

PREVOST

Pneumatic diagram

PNEUMATIC DIAGRAMS X3-45 COACHES WITH FRONT BEAM AXLE

NO:	D140384P0	REVISION :	F
------------	------------------	-------------------	----------

EFF. OC#	2010001	PRIOR TO OC#	2011095
EFF. VEH#	#B-5002	PRIOR TO VEH#	#C-5212

DR.	R. Bouillon	date	2012-02-07
CHK	Marc-Jose Handfield	appr	Marc-José Handfield

REV.	DATE	DESCRIPTION	PAGE	BY	CHK.	APPR.
A	2010-11-24	Coach X3-45 with Front Beam Axle, NEW EPA VOLVO ENGINE 2010 Production Vehicle #B-5002...		Rob.	M.J.H.	M.J.H.
B	2011-05-18	#D140384 P4.0 REVISION: B #D140384 P5.0 REVISION: B #D140384 P6.0 REVISION: B #D140384 P8.0 REVISION: B (AHI REPLACED) #D140384 P9.0 REVISION: B (AHI REPLACED) #B-5053 X3-45 PRELIMINARY VEHICLE AHI	P4.0 & 4.1 P5.0 & 5.1 P6.0 & 6.1 P8.0 & 8.1 P9.0 & 9.1	Rob. R.LAM.	M.J.H. M.J.H.	M.J.H. M.J.H.
C	2011-10-04	#D140384 P2.0 Revision: B (UPDATE) #D140384 P11.0 Revision: B (UPDATE) #D140384 P13.0 Revision: B (UPDATE) Effectif #C-5241	P.0 & 2.1 P11.0&11.1 P13.0&13.1	Rob.	M.J.H.	M.J.H.
D	2011-10-17	#D140384 P3 Revision B , P4 , P5 , P6 Revision C (Front Height Control Valve Kneeling,Production Vehicle #c-5170...)	P3.0 & 3.1 P4.0 & 4.1 P5.0 & 5.1 P6.0 & 6.1	Rob.	M.J.H.	M.J.H.
E	2011-11-04	VOLVO ENGINE VERSION WITHOUT DRV VALVE Production vehicle #C-5212 ...	P.8 & 9 P8.1&9.1	Rob.	M.Pelletier	M.Pelletier
F	2012-02-07	#D140384 P1 Revision B (UPDATE)	P1.0 P1.1@p1.4	Rob.	M.J.H	M.J.H.

Pneumatic diagram

PNEUMATIC DIAGRAMS X3-45 COACHES WITH FRONT BEAM AXLE

PRODUCTION NUMBER	REV	EFF. VEH.	ECN	S.A.V. NUMBER	REV	DESCRIPTION
D140384P1.0	B	#B-5002	2010001	D140384P1.1	B	FULL PNEUMATIC SYSTEM ABS 6
				D140384P1.2	B	ACCESSORIES
				D140384P1.3	B	BRAKES SYSTEM
				D140384P1.4	B	SUSPENSION
D140384P2.0	B	#C-5241		D140384P2.1	A	BRAKE SYSTEM ESP (Electronic Stability Program) OPTION
D140384P3.0	B	#C-5170	2011106	D140384P3.1	B	KNEELING OPTION
D140384P4.0	C	#C-5170	2011106	D140384P4.1	C	KNEELING & LOW-BUOY OPTION
D140384P5.0	C	#C-5170	2011106	D140384P5.1	C	KNEELING & HIGH-BUOY OPTION
D140384P6.0	C	#C-5170	2011106	D140384P6.1	C	KNEELING, LOW-BUOY & HIGH-BUOY OPTION
D140384P7.0	A	#B-5002	2010001	D140384P7.1	A	PARKING BRAKE WITH WCL WITHOUT KNEELING OPTION
D140384P8.0	C	#C-5212	2011095	D140384P8.1	C	ALLISON TRANSMISSION WITHOUT RETARDER OPTION (AHI)
D140384P9.0	C	#C-5212	2011095	D140384P9.1	C	ALLISON TRANSMISSION WITH RETARDER OPTION (AHI)
D140384P10.0	A	#B-5002	2010001	D140384P10.1	A	I-SHIFT TRANSMISSION OPTION
D140384P11.0	B	#C-5241		D140384P11.1	B	I-SHIFT TRANSMISSION & ESP OPTION
D140384P12.0	A	#B-5002	2010001	D140384P12.1	A	HALDEX AIR DRYER OPTION
D140384P13.0	B	#C-5241		D140384P13.1	B	TRAILER HITCH AIR BRAKES AND ESP OPTION (Allison Transm.)
D140384SP1.0	A	#B-5002	2010001	D140384SP1.1	A	"SPECIAL" WITH WABCO AIR DRYER
D140384SP2.0	A	#B-5002	2010001	D140384SP2.1	A	"SPECIAL" WITH OPTION PARKING BRAKE RELEASE WITH SUPPLEMENTARY SWITCH / WHITOUT KNEELING
D140384SP3.0	A	#B-5002	2010001	D140384SP3.1	A	"SPECIAL" WITH FRONT FILL VALVE

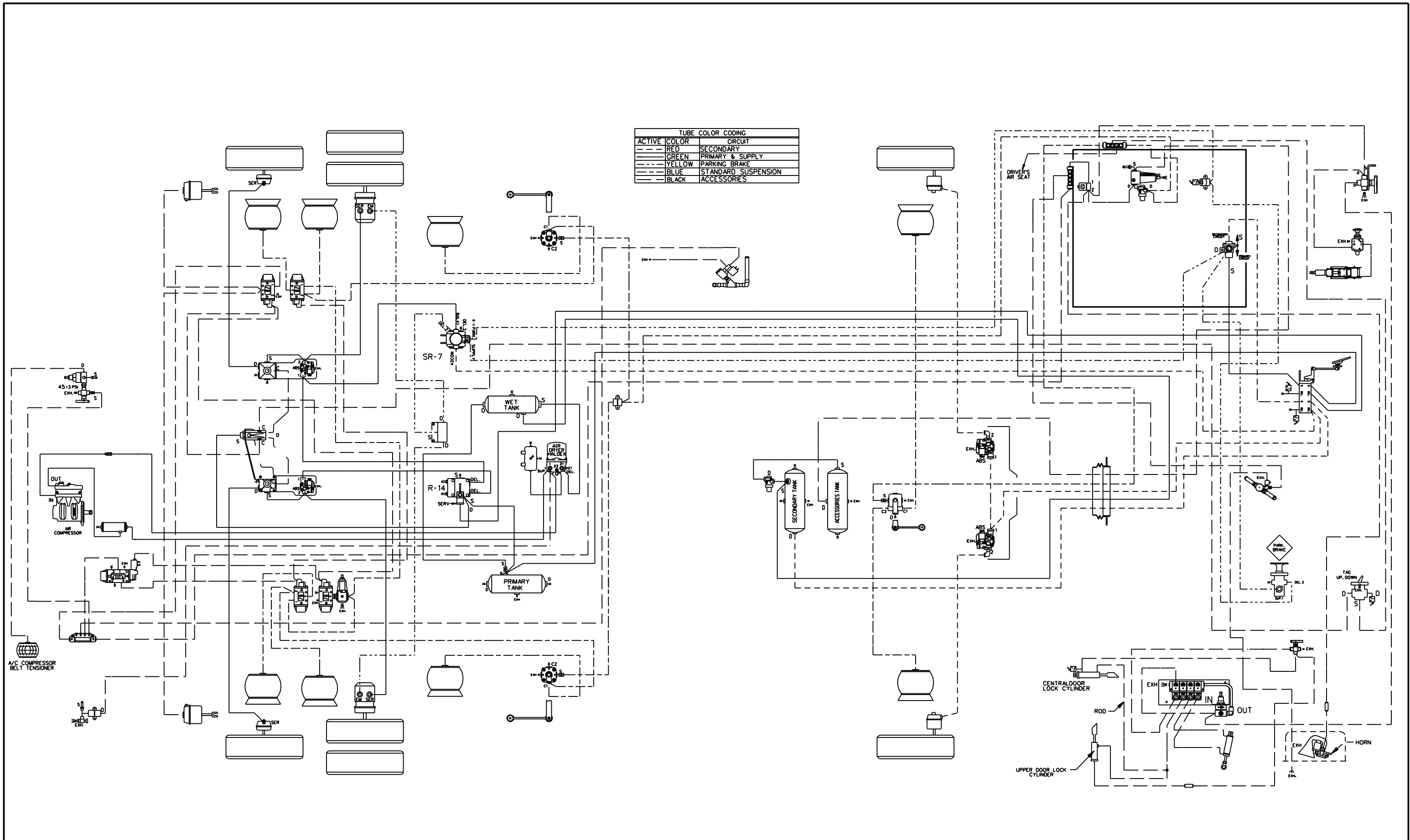

TUBE COLOR CODING	
ACTIVE COLOR	CIRCUIT
RED	SECONDARY
GREEN	PRIMARY & SUPPLY
YELLOW	PARKING BRAKE
BLUE	STANDARD SUSPENSION
BLACK	ACCESSORIES

PREVOST®

DESCRIPTION:

X3-45 COACH WITH FRONT I-BEAM AXLE
FULL PNEUMATIC SYSTEM

REV.:

B

PAGE:

D140384 P1.1

DATE:

2012/02

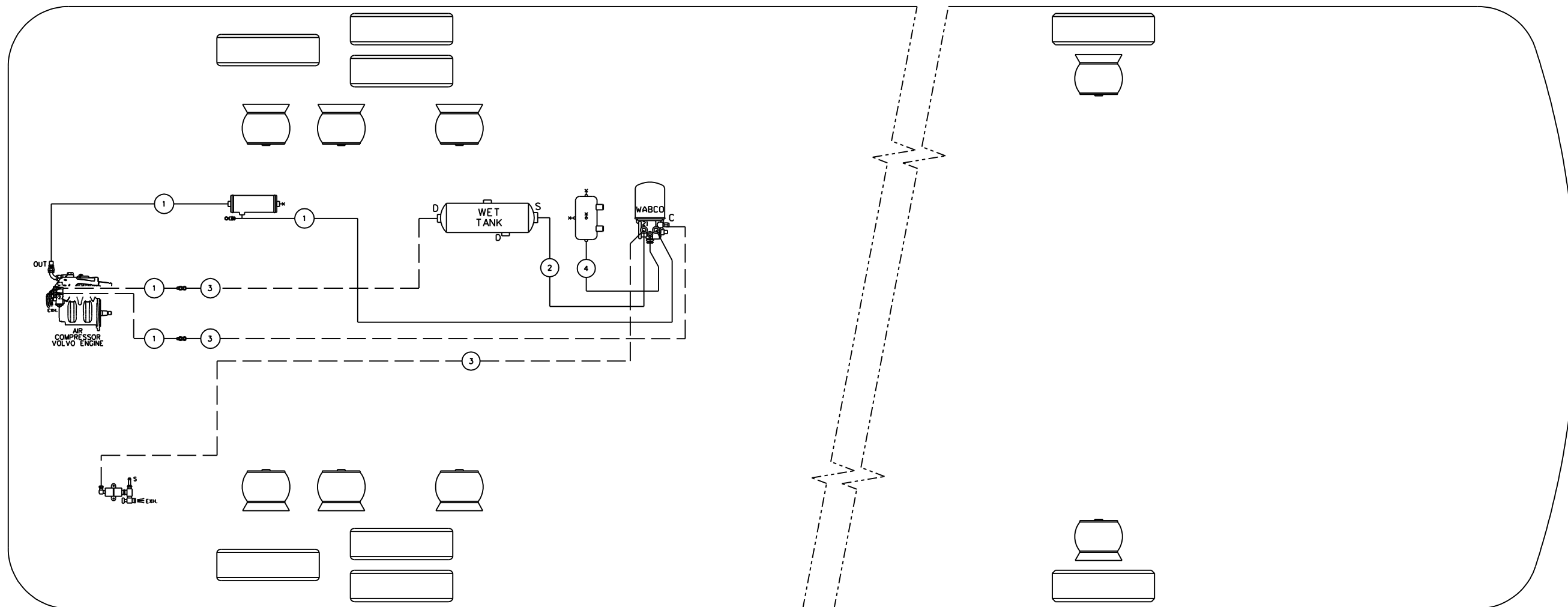

TUBE COLOR CODING	
ACTIVE COLOR	CIRCUIT
— GREEN	PRIMARY & SUPPLY
— BLACK	ACCESSORIES

BALLOON	PIPE
•1	HOSE ASS'Y
•2	3/4" O.D. GREEN
•3	1/4" O.D. BLACK
•4	3/8" O.D. GREY

PREVOST®

DESCRIPTION:

X3-45 COACH WITH FRONT BEAM AXLE,
WITH WABCO AIR DRYER OPTION

REV.:

A

PAGE:

DATE:

2010/11

D140384 SP1.1

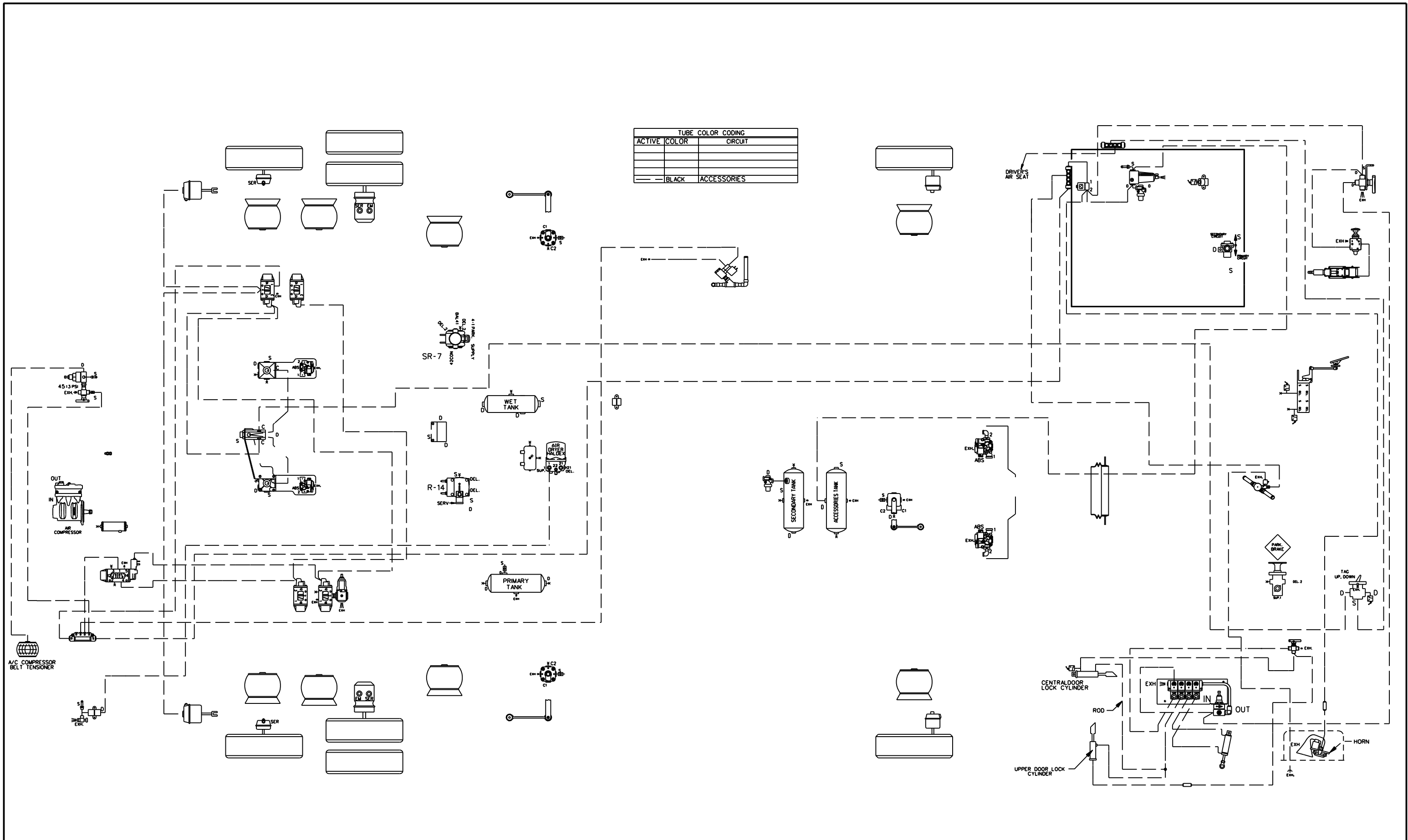

PREVOST®

DESCRIPTION:

X3-45 COACH WITH FRONT I-BEAM AXLE ACCESSORIES

REV.:

B

PAGE:

DATE:

2012/02

D140384 P1.2

TUBE COLOR CODING		
ACTIVE	COLOR	CIRCUIT
---	RED	SECONDARY
---	GREEN	PRIMARY & SUPPLY
---	YELLOW	PARKING BRAKE

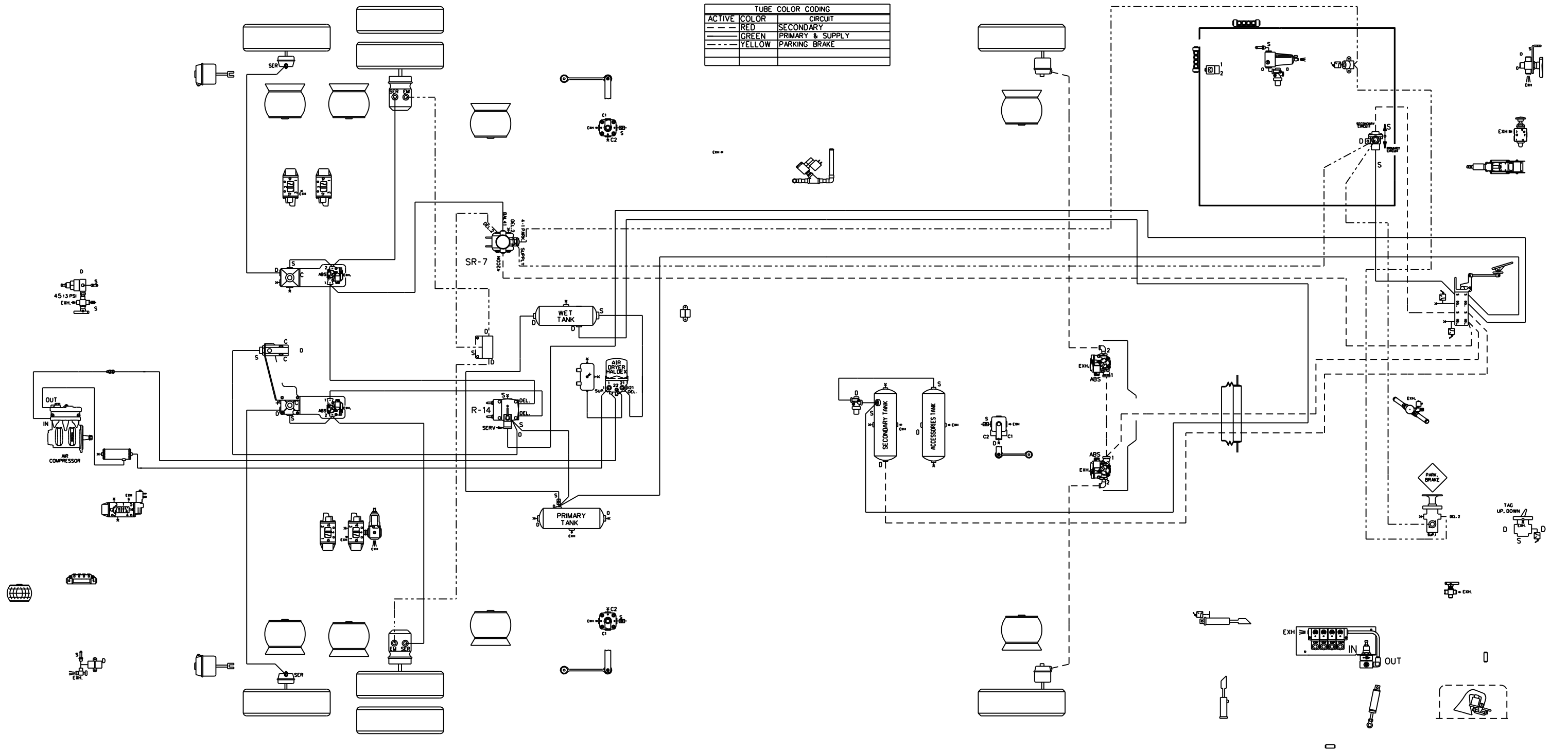

PREVOST

DESCRIPTION:

X3-45 COACH WITH FRONT I-BEAM AXLE
BRAKES SYSTEM

REV.:

B

PAGE:

DATE:

2012/02

D140384 P1.3

TUBE COLOR CODING		
ACTIVE	COLOR	CIRCUIT
---	---	---
---	BLUE	STANDARD SUSPENSION

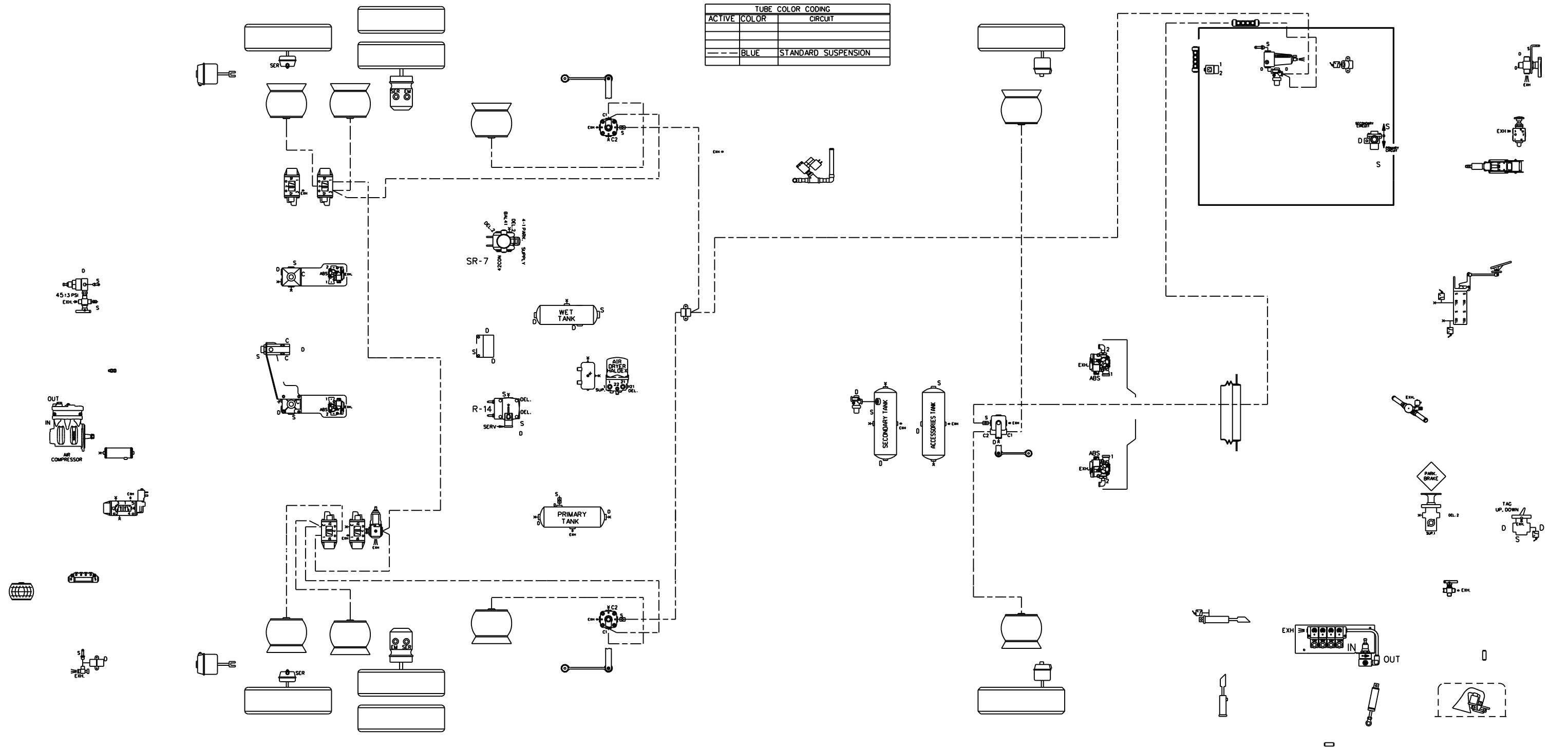

PREVOST®

DESCRIPTION:

X3-45 COACH WITH FRONT I-BEAM AXLE
STANDARD SUSPENSION

REV.:

B

PAGE:

DATE:

2012/02

D140384 P1.4

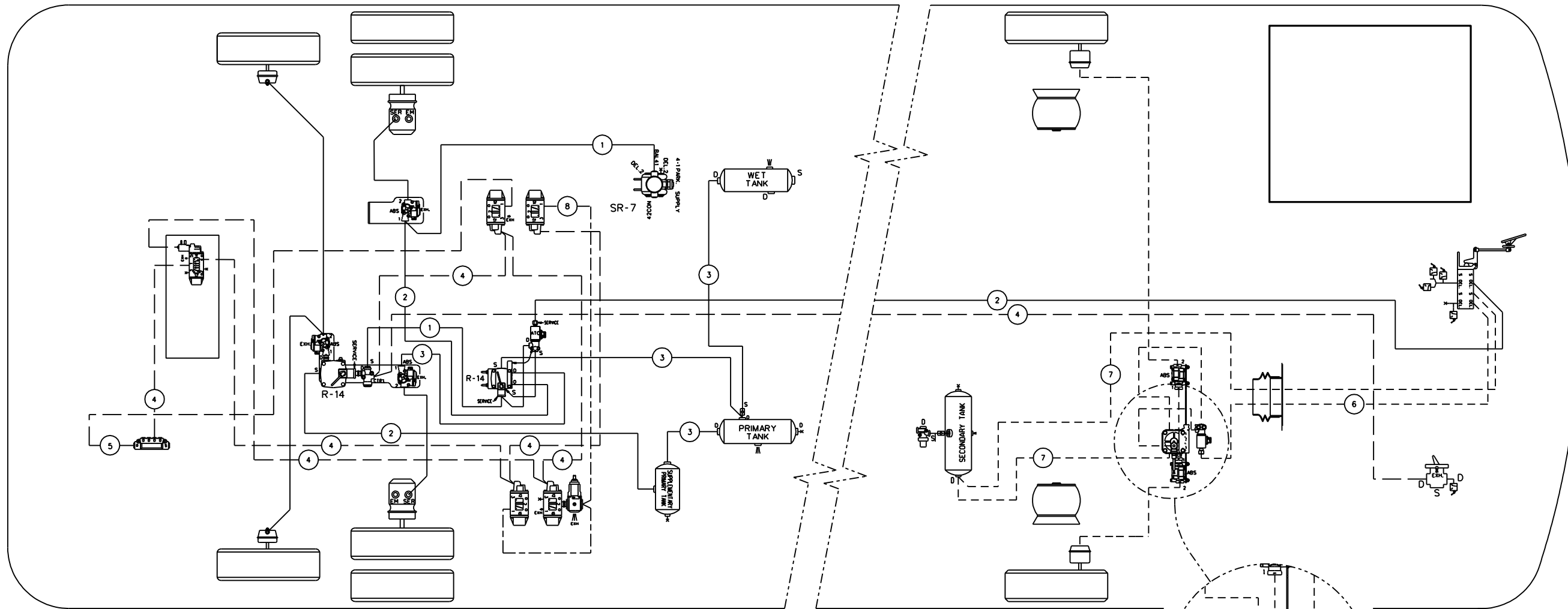

BALLOON	PIPE
*1	3/8" O.D. GREEN
*2	1/2" O.D. GREEN
*3	5/8" O.D. GREEN
*4	1/4" O.D. BLACK
*5	3/8" O.D. BLACK
*6	1/2" O.D. RED
*7	5/8" O.D. RED
*8	3/8" O.D. BLUE

TUBE COLOR CODING		
ACTIVE	COLOR	CIRCUIT
—	GREEN	PRIMARY & SUPPLY
—	BLACK	ACCESSORIES
- - -	RED	SECONDARY

PREVOST®

DESCRIPTION: X3-45 COACH, WITH FRONT BEAM AXLE SUSPENSION WITH ESP

REV.: A
DATE: 2010/11

PAGE: D140384 P2.1

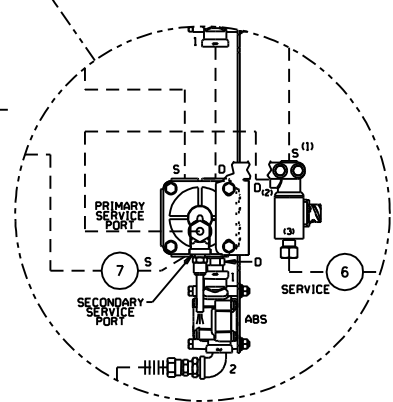
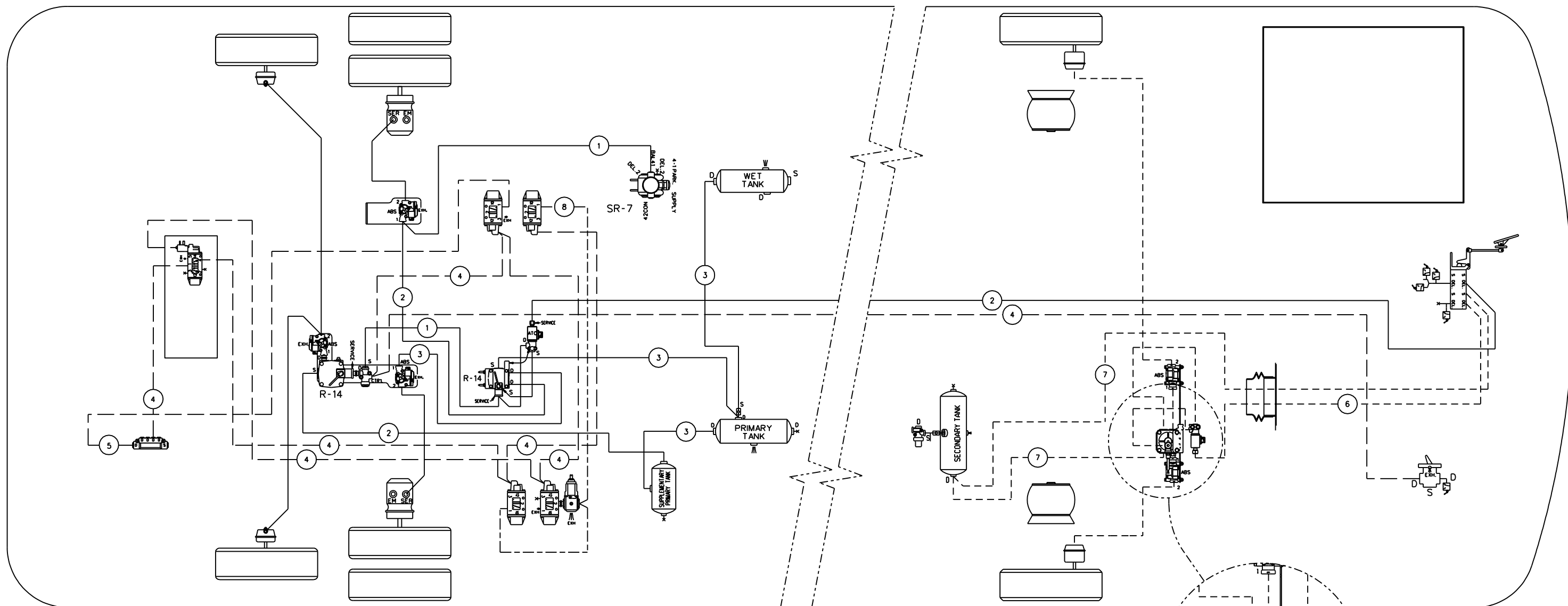

BALLOON	PIPE
#1	3/8" O.D. GREEN
#2	1/2" O.D. GREEN
#3	5/8" O.D. GREEN
#4	1/4" O.D. BLACK
#5	3/8" O.D. BLACK
#6	1/2" O.D. RED
#7	5/8" O.D. RED
#8	3/8" O.D. BLUE

TUBE COLOR CODING	
ACTIVE COLOR	CIRCUIT
GREEN	PRIMARY & SUPPLY
BLACK	ACCESSORIES
RED	SECONDARY

PREVOST®

DESCRIPTION:

X3-45 COACH, WITH FRONT BEAM AXLE SUSPENSION WITH ESP

REV.: B
DATE: 2011/10

PAGE: D140384 P2.1

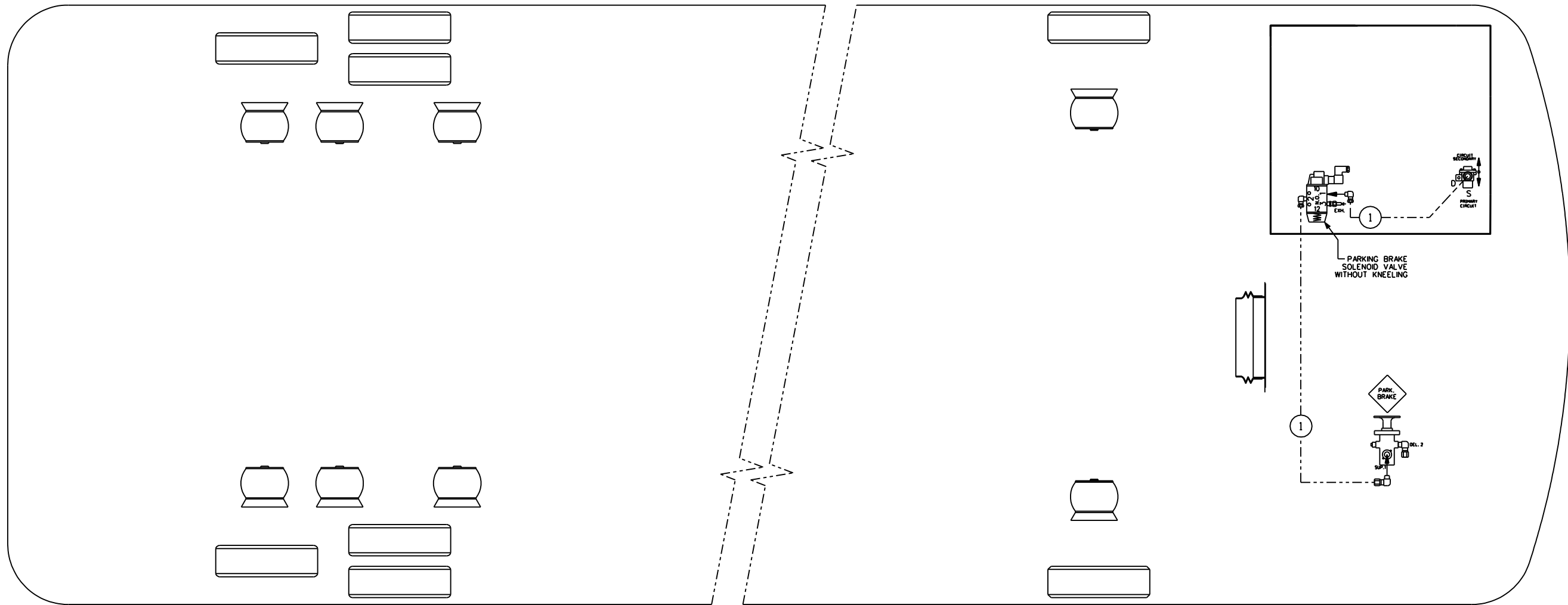

TUBE COLOR CODING		
ACTIVE	COLOR	CIRCUIT
---	YELLOW	PREMIERE BRANONNEMENT

BALLOON	PIPE
*1	1/4" O.D. YELLOW

PREVOST®

DESCRIPTION: X3-45 COACH WITH FRONT BEAM AXLE, WITH OPTION PARKING BRAKE RELEASE WITH SUPPLEMENTARY SWITCH

REV.: A
DATE: 2010/09

PAGE: D140384 SP2.1

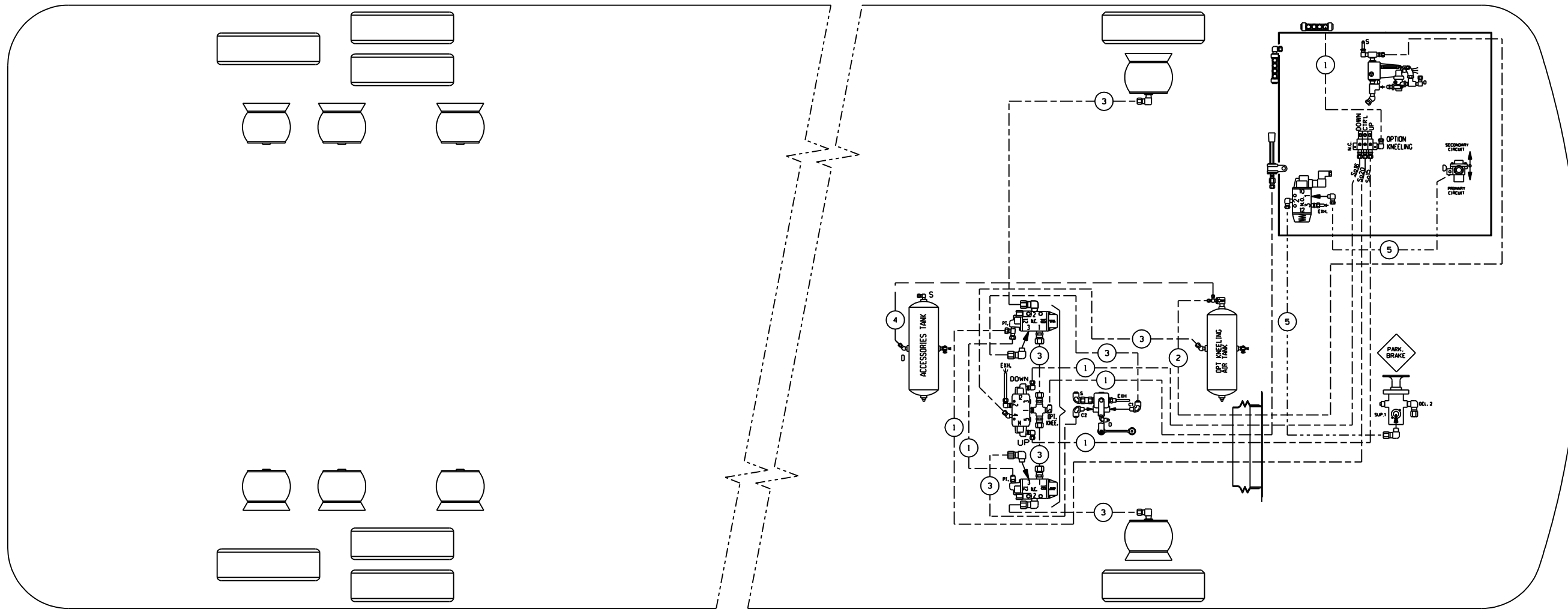

TUBE COLOR CODING	
ACTIVE COLOR	CIRCUIT
---	YELLOW PARKING BRAKE
---	BLACK ACCESSORIES
---	BLUE KNEELING OPTION

BALLOON	PIPE
*1	1/4" O.D. BLUE
*2	3/8" O.D. BLUE
*3	1/2" O.D. BLUE
*4	3/8" O.D. BLACK
*5	3/8" O.D. YELLOW

PREVOST®

DESCRIPTION: X3-45 COACH WITH FRONT I-BEAM AXLE WITH FRONT KNEELING OPTION

REV.: A
DATE: 2010/11

PAGE: D140384 P3.1

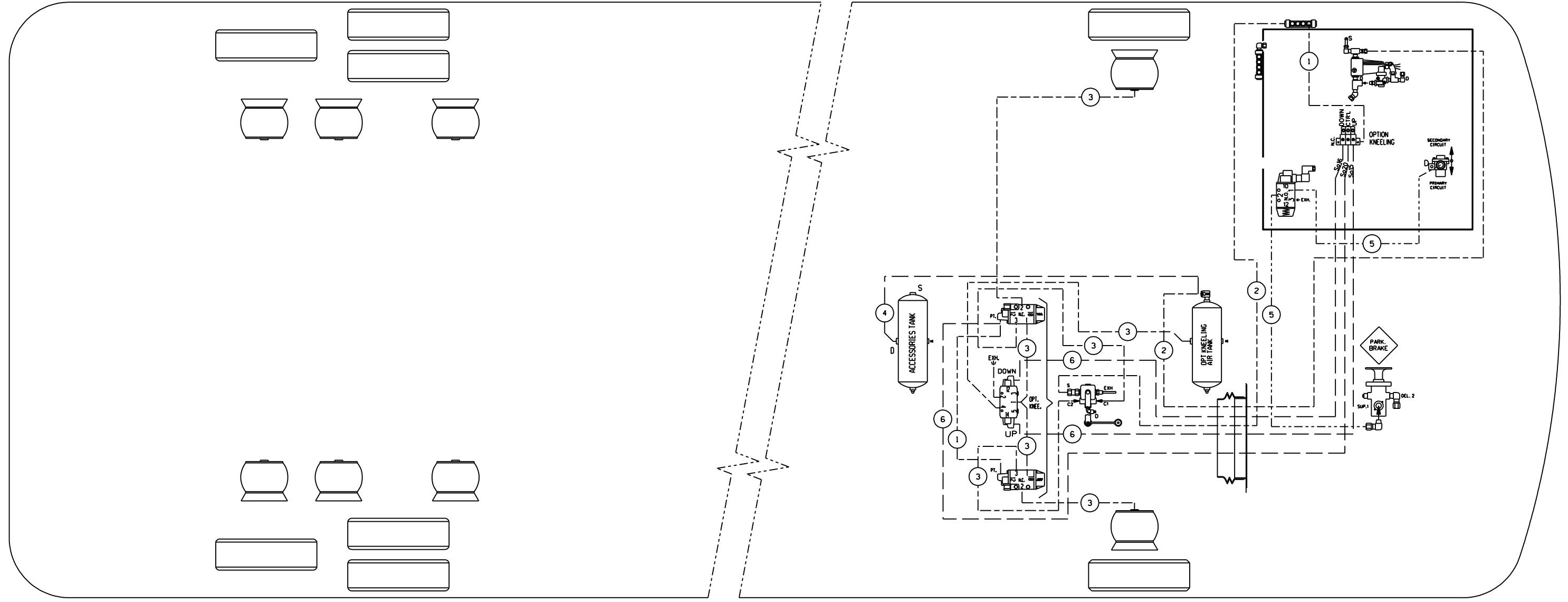

TUBE COLOR CODING	
ACTIVE COLOR	CIRCUIT
---	YELLOW PARKING BRAKE
---	BLACK ACCESSORIES
---	BLUE KNEELING OPTION

BALLOON	PIPE
#1	1/4" O.D. BLUE
#2	3/8" O.D. BLUE
#3	1/2" O.D. BLUE
#4	3/8" O.D. BLACK
#5	3/8" O.D. YELLOW
#6	1/4" O.D. BLACK

PREVOST®

DESCRIPTION:

X3-45 COACH WITH FRONT I-BEAM AXLE
WITH FRONT KNEELING OPTION

REV.: B
DATE: 2010/10

PAGE: D140384 P3.1

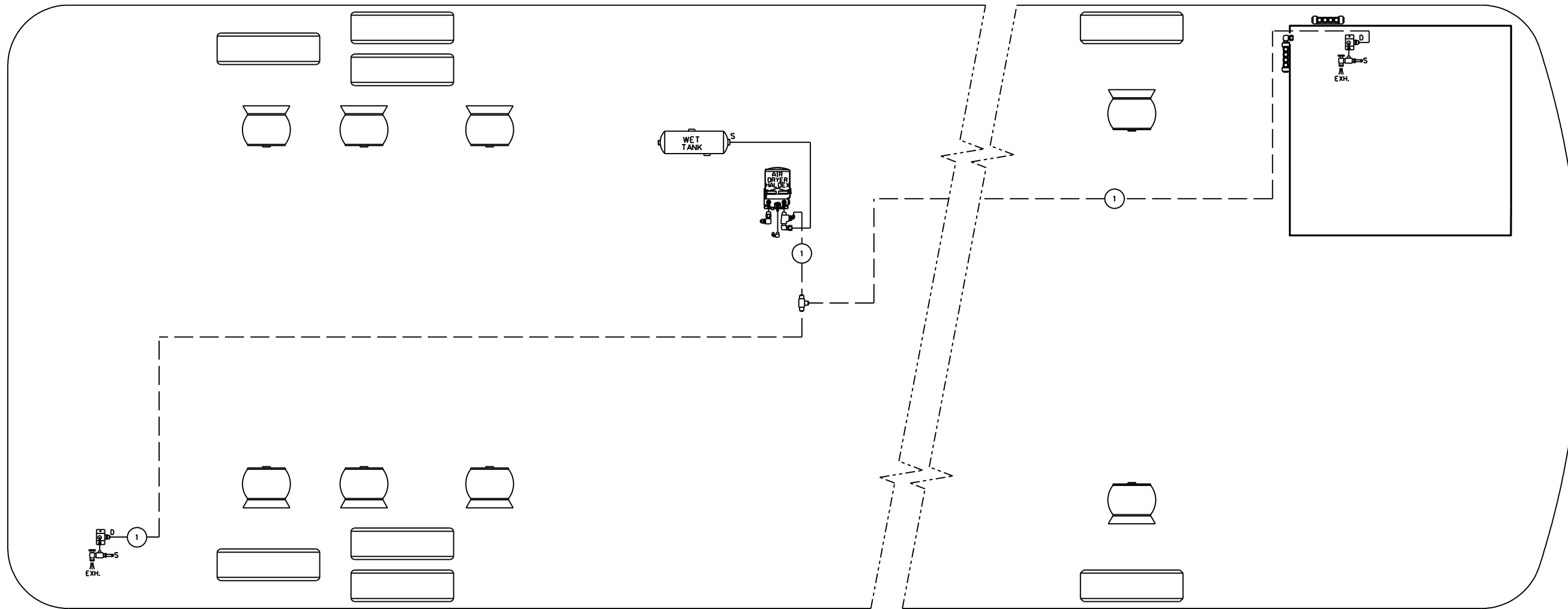

TUBE COLOR CODING		
ACTIVE	COLOR	CIRCUIT
—	GREEN	PRIMARY & SUPPLY
—	BLACK	ACCESSORY

BALLOON	PIPE
•1	1/4" O.D. BLACK

PREVOST®

DESCRIPTION:

X3-45 COACH, WITH FRONT BEAM AXLE,
FRONT AIR FILL VALVE
OPTION

REV.:

A

DATE:

2010/11

PAGE:

D140384 SP3.1

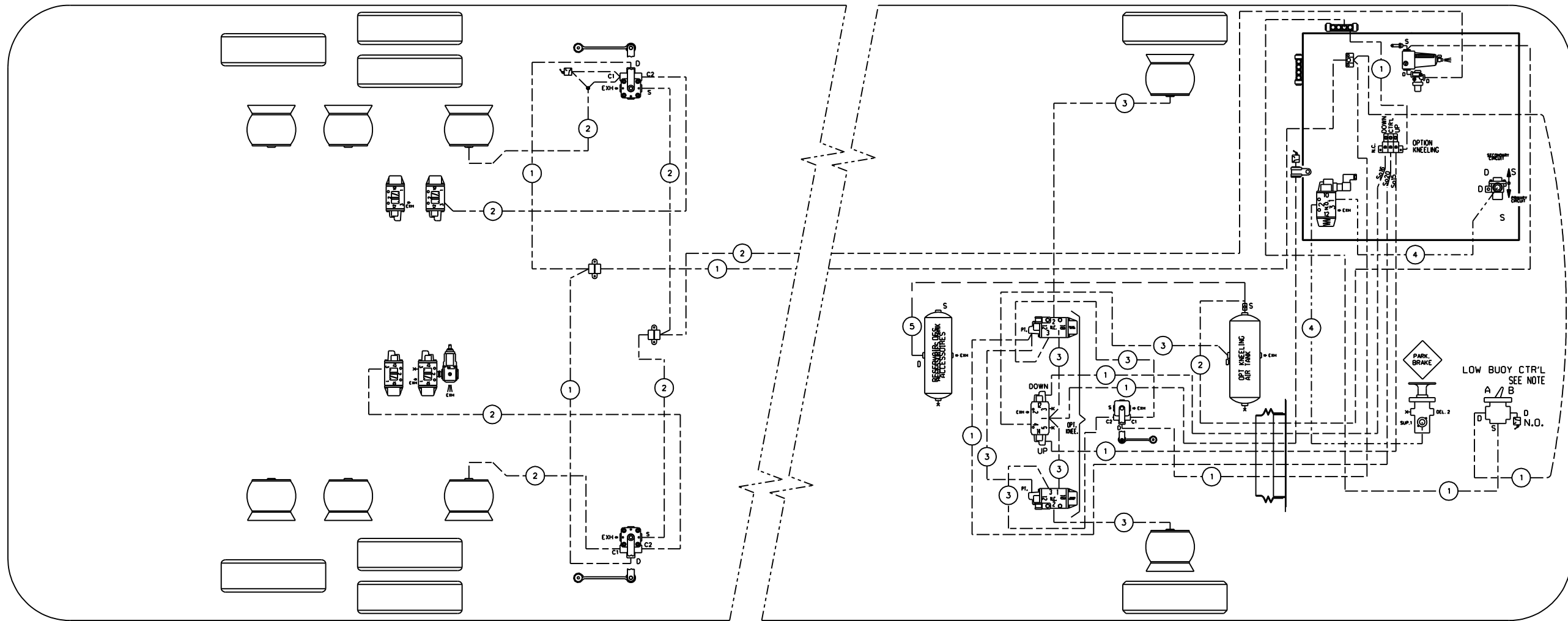

BALLOON	PIPE
*1	1/4" O.D. BLUE
*2	3/8" O.D. BLUE
*3	1/2" O.D. BLUE
*4	3/8" O.D. YELLOW
*5	3/8" O.D. BLACK
*6	3/4" O.D. BLACK

TUBE COLOR CODING		
LINE TYPE	COLOR	CIRCUIT
---	BLUE	SUSPENSION
---	BLACK	ACCESSORIES
---	YELLOW	PARKING BRAKES

NOTE:

CONTROL VALVE OPT. "LOW-BUOY" , "A" OR "B" SETTING:

POSITION "A": VALVE IS OPEN,
AIR FLOW BETWEEN SUPPLY (S) AND
DELIVERY (D) , LOW-BUOY IS IN FUNCTION.

POSITION "B": VALVE CLOSED,
AIR DOES'NT FLOW BETWEEN SUPPLY (S) AND
DELIVERY (D) , LOW-BUOY IS NOT IN FUNCTION.

PREVOST®

DESCRIPTION:
X3-45 COACH, WITH FRONT BEAM AXLE
WITH OPTION FRONT KNEELING & LOW-BUOY COMBINATION

REV.: A
DATE: 2010/11

PAGE:
D140384 P4.1

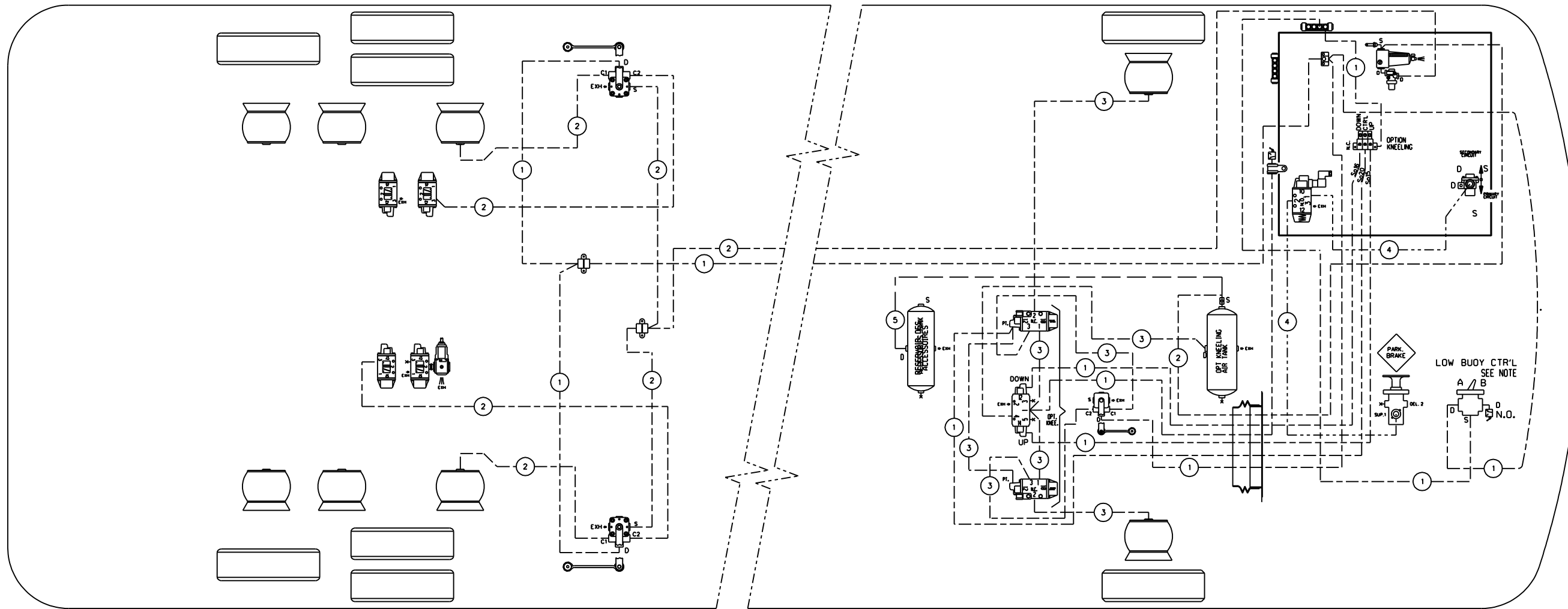

BALLOON	PIPE
*1	1/4" O.D. BLUE
*2	3/8" O.D. BLUE
*3	1/2" O.D. BLUE
*4	3/8" O.D. YELLOW
*5	3/8" O.D. BLACK
*6	3/4" O.D. BLACK

TUBE COLOR CODING		
LINE TYPE	COLOR	CIRCUIT
---	BLUE	SUSPENSION
---	BLACK	ACCESSORIES
---	YELLOW	PARKING BRAKES

NOTE:

CONTROL VALVE OPT. "LOW-BUOY" , "A" OR "B" SETTING:

POSITION "A": VALVE IS OPEN,
AIR FLOW BETWEEN SUPPLY (S) AND
DELIVERY (D) , LOW-BUOY IS IN FUNCTION.

POSITION "B": VALVE CLOSED,
AIR DOES'NT FLOW BETWEEN SUPPLY (S) AND
DELIVERY (D) , LOW-BUOY IS NOT IN FUNCTION.

PREVOST®

DESCRIPTION:
X3-45 COACH, WITH FRONT BEAM AXLE
WITH OPTION FRONT KNEELING & LOW-BUOY COMBINATION

REV.: B
DATE: 2011/04

PAGE:
D140384 P4.1

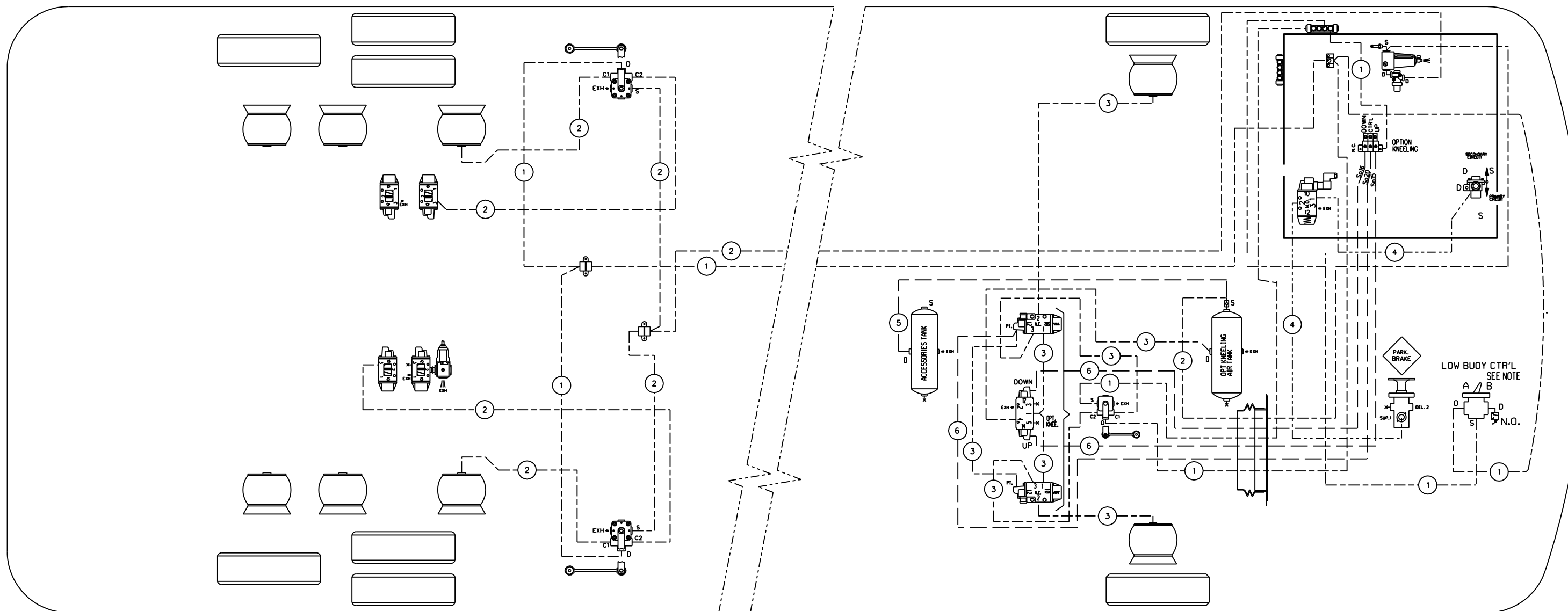

BALLOON	PIPE
*1	1/4" O.D. BLUE
*2	3/8" O.D. BLUE
*3	1/2" O.D. BLUE
*4	3/8" O.D. YELLOW
*5	3/8" O.D. BLACK
*6	1/4" O.D. BLACK

TUBE COLOR CODING		
LINE TYPE	COLOR	CIRCUIT
---	BLUE	SUSPENSION
---	BLACK	ACCESSORIES
---	YELLOW	PARKING BRAKES

NOTE:

CONTROL VALVE OPT. "LOW-BUOY" , "A" OR "B" SETTING:

POSITION "A": VALVE IS OPEN,
AIR FLOW BETWEEN SUPPLY (S) AND
DELIVERY (D) , LOW-BUOY IS IN FUNCTION.

POSITION "B": VALVE CLOSED,
AIR DOES'NT FLOW BETWEEN SUPPLY (S) AND
DELIVERY (D) , LOW-BUOY IS NOT IN FUNCTION.

PREVOST®

DESCRIPTION:

X3-45 COACH, WITH FRONT BEAM AXLE
WITH OPTION FRONT KNEELING & LOW-BUOY COMBINATION

REV.:

C

PAGE:

D140384 P4.1

DATE:

2011/10

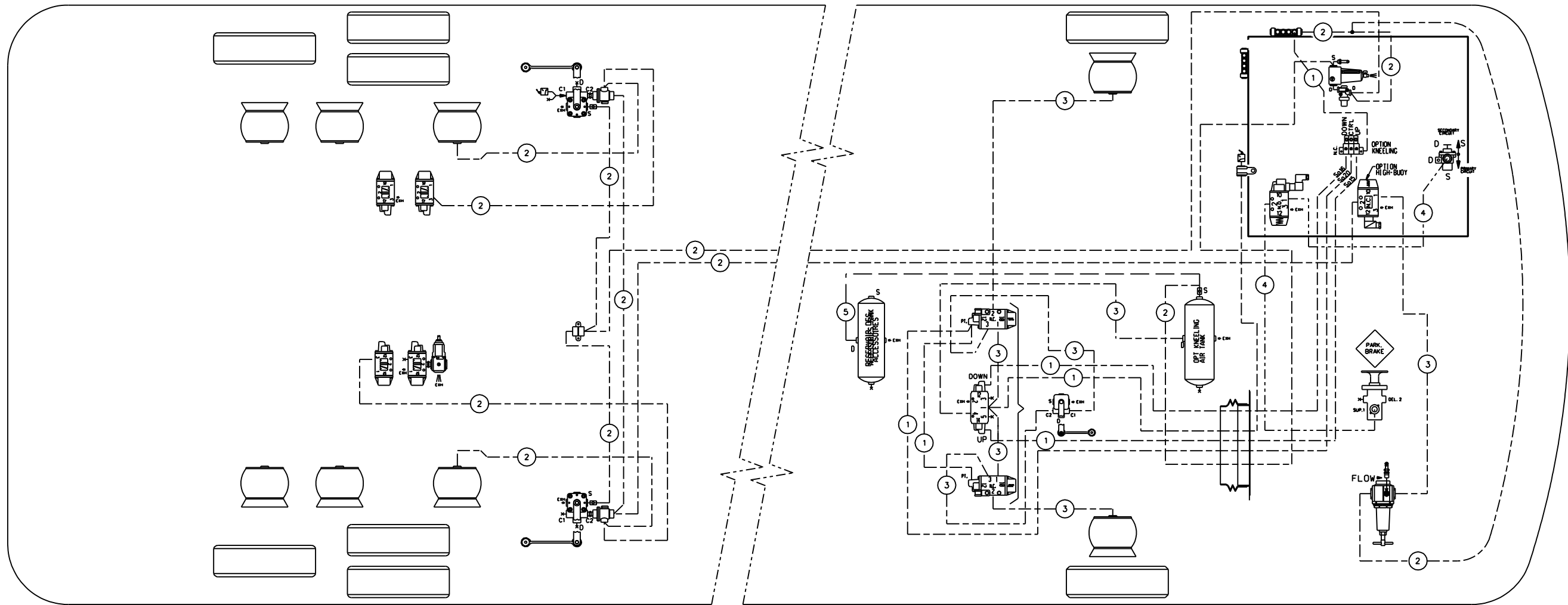

BALLOON	PIPE
*1	1/4" O.D. BLUE
*2	3/8" O.D. BLUE
*3	1/2" O.D. BLUE
*4	3/8" O.D. YELLOW

TUBE COLOR CODING		
LINE TYPE	COLOR	CIRCUIT
	BLUE	SUSPENSION
	YELLOW	PARKING BRAKES
	BLACK	ACCESSORIES

PREVOST[®]

DESCRIPTION:

X3-45 COACH, WITH FRONT BEAM AXLE
WITH OPTION FRONT KNEELING & HIGH-BUOY COMBINATION

REV.:

A

DATE:

2010/11

PAGE:

D140384 P5.1

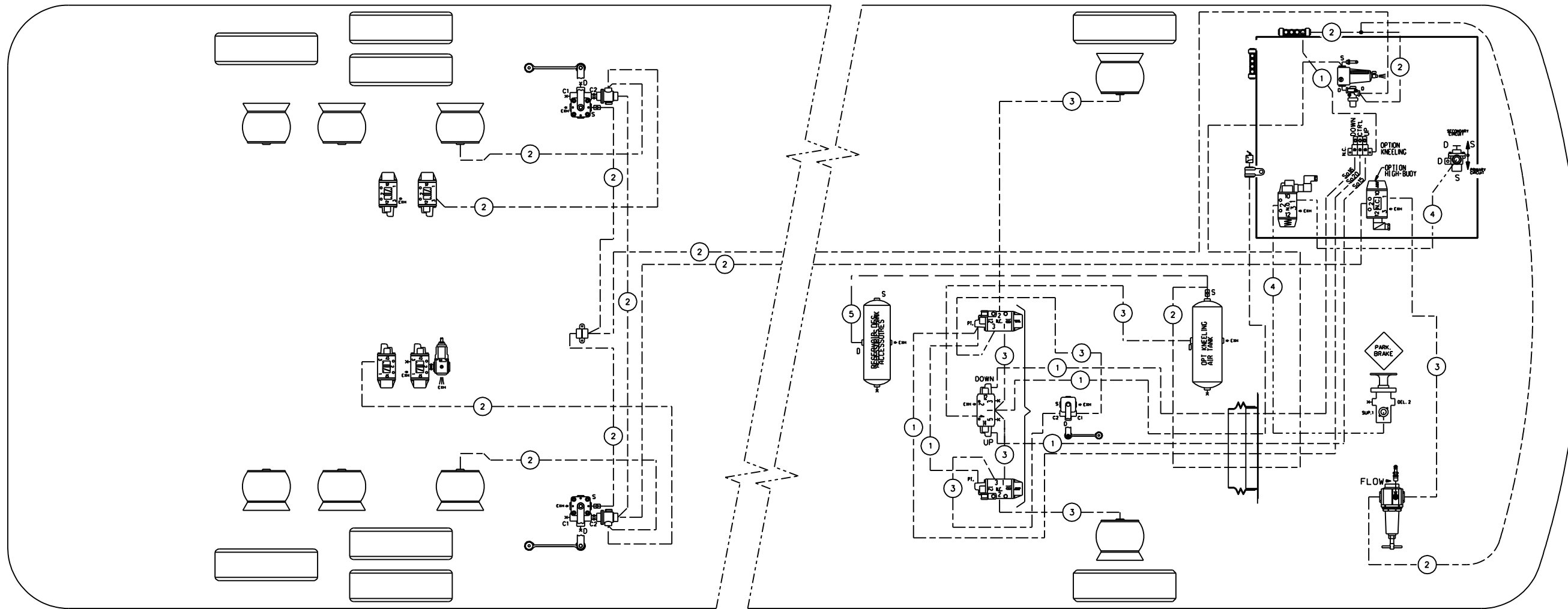

BALLOON	PIPE
*1	1/4" O.D. BLUE
*2	3/8" O.D. BLUE
*3	1/2" O.D. BLUE
*4	3/8" O.D. YELLOW

TUBE COLOR CODING		
LINE TYPE	COLOR	CIRCUIT
	BLUE	SUSPENSION
	YELLOW	PARKING BRAKES
	BLACK	ACCESSORIES

PREVOST[®]

DESCRIPTION:

X3-45 COACH, WITH FRONT BEAM AXLE
WITH OPTION FRONT KNEELING & HIGH-BUOY COMBINATION

REV.:

B

DATE:

2011/04

PAGE:

D140384 P5.1

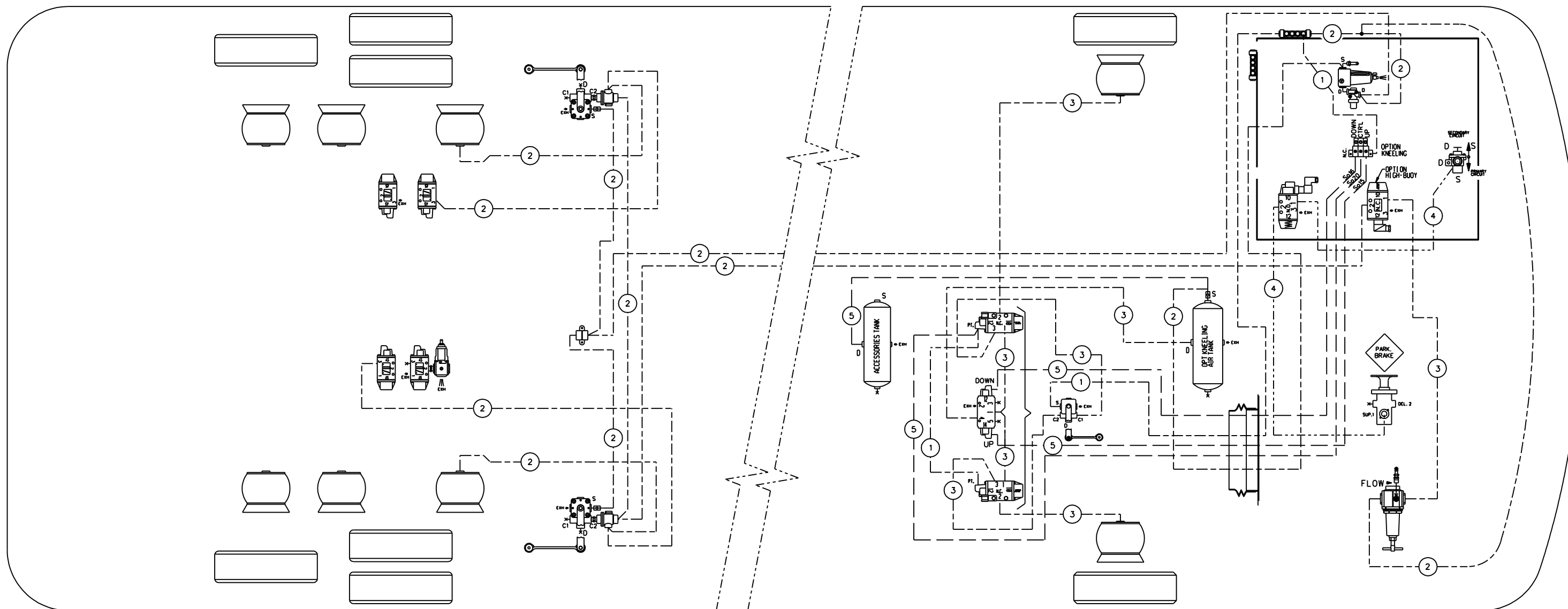

BALLOON	PIPE
*1	1/4" O.D. BLUE
*2	3/8" O.D. BLUE
*3	1/2" O.D. BLUE
*4	3/8" O.D. YELLOW
*5	1/4" O.D. BLACK

TUBE COLOR CODING		
LINE TYPE	COLOR	CIRCUIT
	BLUE	SUSPENSION
	YELLOW	PARKING BRAKES
	BLACK	ACCESSORIES

PREVOST[®]

DESCRIPTION:

X3-45 COACH, WITH FRONT BEAM AXLE
WITH OPTION FRONT KNEELING & HIGH-BUOY COMBINATION

REV.:

C

DATE:

2011/10

PAGE:

D140384 P5.1

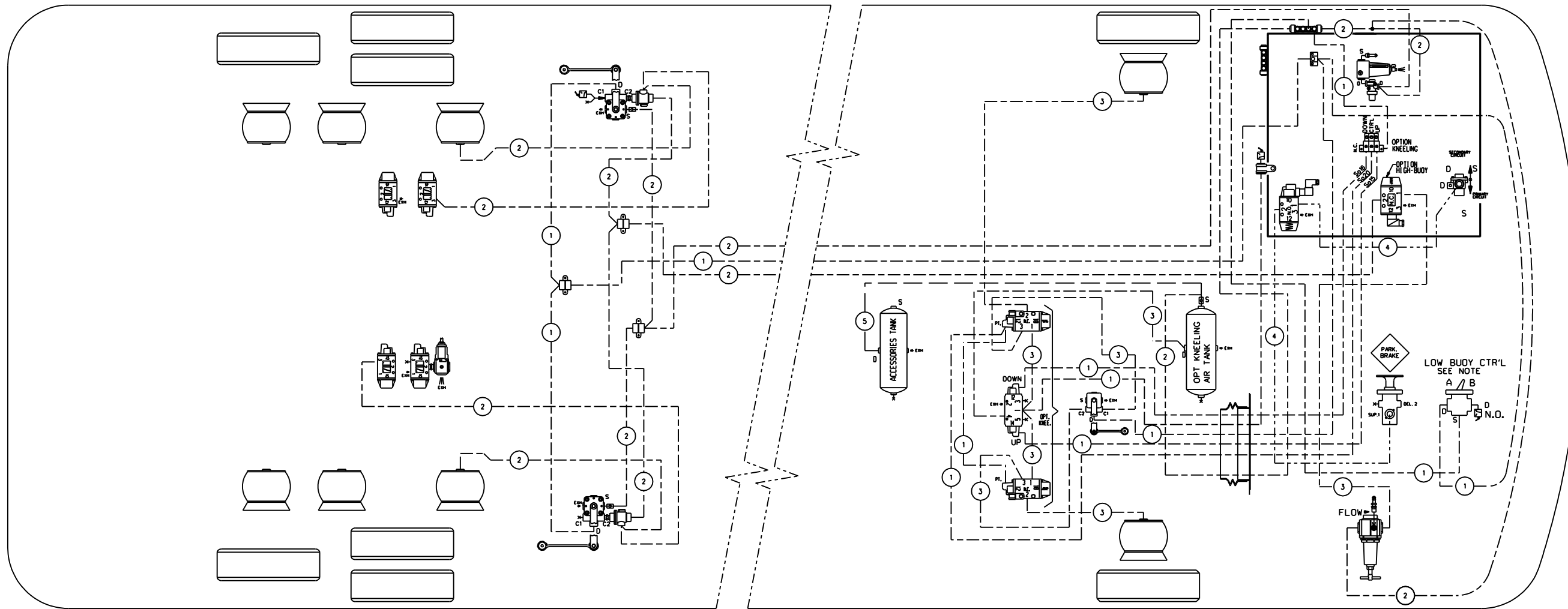

BALLOON	PIPE
*1	1/4" O.D. BLUE
*2	3/8" O.D. BLUE
*3	1/2" O.D. BLUE
*4	3/8" O.D. YELLOW
*5	3/8" O.D. BLACK

NOTE:

KNEELING SYSTEM UP (CTR'L + UP ENERGIZED)
DOWN (CTR'L + DOWN ENERGIZED)

CONTROL VALVE OPT. "LOW-BUOY" , "A" OR "B" SETTING:

POSITION "A": VALVE IS OPEN,
AIR FLOW BETWEEN SUPPLY (S) AND
DELIVERY (D) , LOW-BUOY IS IN FUNCTION.

POSITION "B": VALVE CLOSED,
AIR DOES'NT FLOW BETWEEN SUPPLY (S) AND
DELIVERY (D) , LOW-BUOY IS NOT IN FUNCTION.

TUBE COLOR CODING		
LINE TYPE	COLOR	CIRCUIT
---	BLUE	SUSPENSION
---	BLACK	ACCESSORIES
---	YELLOW	PARKING BRAKES

PREVOST®

DESCRIPTION:

X3-45 COACH, WITH FRONT BEAM AXLE
WITH OPTION FRONT KNEELING,
LOW-BUOY & HIGH-BUOY COMBINATION

REV.:

A

DATE:

2010/11

PAGE:

D140384 P6.1

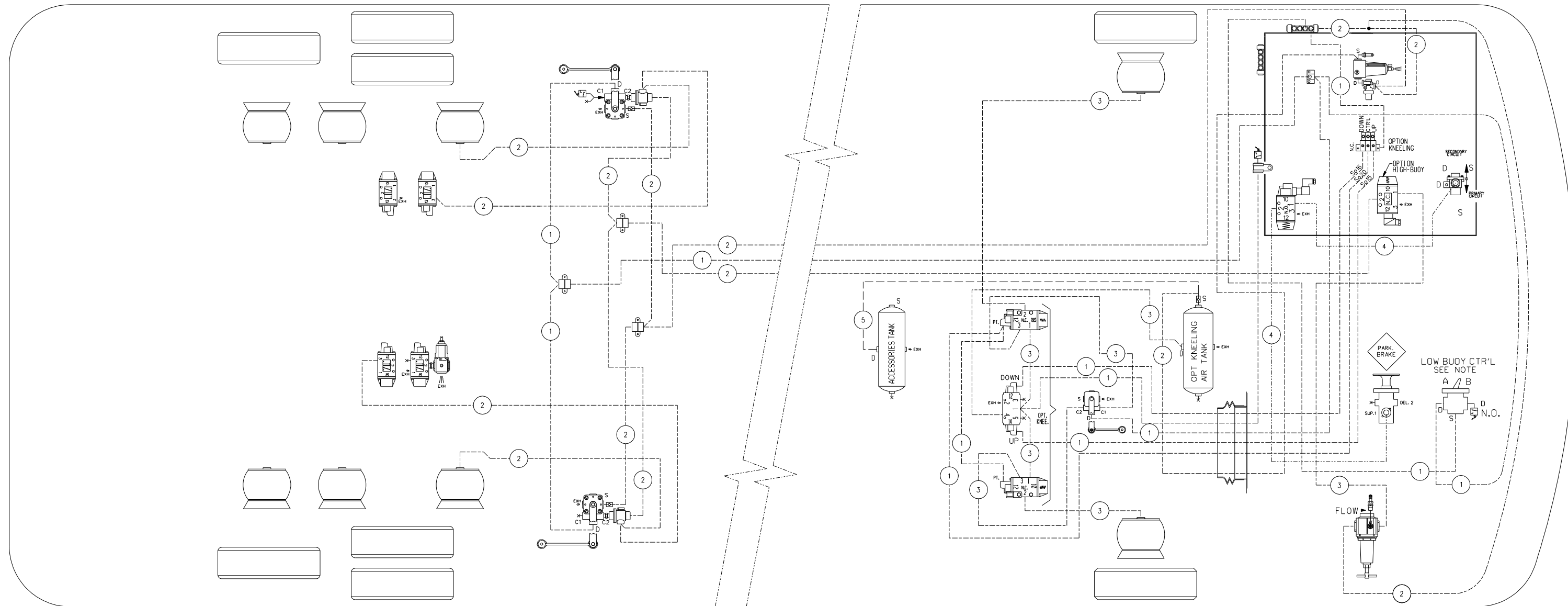

BALLOON	PIPE
#1	1/4" O.D. BLUE
#2	3/8" O.D. BLUE
#3	1/2" O.D. BLUE
#4	3/8" O.D. YELLOW
#5	3/8" O.D. BLACK

NOTE:

KNEELING SYSTEM = UP (CTR'L + UP ENERGIZED)
DOWN (CTR'L + DOWN ENERGIZED)

CONTROL VALVE OPT. "LOW-BUOY" , "A" OR "B" SETTING:

POSITION "A": VALVE IS OPEN,
AIR FLOW BETWEEN SUPPLY (S) AND
DELIVERY (D) , LOW-BUOY IS IN FUNCTION.

POSITION "B": VALVE CLOSED,
AIR DOES'NT FLOW BETWEEN SUPPLY (S) AND
DELIVERY (D) , LOW-BUOY IS NOT IN FUNCTION.

TUBE COLOR CODING		
LINE TYPE	COLOR	CIRCUIT
---	BLUE	SUSPENSION
---	BLACK	ACCESSORIES
---	YELLOW	PARKING BRAKES

PREVOST®

DESCRIPTION:

X3-45 COACH, WITH FRONT BEAM AXLE
WITH OPTION FRONT KNEELING,
LOW-BUOY & HIGH-BUOY COMBINATION

REV.: B
DATE: 2011/01

PAGE:
D140384 P6.1

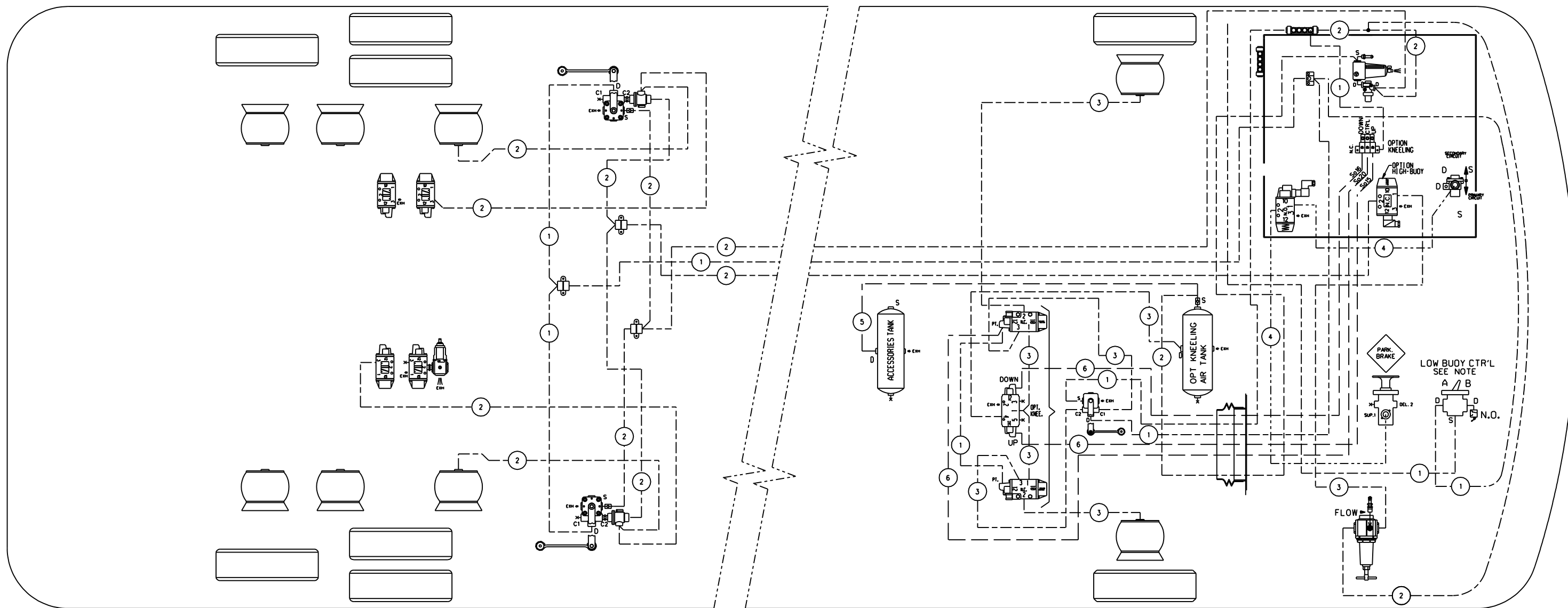

BALLOON	PIPE
*1	1/4" O.D. BLUE
*2	3/8" O.D. BLUE
*3	1/2" O.D. BLUE
*4	3/8" O.D. YELLOW
*5	3/8" O.D. BLACK
*6	1/4" O.D. BLACK

NOTE:

KNEELING SYSTEM = UP (CTR'L + UP ENERGIZED)
DOWN (CTR'L + DOWN ENERGIZED)

CONTROL VALVE OPT. "LOW-BUOY" , "A" OR "B" SETTING:

POSITION "A": VALVE IS OPEN,
AIR FLOW BETWEEN SUPPLY (S) AND
DELIVERY (D) , LOW-BUOY IS IN FUNCTION.

POSITION "B": VALVE CLOSED,
AIR DOES'NT FLOW BETWEEN SUPPLY (S) AND
DELIVERY (D) , LOW-BUOY IS NOT IN FUNCTION.

TUBE COLOR CODING		
LINE TYPE	COLOR	CIRCUIT
---	BLUE	SUSPENSION
---	BLACK	ACCESSORIES
---	YELLOW	PARKING BRAKES

PREVOST®

DESCRIPTION:

X3-45 COACH, WITH FRONT BEAM AXLE
WITH OPTION FRONT KNEELING,
LOW-BUOY & HIGH-BUOY COMBINATION

REV.:

C

PAGE:

D140384 P6.1

DATE:

2011/10

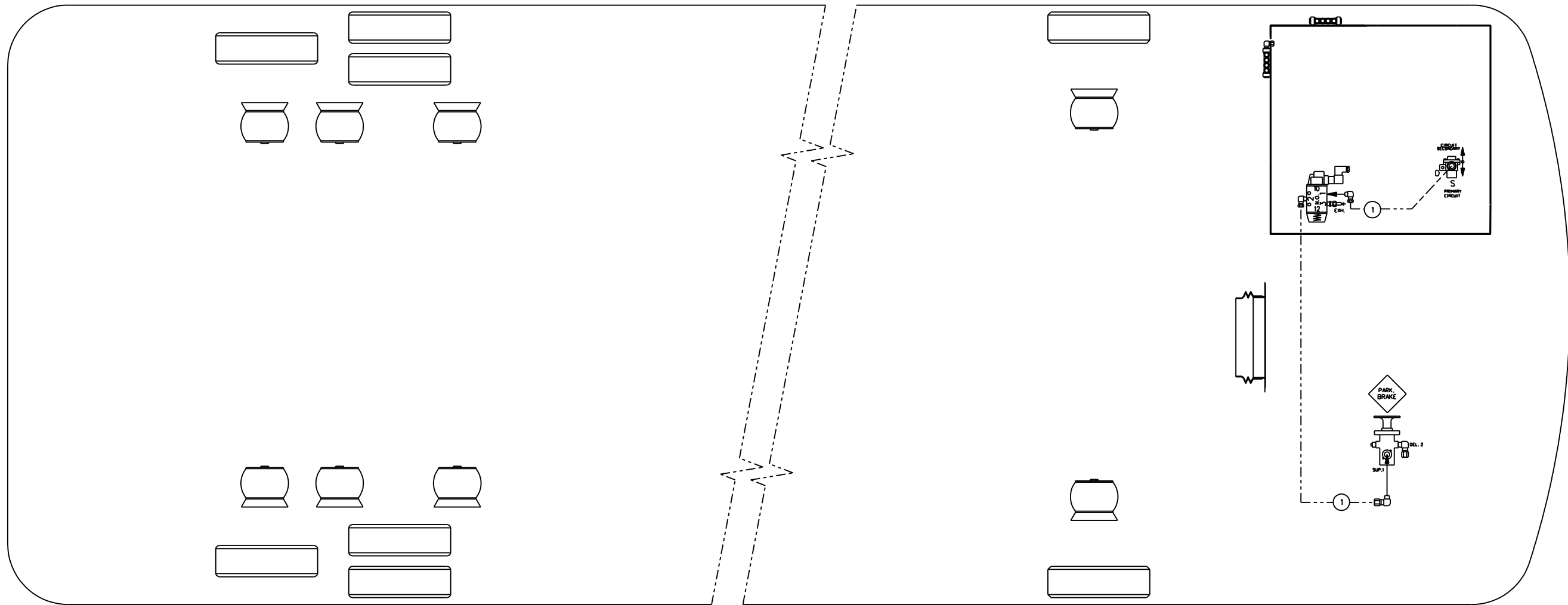

TUBE COLOR CODING	
ACTIVE COLOR	CIRCUIT
---	YELLOW PARKING BRAKE

BALLOON	PIPE
*1	3/8" O.D. YELLOW

PREVOST®

DESCRIPTION: X3-45 COACH, WITH FRONT BEAM AXLE
WITH OPTION PARKING BRAKE WITH WHEELCHAIR LIFT AND WITHOUT
KNEELING

REV.: A
DATE: 2010/11

PAGE: D140384 P7.1

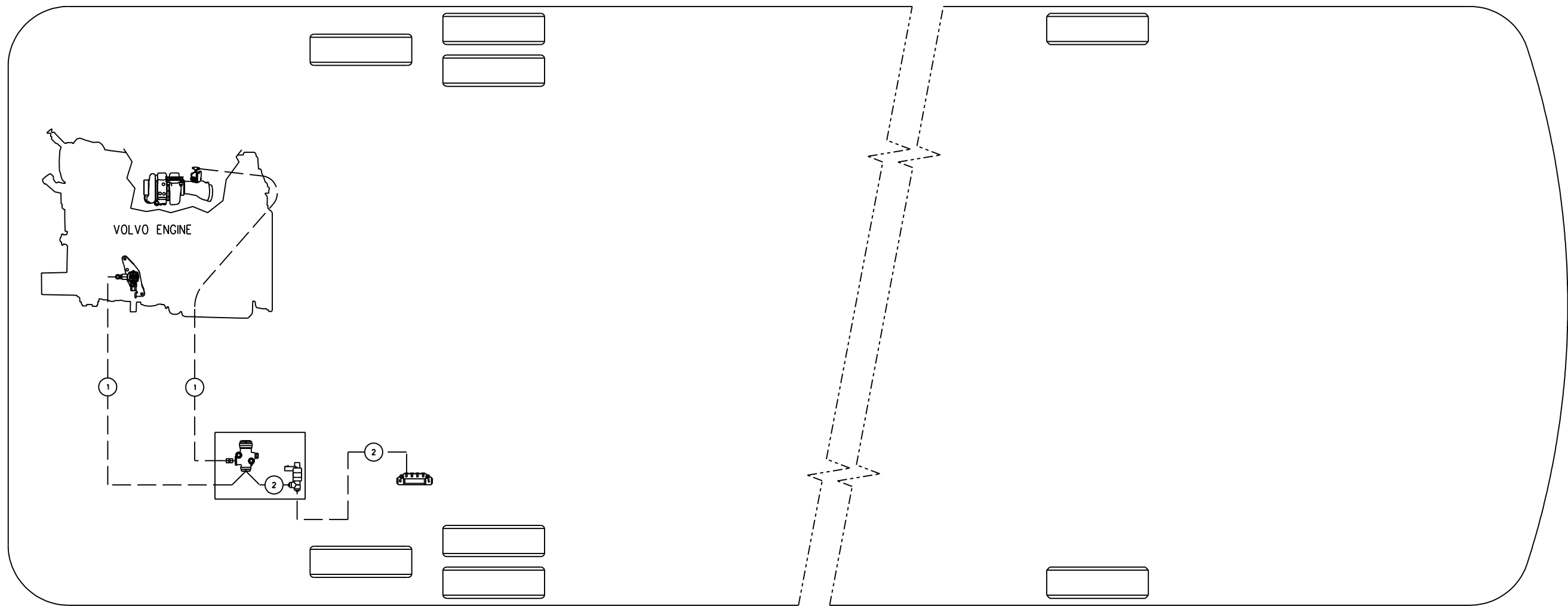

TUBE COLOR CODING		
ACTIVE	COLOR	CIRCUIT
—	BLACK	ACCESSORIES

BALLOON	PIPE
*1	HOSE ASS'Y
*2	1/4" O.D. BLACK

PREVOST®

DESCRIPTION:

X3-45 COACH, WITH FRONT BEAM AXLE,
WITHOUT OUTPUT RETARDER ON WORLD TRANSMISSION

REV.:

A

DATE:

2010/11

PAGE:

D140384 P8.1

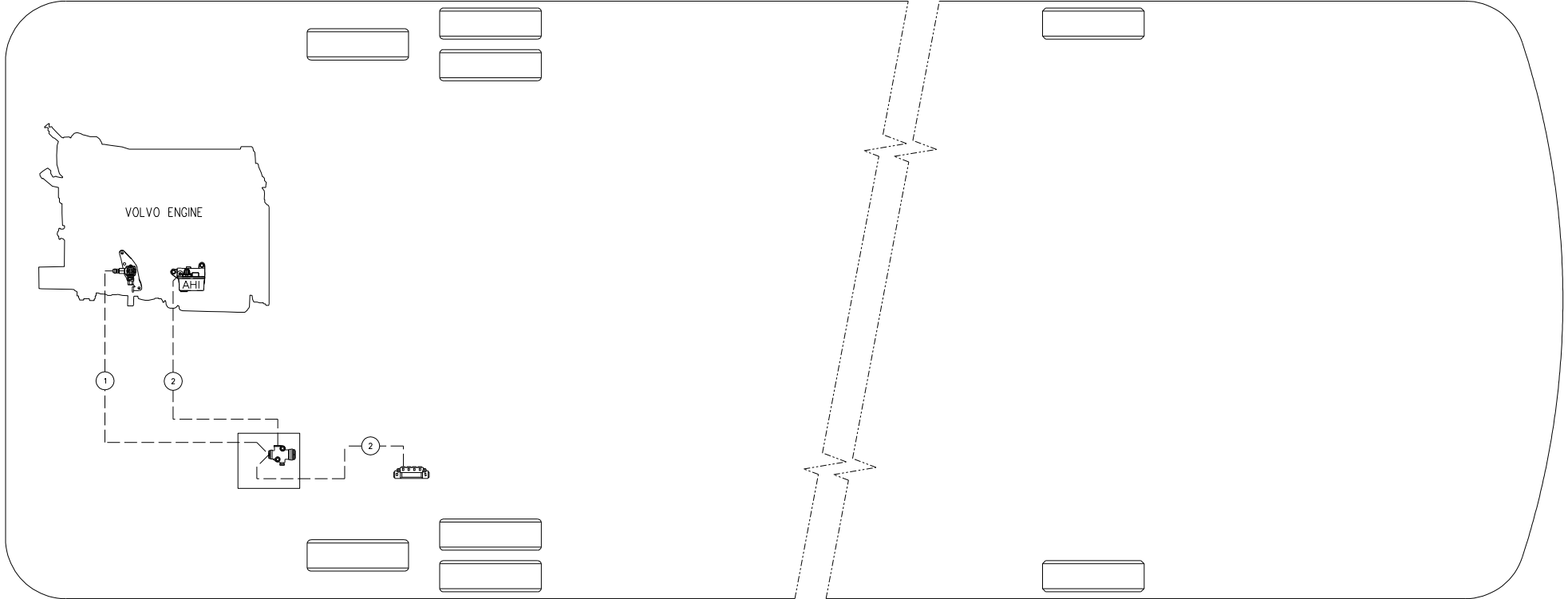

TUBE COLOR CODING	
ACTIVE COLOR	CIRCUIT
--- BLACK	ACCESSORIES

BALLOON	PIPE
*1	HOSE ASS'Y
*2	1/4" O.D. BLACK

PREVOST®

DESCRIPTION: X3-45 COACH, WITH FRONT BEAM AXLE,
WITHOUT OUTPUT RETARDER ON WORLD AND I-SHIFT TRANSMISSION

REV.: B
DATE: 2011/02

PAGE: D140384 P8.1

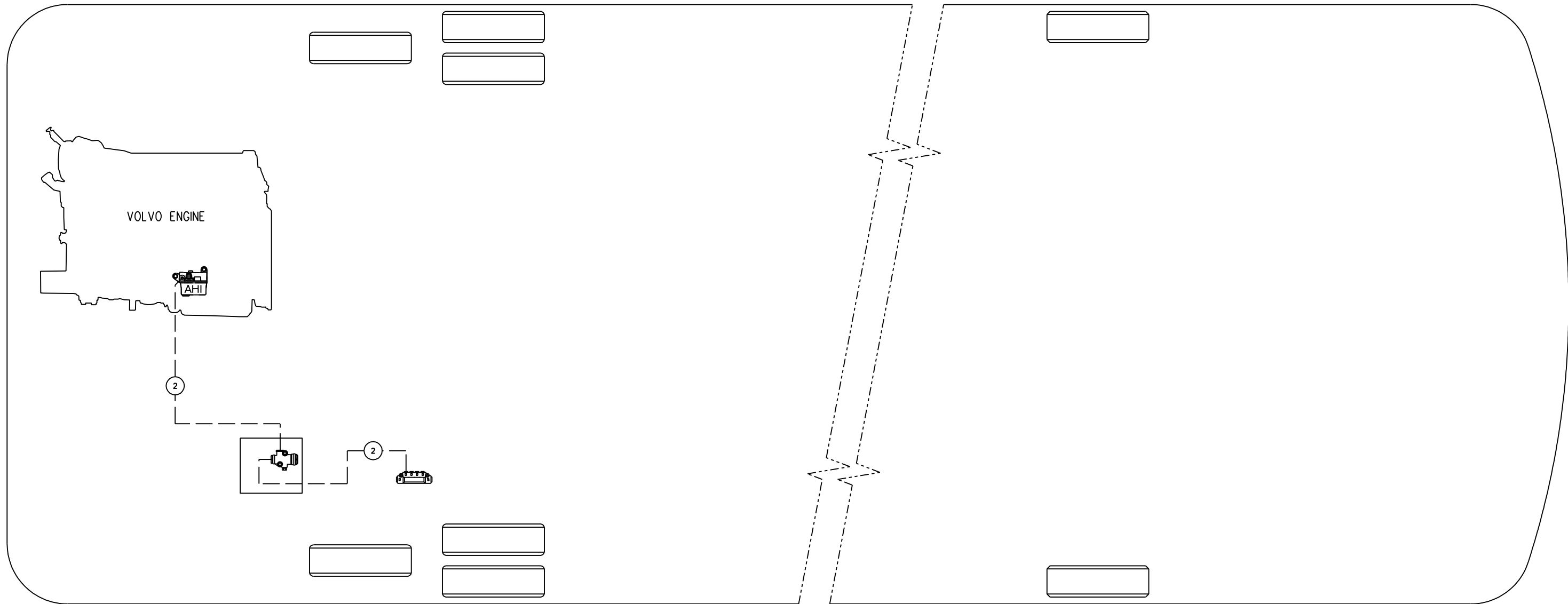

TUBE COLOR CODING		
ACTIVE	COLOR	CIRCUIT
---	BLACK	ACCESSORIES

BALLOON	PIPE
*1	---
*2	1/4" O.D. BLACK

PREVOST®

DESCRIPTION:

X3-45 COACH, WITH FRONT BEAM AXLE,
WITHOUT OUTPUT RETARDER ON WORLD AND I-SHIFT TRANSMISSION

REV.:

C

DATE:

2011/12

PAGE:

D140384 P8.1

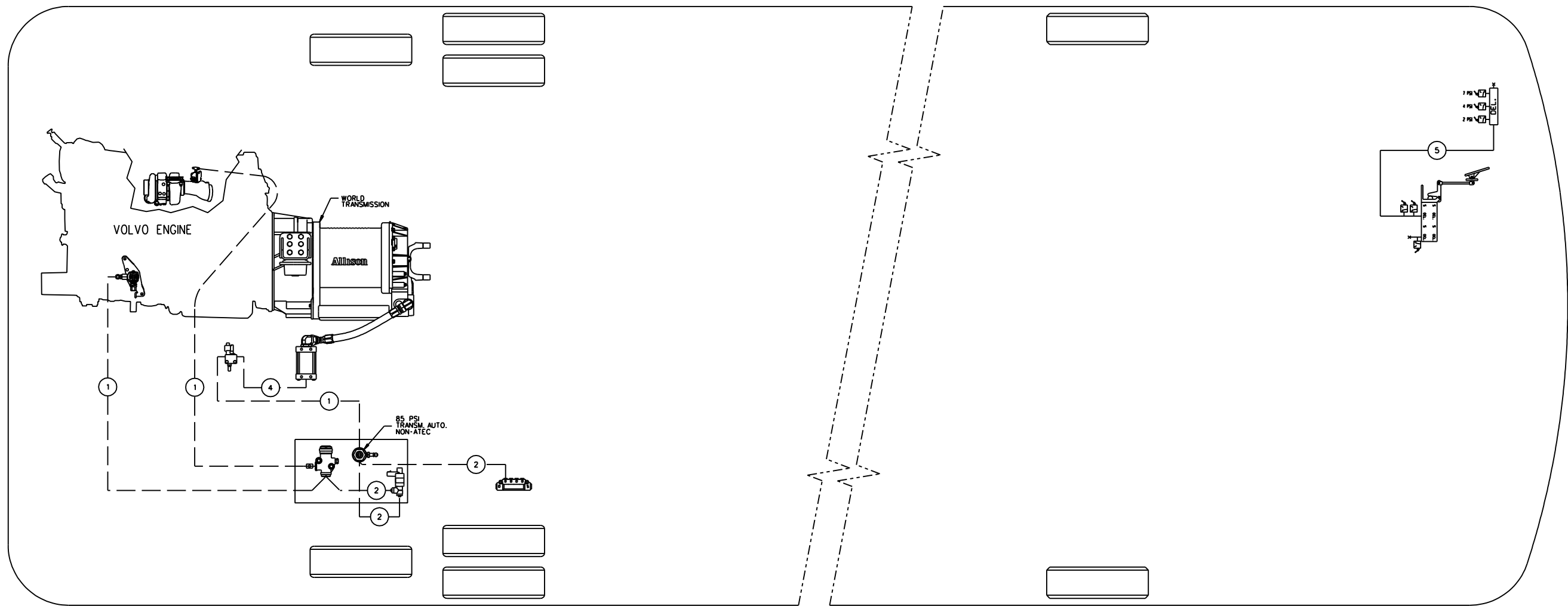

TUBE COLOR CODING		
ACTIVE	COLOR	CIRCUIT
---	BLACK	ACCESSORIES
---	GREEN	PRIMARY & SUPPLY

BALLOON	PIPE
*1	HOSE ASS'Y
*2	1/4" O.D. BLACK
*3	3/8" O.D. BLACK
*4	1/2" O.D. BLACK
*5	3/8" O.D. GREEN

PREVOST®

DESCRIPTION:

X3-45 COACH,
WITH FRONT BEAM AXLE
& OUTPUT RETARDER ON WORLD TRANSMISSION

REV.:

A

DATE:

2010/11

PAGE:

D140384 P9.1

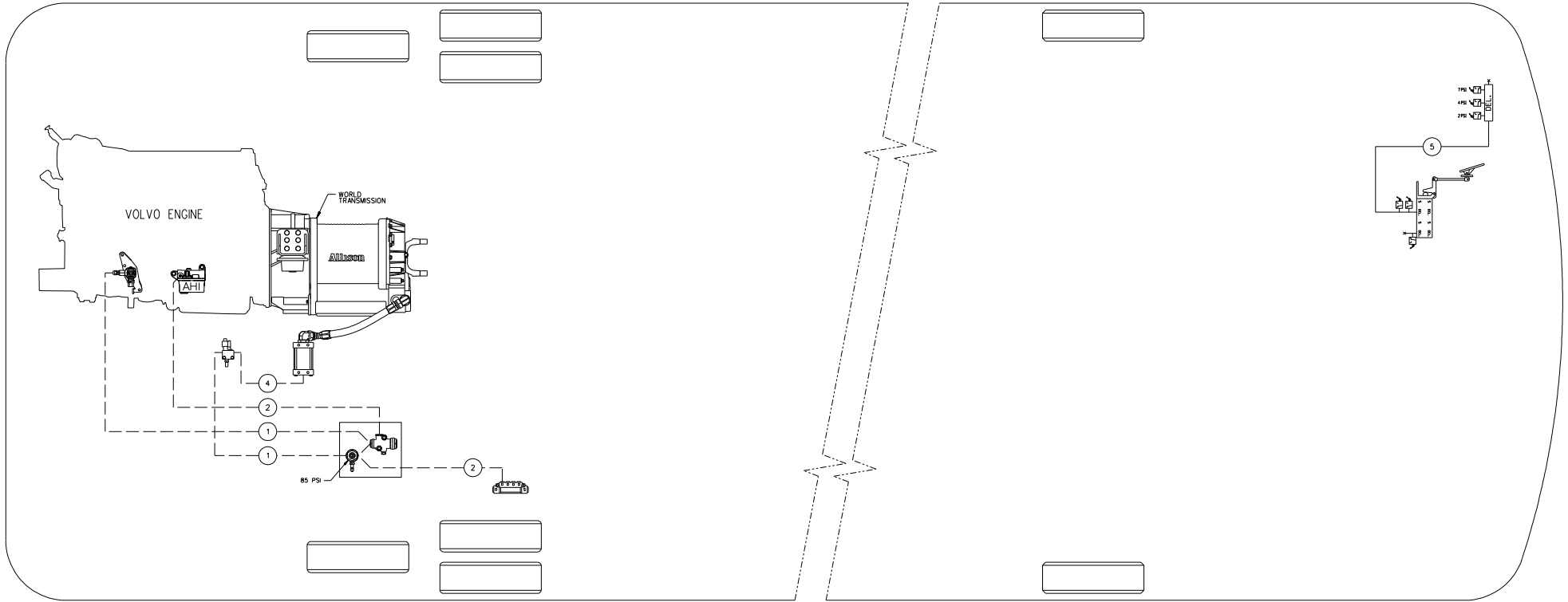

TUBE COLOR CODING	
ACTIVE COLOR	CIRCUIT
---	BLACK ACCESSORIES
---	GREEN PRIMARY & SUPPLY

BALLOON	PIPE
*1	HOSE ASS'Y
*2	1/4" O.D. BLACK
*3	3/8" O.D. BLACK
*4	1/2" O.D. BLACK
*5	3/8" O.D. GREEN

PREVOST®

DESCRIPTION:

X3-45 COACH,
WITH FRONT BEAM AXLE
& OUTPUT RETARDER ON WORLD TRANSMISSION

REV.:

B

DATE:

2011/02

PAGE:

D140384 P9.1

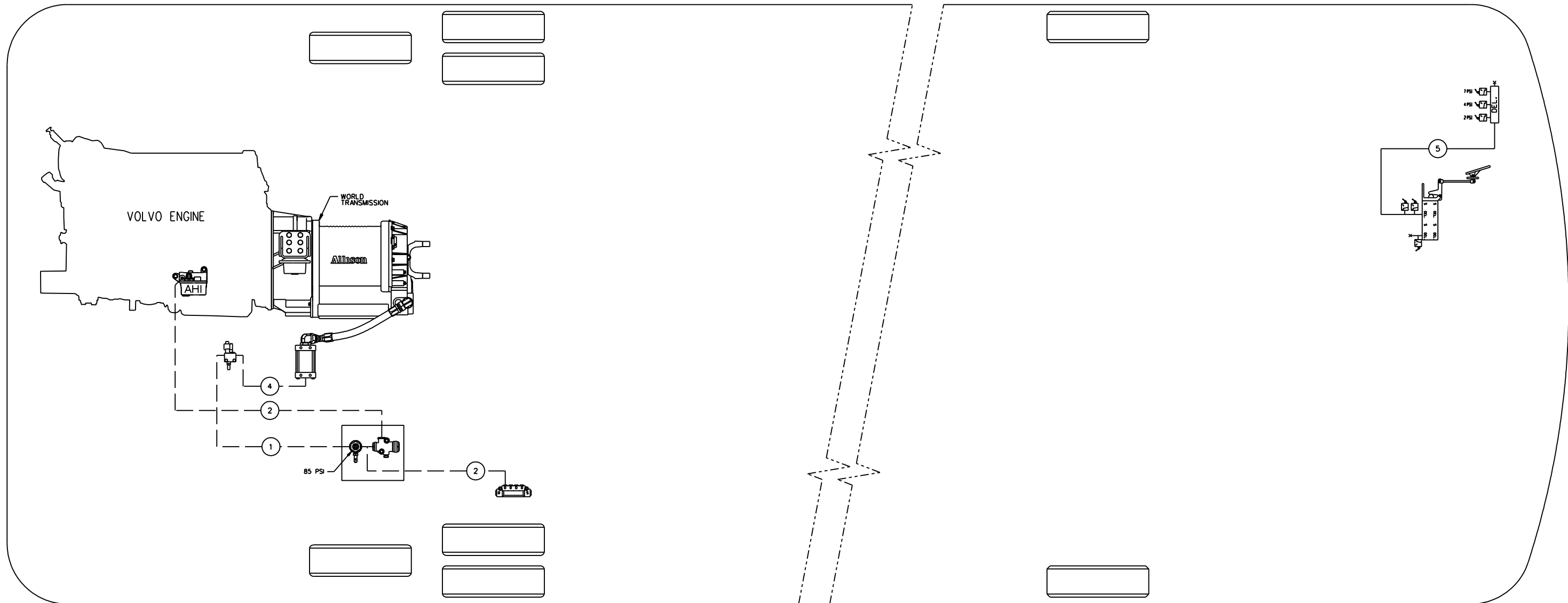

TUBE COLOR CODING		
ACTIVE	COLOR	CIRCUIT
---	BLACK	ACCESSORIES
---	GREEN	PRIMARY & SUPPLY

BALLOON	PIPE
*1	HOSE ASS'Y
*2	1/4" O.D. BLACK
*3	3/8" O.D. BLACK
*4	1/2" O.D. BLACK
*5	3/8" O.D. GREEN

PREVOST®

DESCRIPTION:

X3-45 COACH,
WITH FRONT BEAM AXLE
& OUTPUT RETARDER ON WORLD TRANSMISSION

REV.:

C

DATE:

2011/12

PAGE:

D140384 P9.1

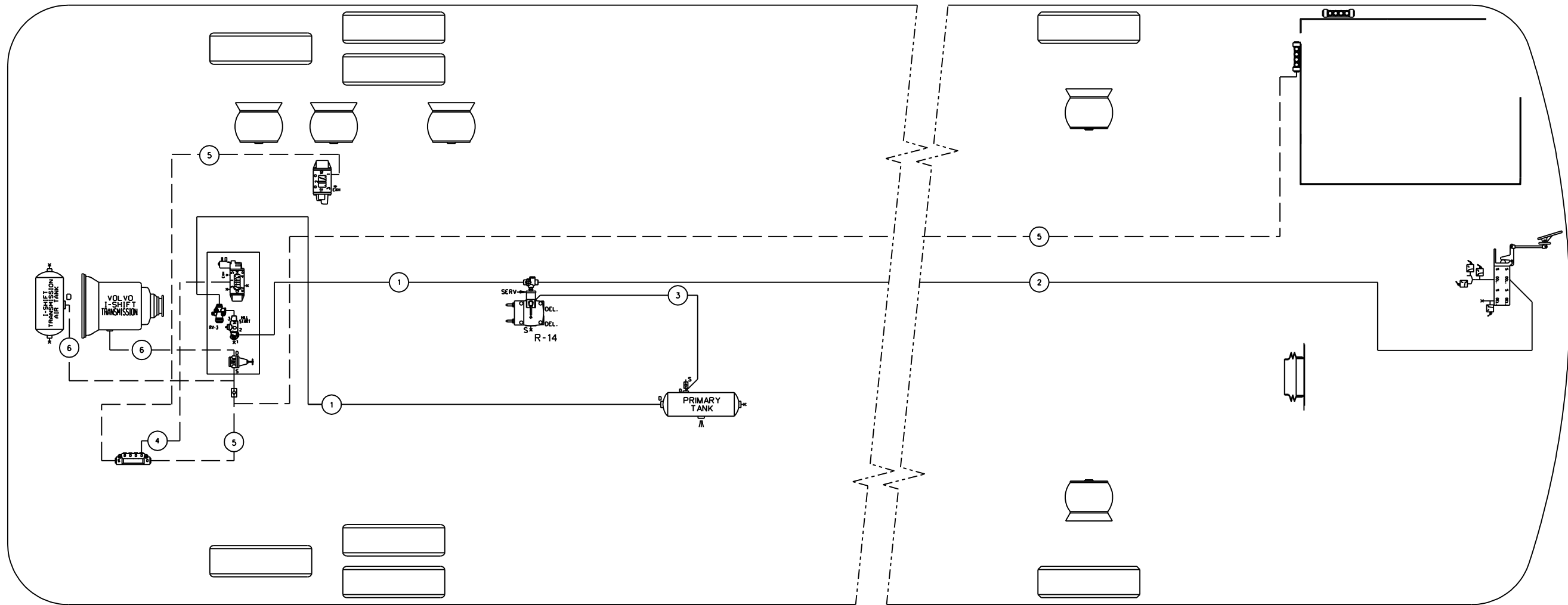

BALLOON	PIPE
*1	3/8" O.D. GREEN
*2	1/2" O.D. GREEN
*3	5/8" O.D. GREEN
*4	1/4" O.D. BLACK
*5	3/8" O.D. BLACK
*6	1/2" O.D. BLACK

TUBE COLOR CODING		
ACTIVE	COLOR	CIRCUIT
—	GREEN	PRIMARY & SUPPLY
—	BLACK	ACCESSORIES

PREVOST®

DESCRIPTION: X3-45 COACH WITH FRONT BEAM AXLE, WITH I-SHIFT TRANSMISSION OPTIONS

REV.: A
DATE: 2010/11

PAGE: D140384 P10.1

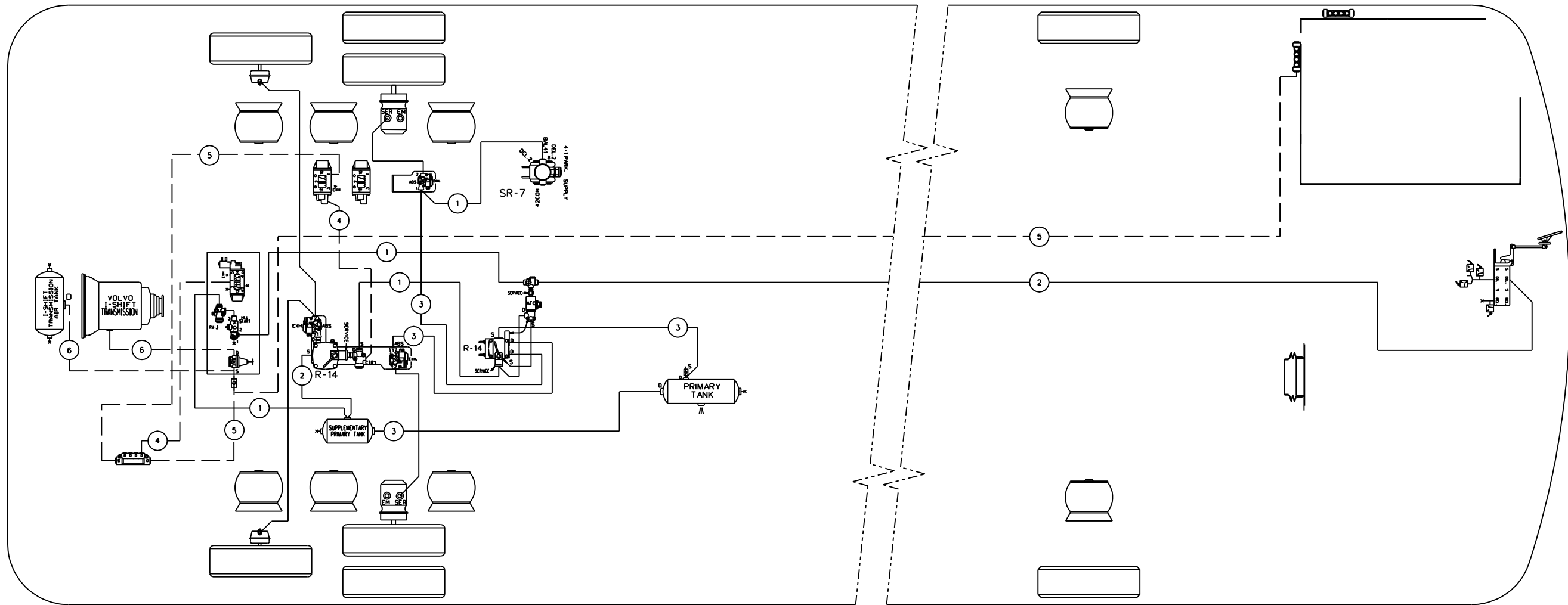

BALLOON	PIPE
*1	3/8" O.D. GREEN
*2	1/2" O.D. GREEN
*3	5/8" O.D. GREEN
*4	1/4" O.D. BLACK
*5	3/8" O.D. BLACK
*6	1/2" O.D. BLACK

TUBE COLOR CODING	
ACTIVE COLOR	CIRCUIT
GREEN	PRIMARY & SUPPLY
BLACK	ACCESSORIES

PREVOST®

DESCRIPTION: X3-45 COACH WITH FRONT BEAM AXLE, WITH ESP & I-SHIFT TRANSMISSION OPTIONS

REV.: A
DATE: 2010/11

PAGE: D140384 P11.1

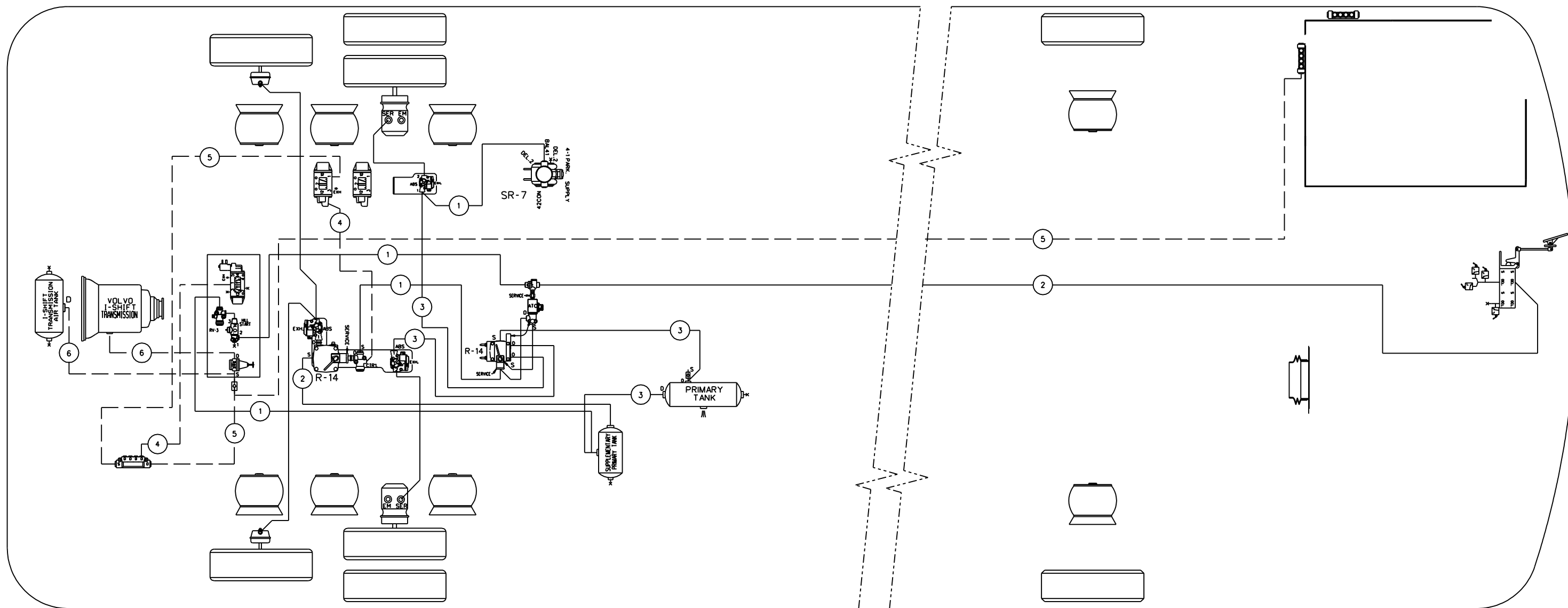

BALLOON	PIPE
#1	3/8" O.D. GREEN
#2	1/2" O.D. GREEN
#3	5/8" O.D. GREEN
#4	1/4" O.D. BLACK
#5	3/8" O.D. BLACK
#6	1/2" O.D. BLACK

TUBE COLOR CODING		
ACTIVE	COLOR	CIRCUIT
—	GREEN	PRIMARY & SUPPLY
—	BLACK	ACCESSORIES

PREVOST®

DESCRIPTION:

X3-45 COACH WITH FRONT BEAM AXLE, WITH ESP & I-SHIFT TRANSMISSION OPTIONS

REV.:

B

DATE:

2011/10

PAGE:

D140384 P11.1

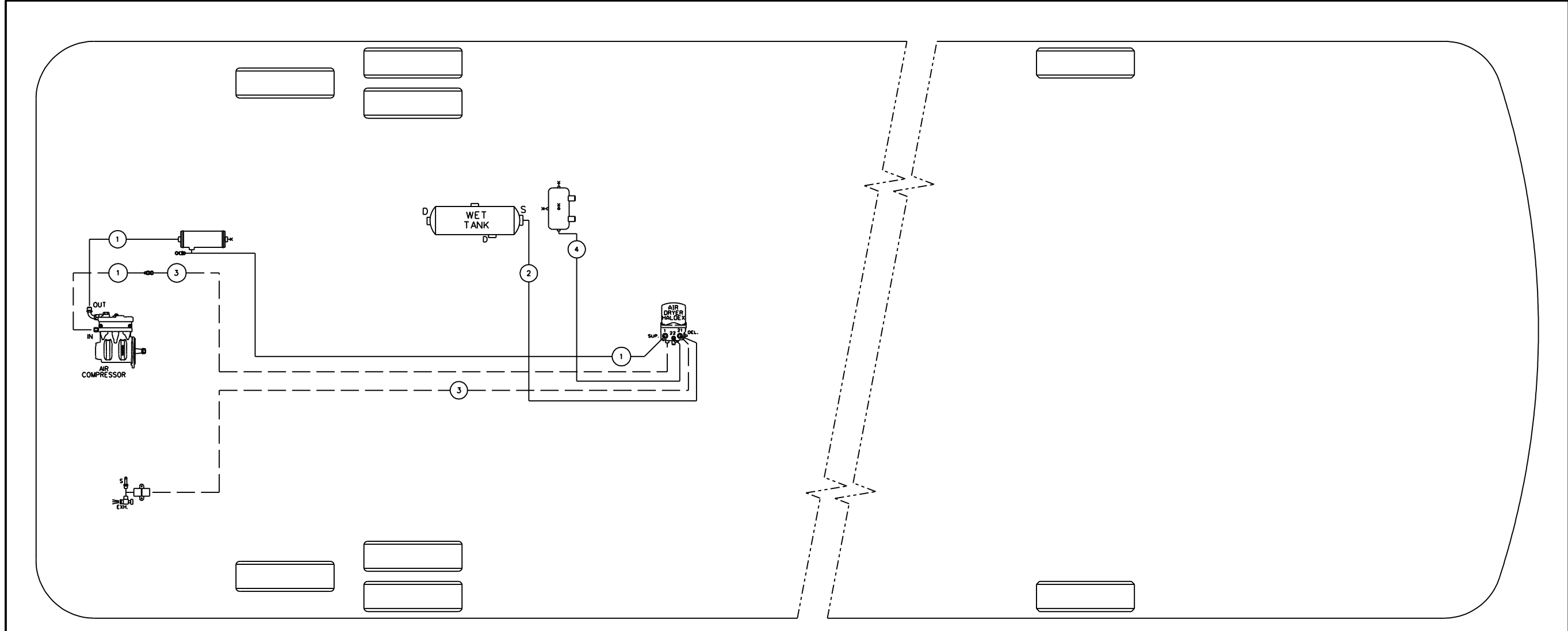

TUBE COLOR CODING	
ACTIVE COLOR	CIRCUIT
— GREEN —	PRIMARY & SUPPLY
— BLACK —	ACCESSORIES

BALLOON	PIPE
•1	HOSE ASS'Y
•2	3/4" O.D. GREEN
•3	1/4" O.D. BLACK
•4	3/8" O.D. GREY

PREVOST®

DESCRIPTION: X3-45 COACH, WITH FRONT BEAM AXLE, OPTION HALDEX AIR DRYER

REV.: A
DATE: 2010/11

PAGE: D140384 P12.1

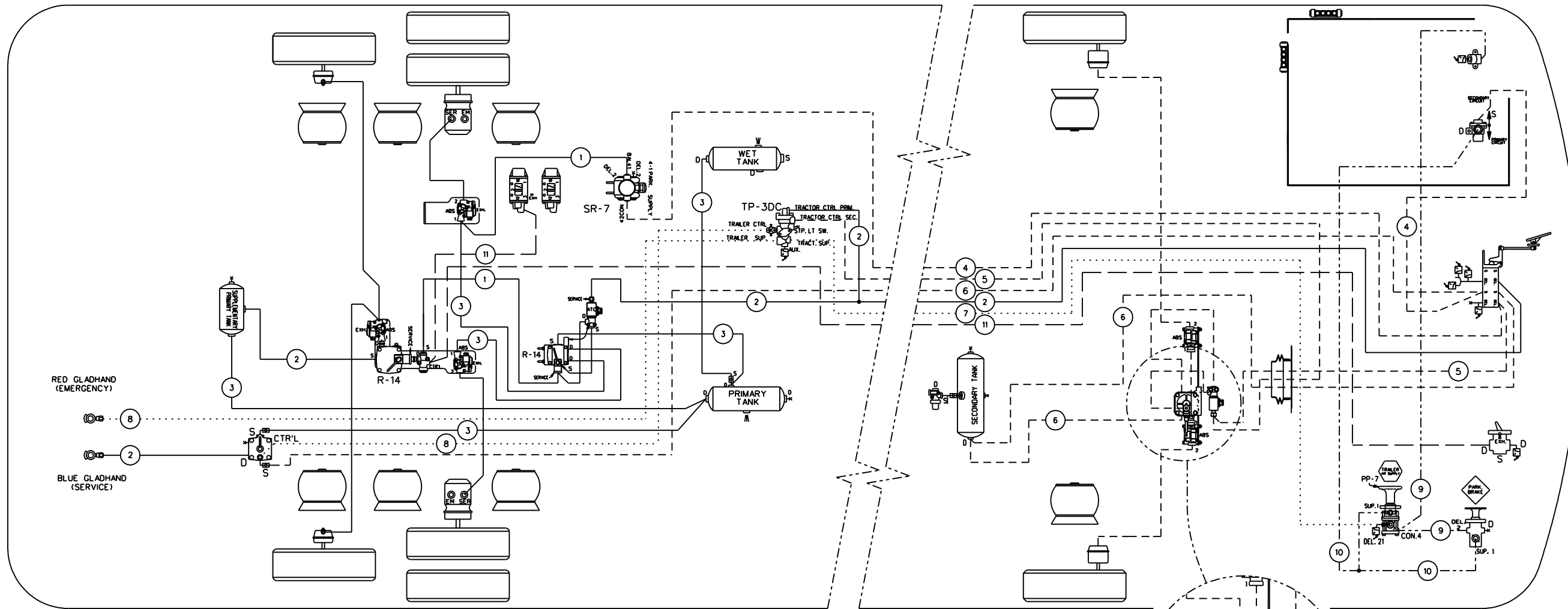

RED GLADHAND
(EMERGENCY)

BLUE GLADHAND
(SERVICE)

BALLOON	PIPE
*1	3/8" O.D. GREEN
*2	1/2" O.D. GREEN
*3	5/8" O.D. GREEN
*4	3/8" O.D. RED
*5	1/2" O.D. RED
*6	5/8" O.D. RED
*7	3/8" O.D. BROWN
*8	1/2" O.D. BROWN
*9	1/4" O.D. YELLOW
*10	3/8" O.D. YELLOW
*11	1/4" O.D. BLACK
*12	5/8" O.D. BLACK

TUBE COLOR CODING	
ACTIVE	CIRCUIT
---	RED SECONDARY
---	GREEN PRIMARY & SUPPLY
---	YELLOW PARKING BRAKE
---	BROWN TRAILER
---	BLACK ACCESSORIES

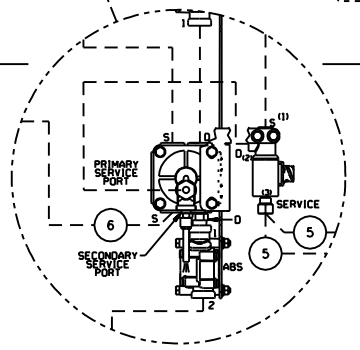

PREVOST

DESCRIPTION:

X3-45 COACH, WITH FRONT BEAM AXLE WITH OPTION
TRAILER HITCH AIR BRAKE WITH ESP

REV.:

A

DATE:

2010/11

PAGE:

D140384 P13.1

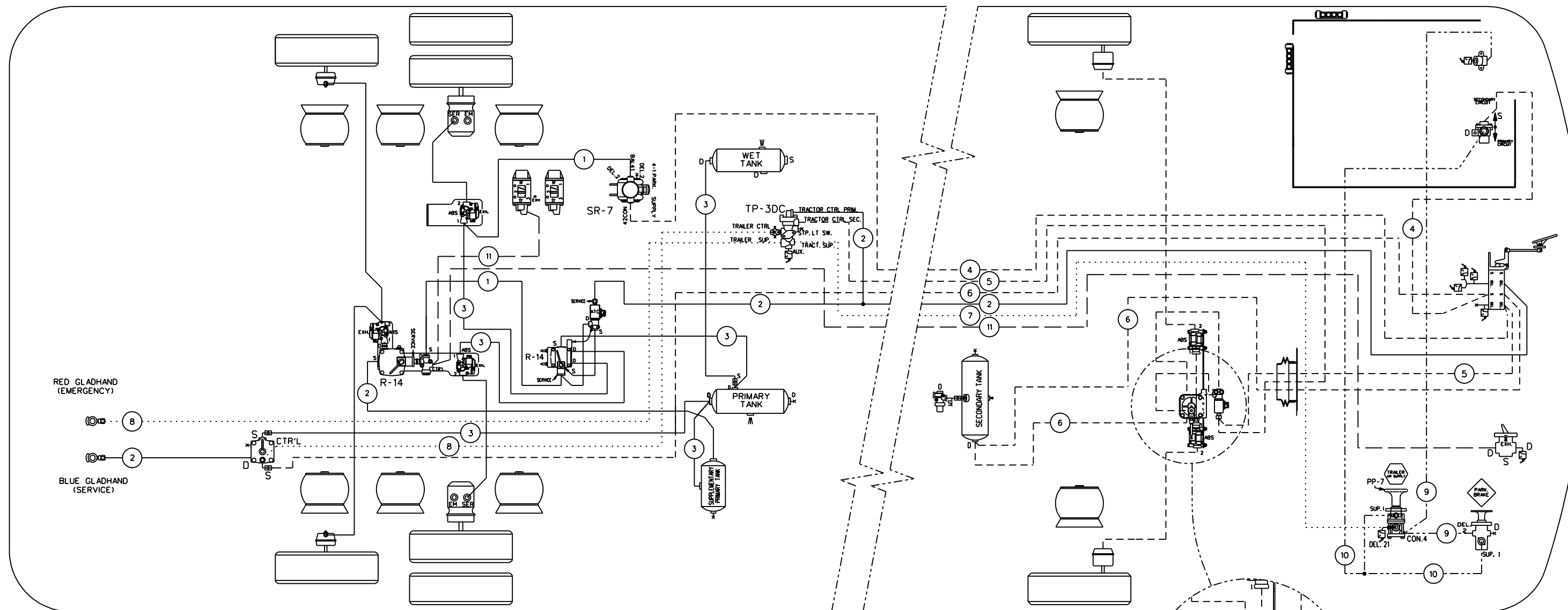

RED GLADHAND
(EMERGENCY)

BLUE GLADHAND
(SERVICE)

BALLOON	PIPE
*1	3/8" O.D. GREEN
*2	1/2" O.D. GREEN
*3	5/8" O.D. GREEN
*4	3/8" O.D. RED
*5	1/2" O.D. RED
*6	5/8" O.D. RED
*7	3/8" O.D. BROWN
*8	1/2" O.D. BROWN
*9	1/4" O.D. YELLOW
*10	3/8" O.D. YELLOW
*11	1/4" O.D. BLACK
*12	5/8" O.D. BLACK

TUBE COLOR CODING	
ACTIVE COLOR	CIRCUIT
---	RED SECONDARY
---	GREEN PRIMARY & SUPPLY
---	YELLOW PARKING BRAKE
---	BROWN TRAILER
---	BLACK ACCESSORIES

PREVOST®

DESCRIPTION:

X3-45 COACH, WITH FRONT BEAM AXLE WITH OPTION TRAILER HITCH AIR BRAKE WITH ESP

REV.:

B

PAGE:

D140384 P13.1

DATE:

2011/04