

## Pneumatic diagram

### PNEUMATIC DIAGRAMS VIP BUS SHELL WITH INDEPENDENT SUSPENSION SYSTEM

NO:	<b>D140355 P0</b>	REVISION :	<b>J</b>
-----	-------------------	------------	----------

EFF. OC#	2006038 2005002	PRIOR TO OC#	<b>2009088</b>
EFF. VEH#	#7-0942	PRIOR TO VEH#	<b>#A-1653...</b>

DR.	Robert Bouillon	date	2010-01-22
CHK	Marc-Jose Handfield	appr	Marc-José Handfield

REV.	DATE	DESCRIPTION	PAGE	BY	CHK.	APPR.
A	2006-10-02	#7-0730 VIP PROTOTYPE VEHICLE , ESP ADVANCED WITH AIR BRAKE ON TRAILER HITCH				
	2007-04-25	#7-0942 VIP PRODUCTION VEHICLE NOTE : AIR BRAKE SYSTEM ABS 6 WITH AIR BRAKE ON TRAILER HITCH NOT AVAILABLE.				
B	2008-01-31	#8-1430 VIP PRODUCTION VEHICLE WITH FOUR SLIDE-OUT ( NEW ) 3 Préliminary Veh. #8-1244 , #8-1332 , #8-1394	7	S.G.	Rob.	M.J.H.
	2008-01-31	#D140355 p.2 Revision B , Update	2	Rob.	Rob.	M.J.H.
	2008-01-31	#D140355 p.3 Revision B , Update	3	Rob.	Rob.	M.J.H.
	2008-01-31	#D140355 p.6 Revision B , Update	6	Rob.	Rob.	M.J.H.
C	2007-10-31	#7-1017 VIP PRODUCTION VEHICLE WITH NEW PINK TANK	1, 1.1,1.2,1.3 1.4	Rob.	Rob.	M.J.H.
D	2008-03-27	TRIPLICATE SLIDE OUT OPTION CONFIGURATION : #D140355 P.6 REVISION : C #D140355 P.8 New page , Revision : A	P 6 & 6.1 P 8 & 8.1	Rob. Rob.	Rob. Rob.	M.J.H. M.J.H.
E	2008-03-31	#D140355P3, Rev C, Update	3 & 3.1	Y.L.	Y.L.	M.J.H.
F	2008-09-11	#D140355SP2 Update special air horn Volvo , New face lift VIP	P2 & 2.1	Rob.	Rob.	M.J.H.
G	2009-01-20	#D140355P3 Rev C , OC#2008107 #D140355SP2 Revision C	P3 & 3.1 SP2 & SP2,1	Rob. Rob.	Rob. Rob.	M.J.H. M.J.H.
H	2009-05-18	#D140355P.1,2,4,5,6,7,8, UPDATE OC#2007032		Rob.	Rob.	M.J.H.
I	2009-11-26	#D140355SP3 NEW Special Liberty Coach , add air horn Bendix box.	SP3 & SP3,1	Rob.	Rob.	M.J.H.
J	2010-01-22	#D140355P9 NEW 7e injector Volvo engine	P9 & P9.1	Y.L.	Y.L.	M.J.H.

# Pneumatic diagram

## *PNEUMATIC DIAGRAMS VIP BUS SHELL WITH INDEPENDENT SUSPENSION SYSTEM*

PRODUCTION NUMBER	REV	EFF. VEH.	ECN	S.A.V. NUMBER	REV	DESCRIPTION
D140355P1.0	A	#7-0942 ...	2006038	D140355P1.1	C	FULL PNEUMATIC ABS 6 AIR BRAKE SYSTEM (WITH STD LEVEL-LOW FINGER TIP SUSPENSION)
	B	#7-1017...	2007062	D140355P1.2	C	ACCESSORIES
	C	#9-1481...	2007032	D140355P1.3	C	BRAKES SYSTEM
				D140355P1.4	C	SUSPENSION
D140355P2.0	A B C	#7-0942 #9-1841	2006038 2007032	D140355P2.1	A B C	AIR BRAKE SYSTEM ESP OPTION
D140355P3.0	A B C D	#7-0730 , #7-0944... #9-1499	2006038 2008107	D140355P3.1	A B C D	AIR BRAKE SYSTEM ESP OPTION WITH AIR BRAKE ON TRAILER HITCH OPTION. (Preliminary Veh. #7-0730)
D140355P4.0	A B	#7-0942 #9-1481	2006038 2007032	D140355P4.1	A B	WITH FRONT SINGLE SLIDE OUT OPTION,LEFT SIDE
D140355P5.0	A B	#7-0730 #9-1481	2006038 2007032	D140355P5.1	A B	WITH DOUBLE SLIDE OUT LEFT SIDE , FRONT AND REAR. SMALL OR LARGE SIZE REAR CAISSON POSSIBILITY OPTION.
D140355P6.0	A B C D	#8-1071 #8-1415 #9-1481	2006038 2005062 2008011 2007032	D140355P6.1	A B C D	WITH TRIPPLICATE SLIDE OUT , LEFT SIDE FRONT AND REAR , RIGHT SIDE REAR. (Preliminary Veh. #7-0944, #7-0989) SMALL OR LARGE SIZE REAR CAISSON POSSIBILITY OPTION
D140355P7.0	A B	#8-1415 #9-1481	2005063 2007032	D140355P7.1	A B	WITH QUADRUPLE SLIDE OUT , LEFT SIDE FRONT AND REAR , RIGHT SIDE FRONT AND REAR. (Preliminary Veh. #8-1244, #8-1332 , #8-1394) SMALL OR LARGE SIZE REAR CAISSON POSSIBILITY OPTION
D140355P8.0	A B	#8-1415 #9-1481	2008011 2007032	D140355P8.1	A B	WITH TRIPPLICATE SLIDE OUT , LEFT SIDE FRONT AND REAR , RIGHT SIDE FRONT. SMALL OR LARGE SIZE REAR CAISSON POSSIBILITY OPTION
D140355P9.0	A	#A-1653		D140355P9.1	A	VOLVO ENGINE SOLENOID 7 th INJECTOR
D140355SP1.0	A	#7-0942	2006038	D140355SP1.1	A	“SPECIAL” WITH EXTRA AIR TANK ADDED TO FRONT SUSPENSION ( First application #6-0353)

# Pneumatic diagram

## *PNEUMATIC DIAGRAMS VIP BUS SHELL WITH INDEPENDENT SUSPENSION SYSTEM*

D140355SP2.0	A B C	#7-0942 #9-1481 #9-1499	2006038 2007032 2008107	D140355SP2.1	A B C	“SPECIAL” WITH AIR HORN ADDED (First application #8-0868) ( Preliminary New Face Lift VIP # 9-1411 )
D140355SP3.0	A	#A-1607		D140355SP3.1	A	“SPECIAL” WITH AIR HORN BENDIX BOX AND SOLENOID CONTROL ADDED. (First application #A-1607 Liberty Coach Inc.)

ACTIVE	COLOR	CIRCUIT
---	RED	SECONDARY
---	GREEN	PRIMARY & SUPPLY
---	YELLOW	PARKING BRAKES
---	BLUE	STANDARD SUSPENSION
---	BLACK	ACCESSORIES

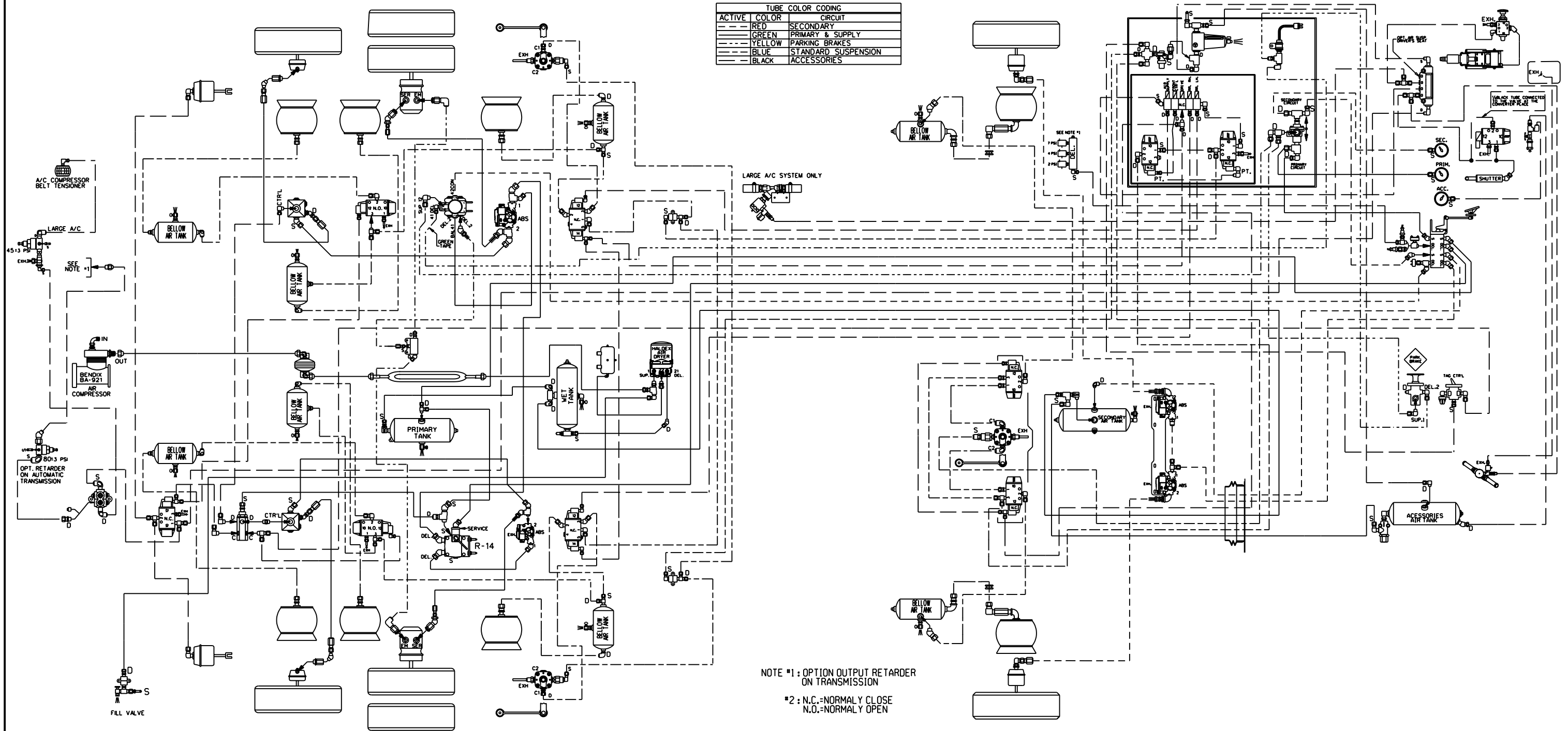

NOTE #1 : OPTION OUTPUT RETARDER ON TRANSMISSION  
 #2 : N.C.-NORMALY CLOSE  
 N.O.-NORMALY OPEN

**PREVOST**

DESCRIPTION: VIP, ENGINE 2007,  
 WITH INDEPENDENT SUSPENSION SYSTEM  
 -FULL PNEUMATIC ABS 6 BASIC SYSTEM-

EFF. W/ VEH : #7-0942...  
 DATE: 2007/05  
 REV.: A

PAGE: D140355 P1.1

ACTIVE	COLOR	CIRCUIT
---	RED	SECONDARY
---	GREEN	PRIMARY & SUPPLY
---	YELLOW	PARKING BRAKES
---	BLUE	STANDARD SUSPENSION
---	BLACK	ACCESSORIES

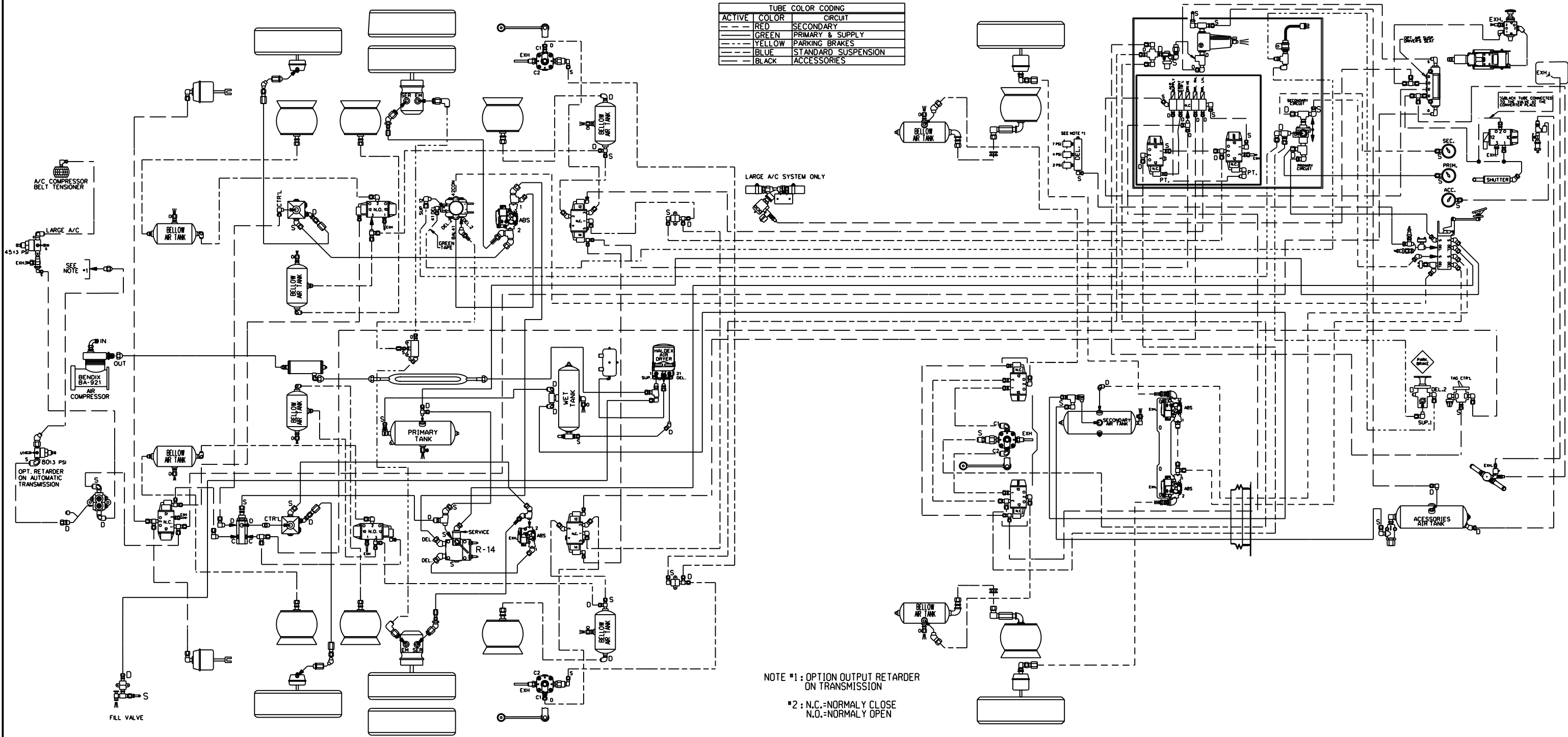

NOTE #1 : OPTION OUTPUT RETARDER ON TRANSMISSION  
 #2 : N.C.=NORMALY CLOSE  
 N.O.=NORMALY OPEN

**PREVOST**®

DESCRIPTION: VIP, ENGINE 2007,  
 WITH INDEPENDENT SUSPENSION SYSTEM  
 FULL PNEUMATIC ABS 6 BRAKE SYSTEM

EFF. W/ VEH : #7-1017...  
 DATE: 2007/10  
 REV.: B

PAGE: D140355 P1.1

TUBE COLOR CODING		
ACTIVE	COLOR	CIRCUIT
---	RED	SECONDARY
---	GREEN	PRIMARY & SUPPLY
---	YELLOW	PARKING BRAKES
---	BLUE	STANDARD SUSPENSION
---	BLACK	ACCESSORIES

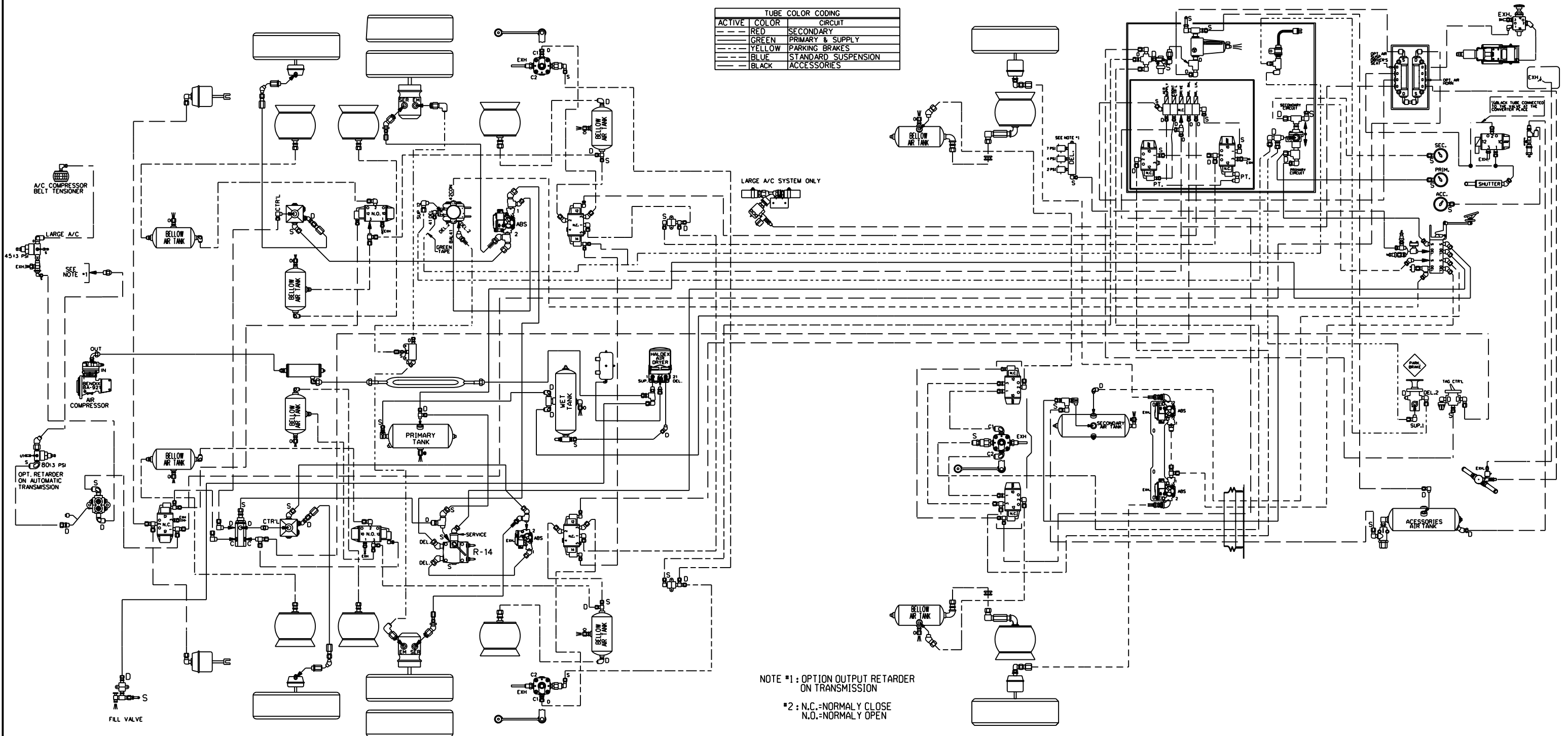

**PREVOST®**

DESCRIPTION:

VIP, ENGINE 2007,  
WITH INDEPENDENT SUSPENSION SYSTEM  
-FULL PNEUMATIC ABS 6 SYSTEM-

EFF. W/ VEH : #7-1026...

PAGE:

D140355 P1.1

DATE:  
2009/05

REV.:  
C

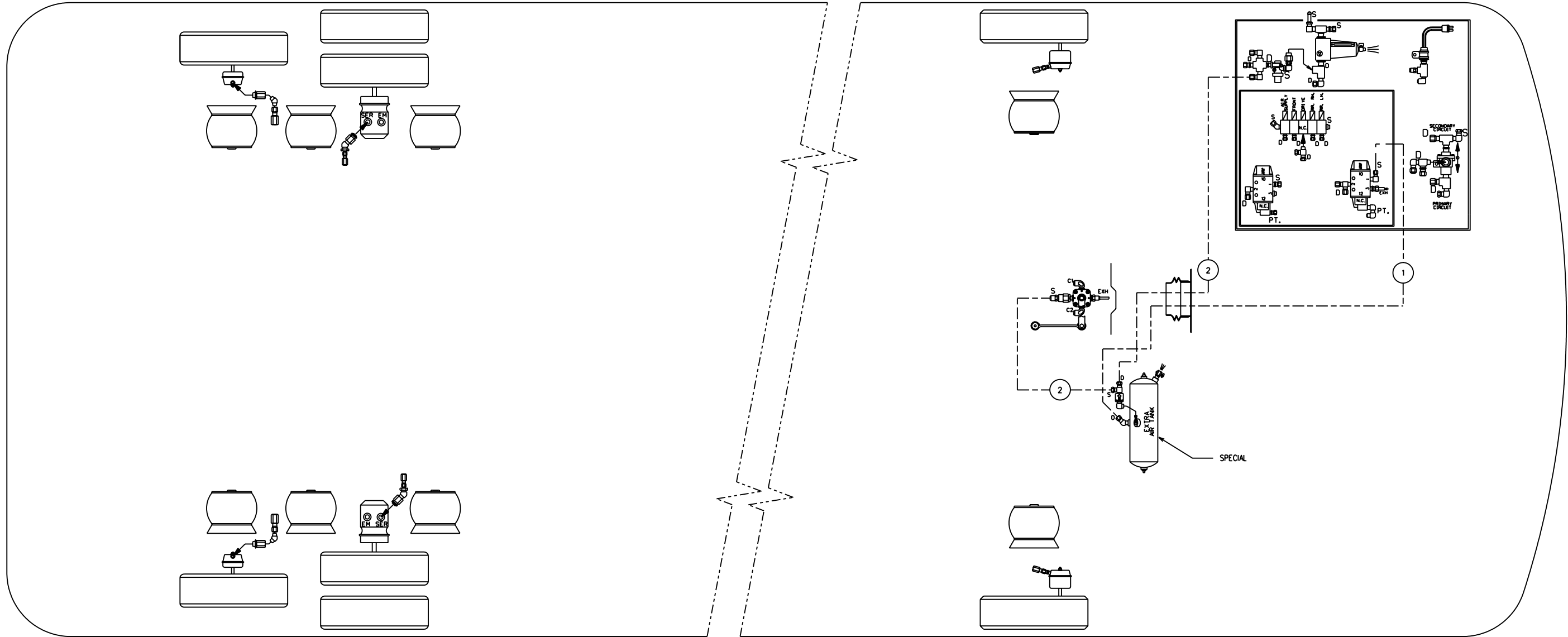

TUBE COLOR CODING			BALLOON	PIPE
ACTIVE	COLOR	CIRCUIT	*1	1/2" O.D. BLUE
---	BLACK	ACCESSORIES	*2	3/8" O.D. BLUE
---	BLUE	SUSPENSION		

**PREVOST®**

DESCRIPTION: VIP, ENGINE 2007 WITH INDEPENDENT SUSPENSION SYSTEM  
SPECIAL WITH EXTRA AIR TANK ADDED TO FRONT SUSPENSION

EFF. W/ VEH : #6-0353...  
DATE: 2007/05  
REV.: A

PAGE:  
D140355 SP1.1

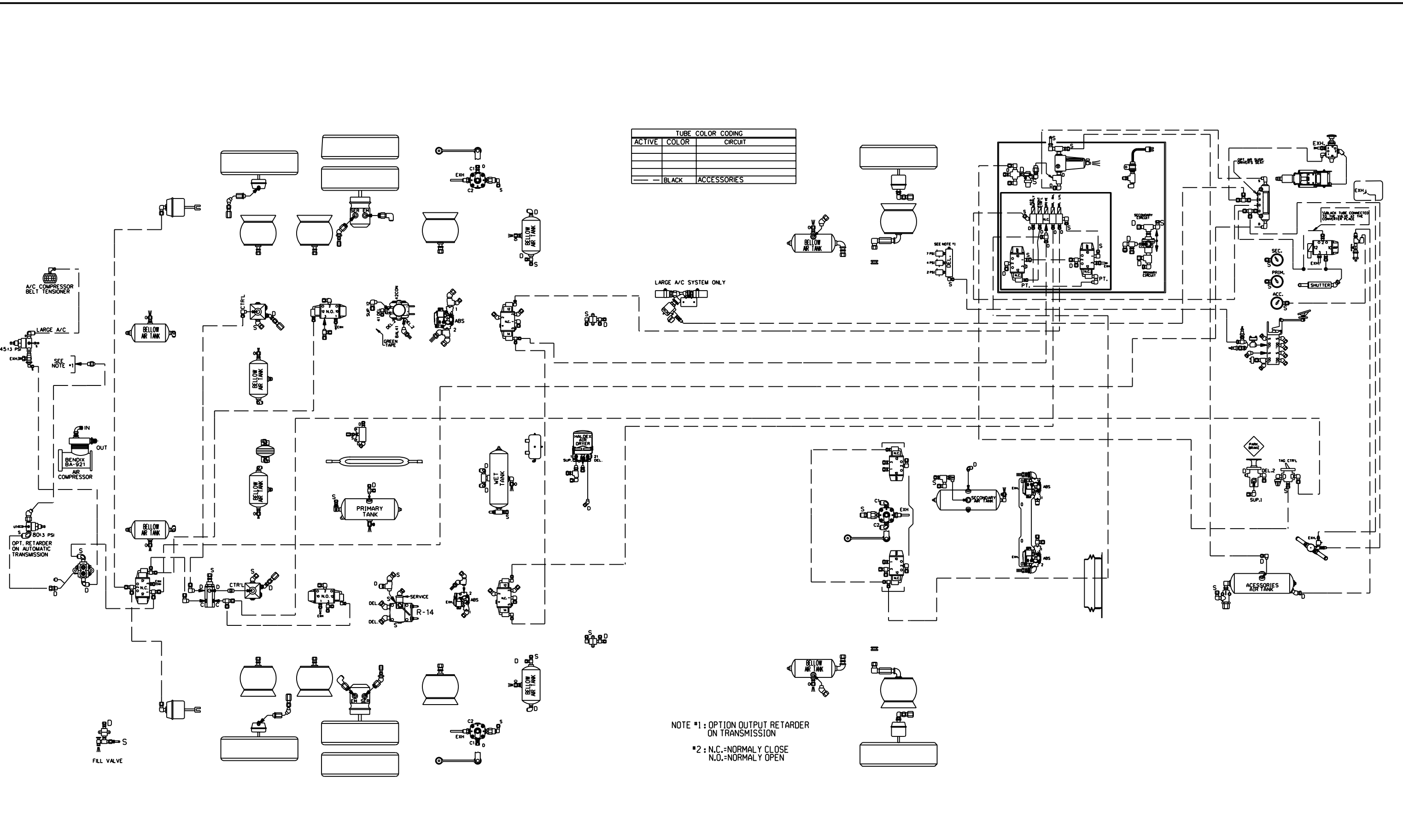

**PREVOST**

DESCRIPTION: VIP, ENGINE 2007,  
WITH INDEPENDENT SUSPENSION SYSTEM  
-ACCESSORIES-

EFF. W/ VEH : #7-0942...  
DATE: 2007/05  
REV.: A

PAGE: D140355 P1.2



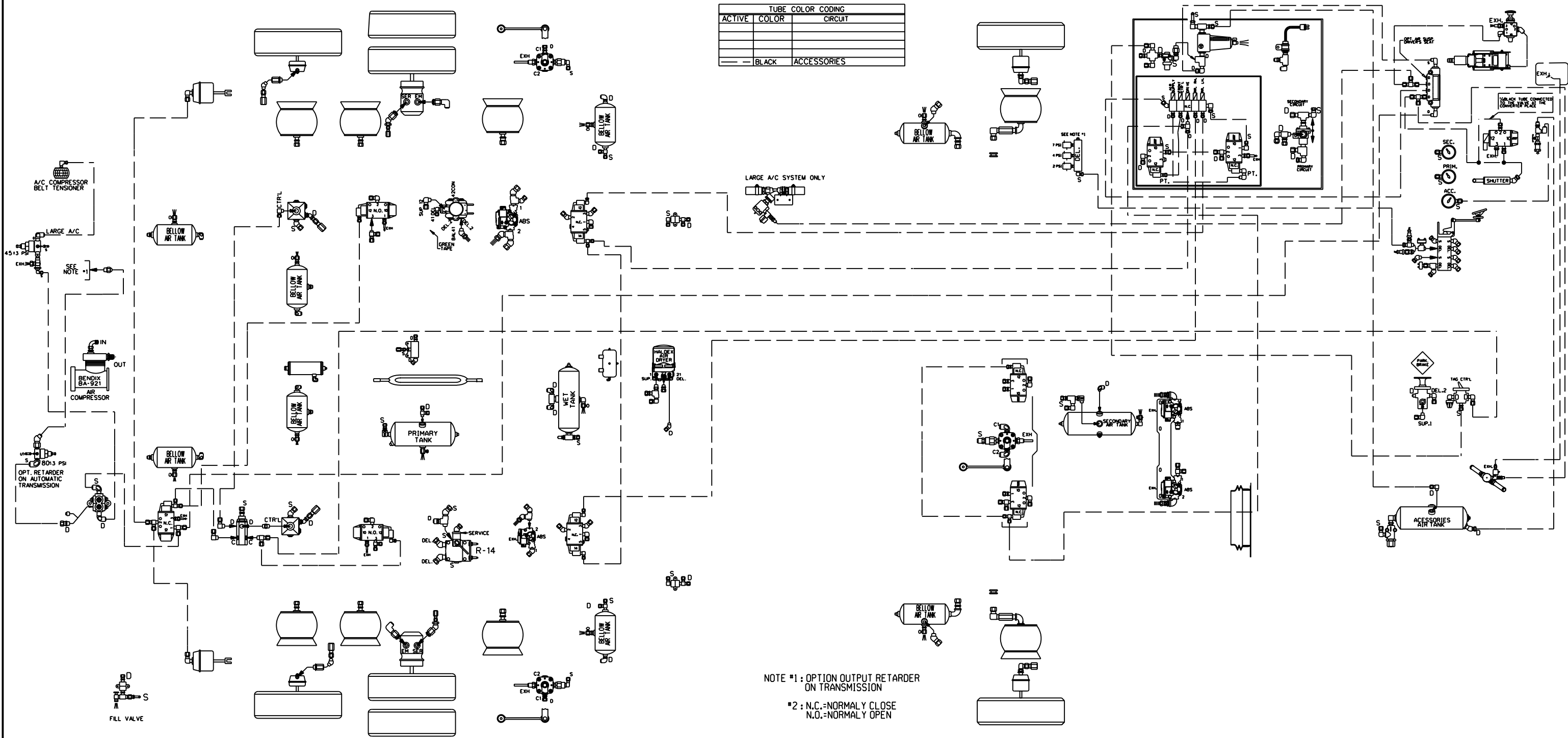

**PREVOST®**

DESCRIPTION:

VIP, ENGINE 2007,  
 WITH INDEPENDENT SUSPENSION SYSTEM  
 -ACCESSORIES-

EFF. W/ VEH : #7-1017...  
 DATE: 2007/10  
 REV.: B

PAGE:  
 D140355 P1.2

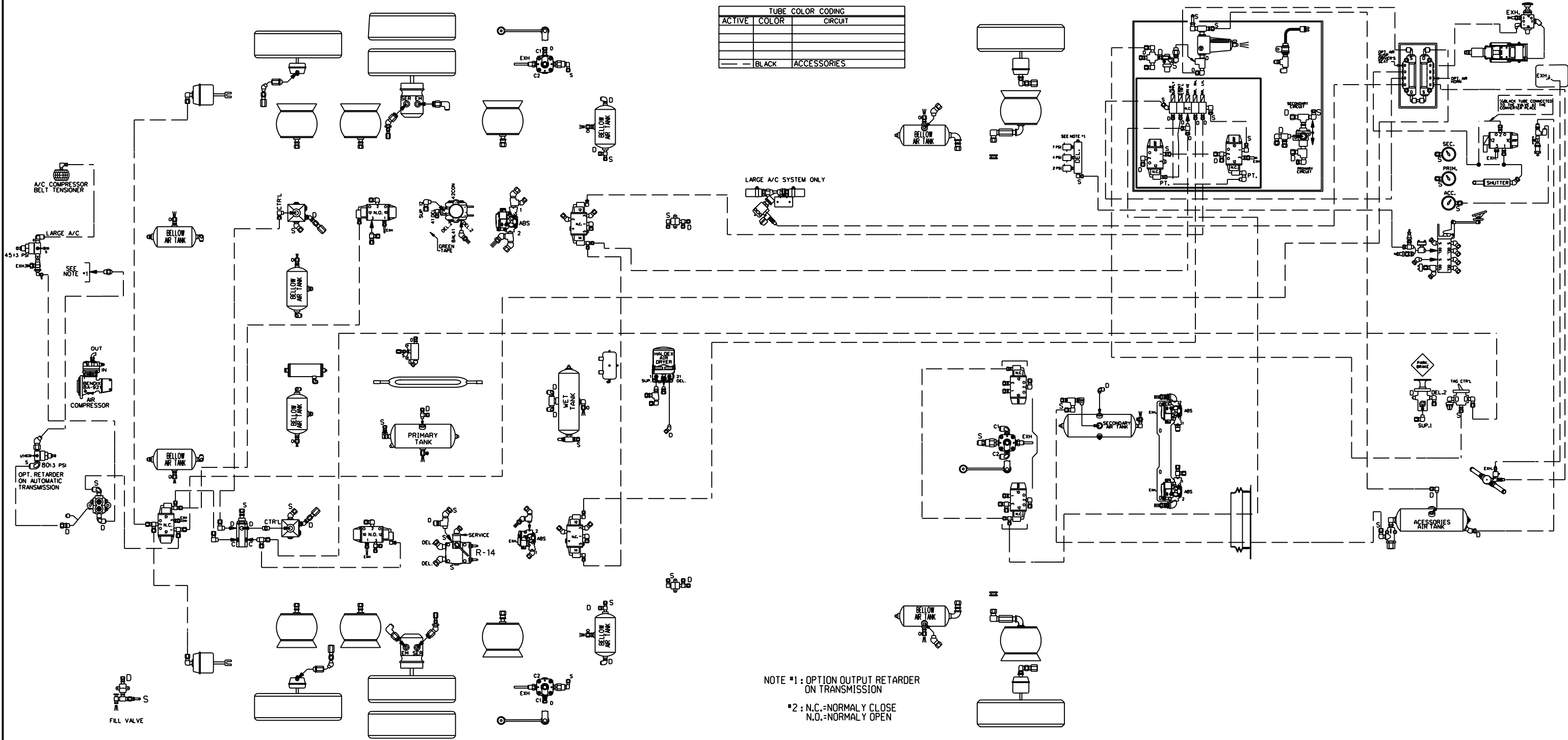

**PREVOST®**

DESCRIPTION:

VIP, ENGINE 2007,  
WITH INDEPENDENT SUSPENSION SYSTEM  
-ACCESSORIES-

EFF. W/ VEH : #7-1017...

PAGE:

D140355 P1.2

DATE: 2009/05

REV.: C

TUBE COLOR CODING		
ACTIVE	COLOR	CIRCUIT
---	RED	SECONDARY
---	GREEN	PRIMARY & SUPPLY
---	YELLOW	PARKING BRAKES

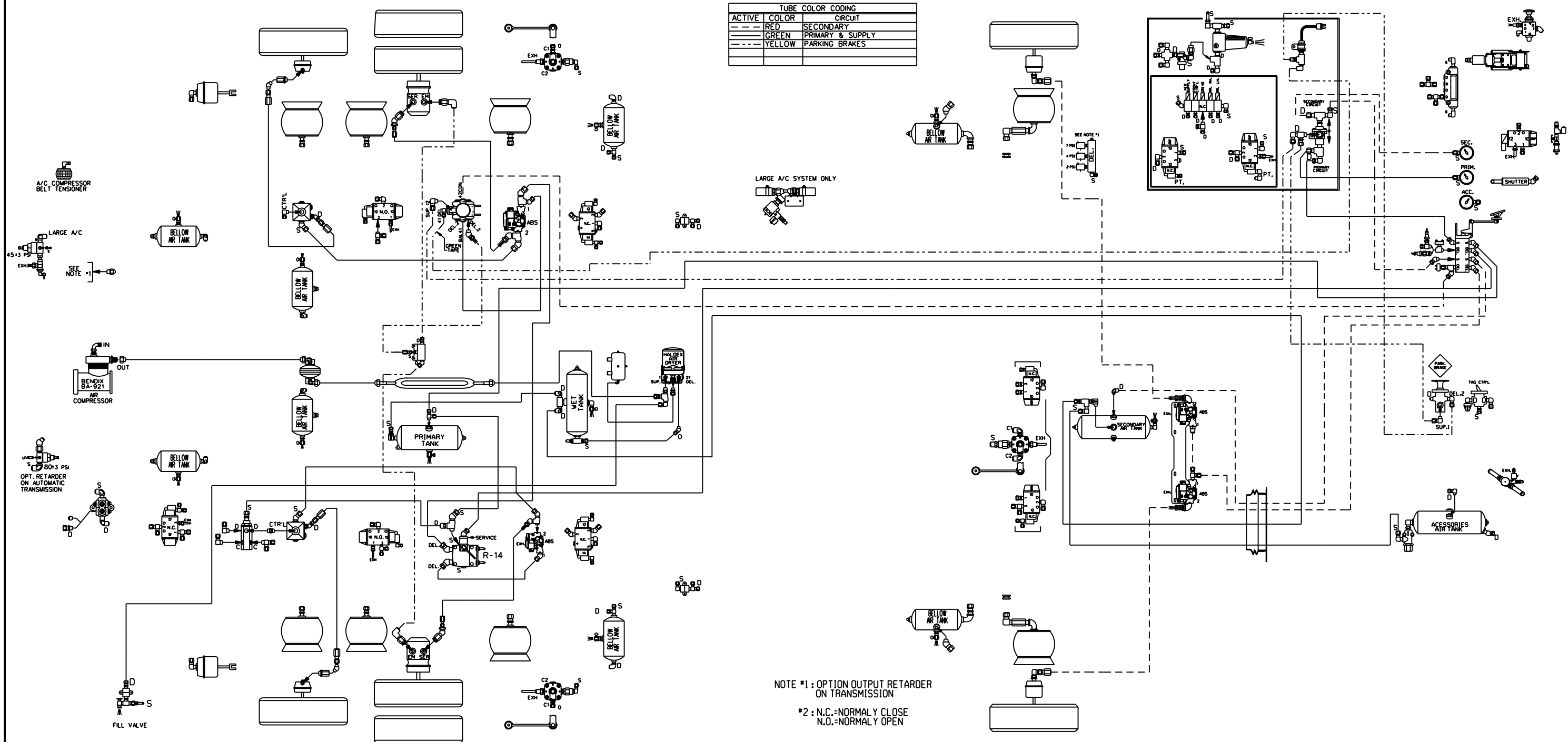

NOTE #1 : OPTION OUTPUT RETARDER ON TRANSMISSION  
 #2 : N.C.-NORMALY CLOSE  
 N.O.-NORMALY OPEN

**PREVOST**

DESCRIPTION:  
 VIP, ENGINE 2007,  
 WITH INDEPENDENT SUSPENSION  
 -AIR BRAKES ABS 6 BASIC SYSTEM-

EFF. W/ VEH : #7-0942...  
 DATE: 2007/05  
 REV.: A

PAGE:  
 D140355 P1.3

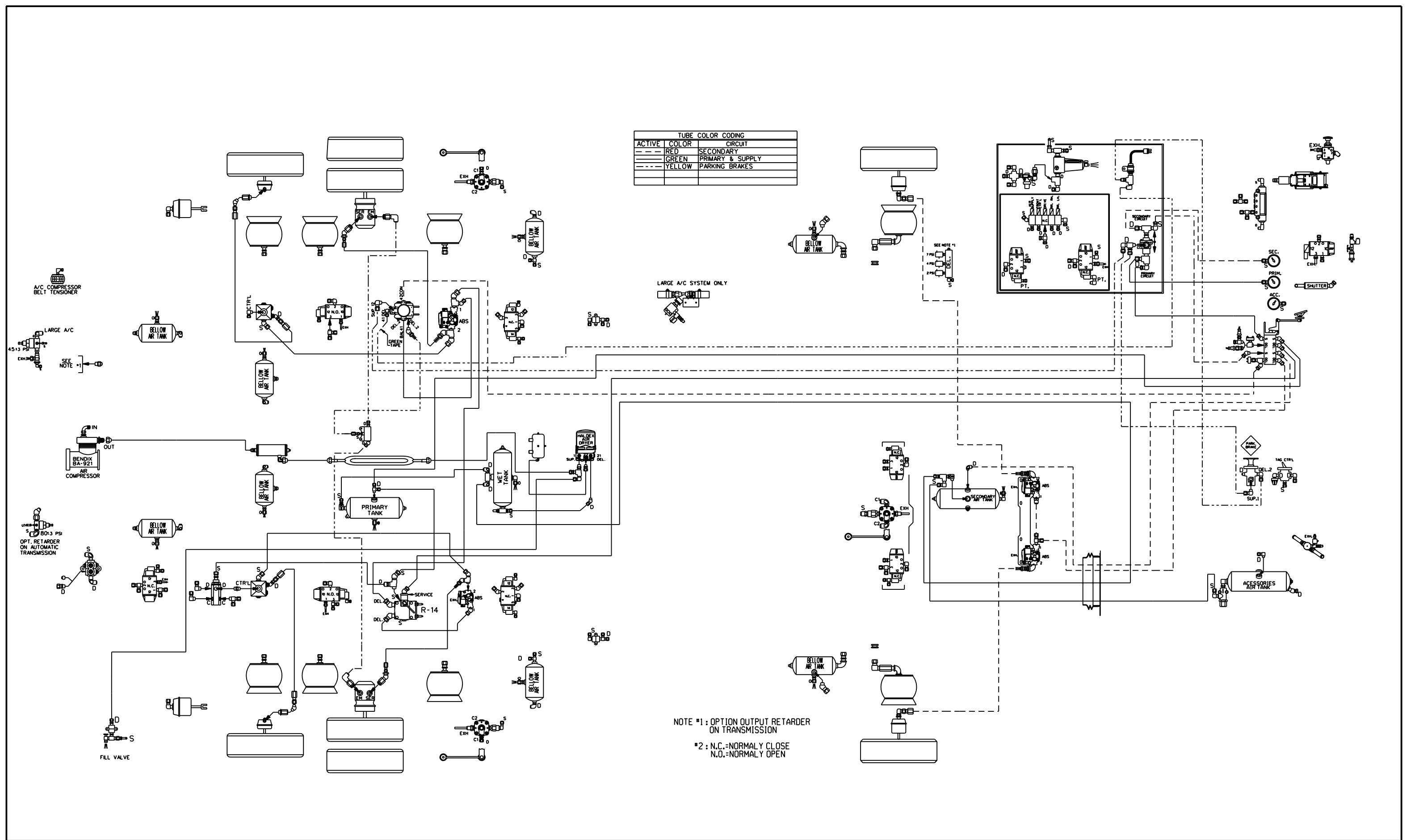

**PREVOST®**

DESCRIPTION:

VIP, ENGINE 2007,  
WITH INDEPENDENT SUSPENSION  
AIR BRAKES ABS 6 BRAKE SYSTEM

EFF. W/ VEH : #7-1017...

PAGE:

D140355 P1.3

DATE:  
2007/10

REV.:  
B

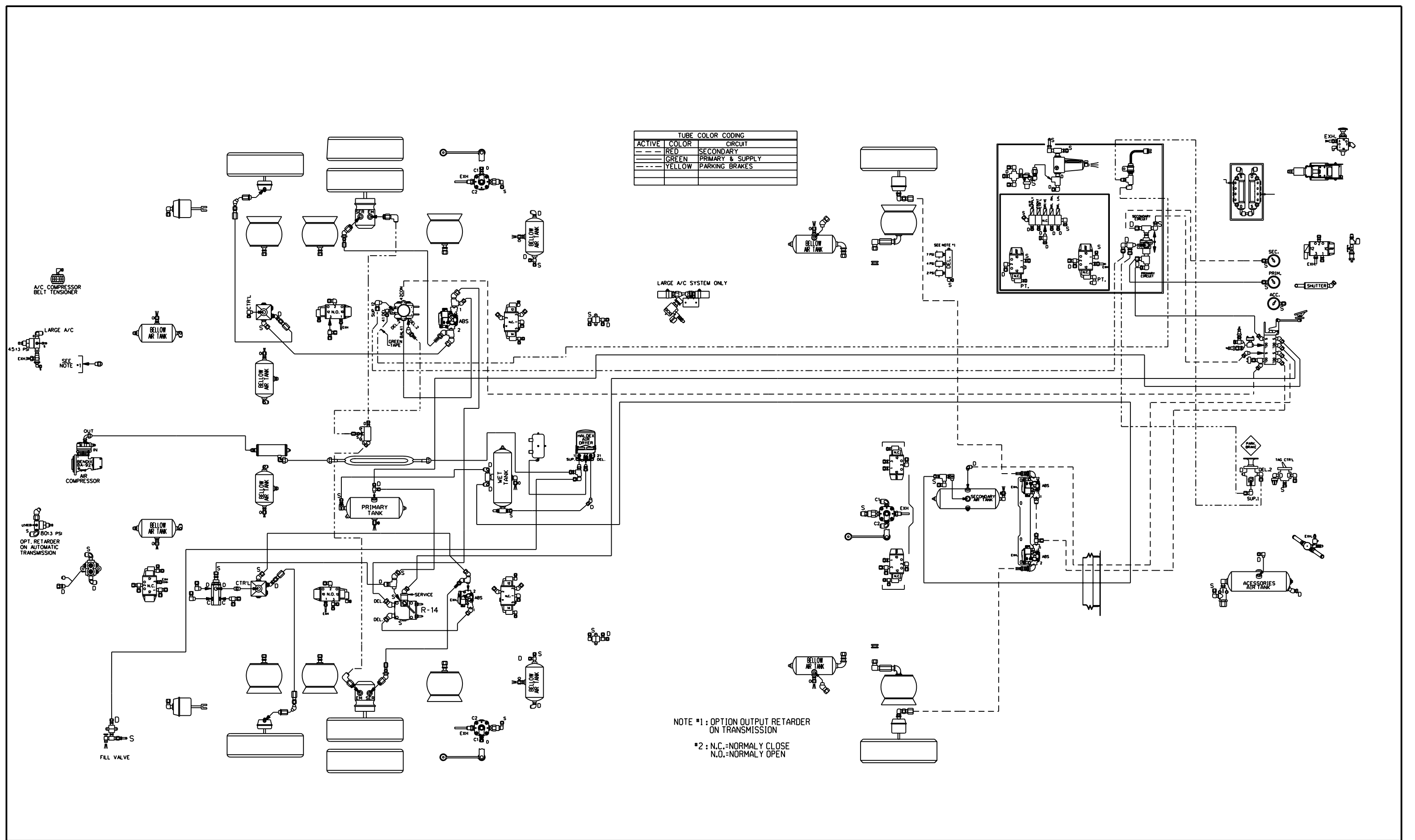

**PREVOST**®

DESCRIPTION:

VIP, ENGINE 2007,  
WITH INDEPENDENT SUSPENSION  
-AIR BRAKES ABS 6 SYSTEM-

EFF. W/ VEH : #7-1017...

PAGE:

D140355 P1.3

DATE:  
2009/05

REV.:  
C

TUBE COLOR CODING		
ACTIVE	COLOR	CIRCUIT
---	BLUE	STANDARD SUSPENSION

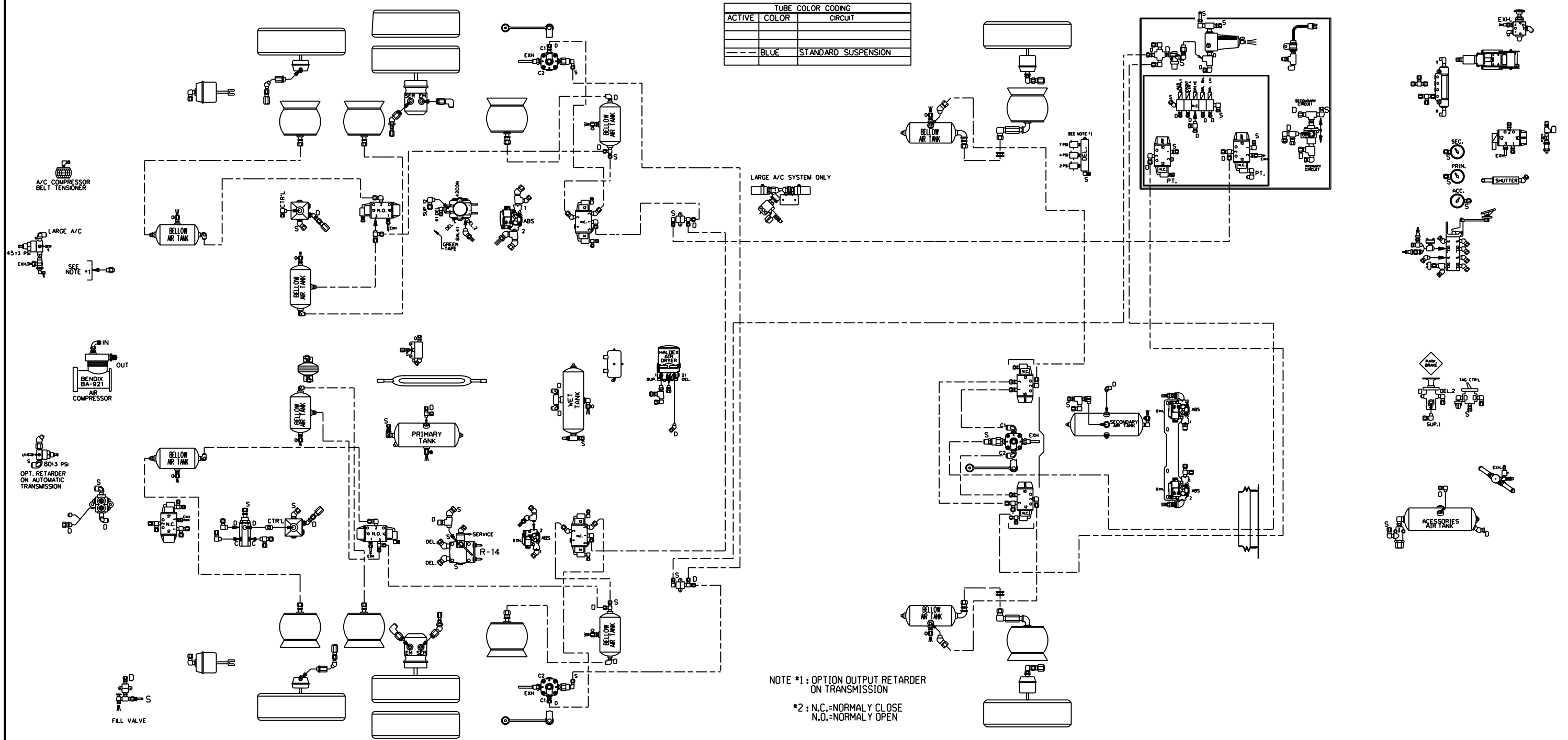

NOTE #1 : OPTION OUTPUT RETARDER ON TRANSMISSION  
 #2 : N.C.-NORMALY CLOSE  
 N.O.-NORMALY OPEN

**PREVOST**

DESCRIPTION: VIP, ENGINE 2007,  
 WITH INDEPENDENT SUSPENSION SYSTEM  
 -STANDARD SUSPENSION-

EFF. W/ VEH : #7-0942...  
 DATE: 2007/05  
 REV.: A

PAGE:  
 D140355 P1.4

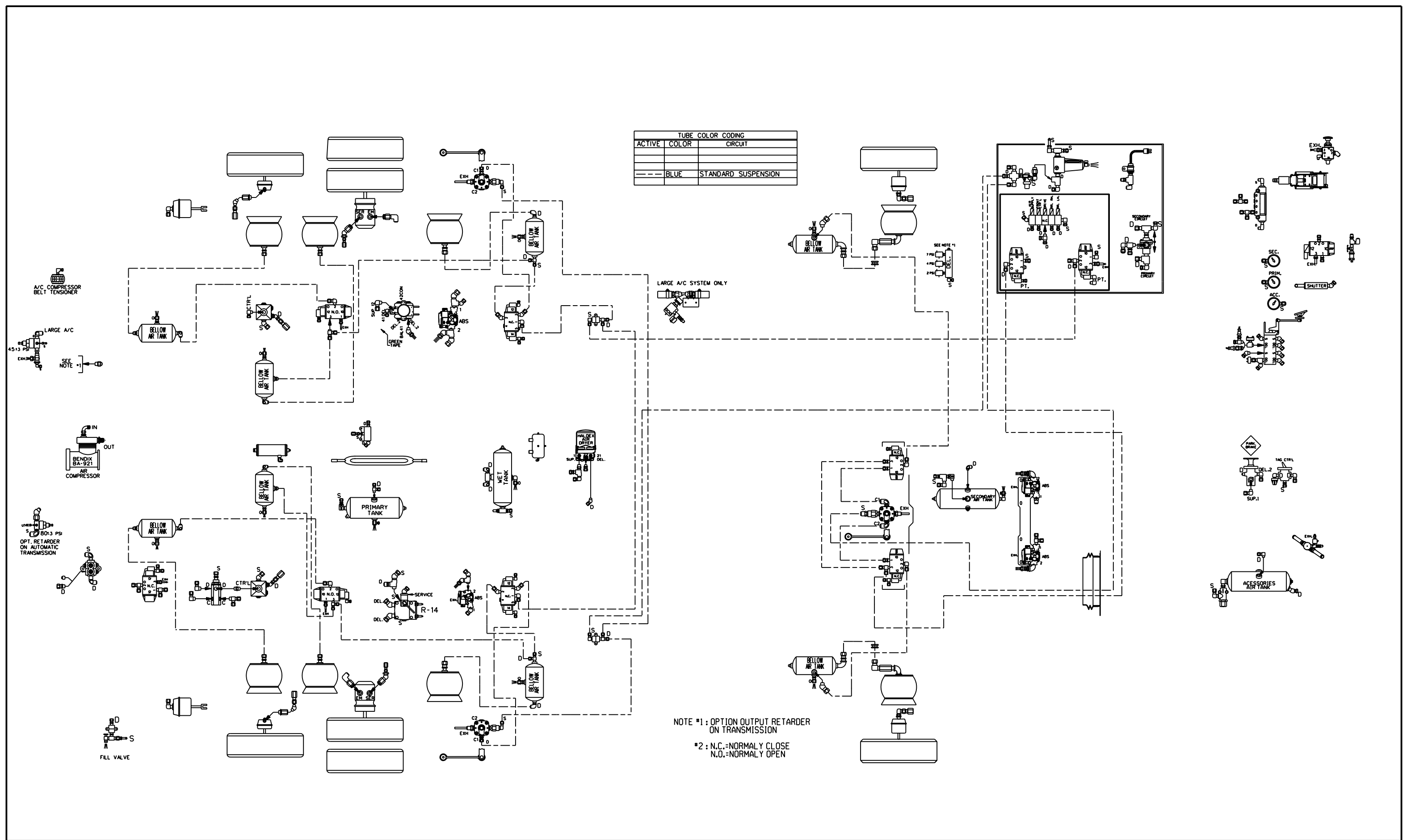

**PREVOST®**

DESCRIPTION: VIP, ENGINE 2007,  
 WITH INDEPENDENT SUSPENSION SYSTEM  
 -STANDARD SUSPENSION-

EFF. W/ VEH : #7-1017...  
 DATE: 2007/10  
 REV.: B

PAGE: D140355 P1.4

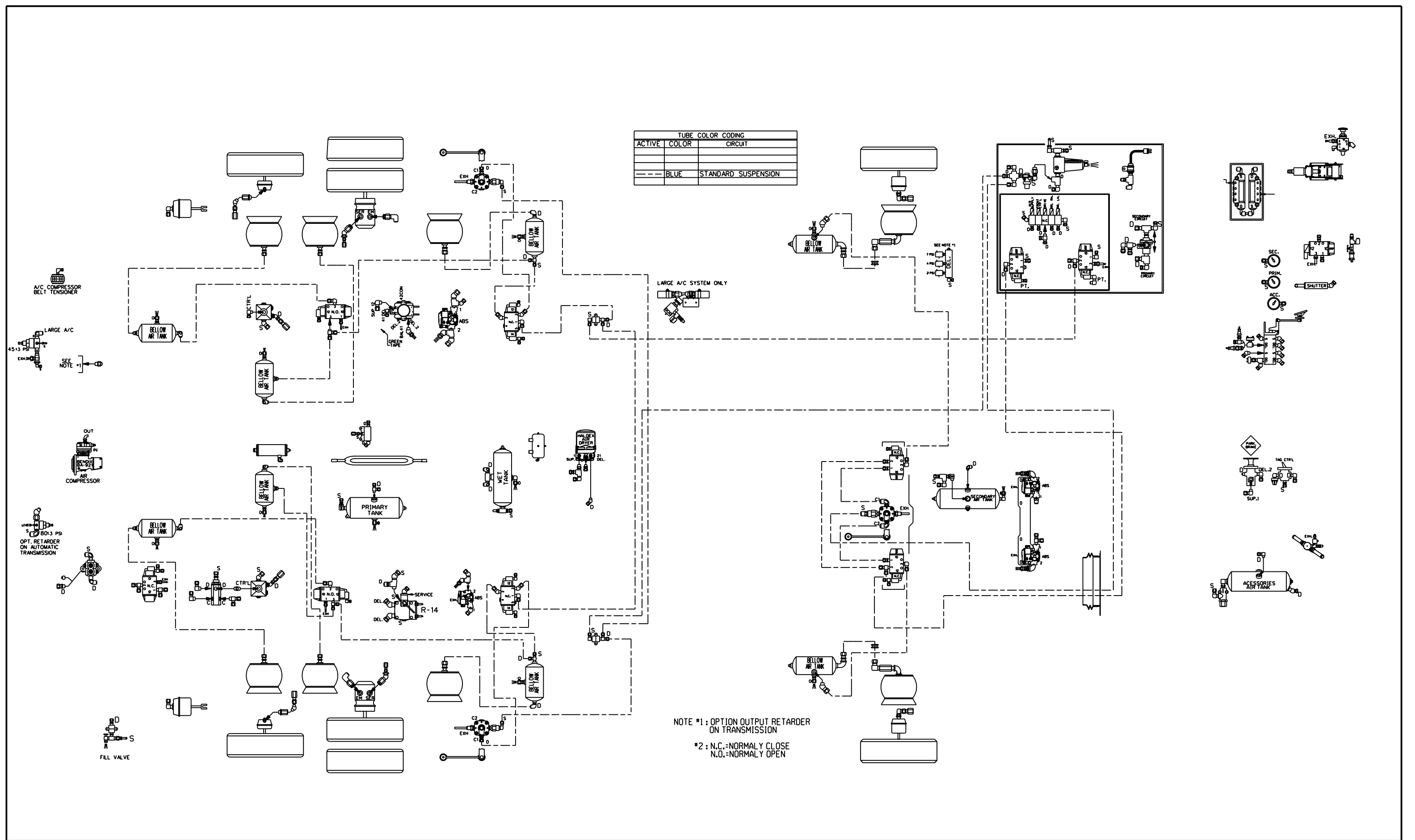

**PREVOST®**

DESCRIPTION:

VIP, ENGINE 2007,  
 WITH INDEPENDENT SUSPENSION SYSTEM  
 -STANDARD SUSPENSION-

EFF. W/ VEH : #7-1017...

PAGE:

D140355 P1.4

DATE:  
2009/05

REV.:  
C



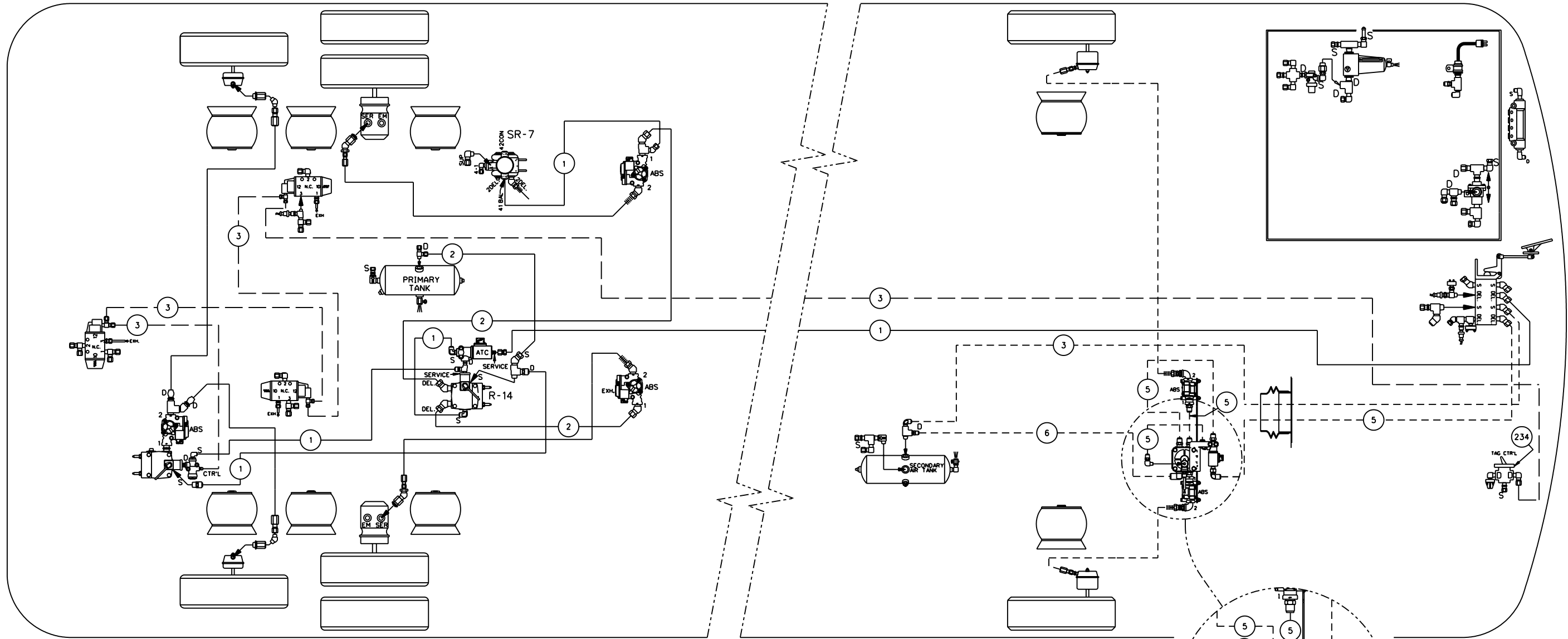

TUBE COLOR CODING		
ACTIVE	COLOR	CIRCUIT
—	GREEN	PRIMARY & SUPPLY
— — —	BLACK	ACCESSORIES
- - - -	RED	SECONDARY

BALLOON	PIPE
*1	3/8" O.D. GREEN
*2	5/8" O.D. GREEN
*3	1/4" O.D. BLACK
*4	3/8" O.D. RED
*5	1/2" O.D. RED
*6	5/8" O.D. RED

**PREVOST**®

DESCRIPTION:  
 VIP, ENGINE 2007,  
 WITH INDEPENDENT SUSPENSION SYSTEM  
 WITH ABS 6, ADVANCED OPTION

EFF. W/ VEH : #7-0942...  
 DATE: 2007/05  
 REV.: A

PAGE:  
 D140355 P2.1

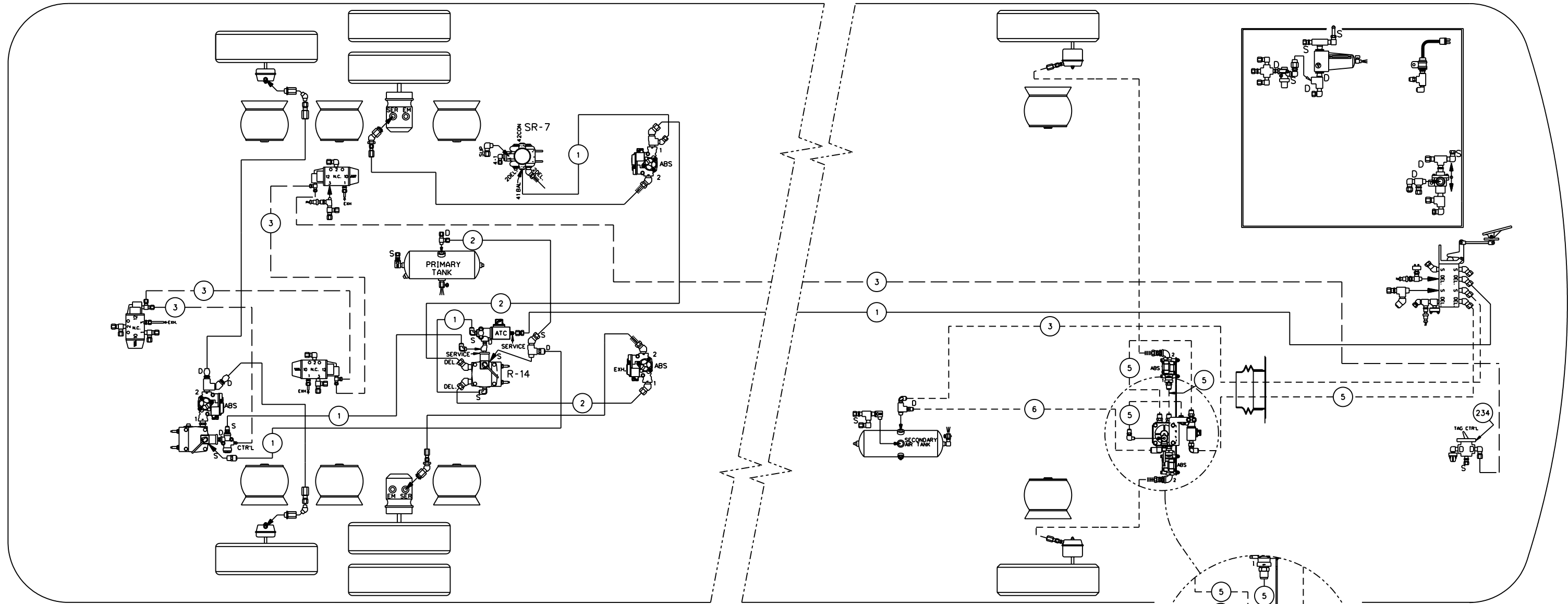

TUBE COLOR CODING		
ACTIVE	COLOR	CIRCUIT
—	GREEN	PRIMARY & SUPPLY
—	BLACK	ACCESSORIES
---	RED	SECONDARY

BALLOON	PIPE
*1	3/8" O.D. GREEN
*2	5/8" O.D. GREEN
*3	1/4" O.D. BLACK
*4	3/8" O.D. RED
*5	1/2" O.D. RED
*6	5/8" O.D. RED

**PREVOST**®

DESCRIPTION:

VIP, ENGINE 2007,  
WITH INDEPENDENT SUSPENSION SYSTEM  
WITH AIR BRAKE SYSTEM ESP OPTION

EFF. W/ VEH : #7-0942...

PAGE:

D140355 P2.1

DATE:  
2009/05

REV.:  
C

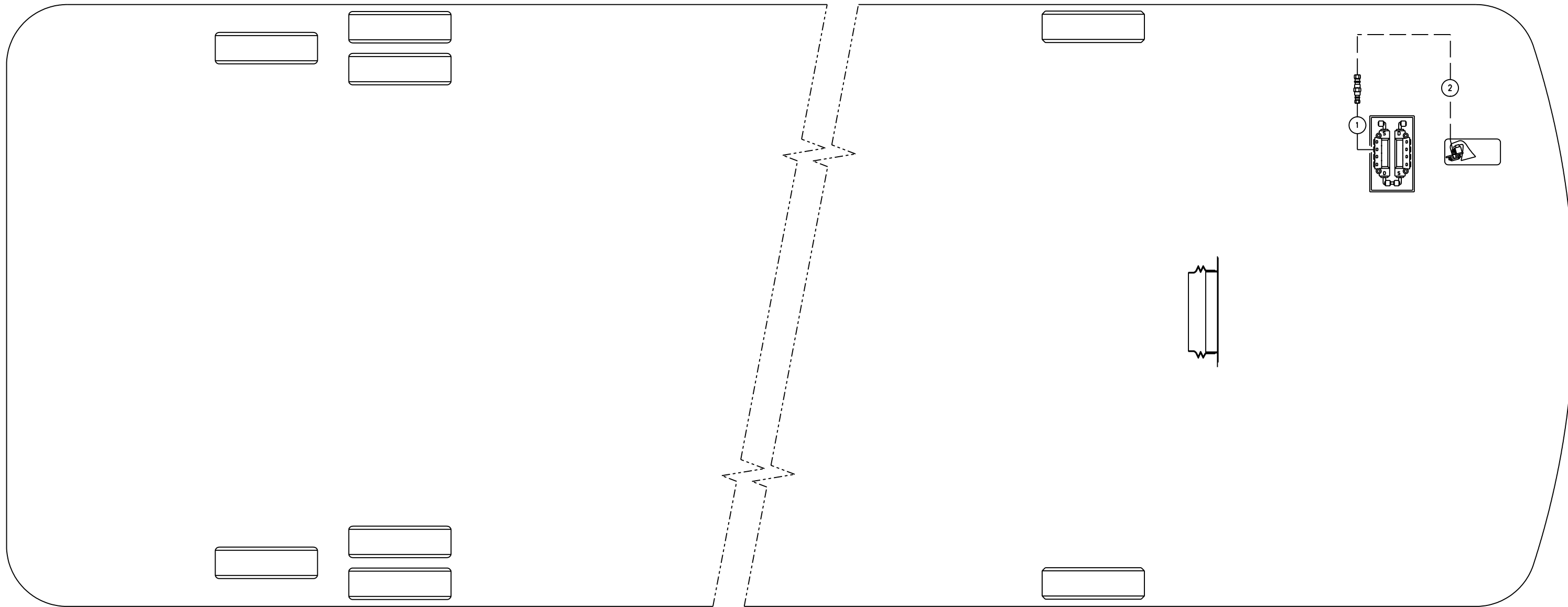

TUBE COLOR CODING	
ACTIVE COLOR	CIRCUIT
— BLACK	ACCESSORIES

BALLOON	PIPE
*1	1/4" O.D. BLACK
*2	1/8" O.D. BLACK

**PREVOST®**

DESCRIPTION:

VIP, ENGINE 2007,  
WITH INDEPENDENT SUSPENSION SYSTEM  
SPECIAL WITH AIR HORN ADDED

EFF. W/ VEH :

#9-1386

PAGE:

D140355 SP2.1

DATE:  
2009/01

REV.:  
C

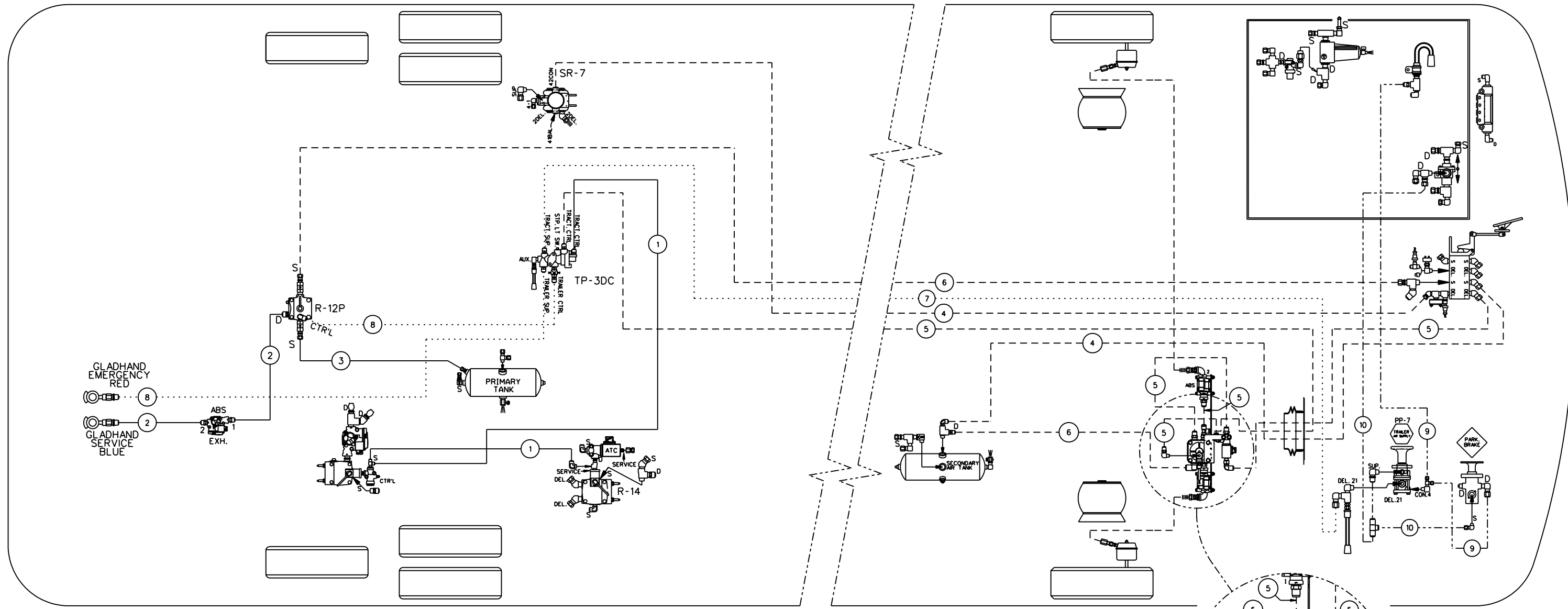

BALLOON	PIPE
*1	3/8" O.D. GREEN
*2	1/2" O.D. GREEN
*3	5/8" O.D. GREEN
*4	3/8" O.D. RED
*5	1/2" O.D. RED
*6	5/8" O.D. RED
*7	3/8" O.D. BROWN
*8	1/2" O.D. BROWN
*9	1/4" O.D. YELLOW
*10	3/8" O.D. YELLOW

TUBE COLOR CODING		
ACTIVE	COLOR	CIRCUIT
---	RED	SECONDARY
---	GREEN	PRIMARY & SUPPLY
---	YELLOW	PARKING BRAKE
---	BLACK	ACCESSORIES
---	BROWN	TRAILER

**PREVOST**®

DESCRIPTION: VIP, ENGINE 2007,  
WITH INDEPENDENT SUSPENSION SYSTEM  
WITH AIR BRAKES TRAILER HITCH &  
ESP OPTIONS

EFF. W/ VEH : #7-0944...  
DATE: 2008/03 REV.: C

PAGE: D140355 P3.1

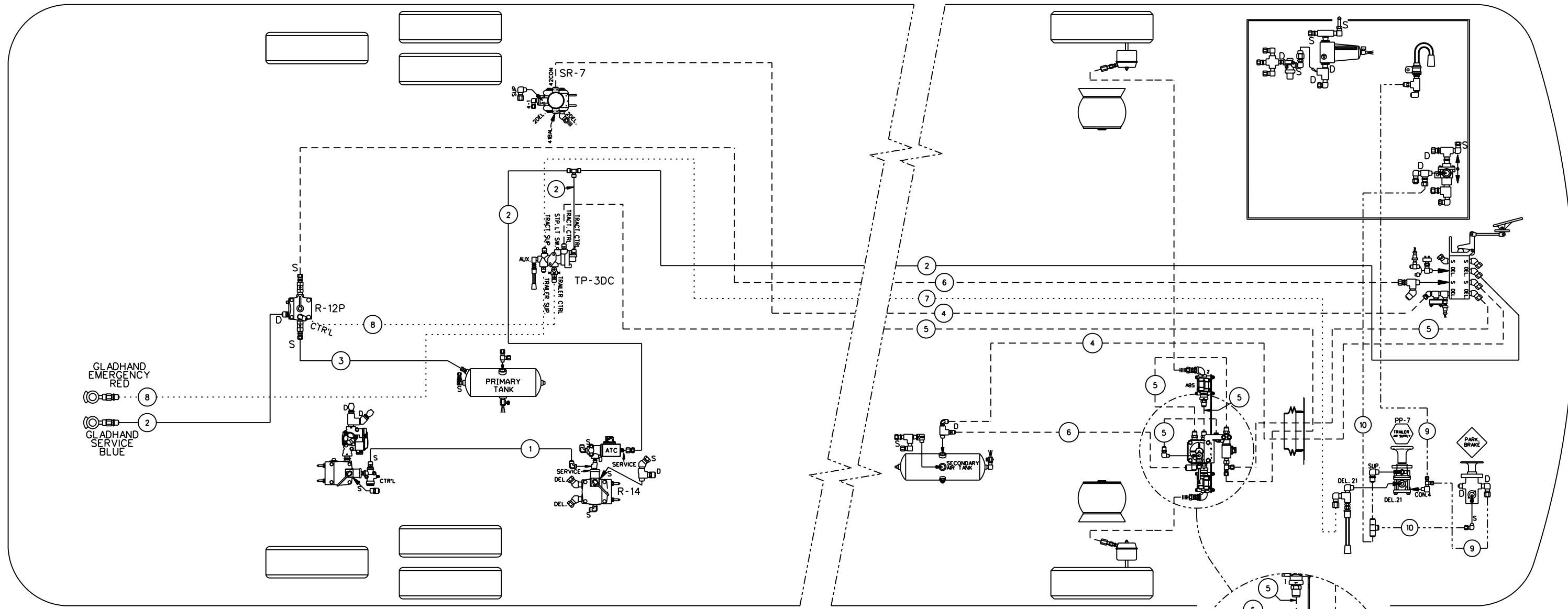

BALLOON	PIPE
*1	3/8" O.D. GREEN
*2	1/2" O.D. GREEN
*3	5/8" O.D. GREEN
*4	3/8" O.D. RED
*5	1/2" O.D. RED
*6	5/8" O.D. RED
*7	3/8" O.D. BROWN
*8	1/2" O.D. BROWN
*9	1/4" O.D. YELLOW
*10	3/8" O.D. YELLOW

TUBE COLOR CODING		
ACTIVE	COLOR	CIRCUIT
---	RED	SECONDARY
---	GREEN	PRIMARY & SUPPLY
---	YELLOW	PARKING BRAKE
---	BLACK	ACCESSORIES
---	BROWN	TRAILER

**PREVOST**®

DESCRIPTION: VIP, ENGINE 2007,  
WITH INDEPENDENT SUSPENSION SYSTEM  
WITH AIR BRAKES TRAILER HITCH &  
ESP OPTIONS

EFF. W/ VEH : #9-1499...

PAGE: D140355 P3.1

DATE: 2008/12 REV.: D

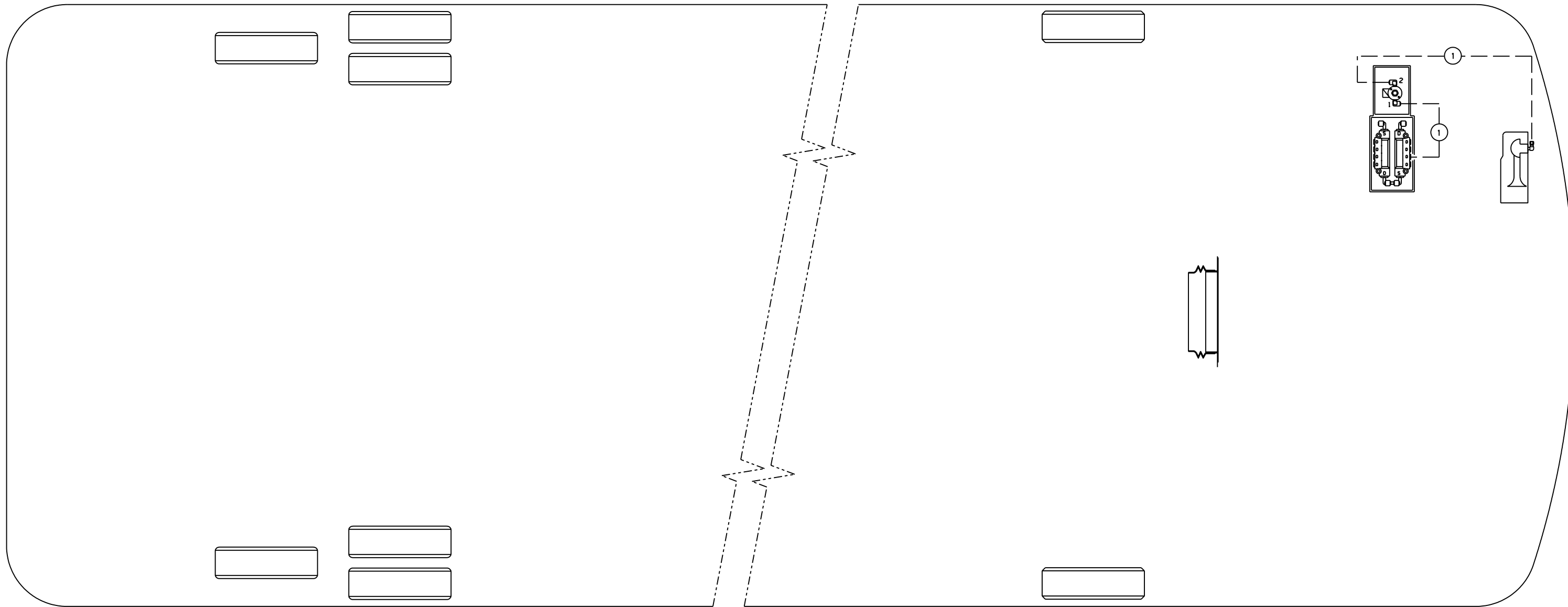

TUBE COLOR CODING	
ACTIVE	COLOR
—	BLACK
—	ACCESSORIES

BALLOON	PIPE
*1	1/4" O.D. BLACK

**PREVOST®**

DESCRIPTION:

VIP, ENGINE 2007,  
WITH INDEPENDENT SUSPENSION SYSTEM  
SPECIAL WITH AIR HORN BENDIX BOX ADDED

EFF. W/ VEH :

#A-1607

DATE:  
2009/11

REV.:  
A

PAGE:

D140355 SP3.1

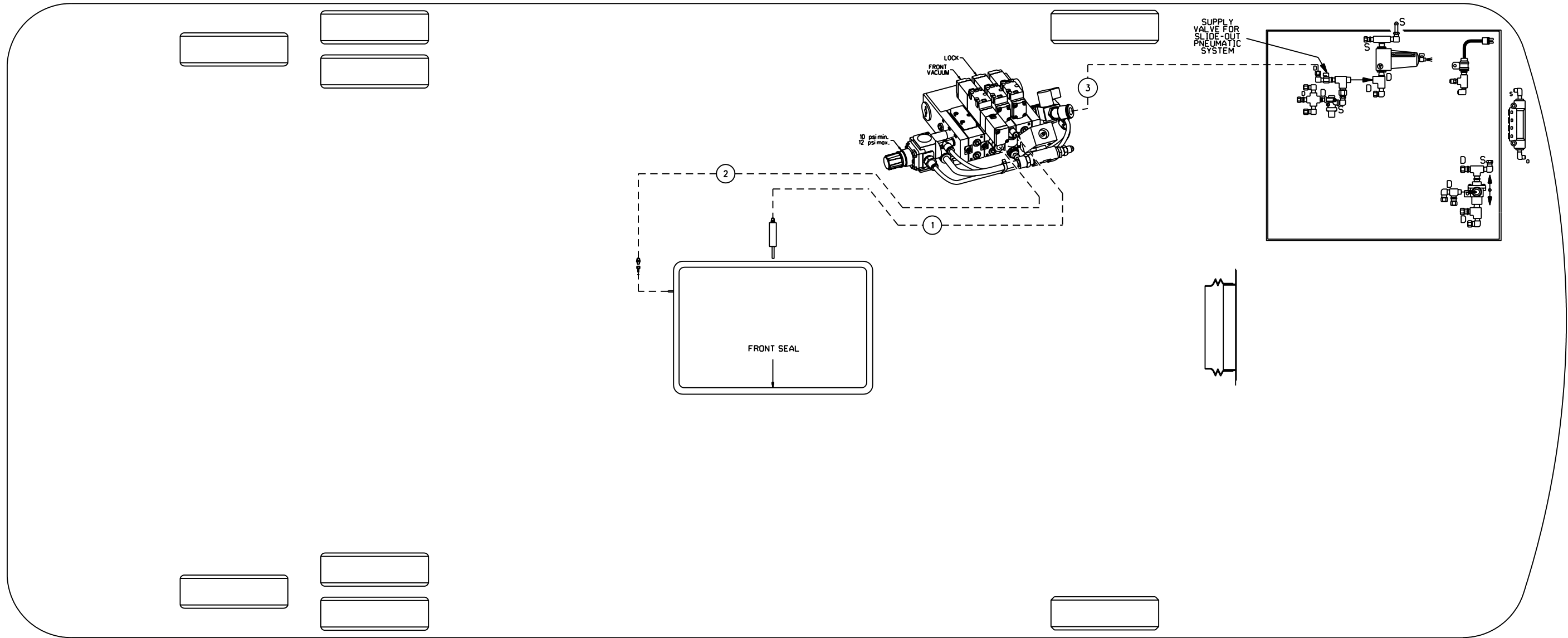

TUBE COLOR CODING	
ACTIVE COLOR	CIRCUIT
—	BLACK ACCESSORIES

BALLOON	PIPE
*1	1/8" O.D. BLACK
*2	3/8" O.D. BLACK
*3	1/2" O.D. BLACK

**PREVOST®**

DESCRIPTION:

VIP, ENGINE 2007,  
WITH INDEPENDENT SUSPENSION SYSTEM  
FRONT SINGLE SLIDE-OUT OPTION, LEFT SIDE

EFF. W/ VEH : #7-0942...

PAGE:

DATE:  
2007/05

REV.:  
A

D140355 P4.1

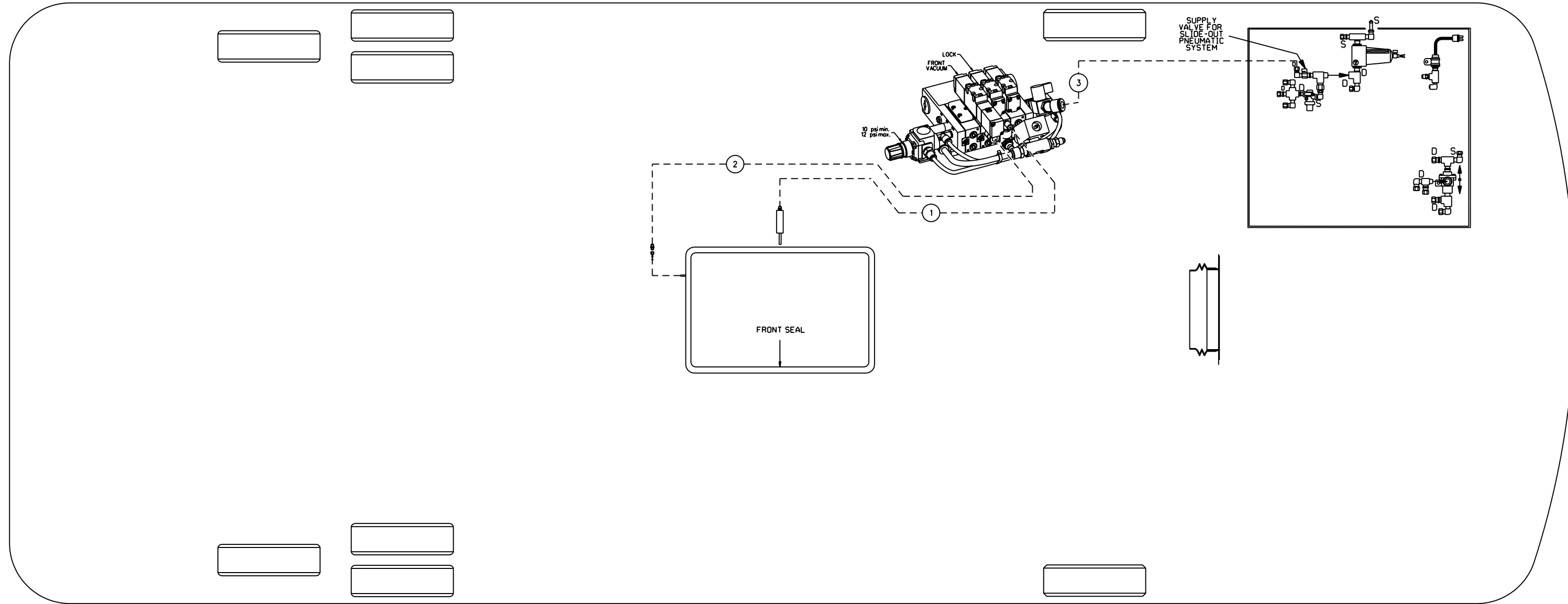

TUBE COLOR CODING		
ACTIVE	COLOR	CIRCUIT
—	BLACK	ACCESSORIES

BALLOON	PIPE
*1	1/8" O.D. BLACK
*2	3/8" O.D. BLACK
*3	1/2" O.D. BLACK

**PREVOST®**

DESCRIPTION:

VIP, ENGINE 2007,  
WITH INDEPENDENT SUSPENSION SYSTEM  
FRONT SINGLE SLIDE-OUT OPTION, LEFT SIDE

EFF. W/ VEH : #7-0942...

DATE: 2009/05

REV.: B

PAGE:

D140355 P4.1



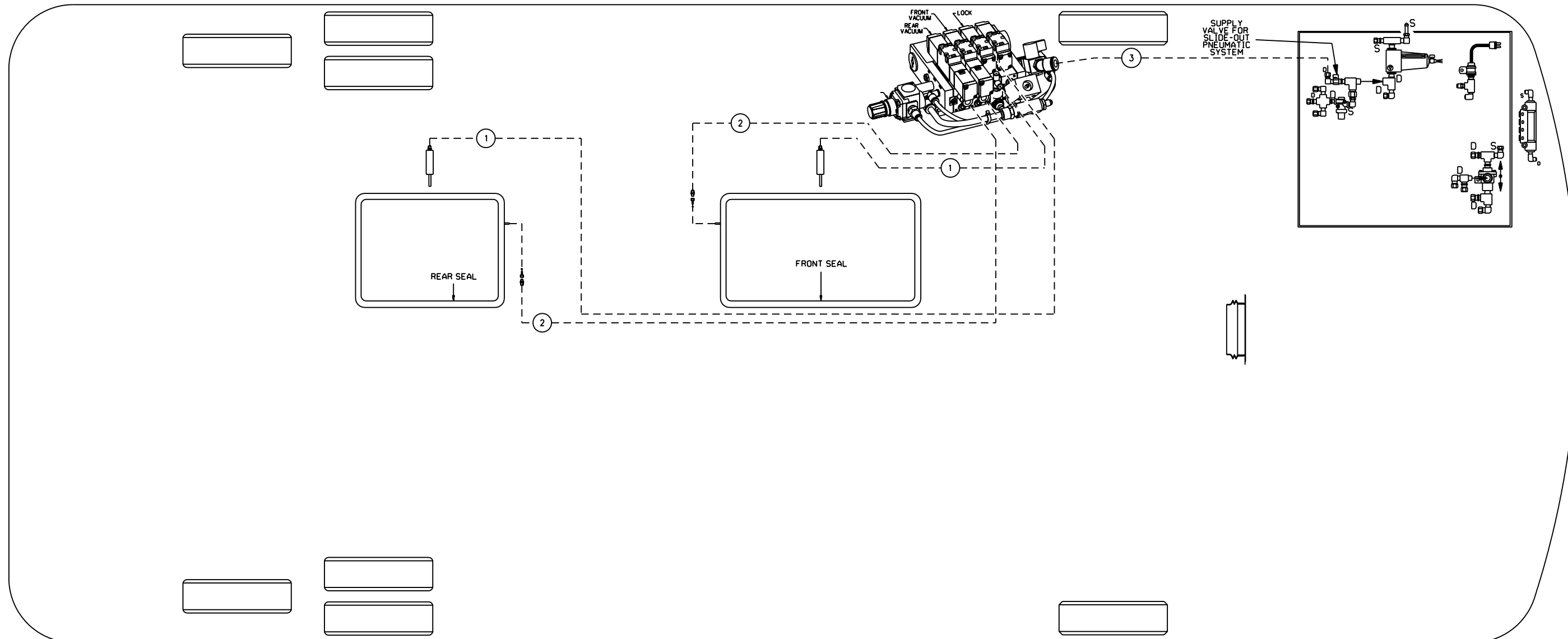

TUBE COLOR CODING	
ACTIVE	COLOR
---	BLACK
CIRCUIT	ACCESSORIES

BALLOON	PIPE
*1	1/8" O.D. BLACK
*2	3/8" O.D. BLACK
*3	1/2" O.D. BLACK

**PREVOST®**

DESCRIPTION:

VIP, ENGINE 2007,  
 WITH INDEPENDENT SUSPENSION SYSTEM  
 DOUBLE SLIDE-OUT OPTION LEFT SIDE, FRONT AND REAR  
 SMALL OR LARGE REAR CAISSON POSSIBILITY OPTION

EFF. W/ VEH : #7-0942...

DATE: 2007/05

REV.: A

PAGE:

D140355 P5.1

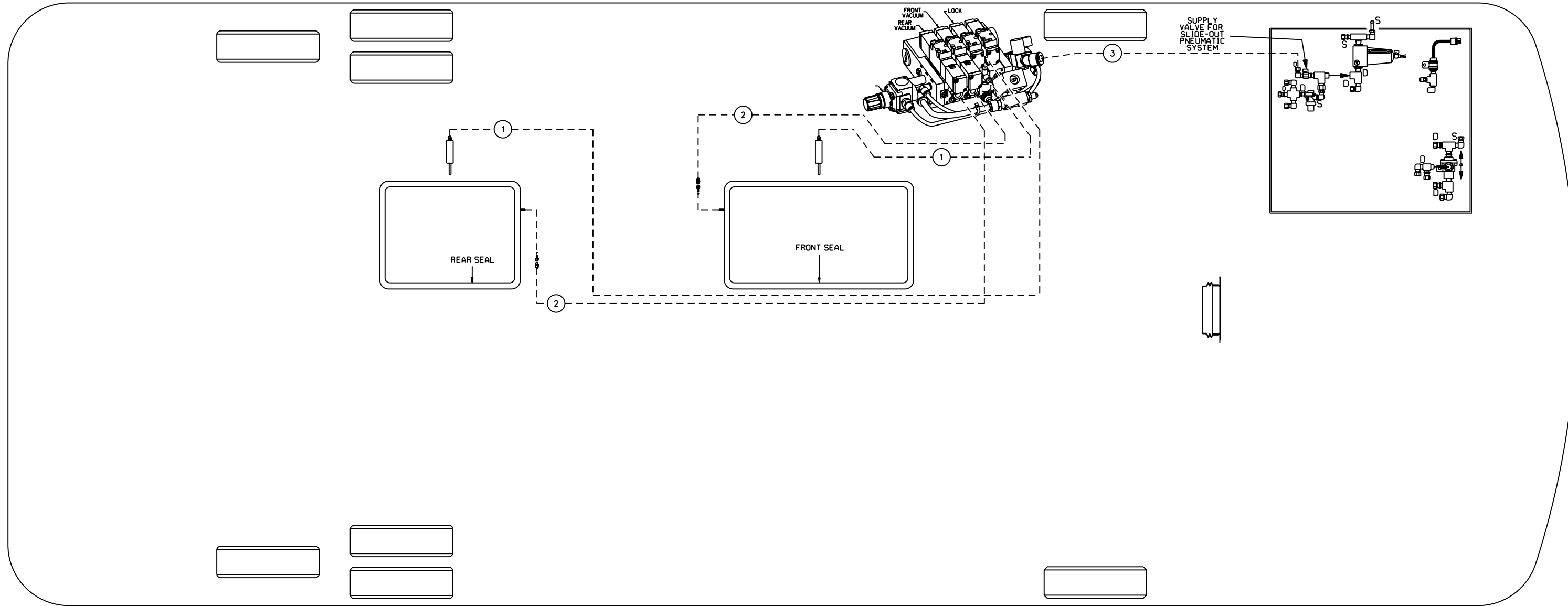

TUBE COLOR CODING	
ACTIVE COLOR	CIRCUIT
— BLACK	ACCESSORIES

BALLOON	PIPE
*1	1/8" O.D. BLACK
*2	3/8" O.D. BLACK
*3	1/2" O.D. BLACK

**PREVOST®**

DESCRIPTION: VIP, ENGINE 2007,  
WITH INDEPENDENT SUSPENSION SYSTEM  
DOUBLE SLIDE-OUT OPTION LEFT SIDE, FRONT AND REAR  
SMALL OR LARGE REAR CAISSON POSSIBILITY OPTION

EFF. W/ VEH : #7-0942...  
DATE: 2009/05  
REV.: B

PAGE:  
D140355 P5.1

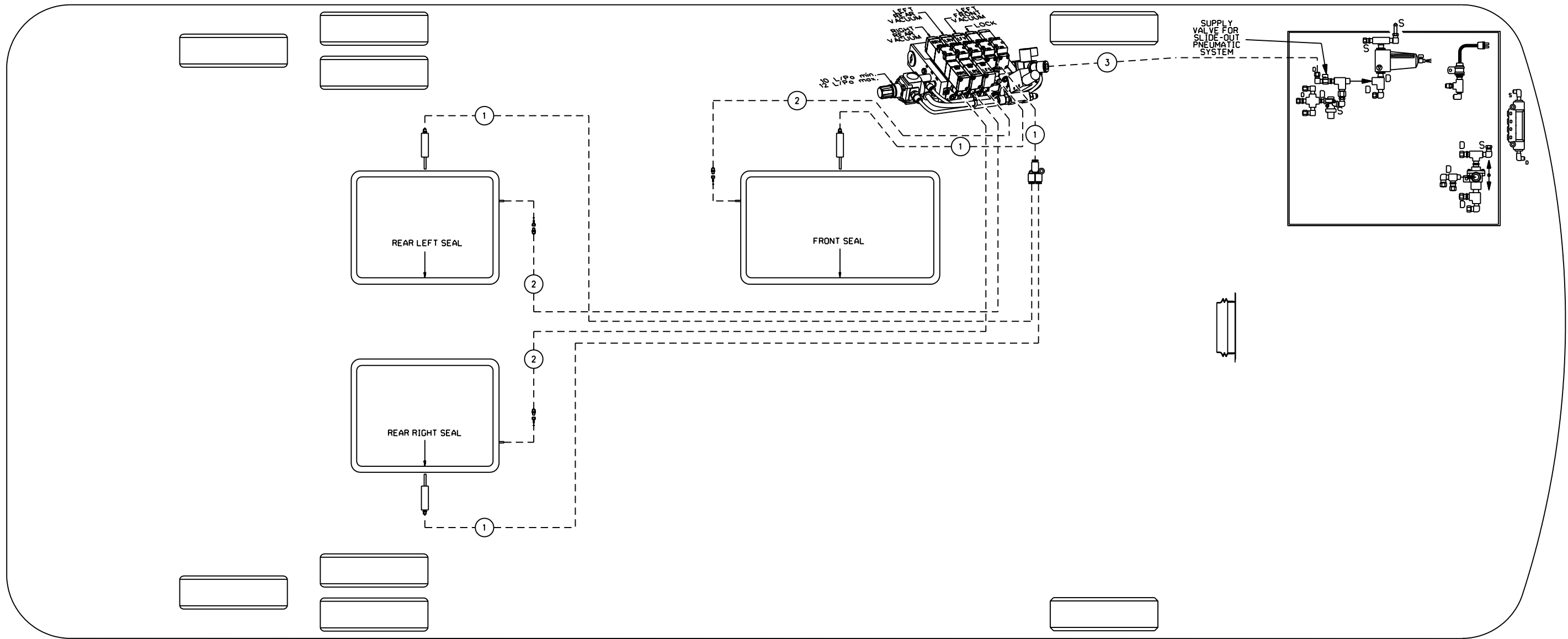

TUBE COLOR CODING	
ACTIVE COLOR	CIRCUIT
— BLACK	ACCESSORIES

BALLOON	PIPE
*1	1/8" O.D. BLACK
*2	3/8" O.D. BLACK
*3	1/2" O.D. BLACK

**PREVOST®**

DESCRIPTION: VIP, ENGINE 2007 WITH INDEPENDENT SUSPENSION SYSTEM  
 TRIPPLICATE SLIDE-OUT OPTION LEFT SIDE, FRONT AND REAR  
 RIGHT SIDE REAR ONLY  
 SMALL OR LARGE REAR CAISSON POSIBILITY OPTION

EFF. W/ VEH : #8-1071...  
 DATE: 2007/10  
 REV.: B

PAGE:  
 D140355 P6.1

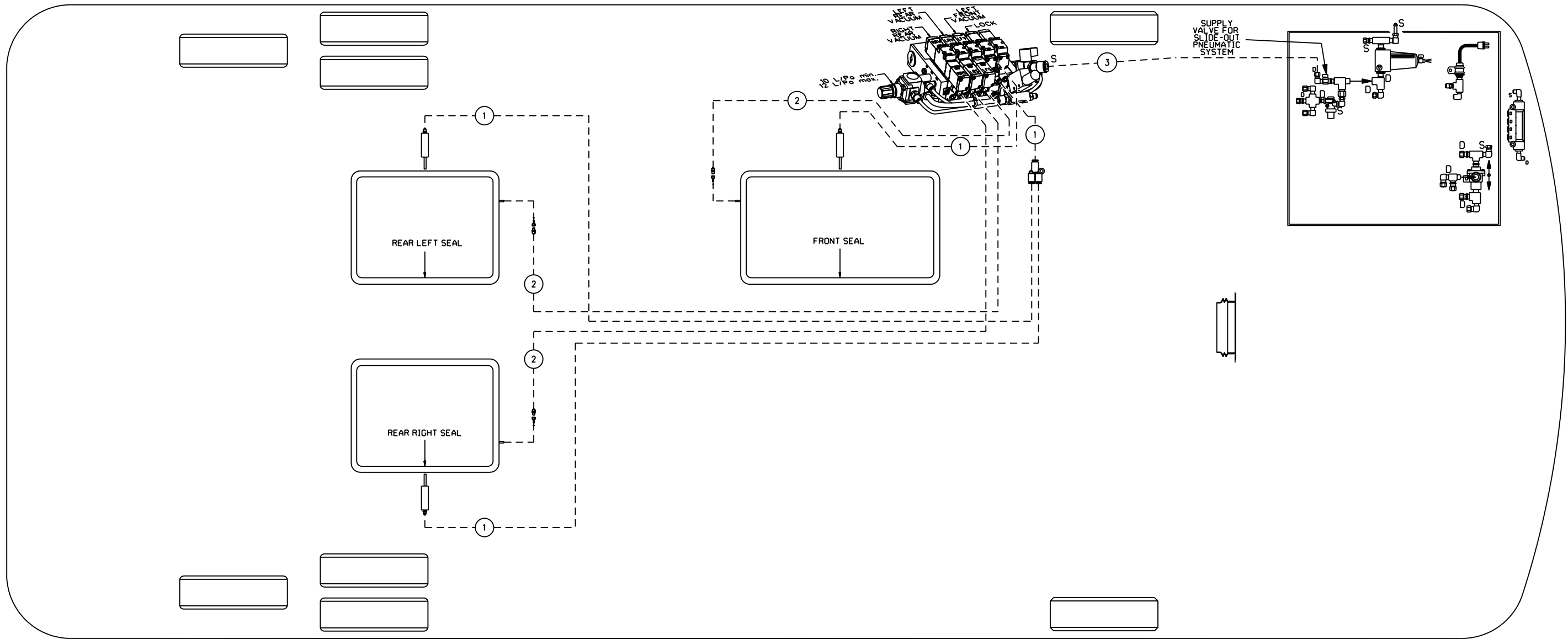

TUBE COLOR CODING	
ACTIVE COLOR	CIRCUIT
— BLACK	ACCESSORIES

BALLOON	PIPE
*1	1/8" O.D. BLACK
*2	3/8" O.D. BLACK
*3	1/2" O.D. BLACK

**PREVOST®**

DESCRIPTION: VIP, ENGINE 2007 WITH INDEPENDENT SUSPENSION SYSTEM  
 TRIPPLICATE SLIDE-OUT OPTION LEFT SIDE, FRONT AND REAR  
 RIGHT SIDE REAR ONLY  
 SMALL OR LARGE REAR CAISSON POSIBILITY OPTION

EFF. W/ VEH : #8-1415...  
 DATE: 2008/03  
 REV.: C

PAGE:  
 D140355 P6.1

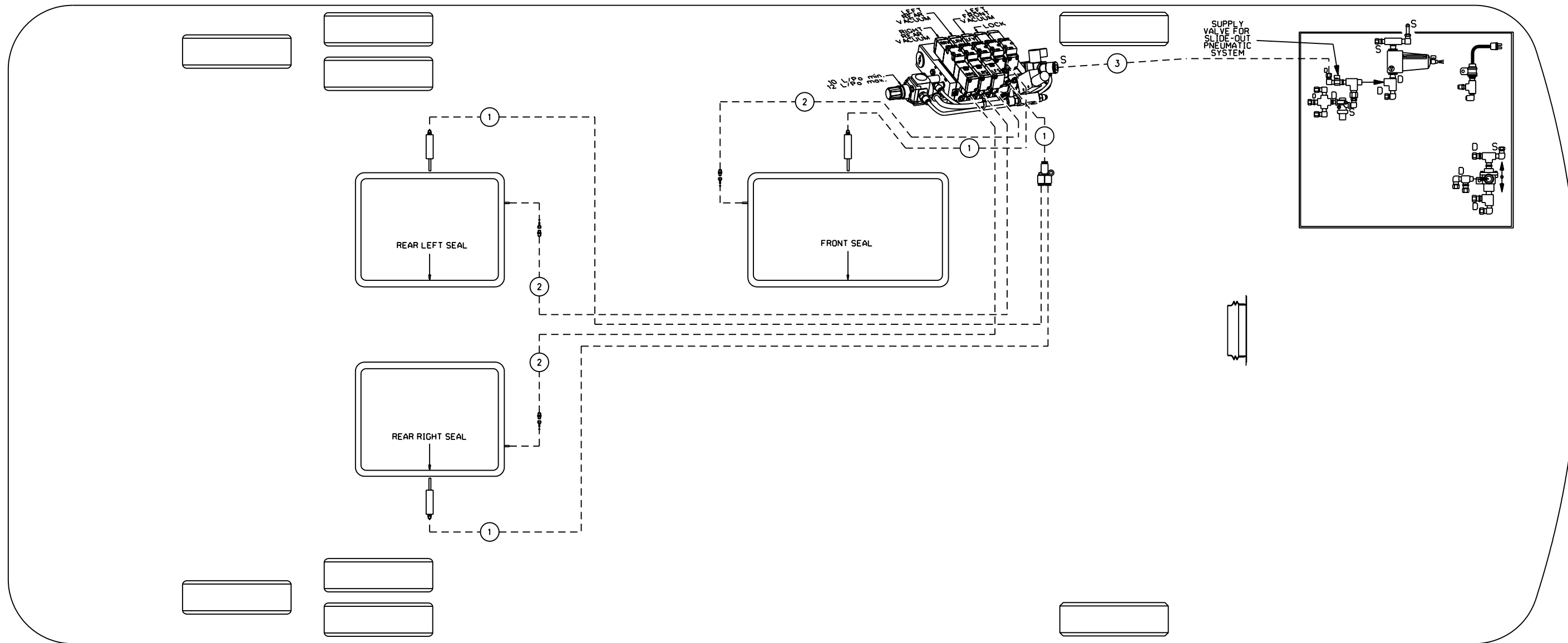

TUBE COLOR CODING	
ACTIVE COLOR	CIRCUIT
— BLACK	ACCESSORIES

BALLOON	PIPE
*1	1/8" O.D. BLACK
*2	3/8" O.D. BLACK
*3	1/2" O.D. BLACK

**PREVOST®**

DESCRIPTION: VIP, ENGINE 2007 WITH INDEPENDENT SUSPENSION SYSTEM  
 TRIPPLICATE SLIDE-OUT OPTION LEFT SIDE, FRONT AND REAR  
 RIGHT SIDE REAR ONLY  
 SMALL OR LARGE REAR CAISSON POSIBILITY OPTION

EFF. W/ VEH : #8-1415...  
 DATE: 2009/05  
 REV.: D

PAGE:  
 D140355 P6.1

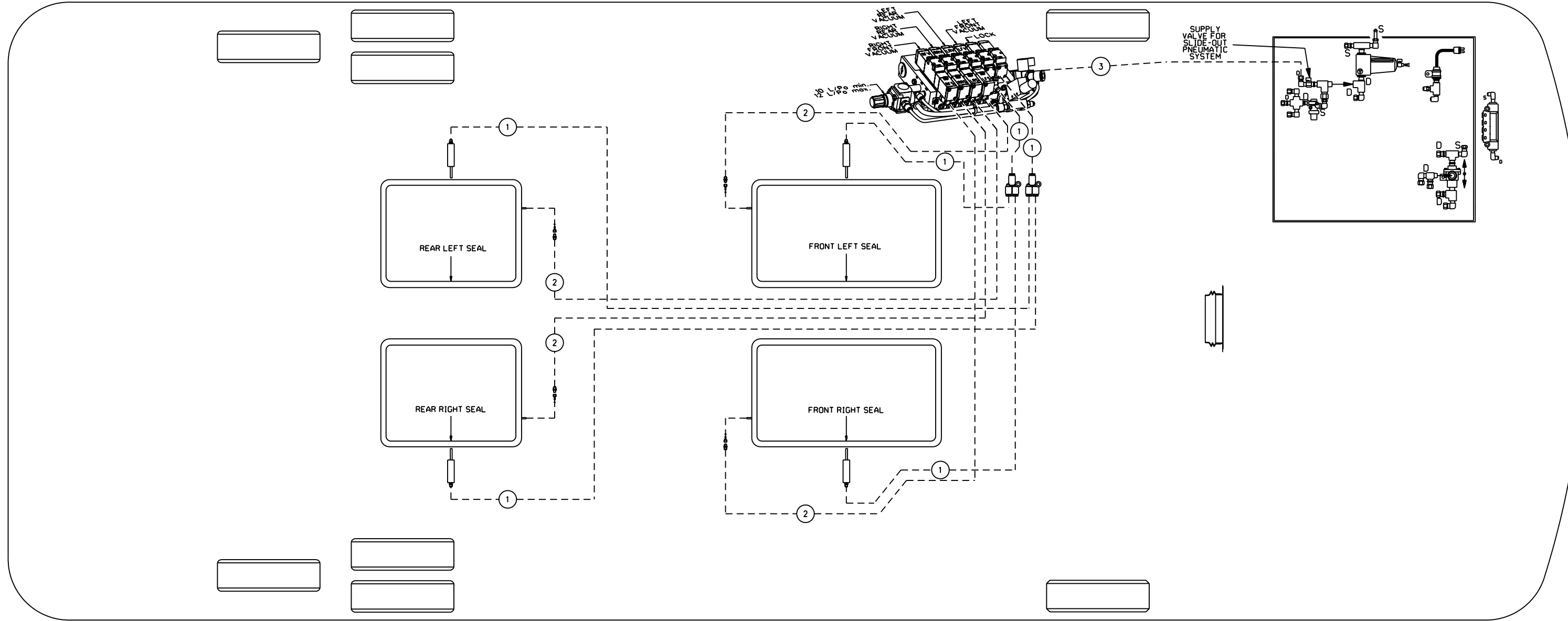

TUBE COLOR CODING	
ACTIVE	COLOR
---	BLACK
---	ACCESSORIES

BALLOON	PIPE
*1	1/8" O.D. BLACK
*2	3/8" O.D. BLACK
*3	1/2" O.D. BLACK

**PREVOST®**

DESCRIPTION:  
 VIP  
 FOUR SLIDE-OUT OPTION  
 SMALL OR LARGE REAR AND RIGHT FRONT CAISSON POSIBILITY  
 OPTIONS

EFF. W/ VEH : #8-1430...  
 DATE: 2008/01  
 REV.: A

PAGE:  
 D140355 P7.1

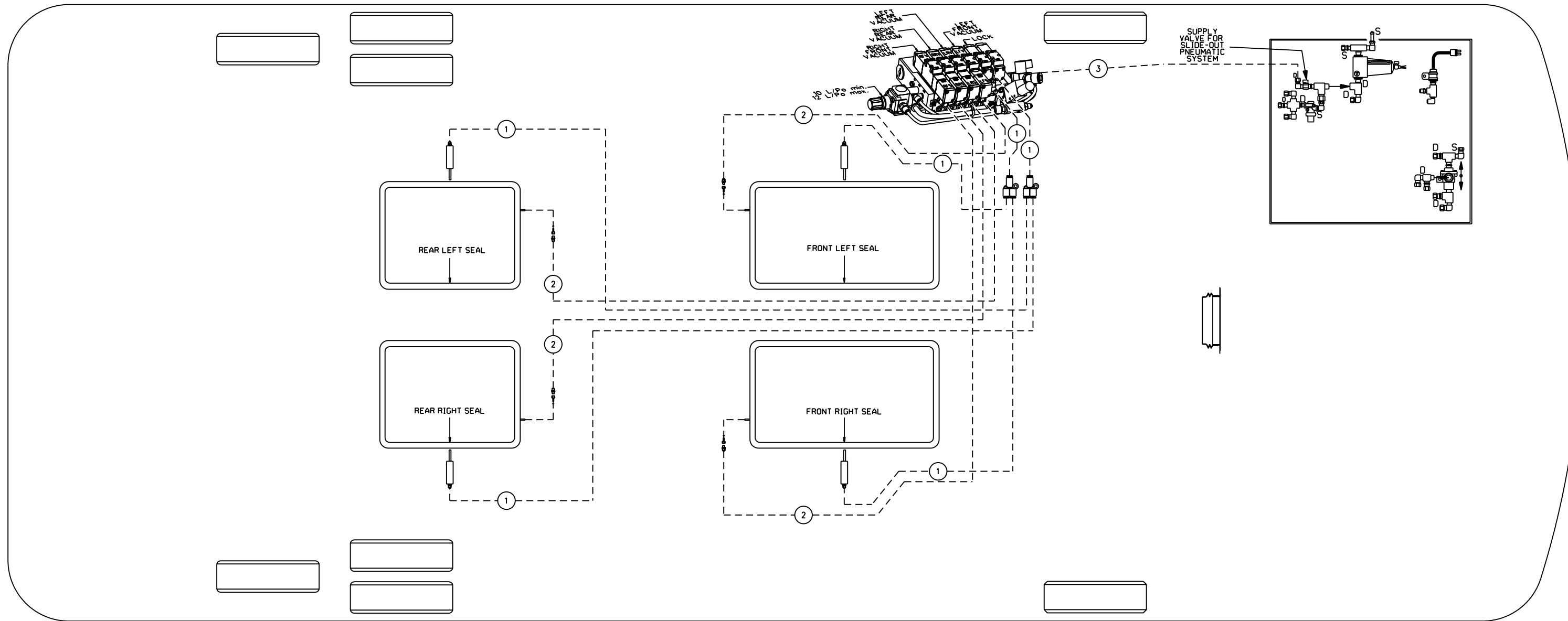

TUBE COLOR CODING	
ACTIVE COLOR	CIRCUIT
— BLACK	ACCESSORIES

BALLOON	PIPE
*1	1/8" O.D. BLACK
*2	3/8" O.D. BLACK
*3	1/2" O.D. BLACK

**PREVOST®**

DESCRIPTION:  
 VIP  
 FOUR SLIDE-OUT OPTION  
 SMALL OR LARGE REAR AND RIGHT FRONT CAISSON POSIBILITY  
 OPTIONS

EFF. W/ VEH : #8-1430...  
 DATE: 2009/05  
 REV.: B

PAGE:  
 D140355 P7.1

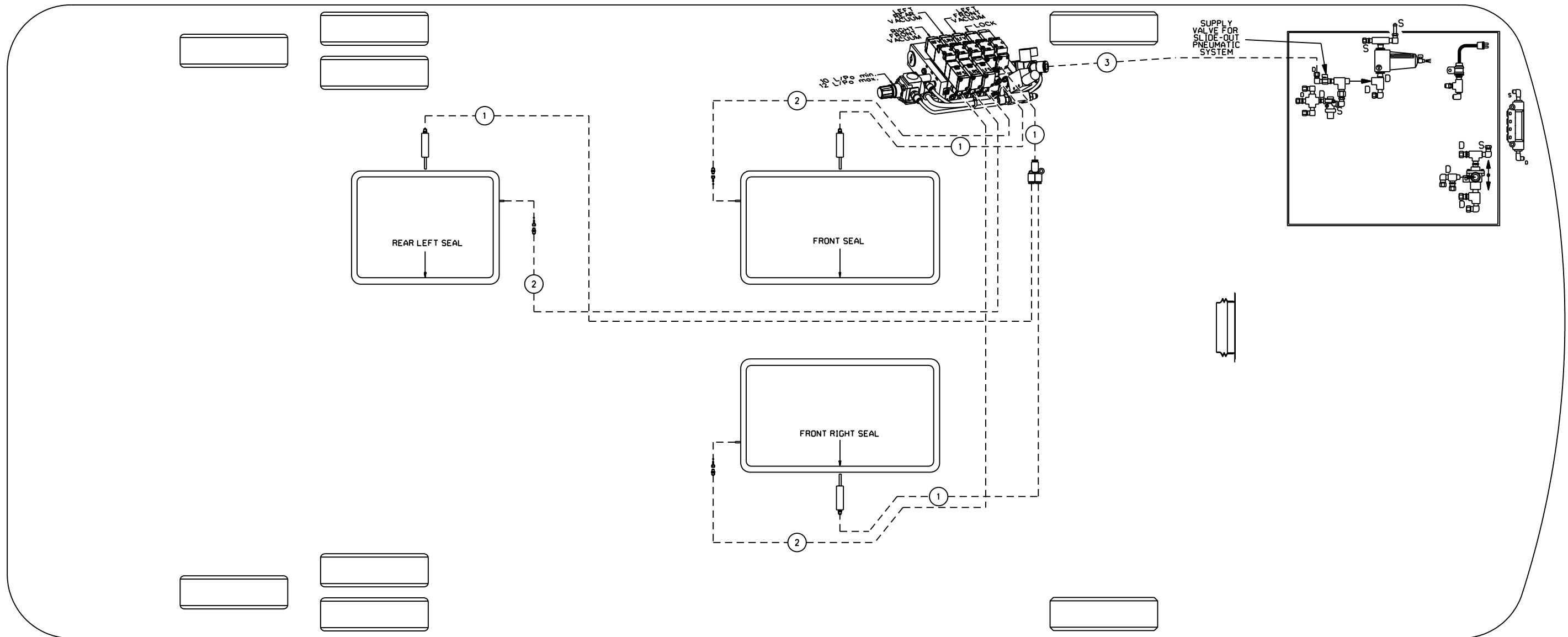

TUBE COLOR CODING	
ACTIVE COLOR	CIRCUIT
— BLACK	ACCESSORIES

BALLOON	PIPE
*1	1/8" O.D. BLACK
*2	3/8" O.D. BLACK
*3	1/2" O.D. BLACK

**PREVOST®**

DESCRIPTION: VIP, ENGINE 2007 WITH INDEPENDENT SUSPENSION SYSTEM  
 TRIPPLICATE SLIDE-OUT OPTION LEFT SIDE FRONT AND REAR &  
 RIGHT SIDE FRONT ONLY. SMALL OR LARGE REAR AND FRONT  
 RIGHT CAISSON POSIBILITY OPTION

EFF. W/ VEH : #8-1415...  
 DATE: 2008/03  
 REV.: A

PAGE:  
 D140355 P8.1



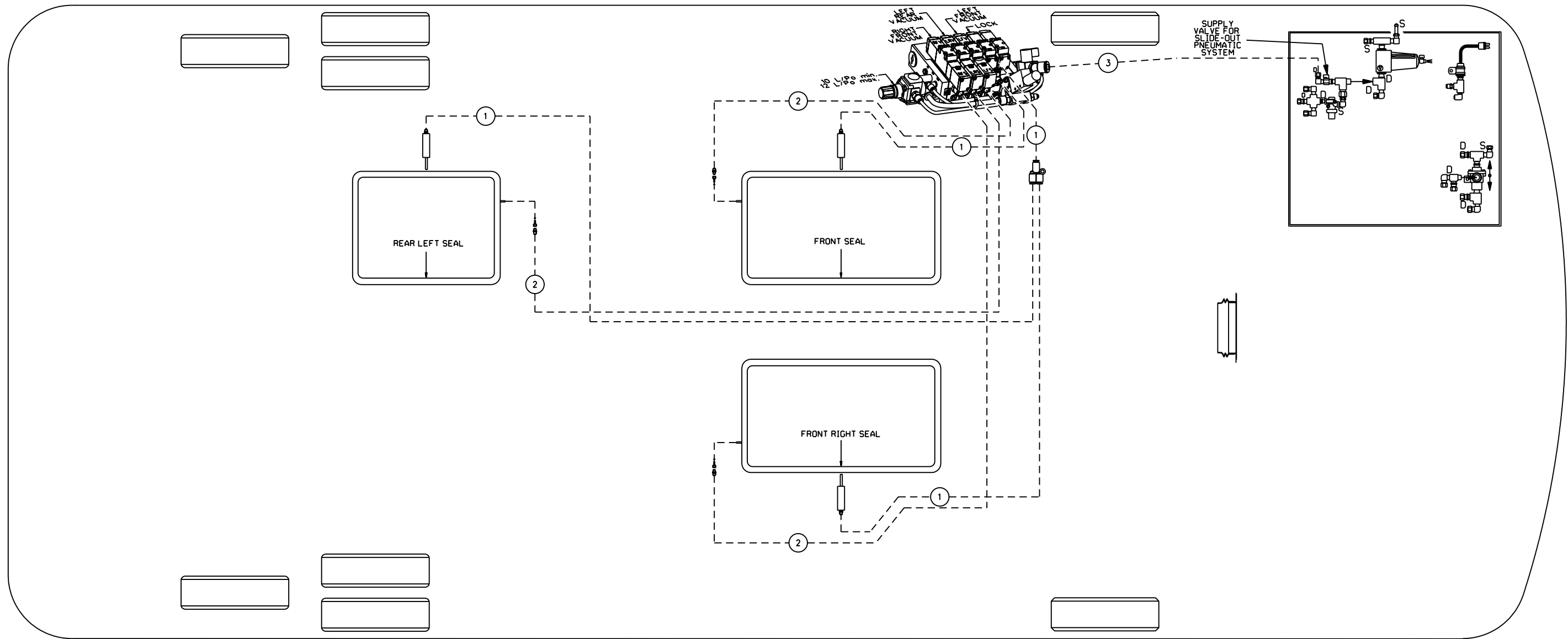

TUBE COLOR CODING	
ACTIVE COLOR	CIRCUIT
— BLACK	ACCESSORIES

BALLOON	PIPE
*1	1/8" O.D. BLACK
*2	3/8" O.D. BLACK
*3	1/2" O.D. BLACK

**PREVOST®**

DESCRIPTION: VIP, ENGINE 2007 WITH INDEPENDENT SUSPENSION SYSTEM  
 TRIPPLICATE SLIDE-OUT OPTION LEFT SIDE FRONT AND REAR &  
 RIGHT SIDE FRONT ONLY. SMALL OR LARGE REAR AND FRONT  
 RIGHT CAISSON POSIBILITY OPTION

EFF. W/ VEH : #8-1415...  
 DATE: 2009/05  
 REV.: B

PAGE:  
 D140355 P8.1

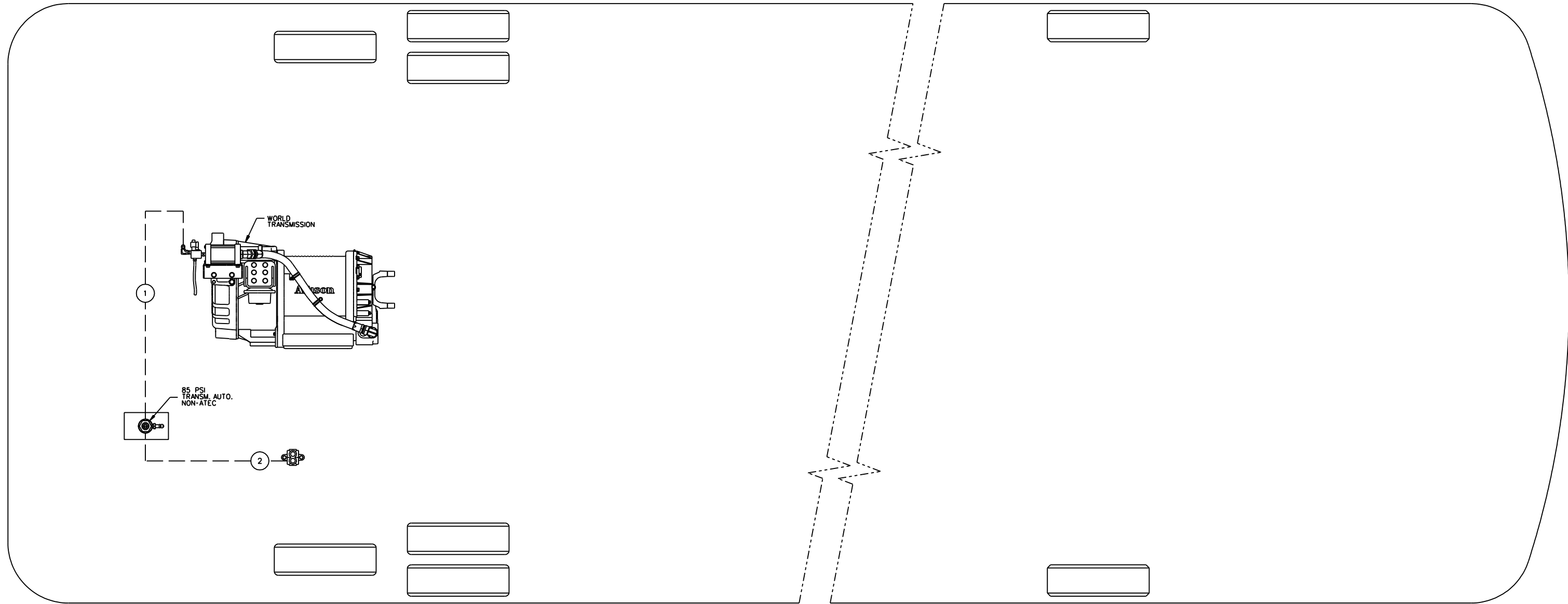

TUBE COLOR CODING	
ACTIVE COLOR	CIRCUIT
---	BLACK ACCESSORIES
---	GREEN PRIMARY & SUPPLY

BALLOON	PIPE
#1	HOSE ASS'Y
#2	1/4" O.D. BLACK
#3	3/8" O.D. GREEN

**PREVOST®**

DESCRIPTION:

VIP, ENGINE 2007,  
WITH INDEPENDENT SUSPENSION SYSTEM &  
OUTPUT RETARDER ON WORLD TRANSMISSION

EFF. W/ VEH :

#A-1653

PAGE:

D140355 P9.1

DATE:

2010/01

REV.:

A