

# Pneumatic diagram

## *PNEUMATIC DIAGRAMS X3-45 COACHES WITH FRONT BEAM AXLE*

NO:	<b>D140331 P0</b>	REVISION :	<b>P</b>
-----	-------------------	------------	----------

EFF. OC#	2004015	PRIOR TO OC#	<b>2007131 &amp; 2009088</b>
EFF. VEH#	#7-8938	PRIOR TO VEH#	<b>#A-9953</b>

DR.	Y. Laine	date	2010/06/22
CHK	Marc-Jose Handfield	appr	Marc-José Handfield

REV.	DATE	DESCRIPTION	PAGE	BY	CHK.	APPR.
A	2006-01-11 2006-03-31	#7-8904 X3-45 PRELIMINARY VEHICLE #4 PRODUCTION VEHICLE (PWT) #7-8938...				
B	2006-08-23	#D140331P1.0 REVISION : B	P1.0	Rob.	M.J.H	M.J.H
	2006-08-23	#D140331P1.1 REVISION : B	P1.1	Rob.	M.J.H	M.J.H
	2006-08-23	#D140331P1.2 REVISION : B	P1.2	Rob.	M.J.H	M.J.H
	2006-08-23	#D140331P1.3 REVISION : B	P1.3	Rob.	M.J.H	M.J.H
	2006-08-23	#D140331P1.4 REVISION : B	P1.4	Rob.	M.J.H	M.J.H
	2006-05-05	#D140331SP5.0 , REVISION : A (NEW DIAGRAM)	SP5.0	Rob.	M.J.H.	M.J.H.
	2006-05-05	#D140331SP5.1 , REVISION : A (NEW DIAGRAM SAV)	SP5.1	Rob.	M.J.H.	M.J.H.
	2006-08-23	#D140331SP4.1 , REVISION : B	SP4.1	Rob.	M.J.H.	M.J.H.
	2006-08-23	#D140331SP3.1 , REVISION : B	SP3.1	Rob.	M.J.H.	M.J.H.
C	2007-04-13	#D140331 P1.0 REVISION: C (E-Rides valves Replaced)	P1.0	Rob.	M.J.H.	M.J.H.
		#D140331 P1.1 REVISION: C (E-Rides valves Replaced)	P1.1	Rob.	M.J.H.	M.J.H.
		#D140331 P1.2 REVISION: C (E-Rides valves Replaced)	P1.2	Rob.	M.J.H.	M.J.H.
		#D140331 P1.3 REVISION: C (E-Rides valves Replaced)	P1.3	Rob.	M.J.H.	M.J.H.
		#D140331 P1.4 REVISION: C (E-Rides valves Replaced)	P1.4	Rob.	M.J.H.	M.J.H.
		#D140331 P2.0 REVISION: B (E-Rides valves Replaced)	P2.0	Rob.	M.J.H.	M.J.H.
		#D140331 P3.0 REVISION: B (E-Rides valves Replaced)	P3.0	Rob.	M.J.H.	M.J.H.
		#D140331 P4.0 REVISION: B (E-Rides valves Replaced)	P4.0	Rob.	M.J.H.	M.J.H.
		PRODUCTION VEHICLE #8-9226... O.C. #2007020				
D	2007-05	#D140331 P1.0 REVISION: D (ABS 6)	P1.0	Rob.	M.J.H.	M.J.H.
		#D140331 P1.1 REVISION: D (ABS 6)	P1.1	Rob.	M.J.H.	M.J.H.
		#D140331 P1.2 REVISION: D (ABS 6)	P1.2	Rob.	M.J.H.	M.J.H.
		#D140331 P1.3 REVISION: D (ABS 6)	P1.3	Rob.	M.J.H.	M.J.H.
		#D140331 P1.4 REVISION: D (ABS 6)	P1.4	Rob.	M.J.H.	M.J.H.
		#D140331 P2.0 REVISION: C (ABS 6 & ESP)	P2.0 & 2.1	Rob.	M.J.H.	M.J.H.
		#D140331 P3.0 REVISION: C (ABS 6 & ESP)	P3.0 & 3.1	Rob.	M.J.H.	M.J.H.
		#D140331 P4.0 REVISION: C (ABS 6 & ESP)	P4.0 & 4.1	Rob.	M.J.H.	M.J.H.
		#D140331 P7.0 REVISION: B (ESP)	P7.0 & 7.1	Rob.	M.J.H.	M.J.H.
		#D140331 P8.0 REVISION: B (ABS 6)	P8.0 & 8.1	Rob.	M.J.H.	M.J.H.

# PREVOST

## Pneumatic diagram

### *PNEUMATIC DIAGRAMS X3-45 COACHES WITH FRONT BEAM AXLE*

REV.	DATE	DESCRIPTION	PAGE	BY	CHK.	APPR.
D	2007-05-25 2007-06-25	#D140331 P9.0 REVISION: A (ESP) #D140331 P10.0 REVISION: A (ESP) #D140331 SP2.0 REVISION: B (ESP) #D140331 SP4.0 OBSOLETE #D140331 SP5.0 REVISION: B (ESP) # 8-9259 X3-45 PRELIMINARY VEHICLE WITH ESP PRODUCTION VEHICLE ESP (X3-45 ORLEANS) #8-9282...	P9.0 & 9.1 P10.0&10.1 SP2.0&2.1 SP4.0&4.1 SP5.0&5.1	Rob. Rob. Rob. Rob. Rob.	M.J.H. M.J.H. M.J.H. M.J.H. M.J.H.	M.J.H. M.J.H. M.J.H. M.J.H. M.J.H.
E	2007-12-05	#D140331 P1.0 REVISION: E #D140331 P1.1 REVISION: E #D140331 P1.2 REVISION: E #D140331 P1.3 REVISION: E #D140331 P1.4 REVISION: E VEHICULES #8-9405 , #8-9431 , PRODUCTION #8-9426...	P1.0 P1.1 P1.2 P1.3 P1.4	Rob. Rob. Rob. Rob. Rob.	M.J.H. M.J.H. M.J.H. M.J.H. M.J.H.	M.J.H. M.J.H. M.J.H. M.J.H. M.J.H.
F	2008-02-26	ENGINE VOLVO MD 13 Preliminary vehicles : No. 1 #8-9259 , No. 2 #8-9295 , No. 3 #8-9364 PRODUCTION VEHICLE X3-45 : #8-9451 ... New page #D140331P11 New page #D140331SP6	P11&11.1 SP6&6.1	Rob. Rob.	M.J.H. M.J.H.	M.J.H. M.J.H.
G	2008-04-04	NEW AIR HORN , SEE #D140331 P.1 REVISION : F EFFECTIF PRODUCTION VEHICLE : #8-9422...	P1.0 TO 1.4	Rob.	M.J.H.	M.J.H.
H	2008-04-14	#D140331 P7.0 REVISION: C (Update) #D140331 P9.0 REVISION: B (Update) #D140331 P10.0 REVISION: B (Update) #D140331 SP2.0 REVISION: C (Update)	P7.0 & 7.1 P9.0 & 9.1 P10.0&10.1 SP2.0&2.1	Rob. Rob. Rob. Rob.	M.J.H. M.J.H. M.J.H. M.J.H.	M.J.H. M.J.H. M.J.H. M.J.H.
I	2008-01-25	NEW AIR TANKS ASSY FOR DIFFERENTIAL AIR BELLOWS SUSPENSION .#D140331 P.1 , P.2 , P.3 , P.4	P1 TO P4 P1.1 TO 4.1	Rob.	M.J.H.	M.J.H.
J	2008-06-27	D13 VOLVO ENGINE , ADD AIR CLEANER INJECTOR #D140331 P12 & P13 NEW PAGES.RETROFIT PRIOR TO #8-9451	P12.1 P13.1	Y.L.	M.J.H.	M.J.H.
K	2008-07-08 2008-07-15	Update P7 & SP2 air brake trailer hitch COST SAVING , O.C.#2008069 , Effective Vehicle #9-9599... #D140331 P1.0 REVISION: H #D140331 P2.0 REVISION: E #D140331 P3.0 REVISION: E #D140331 P4.0 REVISION: E	P7 & SP2 P1.0 & 1.1 P2.0 & 2.1 P3.0&3.1 P4.0&4.1	Y.L. Rob. Rob. Rob. Rob.	M.J.H. M.J.H. M.J.H. M.J.H. M.J.H.	M.J.H. M.J.H. M.J.H. M.J.H. M.J.H.
L	2008-12-04	#D140331 SP7 ADD NEW PAGE FOR GREYHOUND BOLT BUS	P7.0&7.1	Rob.	M.J.H.	M.J.H.

# PREVOST

## Pneumatic diagram

### PNEUMATIC DIAGRAMS X3-45 COACHES WITH FRONT BEAM AXLE

REV.	DATE	DESCRIPTION	PAGE	BY	CHK.	APPR.
M	2009-01-14	#D140331 P7.0 REV.E & SP2 REV. E SEE O.C.#2008107	P7 & SP2	Rob.	M.J.H.	M.J.H.
N	2009-12-11	#D140331 SP6 REV.B SEE O.C.#2009086	SP6	Rob.	M.J.H.	M.J.H.
O	2010-04-28	NEW TAG AXLE, O.C. #2007131 (Preliminary vehicles: #A-9872 , #A-9907 , #A-9926) EFFECTIVE VEHICLE #A-9953		Y.L.	M.J.H.	M.J.H.
		Revision i	P1.0 & 1.1	Y.L.	M.J.H.	M.J.H.
		Revision F	P2.0 & 2.1	Y.L.	M.J.H.	M.J.H.
		Revision F	P3.0 & 3.1	Y.L.	M.J.H.	M.J.H.
		Revision F	P4.0 & 4.1	Y.L.	M.J.H.	M.J.H.
		MODIFICATION FRONT KNEELING OC#2009038	Revision B	Y.L.	M.J.H.	M.J.H.
			Revision F	Y.L.	M.J.H.	M.J.H.
			Revision C	Y.L.	M.J.H.	M.J.H.
			Revision C	Y.L.	M.J.H.	M.J.H.
			Revision C	Y.L.	M.J.H.	M.J.H.
			Revision B	Y.L.	M.J.H.	M.J.H.
		MODIFICATION SOLENOID 7 th INJECTOR VOLVO OC#2009088	Revision B	Y.L.	M.J.H.	M.J.H.
		MODIFICATION SOLENOID 7 th INJECTOR VOLVO OC#2009088	Revision B	Y.L.	M.J.H.	M.J.H.
		MODIFICATION SOLENOID 7 th INJECTOR VOLVO OC#2009088	Revision B	Y.L.	M.J.H.	M.J.H.
		OC#2007131 NEW PAGE 15	P15.0&P15.1	Y.L.	M.J.H.	M.J.H.
		OC#2007131 NEW PAGE 16	P16.0&P16.1	Y.L.	M.J.H.	M.J.H.
		Revision B	SP1&SP1.1	Y.L.	M.J.H.	M.J.H.
		Revision F	SP2.0&SP2.1	Y.L.	M.J.H.	M.J.H.
		SAV NEW PAGE 7.2 Revision A	P7.2	Rob.	Rob.	M.J.H.
P	2009-07-02	UPDATE, REVISION D	P10 & P10.1	Y.L.	Y.L.	M.J.H.
	2010-06-22					

# Pneumatic diagram

## *PNEUMATIC DIAGRAMS X3-45 COACHES WITH FRONT BEAM AXLE*

PRODUCTION NUMBER	REV	EFF. VEH.	ECN	S.A.V. NUMBER	REV	DESCRIPTION
D140331P1.0	A	#7-8933	2004015	<b>D140331P1.1</b>	<b>I</b>	FULL PNEUMATIC SYSTEM ABS 6
	B	#7-9035	----	<b>D140331P1.2</b>	<b>I</b>	ACCESSORIES
	C	#8-9226	2007020	<b>D140331P1.3</b>	<b>I</b>	BRAKES SYSTEM
	D	#8-9282	2006038 2005002	<b>D140331P1.4</b>	<b>I</b>	SUSPENSION
	E	#8-9426	----			
	F	#8-9422	2006025			
	G	#8-9430	2007108			
	H	#9-9599	2008069			
	<b>I</b>	<b>#A-9953</b>	<b>2007131</b>			
D140331P2.0	A	#7-8933	2004015	<b>D140331P2.1</b>	A	KNEELING & LOW-BUOY OPTION
	B	#8-9226	2007020		B	
	C	#8-9282	2006038 2005002		C	
	D	#8-9430	2007108		D	
	E	#9-9599	2008069		E	
	<b>F</b>	<b>#A-9953</b>	<b>2007131</b>		<b>F</b>	
D140331P3.0	A	#7-8933	2004015	<b>D140331P3.1</b>	A	KNEELING & HIGH-BUOY OPTION
	B	#8-9226	2007020		B	
	C	#8-9282	2006038 2005002		C	
	D	#8-9430	2007108		D	
	E	#9-9599	2008069		E	
	<b>F</b>	<b>#A-9953</b>	<b>2007131</b>		<b>F</b>	
D140331P4.0	A	#7-8933	2004015	<b>D140331P4.1</b>	A	KNEELING, LOW-BUOY & HIGH-BUOY OPTION
	B	#8-9226	2007020		B	
	C	#8-9282	2006038 2005002		C	
	D	#8-9430	2007108		D	
	E	#9-9599	2008069		E	
	<b>F</b>	<b>#A-9953</b>	<b>2007131</b>		<b>F</b>	

## Pneumatic diagram

### PNEUMATIC DIAGRAMS X3-45 COACHES WITH FRONT BEAM AXLE

PRODUCTION NUMBER	REV	EFF. VEH.	ECN	S.A.V. NUMBER	REV	DESCRIPTION
D140331P5.0	A B	#7-8933 #A-9867	2004015 2009038	D140331P5.1	A B	KNEELING OPTION
D140331P6.0	A	#7-8933	2004015	D140331P6.1	A	PARKING BRAKE WITH WCL WITHOUT KNEELING OPTION
D140331P7.0	A B C D E F	#7-8933 #8-9282 --- --- #9-9674 #A-9953	2004015 2006038 2005002 --- --- 2008107 2007131	D140331P7.1	A B C D E F	TRAILER HITCH AIR BRAKE OPTION (Allison transmission) AND ESP OPTION
----	----	#8-9405,9-9614 9-9648,9-9660	---	D140331P7.2	A	TRAILER HITCH AIR BRAKE OPTION (Allison transmission) AND ESP OPTION, Modification pneumatic line Retrofit, (2009-07)
D140331P8.0	A B C	#7-8933 #8-9282 #A-9953	2004015 2006038 2005002 2007131	D140331P8.1	A B C	WITH ZF TRANSMISSION ABS 6 ( HALDEX AIR DRYER IN REAR SUB-FRAME ) S-60
D140331P9.0	A B C	#8-9282 #A-9953	2006038 2005002 2007131	D140331P9.1	A B C	WITH ZF TRANSMISSION SYSTEM ESP OPTION ( HALDEX AIR DRYER IN REAR SUB-FRAME ) S-60
D140331P10.0	A B C D	#8-9282 #A-9953	2006038 2005002 2007131	D140331P10.1	A B C D	BRAKE SYSTEM ESP (Electronic Stability Program) OPTION
D140331P11.0	A B	#8-9451 #A-9953	2005086 2007131	D140331P11.1	A B	D13 VOLVO ENGINE HALDEX AIR DRYER INTO LUGGAGE COMPARTMENT
D140331P12.0	A B	#8-9451 #A-9953	2008048 2009088	D140331P12.1	A B	D13 VOLVO ENGINE WITH RETARDER, ALLISON TRANSM.
D140331P13.0	A B	#8-9451 #A-9953	2008048 2009088	D140331P13.1	A B	D13 VOLVO ENGINE WITHOUT RETARDER, ALLISON TRANSM.
D140331P14.0	A	#8-9282	2005002	D140331P14.1	A	S60 ENGINE WITH OUTPUT RETARDER, ALLISON TRANSM.

# Pneumatic diagram

## PNEUMATIC DIAGRAMS X3-45 COACHES WITH FRONT BEAM AXLE

	<b>B</b>	<b>#A-9953</b>	<b>2009088</b>		<b>B</b>	
PRODUCTION NUMBER	REV	EFF. VEH.	ECN	S.A.V. NUMBER	REV	DESCRIPTION
D140331P15.0	<b>A</b>	<b>#A-9953</b>	<b>2007131</b>	D140331P15.1	<b>A</b>	S60 ENGINE HALDEX AIR DRYER IN REAR SUB-FRAME
D140331P16.0	<b>A</b>	<b>#A-9953</b>	<b>2007131</b>	D140331P16.1	<b>A</b>	D13 VOLVO ENGINE HALDEX AIR DRYER IN REAR SUB-FRAME
D140331SP1.0	A <b>B</b>	#7-8883 <b>#A-9953</b>	2004015 <b>2007131</b>	D140331SP2.1	A <b>B</b>	“SPECIAL” WITH WABCO AIR DRYER INTO LUGGAGE COMPARTMENT AND ENGINE DETROIT S-60
D140331SP2.0	A B C D E <b>F</b>	#7-8933 #8-9282 --- --- #9-9674 <b>#A-9953</b>	2004015 2006038 2005002 --- --- 2008107 <b>2007131</b>	D140331SP2.1	A B C D E <b>F</b>	“SPECIAL” WITH TRAILER AIR BRAKE, ZF TRANSMISSION AND ESP OPTION
D140331SP3.0	A <b>B</b>	#7-8933 #7-8883	2004015 ----	D140331SP3.1	A <b>B</b>	“SPECIAL” WITH OPTION PARKING BRAKE RELEASE WITH SUPPLEMENTARY SWITCH
D140331SP4.0	A <b>B</b>	--- ---	2004015 ----	D140331SP4.1		“SPECIAL” WITH ZF TANSMISSION TRACTION CONTROL ATC & TRAILER HITCH OPTION ( No application )
D140331SP5.0	A <b>B</b>	#7-8983 <b>#8-9282</b>	---- <b>2006038</b>	D140331SP5.1	A <b>B</b>	“SPECIAL” WITH FRONT PNEUMATIC FILL VALVE , SERVICE COMPARTMENT.
D140331SP6.0	A B <b>C</b>	#8-9451 #A-9887 <b>#A-9953</b>	2005086 2009086 <b>2007131</b>	D140331SP6.1	A B <b>C</b>	“SPECIAL” D13 VOLVO ENGINE WABCO AIR DRYER INTO LUGGAGE COMPARTMENT
D140331SP7.0	<b>A</b>	<b>#9-9643</b>	-----	D140331SP7.1	<b>A</b>	“SPECIAL” DETROIT ENGINE WITH HALDEX AIR DRYER ON LUGGAGE COMPARTMENT (GREYHOUND BOLT BUS) WARNING : SEE #D140331 P1 Revision I , for the same option witch became standard since OC#2007131.

NOTES: 1) WITH OUTPUT RETARDER ON WORLD AUTOMATIC TRANSMISSION

ACTIVE	COLOR	CIRCUIT
---	RED	SECONDARY
---	GREEN	PRIMARY & SUPPLY
---	YELLOW	PARKING BRAKE
---	BLUE	STANDARD SUSPENSION
---	BLACK	ACCESSORIES

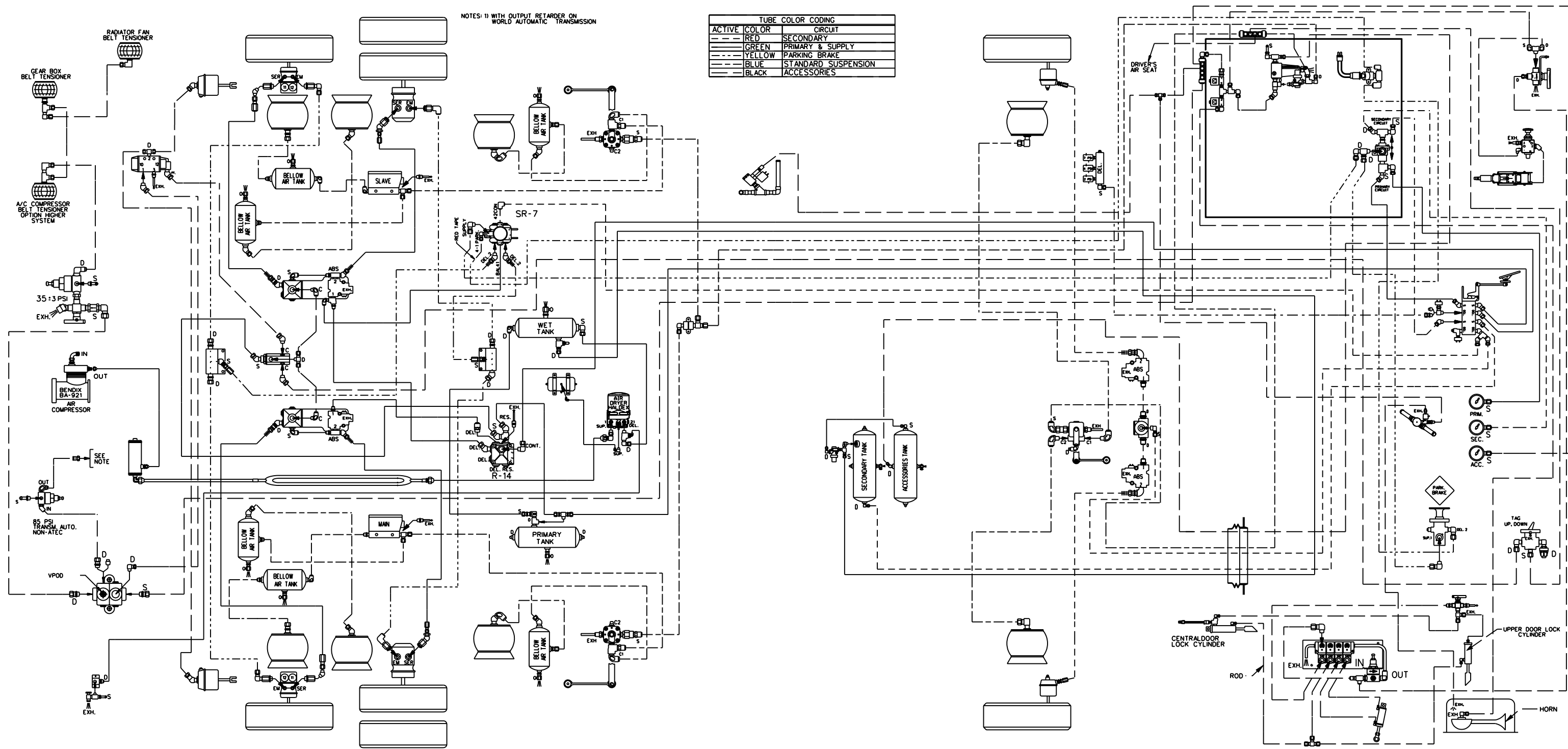

**PREVOST**

DESCRIPTION: X3-45 COACH WITH FRONT I-BEAM AXLE FULL PNEUMATIC SYSTEM

EFF. W/ VEH : #7-8938...  
 DATE: 2006/03 REV.: A

PAGE: D140331 P1.1

NOTES: 1) WITH OUTPUT RETARDER ON WORLD AUTOMATIC TRANSMISSION

ACTIVE	COLOR	CIRCUIT
---	RED	SECONDARY
---	GREEN	PRIMARY & SUPPLY
---	YELLOW	PARKING BRAKE
---	BLUE	STANDARD SUSPENSION
---	BLACK	ACCESSORIES

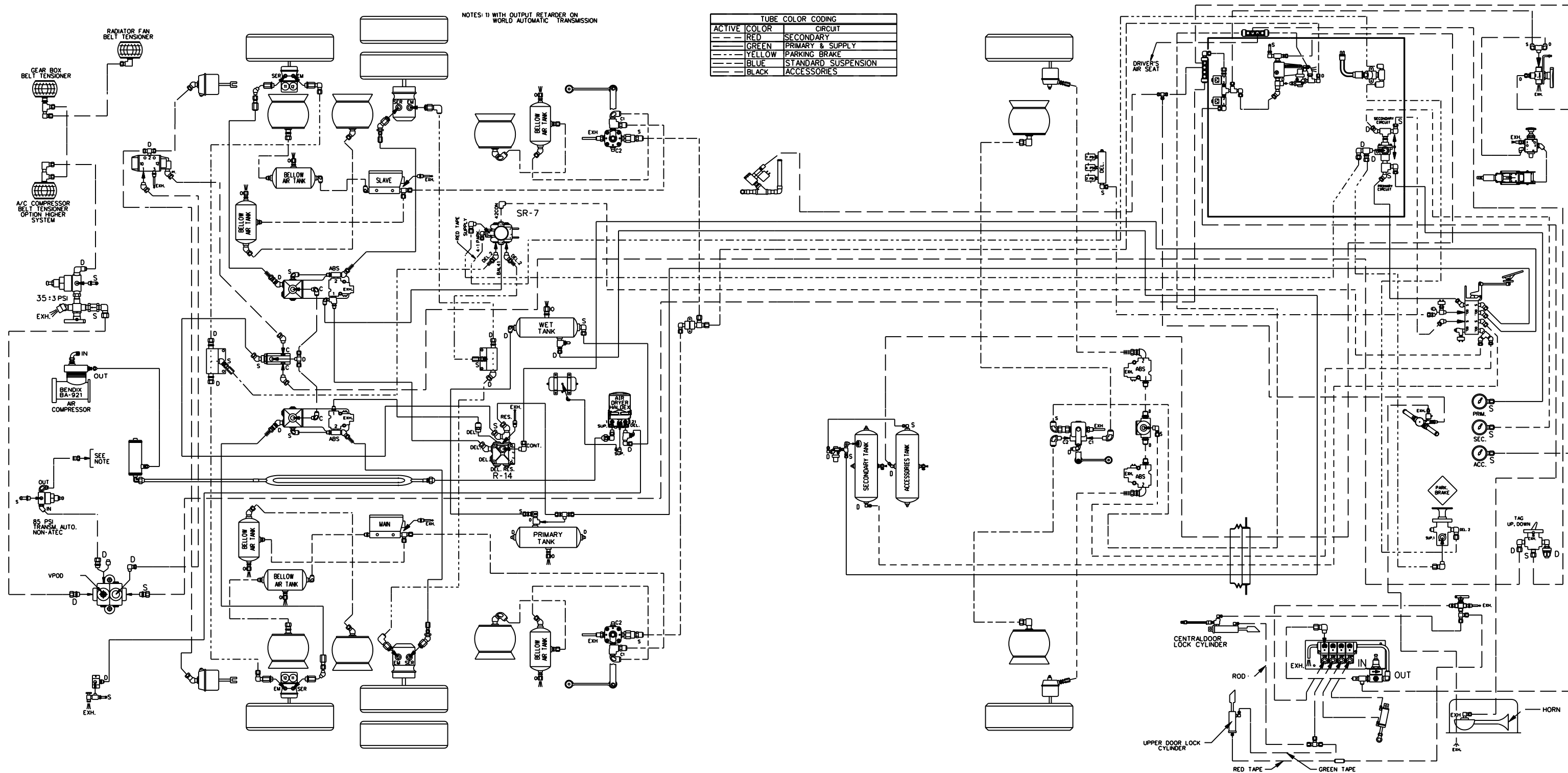

**PREVOST**

DESCRIPTION:

X3-45 COACH WITH FRONT I-BEAM AXLE  
FULL PNEUMATIC SYSTEM

EFF. W/ VEH :

#7-9035...

PAGE:

D140331 P1.1

DATE:

2006/08

REV.:

B



NOTES: 1) WITH OUTPUT RETARDER ON WORLD AUTOMATIC TRANSMISSION

ACTIVE	COLOR	CIRCUIT
---	RED	SECONDARY
---	GREEN	PRIMARY & SUPPLY
---	YELLOW	PARKING BRAKE
---	BLUE	STANDARD SUSPENSION
---	BLACK	ACCESSORIES

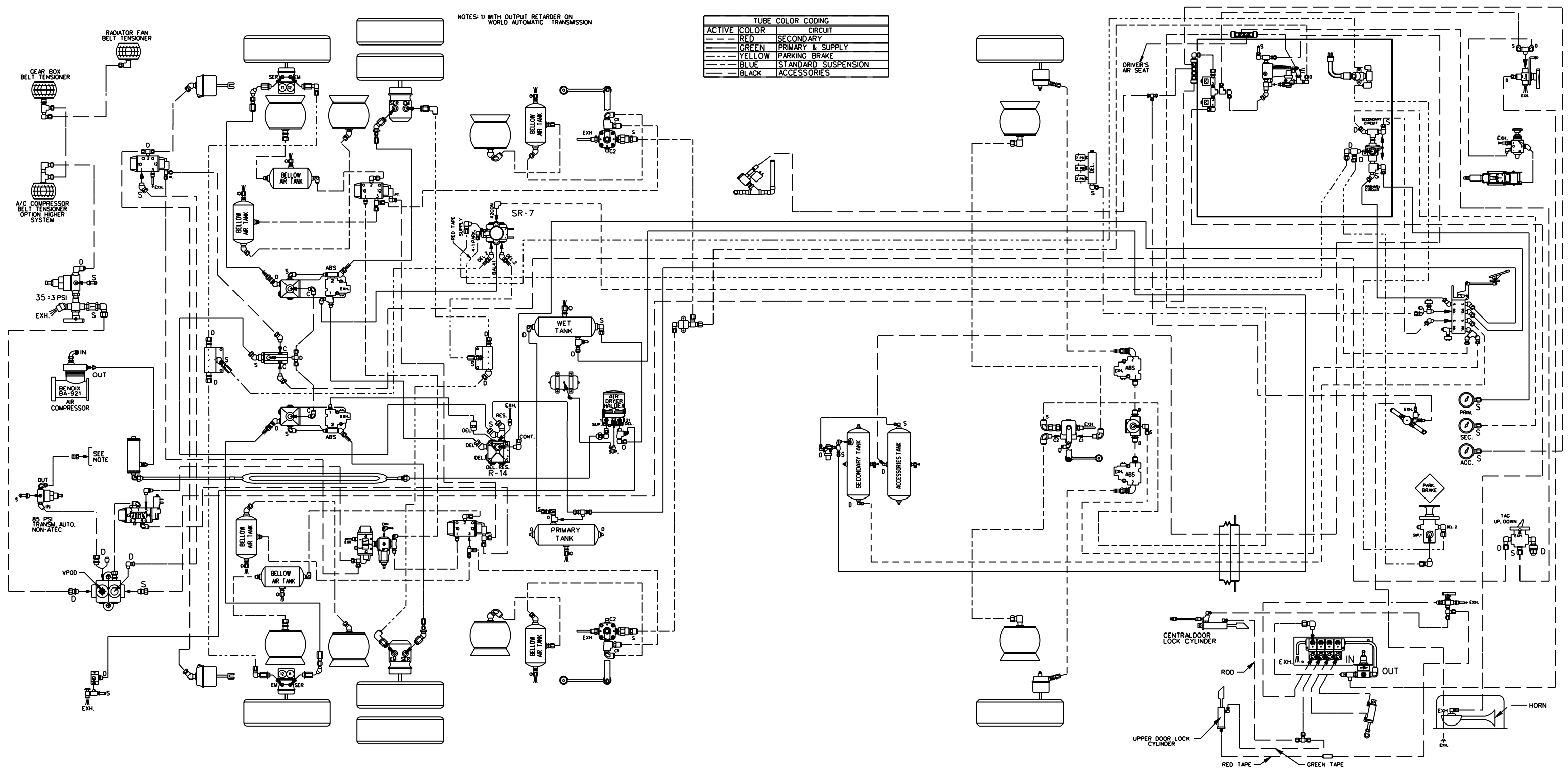

**PREVOST**®

DESCRIPTION: X3-45 COACH WITH FRONT I-BEAM AXLE FULL PNEUMATIC SYSTEM

EFF. W/ VEH : #8-9226...  
 DATE: 2007/04 REV.: C

PAGE: D140331 P1.1

NOTES: 1) WITH OUTPUT RETARDER ON  
WORLD AUTOMATIC TRANSMISSION

ACTIVE	COLOR	CIRCUIT
---	RED	SECONDARY
---	GREEN	PRIMARY & SUPPLY
---	YELLOW	PARKING BRAKE
---	BLUE	STANDARD SUSPENSION
---	BLACK	ACCESSORIES

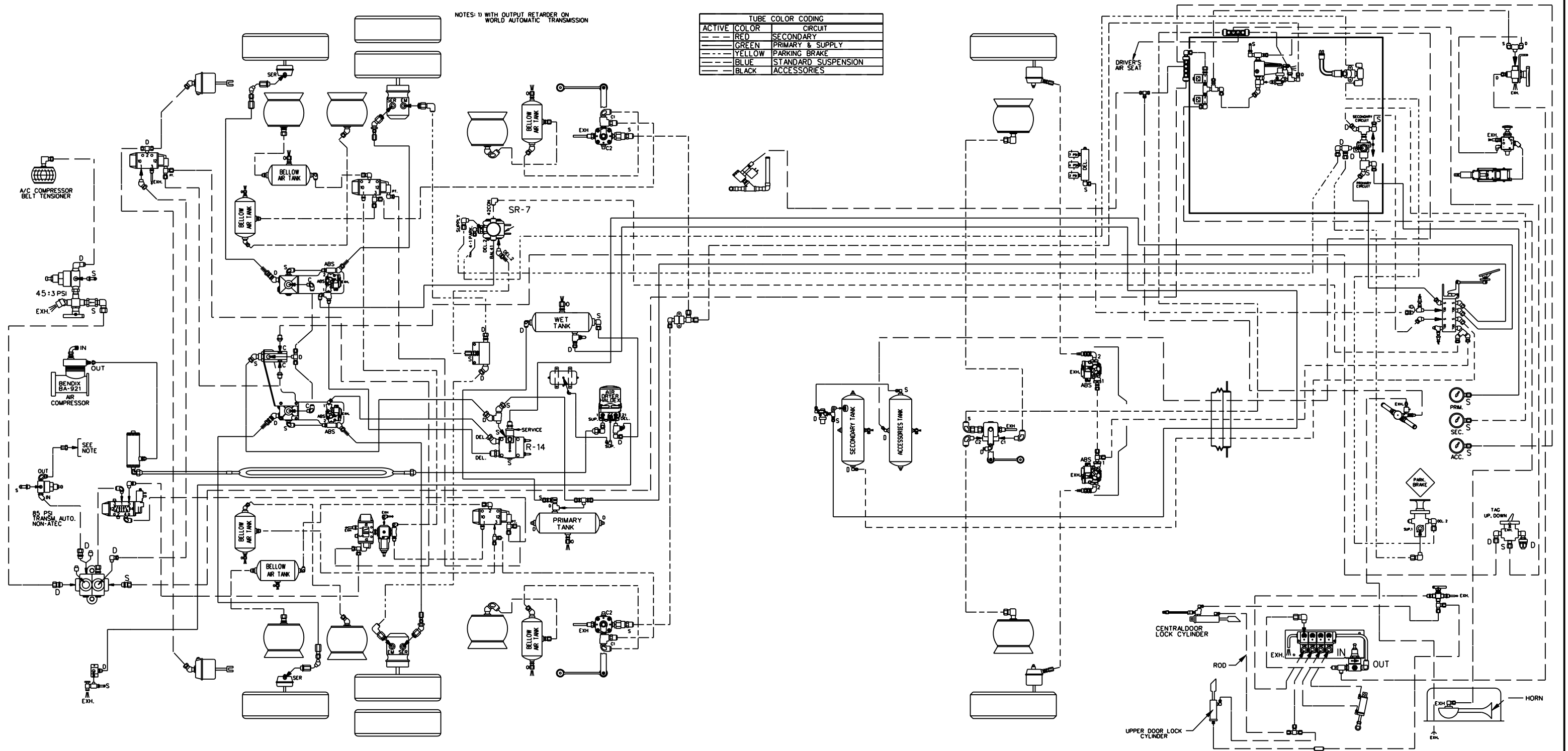

**PREVOST**

DESCRIPTION:

X3-45 COACH WITH FRONT I-BEAM AXLE  
FULL PNEUMATIC SYSTEM

EFF. W/ VEH : #8-9282...

PAGE:

D140331 P1.1

DATE: 2007/05

REV.: D

NOTES: 1) WITH OUTPUT RETARDER ON WORLD AUTOMATIC TRANSMISSION

ACTIVE	COLOR	CIRCUIT
---	RED	SECONDARY
---	GREEN	PRIMARY & SUPPLY
---	YELLOW	PARKING BRAKE
---	BLUE	STANDARD SUSPENSION
---	BLACK	ACCESSORIES

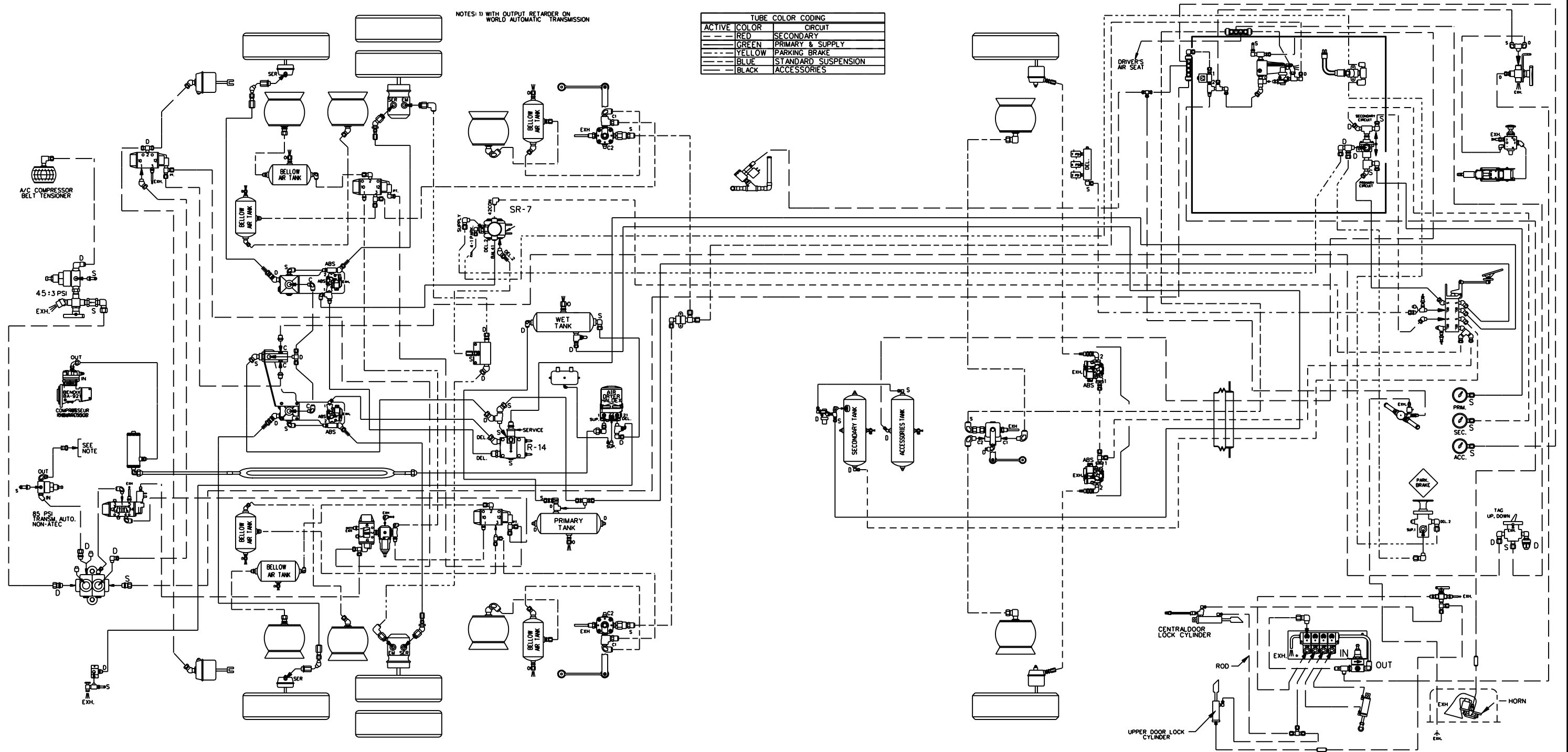

**PREVOST.**

DESCRIPTION:

X3-45 COACH WITH FRONT I-BEAM AXLE  
FULL PNEUMATIC SYSTEM

EFF. W/ VEH : #8-9422...

PAGE:

DATE: 2008/03

REV.: F

D140331 P1.1

NOTES: 1) WITH OUTPUT RETARDER ON WORLD AUTOMATIC TRANSMISSION

ACTIVE	COLOR	CIRCUIT
---	RED	SECONDARY
---	GREEN	PRIMARY & SUPPLY
---	YELLOW	PARKING BRAKE
---	BLUE	STANDARD SUSPENSION
---	BLACK	ACCESSORIES

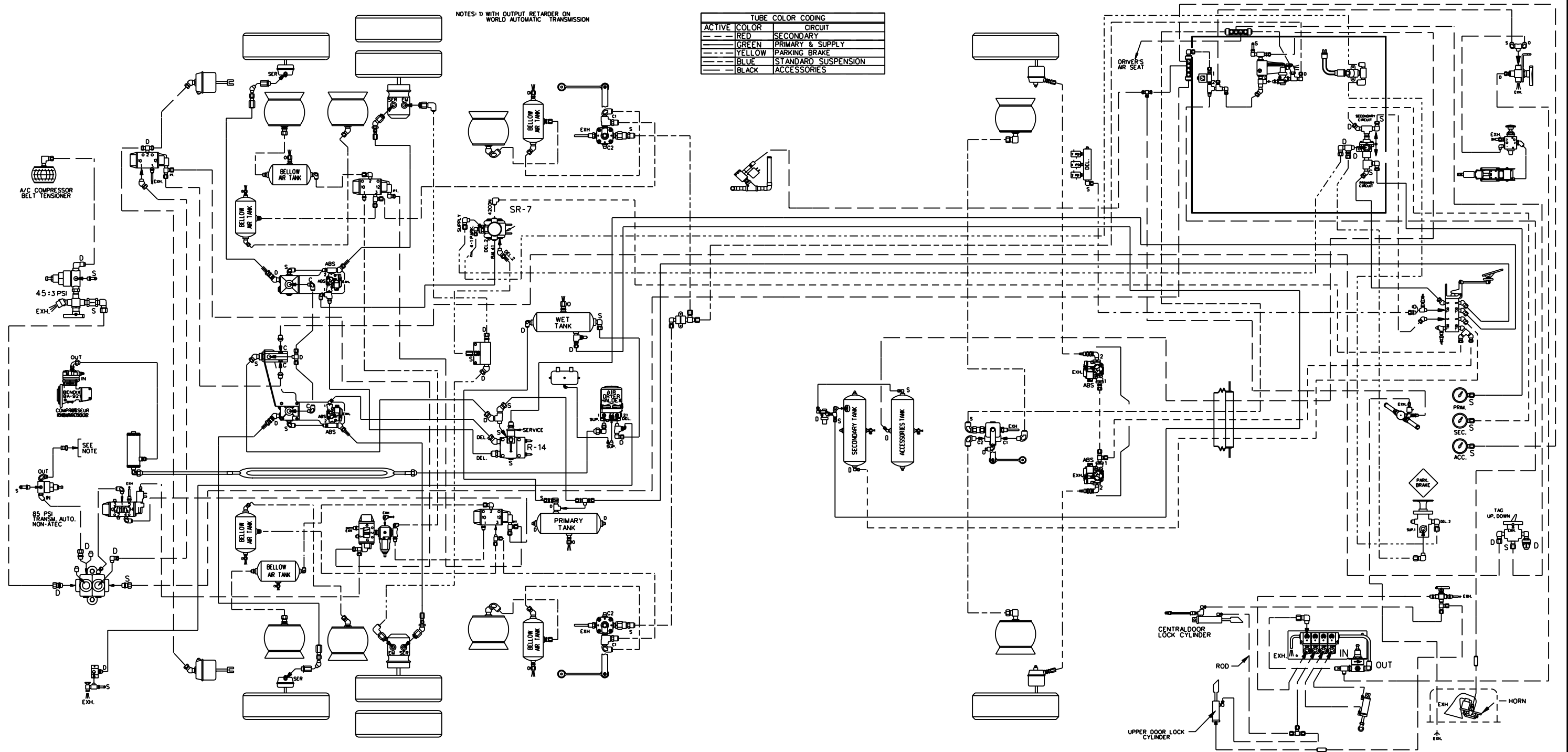

**PREVOST.**

DESCRIPTION:

X3-45 COACH WITH FRONT I-BEAM AXLE  
FULL PNEUMATIC SYSTEM

EFF. W/ VEH : #8-9430

PAGE:

DATE: 2008/04

REV.: G

D140331 P.1

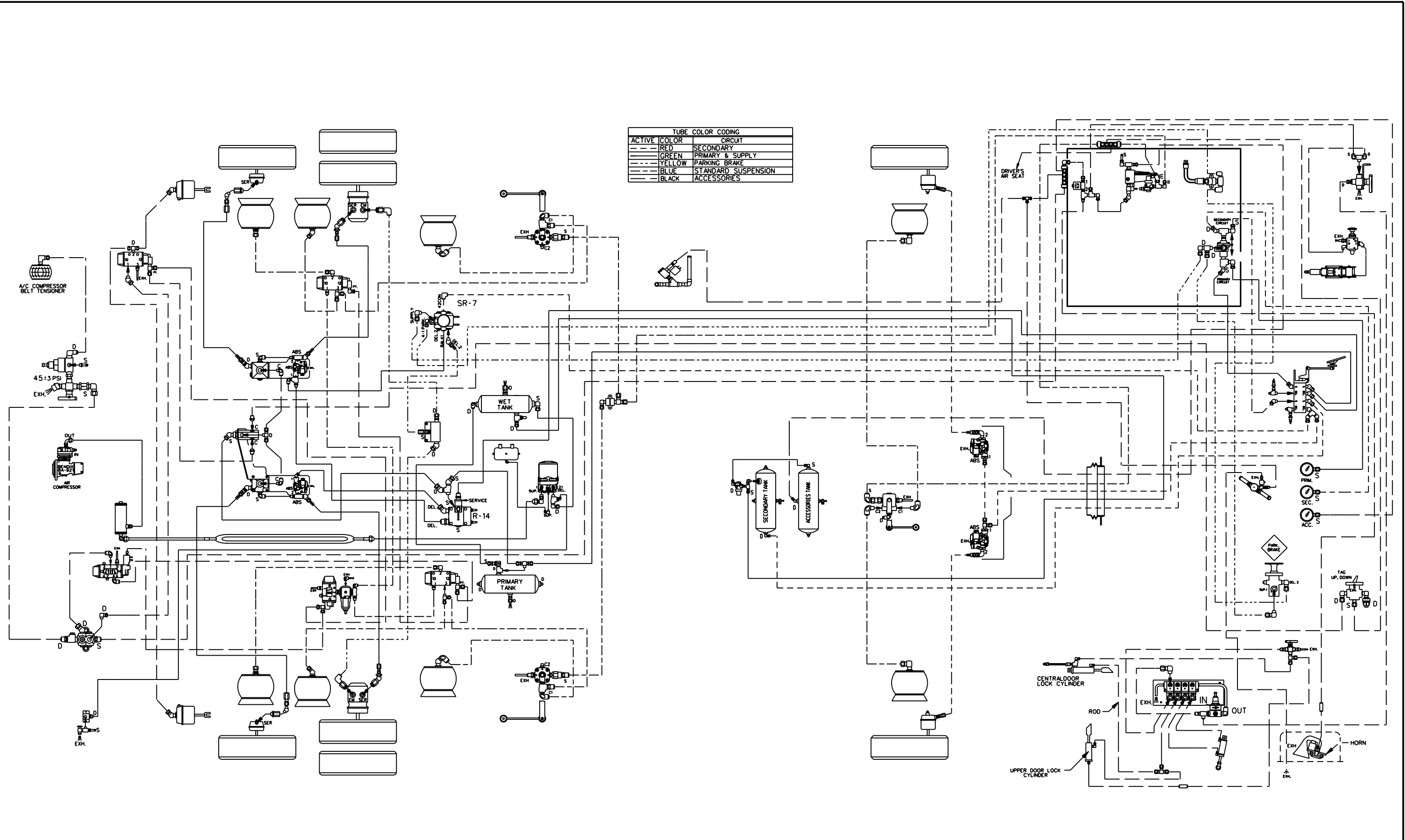

**PREVOST.**

DESCRIPTION:

X3-45 COACH WITH FRONT I-BEAM AXLE  
FULL PNEUMATIC SYSTEM

EFF. W/ VEH : #9-9599...

PAGE:

DATE: 2008/07

REV.: H

D140331 P.1

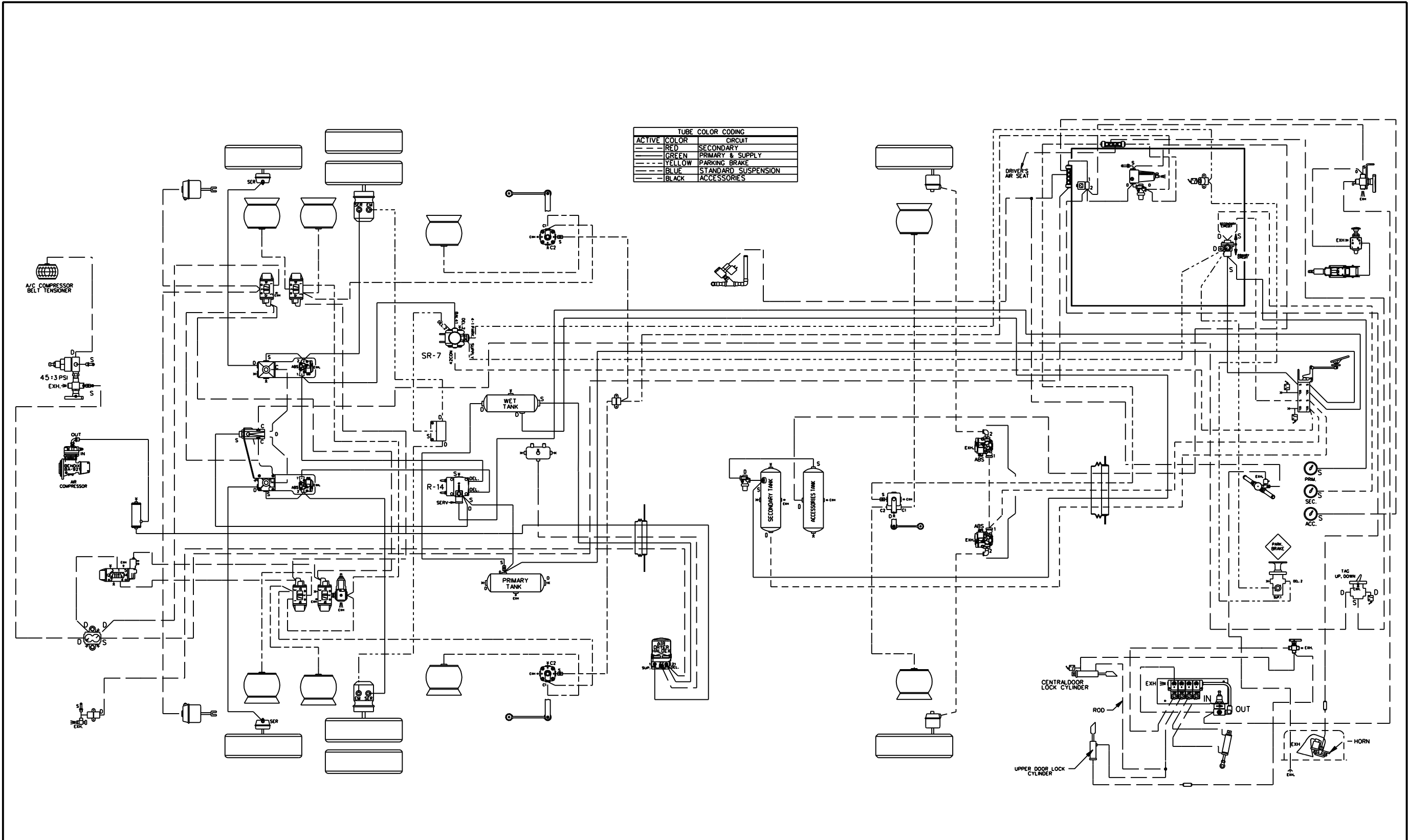

TUBE COLOR CODING	
ACTIVE	CIRCUIT
—	RED SECONDARY
- - -	GREEN PRIMARY & SUPPLY
- - - - -	YELLOW PARKING BRAKE
- · - · -	BLUE STANDARD SUSPENSION
- · - - -	BLACK ACCESSORIES

**PREVOST**®

DESCRIPTION: X3-45 COACH WITH FRONT I-BEAM AXLE FULL PNEUMATIC SYSTEM

EFF. W/ VEH : #A-9953  
 DATE: 2010/04 REV.: i

PAGE: D140331 P.1.1

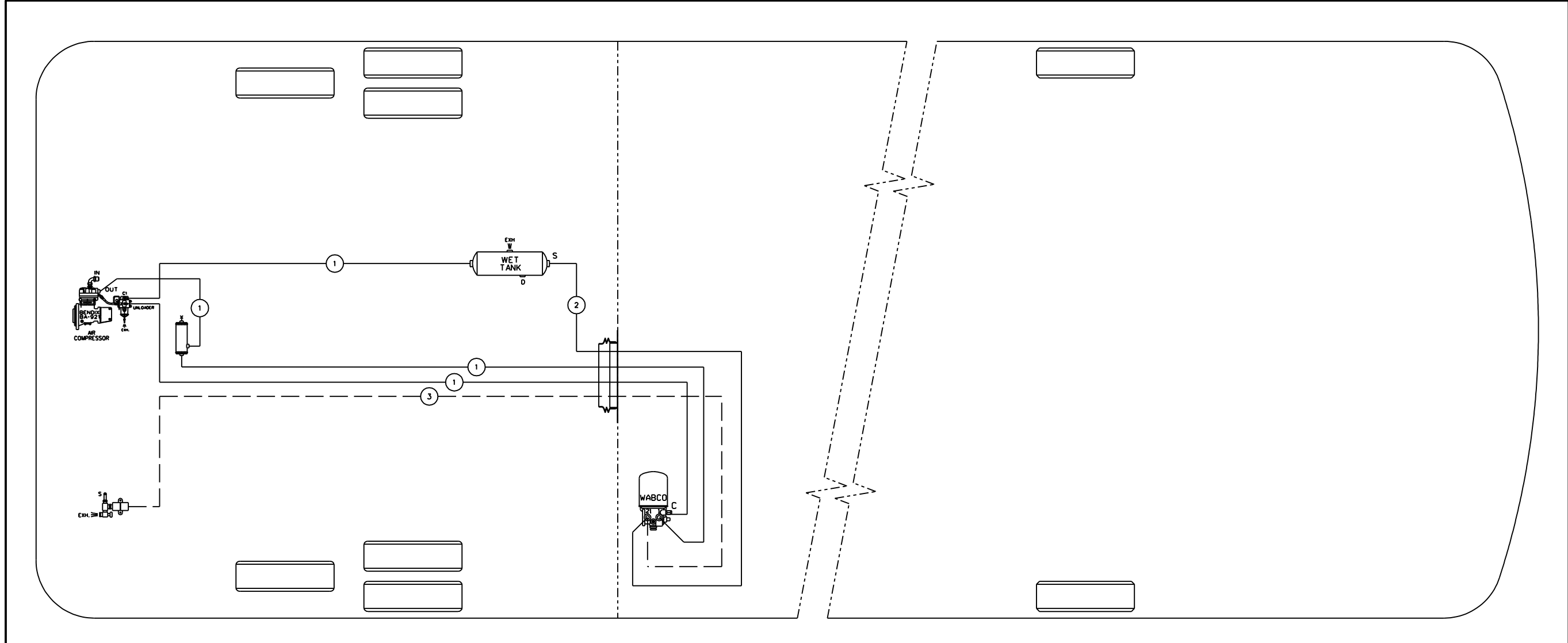

TUBE COLOR CODING		
ACTIVE	COLOR	CIRCUIT
—	GREEN	PRIMARY & SUPPLY
—	BLACK	ACCESSORIES

BALLOON	PIPE
•1	HOSE ASS'Y
•2	3/4" O.D. GREEN
•3	1/4" O.D. BLACK
•4	3/8" O.D. GREY

**PREVOST**®

DESCRIPTION:  
 X3-45 COACH, S60 DETROIT ENGINE WITH FRONT BEAM AXLE  
 WITH OPTION WABCO AIR DRYER

EFF. W/ VEH : #A-9953  
 DATE: 2010/04 REV.: B

PAGE:  
 D140331 SP1.1

NOTES: 1) WITH OUTPUT RETARDER ON WORLD AUTOMATIC TRANSMISSION

TUBE COLOR CODING		
ACTIVE	COLOR	CIRCUIT
—	BLACK	ACCESSORIES

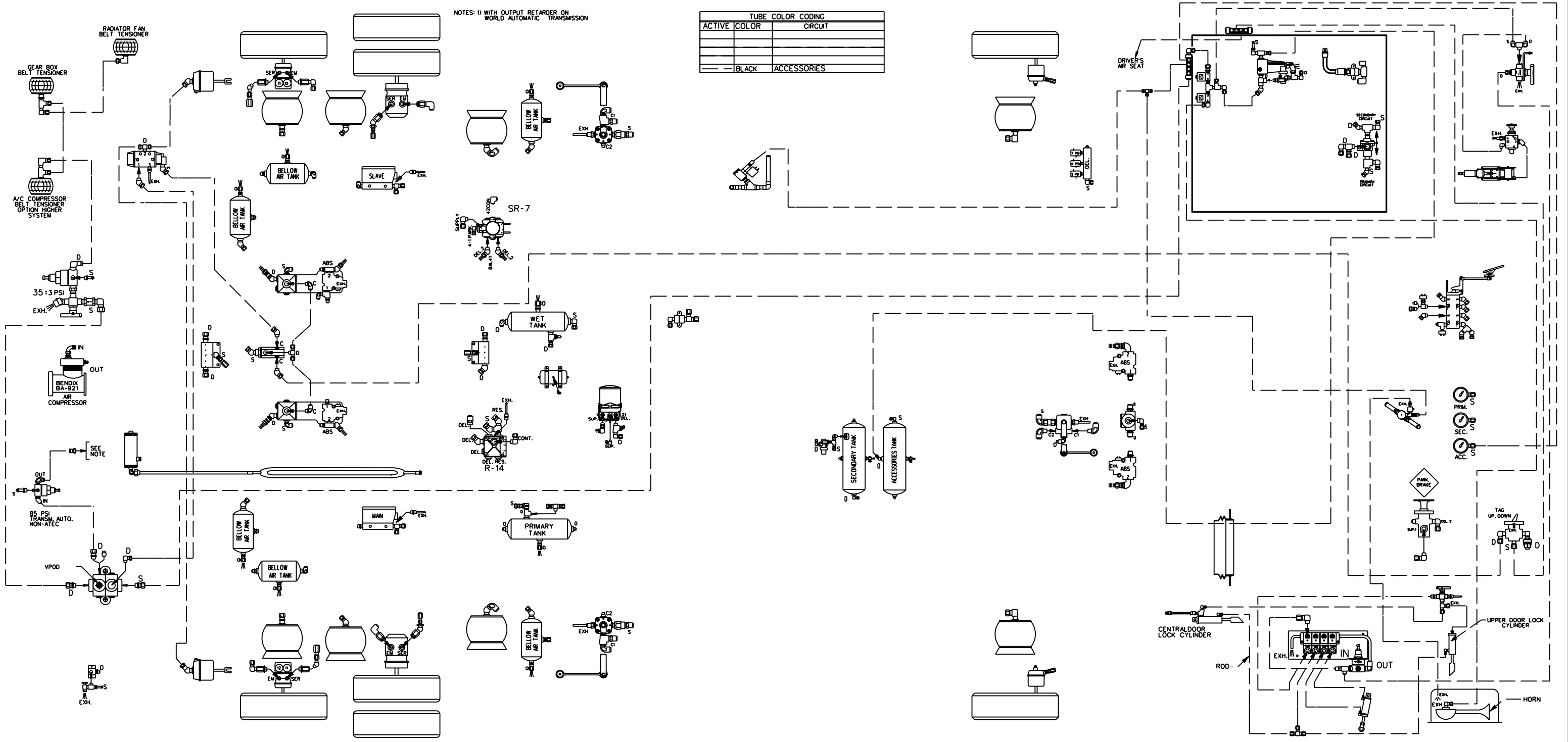

**PREVOST**

DESCRIPTION: X3-45 COACH WITH FRONT I-BEAM AXLE ACCESSORIES

EFF. W/ VEH : #7-8938...  
 DATE: 2006/03 REV.: A

PAGE: D140331P1.2



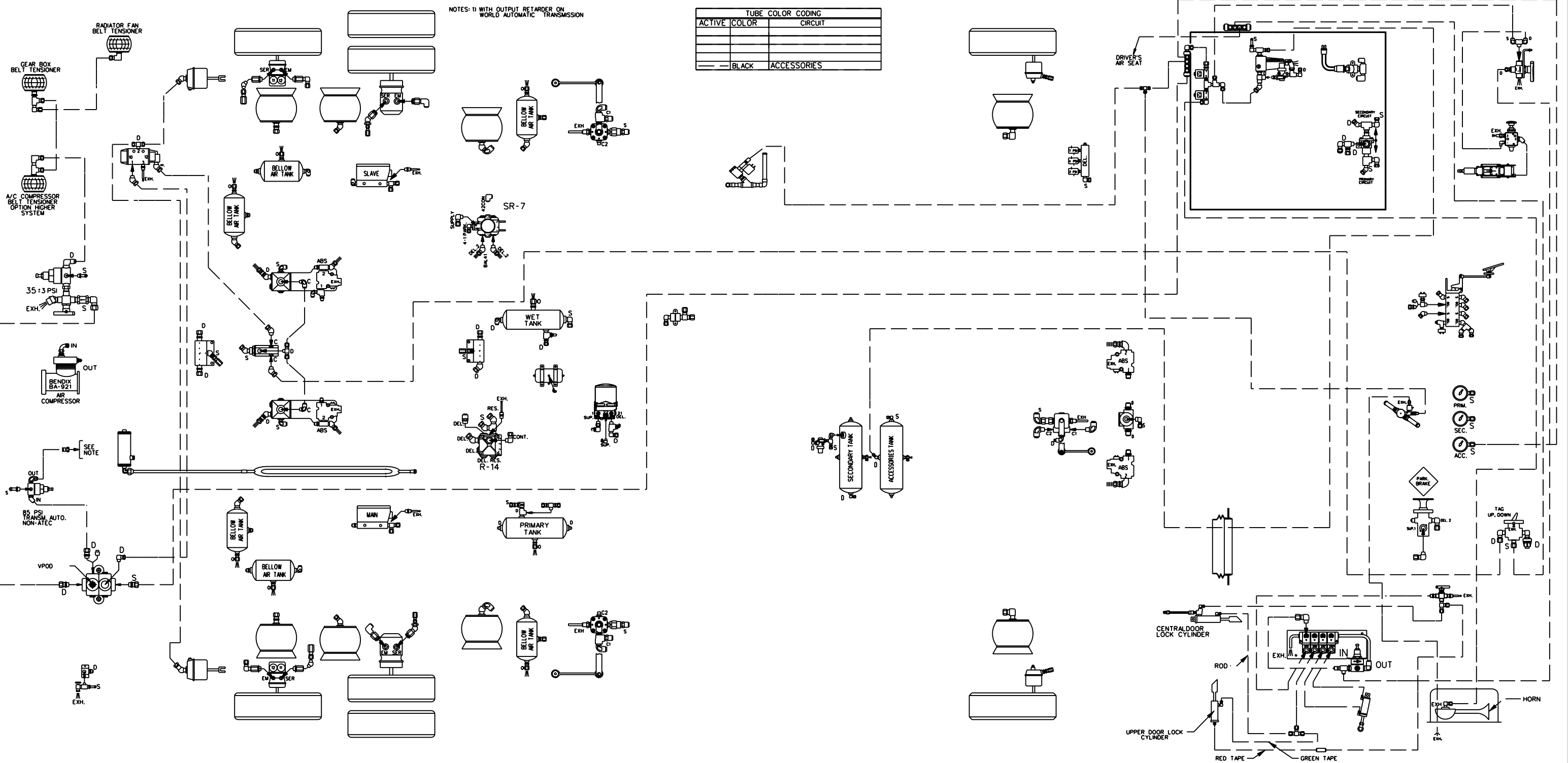

**PREVOST®**

DESCRIPTION:

X3-45 COACH WITH FRONT I-BEAM AXLE ACCESSORIES

EFF. W/ VEH : #7-9035...

PAGE:

D140331P1.2

DATE: 2006/08

REV.: B

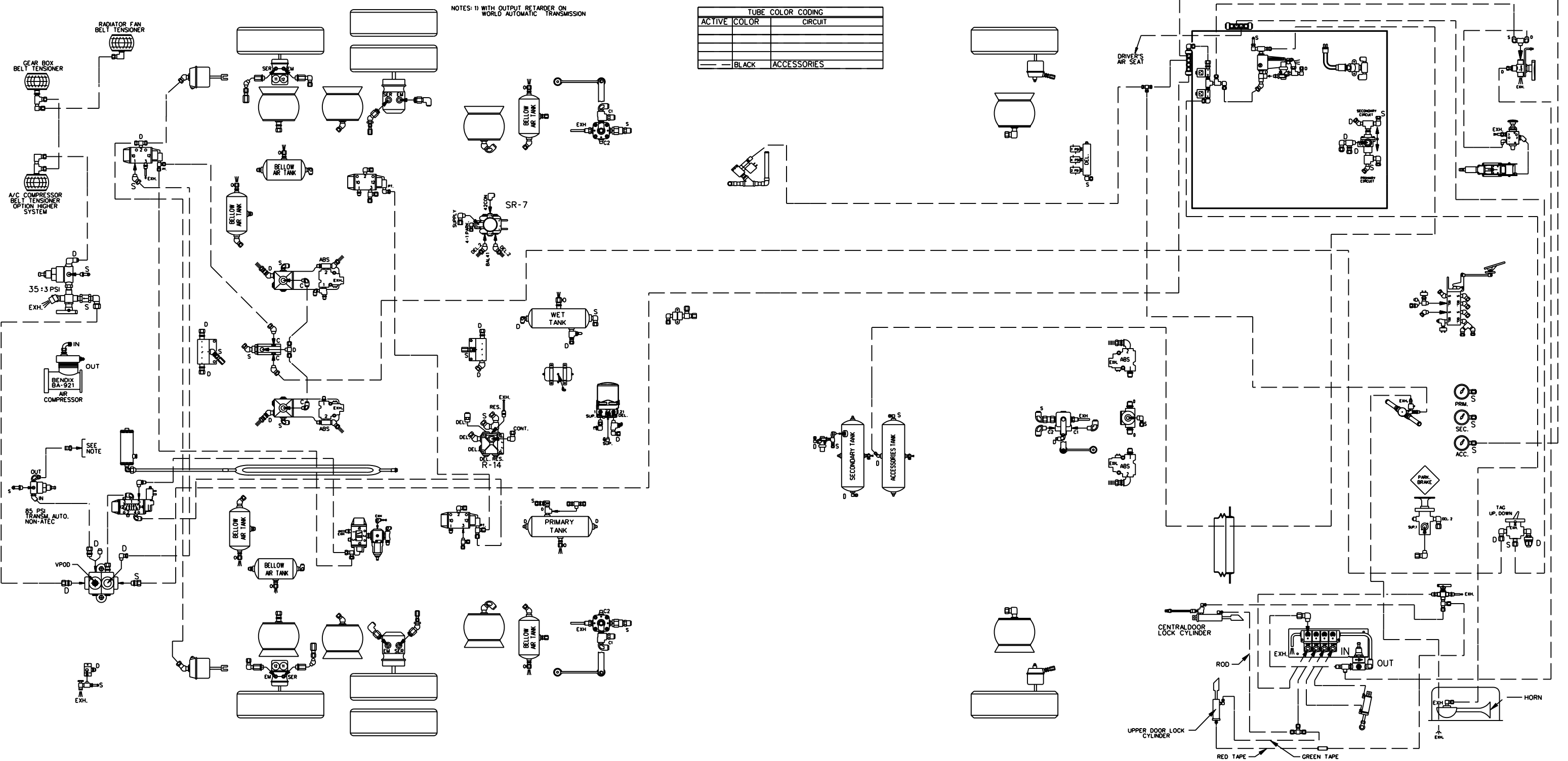

**PREVOST**®

DESCRIPTION:

X3-45 COACH WITH FRONT I-BEAM AXLE ACCESSORIES

EFF. W/ VEH :

#8-9226...

PAGE:

D140331P1.2

DATE:

2007/04

REV.:

C

NOTES: 1) WITH OUTPUT RETARDER ON WORLD AUTOMATIC TRANSMISSION

TUBE COLOR CODING	
ACTIVE COLOR	CIRCUIT
— BLACK	ACCESSORIES

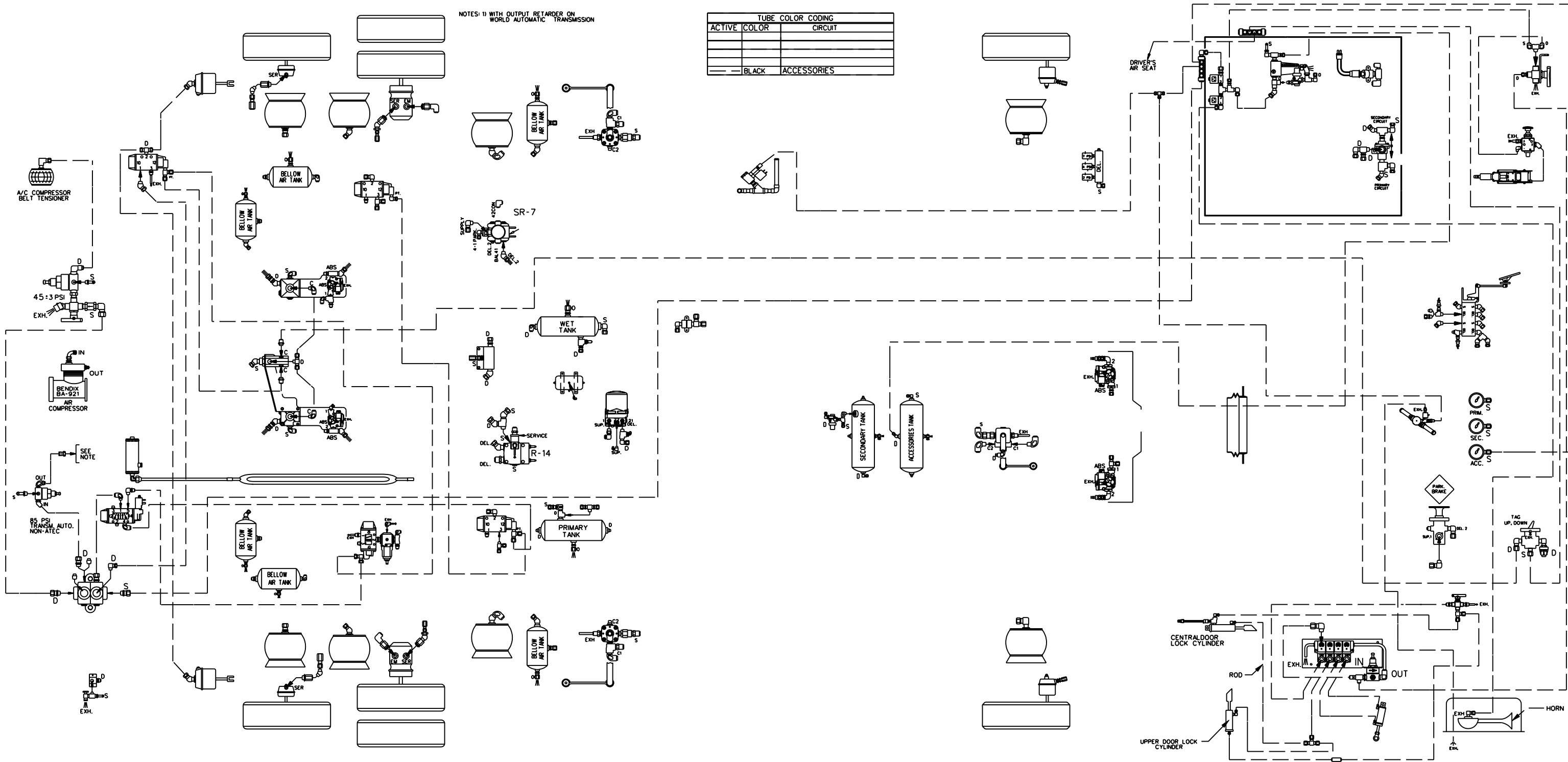

**PREVOST®**

DESCRIPTION:

X3-45 COACH WITH FRONT I-BEAM AXLE ACCESSORIES

EFF. W/ VEH : #8-9282...

PAGE:

DATE: 2007/05

REV.: D

D140331P1.2

NOTES: 1) WITH OUTPUT RETARDER ON WORLD AUTOMATIC TRANSMISSION

TUBE COLOR CODING		
ACTIVE	COLOR	CIRCUIT
—	BLACK	ACCESSORIES

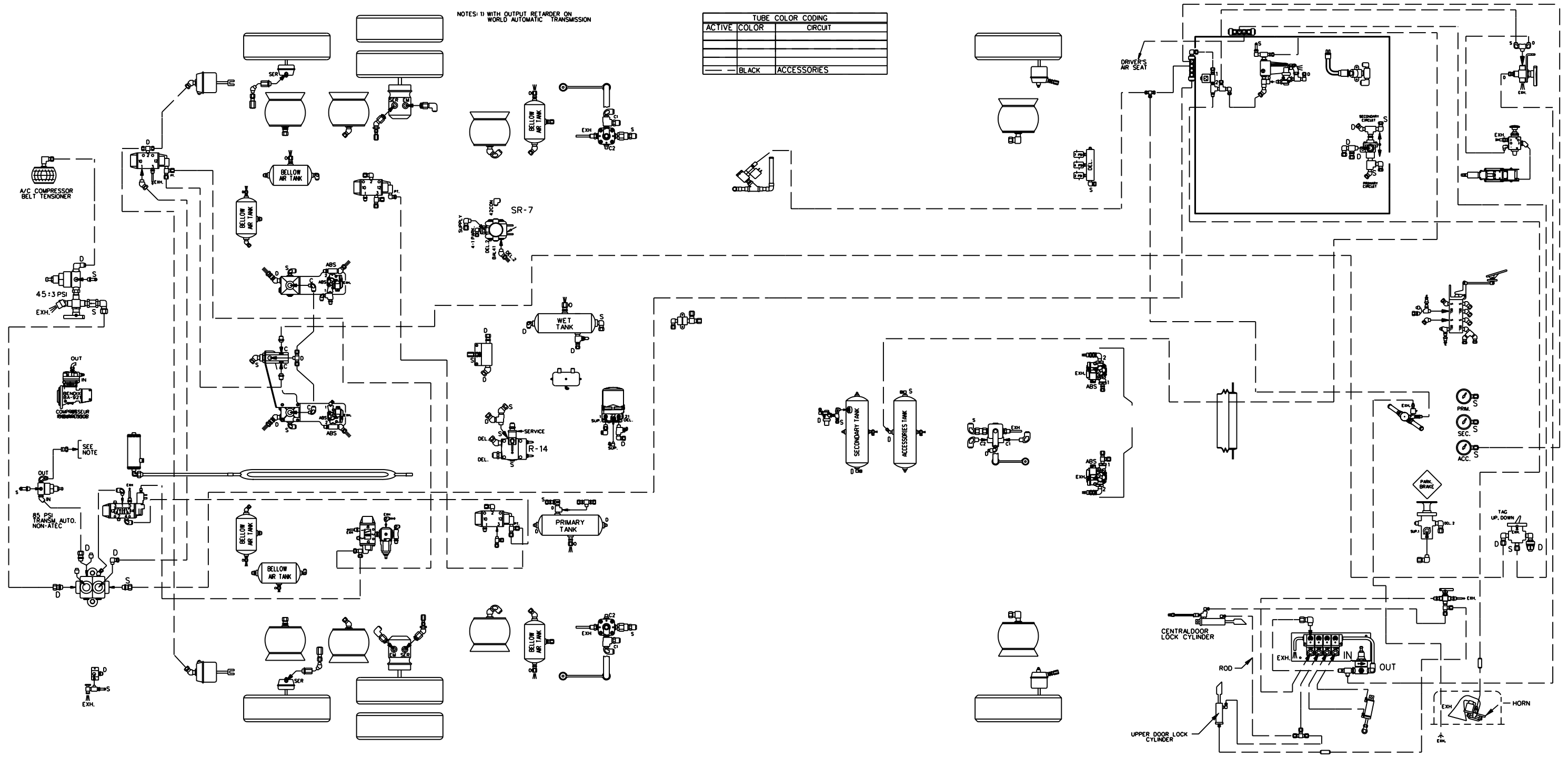

**PREVOST**

DESCRIPTION: X3-45 COACH WITH FRONT I-BEAM AXLE ACCESSORIES

EFF. W/ VEH : #8-9422...  
 DATE: 2008/03 REV.: F

PAGE:  
 D140331P1.2

NOTES: 1) WITH OUTPUT RETARDER ON WORLD AUTOMATIC TRANSMISSION

TUBE COLOR CODING		
ACTIVE	COLOR	CIRCUIT
—	BLACK	ACCESSORIES

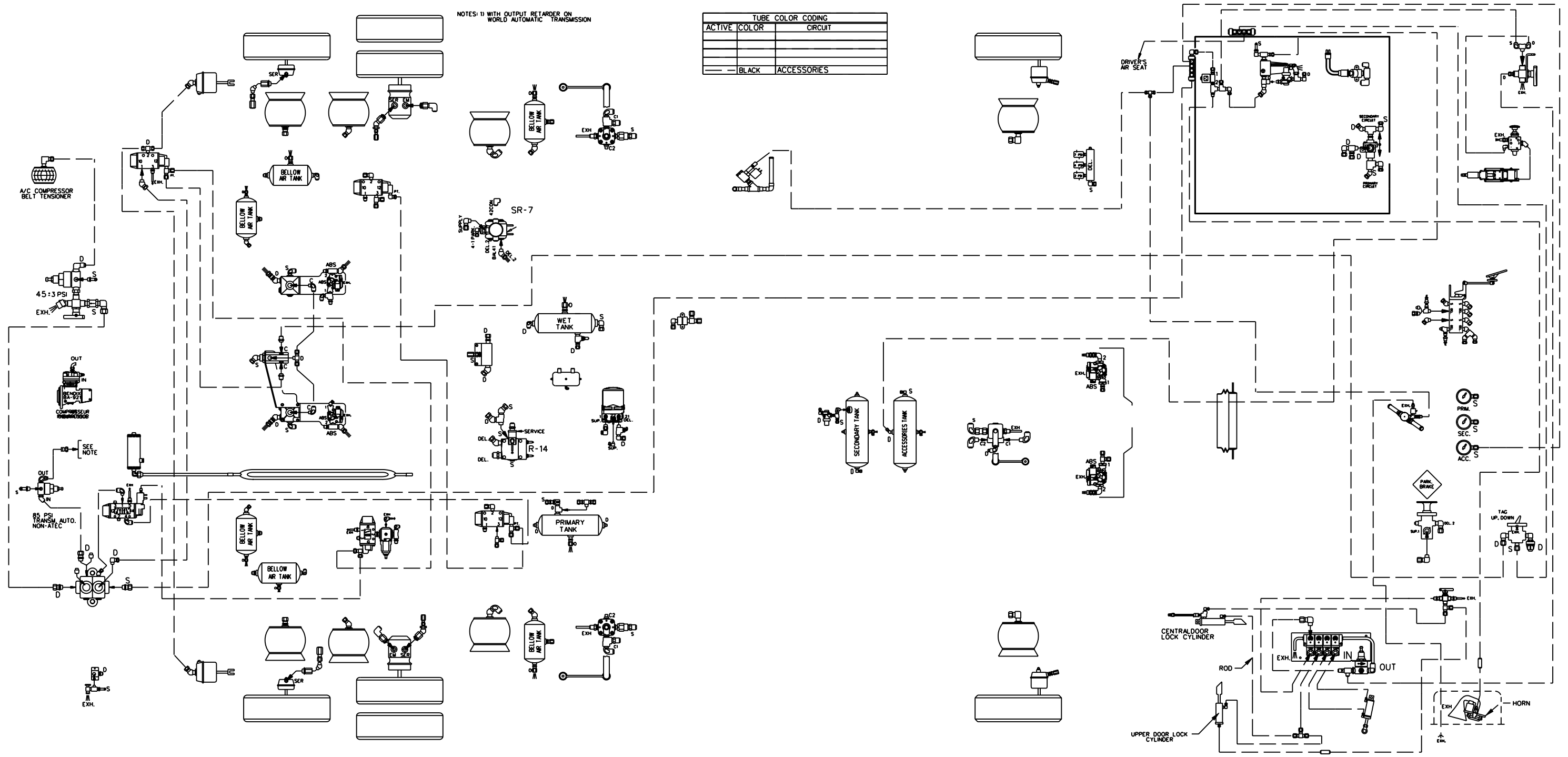

**PREVOST**

DESCRIPTION: X3-45 COACH WITH FRONT I-BEAM AXLE ACCESSORIES

EFF. W/ VEH : #8-9430  
 DATE: 2008/04 REV.: G

PAGE: D140331 P1.2

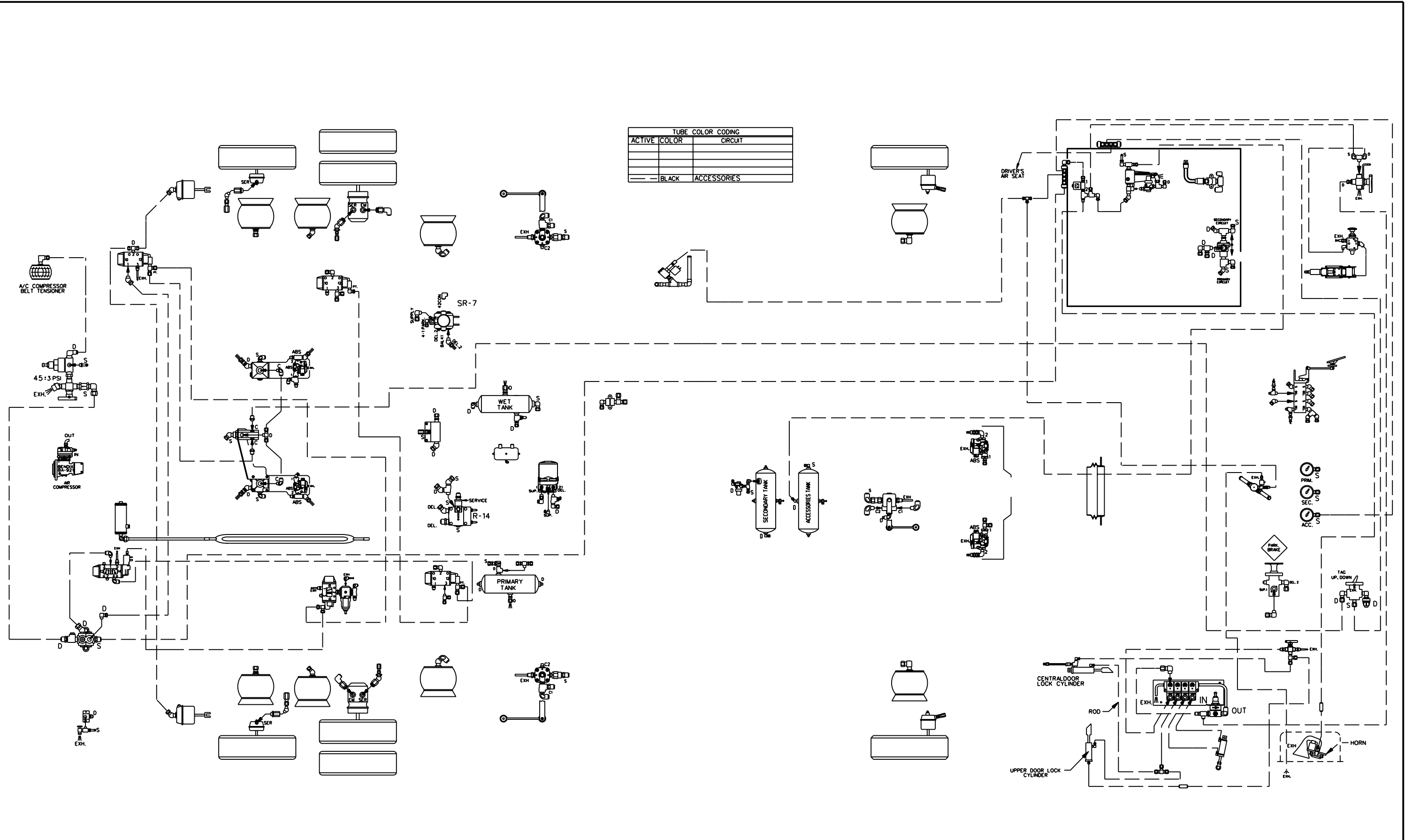

**PREVOST**®

DESCRIPTION: X3-45 COACH WITH FRONT I-BEAM AXLE ACCESSORIES

EFF. W/ VEH : #9-9599...

PAGE:

DATE: 2008/07

REV.: H

D140331 P1.2

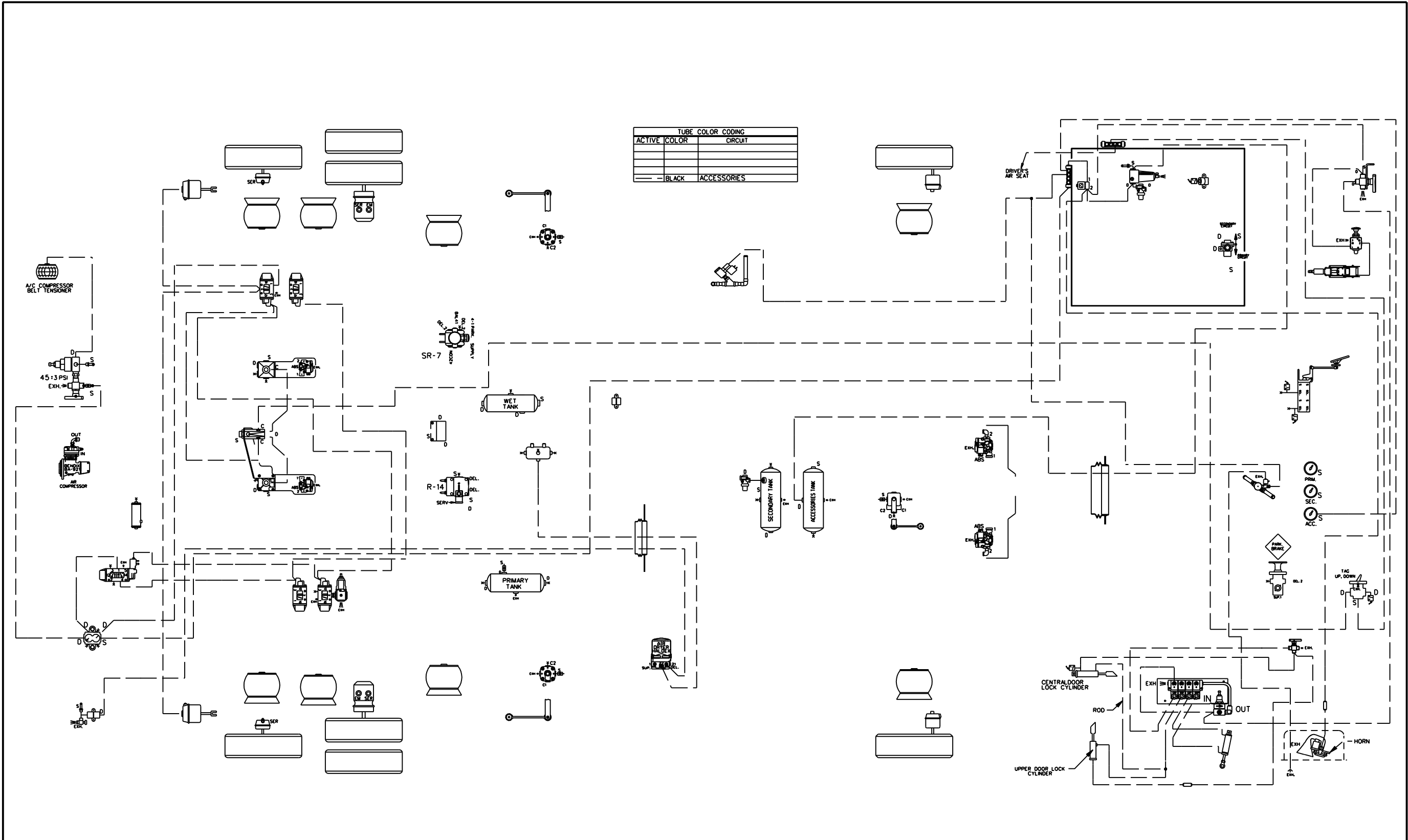

**PREVOST®**

DESCRIPTION: X3-45 COACH WITH FRONT I-BEAM AXLE ACCESSORIES

EFF. W/ VEH : #A-9953  
 DATE: 2010/04 REV.: i

PAGE: D140331 P1.2

NOTES: 1) WITH OUTPUT RETARDER ON WORLD AUTOMATIC TRANSMISSION

TUBE COLOR CODING	
ACTIVE COLOR	CIRCUIT
---	RED
---	GREEN
---	YELLOW

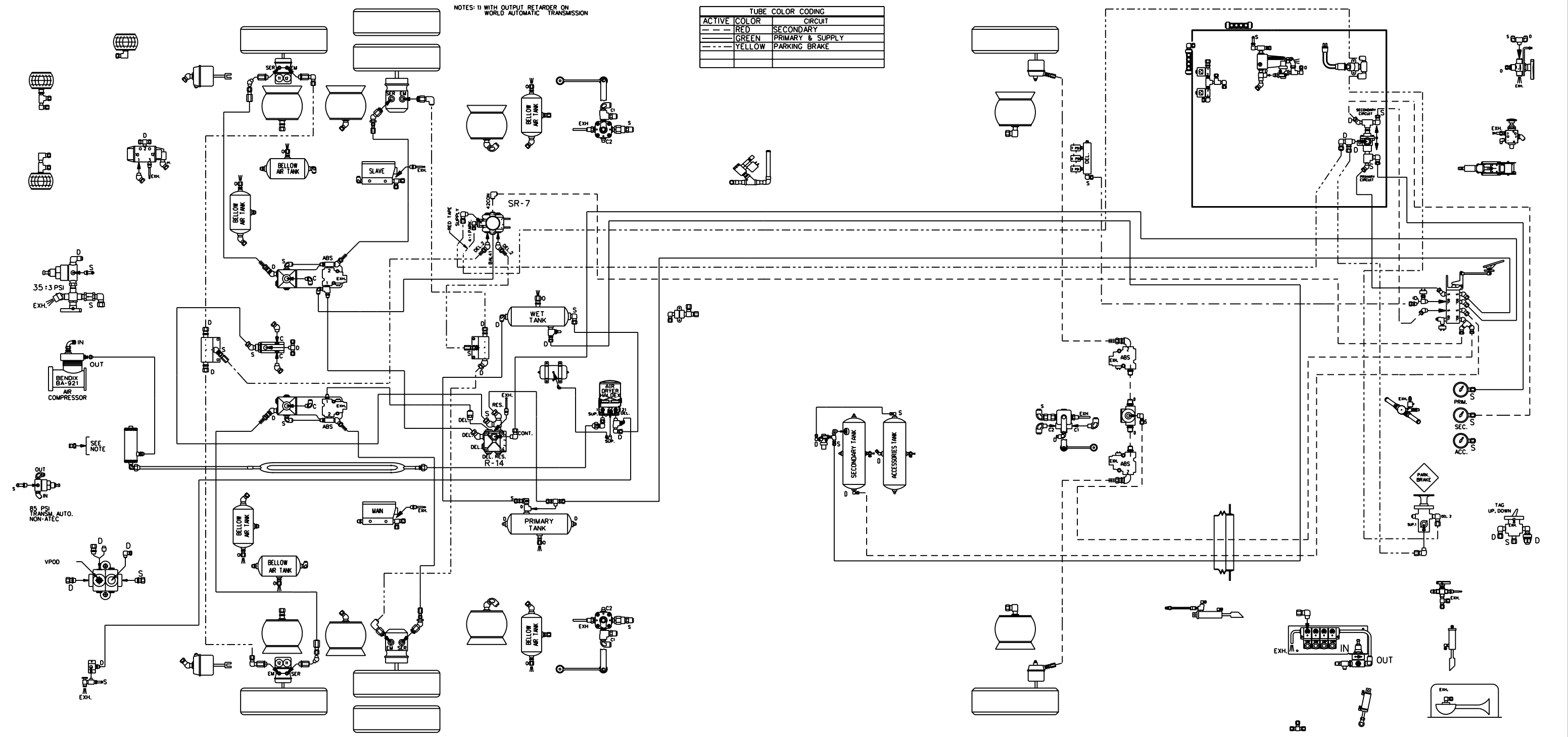

**PREVOST**

DESCRIPTION: X3-45 COACH WITH FRONT I-BEAM AXLE BRAKES SYSTEM

EFF. W/ VEH : #7-8938...  
 DATE: 2006/03 REV: A

PAGE: D140331 P1.3



NOTES: 1) WITH OUTPUT RETARDER ON  
WORLD AUTOMATIC TRANSMISSION

ACTIVE	COLOR	CIRCUIT
---	RED	SECONDARY
---	GREEN	PRIMARY & SUPPLY
---	YELLOW	PARKING BRAKE

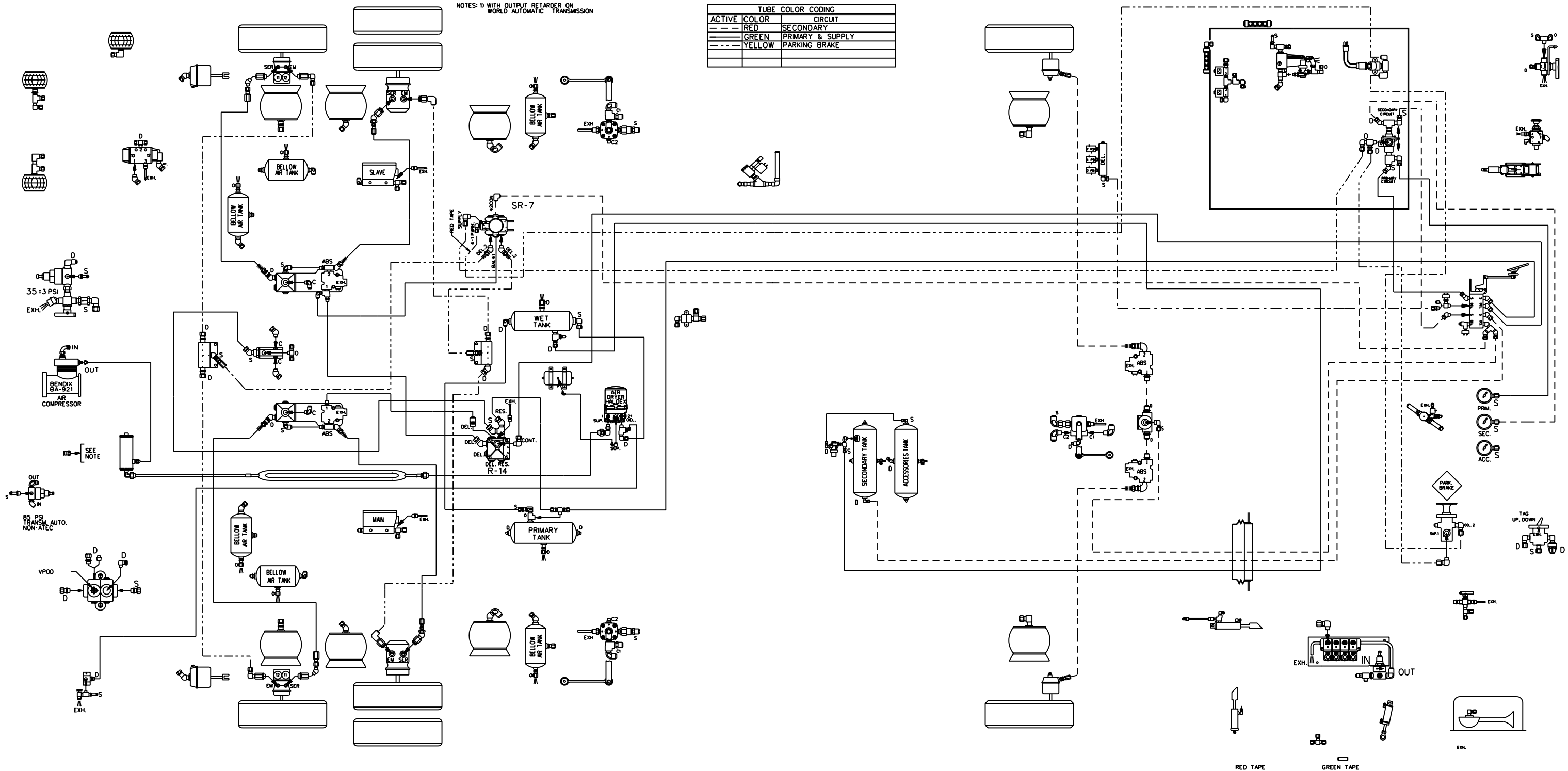

**PREVOST**

DESCRIPTION:

X3-45 COACH WITH FRONT I-BEAM AXLE  
BRAKES SYSTEM

EFF. W/ VEH :

#7-9035...

PAGE:

D140331 P1.3

DATE:

2006/08

REV.:

B

NOTES: 1) WITH OUTPUT RETARDER ON WORLD AUTOMATIC TRANSMISSION

TUBE COLOR CODING		
ACTIVE	COLOR	CIRCUIT
---	RED	SECONDARY
---	GREEN	PRIMARY & SUPPLY
---	YELLOW	PARKING BRAKE

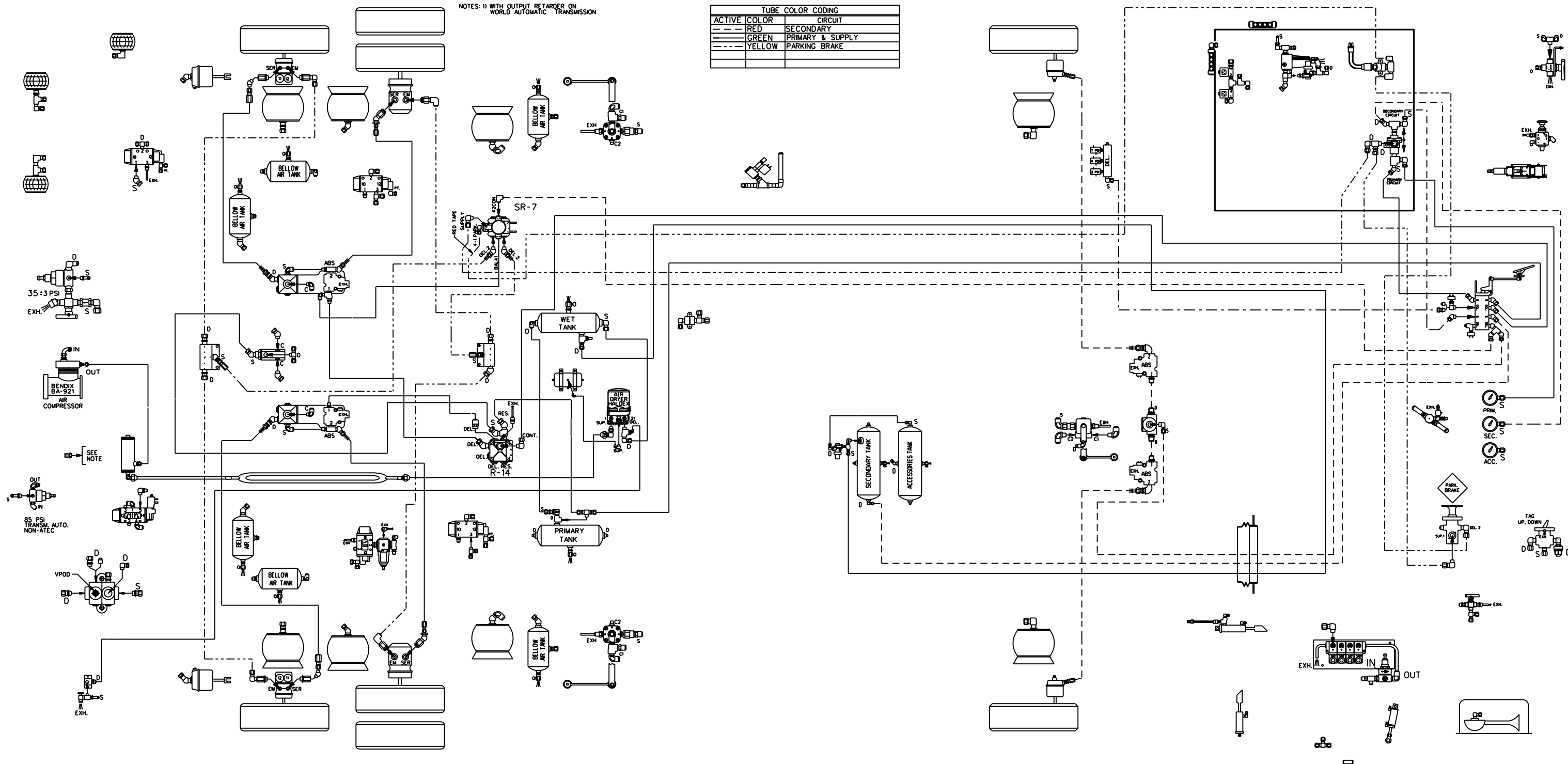

**PREVOST**®

DESCRIPTION: X3-45 COACH WITH FRONT I-BEAM AXLE BRAKES SYSTEM

EFF. W/ VEH : #8-9226...  
 DATE: 2007/04 REV.: C

PAGE: D140331 P1.3

NOTES: 1) WITH OUTPUT RETARDER ON  
WORLD AUTOMATIC TRANSMISSION

ACTIVE	COLOR	CIRCUIT
---	RED	SECONDARY
---	GREEN	PRIMARY & SUPPLY
---	YELLOW	PARKING BRAKE

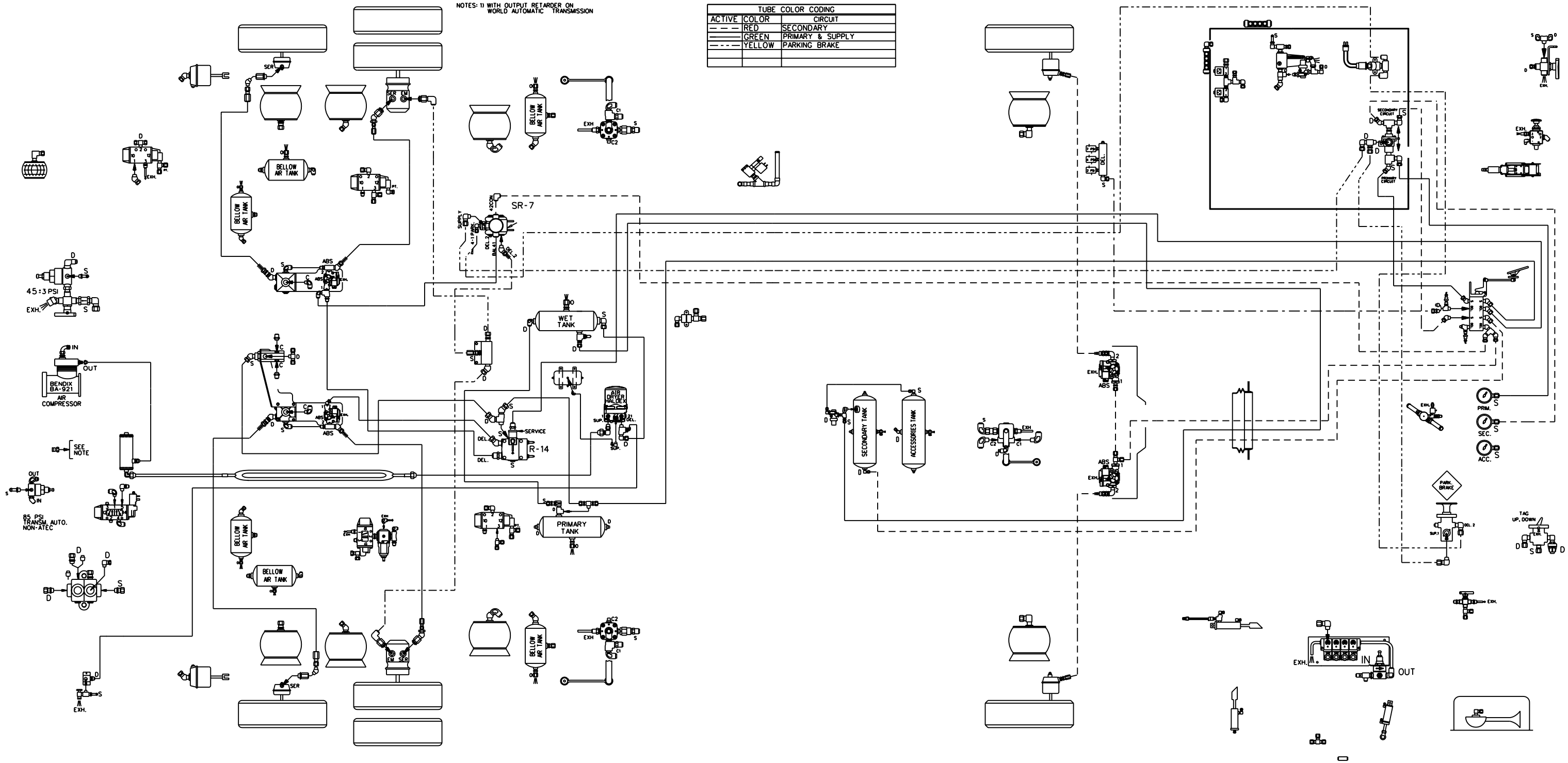

**PREVOST**

DESCRIPTION:

X3-45 COACH WITH FRONT I-BEAM AXLE  
BRAKES SYSTEM

EFF. W/ VEH : #8-9282...

PAGE:

D140331 P1.3

DATE: 2007/05

REV.: D

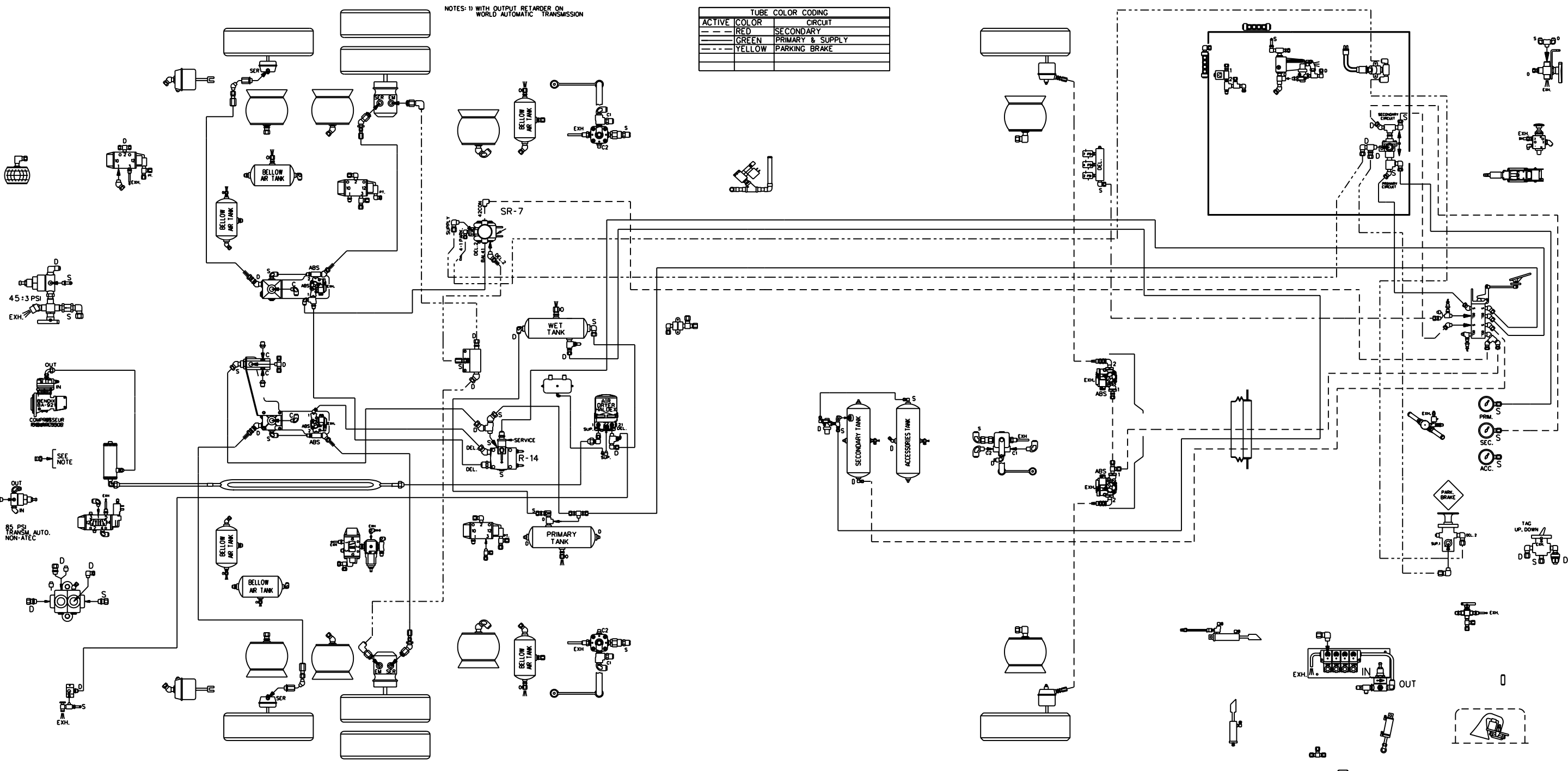

TUBE COLOR CODING		
ACTIVE	COLOR	CIRCUIT
---	RED	SECONDARY
---	GREEN	PRIMARY & SUPPLY
---	YELLOW	PARKING BRAKE

NOTES: 1) WITH OUTPUT RETARDER ON WORLD AUTOMATIC TRANSMISSION

**PREVOST**

DESCRIPTION: X3-45 COACH WITH FRONT I-BEAM AXLE BRAKES SYSTEM

EFF. W/ VEH : #8-9422...  
 DATE: 2008/03 REV.: F

PAGE: D140331 P1.3

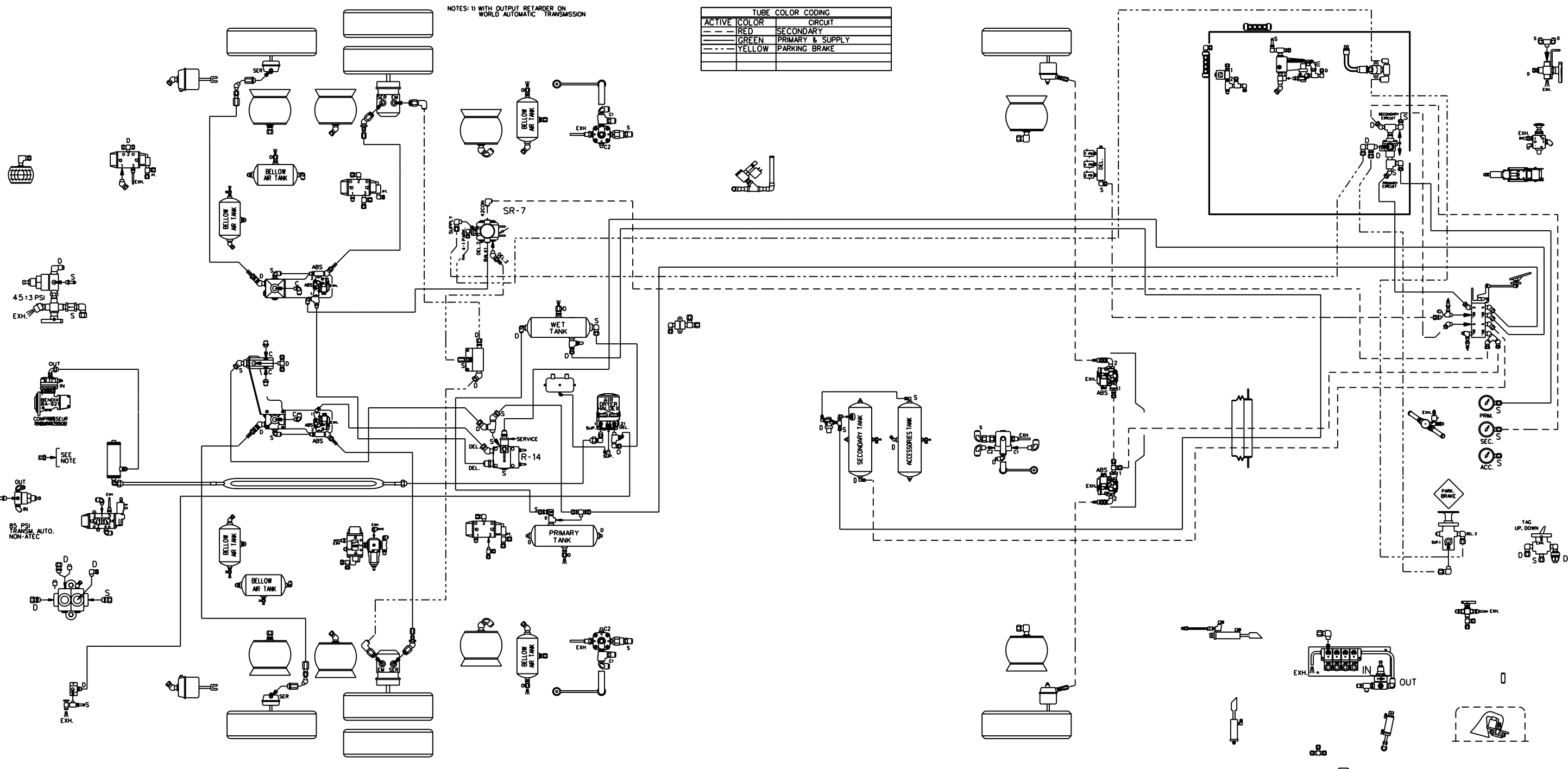

**PREVOST.**

DESCRIPTION:

X3-45 COACH WITH FRONT I-BEAM AXLE BRAKES SYSTEM

EFF. W/ VEH : #8-9430

PAGE:

DATE: 2008/04

REV.: G

D140331 P1.3

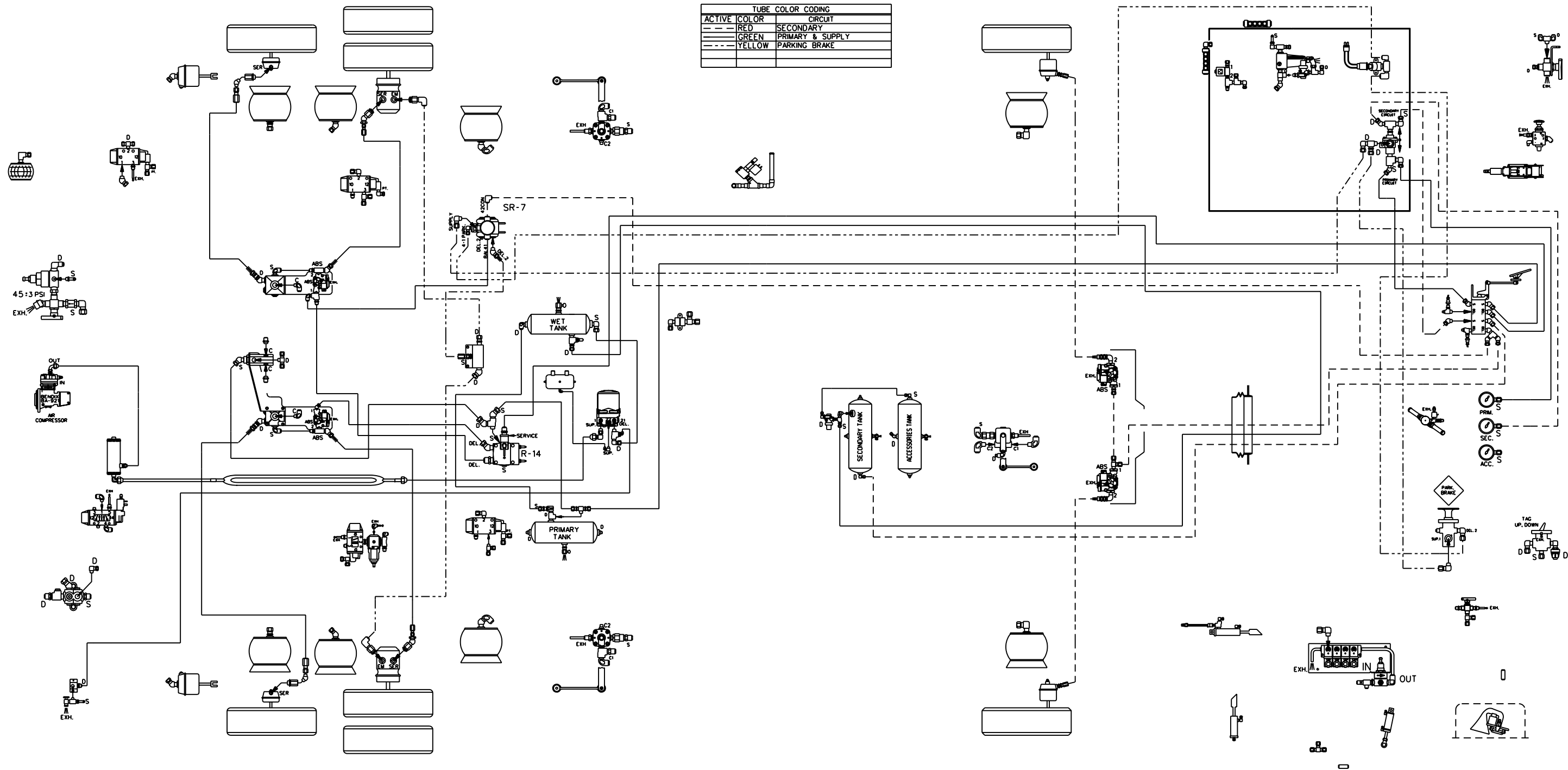

**PREVOST.**

DESCRIPTION:

X3-45 COACH WITH FRONT I-BEAM AXLE  
BRAKES SYSTEM

EFF. W/ VEH : #9-9599...

PAGE:

DATE: 2008/07

REV.: H

D140331 P1.3

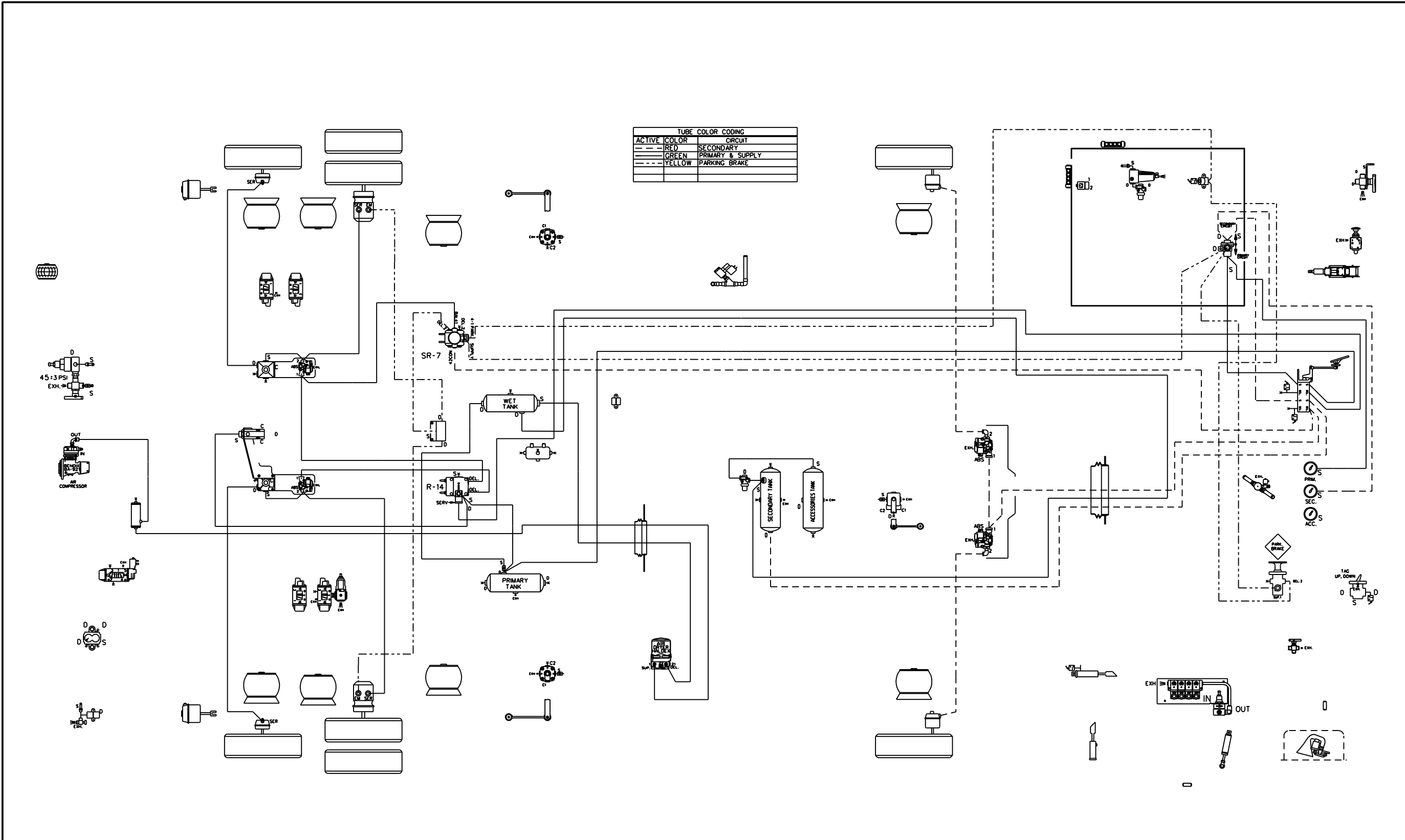

**PREVOST®**

DESCRIPTION:

X3-45 COACH WITH FRONT I-BEAM AXLE  
BRAKES SYSTEM

EFF. W/ VEH : #A-9953

PAGE:

D140331 P1.3

DATE: 2010/04

REV.: i

NOTES: 1) WITH OUTPUT RETARDER ON  
WORLD AUTOMATIC TRANSMISSION

TUBE COLOR CODING	
ACTIVE COLOR	CIRCUIT
---	BLUE STANDARD SUSPENSION

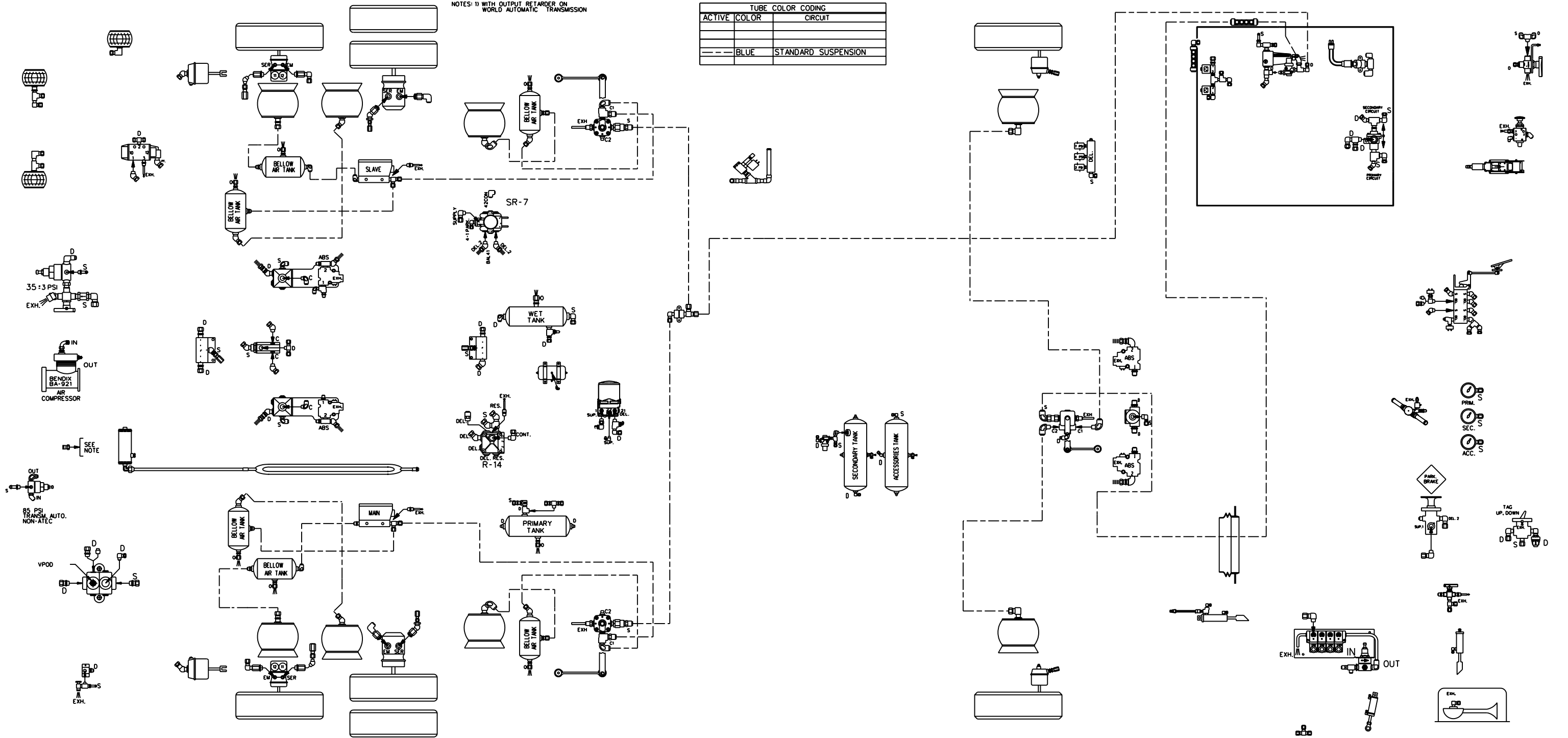

**PREVOST**

DESCRIPTION:

X3-45 COACH WITH FRONT I-BEAM AXLE  
STANDARD SUSPENSION

EFF. W/ VEH :

#7-8938...

PAGE:

D140331 P1.4

DATE:  
2006/03

REV.:  
A



NOTES: 1) WITH OUTPUT RETARDER ON WORLD AUTOMATIC TRANSMISSION

TUBE COLOR CODING	
ACTIVE COLOR	CIRCUIT
---	BLUE
---	STANDARD SUSPENSION

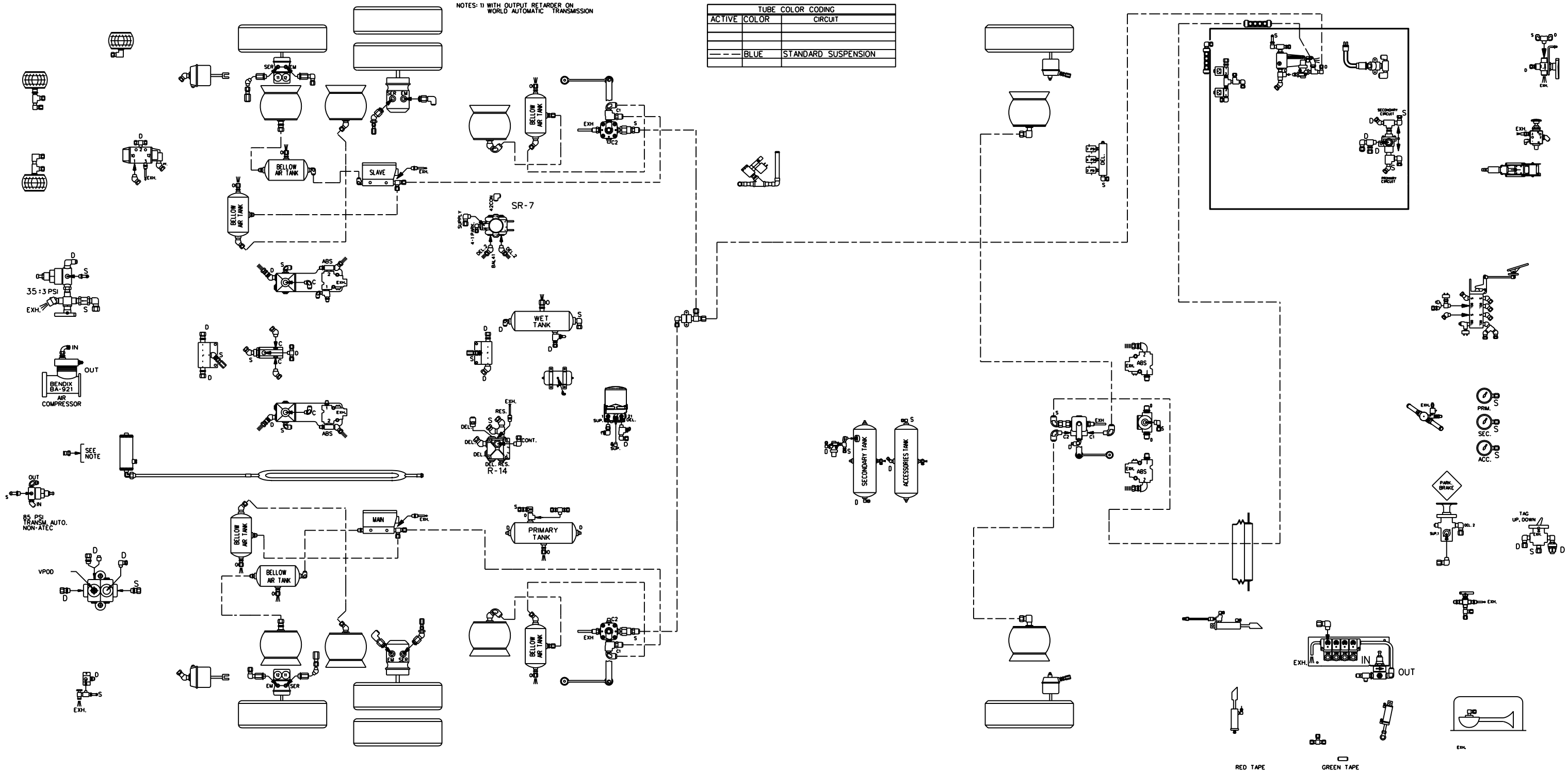

**PREVOST**

DESCRIPTION:

X3-45 COACH WITH FRONT I-BEAM AXLE  
STANDARD SUSPENSION

EFF. W/ VEH :

#7-9035...

PAGE:

D140331 P1.4

DATE:

2006/08

REV.:

B

NOTES: 1) WITH OUTPUT RETARDER ON  
WORLD AUTOMATIC TRANSMISSION

TUBE COLOR CODING		
ACTIVE	COLOR	CIRCUIT
---	BLUE	STANDARD SUSPENSION

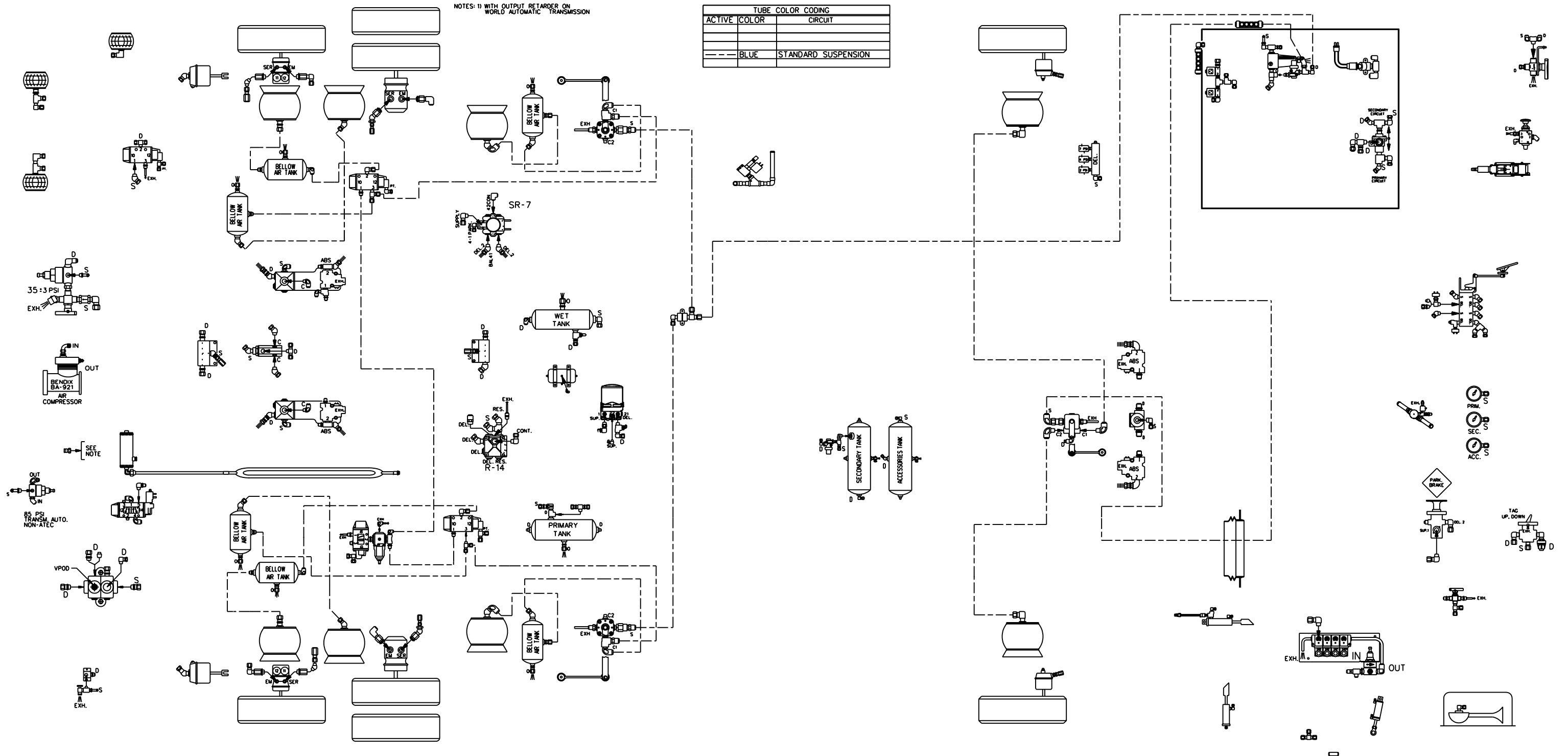

**PREVOST®**

DESCRIPTION:

X3-45 COACH WITH FRONT I-BEAM AXLE  
STANDARD SUSPENSION

EFF. W/ VEH : #8-9226...

PAGE:

DATE: 2007/04

REV.: C

D140331 P1.4

NOTES: 1) WITH OUTPUT RETARDER ON WORLD AUTOMATIC TRANSMISSION

TUBE COLOR CODING	
ACTIVE COLOR	CIRCUIT
---	BLUE
---	STANDARD SUSPENSION

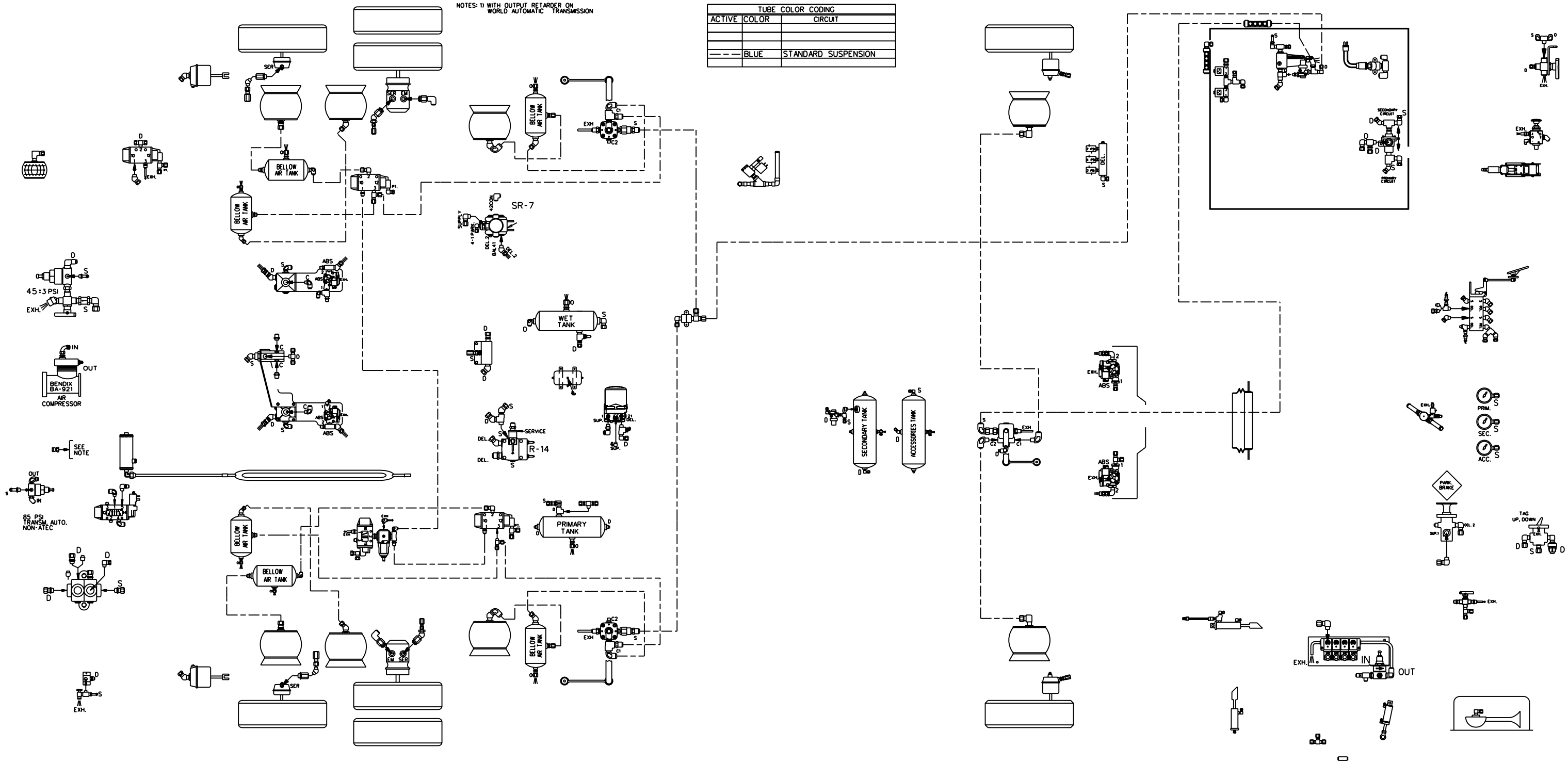

**PREVOST**

DESCRIPTION: X3-45 COACH WITH FRONT I-BEAM AXLE  
STANDARD SUSPENSION

EFF. W/ VEH : #8-9282...

PAGE:

DATE: 2007/05

REV.: D

D140331 P1.4

NOTES: 1) WITH OUTPUT RETARDER ON WORLD AUTOMATIC TRANSMISSION

TUBE COLOR CODING		
ACTIVE	COLOR	CIRCUIT
---	BLUE	STANDARD SUSPENSION

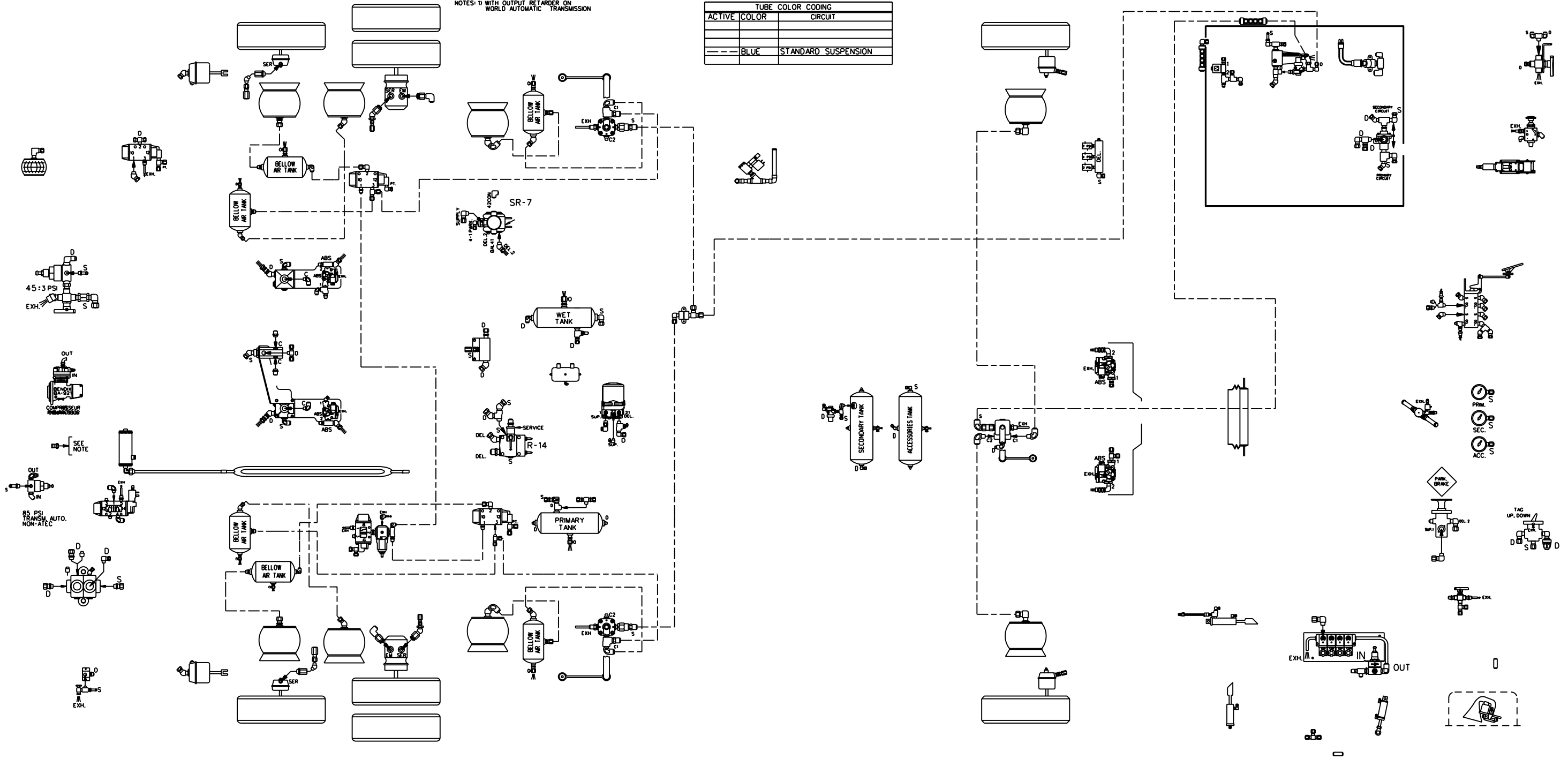

**PREVOST.**

DESCRIPTION:

X3-45 COACH WITH FRONT I-BEAM AXLE  
STANDARD SUSPENSION

EFF. W/ VEH : #8-9422...

PAGE:

DATE: 2008/03

REV.: F

D140331 P1.4

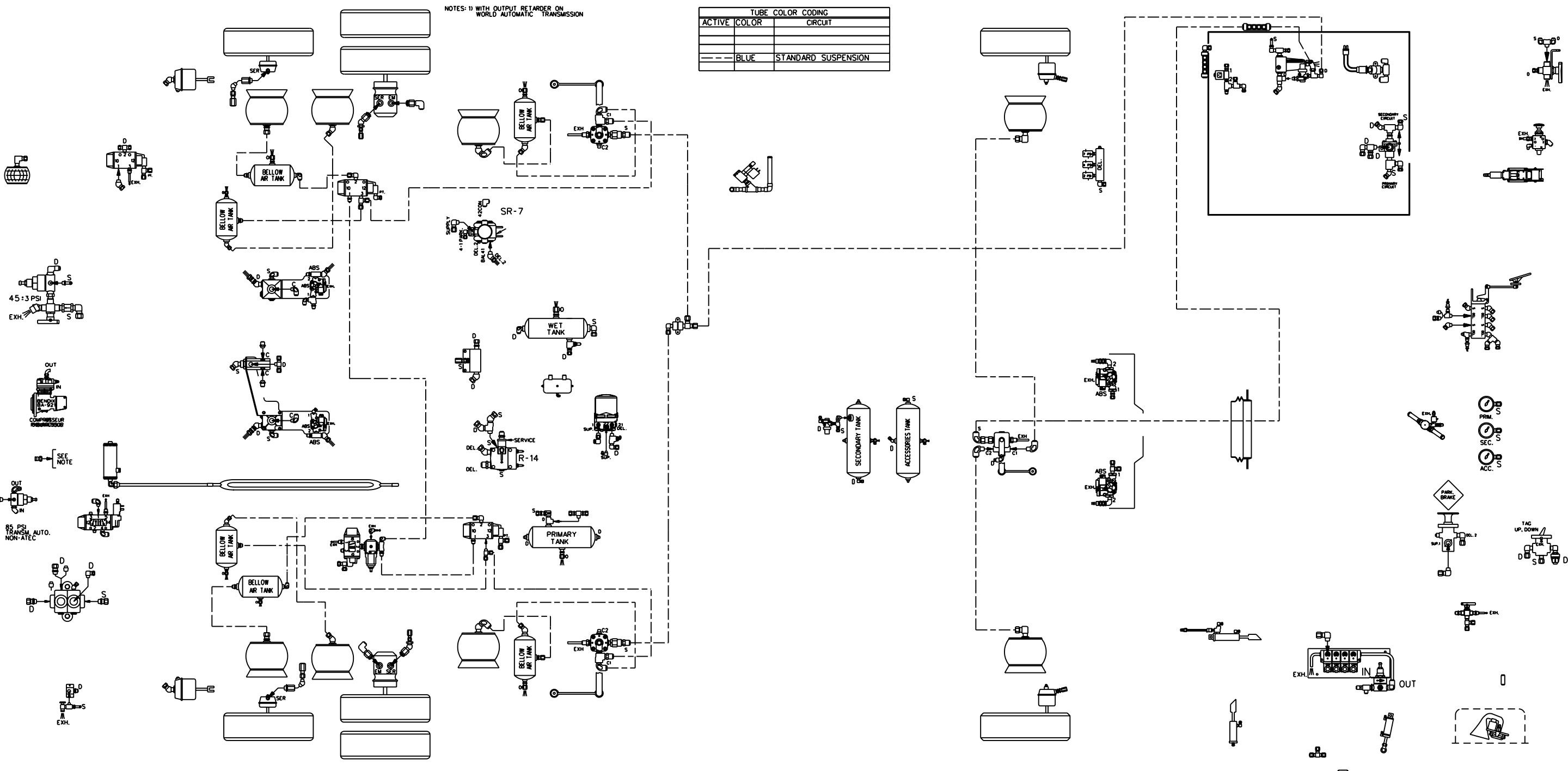

NOTES: 1) WITH OUTPUT RETARDER ON WORLD AUTOMATIC TRANSMISSION

TUBE COLOR CODING		
ACTIVE	COLOR	CIRCUIT
---	BLUE	STANDARD SUSPENSION

**PREVOST**

DESCRIPTION: X3-45 COACH WITH FRONT I-BEAM AXLE STANDARD SUSPENSION

EFF. W/ VEH : #8-9430  
 DATE: 2008/04 REV.: G

PAGE: D140331 P1.4

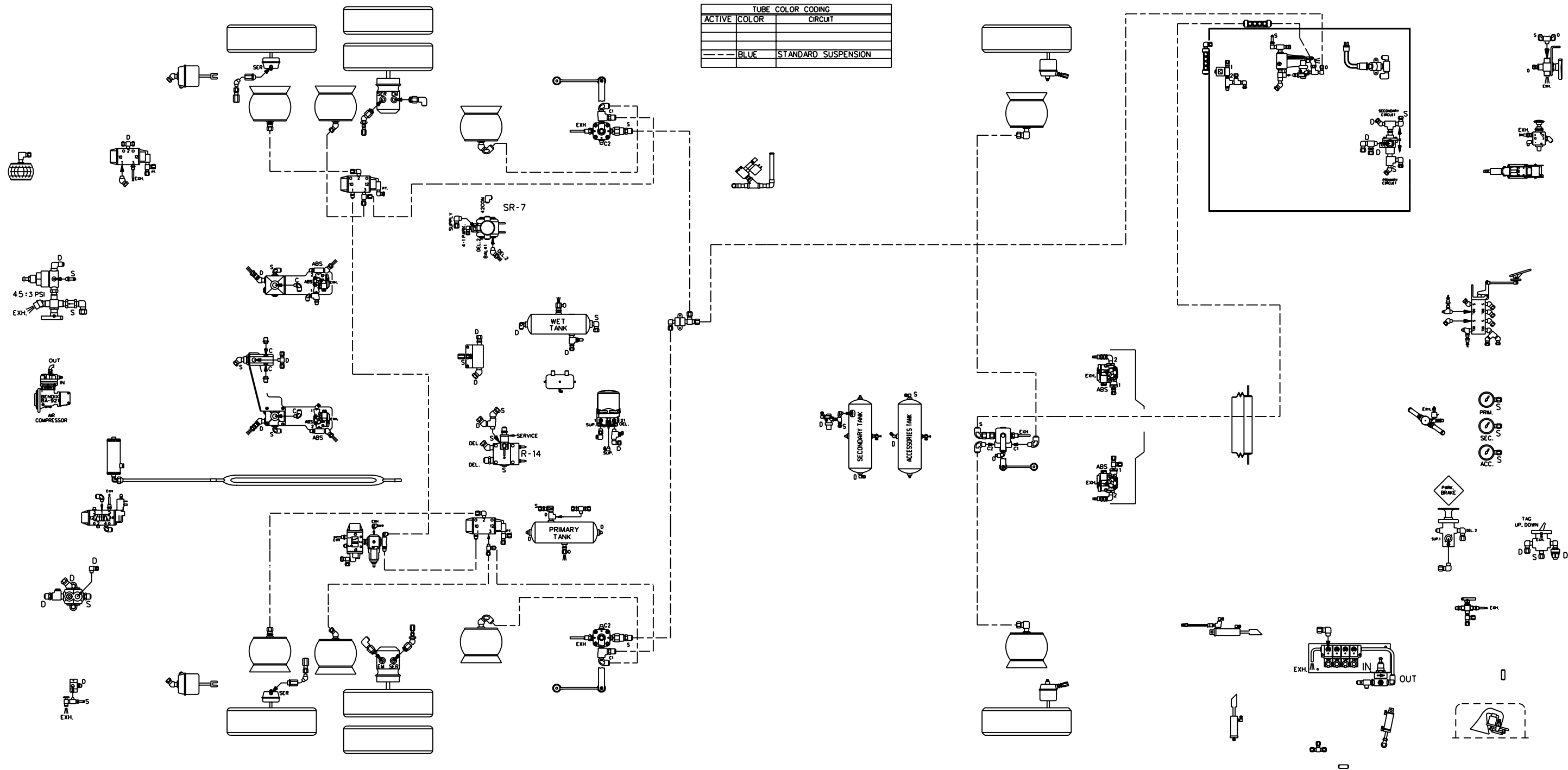

**PREVOST.**

DESCRIPTION:

X3-45 COACH WITH FRONT I-BEAM AXLE  
STANDARD SUSPENSION

EFF. W/ VEH : #9-9599...

PAGE:

DATE: 2008/07

REV.: H

D140331 P1.4

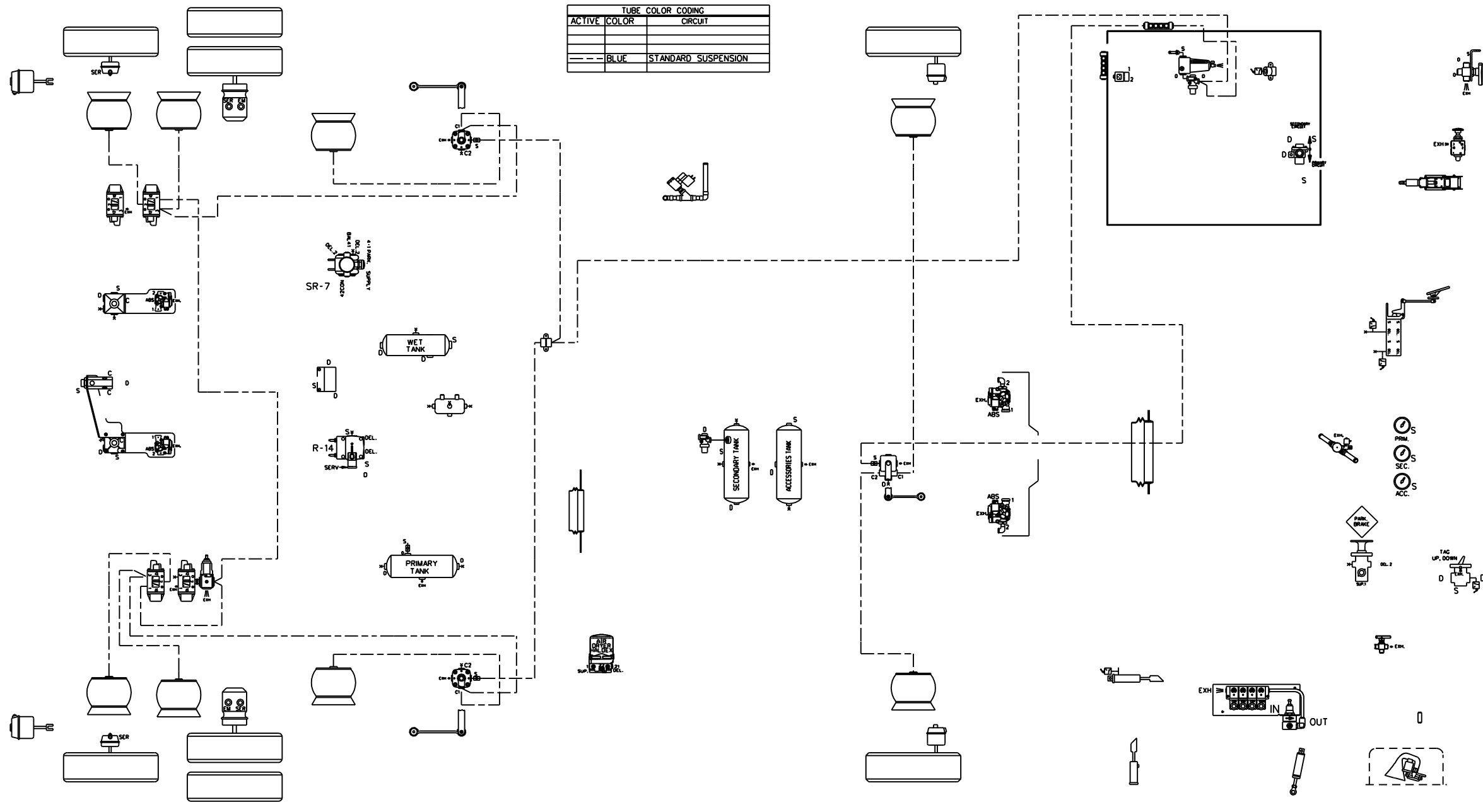
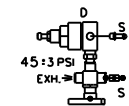

TUBE COLOR CODING	
ACTIVE COLOR	CIRCUIT
---	BLUE
---	STANDARD SUSPENSION

**PREVOST®**

DESCRIPTION: X3-45 COACH WITH FRONT I-BEAM AXLE  
STANDARD SUSPENSION

EFF. W/ VEH : #A-9953  
DATE: 2010/04 REV.: i

PAGE: D140331 P1.4

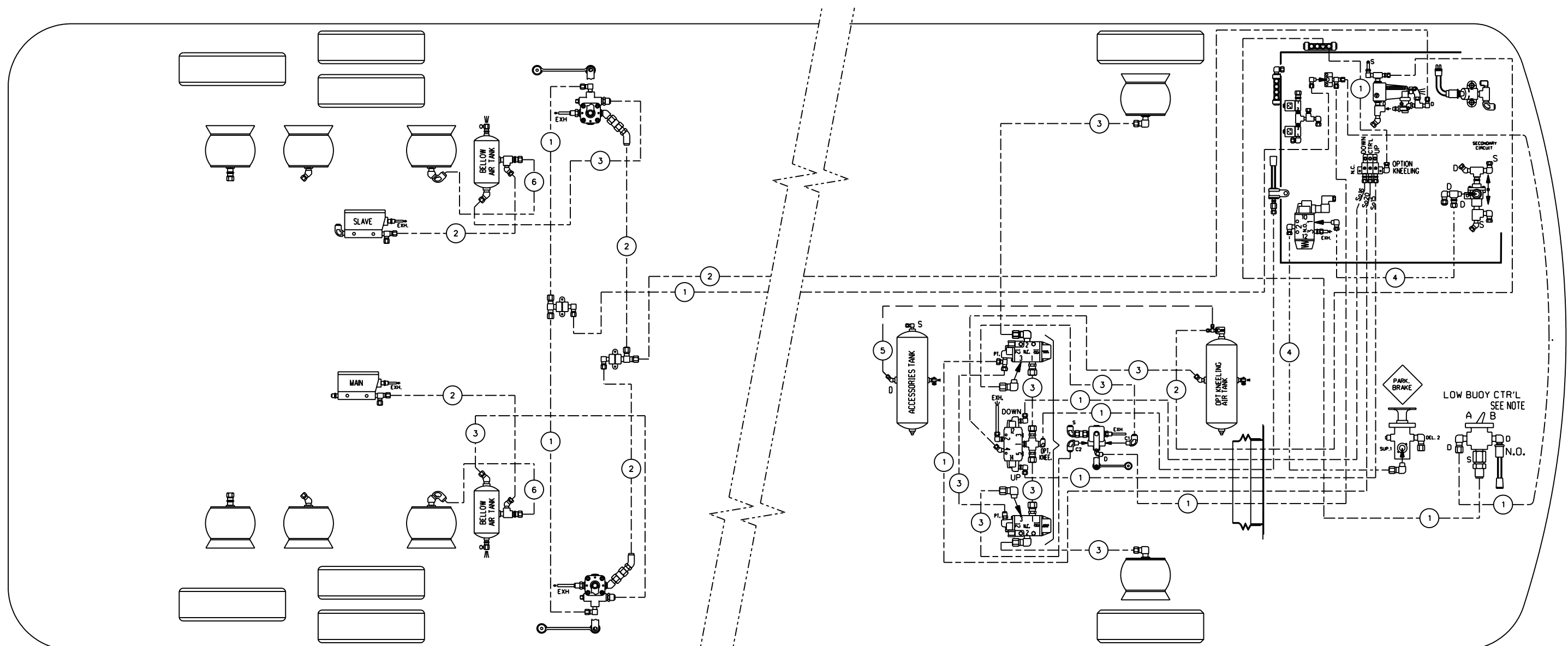

KNEELING SYSTEM = UP (CTR'L + UP ENERGIZED)  
 DOWN (CTR'L + DOWN ENERGIZED)

BALLOON	PIPE
*1	1/4" O.D. BLUE
*2	3/8" O.D. BLUE
*3	1/2" O.D. BLUE
*4	3/8" O.D. YELLOW
*5	3/8" O.D. BLACK
*6	3/4" O.D. BLACK

TUBE COLOR CODING		
LINE TYPE	COLOR	CIRCUIT
---	BLUE	SUSPENSION
---	BLACK	ACCESSORIES
---	YELLOW	PARKING BRAKES

NOTE:  
 CONTROL VALVE OPT. "LOW-BUOY" , "A" OR "B" SETTING:  
POSITION "A": VALVE IS OPEN,  
 AIR FLOW BETWEEN SUPPLY (S) AND  
 DELIVERY (D) , LOW-BUOY IS IN FUNCTION.  
  
POSITION "B": VALVE CLOSED,  
 AIR DOES'NT FLOW BETWEEN SUPPLY (S) AND  
 DELIVERY (D) , LOW-BUOY IS NOT IN FUNCTION.

**PREVOST®**

DESCRIPTION:  
 X3-45 COACH, WITH FRONT BEAM AXLE  
 WITH OPTION FRONT KNEELING & LOW-BUOY COMBINATION

EFF. W/VEH : TO FOLLOW  
 DATE: 2006/03  
 REV.: A

PAGE:  
 D140331 P2.1



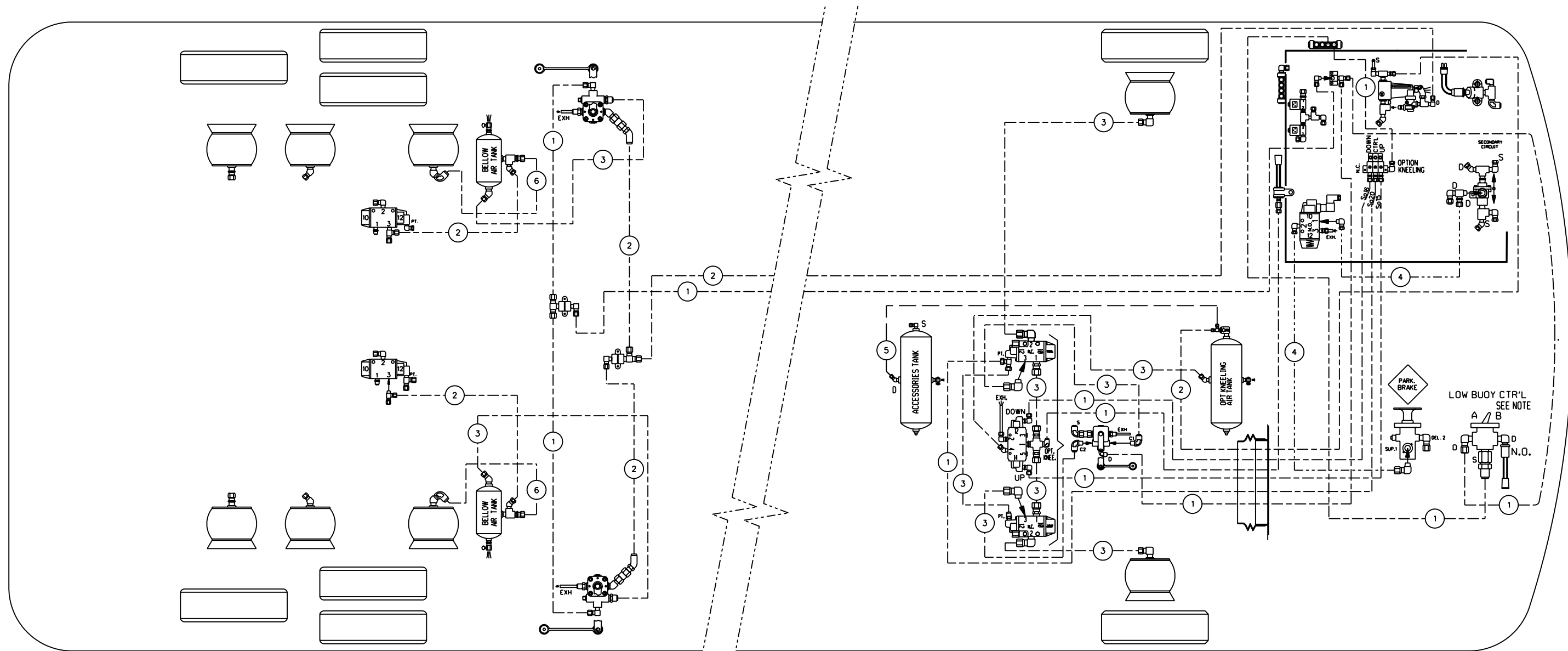

KNEELING SYSTEM = UP (CTR'L + UP ENERGIZED)  
DOWN (CTR'L + DOWN ENERGIZED)

BALLOON	PIPE
*1	1/4" O.D. BLUE
*2	3/8" O.D. BLUE
*3	1/2" O.D. BLUE
*4	3/8" O.D. YELLOW
*5	3/8" O.D. BLACK
*6	3/4" O.D. BLACK

TUBE COLOR CODING		
LINE TYPE	COLOR	CIRCUIT
---	BLUE	SUSPENSION
---	BLACK	ACCESSORIES
---	YELLOW	PARKING BRAKES

NOTE:

CONTROL VALVE OPT. "LOW-BUOY" , "A" OR "B" SETTING:

POSITION "A": VALVE IS OPEN,  
AIR FLOW BETWEEN SUPPLY (S) AND  
DELIVERY (D) , LOW-BUOY IS IN FUNCTION.

POSITION "B": VALVE CLOSED,  
AIR DOES'NT FLOW BETWEEN SUPPLY (S) AND  
DELIVERY (D) , LOW-BUOY IS NOT IN FUNCTION.

**PREVOST**®

DESCRIPTION:

X3-45 COACH, WITH FRONT BEAM AXLE  
WITH OPTION FRONT KNEELING & LOW-BUOY COMBINATION

EFF. W/VEH :

#8-9226...

PAGE:

D140331 P2.1

DATE:

2007/04

REV.:

B

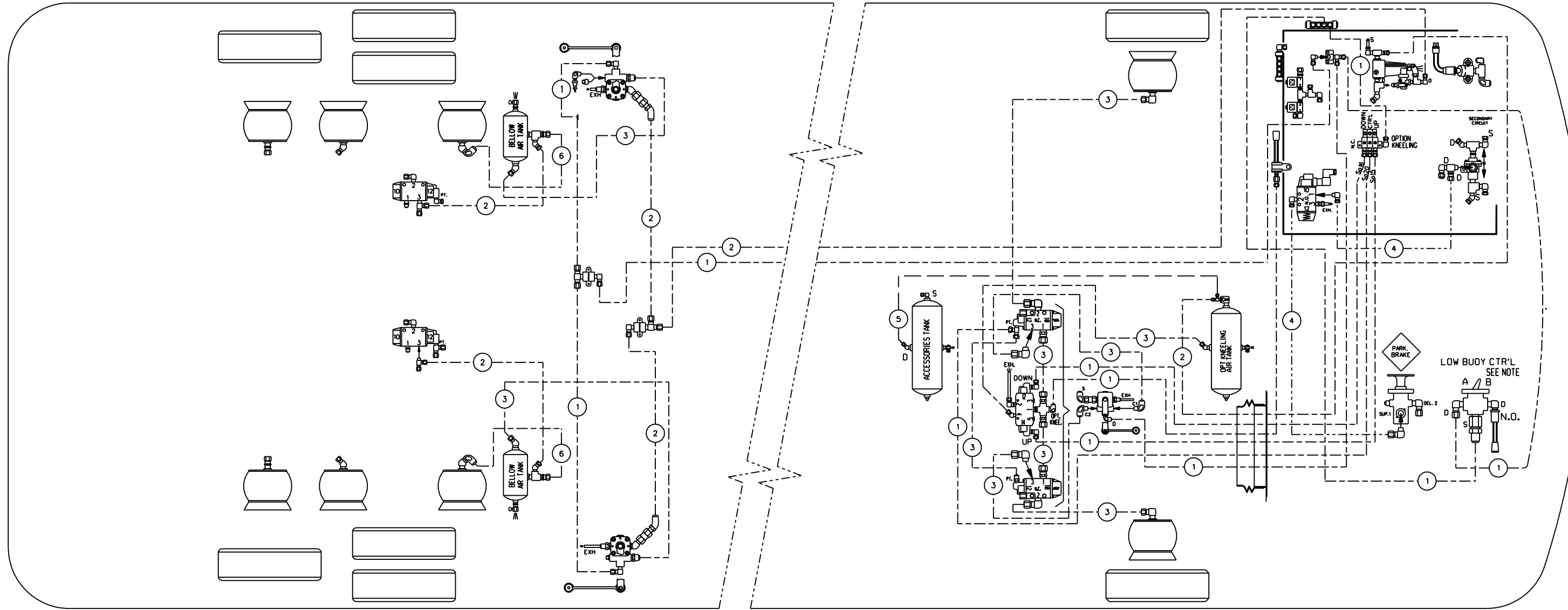

BALLOON	PIPE
*1	1/4" O.D. BLUE
*2	3/8" O.D. BLUE
*3	1/2" O.D. BLUE
*4	3/8" O.D. YELLOW
*5	3/8" O.D. BLACK
*6	3/4" O.D. BLACK

TUBE COLOR CODING		
LINE TYPE	COLOR	CIRCUIT
---	BLUE	SUSPENSION
---	BLACK	ACCESSORIES
---	YELLOW	PARKING BRAKES

**NOTE:**

CONTROL VALVE OPT. "LOW-BUOY" , "A" OR "B" SETTING:

POSITION "A": VALVE IS OPEN,  
AIR FLOW BETWEEN SUPPLY (S) AND  
DELIVERY (D) , LOW-BUOY IS IN FUNCTION.

POSITION "B": VALVE CLOSED,  
AIR DOES'NT FLOW BETWEEN SUPPLY (S) AND  
DELIVERY (D) , LOW-BUOY IS NOT IN FUNCTION.

**PREVOST®**

DESCRIPTION:

X3-45 COACH, WITH FRONT BEAM AXLE  
WITH OPTION FRONT KNEELING & LOW-BUOY COMBINATION

EFF. W/VEH :

#8-9282...

PAGE:

D140331 P2.1

DATE:

2007/05

REV.:

C

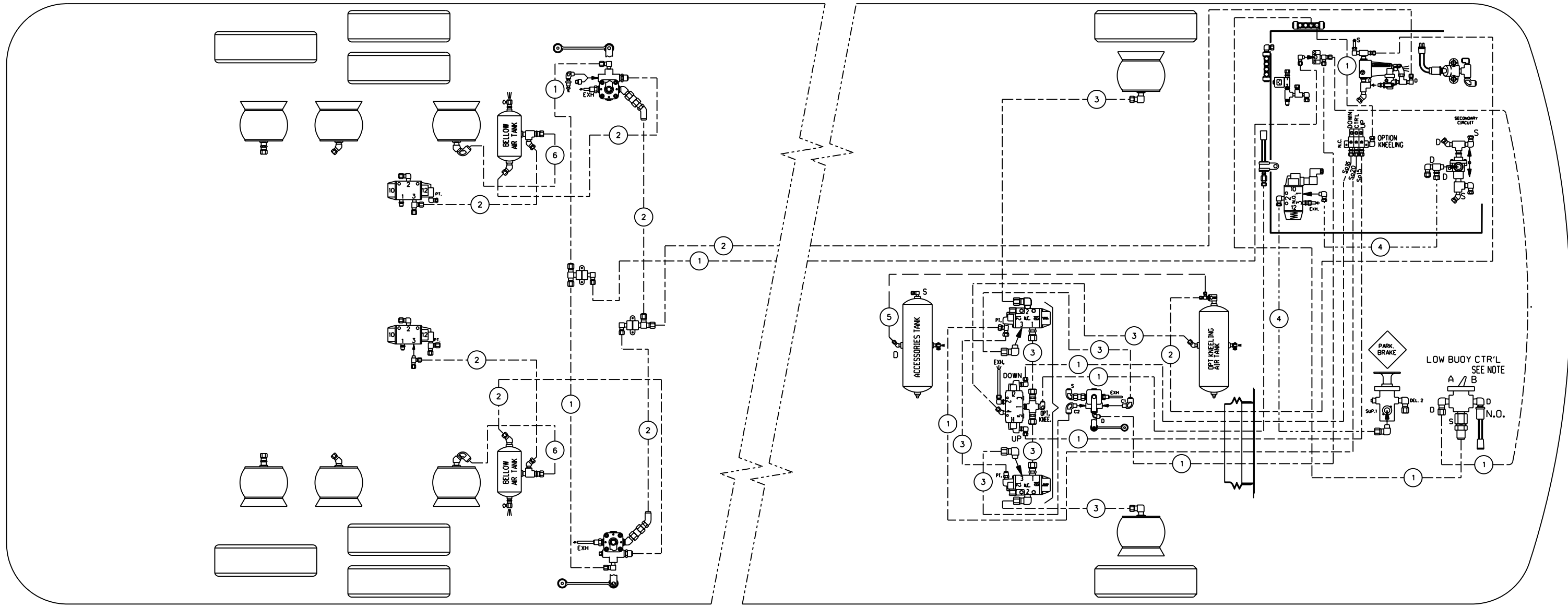

BALLOON	PIPE
*1	1/4" O.D. BLUE
*2	3/8" O.D. BLUE
*3	1/2" O.D. BLUE
*4	3/8" O.D. YELLOW
*5	3/8" O.D. BLACK
*6	3/4" O.D. BLACK

TUBE COLOR CODING		
LINE TYPE	COLOR	CIRCUIT
---	BLUE	SUSPENSION
---	BLACK	ACCESSORIES
---	YELLOW	PARKING BRAKES

**NOTE:**

CONTROL VALVE OPT. "LOW-BUOY" , "A" OR "B" SETTING:

POSITION "A": VALVE IS OPEN,  
AIR FLOW BETWEEN SUPPLY (S) AND  
DELIVERY (D) , LOW-BUOY IS IN FUNCTION.

POSITION "B": VALVE CLOSED,  
AIR DOES'NT FLOW BETWEEN SUPPLY (S) AND  
DELIVERY (D) , LOW-BUOY IS NOT IN FUNCTION.

**PREVOST**®

DESCRIPTION:  
X3-45 COACH, WITH FRONT BEAM AXLE  
WITH OPTION FRONT KNEELING & LOW-BUOY COMBINATION

EFF. W/VEH : #8-9430

PAGE:  
D140331 P2.1

DATE: 2008/04 REV.: D

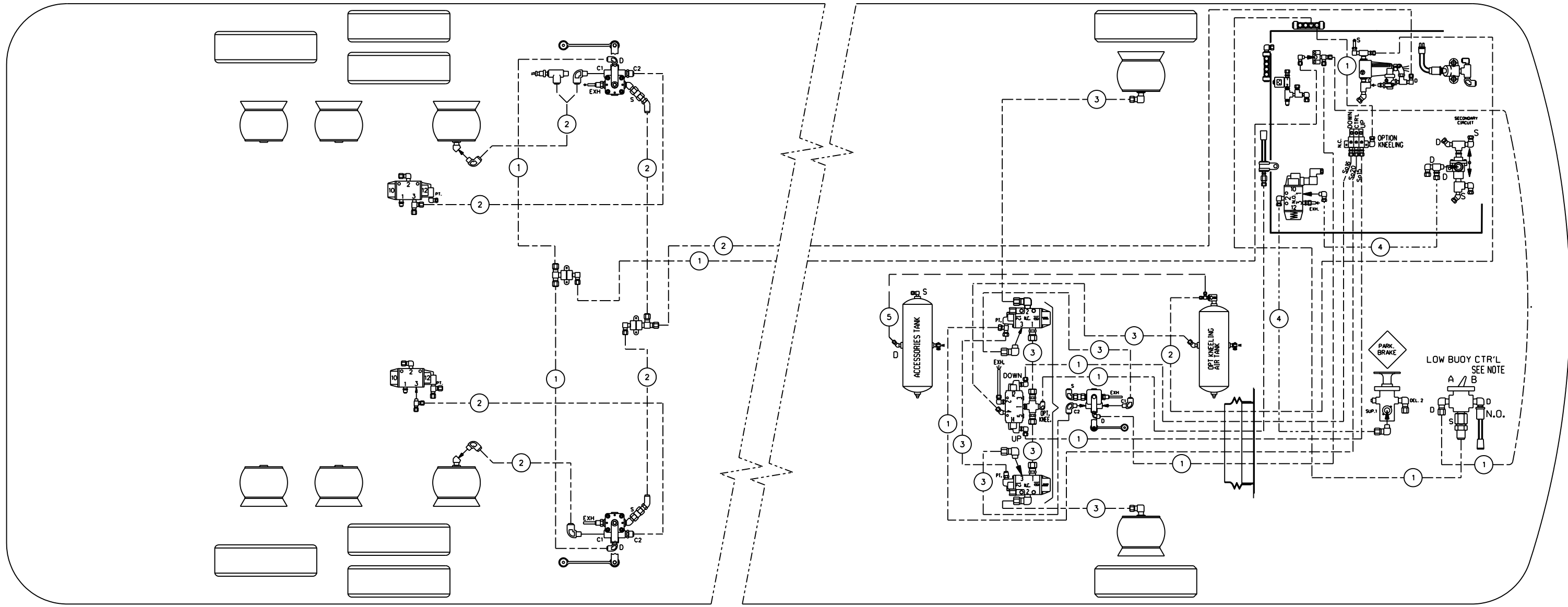

BALLOON	PIPE
*1	1/4" O.D. BLUE
*2	3/8" O.D. BLUE
*3	1/2" O.D. BLUE
*4	3/8" O.D. YELLOW
*5	3/8" O.D. BLACK
*6	3/4" O.D. BLACK

TUBE COLOR CODING		
LINE TYPE	COLOR	CIRCUIT
---	BLUE	SUSPENSION
---	BLACK	ACCESSORIES
---	YELLOW	PARKING BRAKES

**NOTE:**

CONTROL VALVE OPT. "LOW-BUOY" , "A" OR "B" SETTING:

POSITION "A": VALVE IS OPEN,  
AIR FLOW BETWEEN SUPPLY (S) AND  
DELIVERY (D) , LOW-BUOY IS IN FUNCTION.

POSITION "B": VALVE CLOSED,  
AIR DOES'NT FLOW BETWEEN SUPPLY (S) AND  
DELIVERY (D) , LOW-BUOY IS NOT IN FUNCTION.

**PREVOST®**

DESCRIPTION:

X3-45 COACH, WITH FRONT BEAM AXLE  
WITH OPTION FRONT KNEELING & LOW-BUOY COMBINATION

EFF. W/VEH : #9-9599...

PAGE:

DATE: 2008/07

REV.: E

D140331 P2.1

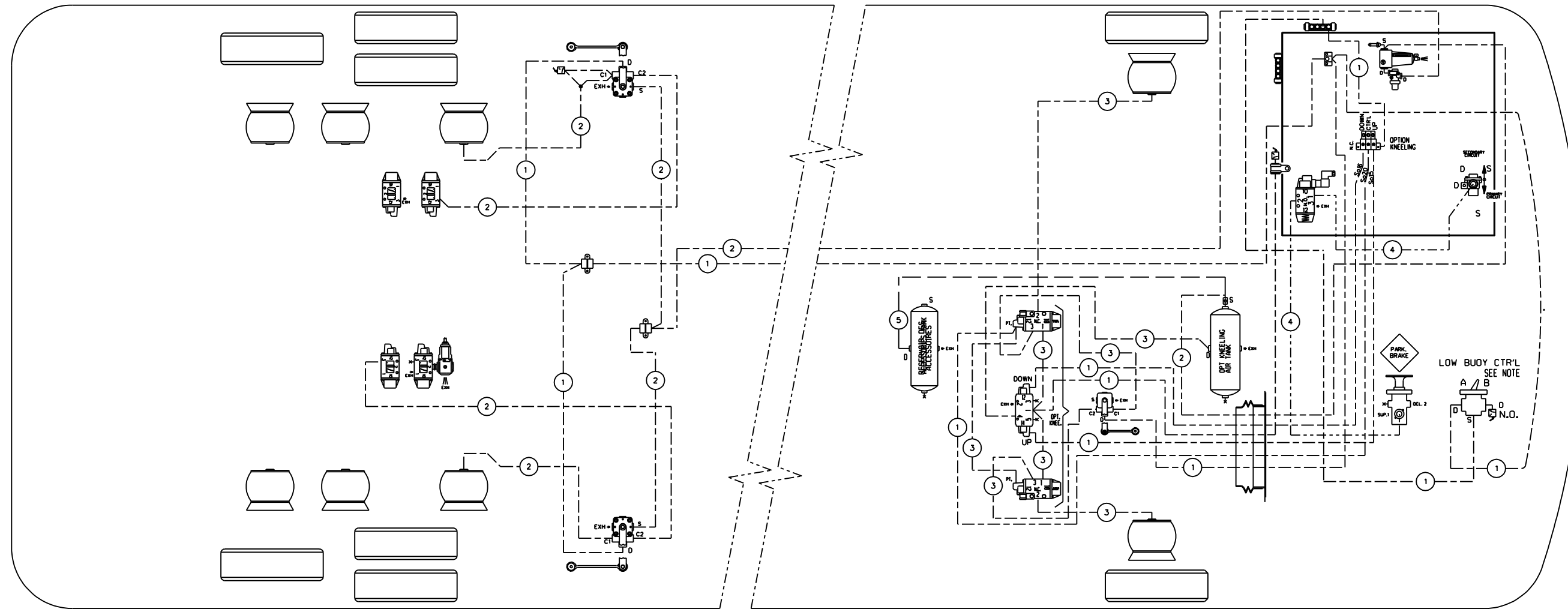

BALLOON	PIPE
*1	1/4" O.D. BLUE
*2	3/8" O.D. BLUE
*3	1/2" O.D. BLUE
*4	3/8" O.D. YELLOW
*5	3/8" O.D. BLACK
*6	3/4" O.D. BLACK

TUBE COLOR CODING		
LINE TYPE	COLOR	CIRCUIT
—————	BLUE	SUSPENSION
-----	BLACK	ACCESSORIES
.....	YELLOW	PARKING BRAKES

**NOTE:**  
CONTROL VALVE OPT. "LOW-BUOY" , "A" OR "B" SETTING:  
POSITION "A": VALVE IS OPEN,  
AIR FLOW BETWEEN SUPPLY (S) AND  
DELIVERY (D) , LOW-BUOY IS IN FUNCTION.  
  
POSITION "B": VALVE CLOSED,  
AIR DOES'NT FLOW BETWEEN SUPPLY (S) AND  
DELIVERY (D) , LOW-BUOY IS NOT IN FUNCTION.

**PREVOST®**

DESCRIPTION:  
X3-45 COACH, WITH FRONT BEAM AXLE  
WITH OPTION FRONT KNEELING & LOW-BUOY COMBINATION

EFF. W/VEH : #A-9953  
DATE: 2010/04 REV.: F

PAGE:  
D140331 P2.1



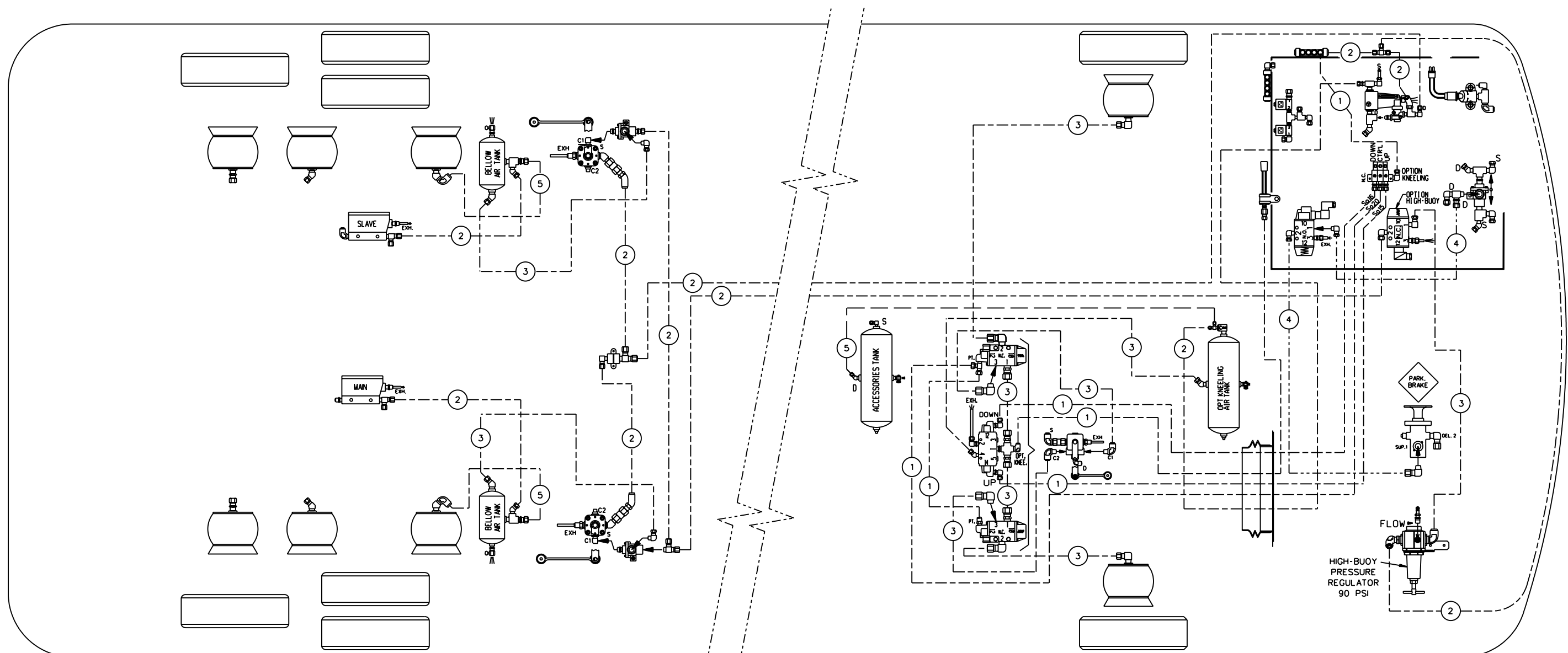

KNEELING SYSTEM = UP (CTR'L + UP ENERGIZED)  
 DOWN (CTR'L + DOWN ENERGIZED)

BALLOON	PIPE
*1	1/4" O.D. BLUE
*2	3/8" O.D. BLUE
*3	1/2" O.D. BLUE
*4	3/8" O.D. YELLOW
*5	3/4" O.D. BLACK

TUBE COLOR CODING		
LINE TYPE	COLOR	CIRCUIT
---	BLUE	SUSPENSION
---	YELLOW	PARKING BRAKES
---	BLACK	ACCESSORIES

**PREVOST**®

DESCRIPTION:  
 X3-45 COACH, WITH FRONT BEAM AXLE  
 WITH OPTION FRONT KNEELING & HIGH-BUOY COMBINATION

EFF. W/VEH : TO FOLLOW  
 DATE: 2006/03  
 REV.: A

PAGE:  
 D140331 P3.1

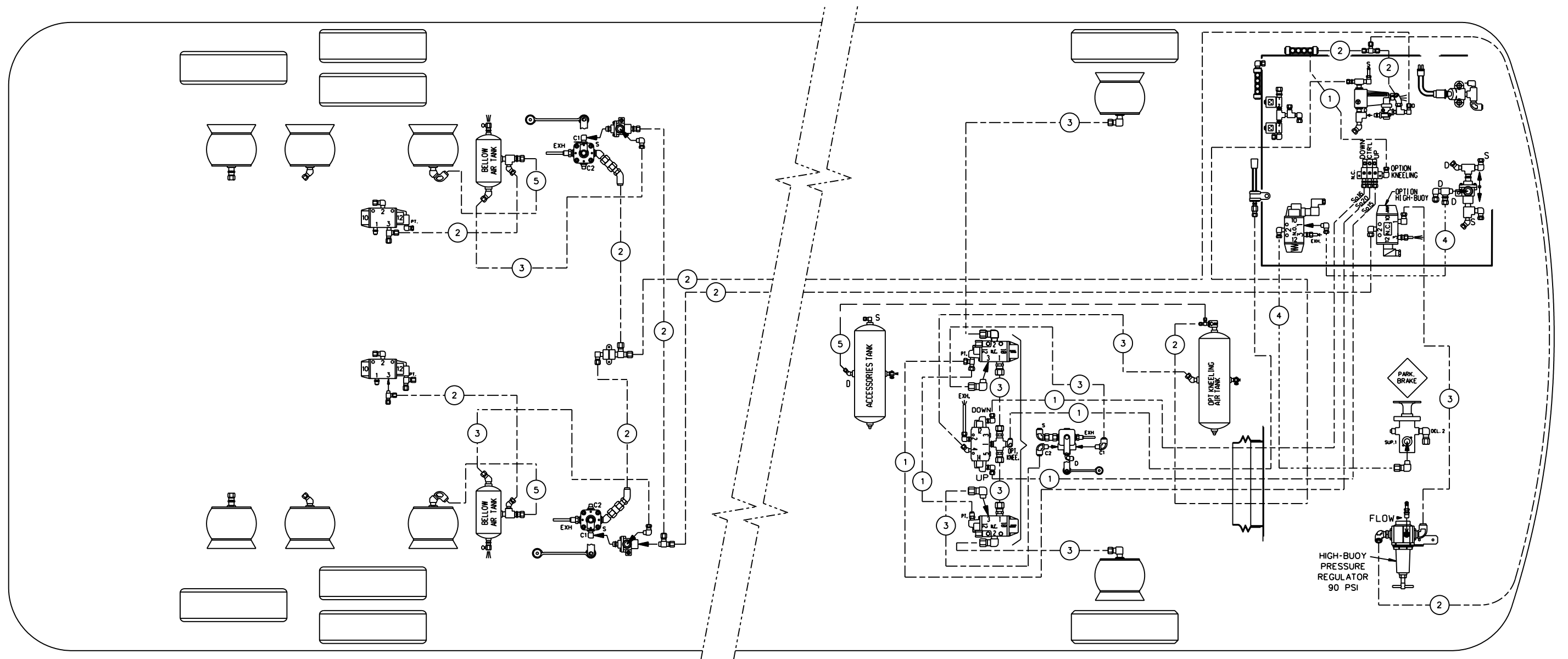

KNEELING SYSTEM = UP (CTR'L + UP ENERGIZED)  
 DOWN (CTR'L + DOWN ENERGIZED)

BALLOON	PIPE
#1	1/4" O.D. BLUE
#2	3/8" O.D. BLUE
#3	1/2" O.D. BLUE
#4	3/8" O.D. YELLOW
#5	3/4" O.D. BLACK

TUBE COLOR CODING		
LINE TYPE	COLOR	CIRCUIT
---	BLUE	SUSPENSION
- - - -	YELLOW	PARKING BRAKES
---	BLACK	ACCESSORIES

**PREVOST**®

DESCRIPTION:

X3-45 COACH, WITH FRONT BEAM AXLE  
 WITH OPTION FRONT KNEELING & HIGH-BUOY COMBINATION

EFF. W/VEH :

#8-9226...

PAGE:

D140331 P3.1

DATE:

2007/04

REV.:

B



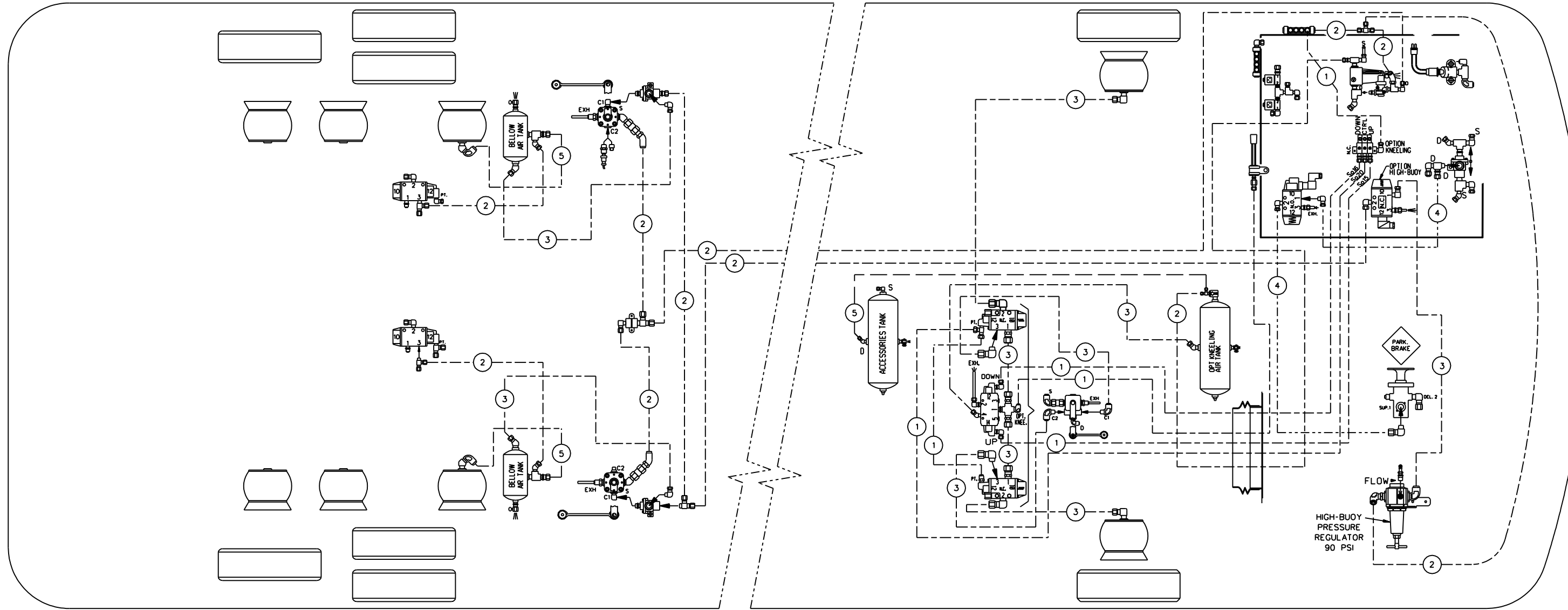

BALLOON	PIPE
*1	1/4" O.D. BLUE
*2	3/8" O.D. BLUE
*3	1/2" O.D. BLUE
*4	3/8" O.D. YELLOW
*5	3/4" O.D. BLACK

TUBE COLOR CODING		
LINE TYPE	COLOR	CIRCUIT
---	BLUE	SUSPENSION
---	YELLOW	PARKING BRAKES
---	BLACK	ACCESSORIES

**PREVOST**<sup>®</sup>

DESCRIPTION:  
 X3-45 COACH, WITH FRONT BEAM AXLE  
 WITH OPTION FRONT KNEELING & HIGH-BUOY COMBINATION

EFF. W/VEH : #8-9282...

PAGE:  
 D140331 P3.1

DATE: 2007/05

REV.: C

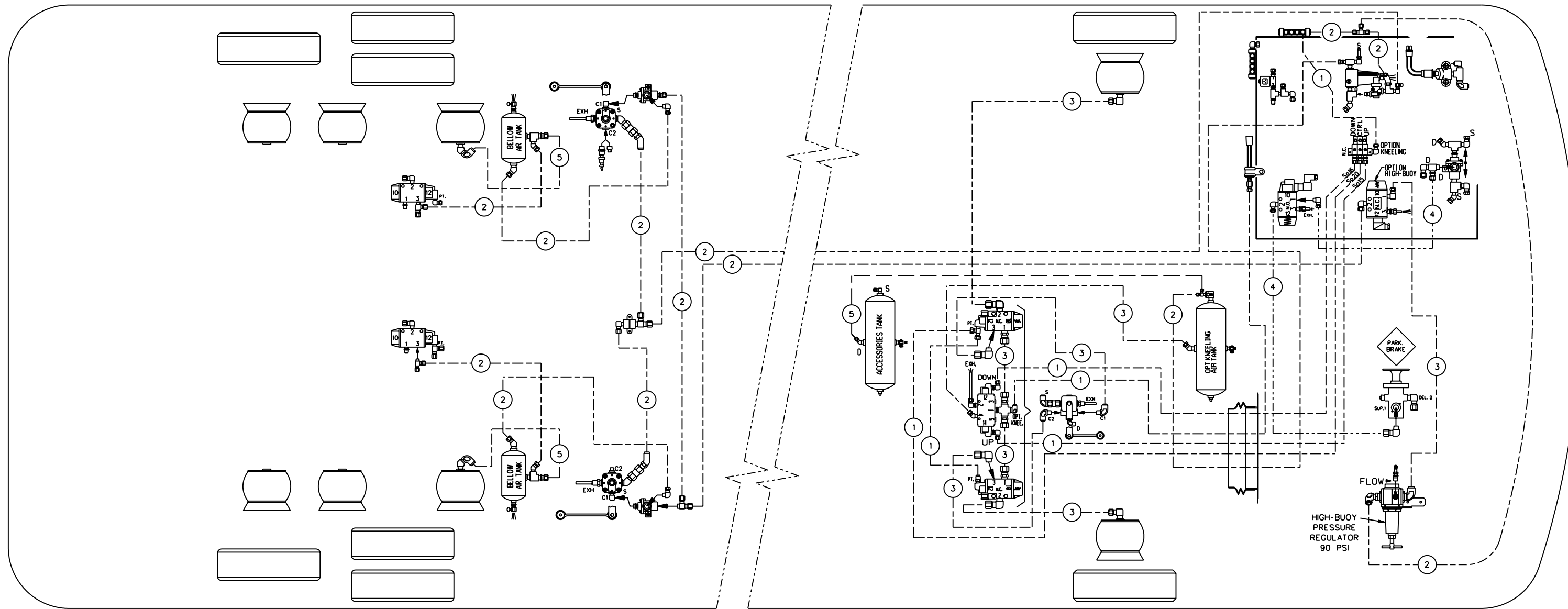

BALLOON	PIPE
#1	1/4" O.D. BLUE
#2	3/8" O.D. BLUE
#3	1/2" O.D. BLUE
#4	3/8" O.D. YELLOW
#5	3/4" O.D. BLACK

TUBE COLOR CODING		
LINE TYPE	COLOR	CIRCUIT
---	BLUE	SUSPENSION
---	YELLOW	PARKING BRAKES
---	BLACK	ACCESSORIES

**PREVOST**<sup>®</sup>

DESCRIPTION:

X3-45 COACH, WITH FRONT BEAM AXLE  
WITH OPTION FRONT KNEELING & HIGH-BUOY COMBINATION

EFF. W/VEH :

#8-9430

PAGE:

D140331 P3.1

DATE:

2008/04

REV.:

D

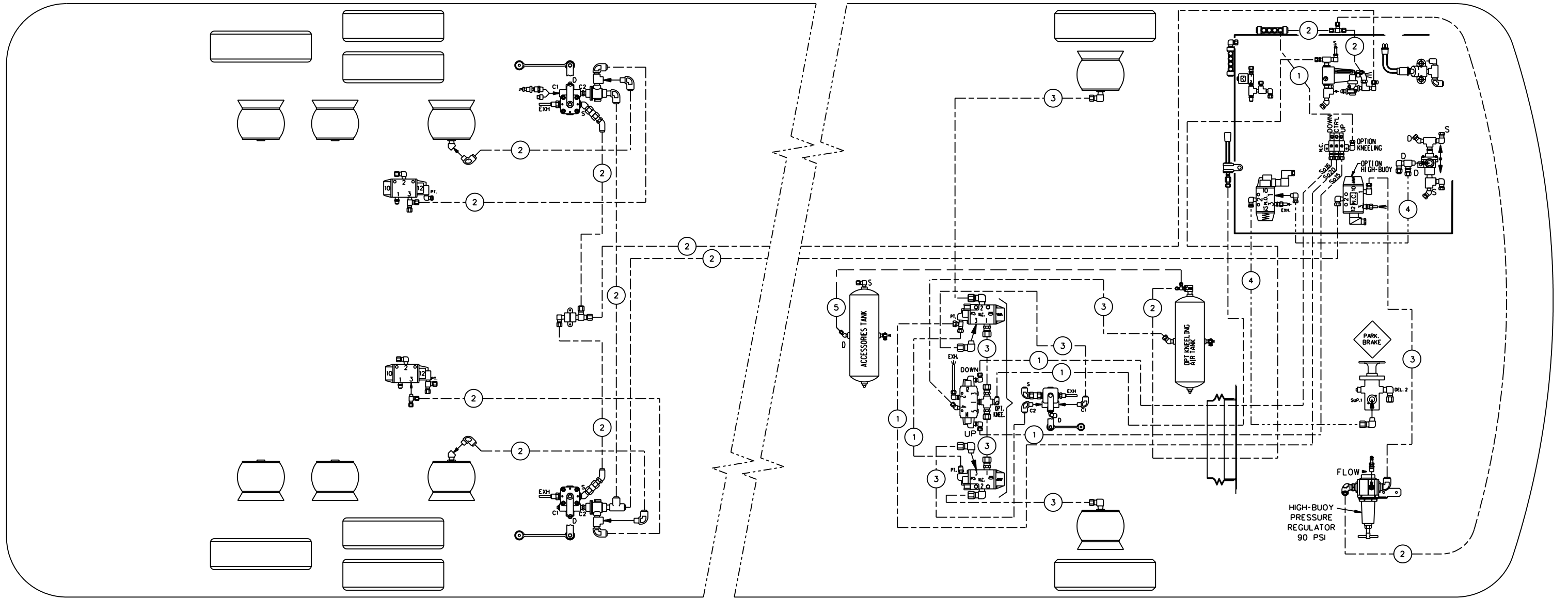

BALLOON	PIPE
*1	1/4" O.D. BLUE
*2	3/8" O.D. BLUE
*3	1/2" O.D. BLUE
*4	3/8" O.D. YELLOW

TUBE COLOR CODING		
LINE TYPE	COLOR	CIRCUIT
---	BLUE	SUSPENSION
---	YELLOW	PARKING BRAKES
---	BLACK	ACCESSORIES

**PREVOST**<sup>®</sup>

DESCRIPTION:  
 X3-45 COACH, WITH FRONT BEAM AXLE  
 WITH OPTION FRONT KNEELING & HIGH-BUOY COMBINATION

EFF. W/VEH : #9-9599...  
 DATE: 2008/07  
 REV.: E

PAGE:  
 D140331 P3.1

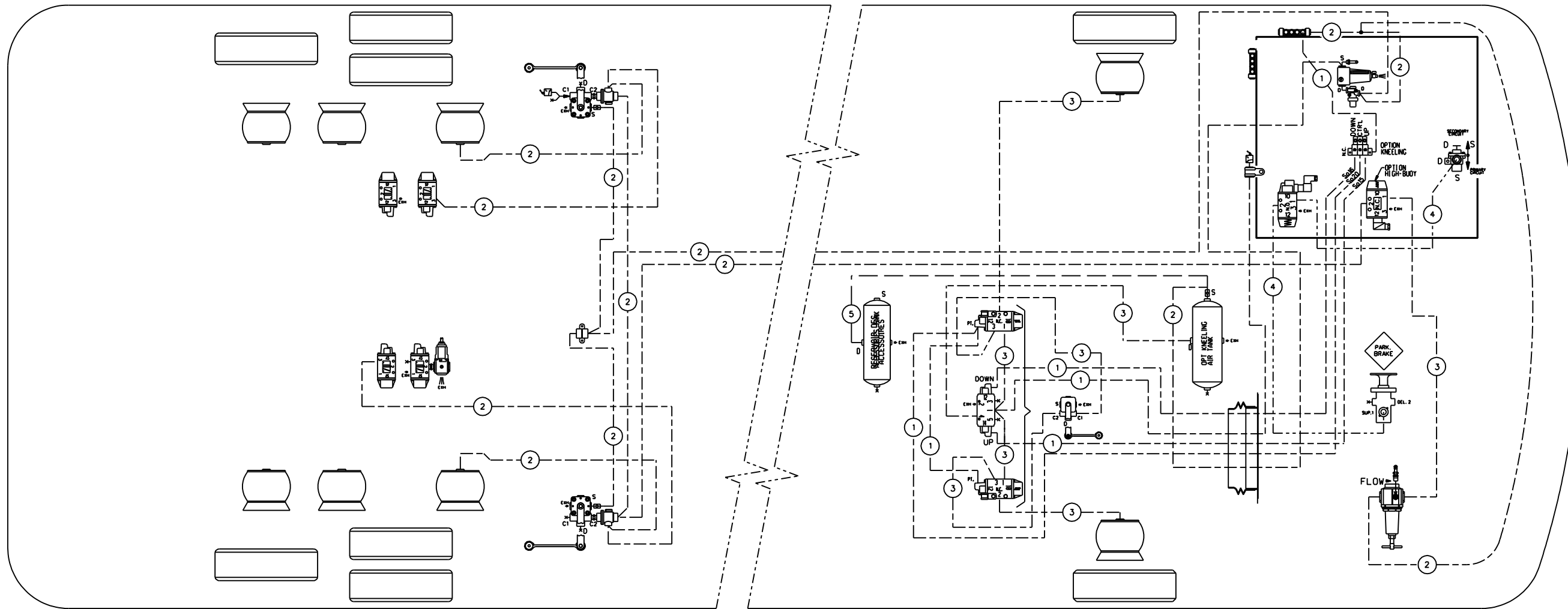

BALLOON	PIPE
*1	1/4" O.D. BLUE
*2	3/8" O.D. BLUE
*3	1/2" O.D. BLUE
*4	3/8" O.D. YELLOW

TUBE COLOR CODING		
LINE TYPE	COLOR	CIRCUIT
---	BLUE	SUSPENSION
----	YELLOW	PARKING BRAKES
----	BLACK	ACCESSORIES

**PREVOST**<sup>®</sup>

DESCRIPTION:

X3-45 COACH, WITH FRONT BEAM AXLE  
WITH OPTION FRONT KNEELING & HIGH-BUOY COMBINATION

EFF. W/VEH :

#A-9953

PAGE:

D140331 P3.1

DATE:

2010/04

REV.:

F

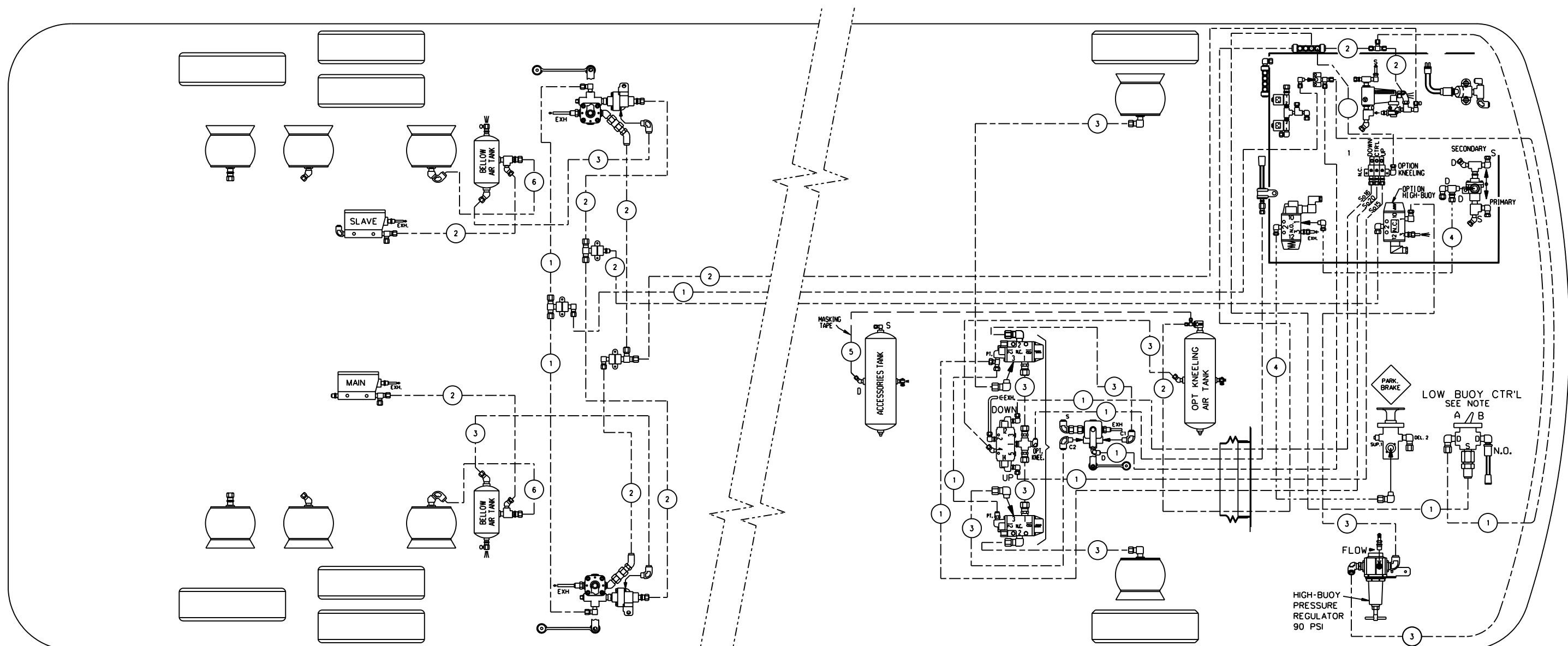

KNEELING SYSTEM = UP (CTR'L + UP ENERGIZED)  
 DOWN (CTR'L + DOWN ENERGIZED)

BALLOON	PIPE
*1	1/4" O.D. BLUE
*2	3/8" O.D. BLUE
*3	1/2" O.D. BLUE
*4	3/8" O.D. YELLOW
*5	3/8" O.D. BLACK
*6	3/4" O.D. BLACK

TUBE COLOR CODING		
LINE TYPE	COLOR	CIRCUIT
---	BLUE	SUSPENSION
---	BLACK	ACCESSORIES
---	YELLOW	PARKING BRAKES

NOTE:

CONTROL VALVE OPT. "LOW-BUOY" , "A" OR "B" SETTING:

POSITION "A": VALVE IS OPEN,  
 AIR FLOW BETWEEN SUPPLY (S) AND  
 DELIVERY (D) , LOW-BUOY IS IN FUNCTION.

POSITION "B": VALVE CLOSED,  
 AIR DOES'NT FLOW BETWEEN SUPPLY (S) AND  
 DELIVERY (D) , LOW-BUOY IS NOT IN FUNCTION.

**PREVOST®**

X3-45 COACH, WITH FRONT BEAM AXLE  
 WITH OPTION FRONT KNEELING,  
 LOW-BUOY & HIGH-BUOY COMBINATION

EFF. W/VEH : TO FOLLOW

DATE: 2006/03 REV.: A

PAGE:

D140331 P4.1

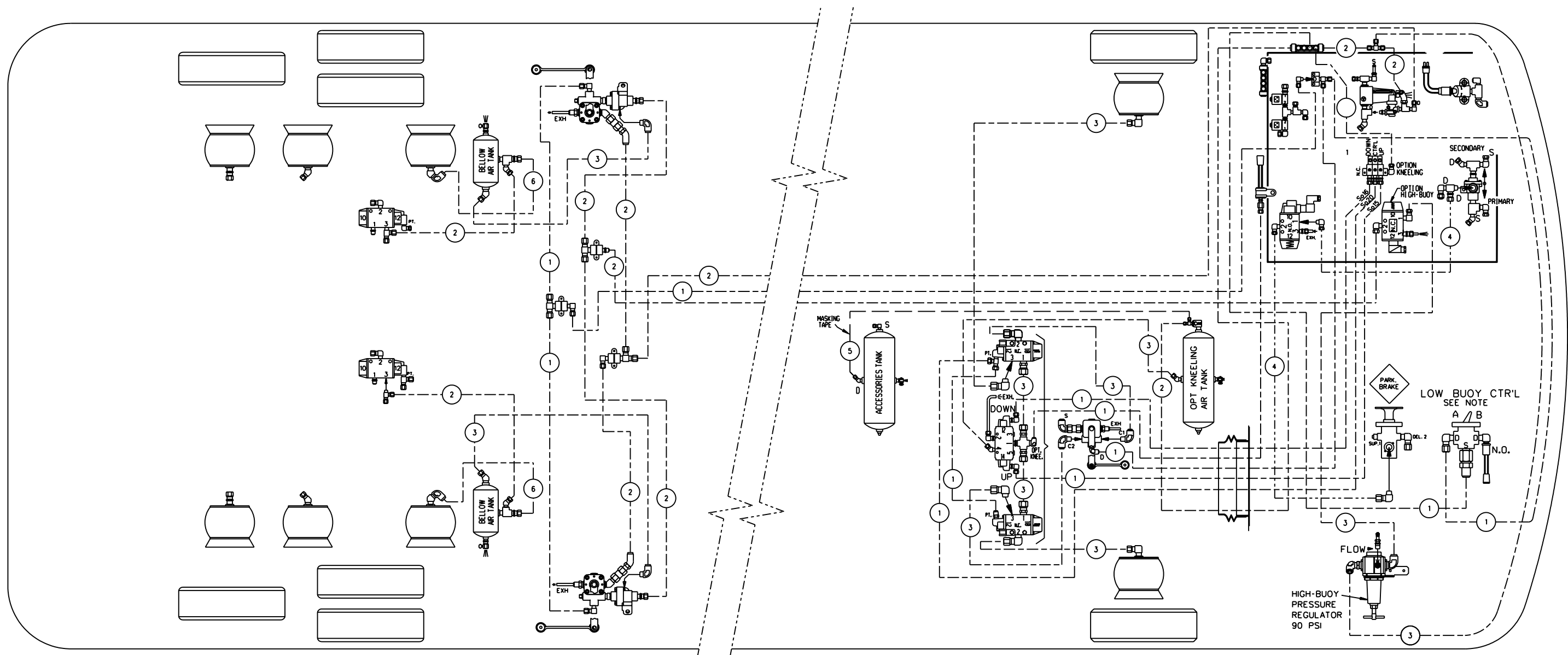

KNEELING SYSTEM = UP (CTR'L + UP ENERGIZED)  
 DOWN (CTR'L + DOWN ENERGIZED)

BALLOON	PIPE
*1	1/4" O.D. BLUE
*2	3/8" O.D. BLUE
*3	1/2" O.D. BLUE
*4	3/8" O.D. YELLOW
*5	3/8" O.D. BLACK
*6	3/4" O.D. BLACK

TUBE COLOR CODING		
LINE TYPE	COLOR	CIRCUIT
---	BLUE	SUSPENSION
---	BLACK	ACCESSORIES
---	YELLOW	PARKING BRAKES

NOTE:

CONTROL VALVE OPT. "LOW-BUOY" , "A" OR "B" SETTING:

POSITION "A": VALVE IS OPEN,  
 AIR FLOW BETWEEN SUPPLY (S) AND  
 DELIVERY (D) , LOW-BUOY IS IN FUNCTION.

POSITION "B": VALVE CLOSED,  
 AIR DOES'NT FLOW BETWEEN SUPPLY (S) AND  
 DELIVERY (D) , LOW-BUOY IS NOT IN FUNCTION.

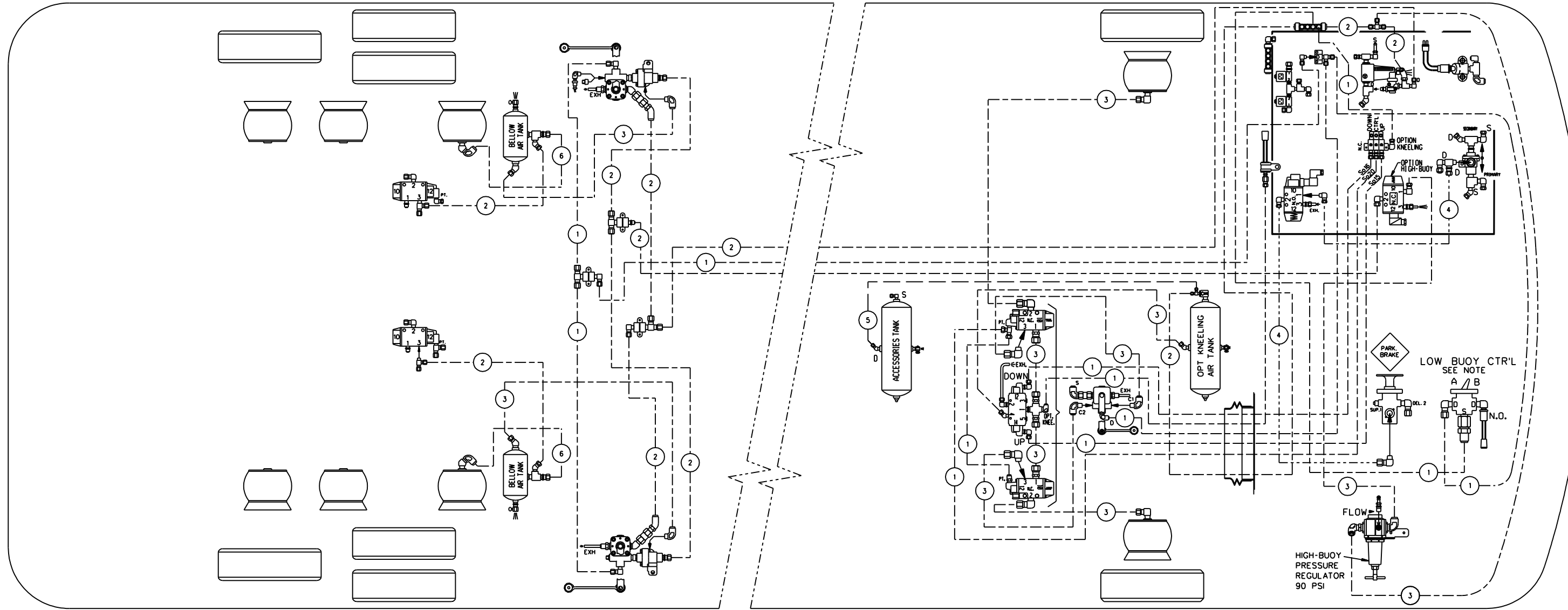

BALLOON	PIPE
*1	1/4" O.D. BLUE
*2	3/8" O.D. BLUE
*3	1/2" O.D. BLUE
*4	3/8" O.D. YELLOW
*5	3/8" O.D. BLACK
*6	3/4" O.D. BLACK

**NOTE:**

KNEELING SYSTEM = UP (CTR'L + UP ENERGIZED)  
DOWN (CTR'L + DOWN ENERGIZED)

CONTROL VALVE OPT. "LOW-BUOY" , "A" OR "B" SETTING:

POSITION "A": VALVE IS OPEN,  
AIR FLOW BETWEEN SUPPLY (S) AND  
DELIVERY (D) , LOW-BUOY IS IN FUNCTION.

POSITION "B": VALVE CLOSED,  
AIR DOES'NT FLOW BETWEEN SUPPLY (S) AND  
DELIVERY (D) , LOW-BUOY IS NOT IN FUNCTION.

TUBE COLOR CODING		
LINE TYPE	COLOR	CIRCUIT
---	BLUE	SUSPENSION
---	BLACK	ACCESSORIES
---	YELLOW	PARKING BRAKES

**PREVOST®**

X3-45 COACH, WITH FRONT BEAM AXLE  
WITH OPTION FRONT KNEELING,  
LOW-BUOY & HIGH-BUOY COMBINATION

EFF. W/VEH : #8-9282...

PAGE:

DATE: 2007/05

REV.: C

D140331 P4.1

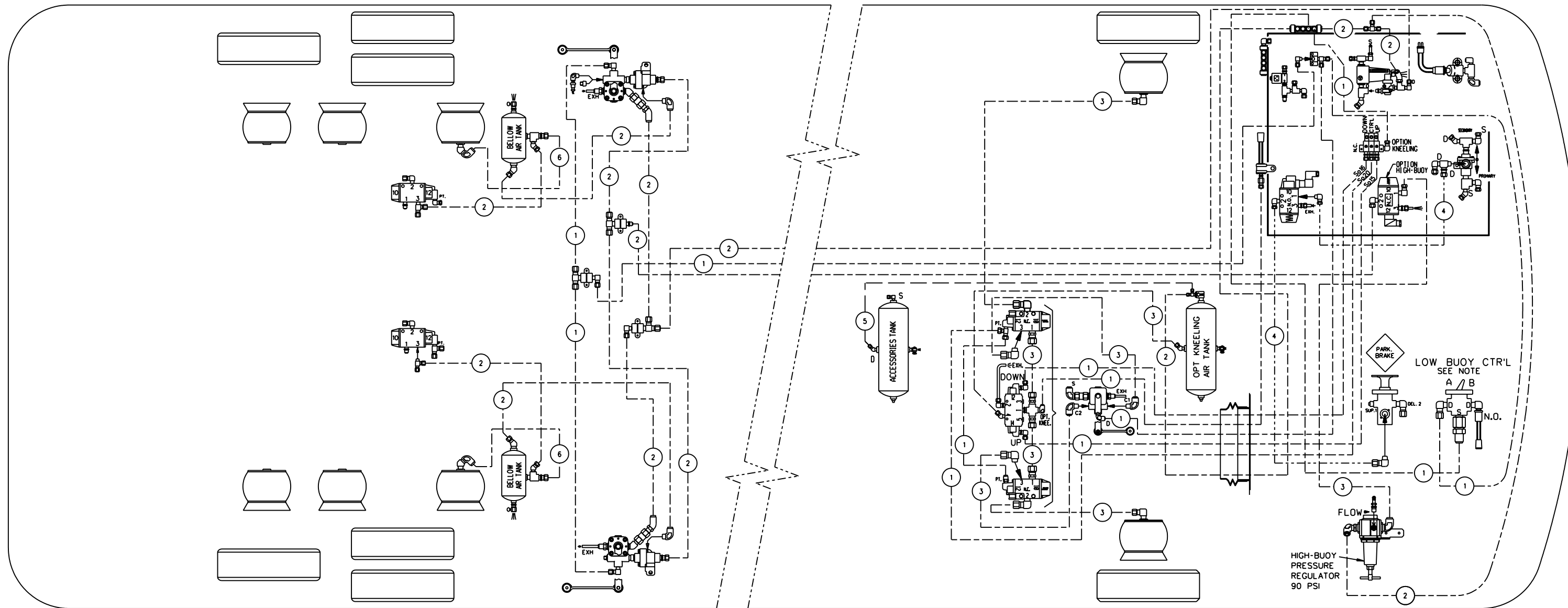

BALLOON	PIPE
#1	1/4" O.D. BLUE
#2	3/8" O.D. BLUE
#3	1/2" O.D. BLUE
#4	3/8" O.D. YELLOW
#5	3/8" O.D. BLACK
#6	3/4" O.D. BLACK

**NOTE:**

KNEELING SYSTEM = UP (CTR'L + UP ENERGIZED)  
DOWN (CTR'L + DOWN ENERGIZED)

CONTROL VALVE OPT. "LOW-BUOY" , "A" OR "B" SETTING:

POSITION "A": VALVE IS OPEN,  
AIR FLOW BETWEEN SUPPLY (S) AND  
DELIVERY (D) , LOW-BUOY IS IN FUNCTION.

POSITION "B": VALVE CLOSED,  
AIR DOES'NT FLOW BETWEEN SUPPLY (S) AND  
DELIVERY (D) , LOW-BUOY IS NOT IN FUNCTION.

TUBE COLOR CODING		
LINE TYPE	COLOR	CIRCUIT
---	BLUE	SUSPENSION
---	BLACK	ACCESSORIES
---	YELLOW	PARKING BRAKES

**PREVOST®**

X3-45 COACH, WITH FRONT BEAM AXLE  
WITH OPTION FRONT KNEELING,  
LOW-BUOY & HIGH-BUOY COMBINATION

EFF. W/VEH : #8-9430

PAGE:

DATE: 2008/04

REV.: D

D140331 P4.1



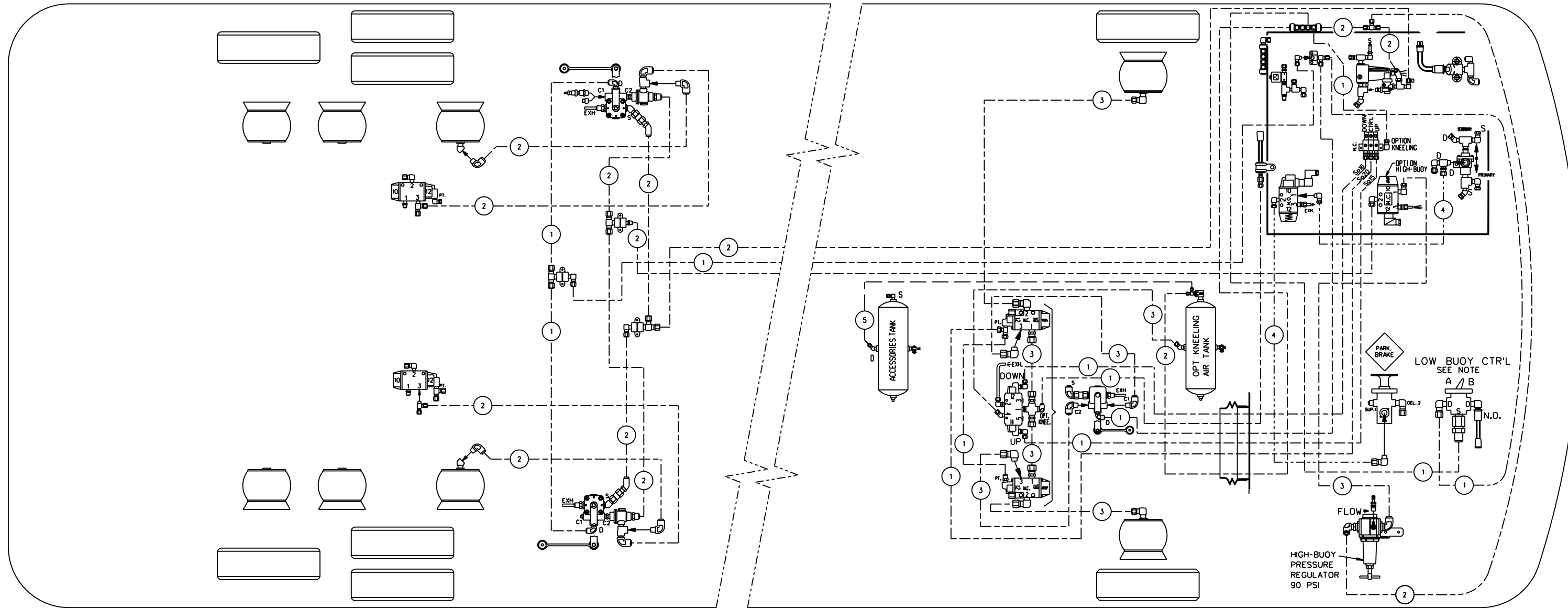

BALLOON	PIPE
*1	1/4" O.D. BLUE
*2	3/8" O.D. BLUE
*3	1/2" O.D. BLUE
*4	3/8" O.D. YELLOW
*5	3/8" O.D. BLACK

**NOTE:**

KNEELING SYSTEM = UP (CTR'L + UP ENERGIZED)  
DOWN (CTR'L + DOWN ENERGIZED)

CONTROL VALVE OPT. "LOW-BUOY" , "A" OR "B" SETTING:

POSITION "A": VALVE IS OPEN,  
AIR FLOW BETWEEN SUPPLY (S) AND  
DELIVERY (D) ,LOW-BUOY IS IN FUNCTION.

POSITION "B": VALVE CLOSED,  
AIR DOES'NT FLOW BETWEEN SUPPLY (S) AND  
DELIVERY (D) ,LOW-BUOY IS NOT IN FUNCTION.

TUBE COLOR CODING		
LINE TYPE	COLOR	CIRCUIT
---	BLUE	SUSPENSION
---	BLACK	ACCESSORIES
---	YELLOW	PARKING BRAKES

**PREVOST®**

X3-45 COACH, WITH FRONT BEAM AXLE  
WITH OPTION FRONT KNEELING,  
LOW-BUOY & HIGH-BUOY COMBINATION

EFF. W/VEH : #9-9599...

PAGE:

DATE: 2008/07

REV.: E

D140331 P4.1

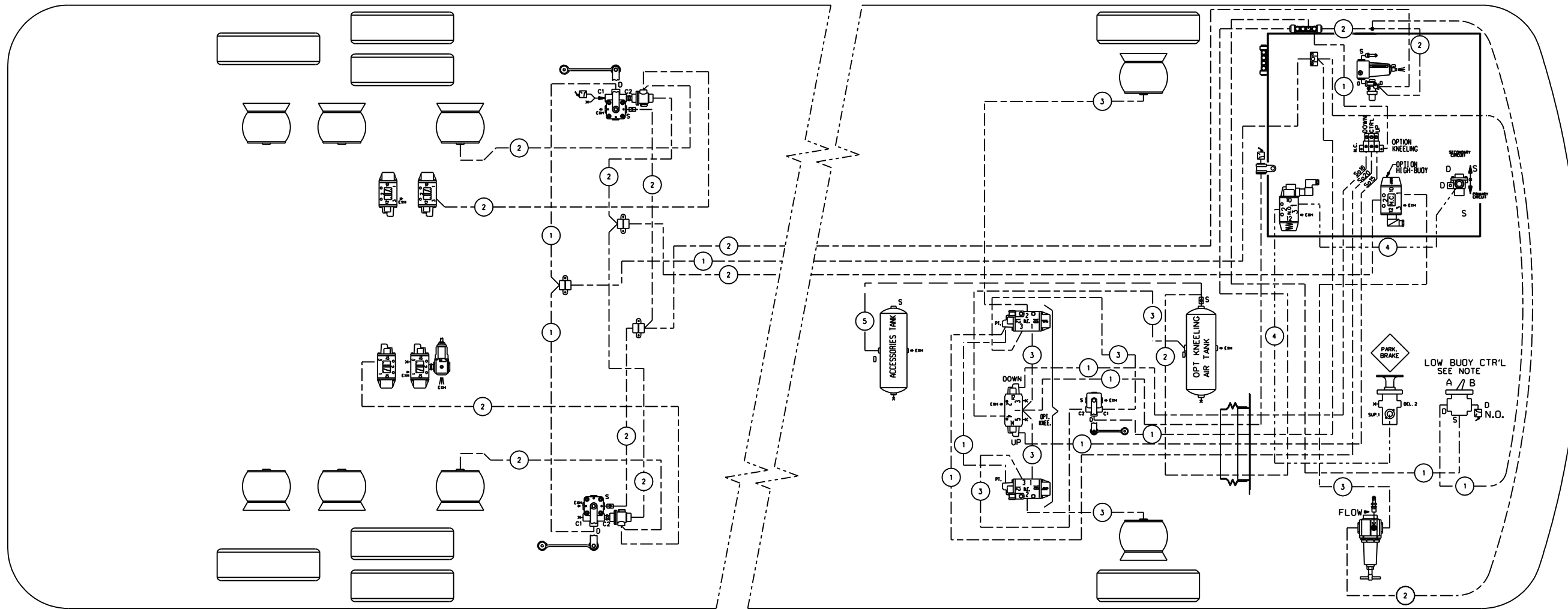

BALLOON	PIPE
*1	1/4" O.D. BLUE
*2	3/8" O.D. BLUE
*3	1/2" O.D. BLUE
*4	3/8" O.D. YELLOW
*5	3/8" O.D. BLACK

**NOTE:**

KNEELING SYSTEM UP (CTR'L + UP ENERGIZED)  
DOWN (CTR'L + DOWN ENERGIZED)

CONTROL VALVE OPT. "LOW-BUOY" , "A" OR "B" SETTING:

POSITION "A": VALVE IS OPEN,  
AIR FLOW BETWEEN SUPPLY (S) AND  
DELIVERY (D) , LOW-BUOY IS IN FUNCTION.

POSITION "B": VALVE CLOSED,  
AIR DOES'NT FLOW BETWEEN SUPPLY (S) AND  
DELIVERY (D) , LOW-BUOY IS NOT IN FUNCTION.

TUBE COLOR CODING		
LINE TYPE	COLOR	CIRCUIT
---	BLUE	SUSPENSION
---	BLACK	ACCESSORIES
---	YELLOW	PARKING BRAKES

**PREVOST®**

X3-45 COACH, WITH FRONT BEAM AXLE  
WITH OPTION FRONT KNEELING,  
LOW-BUOY & HIGH-BUOY COMBINATION

EFF. W/VEH : #A-9953

PAGE:

DATE: 2010/04

REV.: F

D140331 P4.1

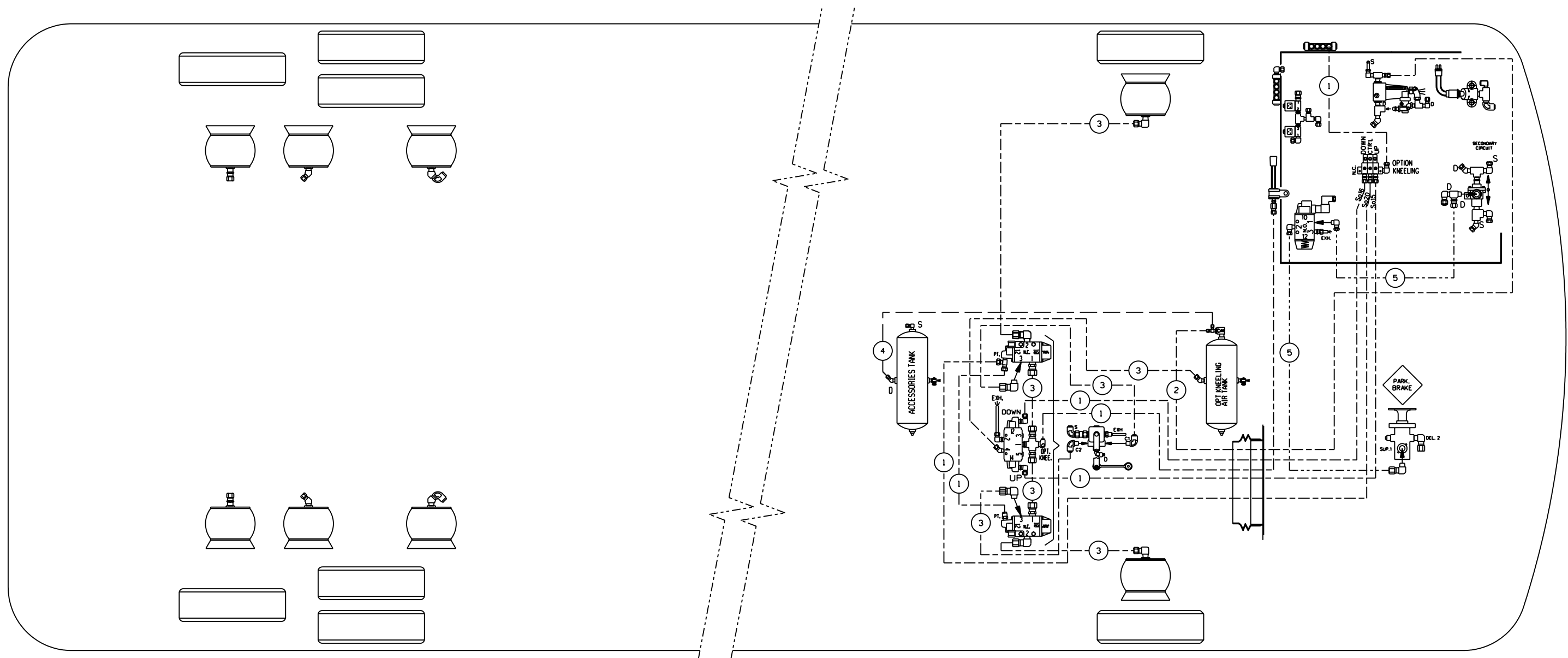

KNEELING SYSTEM = UP (CTR'L + UP ENERGIZED)  
 DOWN (CTR'L + DOWN ENERGIZED)

TUBE COLOR CODING		
ACTIVE	COLOR	CIRCUIT
---	YELLOW	PARKING BRAKE
---	BLACK	ACCESSORIES
---	BLUE	KNEELING OPTION

BALLOON	PIPE
*1	1/4" O.D. BLUE
*2	3/8" O.D. BLUE
*3	1/2" O.D. BLUE
*4	3/8" O.D. BLACK
*5	3/8" O.D. YELLOW

**PREVOST**®

DESCRIPTION: X3-45 COACH WITH FRONT I-BEAM AXLE WITH FRONT KNEELING OPTION

EFF. W/ VEH : #7-8938...  
 DATE: 2006/03 REV.: A

PAGE: D140331 P5.1

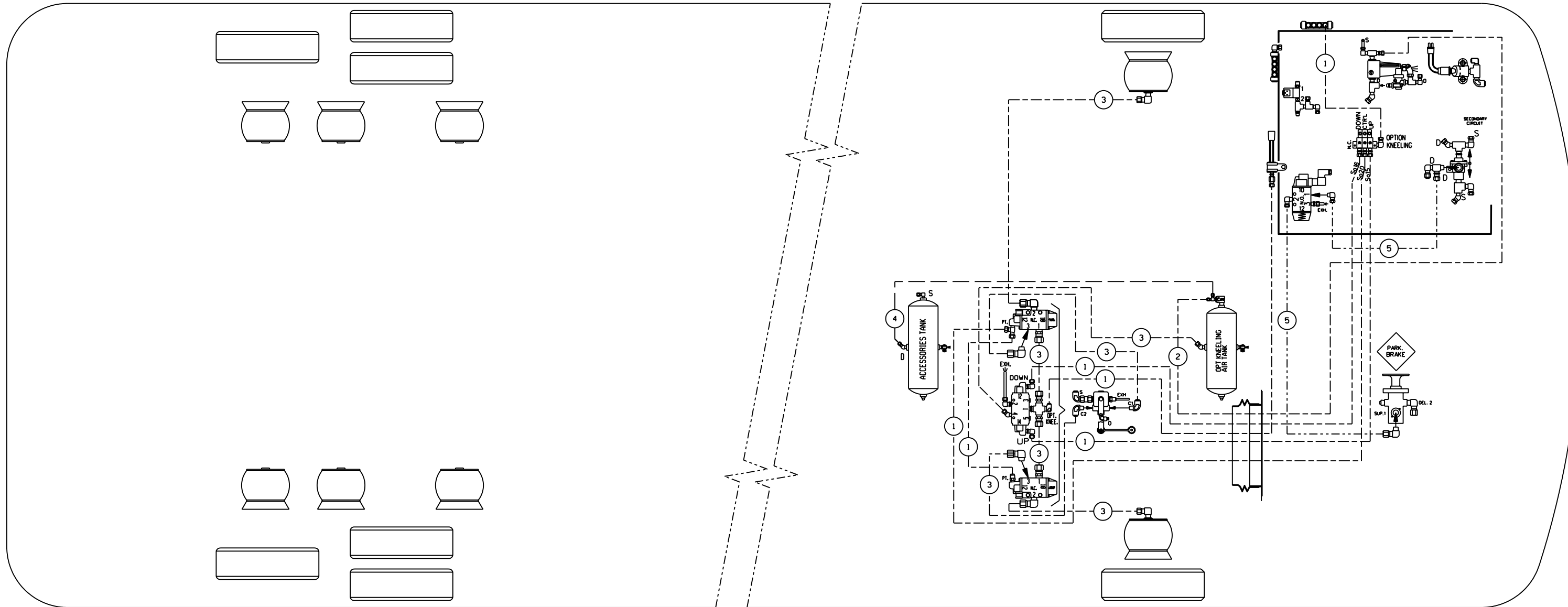

TUBE COLOR CODING		
ACTIVE	COLOR	CIRCUIT
- - - -	YELLOW	PARKING BRAKE
— — —	BLACK	ACCESSORIES
- - - -	BLUE	KNEELING OPTION

BALLOON	PIPE
#1	1/4" O.D. BLUE
#2	3/8" O.D. BLUE
#3	1/2" O.D. BLUE
#4	3/8" O.D. BLACK
#5	3/8" O.D. YELLOW

**PREVOST®**

DESCRIPTION:

X3-45 COACH WITH FRONT I-BEAM AXLE  
WITH FRONT KNEELING OPTION

EFF. W/ VEH :

#7-8938...

PAGE:

D140331 P5.1

DATE:

2009/05

REV.:

B

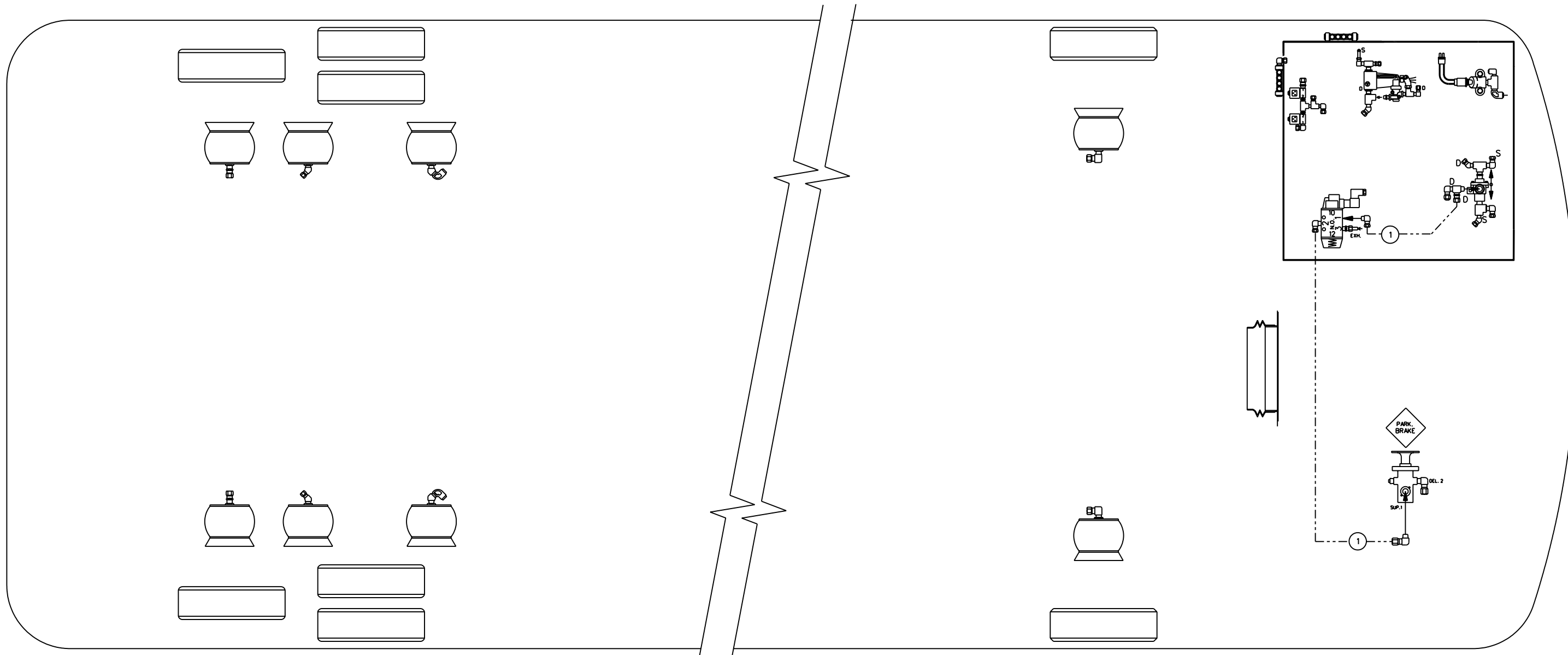

TUBE COLOR CODING		
ACTIVE	COLOR	CIRCUIT
---	YELLOW	PARKING BRAKE

BALLOON	PIPE
*1	3/8" O.D. YELLOW

**PREVOST®**

DESCRIPTION: X3-45 COACH, WITH FRONT BEAM AXLE  
WITH OPTION PARKING BRAKE WITH WHEELCHAIR LIFT AND WITHOUT  
KNEELING

EFF. W/ VEH : TO FOLLOW  
DATE: 2006/03 REV.: A

PAGE: D140331 P6.1

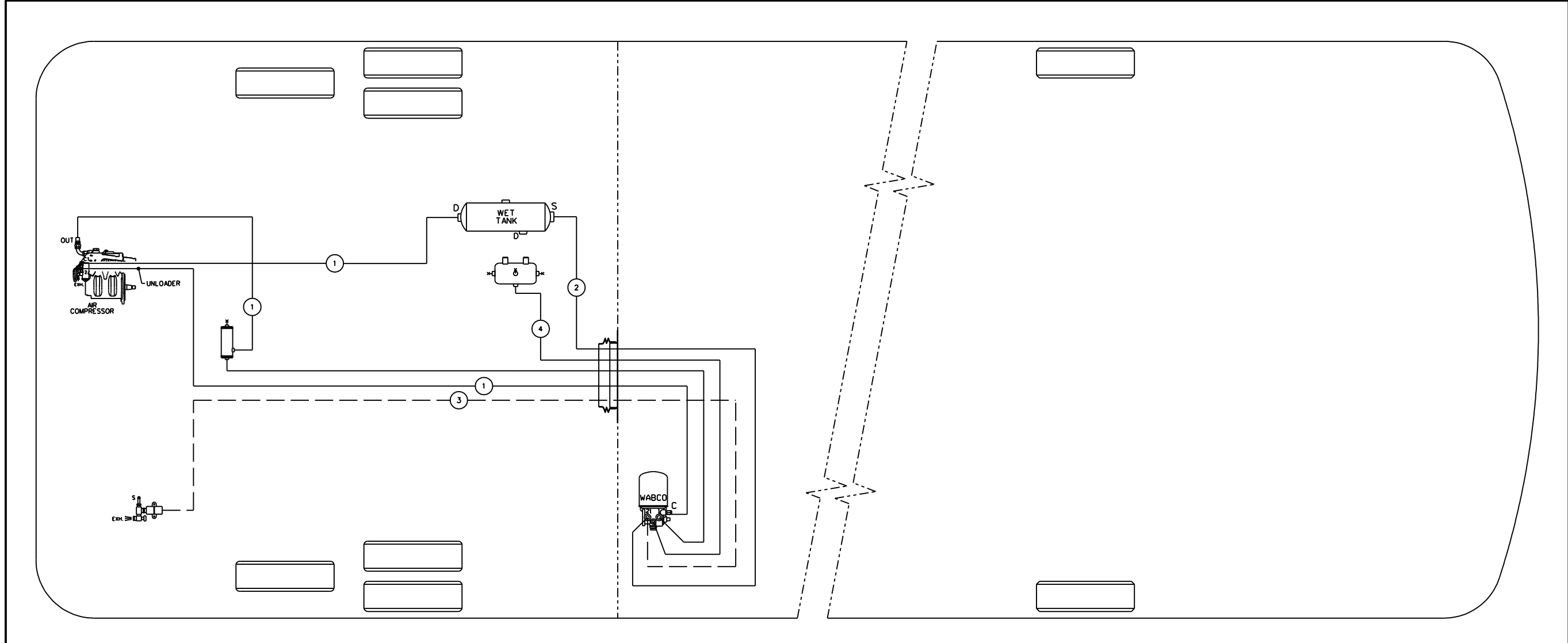

TUBE COLOR CODING		
ACTIVE	COLOR	CIRCUIT
—	GREEN	PRIMARY & SUPPLY
—	BLACK	ACCESSORIES

BALLOON	PIPE
•1	HOSE ASS'Y
•2	3/4" O.D. GREEN
•3	1/4" O.D. BLACK
•4	3/8" O.D. GREY

**PREVOST**®

DESCRIPTION:  
 X3-45 COACH, MD13 VOLVO ENGINE WITH FRONT BEAM AXLE  
 WITH OPTION WABCO AIR DRYER

EFF. W/ VEH : #A-9953  
 DATE: 2010/04 REV.: C

PAGE:  
 D140331 SP6.1

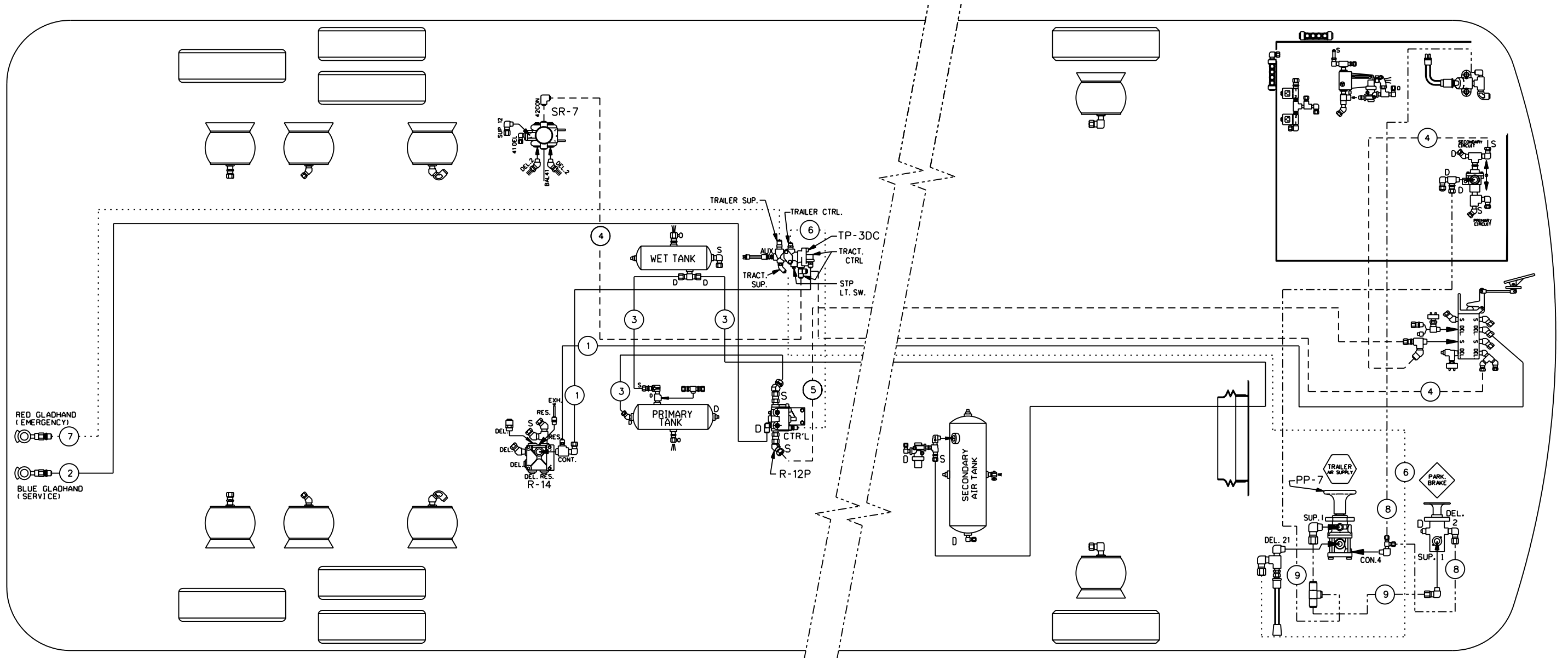

RED GLADHAND  
(EMERGENCY) 7

BLUE GLADHAND  
(SERVICE) 2

TUBE COLOR CODING	
ACTIVE	CIRCUIT
---	RED SECONDARY
---	GREEN PRIMARY & SUPPLY
---	YELLOW PARKING BRAKE
---	BLACK ACCESSORIES
---	BROWN TRAILER

BALLOON	PIPE
*1	3/8" O.D. GREEN
*2	1/2" O.D. GREEN
*3	5/8" O.D. GREEN
*4	3/8" O.D. RED
*5	5/8" O.D. RED
*6	3/8" O.D. BROWN
*7	1/2" O.D. BROWN
*8	1/4" O.D. YELLOW
*9	3/8" O.D. YELLOW
*10	3/8" O.D. BLACK
*11	5/8" O.D. BLACK

**PREVOST**®

DESCRIPTION:

X3-45 COACH, WITH FRONT BEAM AXLE  
WITH OPTION TRAILER HITCH

EFF. W/ VEH :

TO FOLLOW

PAGE:

DATE:  
2006/03

REV.:  
A

D140331 P7.1

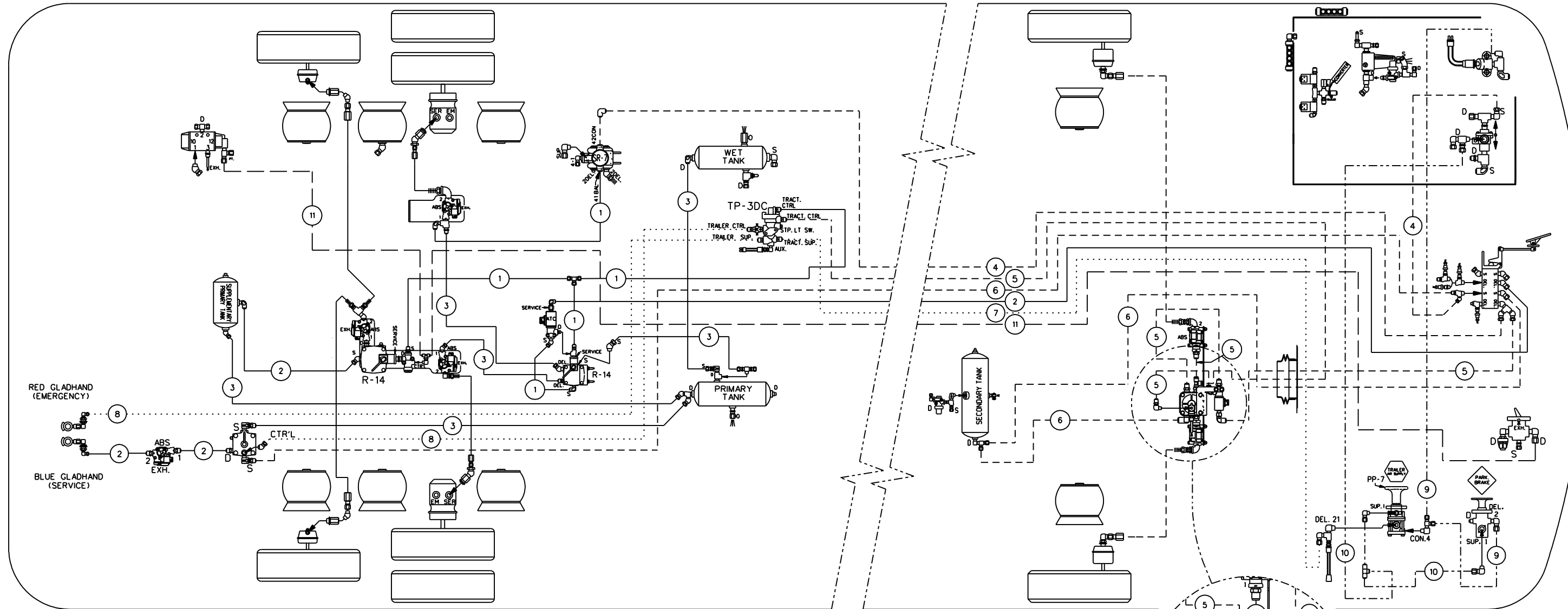

BALLOON	PIPE
•1	3/8" O.D. GREEN
•2	1/2" O.D. GREEN
•3	5/8" O.D. GREEN
•4	3/8" O.D. RED
•5	1/2" O.D. RED
•6	5/8" O.D. RED
•7	3/8" O.D. BROWN
•8	1/2" O.D. BROWN
•9	1/4" O.D. YELLOW
•10	3/8" O.D. YELLOW
•11	1/4" O.D. BLACK
•12	5/8" O.D. BLACK

TUBE COLOR CODING	
ACTIVE	COLOR
---	RED
---	GREEN
---	YELLOW
---	BROWN
---	BLACK

CIRCUIT
SECONDARY
PRIMARY & SUPPLY
PARKING BRAKE
TRAILER
ACCESSORIES

**PREVOST®**

DESCRIPTION:

X3-45 COACH, WITH FRONT BEAM AXLE  
WITH OPTION TRAILER HITCH AIR BRAKE  
WITH ESP ADVANCED

EFF. W/VEH : #8-9282...

PAGE:

DATE: 2007/05

REV.: B

D140331 P7.1



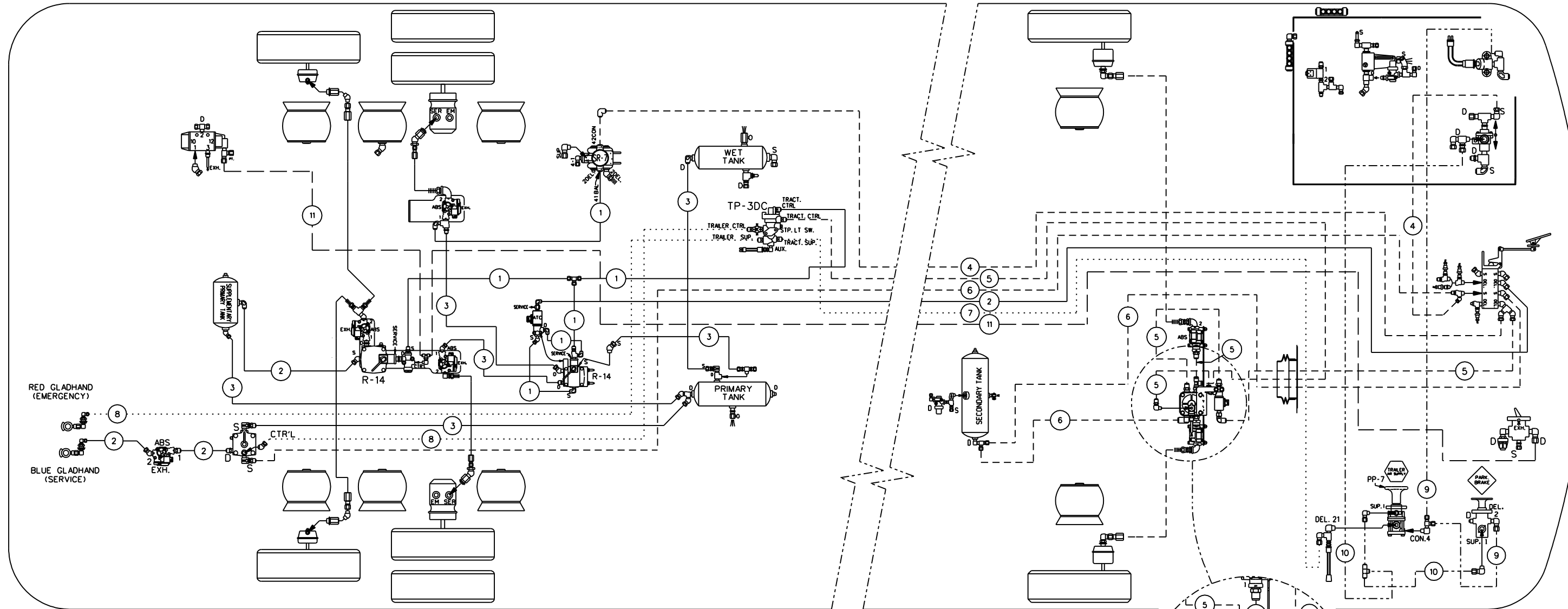

BALLOON	PIPE
•1	3/8" O.D. GREEN
•2	1/2" O.D. GREEN
•3	5/8" O.D. GREEN
•4	3/8" O.D. RED
•5	1/2" O.D. RED
•6	5/8" O.D. RED
•7	3/8" O.D. BROWN
•8	1/2" O.D. BROWN
•9	1/4" O.D. YELLOW
•10	3/8" O.D. YELLOW
•11	1/4" O.D. BLACK
•12	5/8" O.D. BLACK

TUBE COLOR CODING		
ACTIVE	COLOR	CIRCUIT
---	RED	SECONDARY
---	GREEN	PRIMARY & SUPPLY
---	YELLOW	PARKING BRAKE
---	BROWN	TRAILER
---	BLACK	ACCESSORIES

**PREVOST®**

DESCRIPTION:

X3-45 COACH, WITH FRONT BEAM AXLE  
WITH OPTION TRAILER HITCH AIR BRAKE  
WITH ESP ADVANCED

EFF. W/VEH : #8-9282...

PAGE:

DATE: 2008/07

REV.: D

D140331 P7.1

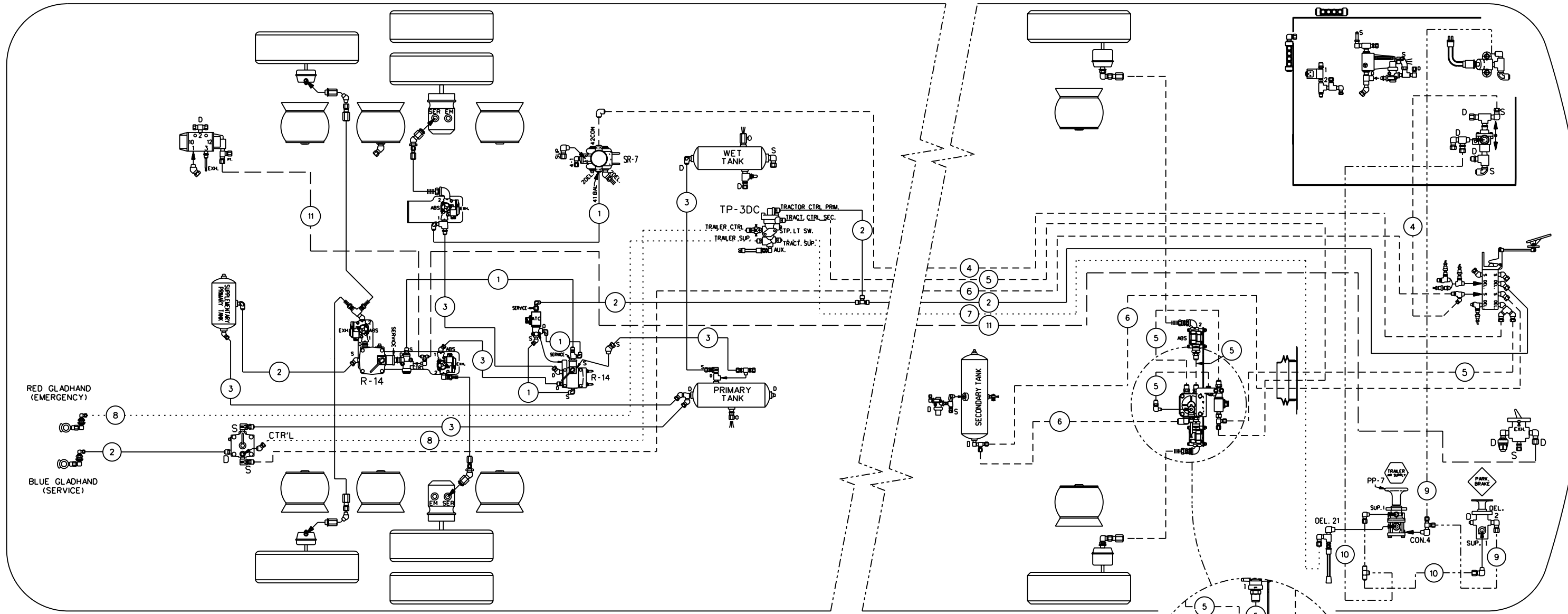

RED GLADHAND  
(EMERGENCY)

BLUE GLADHAND  
(SERVICE)

BALLOON	PIPE
*1	3/8" O.D. GREEN
*2	1/2" O.D. GREEN
*3	5/8" O.D. GREEN
*4	3/8" O.D. RED
*5	1/2" O.D. RED
*6	5/8" O.D. RED
*7	3/8" O.D. BROWN
*8	1/2" O.D. BROWN
*9	1/4" O.D. YELLOW
*10	3/8" O.D. YELLOW
*11	1/4" O.D. BLACK
*12	5/8" O.D. BLACK

TUBE COLOR CODING	
ACTIVE	CIRCUIT
---	RED SECONDARY
---	GREEN PRIMARY & SUPPLY
---	YELLOW PARKING BRAKE
---	BROWN TRAILER
---	BLACK ACCESSORIES

**PREVOST**®

DESCRIPTION: X3-45 COACH, WITH FRONT BEAM AXLE WITH OPTION TRAILER HITCH AIR BRAKE WITH ESP ADVANCED

EFF. W/VEH : #9-9674...

PAGE: D140331 P7.1

DATE: 2008/12 REV.: E

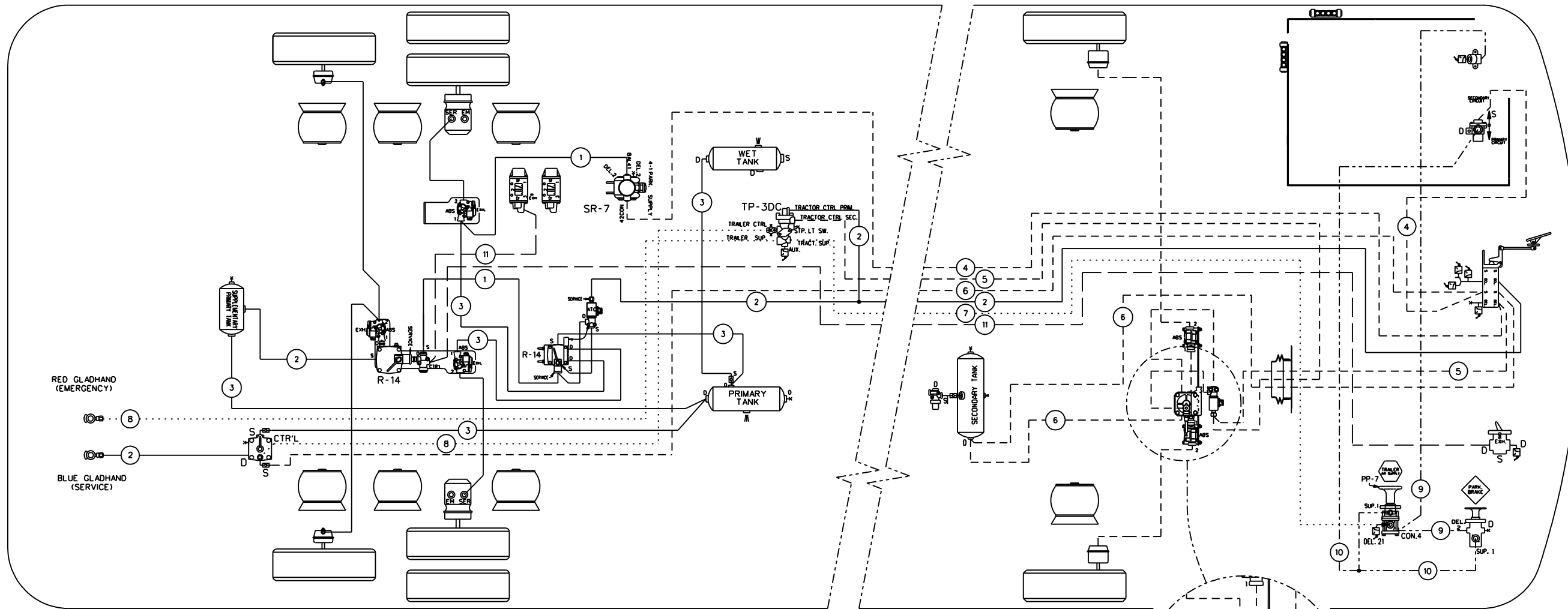

RED GLADHAND  
(EMERGENCY)

BLUE GLADHAND  
(SERVICE)

BALLOON	PIPE
*1	3/8" O.D. GREEN
*2	1/2" O.D. GREEN
*3	3/8" O.D. GREEN
*4	3/8" O.D. RED
*5	1/2" O.D. RED
*6	3/8" O.D. RED
*7	3/8" O.D. BROWN
*8	1/2" O.D. BROWN
*9	1/4" O.D. YELLOW
*10	3/8" O.D. YELLOW
*11	1/4" O.D. BLACK
*12	3/8" O.D. BLACK

TUBE COLOR CODING	
ACTIVE COLOR	CIRCUIT
---	RED SECONDARY
---	GREEN PRIMARY & SUPPLY
---	YELLOW PARKING BRAKE
---	BROWN TRAILER
---	BLACK ACCESSORIES

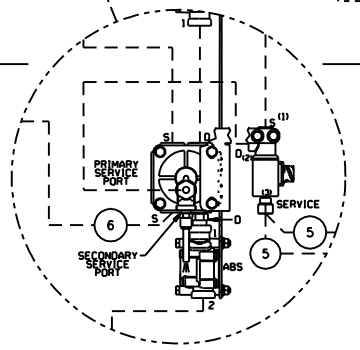

**PREVOST**

DESCRIPTION: X3-45 COACH WITH FRONT BEAM AXLE WITH OPTION TRAILER HITCH AIR BRAKE WITH ESP ADVANCED

EFF. W/VEH : #A-9953  
DATE: 2010/04 REV.: F

PAGE: D140331 P7.1

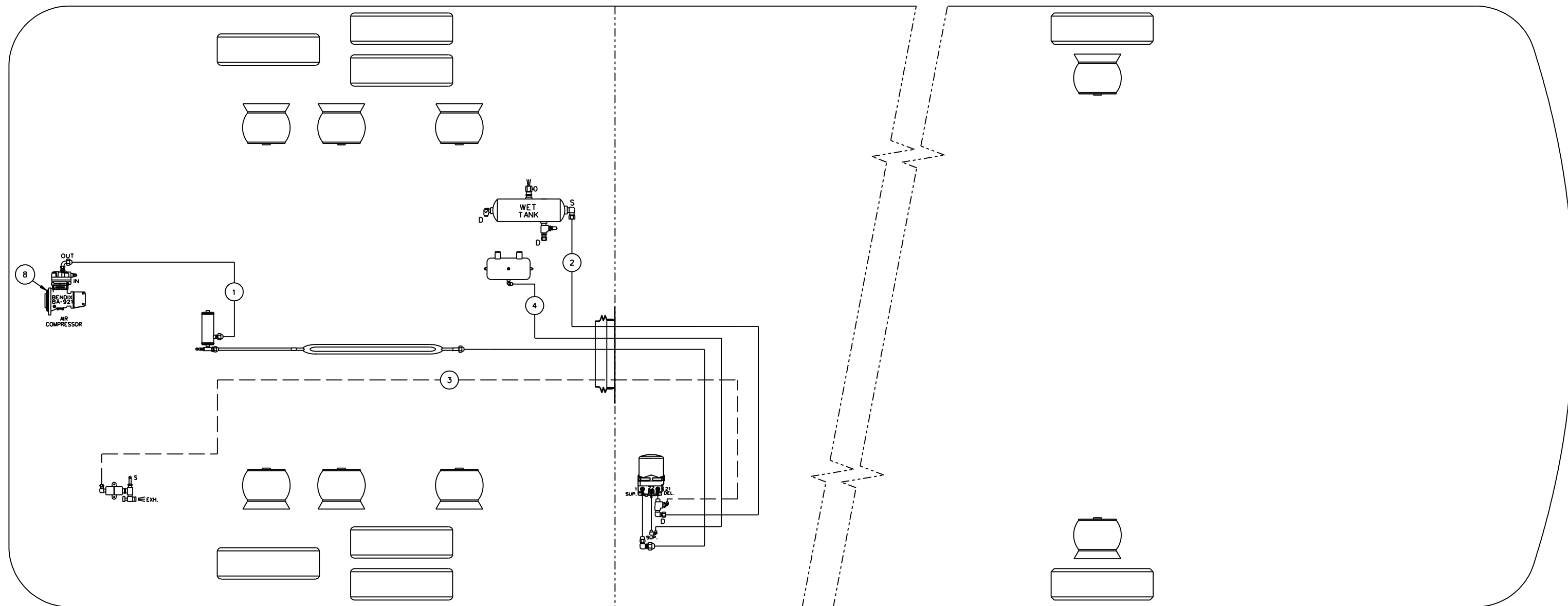

TUBE COLOR CODING	
ACTIVE COLOR	CIRCUIT
— GREEN	PRIMARY & SUPPLY
— BLACK	ACCESSORIES

BALLOON	PIPE
*1	HOSE ASS'Y
*2	3/4" O.D. GREEN
*3	1/4" O.D. BLACK
*4	3/8" O.D. GREY

**PREVOST**®

DESCRIPTION:

X3-45 COACH, WITH FRONT BEAM AXLE  
WITH HALDEX AIR DRYER OPTION

EFF. W/ VEH :

#9-9643

PAGE:

DATE:

2008/12

REV.:

A

D140331 SP7.1

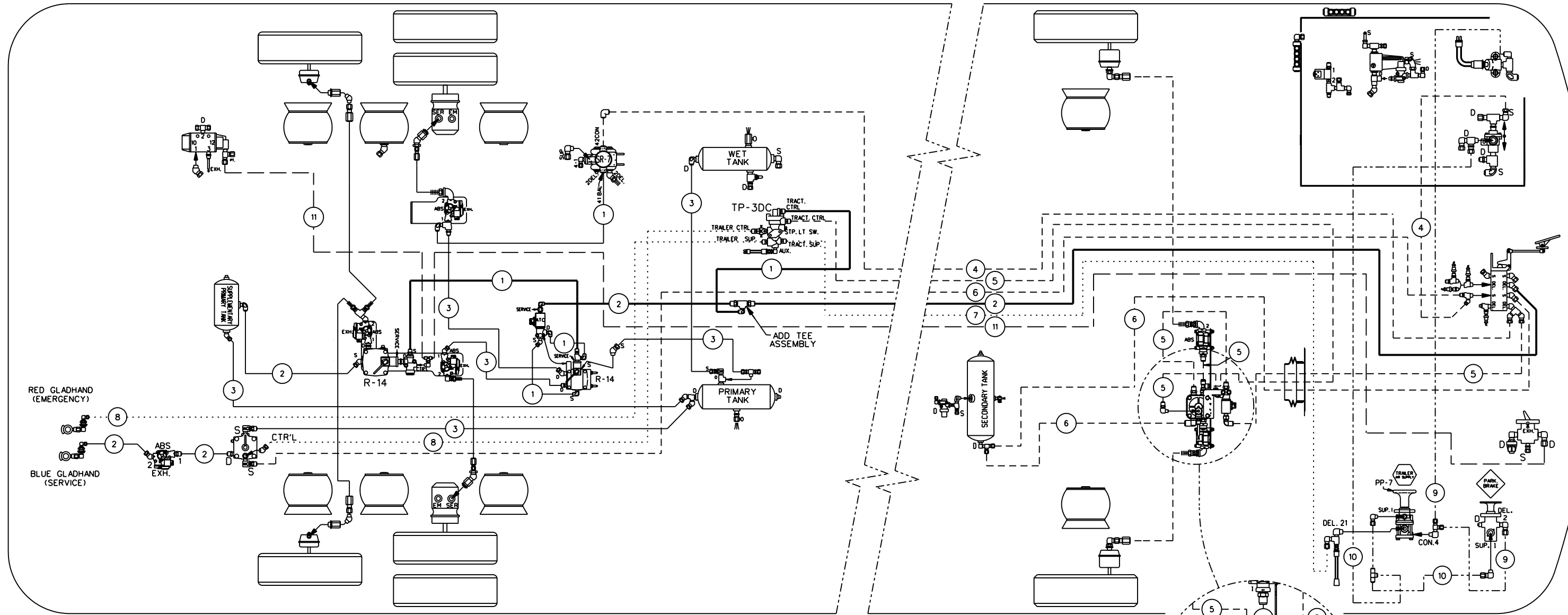

BALLOON	PIPE
*1	3/8" O.D. GREEN
*2	1/2" O.D. GREEN
*3	5/8" O.D. GREEN
*4	3/8" O.D. RED
*5	1/2" O.D. RED
*6	5/8" O.D. RED
*7	3/8" O.D. BROWN
*8	1/2" O.D. BROWN
*9	1/4" O.D. YELLOW
*10	3/8" O.D. YELLOW
*11	1/4" O.D. BLACK
*12	5/8" O.D. BLACK

TUBE COLOR CODING	
ACTIVE	COLOR
---	RED
---	GREEN
---	YELLOW
---	BROWN
---	BLACK
CIRCUIT	
	SECONDARY
	PRIMARY & SUPPLY
	PARKING BRAKE
	TRAILER
	ACCESSORIES

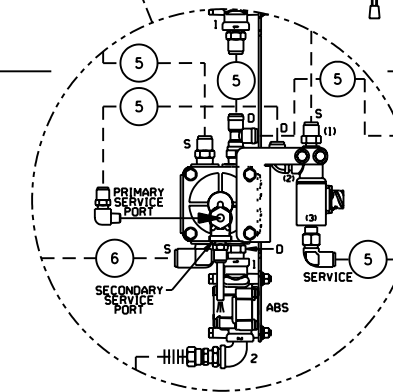

**PREVOST**

DESCRIPTION: X3-45 COACH, WITH FRONT BEAM AXLE  
WITH OPTION TRAILER HITCH AIR BRAKE AND ESP SYSTEM  
PNEUMATIC LINES MODIFICATION

EFF. W/VEH : #8-9405, #9-9614  
#9-9648, #9-9660

PAGE:

DATE: 2009/07

REV.: A

D140331 P7.2

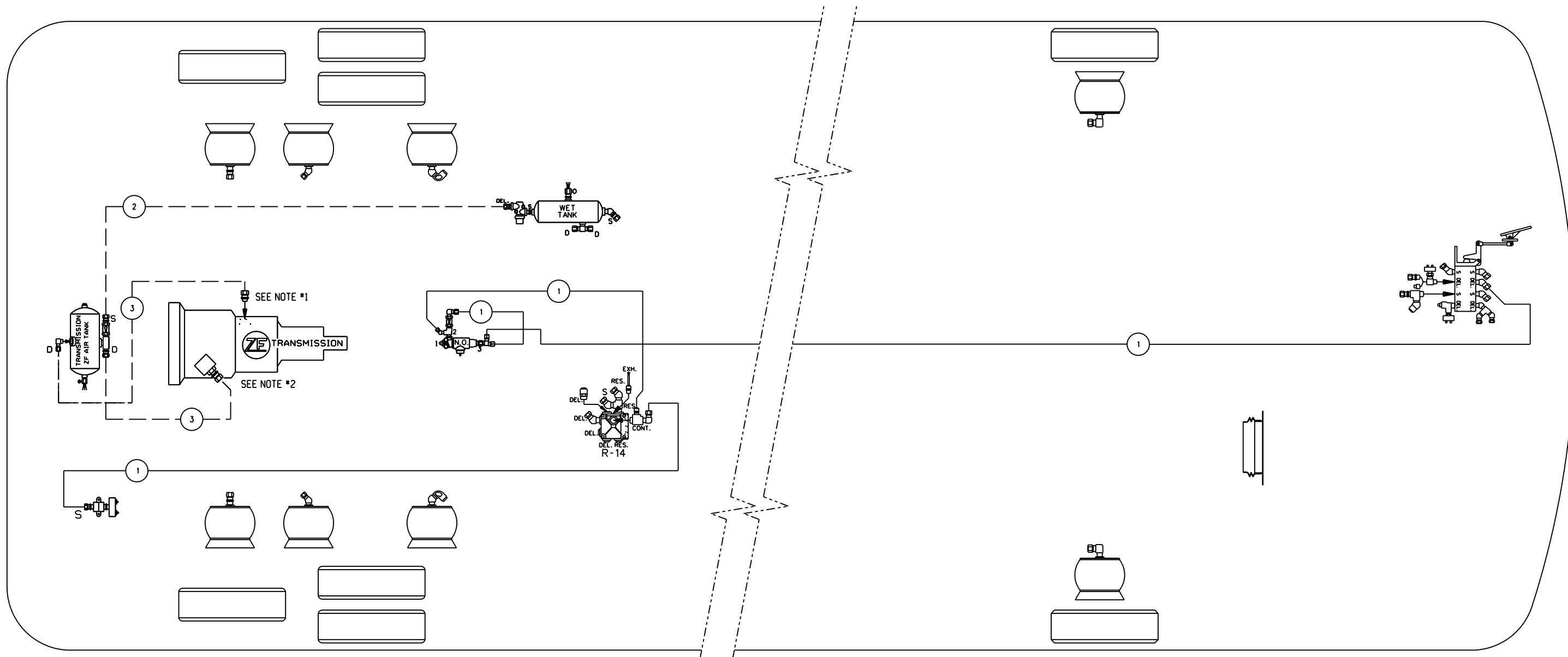

- NOTE #1: COMPRESSED AIR LINE FOR CLUTCH ACTUATOR  
 #2: COMPRESSED AIR LINE FOR TRANSMISSION ACTUATOR  
 #3: BASED ON #D140300 P.1

TUBE COLOR CODING		
ACTIVE	COLOR	CIRCUIT
—	GREEN	PRIMARY & SUPPLY
—	BLACK	ACCESSORIES

BALLOON	PIPE
#1	3/8" O.D. GREEN
#2	3/8" O.D. BLACK
#3	5/8" O.D. BLACK

**PREVOST®**

DESCRIPTION:

X3-45 COACH, WITH FRONT BEAM AXLE  
 WITH OPTION TRANSMISSION ZF

EFF. W/ VEH : TO FOLLOW

DATE: 2006/03

REV.: A

PAGE:

D140331 P8.1

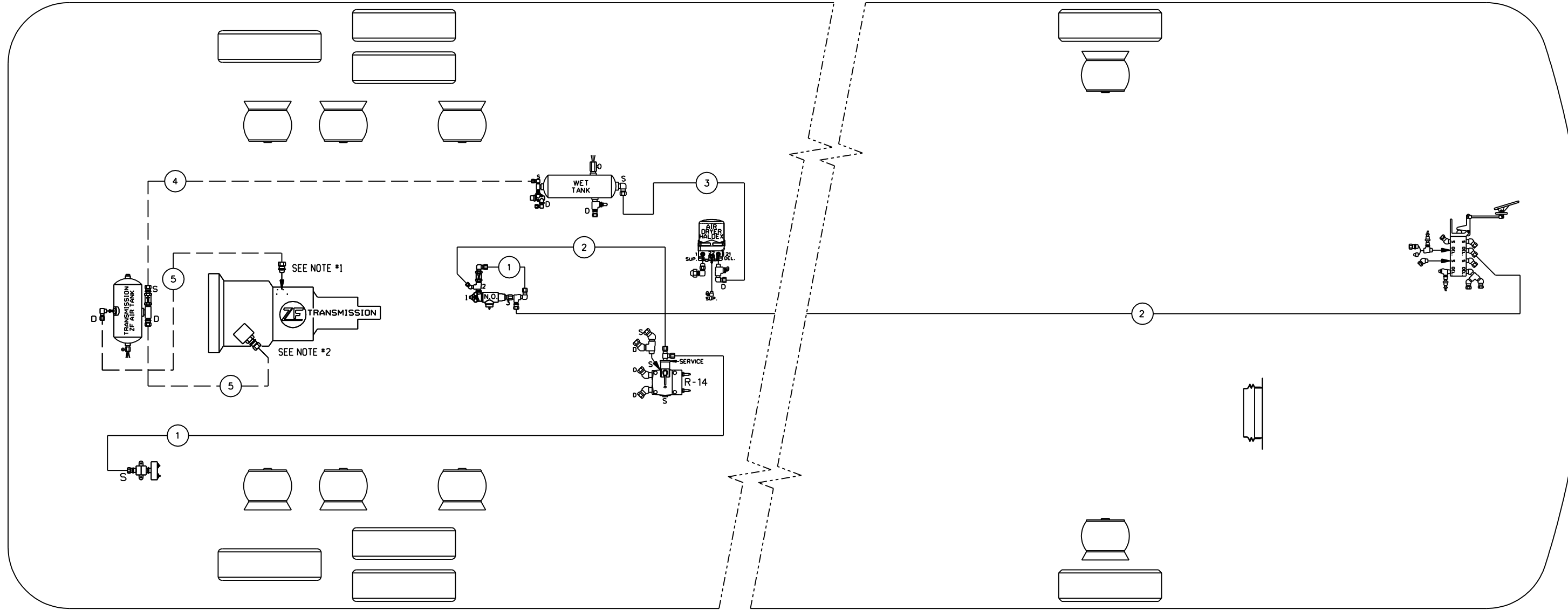

NOTE \*1: COMPRESSED AIR LINE FOR CLUTCH ACTUATOR  
 \*2: COMPRESSED AIR LINE FOR TRANSMISSION ACTUATOR  
 \*3: BASED ON #D140300 P.1

TUBE COLOR CODING	
ACTIVE COLOR	CIRCUIT
GREEN	PRIMARY & SUPPLY
BLACK	ACCESSORIES

BALLOON	PIPE
*1	3/8" O.D. GREEN
*2	1/2" O.D. GREEN
*3	3/4" O.D. GREEN
*4	3/8" O.D. BLACK
*5	5/8" O.D. BLACK

**PREVOST**®

DESCRIPTION:

X3-45 COACH, WITH FRONT BEAM AXLES  
 WITH OPTION TRANSMISSION ZF

EFF. W/ VEH :

#8-9282...

PAGE:

D140331 P8.1

DATE:

2007/05

REV.:

B

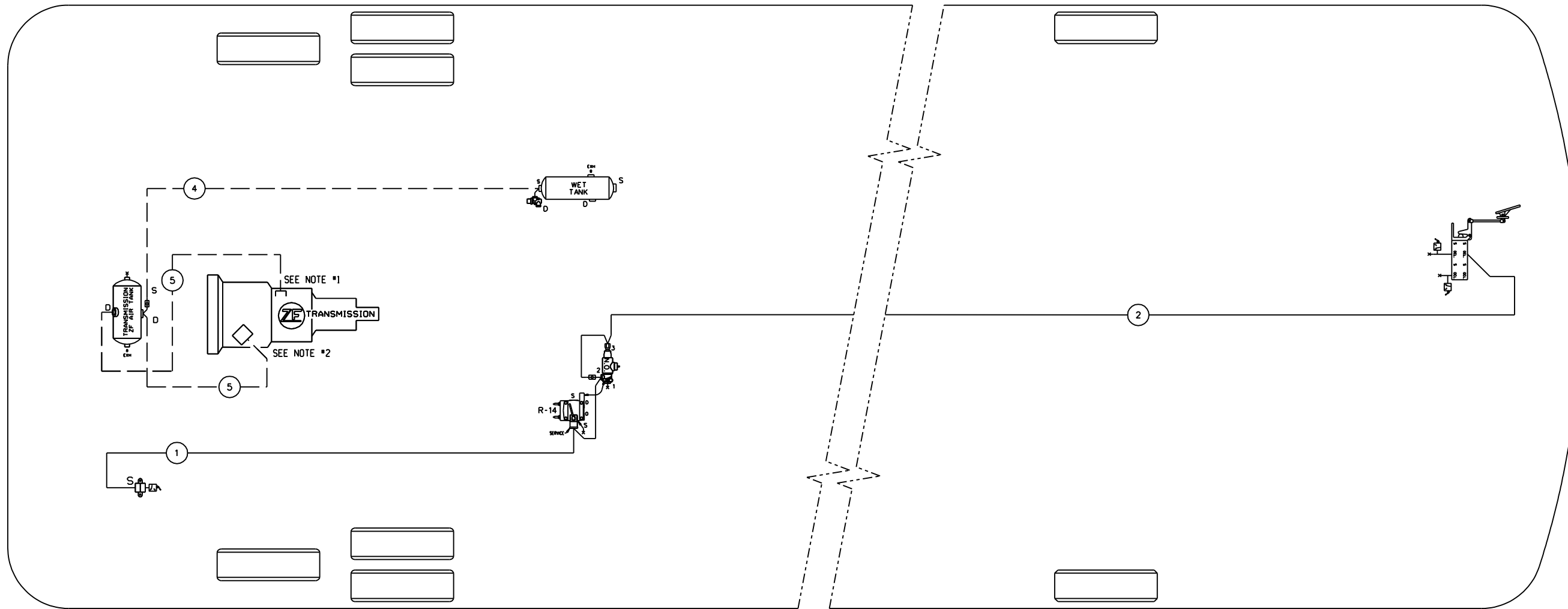

NOTE \*1: COMPRESSED AIR LINE FOR CLUTCH ACTUATOR  
 \*2: COMPRESSED AIR LINE FOR TRANSMISSION ACTUATOR  
 \*3: BASED ON \*D140300 P.1

TUBE COLOR CODING	
ACTIVE COLOR	CIRCUIT
— GREEN	PRIMARY & SUPPLY
— BLACK	ACCESSORIES

BALLOON	PIPE
*1	3/8" O.D. GREEN
*2	1/2" O.D. GREEN
*3	3/4" O.D. GREEN
*4	3/8" O.D. BLACK
*5	5/8" O.D. BLACK

**PREVOST**®

DESCRIPTION:

X3-45 COACH, WITH FRONT BEAM AXLES  
 WITH OPTION TRANSMISSION ZF

EFF. W/ VEH :

#A-9953

PAGE:

D140331 P8.1

DATE: 2010/04

REV.: C



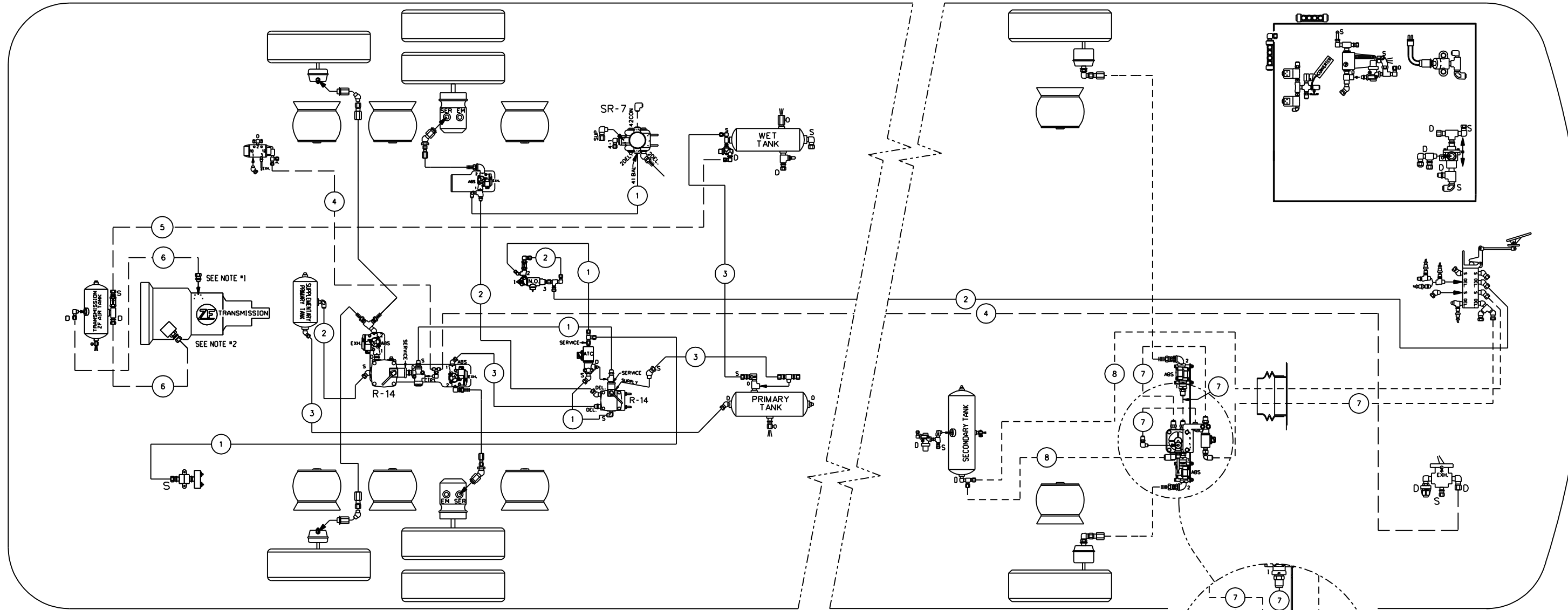

NOTE #1: COMPRESSED AIR LINE FOR CLUTCH ACTUATOR  
 #2: COMPRESSED AIR LINE FOR TRANSMISSION ACTUATOR

BALLOON	PIPE
#1	3/8" O.D. GREEN
#2	1/2" O.D. GREEN
#3	5/8" O.D. GREEN
#4	1/4" O.D. BLACK
#5	3/8" O.D. BLACK
#6	1/2" O.D. BLACK
#7	1/2" O.D. RED
#8	5/8" O.D. RED

TUBE COLOR CODING		
ACTIVE	COLOR	CIRCUIT
—	GREEN	PRIMARY & SUPPLY
---	BLACK	ACCESSORIES
- - -	RED	SECONDARY

**PREVOST**®

DESCRIPTION:  
 X3-45 COACH, WITH FRONT BEAM AXLE  
 WITH TRANSMISSION ZF & ESP ADVANCED OPTIONS

EFF. W/ VEH :  
 #8-9282...  
 DATE: 2007/05  
 REV.: A

PAGE:  
 D140331 P9.1

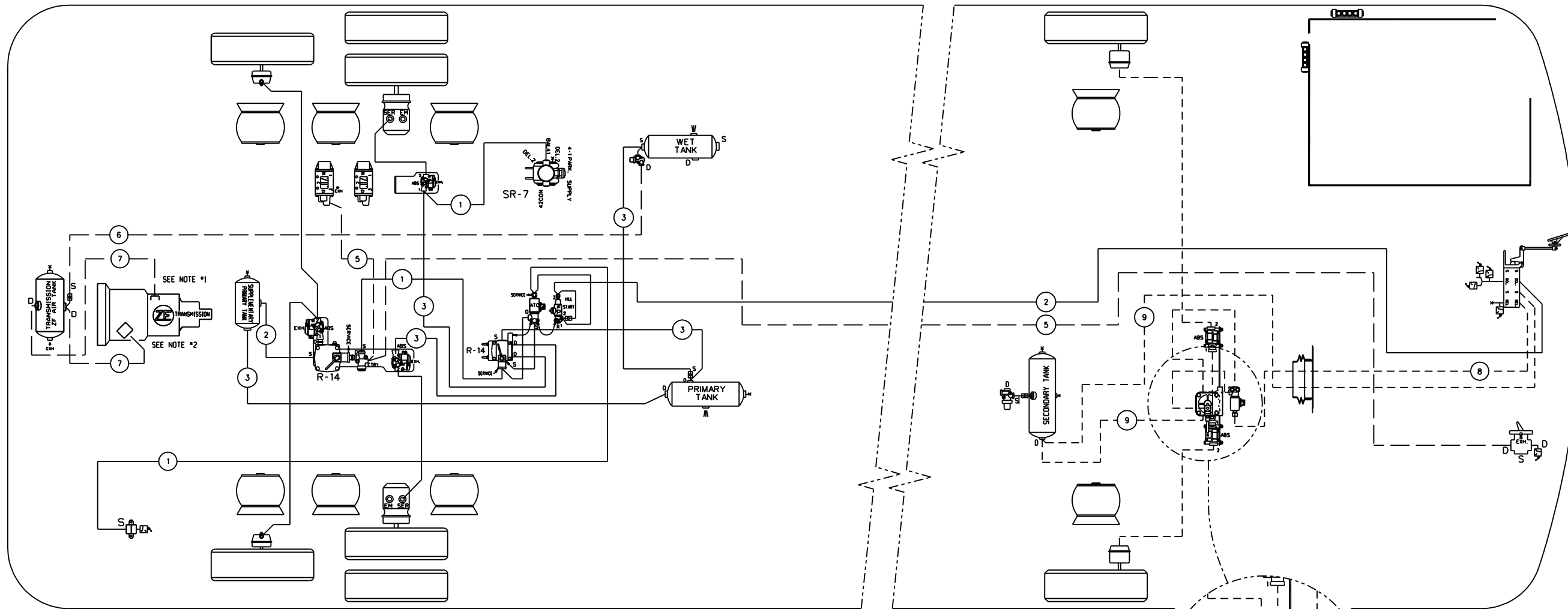

NOTE \*1: COMPRESSED AIR LINE FOR CLUTCH ACTUATOR  
 \*2: COMPRESSED AIR LINE FOR TRANSMISSION ACTUATOR

BALLOON	PIPE
*1	3/8" O.D. GREEN
*2	1/2" O.D. GREEN
*3	5/8" O.D. GREEN
*4	3/4" O.D. GREEN
*5	1/4" O.D. BLACK
*6	3/8" O.D. BLACK
*7	1/2" O.D. BLACK
*8	1/2" O.D. RED
*9	5/8" O.D. RED

TUBE COLOR CODING		
ACTIVE	COLOR	CIRCUIT
—	GREEN	PRIMARY & SUPPLY
—	BLACK	ACCESSORIES
- - -	RED	SECONDARY

**PREVOST**®

DESCRIPTION: X3-45 COACH, WITH FRONT BEAM AXLE WITH TRANSMISSION ZF & ESP BRAKE SYSTEM OPTIONS

EFF. W/ VEH : #A-9953  
 DATE: 2010/04 REV.: C

PAGE: D140331 P9.1

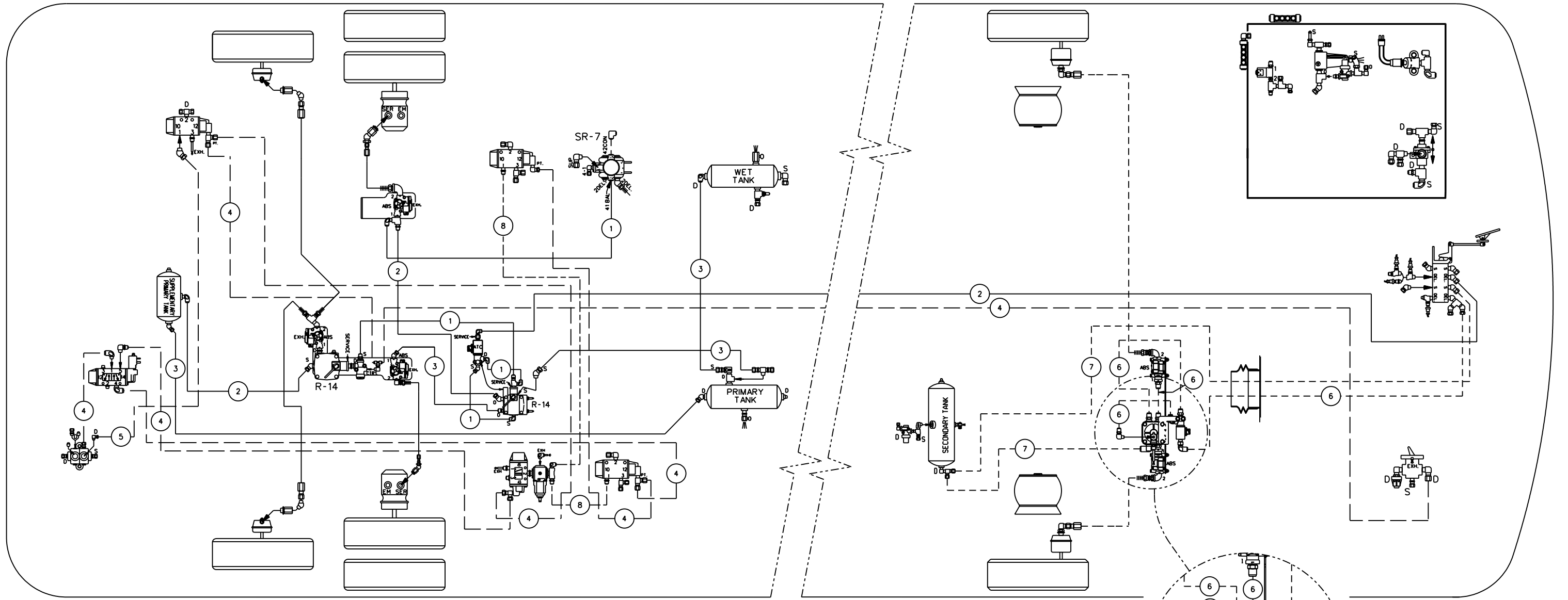

BALLOON	PIPE
*1	3/8" O.D. GREEN
*2	1/2" O.D. GREEN
*3	5/8" O.D. GREEN
*4	1/4" O.D. BLACK
*5	3/8" O.D. BLACK
*6	1/2" O.D. RED
*7	5/8" O.D. RED
*8	3/8" O.D. BLUE

TUBE COLOR CODING	
ACTIVE COLOR	CIRCUIT
— GREEN —	PRIMARY & SUPPLY
— BLACK —	ACCESSORIES
- - - RED - - -	SECONDARY

**PREVOST**®

DESCRIPTION:  
 X3-45 COACH, WITH FRONT BEAM AXLE SUSPENSION  
 WITH ESP BRAKE SYSTEM OPTION

EFF. W/ VEH :  
 #8-9282...  
 DATE: 2008/03  
 REV.: B

PAGE:  
 D140331 P10.1

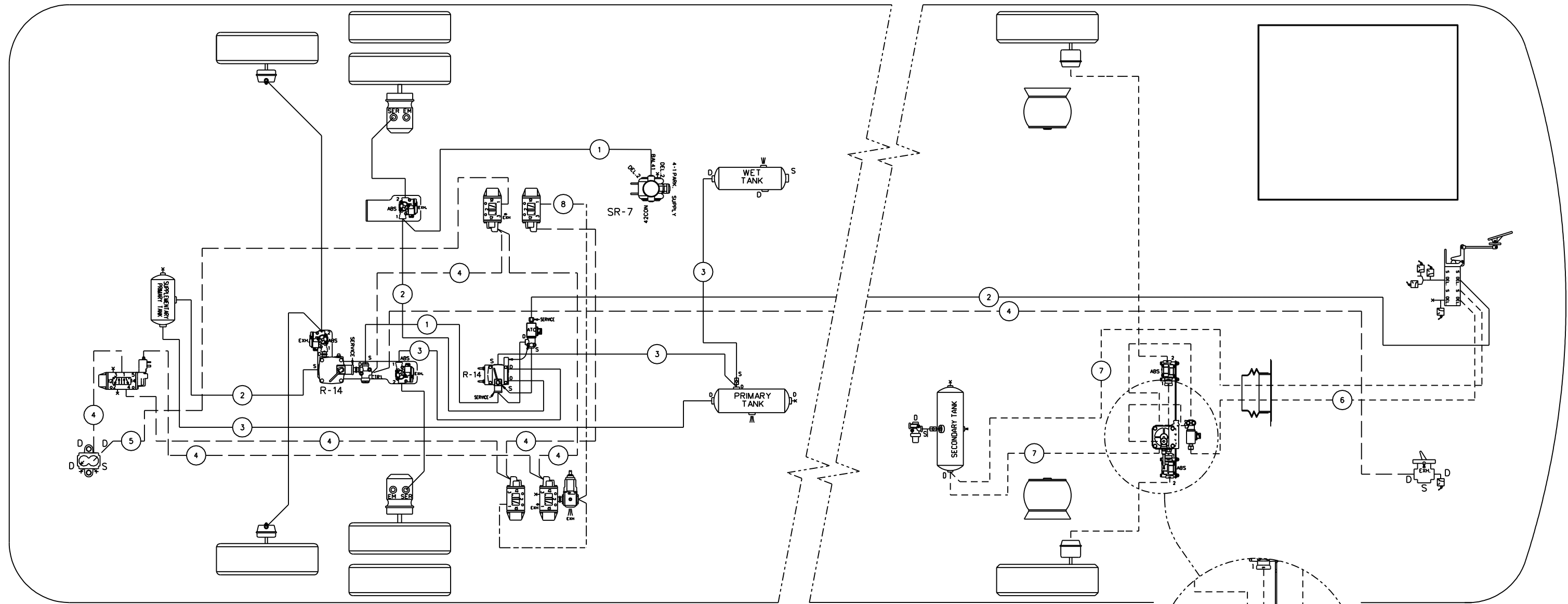

BALLOON	PIPE
*1	3/8" O.D. GREEN
*2	1/2" O.D. GREEN
*3	5/8" O.D. GREEN
*4	1/4" O.D. BLACK
*5	3/8" O.D. BLACK
*6	1/2" O.D. RED
*7	5/8" O.D. RED
*8	3/8" O.D. BLUE

TUBE COLOR CODING		
ACTIVE	COLOR	CIRCUIT
—	GREEN	PRIMARY & SUPPLY
---	BLACK	ACCESSORIES
- - -	RED	SECONDARY

**PREVOST**

DESCRIPTION:

X3-45 COACH, WITH FRONT BEAM AXLE SUSPENSION  
WITH ABS 6, ADVANCED OPTION

EFF. W/ VEH :

#A-9953

PAGE:

D140331 P10.1

DATE:

2010/04

REV.:

D

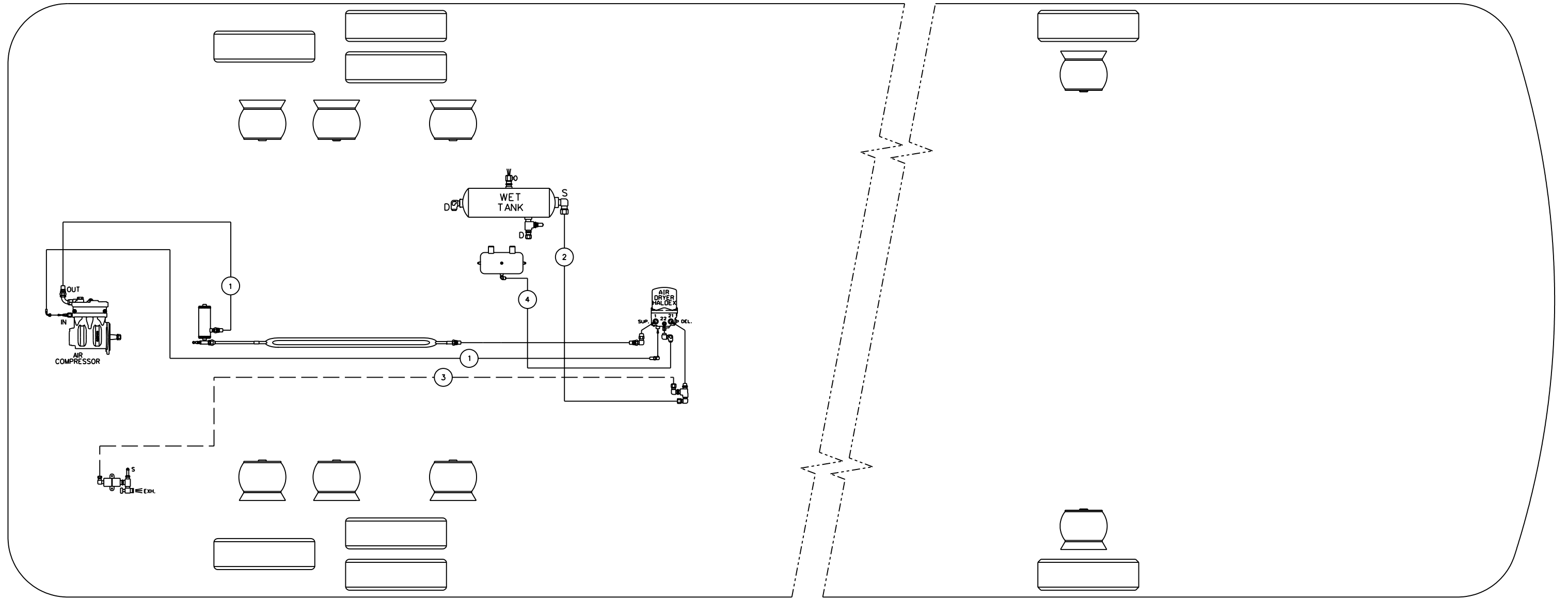

TUBE COLOR CODING		
ACTIVE	COLOR	CIRCUIT
—	GREEN	PRIMARY & SUPPLY
—	BLACK	ACCESSORIES

BALLOON	PIPE
*1	HOSE ASS'Y
*2	3/4" O.D. GREEN
*3	1/4" O.D. BLACK
*4	3/8" O.D. GREY

**PREVOST**®

DESCRIPTION:  
X3-45 COACH, MD13 VOLVO ENGINE WITH FRONT BEAM AXLE WITH  
OPTION HALDEX AIR DRYER

EFF. W/ VEH : #8-9514...  
DATE: 2008/01  
REV.: A

PAGE:  
D140331 P11.1

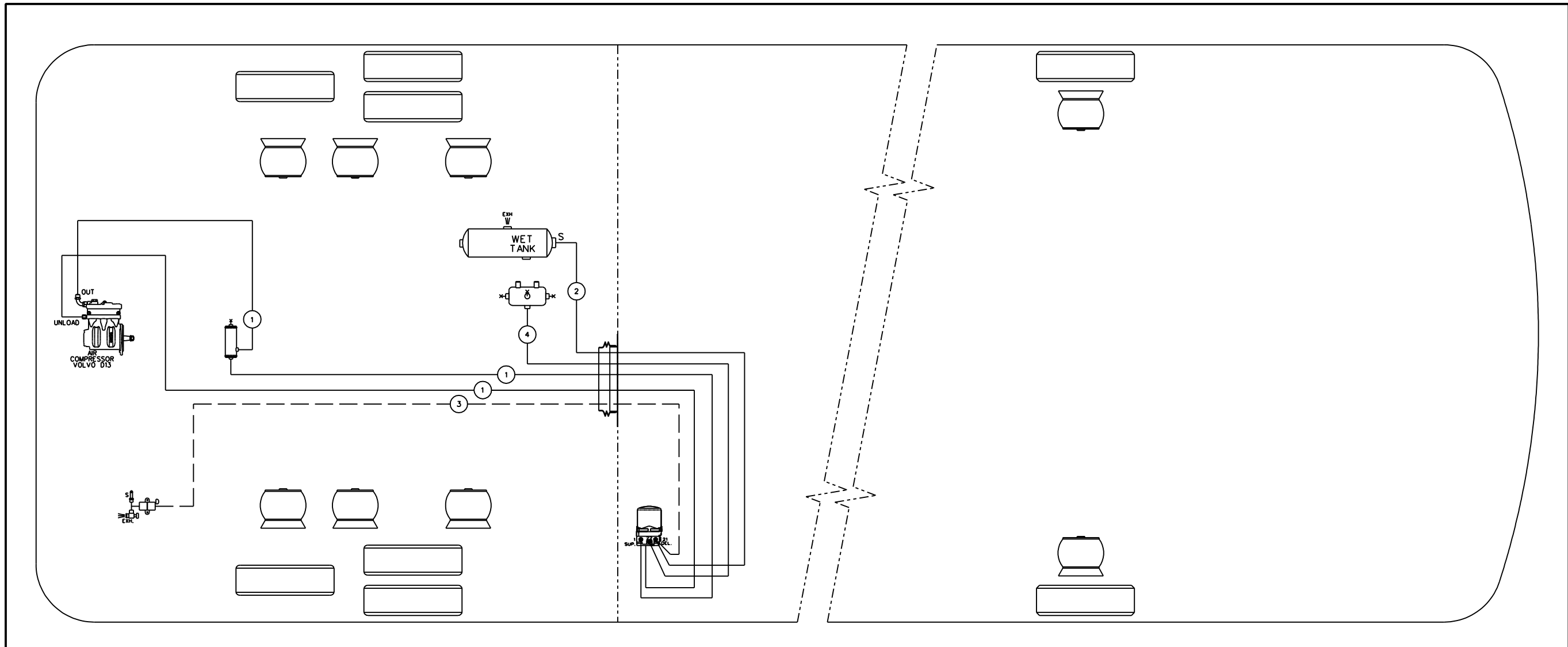

TUBE COLOR CODING	
ACTIVE COLOR	CIRCUIT
— GREEN	PRIMARY & SUPPLY
— BLACK	ACCESSORIES

BALLOON	PIPE
•1	HOSE ASS'Y
•2	3/4" O.D. GREEN
•3	1/4" O.D. BLACK
•4	3/8" O.D. GREY

**PREVOST**®

DESCRIPTION:  
X3-45 COACH, MD13 VOLVO ENGINE WITH FRONT BEAM AXLE  
WITH OPTION HALDEX AIR DRYER

EFF. W/ VEH : #A-9953  
DATE: 2010/04 REV.: B

PAGE:  
D140331 P11.1

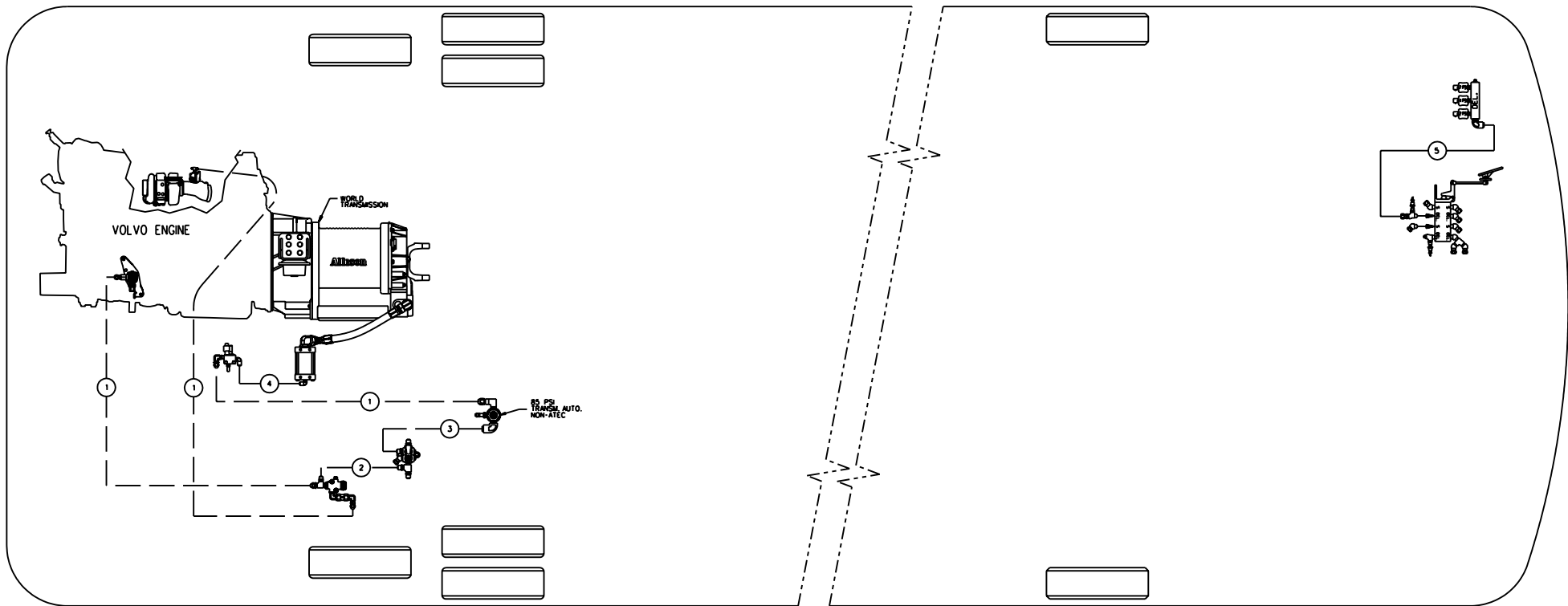

TUBE COLOR CODING	
ACTIVE COLOR	CIRCUIT
— BLACK	ACCESSORIES
— GREEN	PRIMARY & SUPPLY

BALLOON	PIPE
•1	HOSE ASS'Y
•2	1/4" O.D. BLACK
•3	3/8" O.D. BLACK
•4	1/2" O.D. BLACK
•5	3/8" O.D. GREEN

**PREVOST.**

DESCRIPTION:

X3-45 COACH, MD13 VOLVO ENGINE  
WITH FRONT BEAM AXLE  
& OUTPUT RETARDER ON WORLD TRANSMISSION

EFF. W/ VEH :

#8-9451...

PAGE:

D140331 P12.1

DATE:

2008/06

REV.:

A

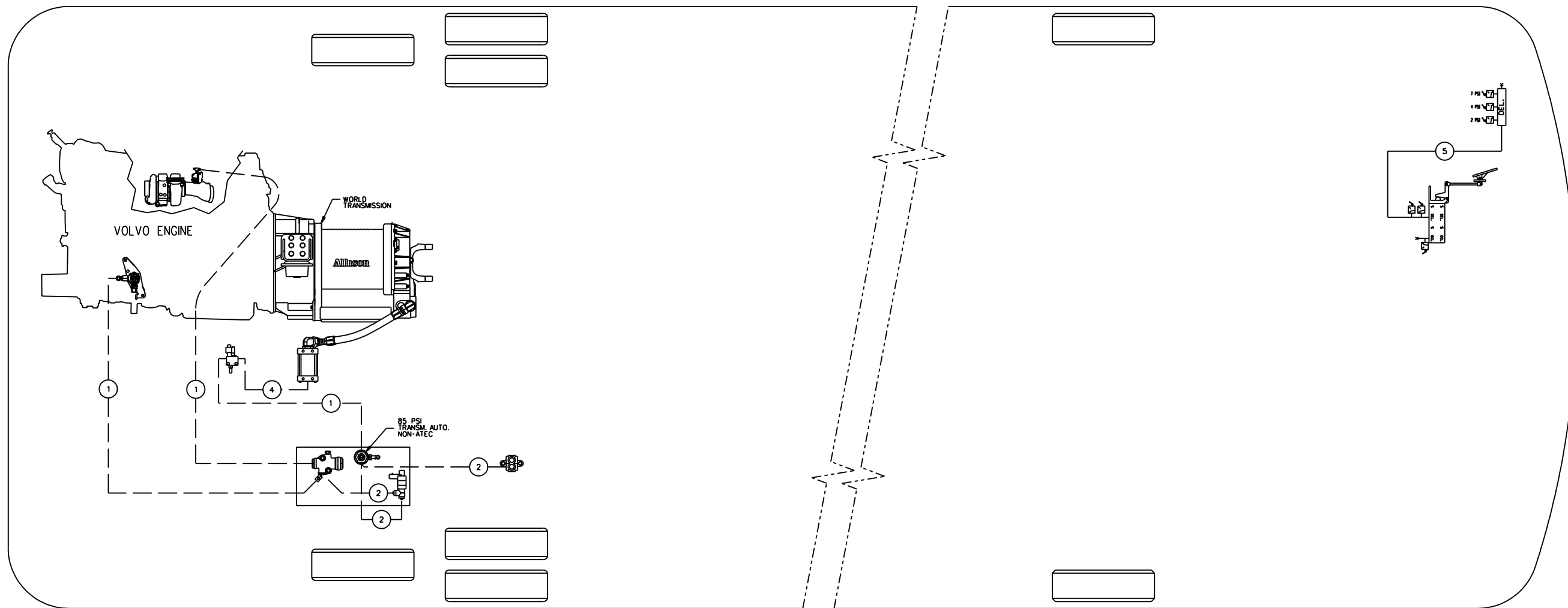

TUBE COLOR CODING		
ACTIVE	COLOR	CIRCUIT
---	BLACK	ACCESSORIES
---	GREEN	PRIMARY & SUPPLY

BALLOON	PIPE
*1	HOSE ASS'Y
*2	1/4" O.D. BLACK
*3	3/8" O.D. BLACK
*4	1/2" O.D. BLACK
*5	3/8" O.D. GREEN

**PREVOST**®

DESCRIPTION: X3-45 COACH, MD13 VOLVO ENGINE  
WITH FRONT BEAM AXLE  
& OUTPUT RETARDER ON WORLD TRANSMISSION

EFF. W/ VEH : #A-9953

DATE: 2010/04 REV.: B

PAGE: D140331 P12.1



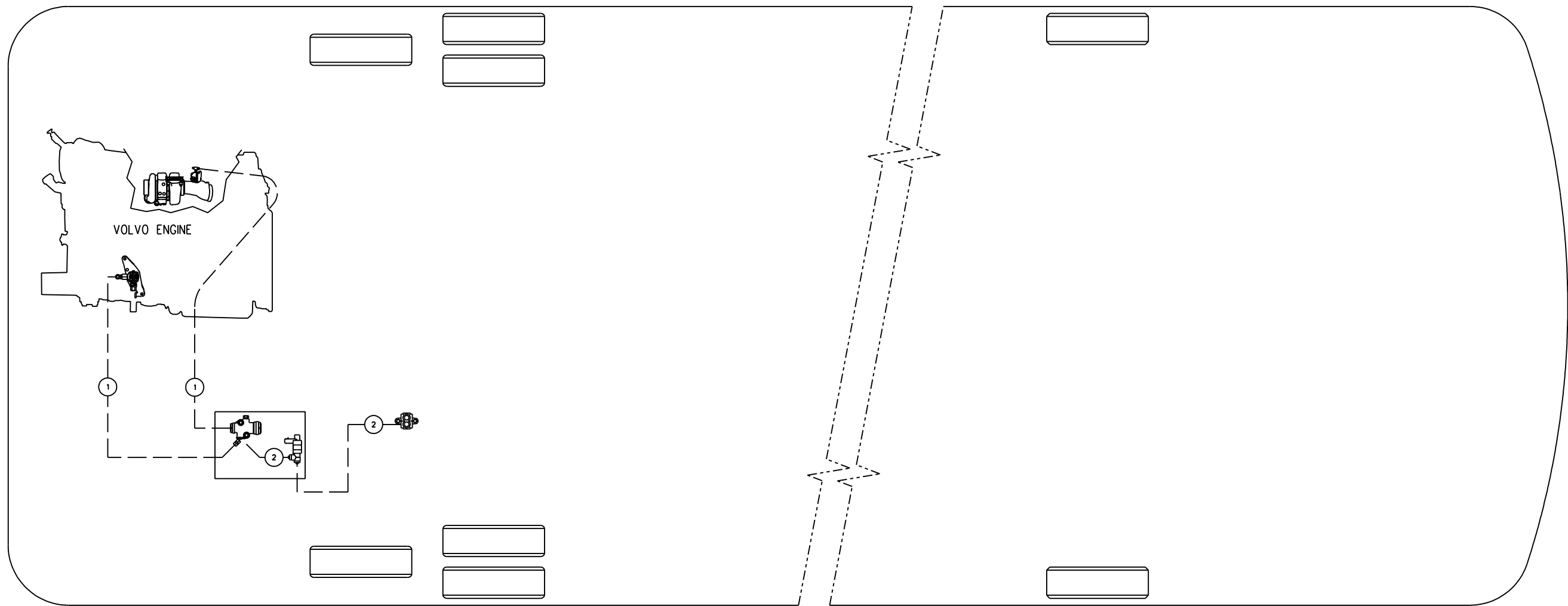

TUBE COLOR CODING		
ACTIVE	COLOR	CIRCUIT
—	BLACK	ACCESSORIES

BALLOON	PIPE
*1	HOSE ASS'Y
*2	1/4" O.D. BLACK

**PREVOST**®

DESCRIPTION:

X3-45 COACH, MD13 VOLVO ENGINE  
WITH FRONT BEAM AXLE

EFF. W/ VEH : #A-9953

PAGE:

DATE: 2010/04

REV.: B

D140331 P13.1

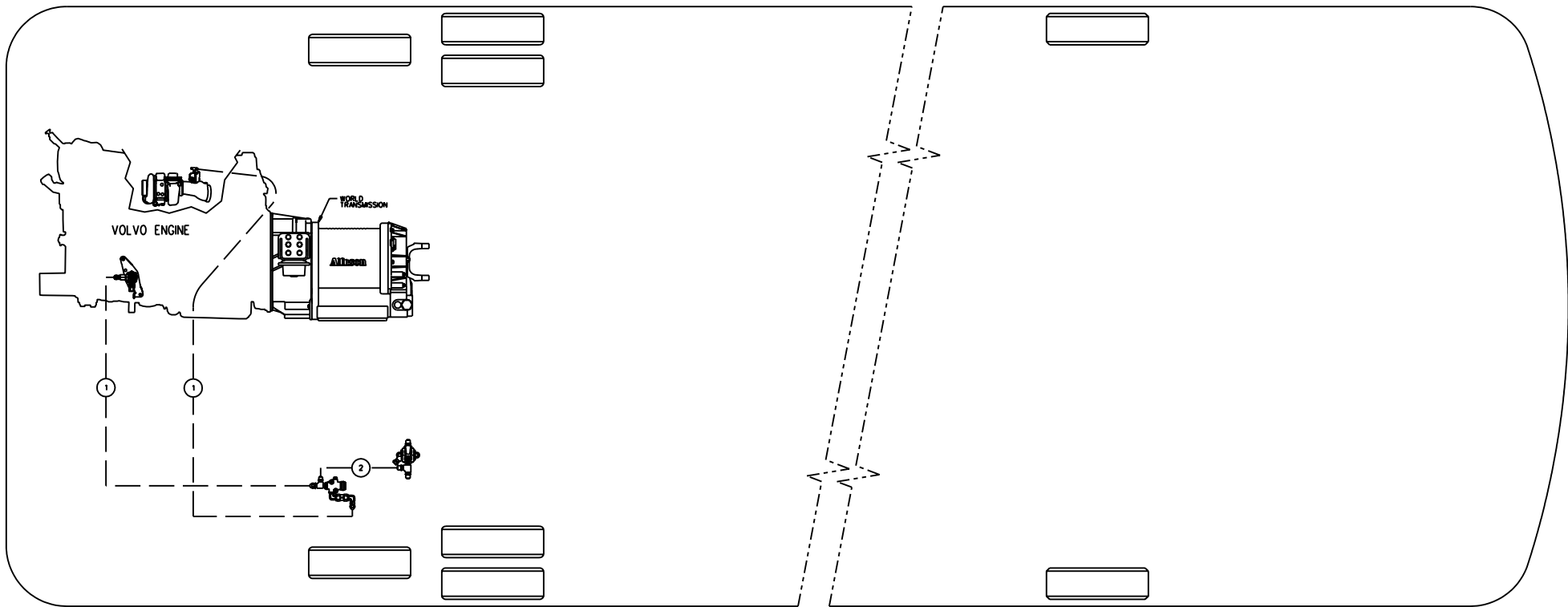

TUBE COLOR CODING	
ACTIVE COLOR	CIRCUIT
— BLACK	ACCESSORIES

BALLOON	PIPE
•1	HOSE ASS'Y
•2	1/4" O.D. BLACK

**PREVOST.**

DESCRIPTION:

X3-45 COACH, MD13 VOLVO ENGINE  
WITH FRONT BEAM AXLE, WITHOUT  
OUTPUT RETARDER ON WORLD TRANSMISSION

EFF. W/ VEH :

#8-9451...

PAGE:

D140331 P13.1

DATE:

2008/06

REV.:

A

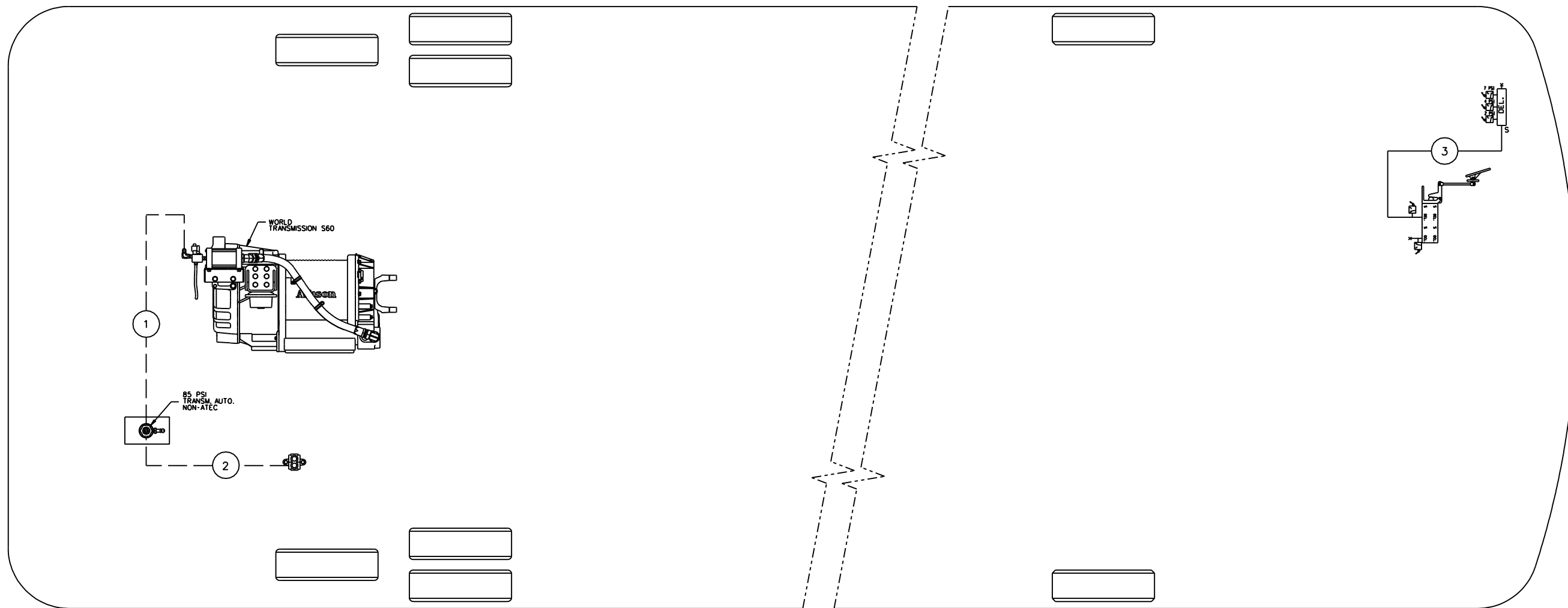

TUBE COLOR CODING		
ACTIVE	COLOR	CIRCUIT
---	BLACK	ACCESSORIES
---	GREEN	PRIMARY & SUPPLY

BALLOON	PIPE
*1	HOSE ASS'Y
*2	1/4" O.D. BLACK
*3	3/8" O.D. GREEN

**PREVOST®**

DESCRIPTION:

X3-45 COACH WITH FRONT I-BEAM AXLE  
WITH OUTPUT RETARDER ON WORLD TRANSMISSION S60

EFF. W/ VEH : #A-9953...

DATE: 2010/04

REV.: B

PAGE:

D140331 P14.1

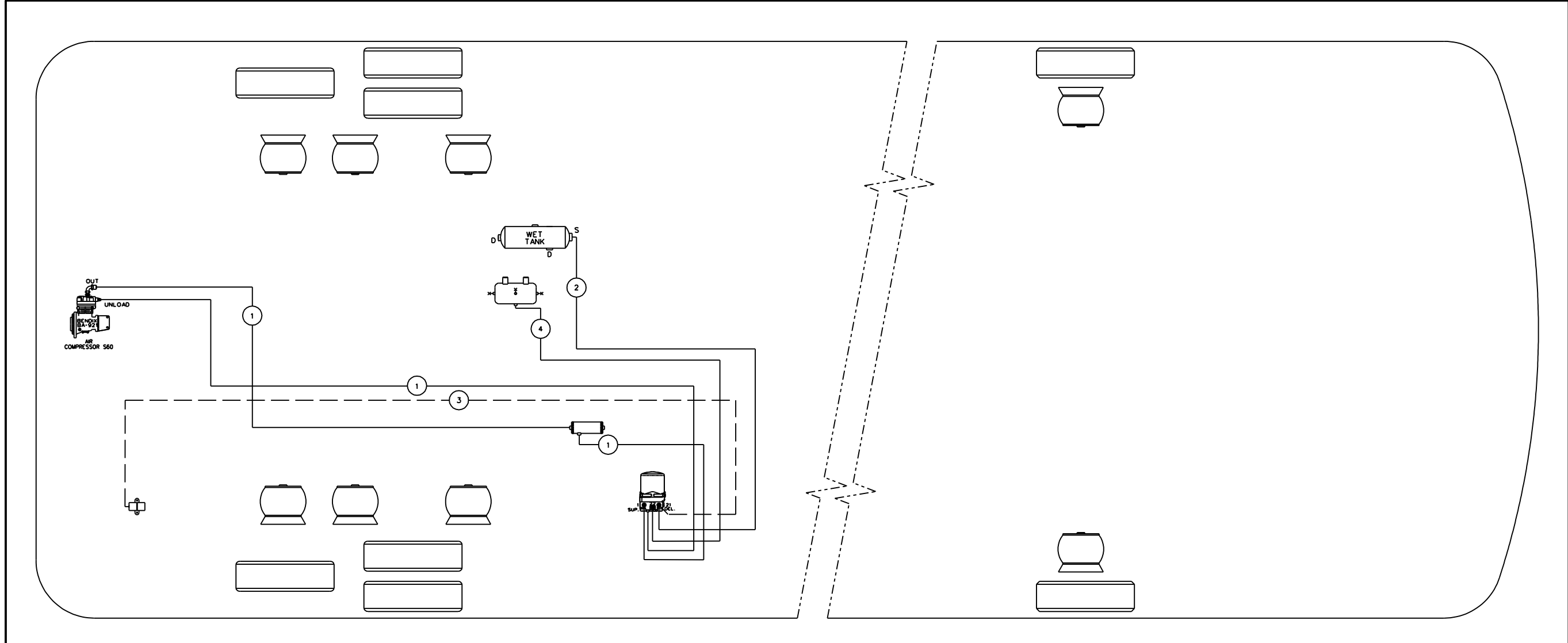

TUBE COLOR CODING	
ACTIVE COLOR	CIRCUIT
— GREEN	PRIMARY & SUPPLY
— BLACK	ACCESSORIES

BALLOON	PIPE
•1	HOSE ASS'Y
•2	3/4" O.D. GREEN
•3	1/4" O.D. BLACK
•4	3/8" O.D. GREY

**PREVOST**®

DESCRIPTION: X3-45 COACH S60, WITH FRONT BEAM AXLE WITH HALDEX AIR DRYER REAR SUB FRAME OPTION

EFF. W/ VEH : #A-9953  
 DATE: 2010/04 REV.: A

PAGE: D140331 P15.1

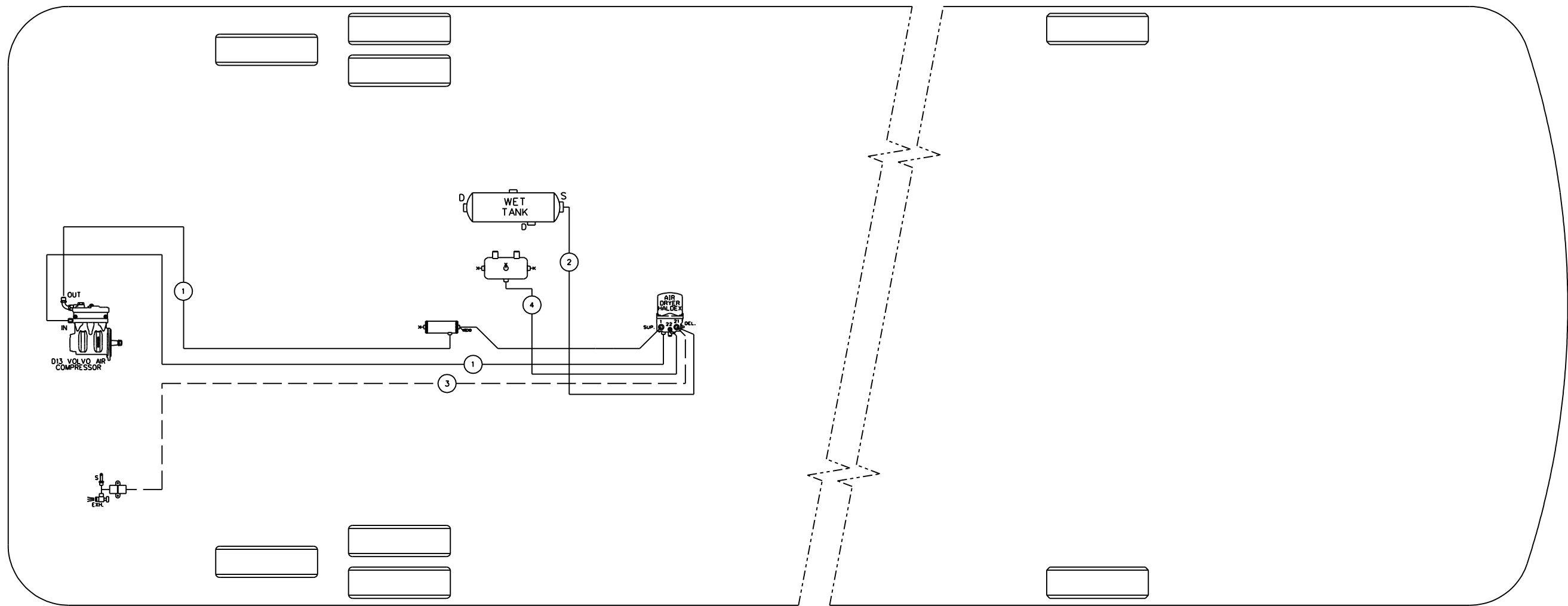

TUBE COLOR CODING		
ACTIVE	COLOR	CIRCUIT
—	GREEN	PRIMARY & SUPPLY
—	BLACK	ACCESSORIES

BALLOON	PIPE
•1	HOSE ASS'Y
•2	3/4" O.D. GREEN
•3	1/4" O.D. BLACK
•4	3/8" O.D. GREY

**PREVOST®**

DESCRIPTION:

X3-45 COACH, MD13 VOLVO ENGINE WITH FRONT BEAM AXLE WITH  
OPTION HALDEX AIR DRYER IN REAR SUB-FRAME

EFF. W/ VEH :

#A-9953

PAGE:

D140331 P16.1

DATE:

2010/04

REV.:

A