

WIRING DIAGRAM

PREVOST CAR INC. Le Mirage Bus Shell 45'



REFERENCE: ENGINE DDEC III S60 (M5)	NO: D060816 p.1/2
-------------------------------------	-------------------

EFF. W/ OC# 93042 PRIOR TO / OC#	DR. MARTIN LAFLAMME	DATE: 93-10-10
EFF. W/ VEH.# R797, R823 . . . PRIOR TO / VEH.#	CK. ROCH CHAMPAGNE	APPR. ROLAND LAPOINTE

REVISION DATE	DESCRIPTION	PAGE	BY	CK.	APPR.
93-10-19	UPDATE	1, 2	R.C.		
93-10-20	UPDATE	19, F	R.C.		
93-12-24	UPDATE PAGES: 1, 2, 3, 4, 8, 10, 12, 13, 14, 15, 16, 17, 18, 20, B, C, E, F, G, H	← SEE	R.C.		
94-01-18	UPDATE PAGES: D, 3, 4, 5, 13, 19	← SEE	R.C.		
94-01-19	RADIATOR FAN CLUTCH PRIOR TO R920 OC* 94005 PAGES: C, F, H, I, 3, 5, 12, 13	← SEE	R.C.		
94-01-19	RADIATOR FAN CLUTCH EFF. W/ R920 OC* 94005 PAGES: Ca, Fa, Ha, Ia, 3a, 5a, 12a, 13a	← SEE	R.C.		
94-04-08	UPDATE PAGES: A, E, G, K, 3, 3a, 5, 5a, 6, 7, 9, 11, 17, 18, 19	← SEE	S.G.		
94-05-20	UPDATE PAGES: D, 3a, 5a, 12, 12a, 13, 13a, 18	← SEE	S.G.		
94-05-20	FREON 134A PRIOR TO R960 OC* 94022 PAGE: 13a	← SEE	S.G.		
94-05-20	FREON 134A EFF. W/ R960 OC* 94022 PAGE: 13b	← SEE	S.G.		
94-06-14	UPDATE PAGES: A, F, Fa, 5, 5a, 6, 10, 12, 20	← SEE	S.G.		
94-09-13	WORLD TRANSMISSION HARNESS (P.E.D. CONNECTOR) PRIOR TO S424 OC* 94099	Ca, 4	S.G.		
94-09-13	WORLD TRANSMISSION HARNESS (DEUTSCH CONNECTOR) EFF. W/S424 OC* 94099	Cb, 4a	S.G.		
94-10-24	UPDATE PAGES: Cb, Ha, 12a, 13b, 18	← SEE	R.C.		
94-11-14	JACOB OR RETARDER SWITCH PRIOR TO S546 O.C.* 94155 PAGES: Cb	← SEE	S.G.		
94-11-14	JACOB OR RETARDER SWITCH EFF. W/S546 O.C.* 94155 PAGES: Cc	← SEE	S.G.		
94-11-14	UPDATE PAGES: I, IA, 12a	← SEE	S.G.		
94-11-16	WORLD TRANSM. ECU V7 PRIOR TO S464, OC* 94157	16	MJ		
94-11-16	WORLD TRANSM. ECU V7 EFF. W/S464, OC* 94157	16a	MJ		
95-02-21	SUN VISOR NEW OPTION EFF. W/S565, OC* 95015	21	MJ		
95-02-21	UPDATE PAGES: A, Cc, E, F, Fa, G, 2, 6, 10, 12, 12a, 13, 13a, 13b, 18	← SEE	MJ		
95-03-07	FIRE ALARM PRIOR TO S573, OC* 95025	5a	S.G.		
95-03-07	FIRE ALARM EFF. W/S573, OC* 95025	5b	S.G.		
95-03-07	UPDATE PAGES: B, J, G 1/2	← SEE	S.G.		

PREVOST CAR inc. Le Mirage Bus Shell 45'

NO: D060816 p. 2/2

REVISION DATE	DESCRIPTION	PAGE	BY	CK.	APPR.
95-03-07	UPDATE PRIOR TO S573, OC•94174	Cc	S.G.	<i>h</i>	<i>h</i>
95-03-07	UPDATE EFF. W/S573 OC•94174	Cd	S.G.	<i>h</i>	<i>h</i>
95-03-15	ABS IN CARRIER PRIOR TO S573 OC•94162	17	MH	<i>h</i>	<i>h</i>
95-03-15	ABS IN CARRIER EFF. W/S573 OC•94162	17a	MH	<i>h</i>	<i>h</i>
95-03-15	UPDATE PAGES: Cd, D, Fa, G, Ia, 5, 5a, 5b	← SEE	MH	<i>h</i>	<i>h</i>

INDEX

A	A/C & HEAT SYSTEM-STANDARD	P. 12	D	D.D.E.C. III	P. 3	R	RETARDER	P. 15
	A/C & HEAT SYSTEM-FULL AIR	P. 13		DIFFERENTIAL OIL TEMP.	P. 5	S	SPEEDOMETER (VDO)	P. 16
	AIR DRYER	P. 5		DRIVER'S SEAT ELEC. ADJUST.	P. 15		SUN VISOR	P. 21
	ALARM AND SIGNAL	P. 5		DRIVER'S SEAT HEATER	P. 15	T	TACHOMETER (VDO)	P. 16
	ABS	P. 17	E	ENGINE BLOCK HEATER	P. 11		TAG-UNLOAD SYSTEM	P. 19
	ARRANGEMENT - CABLE	P. B		ENGINE BRAKE SYSTEM	P. 15	W	WATER HEATER PRE-HEAT	P. 18
	ARRANGEMENT - HARNESS	P. C		ENGINE CONTROL	P. 2		WINDOW AJAR	P. 11
	ARRANGEMENT - SPARE WIRE	P. D		ENTRANCE DOOR (AIR LOCK)	P. 11		WIPER & WASHER LO & UP	P. 8
B	BACK-UP ALARM	P. 5		ETHER COLD START	P. 5		WINDSHIELD	P. 8
C	CHARGING SYSTEM	P. 1		EXTERIOR LIGHTING	P. 6		WORLD TRANSMISSION	P. 4
	CENTER DOOR-AIR LOCK	P. 11	F	FAN CLUTCH-RADIATOR	P. 5			
	CIGAR LIGHTER	P. 14		FUEL PRIME PUMP	P. 21			
	CODE - CIRCUIT NUMBER	P. E		FUEL WATER FILTER	P. 5			
	CODE - CIRCUIT BREAKER	P. F	I	INTERIOR LIGHTING	P. 9			
	CODE - CONNECTOR	P. G	L	LEVEL-LOW SYSTEM	P. 20			
	CODE - DIODE	P. H		LUGGAGE DOOR LOCK	P. 16			
	CODE - RELAY	P. I	M	MIRROR-RR VIEW ADJUST.	P. 14			
	CODE - RESISTOR	P. J		& HEATED	P. 14			
	CODE - WIRING KEY	P. K	P	PARKING BRAKE SWITCH	P. 5			
	CO-PILOT SEAT HEATER	P. 15		PARKING BRAKE ALARM	P. 11			
	CRUISE CONTROL - D.D.E.C.	P. 3		PRODRIVER	P. 11			
				PYROMETER	P. 16			

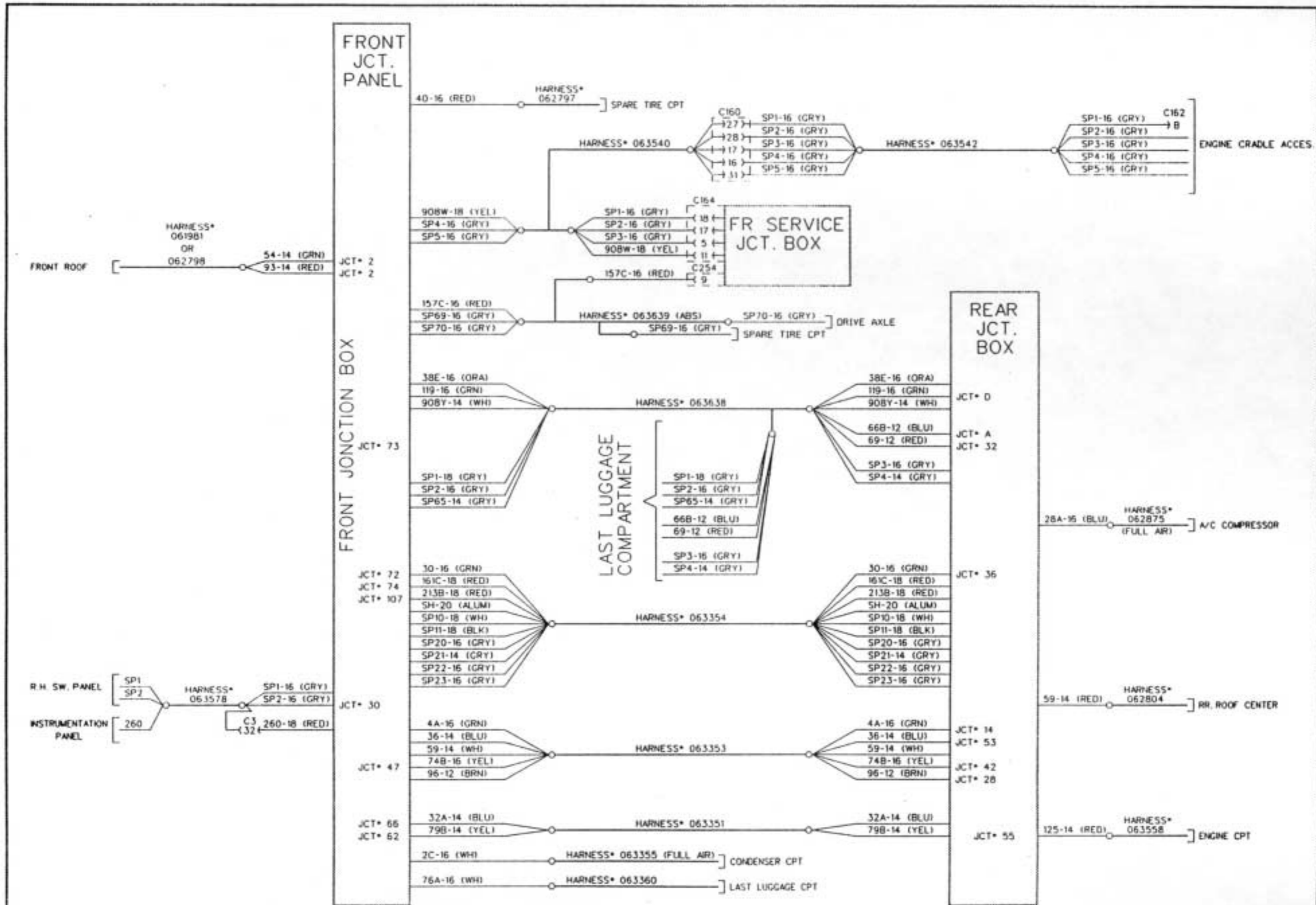

No.	SYSTEM	No.	SYSTEM
0	GRD BATTERY 1 TO BATTERY 2	10	INTERIOR LTS-LUGGAGE CPT
0	GRD BATTERY 1 TO GRD STUD	10A	INTERIOR LTS-LUGGAGE CPT
0	GRD STARTER MOTOR TO GRD STUD	10A	A/C & HEAT SYSTEM-HI PRES.
0	FJP - INSIDE GRD	10B	INTERIOR LTS-LUGGAGE CPT
0	RJB - INSIDE GRD	10D	INTERIOR LTS-LUGGAGE CPT
0	ATEC1 TEST SW GRD	10E	INTERIOR LTS-LUGGAGE CPT
0A	A/C - A/C JCT BOX GRD	12	12V CUT OUT SW TO BATTERY
0A	FJP - GRD	12	FR JCT PANEL 12V DISC SW
0A	RJB - GRD	12	ENTRANCE DOOR AIR LOCK
0AA	VOLTAGE REGULATOR GRD	12A	FR JCT PANEL 12V DISC SW
0B	FJP - GRD	12A	RR JCT BOX 12V DISC SW
0B	RJB - GRD	12A	ENTRANCE DOOR AIR LOCK
0BE	OV BATTERY MONITOR	12B	FR JCT PANEL 12V DISC SW
0C	FJP - GRD	12B	RR JCT BOX 12V DISC SW
0C	RJB - GRD	12BE	12V BATTERY MONITOR
0D	FJP - GRD	12C	FR JCT PANEL 12V DISC SW
0D	RJB - GRD	12C	RR JCT BOX 12V DISC SW
0E	FJP - GRD	12D	FR JCT PANEL 12V DISC SW
0E	RJB - GRD	12D	RR JCT BOX 12V DISC SW
0G	FJP - GRD	12E	FR JCT PANEL 12V DISC SW
0J	FJP - GRD	12E	RR JCT BOX 12V DISC SW
0P	RJB - GRD	12F	FR JCT PANEL 12V DISC SW
0S	FJB - SUN VISOR GRD	12G	FR JCT PANEL 12V DISC SW
0T	RJB - UNLOAD TAG GRD	12I	RR JCT BOX 12V IGNITION
0T	FR SERVICE CPT-GRD	12I	FR JCT PANEL 12V IGNITION
0VA	GRD BATTERY 2 TO BAT.EQUALIZER	12IA	FR JCT PANEL 12V IGNITION
0W	FJP - GRD	12IF	FR JCT PANEL 12V IGNITION
0W	WORLD TRANSM. VIM CHASSIS GRD	12T	RR JCT BOX 12V DISC SW
0WA	PRE-HEAT WATER HEATER	12T	RR JCT BOX 12V DISC SW
0WB	PRE-HEAT WATER HEATER	12V	RR JCT BOX 12V DISC SW
0X	DDEC II-COOLANT MODULE GRD	12VA	12V BATTERY POST TO EQUALIZER
0Y	ABS SYSTEM-GRD	12VD	12V HOT WIRE
0Y1	ABS SYSTEM-GRD	12VDF	12V HOT WIRE FJB
0Z	DDEC II-COOLANT MODULE GRD	12VDR	12V HOT WIRE RJB
00	BATTERY GRD	12VF	12V FR JCT PANEL
2	A/C & HEAT SYSTEM-CONSENSER	12VIF	FR JCT PANEL 12V IGNITION
2A	A/C & HEAT SYSTEM-CONSENSER	12VIR	RR JCT BOX 12V IGNITION
2D	A/C & HEAT SYSTEM-CONSENSER	12VR	12V RR JCT BOX
3	A/C & HEAT SYSTEM-EVAPORATOR	12W	12V HOT WIRE DDEC III FEED
3A	A/C & HEAT SYSTEM-CLUTCH SW	13A	ALARM & SIGNAL-LO AIR PRIM.
6	A/C & HEAT SYSTEM-EVAPORATOR	13B	ALARM & SIGNAL-LO AIR SEC.
6A	EXTERIOR LTS-DOCKING	15	EXTERIOR LTS-MULTI FUNC LEVEL
6B	EXTERIOR LTS-CORNERING	15	ALARM & SIGNAL-DIF. OIL TEMP
6B1	EXTERIOR LTS-CORNERING	15	WIPER & WASHER SYSTEM
6C	EXTERIOR LTS-CORNERING RH	15A	ALARM & SIGNAL-DIF. OIL TEMP
6C1	EXTERIOR LTS-CORNERING LH	16	SPEEDOMETER SIGNAL (+)
6D	EXTERIOR LTS-DOCKING	16T	SPEED SW SIGNAL IN (+)
6E2	EXTERIOR LTS-CORNERING LH	17	EXTERIOR LTS-FLASHER UNIT
6F1	EXTERIOR LTS-CORNERING RH	17A	EXTERIOR LTS-FLASHER UNIT
7	ENTRANCE DOOR	18	ETHER COLD START SYST.
8A	DDEC II-STP ENG. OVERRIDE	19	SPARE - RJB TO RR ROOF RH
9	INTERIOR LTS-ENGINE CPT	20	SPEEDOMETER SIGNAL (-)
9	INTERIOR LTS-RR JCT BOX	20T	SPEED SW SIGNAL IN (-)
9	INTERIOR LTS-FR SERVICE CPT	21	EXTERIOR LTS-DIRECTIONNAL LH
9A	INTERIOR LTS-FR JCT PANEL	21A	EXTERIOR LTS-DIRECTIONNAL LH
9B	INTERIOR LTS-FR JCT PANEL	21B	EXTERIOR LTS-DIRECTIONNAL LH
9C	INTERIOR LTS-FR SERVICE CPT	21C	EXTERIOR LTS-DIRECTIONNAL LH
9E	INTERIOR LTS-LUGGAGE CPT	21H	EXTERIOR LTS-HAZARD SIGNAL
10	A/C & HEAT SYSTEM-LO PRES.	23	EXTERIOR LTS-DIRECTIONNAL RH

No.	SYSTEM	No.	SYSTEM
23A	EXTERIOR LTS-DIRECTIONNAL RH	36C	ENGINE BRAKE SYSTEM
23B	EXTERIOR LTS-DIRECTIONNAL RH	38	FUEL WATER FILTER
23C	EXTERIOR LTS-DIRECTIONNAL RH	39	INTERIOR LTS-DRIVER'S LTS
23H	EXTERIOR LTS-HAZARD SIGNAL	39A	INTERIOR LTS-DRIVER'S LTS
24	BATTERY 3 TO BATTERY 4	39B	INTERIOR LTS-DRIVER'S LTS
24	BATTERY 4 TO 24V DISC SW	39C	INTERIOR LTS-DRIVER'S LTS
24A	RR JCT BOX 24V DISC SW	40	SPARE - F.J.PANEL TO F.SERV CPT
24A	FR JCT PANEL 24V DISC SW	43	A/C & HEAT SYSTEM-FULL AIR
24B	RR JCT BOX 24V DISC SW	44	EXTERIOR LTS-FOG
24B	FR JCT PANEL 24V DISC SW	44A	EXTERIOR LTS-FOG
24BE	BATTERY MONITOR	44B	EXTERIOR LTS-FOG
24C	RR JCT BOX 24V DISC SW	44C	EXTERIOR LTS-FOG & HAZARD SW
24C	FR JCT PANEL 24V DISC SW	45	A/C & HEAT SYSTEM-DRIVER'S CTRL
24E	FR JCT PANEL 24V DISC SW	45	A/C & HEAT SYSTEM-FULL AIR
24E	RR JCT BOX 24V DISC SW	45A	A/C & HEAT SYSTEM-FULL AIR
24F	FR JCT PANEL 24V DISC SW	45G	A/C & HEAT SYSTEM-DRIVER'S HTR
24G	FR JCT PANEL 24V DISC SW	46	EXTERIOR LTS-MARKER
24I	FR JCT PANEL 24V IGNITION	46A	EXTERIOR LTS-MARKER
24I	RR JCT BOX 24V IGNITION	46B	EXTERIOR LTS-MARKER
24IA	FR JCT PANEL 24V IGNITION	46C	EXTERIOR LTS-MARKER
24IA	RR JCT BOX 24V IGNITION	47	A/C & HEAT SYSTEM-DRIVER'S HTR
24IB	FR JCT PANEL 24V IGNITION	47	A/C & HEAT SYSTEM-FULL AIR
24IB	RR JCT BOX 24V IGNITION	50	AIR DRYER
24IF	FR JCT PANEL 24V IGNITION	52	ALARM & SIGNAL-ELEC. HORN
24P	FR JCT PANEL 24V DISC SW	52A	ALARM & SIGNAL-ELEC. HORN
24R	24V RR JCT BLK TO STARTER	53	ALARM & SIGNAL-ELEC. HORN
24S	FJP 24V DISC SW-SUN VISOR	53B	WIPER & WASHER SYSTEM
24T	FR JCT PANEL 24V DISC SW	53C	WIPER & WASHER SYSTEM
24VA	24V BATTERY POST TO EQUALIZER	53E	WIPER & WASHER SYSTEM
24VI	FR JCT PANEL 24V IGNITION	53F	WIPER & WASHER SYSTEM
24VIF	FR JCT PANEL 24V IGNITION	53J	WIPER & WASHER SYSTEM
24VIR	RR JCT BOX 24V IGNITION	54	SPARE-F.J.B. TO FR ROOF
24VD	24V HOT WIRE	55	EXTERIOR LTS-HI BEAM
24VF	FR JCT PANEL 24V DISC SW	56	TRANSM. OIL TEMP GAUGE
24VR	RR JCT BOX 24V DISC SW	57	EXTERIOR LTS-HI BEAM
24X	24V SPEED SW & LEVEL LOW	57	A/C & HEAT SYSTEM-WATER PUMP
25	12VAC GEN RLY ON SIGNAL	57A	EXTERIOR LTS-HI BEAM
25A	NOT GENERATOR-WARNING LT	57B	A/C & HEAT SYSTEM-WATER PUMP
25B	EXTERIOR LTS-DAYTIME RUN LTS	57C	PRE-HEAT WATER HEATER
25C	12VAC GEN RLY ON SIGNAL	57C	A/C & HEAT SYSTEM-WATER PUMP
25K	12VAC GEN RLY ON SIGNAL	57D	PRE-HEAT WATER HEATER
25L	12VAC GEN RLY ON SIGNAL	57E	PRE-HEAT WTR HTR PUMP
26A	ATEC1-NEUTRAL SIGNAL	57F	PRE-HEAT WATER HEATER
28	A/C & HEAT SYSTEM-WARNING LT	58	EXTERIOR LTS-LO BEAM
28A	A/C & HEAT SYSTEM-WARNING LT	58A	EXTERIOR LTS-LO BEAM
29	A/C & HEAT SYSTEM-DRIVER'S HTR	58B	EXTERIOR LTS-LO BEAM
29A	A/C & HEAT SYSTEM-DRIVER'S HTR	58E	EXTERIOR LTS-LO BEAM
29B	A/C & HEAT SYSTEM-DRIVER'S HTR	59A	ENGINE BRAKE SYSTEM
31	A/C & HEAT SYSTEM-WARNING LT	60	EXTERIOR LTS-RR & FR ROOF GRD
31A	A/C & HEAT SYSTEM-WARNING LT	61	EXTERIOR LTS-24V FEED SW
31A	A/C & HEAT SYSTEM-PRESSURE SW	61A	EXTERIOR LTS-HEAD SIGNAL
31B	A/C & HEAT SYSTEM-PRESSURE SW	62	LEVEL-LOW SYSTEM
31B	WIPER & WASHER SYSTEM	63	EXTERIOR LTS-CLEARANCE
32	EXTERIOR LTS-BACK-UP	63A	EXTERIOR LTS-CLEARANCE
32B	EXTERIOR LTS-BACK-UP	63B	EXTERIOR LTS-CLEARANCE
32D	BACK-UP ALARM	63C	EXTERIOR LTS-MARKER SIGNAL
34	A/C & HEAT SYSTEM-CONDENSER	63D	EXTERIOR LTS-MARKER & TAIL
35	INTERIOR LTS-ENTRANCE DOOR	63E	EXTERIOR LTS-CLEARANCE
36	ENGINE BRAKE SYSTEM & RETARDER	63F	EXTERIOR LTS-MARKER BLINKER
36A	ENGINE BRAKE SYSTEM		

No.	SYSTEM	No.	SYSTEM
63H	EXTERIOR LTS-TAIL	90F	CHARG SYST-VOLTAGE REGUL. "B"
63K	EXTERIOR LTS-TAIL	91	PARKING BRAKE SW SIGNAL
64	DIFFERENTIAL OIL TEMP GAUGE	91A	PARKING BRAKE SW SIGNAL
65A	CENTER DOOR AIR LOCK	91B	DDEC III-FAST IDLE SIGNAL
65A	LOW FUEL T.T. LT.	91B	EXTERIOR LTS-RUN LTS CANCEL
67	A/C & HEAT SYSTEM	91M	PARKING BRAKE ALARM
67A	A/C & HEAT SYSTEM	91N	PARKING BRAKE ALARM
67B	A/C & HEAT SYSTEM	92	BATTERY EQUALIZER-CHECK BALANCE
67C	A/C & HEAT SYSTEM	93	BATTERY EQUALIZER-CHECK LO/HI
70B	ENGINE CONTROL SW - 24V IGN.	95	ENGINE BRAKE & RETARDER SYSTEM
71	BACK-UP CANCEL SW	95A	ENGINE BRAKE & RETARDER SYSTEM
71B	BACK-UP CANCEL SW	95B	ENGINE BRAKE & RETARDER SYSTEM
72	BACK-UP CANCEL SW	97	TACHOMETER-NOT USE
72	SPARE F.J.B. TO R.J.B.	99	UNLOAD TAG SYSTEM
72	SPARE F.J.B. TO R.J.B.	99A	FR SERVICE JCT BOX 12V HOT WIRE
72B	SUN VISOR	100B	BACK-UP CANCEL SW
72C	SUN VISOR	101	24V DISC SW TO STARTER
72D	SUN VISOR	101	WORLD TRANSM-LO SIGNAL SOL. LO
72E	SUN VISOR	102	24V STARTER TO GENERATOR
72S	SUN VISOR	102	24V DISC SW TO A/C JCT BOX
76	FUEL TANK GAUGE	102	WORLD TRANSM-SOL. GRD 1
76A	CENTER DOOR AJAR LT	102	WORLD TRANSM-SOL. C3
76L	LOW FUEL LT	104	LEVEL-LOW SYSTEM
76M	FUEL PRIME PUMP	104	WORLD TRANSM-SOL. FORWARD
76P	FUEL PRIME PUMP	105	WORLD TRANSM-RETARDER & SUMP
77	A/C & HEAT SYSTEM	106	WORLD TRANSM-OIL LEVEL HI
77B	A/C & HEAT SYSTEM	107	CHARG SYST-VOLTAGE REGUL. "F"
77C	A/C & HEAT SYSTEM-COMPRESSOR	107	WORLD TRANSM-LOCKUP SOL. HI
77H	A/C & HEAT SYSTEM-FAN CLUTCH	108	WORLD TRANSM-REMOTE PWR WAKE UP
80	WORLD TRANSM-NEUTRAL SIGNAL GRD	109	WORLD TRANSM-RET. SOL. LO
81	EXTERIOR LTS-STOP SW	110	ALARM & SIGNAL-WATER TEMP
82	EXTERIOR LTS-STOP SIGNAL	110	WORLD TRANSM-LOCKUP SOL. LO
82A	EXTERIOR LTS-STOP SIGNAL	111	BATTERY GRD
82B	EXTERIOR LTS-STOP LTS	111	WORLD TRANSM-SOL. C6
82K	EXTERIOR LTS-STOP RETARDER	112	WORLD TRANSM-SPARE OUTPUT (+)
82L	EXTERIOR LTS-STOP LTS	112	BACK-UP SIGNAL
82R	EXTERIOR LTS-STOP LTS	113	ALARM & SIGNAL-OIL PRESS
83	ENGINE CTR-MAST KEY SW ACCES	113	WORLD TRANSM-REVERSE WARNING
83A	DDEC II-COOLANT LEVEL PROBE	114	WORLD TRANSM-SPARE OUTPUT (-)
84	ENGINE CTR-MAST KEY SW START	114	INTERIOR LTS-DASH LT REGUL.
84A	ENGINE CTR-MAST KEY SW START	114A	INTERIOR LTS-DASH LT
85	ENGINE CTR-MAST KEY SW IGN	114B	INTERIOR LTS-DASH LT REGUL.
85A	24V IGN DASH INSTRUMENTATION	114C	INTERIOR LTS-DASH LT
85B	ENGINE CTR-24V IGNITION	115	ALARM & SIGNAL-TAG PRESS
85C	PARKING BRAKE SWITCH	115	DDEC III-COOLANT LEVEL
85F	LO AIR SONALERT	115	WORLD TRANSM-DO NOT SHIFT SIGNAL
85W	ABS-24V IGN	115A	ALARM & SIGNAL-TAG PRESS
85X	ABS-24V IGN	115B	ALARM & SIGNAL-TAG PRESS
85Y	ABS-WARNING LT	115C	DDEC III-COOLANT LEVEL
86	ENGINE CTR-STARTER SOL SIGN	116	WORLD TRANSM-LO SIGNAL SOL. HI
86A	ENGINE CTR-STARTER SOL SIGN	116A	A/C & HEAT SYSTEM-DRIVER'S HTR
87B	ENGINE CTR-24V IGNITION	116B	A/C & HEAT SYSTEM-DRIVER'S HTR
88	ENGINE CTR-RR START SIGNAL	117	WORLD TRANSM-SPARE INPUT (-)
89	ENGINE CTR-RR START SIGNAL	117	ALARM & SIGNAL-TRANSM OIL TEMP
90	A/C & HEAT SYSTEM-WATER PUMP	117A	ALARM & SIGNAL-TRANSM OIL TEMP
90A	ENGINE CTR-MAST KEY SW FEED	118	WORLD TRANSM-SPARE INPUT (+)
90B	A/C & HEAT SYSTEM-COND FAN MOT	118	DRIVER'S & CO-PILOT SEAT HTR
90B	ENGINE CTR-MAST KEY SW FEED	118A	DRIVER'S & CO-PILOT SEAT HTR
90B	FR JCT PANEL 24V DISC SW	119	WORLD TRANSM-ENGINE BRAKE
90C	ALARM & SIGNAL-FIRE DETECTOR		

No.	SYSTEM	No.	SYSTEM
120	12V HOT WIRE-DISC SW TO FJP	136X	WORLD TRANSM-12V BATTERY
120	WORLD TRANSM-SOL. C1	137	WORLD TRANSM-RETARDER
121	WORLD TRANSM-SOL. GRD 2	137	RR VIEW MIRROR
121	CIGAR LIGHTER	137	RR VIEW MIRROR
122	A/C & HEAT SYSTEM-DRIVER'S HTR	137A	RR VIEW MIRROR
122	A/C & HEAT SYSTEM-FRESH AIR	138	WORLD TRANSM-RETARDER TEMP
122	WORLD TRANSM-SOL. GRD 4	138	ABS SYSTEM
123	WORLD TRANSM-NEUTRAL START	138A	ABS SYSTEM
123	ALARM & SIGNAL-FIRE DETECTOR	139	ABS SYSTEM
123A	ALARM & SIGNAL-FIRE DETECTOR	139	WORLD TRANSM-OUTPUT SPEED HI
124	WORLD TRANSM-THROTTLE (HI)	140	WORLD TRANSM-OUTPUT SPEED LO
125	WORLD TRANSM-RETARDER INDICATOR	140	ABS SYSTEM
125W	WORLD TRANSM-RETARDER INDICATOR	141	ABS SYSTEM
126	WORLD TRANSM-LUBE PRESS SW.	141	WORLD TRANSM-ENGINE SPEED HI
126	CENTER DOOR AIR LOCK	142	WORLD TRANSM-SERIAL COM. A
126	FR SERVICE JCT BOX 12V HOT WIRE	142	ABS SYSTEM
127	WORLD TRANSM-RETARDER FEED SOL.	142	ABS SYSTEM
127	PRE-HEAT WATER HEATER	143	ABS SYSTEM
127A	PRE-HEAT WATER HEATER	143A	ABS SYSTEM
127W	PRE-HEAT WATER HEATER	143	WORLD TRANSM-ECU BATTERY GRD
127X	PRE-HEAT WATER HEATER	143W	WORLD TRANSM-BATTERY GRD
128	WORLD TRANSM-SOL. C2	143X	WORLD TRANSM-BATTERY GRD
128A	PRE-HEAT WATER HEATER	144	WORLD TRANSM-ECU CHASSIS GRD
128B	PRE-HEAT WATER HEATER	144	ABS SYSTEM
128C	PRE-HEAT WATER HEATER	144A	ABS SYSTEM
128D	PRE-HEAT WATER HEATER	145	ABS SYSTEM
128W	PRE-HEAT WATER HEATER	146	ABS SYSTEM
128X	PRE-HEAT WATER HEATER	146	WORLD TRANSM-IGNITION SENSE
129	WORLD TRANSM-SOL. C5	146W	WORLD TRANSM-12V IGNITION
129	PRE-HEAT WATER HEATER	146X	WORLD TRANSM-12V IGNITION
129A	PRE-HEAT WATER HEATER	147	WORLD TRANSM-OIL TEMP
129B	PRE-HEAT WATER HEATER	147	ABS SYSTEM
130	WORLD TRANSM-SOL. GRD 3	147	ETHER COLD START
130	A/C & HEAT SYSTEM-EVAPORATOR	147C	ETHER COLD START
131	24V DISC SW TO FR JCT PANEL	148	ABS SYSTEM
131	WORLD TRANSM-SOL. C4	148	WORLD TRANSM-OUTPUT SPEED LO
132	WORLD TRANSM-ENGINE BRAKE	149	WORLD TRANSM-TURBINE SPEED HI
132B	LEVEL-LOW SYSTEM	149	ABS SYSTEM
132C	LEVEL-LOW SYSTEM	149A	ABS SYSTEM
132D	LEVEL-LOW SYSTEM	150	ABS SYSTEM-SPARE
132E	LEVEL-LOW SYSTEM	150	WORLD TRANSM-ENGINE SPEED LO
132W	WORLD TRANSM-ENGINE BRAKE	150	DDEC III-ECM BATTERY GRD
132-1A	LEVEL-LOW SYSTEM	150A	DDEC III-ECM BATTERY GRD
132-1B	LEVEL-LOW SYSTEM	151	DDEC III-ECM BATTERY GRD
132-1C	LEVEL-LOW SYSTEM	151	WORLD TRANSM-SERIAL COM. B
132-2A	LEVEL-LOW SYSTEM	151	ABS SYSTEM-SPARE
132-2B	LEVEL-LOW SYSTEM	152	ABS SYSTEM-SPARE
132-2C	LEVEL-LOW SYSTEM	153	ABS SYSTEM
133	WORLD TRANSM-RET. ACTUATOR HI	153	ELECTRICAL DRIVER'S SEAT
134	WORLD TRANSM-RET. APPLY SOL. HI	153	WORLD TRANSM-SPARE INPUT (-)
135	WORLD TRANSM-ANALOG GRD	154	WORLD TRANSM-ABS INPUT
135	A/C & HEAT SYSTEM-AIR SENSOR	155	WORLD TRANSM-SPARE INPUT (-)
135A	A/C & HEAT SYSTEM-AIR SENSOR	155	ABS SYSTEM
135C	A/C & HEAT SYSTEM-AIR SENSOR	156	WORLD TRANSM-THROTTLE POS. SIGNAL
135D	A/C & HEAT SYSTEM-AIR SENSOR	156	ABS SYSTEM
136	GALLEY-ACCESSORIES	156A	ABS SYSTEM
136	WORLD TRANSM-ECU POWER	156C	ABS SYSTEM
136V	WORLD TRANSM-12V BATTERY	156W	ABS SYSTEM
136W	WORLD TRANSM-12V BATTERY		

No.	SYSTEM	No.	SYSTEM	No.	SYSTEM	No.	SYSTEM
157	WORLD TRANSM-SPEEDOMETER SIGNAL	292	FAN CLUTCH RADIATOR SPD 2				
157	ABS SYSTEM	417	DDEC III-LIMIT SPEED GOVERNOR				
157A	ABS SYSTEM	419	DDEC III-CHECK ENGINE LIGHT				
157B	ABS SYSTEM	439	DDEC III-12V IGNITION				
157C	ABS Syst.-CANCEL SEC. BRK	440	DDEC III-12V IGNITION				
158	WORLD TRANSM-DIMMER	505	DDEC III-TACHOMETER DRIVE				
160	WORLD TRANSM-SER. INTERFACE (-)	505	DDEC III-TACHOMETER DRIVE				
161	WORLD TRANSM-SIGNAL GRD	509	DDEC III-STOP ENGINE LIGHT				
161	UNLOAD TAG SYSTEM	510	DDEC III-FAST IDLE SIGNAL				
161B	WORLD TRANSM-SIGNAL GRD	524	DDEC III-ENGINE BRAKE DISABLE				
162	WORLD TRANSM-PRESS. SW C3	525	DDEC III-FAST IDLE SIGNAL				
163	WORLD TRANSM-RETARDER ENABLE	528	DDEC III-STOP ENG. OVERRIDE				
164	WORLD TRANSM-RET. ACTUATOR SIGN	531	DDEC III-CRUISE CLUTCH CUT OUT				
165	WORLD TRANSM-OIL LEVEL SIGNAL	541	DDEC III-CRUISE SET SW				
168	WORLD TRANSM-SER. INTERFACE (+)	543	DDEC III-CRUISE STOP SW CUT OUT				
170C	LUGGAGE DOOR LOCK	544	DDEC III-CRUISE ON/OFF SW				
170D	LUGGAGE DOOR LOCK	545	DDEC III-CRUISE RESUME SW				
170E	LUGGAGE DOOR LOCK	555	DDEC III-CRUISE ANABLE LIGHT				
170F	LUGGAGE DOOR LOCK	556	DDEC III-VEHICLE SPEED (+)				
170G	LUGGAGE DOOR LOCK	557	DDEC III-VEHICLE SPEED (-)				
170H	LUGGAGE DOOR LOCK	565	DDEC III-ENGINE BRAKE ACTIVE				
170J	LUGGAGE DOOR LOCK	583	DDEC III-ENGINE BRAKE 4 CYL.				
170L	LUGGAGE DOOR LOCK	750	PRODRIVER-ILLUMINATION LTS				
170M	LUGGAGE DOOR LOCK	900	DDEC III-DATA LINK (+)				
170N	LUGGAGE DOOR LOCK	901	DDEC III-DATA LINK (-)				
170P	LUGGAGE DOOR LOCK	908	DDEC III-HYDRAULIC TRANSM. MODULATOR				
170R	LUGGAGE DOOR LOCK	916	DDEC III-SENSOR SUPPLY (5VDC)				
170S	LUGGAGE DOOR LOCK	952	DDEC III-SENSOR RETURN				
170V	LUGGAGE DOOR LOCK	953	DDEC III-BATTERY GRD				
170W	LUGGAGE DOOR LOCK	953C	DDEC III-BATTERY GRD				
170X	LUGGAGE DOOR LOCK	979	DDEC III-ENGINE BRAKE 2 CYL.				
170Y	LUGGAGE DOOR LOCK	A	LEVEL-LOW SYSTEM				
170Z	LUGGAGE DOOR LOCK	A	A/C & HEAT SYSTEM-HI PRES.				
182	PYROMETER	A1	A/C & HEAT SYSTEM-LD PRES.				
182A	PYROMETER	A2	INTERIOR LTS-DRIVER'S LTS				
185	UNLOAD TAG SYSTEM	B	LEVEL-LOW SYSTEM				
185A	UNLOAD TAG SYSTEM	B00	RR JCT BOX CPT BATT GRD				
186	UNLOAD TAG SYSTEM	B000	RR JCT BOX CPT BATT GRD				
186A	UNLOAD TAG SYSTEM	C	LEVEL-LOW SYSTEM				
187	UNLOAD TAG SYSTEM	J4	A/C & HEAT SYSTEM-DRIVER'S HTR				
187C	UNLOAD TAG SYSTEM	D3	A/C & HEAT SYSTEM-DRIVER'S HTR				
188	UNLOAD TAG SYSTEM	R1	A/C & HEAT SYSTEM-DRIVER'S HTR				
188A	UNLOAD TAG SYSTEM	R6	A/C & HEAT SYSTEM-DRIVER'S HTR				
188B	UNLOAD TAG SYSTEM	SH1	SHIELD WIRE GRD				
201	WORLD TRANSM-SPARE	SH2	SHIELD WIRE GRD				
202	WORLD TRANSM-SPARE	SH3	SHIELD WIRE GRD				
203	WORLD TRANSM-SPARE	V5	A/C & HEAT SYSTEM-DRIVER'S HTR				
204	WORLD TRANSM-SPARE	V7	A/C & HEAT SYSTEM-DRIVER'S HTR				
205	WORLD TRANSM-SPARE						
206	WORLD TRANSM-SPARE						
214	WORLD TRANSM-BACK UP SIGNAL						
214A	WORLD TRANSM-BACK UP SIGNAL						
231	WORLD TRANSM-NEUTRAL SIGNAL GRD						
240	DDEC III-ECM 12V FEEDING						
241	DDEC III-ECM 12V FEEDING						
251	PRODRIVER-12V HOT WIRE						
260	WINDOW AJAR						
290	FAN CLUTCH RADIATOR						
291	FAN CLUTCH RADIATOR SPD 1						

CIRCUIT BREAKER CODE (CB)

Page F : 1

NO.	PAGE	AMPERE	#PREVDST	LOCATION	FUNCTION
CB1	1	200A	560838	ENGINE CPT	A/C FULL AIR
CB2	1	30A	870630	ENGINE CPT	12V HOT WIRE RR JCT BOX
CB3	1	70A	561767	ENGINE CPT	12V FEED RR JCT BOX
CB4	1	90A	560298	ENGINE CPT	12V FEED FR JCT BOX
CB5	1	30A	870630	ENGINE CPT	24V HOT WIRE RR JCT BOX
CB6	1	90A	560298	ENGINE CPT	24V FEED RR JCT BOX
CB7	1	90A	560298	ENGINE CPT	24V FEED FR JCT BOX
CB8	13	120A	562397	A/C JCT BOX	CONDENSER FAN MOTOR
CB9	13	105A	560465	A/C JCT BOX	EVAPORATOR FAN MOTOR
CB10	2	8A	561791	FR JCT BOX	MASTER SWITCH
CB16	2	8A	561791	RR JCT BOX	ENGINE-RR CTR & START SW
CB18	2	8A	561791	RR JCT BOX	ENGINE-FR CTR SW
CB19	3	15A	561793	RR JCT BOX	DDEC III E.C.M. POWER
CB20	3	15A	561793	RR JCT BOX	DDEC III E.C.M. POWER
CB21	3	6A	561790	RR JCT BOX	DDEC III 12V IGNITION
CB26	8	10A	561792	FR JCT BOX	BACK-UP LTS
CB27	5	8A	561791	FR JCT BOX	24V IGN DASH ACCESSORIES
CB29	5	20A	561794	FR JCT BOX	ELECTRICAL HORNS
CB30	5	15A	561793	FR JCT BOX	FIRE ALARM & WATER HTR TIMER
CB31	5	8A	561791	FR JCT BOX	AIR DRYER
CB35	6	6A	561790	FR JCT BOX	FOG & HAZARD SW
CB36	6	15A	561793	FR JCT BOX	FOG LTS
CB37	6	8A	561791	FR JCT BOX	HEAD & MULTI-FUNC. SW
CB38	6	10A	561792	FR JCT BOX	MARKER LTS
CB39	6	6A	561790	FR JCT BOX	TACHO & SPEEDO
CB40	6	8A	561791	FR JCT BOX	FR & RR CLEARANCE & ID. LTS
CB42	6	10A	561792	FR JCT BOX	RR MARKER.TAIL.LICENCE LTS
CB43	6	20A	561794	FR JCT BOX	HEADLAMP (HI)
CB44	6	15A	561793	FR JCT BOX	HEADLAMP (LO)
CB45	7	10A	561792	FR JCT BOX	MULTI-FUNC. SW (WIPER CTR)
CB47	7	15A	561793	FR JCT BOX	CORNERING LTS
CB48	8	6A	561790	FR JCT BOX	STOP SW
CB49	8	15A	561793	RR JCT BOX	LH STOP LTS
CB51	8	20A	561794	RR JCT BOX	RH STOP & CYCLOP LTS
CB52	9	15A	561793	FR JCT BOX	LUGGAGE LTS
CB55	10	8A	561791	FR JCT BOX	DASH LTS RHEOSTAT
CB59	10	8A	561791	FR JCT BOX	DRIVER'S LTS SW.
CB70	12-13	8A	561791	FR JCT BOX	BLOWER CUT-IN RELAY
CB72	12	10A	561792	RR JCT BOX	A/C COMPRESSOR CLUTCH
CB73	12	15A	561793	FR JCT BOX	WATER PUMP (A/C STANDARD)
CB73	13	15A	561793	FR JCT BOX	WATER PUMP (A/C FULL AIR)
CB79	12-13	10A	561792	FR JCT BOX	DRIVER'S HTR FAN
CB83	4	20A	561794	RR JCT BOX	WORLD TRANSMISSION VIM POWER
CB91	15	8A	561791	FR JCT BOX	DRIVER'S SEAT HEATER
CB92	16	6A	561790	FR JCT BOX	SPEED SW & LEVEL-LOW
CB104	17	6A	561790	FR JCT BOX	ABS E.C.U.
CB105	17	20A	561794	FR JCT BOX	ABS E.C.U.
CB106	17	10A	561792	FR SERV JCT BOX	ABS E.C.U.
CB107	17	10A	561792	FR SERV JCT BOX	ABS E.C.U.
CB117	14	8A	561791	FR JCT BOX	RR VIEW MIRROR
CB118	16	20A	561794	FR JCT BOX	LUGGAGE DOOR LOCK MOTOR
CB119	16	3A	561797	FR JCT BOX	LUGGAGE UNLOCK TT LT & SW
CB120	16	20A	561794	FR JCT BOX	LUGGAGE DOOR LOCK MOTOR
CB121	14	10A	561792	FR JCT BOX	CIGAR LIGHTER
CB122	11	6A	561790	FR JCT BOX	ENTRANCE DOOR AIR LOCK
CB125	7	20A	561794	FR JCT BOX	DIRECTIONAL LTS LH
CB126	7	20A	561794	FR JCT BOX	DIRECTIONAL LTS RH

CIRCUIT BREAKER CODE (CB)

Page F : 1

NO.	PAGE	AMPERE	#PREVDST	LOCATION	FUNCTION
CB127	15	25A	561795	FR JCT BOX	ELECTRIC DRIVER'S SEAT
CB128	19	6A	561790	RR JCT BOX	UNLOAD TAG SYSTEM
CB129	18	15A	561793	RR JCT BOX	WATER HEATER
CB130	5	6A	561790	RR JCT BOX	FAN CLUTCH RADIATOR
CB132	18	15A	561793	RR JCT BOX	WATER HEATER WEBASTO
CB138	21	3A	561797	FR JCT BOX	SUN VISOR

No.	LOCATION	TYPE	(NB) CAVITY	#PIN HOUSING	#SOCKET HOUSING
C3	UNDER DASH-LH	AMP CPC	37	561645	561646
C7	FR SERVICE COMPT.-CLUTCH SW	ITT SS	3	561111	561080
C11	LH CONSOLE SW-MIRROR	AMP MNL	3	561667	561550
C12	LH CONSOLE SW-MIRROR HTR	AMP MNL	2	561248	561247
C13	LH CONSOLE SW-MIRROR	AMP MNL	6	561552	561515
C14	UNDER DASH LH-MIRROR	AMP MNL	9	561670	561669
C15	UNDER DASH RH-MIRROR	AMP MNL	9	561670	561669
C18	UNDER DASH-FIRE ALARM	TC	2	561030	560997
C18	UNDER DASH-FIRE ALARM	AMP MNL	2	560900	560898
C19	UNDER DASH-A/C & HEAT SYST.	TC	10	561072	561110
C21	LUGGAGE COMPT.-LOCK DOOR MOT.	PED	2	-----	562076
C22	ENGINE COMPT.-CYCLOP LT	PED WP	2	561566	561690
C23	FR SERVICE COMPT.-WTR PUMP	PED WP	2	561566	561690
C26	UNDER INSTRUMENT.-PANEL RHEU.	TC	2	561030	560997
C28	FR SERVICE COMPT.-SEAT HTR	AMP MNL	2	560900	560898
C29	FR SERVICE COMPT.-VIM FEED	PED WP	3	561781	561782
C30	FR SERVICE COMPT.-SEAT ELECT.	PED WP	2	562237	-----
C32	RH CONSOLE-DRV TEMP SENSOR	BURNDY	3	-----	561104
C33	ENGINE DDEC II-SPARE GOV.	PED WP	2	561566	561690
C34	RH CONSOLE-DRV TEMP CTRL	BURNDY	6	-----	561103
C35	RECIRCULATED AIR GRIL.-SENSOR	BURNDY	3	-----	561104
C36	LH CONSOLE SW-CRUISE ON/OFF	SWF	8	-----	561107
C37	LH CONSOLE SW-CRUISE SET	SWF	8	-----	561107
C38	LH CONSOLE SW-CRUISE RESUME	SWF	8	-----	561107
C41	UNDER DASH-FLASHER UNIT	TC	2	-----	561940
C49	FR JCT PANEL-PARK BRK ALARM	AMP MNL	2	560900	560898
C50	RH CONSOLE-PAS. TEMP CTRL	BURNDY	6	-----	561103
C51	RH CONSOLE SW-A/C & HEAT	SWF	8	-----	561107
C52	ENGINE COMPT.-COMPRESSOR 05G	PED WP	2	561566	561690
C53	ENGINE COMPT.-COMPRESSOR 05G	PED WP	2	561566	561690
C54	ENGINE COMPT.-COMPRESSOR 05G	TC	1	560098	560697
C55	CENTRAL DOOR	PED WP	2	561566	561690
C61	ENGINE COMPT.-FUEL FILTER	PED WP	2	561566	561690
C62	ENGINE COMPT.-COMPRESSOR STD	PED WP	2	561566	561690
C63	ENGINE COMPT.-COMPRESSOR STD	PED WP	2	561566	561690
C64	ENGINE COMPT.-COMPRESSOR STD	TC	1	560098	560697
C70	FR JCT PANEL-DOCKING LTS	TC	1	560098	560697
C73	LH SW PANEL-MULTI FUNC. LEV.	AMP FF	8	561188	-----
C74	LH SW PANEL-MULTI FUNC. LEV.	AMP FF	6	-----	561108
C77	UNDER DASH-3 WAY SW	TC	2	561030	560997
C78	LUGGAGE COMPT.-DOOR LOCK 4 LH	AMP MNL	4	560851	560852
C79	LUGGAGE COMPT.-DOOR LOCK 4 RH	AMP MNL	4	560851	560852
C80	FR JCT PANEL-LUG. DOOR LOCK	AMP MNL	6	561552	561515
C81	LUGGAGE COMPT.-DOOR LOCK 1 LH	AMP MNL	4	560851	560852
C82	LUGGAGE COMPT.-DOOR LOCK 1 RH	AMP MNL	4	560851	560852
C83	UNDER DASH-FLASHER MODULE	TC	10	561072	561110
C84	UNDER DASH-A/C SYSTEM	TC	3	561091	561071
C85	LUGGAGE COMPT.-DOOR LOCK 3 RH	AMP MNL	4	560851	560852
C86	LUGGAGE COMPT.-DOOR LOCK 3 LH	AMP MNL	4	560851	560852
C88	RR END ROOF-CLEARANCE LTS	AMP MNL	2	560900	560898
C98	A/C JCT BOX	ITT SS	4	561998	561999
C99	A/C JCT BOX	ITT SS	3	561111	561080
C100	A/C JCT BOX	ITT SS	2	561813	561812
C101	CONDENSER COMPT.-A/C PRES. SW	PED WP	2	561566	561690
C105	UNDER DASH RH-DRV LIO SOL VL	TC	2	561030	560997
C106	UNDER DASH RH-DRV WTR VALVE	TC	2	561030	560997
C107	UNDER DASH RH-DRV HTR RH FAN	TC	2	561030	560997
C108	UNDER DASH RH-DRV HTR LH FAN	TC	2	561030	560997

PRIOR 5573
EFF.5573

No.	LOCATION	TYPE	(NB) CAVITY	#PIN HOUSING	#SOCKET HOUSING
C109	RH CONSOLE SW-A/C CLUTCH SW	SWF	8	-----	561107
C114	ENGINE DDEC II-SPEED SIGNAL	PED WP	2	561566	561590
C115	RR JCT BOX	DEUTSCH	40	562281	562284
C116	DRIVE AXLE COMPT.-AIR DRYER	PED MP	2	-----	562251
C119	ENGINE COMPT.-LH LOWER LAMP	PED WP	6	561606	561607
C120	ENGINE COMPT.-LH LOWER LAMP	PED WP	6	561606	561607
C127	FR SERVICE COMPT.-JACOB	PED WP	4	561610	561783
C131	LH CONSOLE SW-LUG.DOOR LOCK	SWF	8	-----	561107
C132	LH CONSOLE SW-DRIVER'S LTS	SWF	8	-----	561107
C133	LH CONS.SW-JACOB OR RETARDER	SWF	8	-----	561107
C135	LH SW PANEL-ETHER	SWF	8	-----	561107
C136	LH CONSOLE SW-MIRROR HTR	SWF	8	-----	561107
C137	RH SW PANEL-HEAD LAMP	SWF	8	-----	561107
C138	RH SW PANEL-SPARE	SWF	8	-----	561107
C139	RH SW PANEL-FOG LAMP	SWF	8	-----	561107
C140	FR JCT PANEL-BAT. HI/LO	AMP MNL	2	560900	560898
C141	ENGINE COMPT.-B/UP ALARM	PED WP	2	561566	561590
C142	FR SERVICE CPT-LH MARKER LTS	ITT SS	3	561111	561080
C146	FR SERVICE CPT-RH MARKER LTS	ITT SS	3	561111	561080
C154	RH SW PANEL-HAZARD	SWF	8	-----	561107
C155	LH SW PANEL-FAST IDLE	SWF	8	-----	561107
C156	LH SW PANEL-STP ENG. OVER.	SWF	8	-----	561107
C157	RH SW PANEL-ENTRANCE DOOR LCK	SWF	8	-----	561107
C160	FR SERVICE CPT-INTERFACE	AMP CPC	37	561644	561646
C161	ENGINE DDEC III-ECM	PED	30	-----	561600
C162	ENGINE DDEC III-ACCESSORIES	PED WP	4	561610	561611
C163	ENGINE CPT-COOLANT PROBE	PED MP	2	-----	562350
C164	FR SERVICE JCT BOX	AMP CPC	22	561709	561710
C165	FR SERVICE JCT BOX	AMP CPC	16	561693	561695
C166	UNDER INSTRUMENT PANEL	AMP CPC	16	561639	561640
C167	FR SERVICE CPT-EL. FOOT PEDAL	PED WP	3	561781	561782
C168	FR SERVICE CPT-ODR	DEUTSCH	6	562360	-----
C169	FR SERVICE CPT-WORLD TR. VIM	AMP CPC	16	561638	561640
C175	FR SERVICE COMPT.-LEVEL LO	PED WP	3	561781	561782
C180	FR JCT PANEL-DIODES	MOLEX	10	-----	561251
C181	FR SERVICE CPT-LEVEL LOW	AMP MNL	6	561552	561515
C182	FR SERVICE CPT-SPEED SW	AMP HDP	15	-----	562012
C187	FR SERVICE JCT BOX-RESISTORS	AMP MNL	6	561552	561515
C190	FR SERVICE CPT.-WORLD TR VIM	PED WP	30	-----	561600
C199	FR SERV. JCT BOX-SERVICE BRK	AMP MNL	3	561667	561550
C201	UNDER INSTRUMENT PANEL	AMP MNL	2	560900	560898
C202	UNDER INSTRUMENT PANEL	AMP CPC	9	561636	561637
C206	RH CONSOLE-FR DEFROSTER	TC	2	561030	560997
C207	RH CONSOLE-DRV RHEOSTAT	AMP MNL	6	561552	561515
C208	UNDER DASH-DRV HTR MODULE	AMP MNL	9	561670	561669
C209	UNDER DASH-DRV HTR MODULE	AMP MNL	9	561670	561669
C213	FR ROOF-CLEARANCE LT	AMP MNL	2	560900	560898
C230	ENG.CPT. -FUEL PRIME PUMP SW.	PED WP	2	561566	561690
C231	ENG.CPT. -FUEL PRIME PUMP	PED WP	2	561566	561690
C234	UNDER INSTRUMENT PANEL-VDO	AMP MNL	4	560851	560852
C235	UNDER INSTRUMENT PANEL-VDO	AMP MNL	4	560851	560852
C236	FR SERVICE CPT CENTER-ABS	AMP CPC	14	561585	561583
C237	FR AXLE CPT-ABS RH SENSOR	WABCO	2	641132	-----
C238	FR AXLE CPT-ABS RH VALVE	WABCO	3	-----	641098
C239	FR AXLE CPT-ABS LH VALVE	WABCO	3	-----	641098
C240	FR AXLE CPT-ABS LH SENSOR	WABCO	2	641132	-----
C241	DRIVE AXLE CPT-ABS	PED WP	6	561606	561607

No.	LOCATION	TYPE	(NB) CAVITY	#PIN HOUSING	#SOCKET HOUSING	
C242	DRIVE AXLE CPT-ABS LH SENSOR	WABCO	2	641132	-----	PRIOR TO S573
C242	DRIVE AXLE CPT-ABS LH SENSOR	DEUTSCH	2	562486	562485	EFF. W/S573
C243	DRIVE AXLE CPT-ABS LH VALVE	WABCO	3	-----	641098	
C244	DRIVE AXLE CPT-ABS RH VALVE	WABCO	3	-----	641098	
C245	DRIVE AXLE CPT-ABS RH SENSOR	WABCO	2	641132	-----	PRIOR TO S573
C245	DRIVE AXLE CPT-ABS RH SENSOR	DEUTSCH	2	562486	562485	EFF. W/S573
C246	DRIVE AXLE CPT-ABS SPARE	PED WP	4	561610	561611	
C247	FR SERVICE CPT-ABS MODULE	WABCO	35	-----	561094	
C248	DRIVE AXLE CPT-ABS	PED WP	6	561606	561607	
C249	FR SERVICE CPT-ABS/DDEC	PED WP	2	561566	561690	
C250	RH SW PANEL-B/UP CANCEL	SWF	8	-----	561107	
C251	RH SW PANEL-SEAT HTR	SWF	8	-----	561107	
C252	LH SW PANEL-SWITCH LT	SWF	2	-----	561837	
C253	LUGGAGE COMPT.-WINDOW AJAR	MOLEX	4	561477	561476	
C254	FR SERVICE JCT BOX-ABS	AMP CPC	16	561693	561695	
C257	ENGINE COMPT-WATER HEATER	AMP FF	6	-----	561186	
C258	LH CONSOLE-WATER HTR TIMER	AMP FF	8	561188	562363	
C259	ENGINE COMPT-WATER HEATER	TC.	2	561597	-----	
C260	ENGINE COMPT-WATER HEATER	TC.	1	561073	-----	
C261	ENGINE COMPT-WATER HEATER	TC.	2	561597	-----	
C267	LUGGAGE COMPT. LTS - 1	AMP MNL	2	561248	561247	
C268	LUGGAGE COMPT. LTS - 2	AMP MNL	2	561248	561247	
C269	LUGGAGE COMPT. LTS - 3 RH	AMP MNL	2	561248	561247	
C270	LUGGAGE COMPT. LTS - 3 LH	AMP MNL	2	561248	561247	
C271	LUGGAGE COMPT. LTS - 4	AMP MNL	2	561248	561247	
C272	FR SERVICE CPT LTS	AMP MNL	2	561248	561247	
C273	LH CONSOLE SW-UNLOAD TAG	SWF	8	-----	561107	
C274	FR JCT PANEL-DIODES	AMP MNL	15	561987	561986	
C275	FR JCT PANEL-DIODES	AMP MNL	15	561987	561986	
C276	FR JCT PANEL-ALARM BUZZER	BOSCH	5	-----	561183	
C280	ENGINE COMPT-COMPRESSOR STD	PED WP	2	561566	561690	
C290	LUGGAGE CPT-DOOR LOCK	AMP MNL	4	560851	560852	
C291	LUGGAGE CPT-DOOR LOCK	AMP MNL	4	560851	560852	
C292	LUGGAGE CPT-DOOR LOCK	AMP MNL	4	560851	560852	
C293	WIPER MOTOR	AMP FF	6	-----	561186	
C294	UNDER DASH-WIPER SYST. FEED	AMP MNL	6	561552	561515	
C295	UNDER DASH-WIPER PULSE GEN.	AMP FF	6	-----	561186	
C296	FR SERVICE CPT-HEAD LTS	ITT SS	3	561111	561080	
C302	UNDER DASH-FLASHER MODULE	AMP MNL	2	560900	560898	
C303	RR JCT BOX-DIODES	AMP MNL	15	561987	561986	
C304	ENGINE COMPT-RETARDER VALVE	AMPHENOL	2	-----	560412	
C309	ENGINE DDEC III-ECM POWER	PED WP	5	-----	562345	
C312	ENGINE DDEC III-ACCESSORIES	PED WP	2	561566	561690	
C313	ENGINE DDEC III-INPUT	PED WP	3	562398	-----	
C314	FR.ROOF - RH SUN VISOR	AMP MNL	2	560900	560898	
C315	FR.ROOF - LH SUN VISOR	AMP MNL	2	560900	560898	
C316	FR JCT PANEL - SUN VISOR	AMP MNL	4	560851	560852	
C317	RH CONSOLE - LH SUN VISOR SW.	SWF	8	-----	561107	
C318	RH CONSOLE - RH SUN VISOR SW.	SWF	8	-----	561107	
C326	ENGINE DDEC III- HYDR. TR.	PED WP	4	561610	561611	
C359	ENGINE COMPT-UNLOAD TAG VALVE	PED WP	2	561566	561690	
C360	ENGINE COMPT-UNLOAD TAG VALVE	PED WP	2	561566	561690	
C361	ENGINE COMPT-UNLOAD TAG VALVE	PED WP	2	561566	561690	
C381	ENGINE S60 AIR TEMP SW	PED WP	2	561566	561690	
C382	ENGINE GENERATOR 12 VAC RLY	PED WP	1	561605	561577	
C426	ENGINE S60 RAD. FAN CLUTCH	PED WP	3	561781	561782	
C427	ENGINE S60 TEMP SENSOR	BEHR	3	-----	562310	
C428	RH CONSOLE-RHEOSTAT A/C (F A)	AMP MNL	3	561667	561550	

No.	LOCATION	TYPE	(NB) CAVITY	#PIN HOUSING	#SOCKET HOUSING
C500	FR.JCT PANEL-PRODRIVER	MOLEX	6	562070	562069
C501	RH CONSOLE-PRODRIVER	PED MP	7	562433	-----

NO.	PAGE	AMP	#PREVOST	LOCATION	FUNCTION
D1	5	3A	561740	FR JCT BOX	PRIMARY LO-AIR SONALERT
D2	5	3A	561740	FR JCT BOX	SECONDARY LO-AIR SONALERT
D3	12-13	3A	063849	FR JCT BOX	A/C (FULL AIR) - CONTROL SW.
D4	12-13	3A	063849	FR JCT BOX	WATER HEATER ON SIGNAL
D17	7	3A	561740	FR JCT BOX	HAZARD LH
D18	7	3A	561740	FR JCT BOX	HAZARD RH
D19	6	3A	561740	FR JCT BOX	DAYTIME RUNNING LTS
D20	6	3A	561740	FR JCT BOX	DAYTIME RUNNING LTS
D21	7	3A	561740	UNDER DASH	AUDIBLE FLASHER RLY LH
D22	7	3A	561740	UNDER DASH	AUDIBLE FLASHER RLY RH
D23	18	3A	063763	RR JCT BOX	PRE WATER HEATER (ESPAR PRIOR)
D24	5	3A	561740	FR JCT BOX	UNLOAD TAG SYSTEM
D25	19	3A	561740	FR JCT BOX	UNLOAD TAG SYSTEM
D60	12	3A	561740	RR JCT BOX	A/C STD - COMPR. CLUTCH
D61	13	3A	561740	RR JCT BOX	A/C FULL AIR - COMPR. CLUTCH

NO.	PAGE	COIL V	#PREVOST	LOCATION	FUNCTION	NO.	PAGE	COIL V	#PREVOST	LOCATION	FUNCTION
R1	2	24V	561991	FR JCT BOX	ENGINE RUN (24) FR	R83	18	24V	561707	RR JCT BOX	WATER HEATER-WEBASTO
R2	2	24V	561991	FR JCT BOX	ENGINE RUN (12) FR	R84	12	24V	561707	RR JCT BOX	DDEC3 A/C STD FAN CONTROL
R3	1	24V	561707	RR JCT BOX	FIELD RELAY						
R4	1	24V	561005	RR JCT BOX	STARTING MOTOR						
R9	8	24V	561707	RR JCT BOX	BACK-UP LTS						
R12	5	12V	562092	FR JCT BOX	ELECTRICAL HORNS						
R13	6	24V	561707	FR JCT BOX	FOG LTS - 12V						
R14	6	24V	561707	FR JCT BOX	NIGHT'S BLINKER						
R15	6	24V	561707	FR JCT BOX	FR MARKER LTS						
R16	6	24V	561707	FR JCT BOX	IDENT. & CLEARANCE LTS						
R17	6	24V	561707	RR JCT BOX	TAIL.LICENCE.MARKER-RR LTS						
R18	6	24V	561707	FR JCT BOX	DAYTIME RUN LTS-CANCEL						
R19	6	24V	561707	FR JCT BOX	HI-BEAM						
R20	6	24V	561707	FR JCT BOX	LO-BEAM						
R22	3	24V	561707	FR SERV JCT BOX	DDEC III FAST IDLE SIGNAL						
R23	3	24V	561707	RR JCT BOX	DDEC III 12V IGNITION						
R24	4	24V	561707	RR JCT BOX	WORLD TRANSMISSION 12V IGN.						
R25	3	24V	561707	FR SERV JCT BOX	BRAKE SW-DDEC CRUISE CTR						
R26	8	24V	561707	RR JCT BOX	STOP LTS						
R31	13	24V	561707	FR JCT BOX	A/C FULL AIR WATER HTR - WATER VALVE						
R32	12	24V	560772	RR JCT BOX	COMPR. CLUTCH TIME DELAY ON						
R33	12-13	12V	561538	FR JCT BOX	BLOWER CUT-IN						
R34	13	24V	561707	RR JCT BOX	A/C WARNING LT						
R35	12	24V	561707	FR JCT BOX	WATER PUMP A/C STD						
R36	12	24V	561707	RR JCT BOX	A/C STD-COMPR. CLUTCH						
R37	1	24V	561707	RR JCT BOX	GENERATOR-12VAC RLY SIGN						
R38	13	24V	561005	A/C JCT BOX	EVAP. FAN MOTOR (FULL AIR)						
R39	13	24V	561005	A/C JCT BOX	COND. FAN MOTOR (FULL AIR)						
R40	13	24V	561707	A/C JCT BOX	WATER PUMP (FULL AIR)						
R43	1	12V	560271	ENGINE COMPT	12V HOUSE						
R46	7	24V	561707	UNDER INST PANEL	LH DIRECTIONNAL LTS						
R47	7	24V	561707	UNDER INST PANEL	RH DIRECTIONNAL LTS						
R49	17	24V	561707	FR SERV JCT BOX	ABS - SERVICE BRAKE RLY						
R50	17	24V	561707	FR SERV JCT BOX	ABS - VR2 RLY						
R51	17	24V	561707	FR SERV JCT BOX	ABS - WARNING RLY						
R52	17	24V	561707	FR SERV JCT BOX	ABS - VR1 RLY						
R53	2	24V	561991	RR JCT BOX	ENGINE RUN 24V RR						
R54	2	24V	561991	RR JCT BOX	ENGINE RUN 12V RR						
R56	15	24V	561707	FR SERV JCT BOX	ENGINE BRAKE SYSTEM						
R57	6	24V	561707	FR JCT BOX	DAY'S BLINKER						
R60	6	12V	561538	FR JCT BOX	DAYTIME RUN LTS						
R62	7	24V	561707	BEHIND RH CONS	RH CORNERING						
R63	7	24V	561707	BEHIND RH CONS	LH CORNERING						
R66	19	24V	562341	RR JCT BOX	UNLOAD TAG-TIME DELAY OFF						
R67	19	24V	561707	RR JCT BOX	UNLOAD TAG SYSTEM						
R68	11	24V	561707	FR JCT BOX	PARK BRAKE ALARM						
R69	16	12V	562092	FR JCT BOX	LUGG DOOR LOCK						
R70	16	12V	562092	FR JCT BOX	LUGG DOOR UNLOCK						
R71	16	12V	562092	FR JCT BOX	LUGG DOOR LOCK TT LT						
R72	10	24V	561707	FR JCT BOX	DASH LTS RHEOSTAT						
R74	16	12V	562092	RR JCT BOX	LUGG DOOR LOCK						
R75	16	12V	562092	RR JCT BOX	LUGG DOOR UNLOCK						
R76	8	24V	561707	RR JCT BOX	STOP LTS-ENGINE BRK & RETARDER SYST.						
R77	7	12V	562092	UNDER DASH	AUDIBLE FLASHER RLY						
R78	5	24V	561707	RR JCT BOX	DDEC3 FAN CONTROL SPEED# 1						
R79	5	24V	561707	RR JCT BOX	DDEC3 FAN CONTROL SPEED# 2						
R80	15	24V	561707	FR SERV JCT BOX	ENGINE BRAKE SYS.-W/T CTR						
R81	15	24V	561707	FR SERV JCT BOX	ENGINE BRAKE SYS.-W/T CTR						
R82	15	24V	561707	FR SERV JCT BOX	RETARDER SYSTEM						

RESISTOR CODE (RS)

Page J : 1

NO.	PAGE	OHM(S)	#PREVOST	LOCATION	FUNCTION
RS1	3	11 K	562307	FR SERV JCT BOX	DDEC III-FAST IDLE
RS2	3	3.6 K	562306	FR SERV JCT BOX	DDEC III-FAST IDLE
RS3	6	1 (2)	561537	FR SERV. COMPT.	FOG LT - RH
RS4	6	1 (2)	561537	FR SERV. COMPT.	FOG LT - LH
RS5	7	1 (2)	561537	LAMP ASM	CORNERING LT - LH
RS8	7	1 (2)	561537	LAMP ASM	CORNERING LT - RH
RS9	7	1 (2)	561537	LAMP ASM	DOCKING LT - RH
RS10	7	1 (2)	561537	LAMP ASM	DOCKING LT - LH
RS14	6	.82 (2)	560822	FR SERV. COMPT.	DAYTIME RUN LTS
RS15	12	470 K	560805	RR JCT BOX	COMPR CLUTCH TIME DELAY ON
RS16	19	75 K	562342	RR JCT BOX	UNLOAD TAG TIME DELAY OFF
RS17	5	220	562498	UNDER DASH	FIRE ALARM

RESISTOR CODE (RS)

Page J : 1

NO.	PAGE	OHM(S)	#PREVOST	LOCATION	FUNCTION
-----	------	--------	----------	----------	----------

WIRING DIAGRAM KEYS

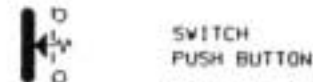
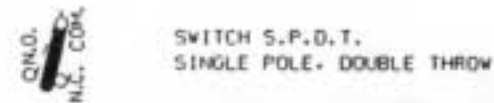
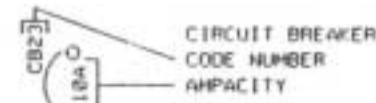
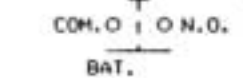
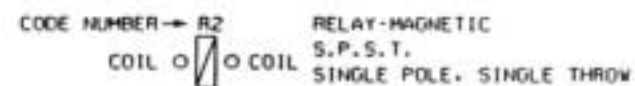
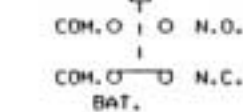
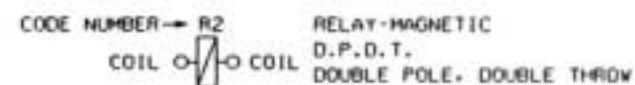
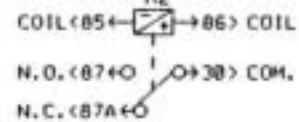
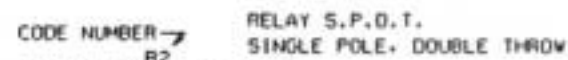
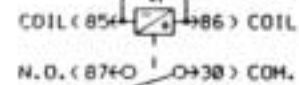
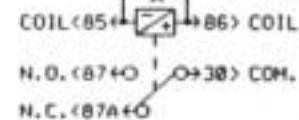
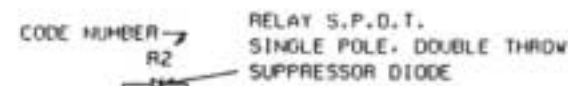
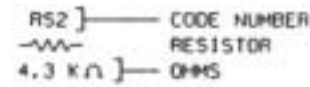
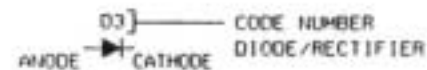
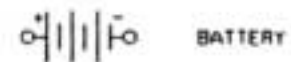
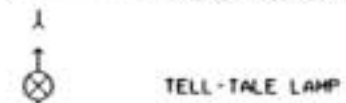
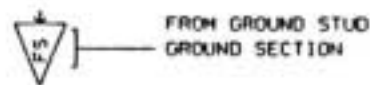
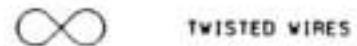
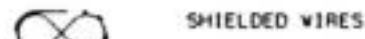
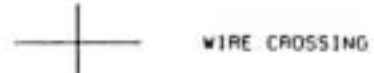
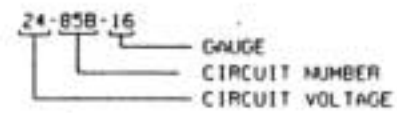

BLK BLACK
YEL YELLOW
RED RED
WH WHITE
GRY GREY
ORA ORANGE
BLU BLUE
GRN GREEN
BRN BROWN
PUR PURPLE
PK PINK



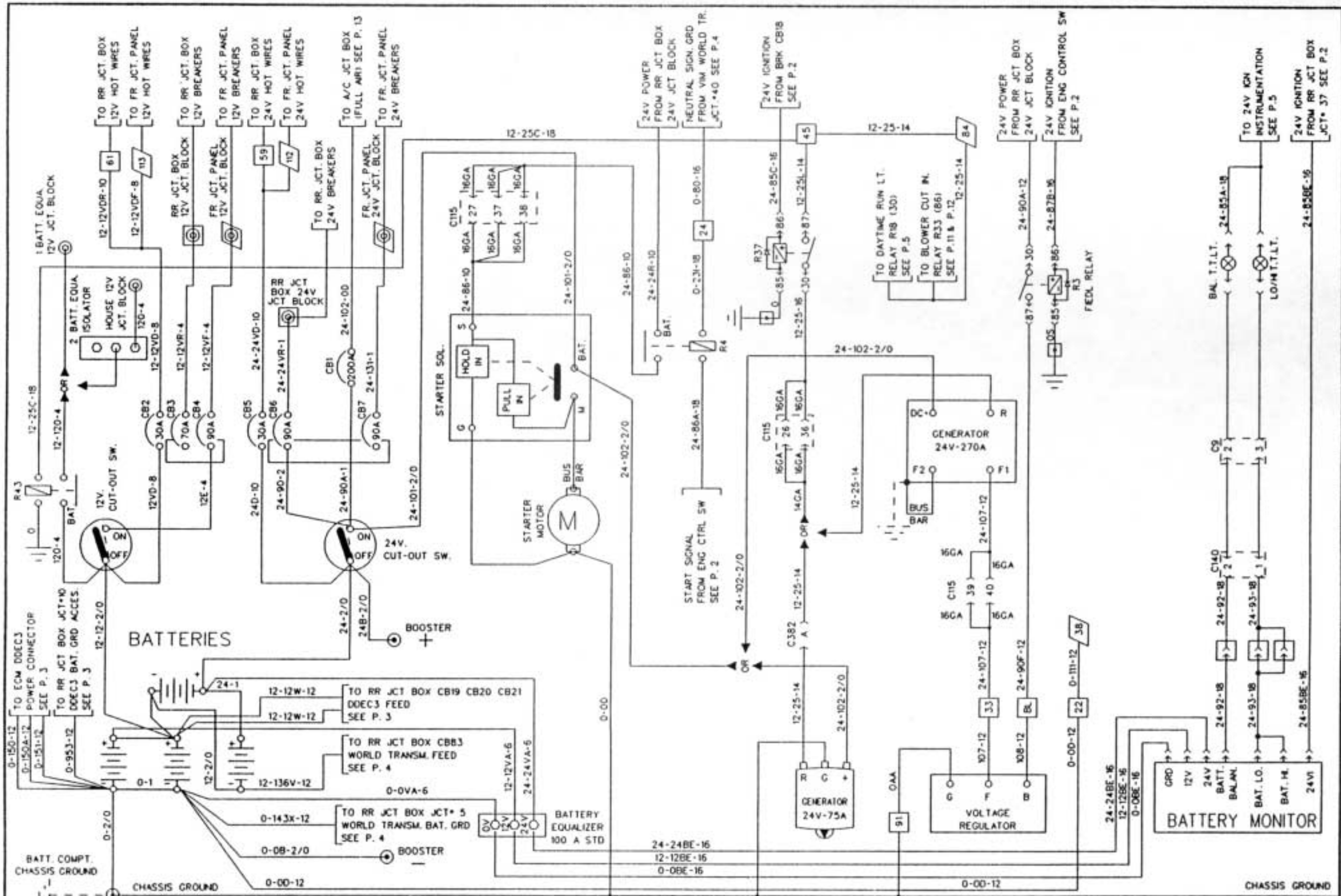

CHARGING SYSTEM

| W/24V 75A | W/24V 270A |

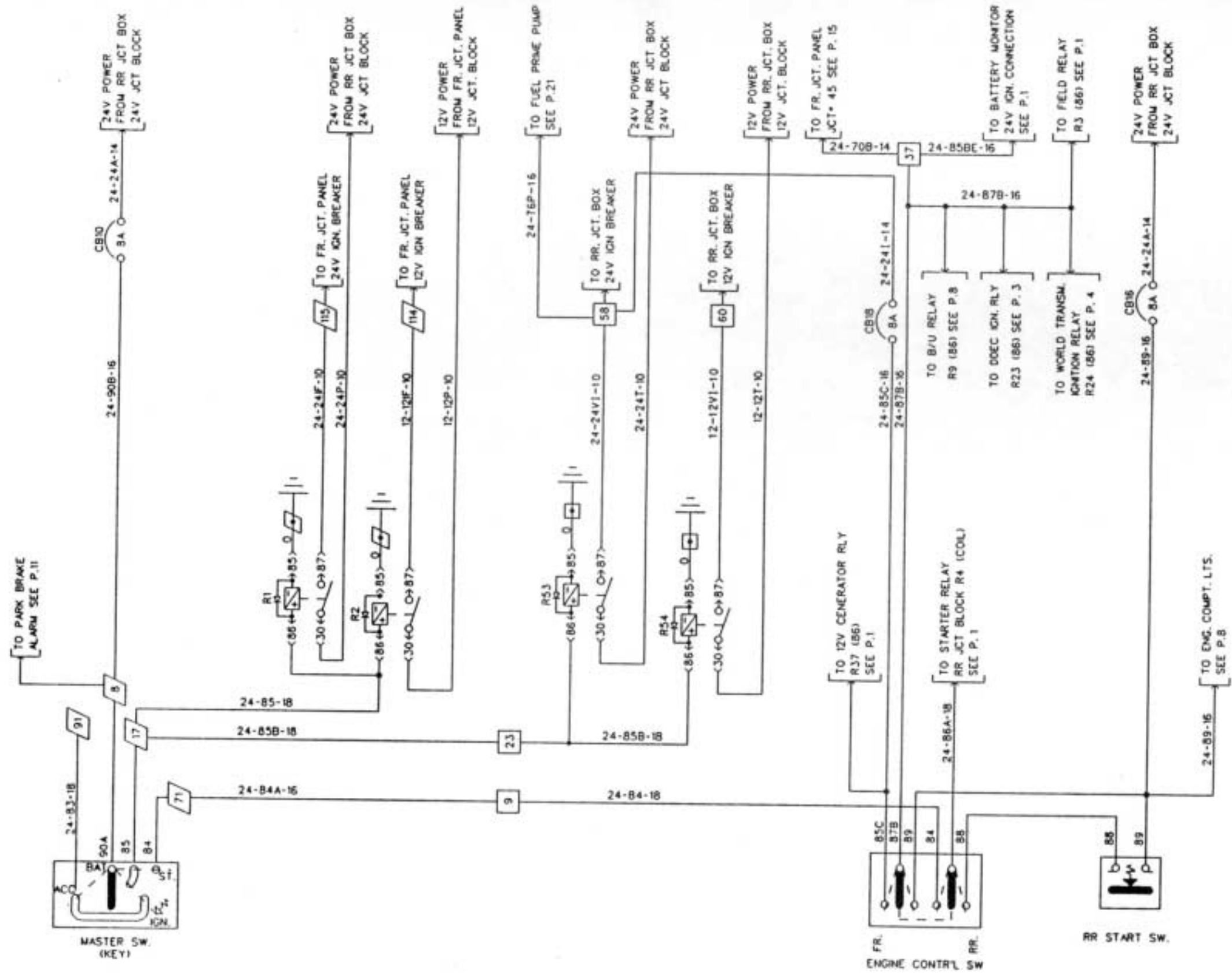

CHASSIS GROUND

CHASSIS GROUND

ENGINE CONTROL

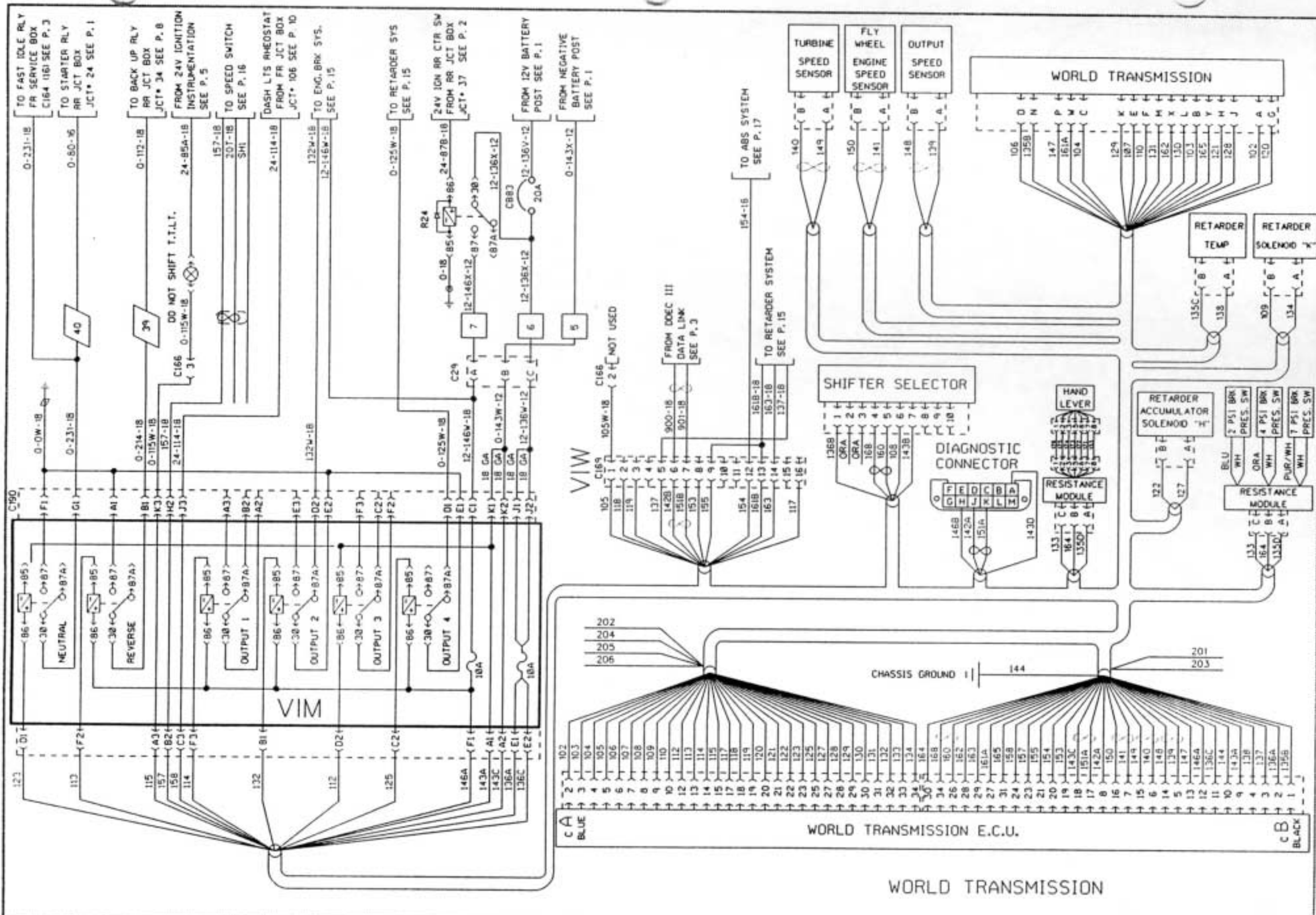

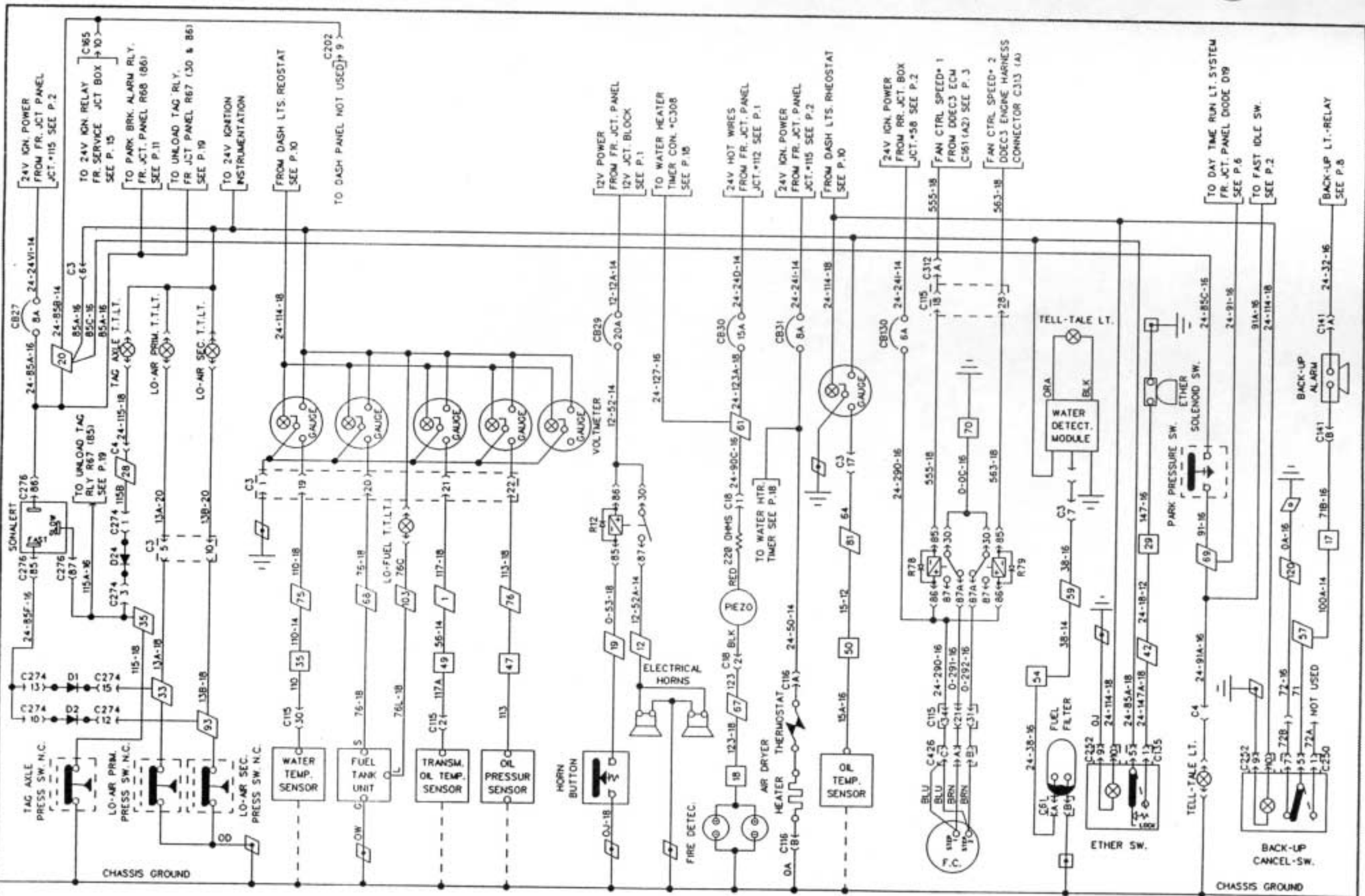

ALARM AND SIGNAL

- AIR DRYER
- DIFFERENTIAL OIL TEMP.
- RADIATOR FAN CLUTCH
- FUEL WATER FILTER
- ETHER COLD START
- PARKING BRAKE SW.
- BACK-UP ALARM

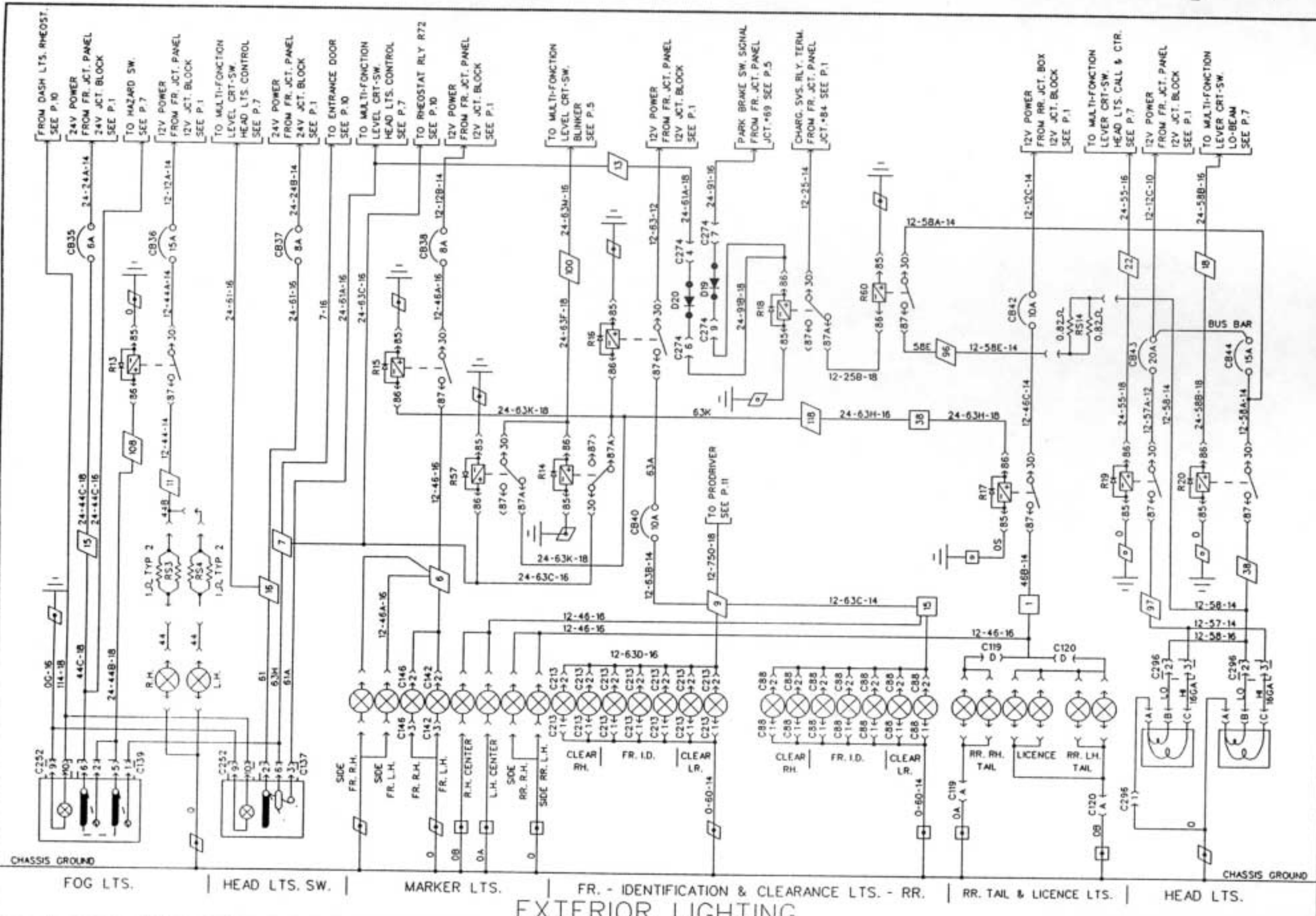

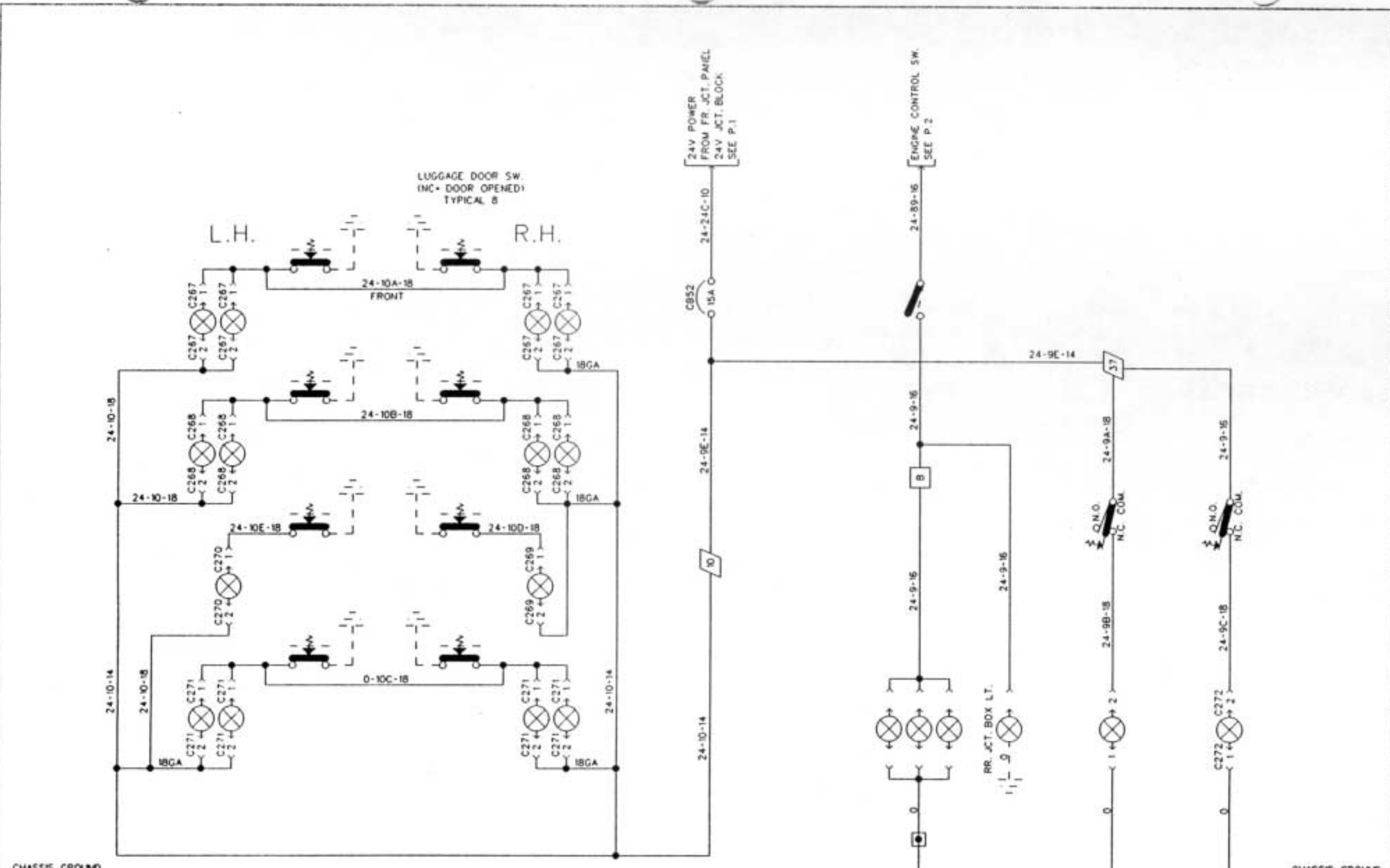

LUGGAGE COMPARTMENT LTS.

ENGINE COMPT. LTS.

FR. JCT. CPT

FR. SERVICE COMPT.

INTERIOR LIGHTING

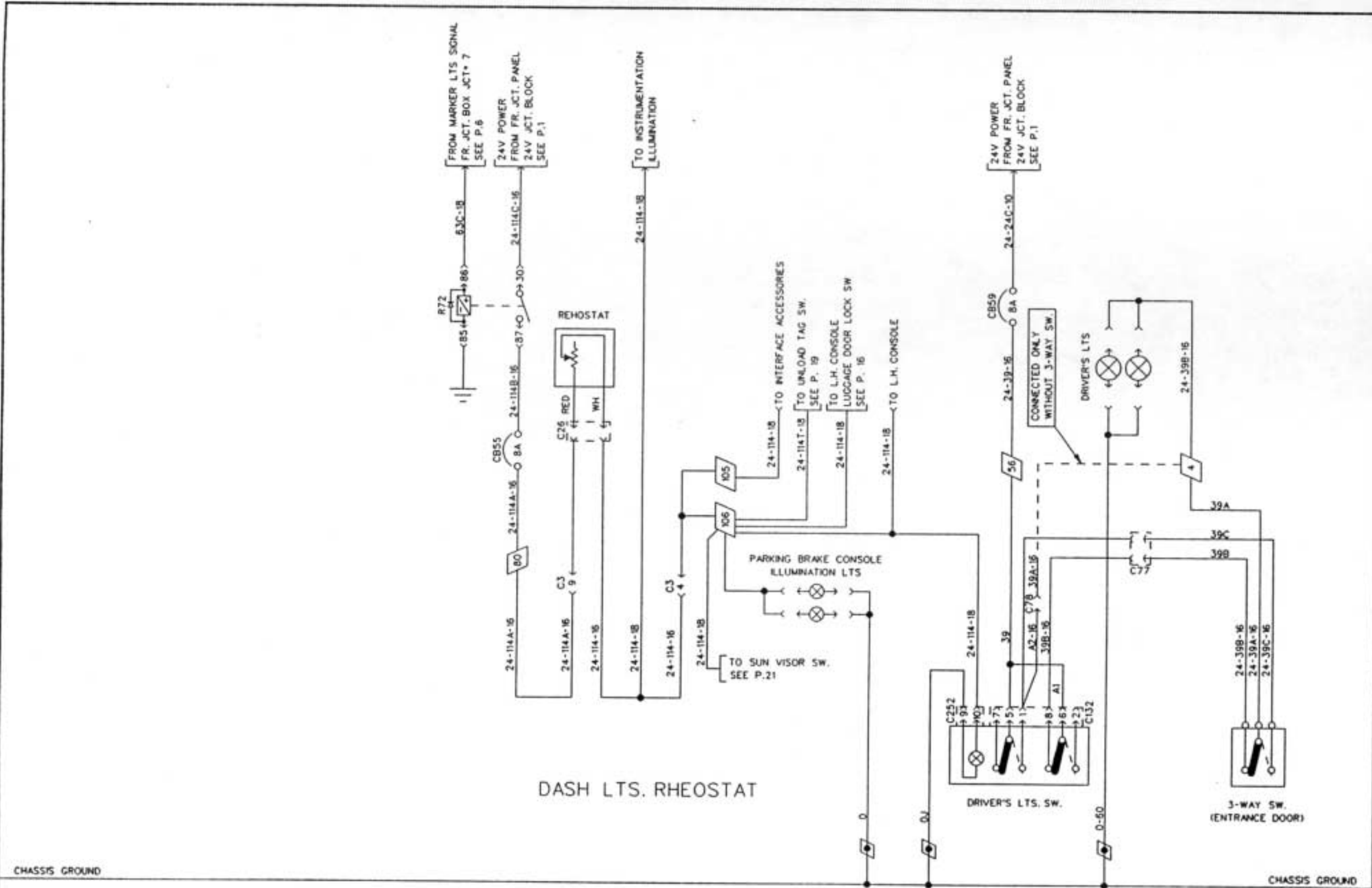

DASH LTS. RHEOSTAT

DRIVER'S LTS. SW.

3-WAY SW. (ENTRANCE DOOR)

INTERIOR LIGHTING

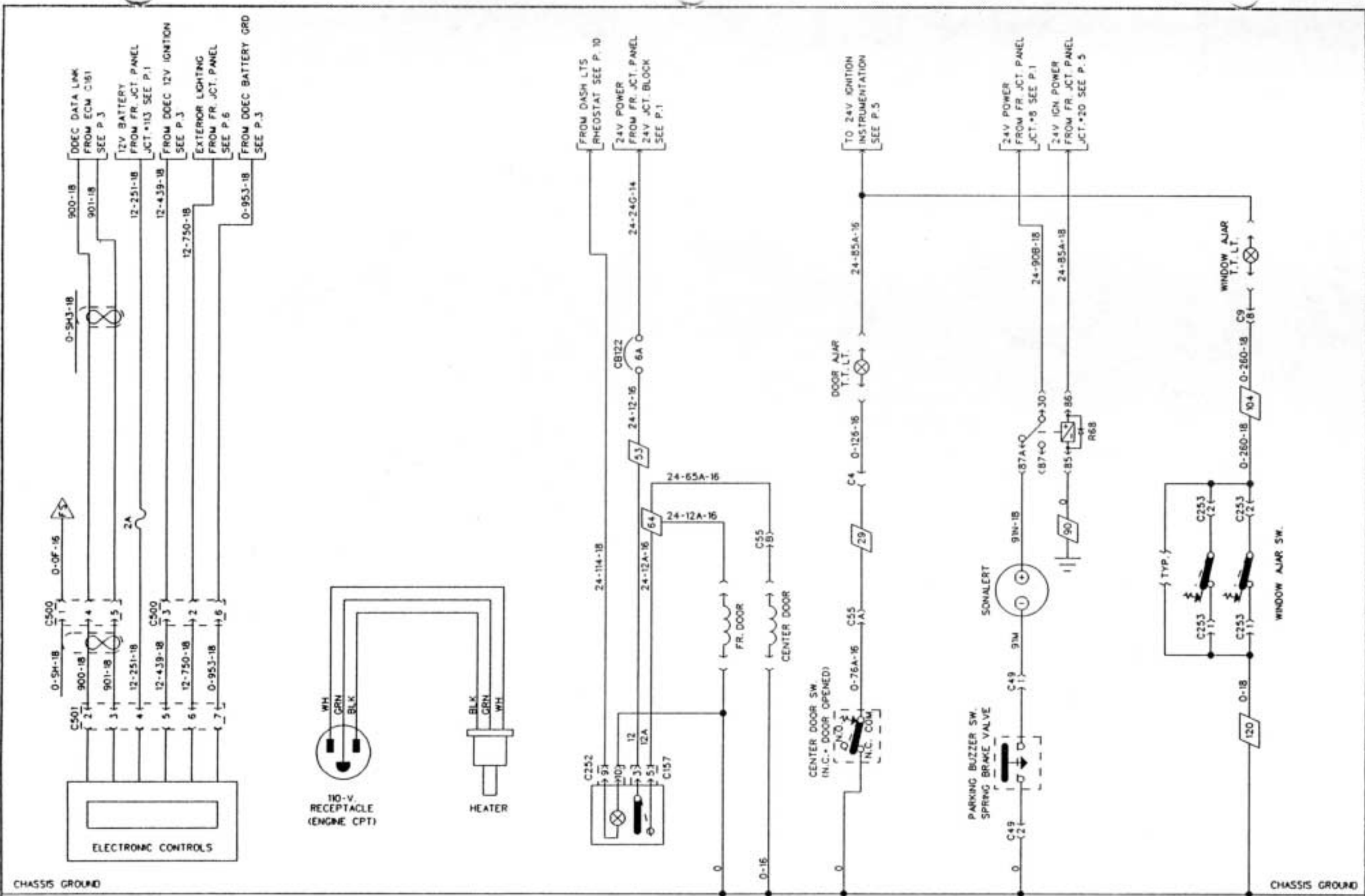

PRODRIVER | ENGINE BLOCK HEATER | ENTRANCE DOOR AIR LOCK | CENTER DOOR AIR LOCK | PARKING BRAKE ALARM | WINDOW AJAR

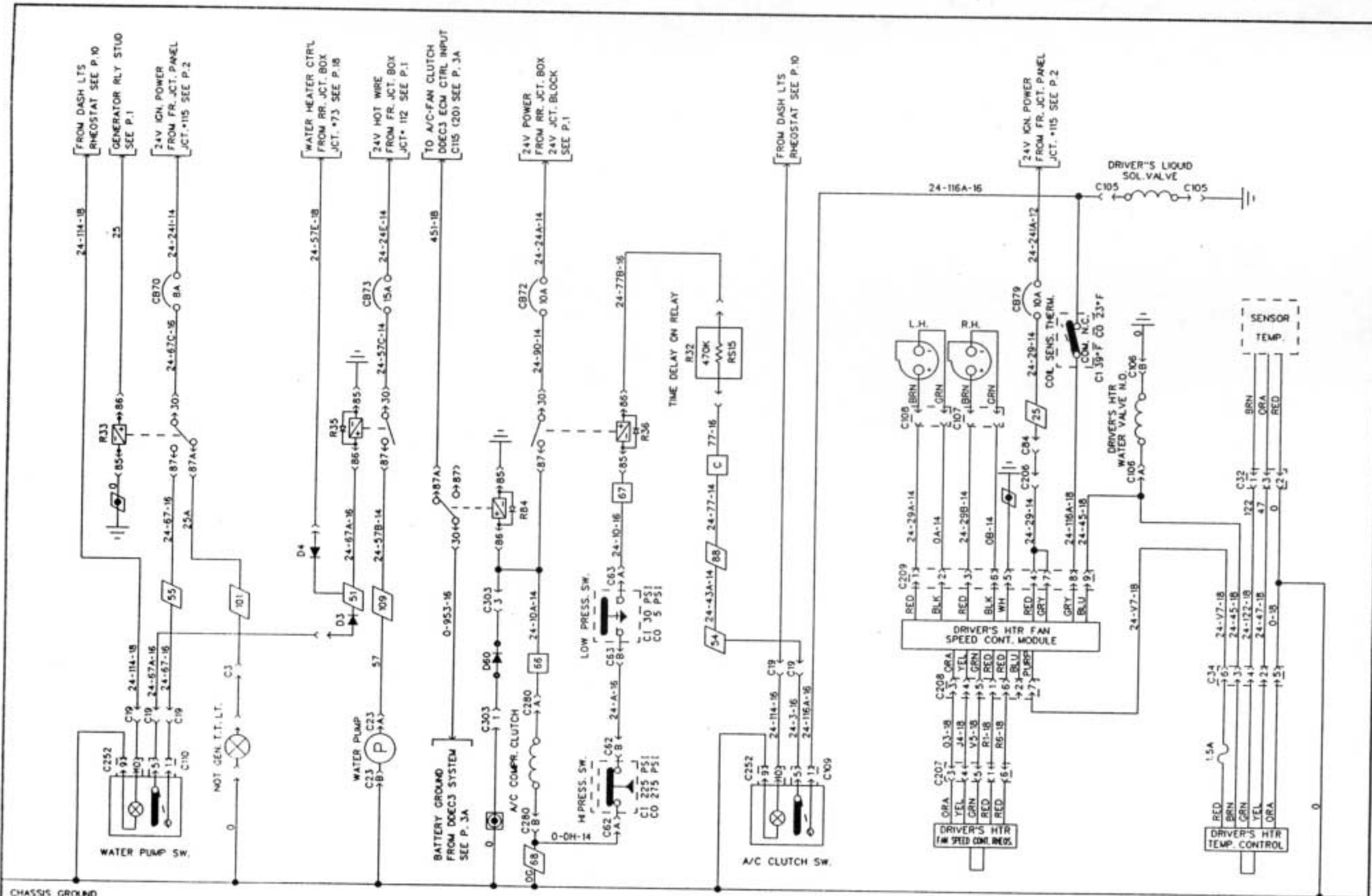

STANDARD A/C AND HEAT SYSTEM

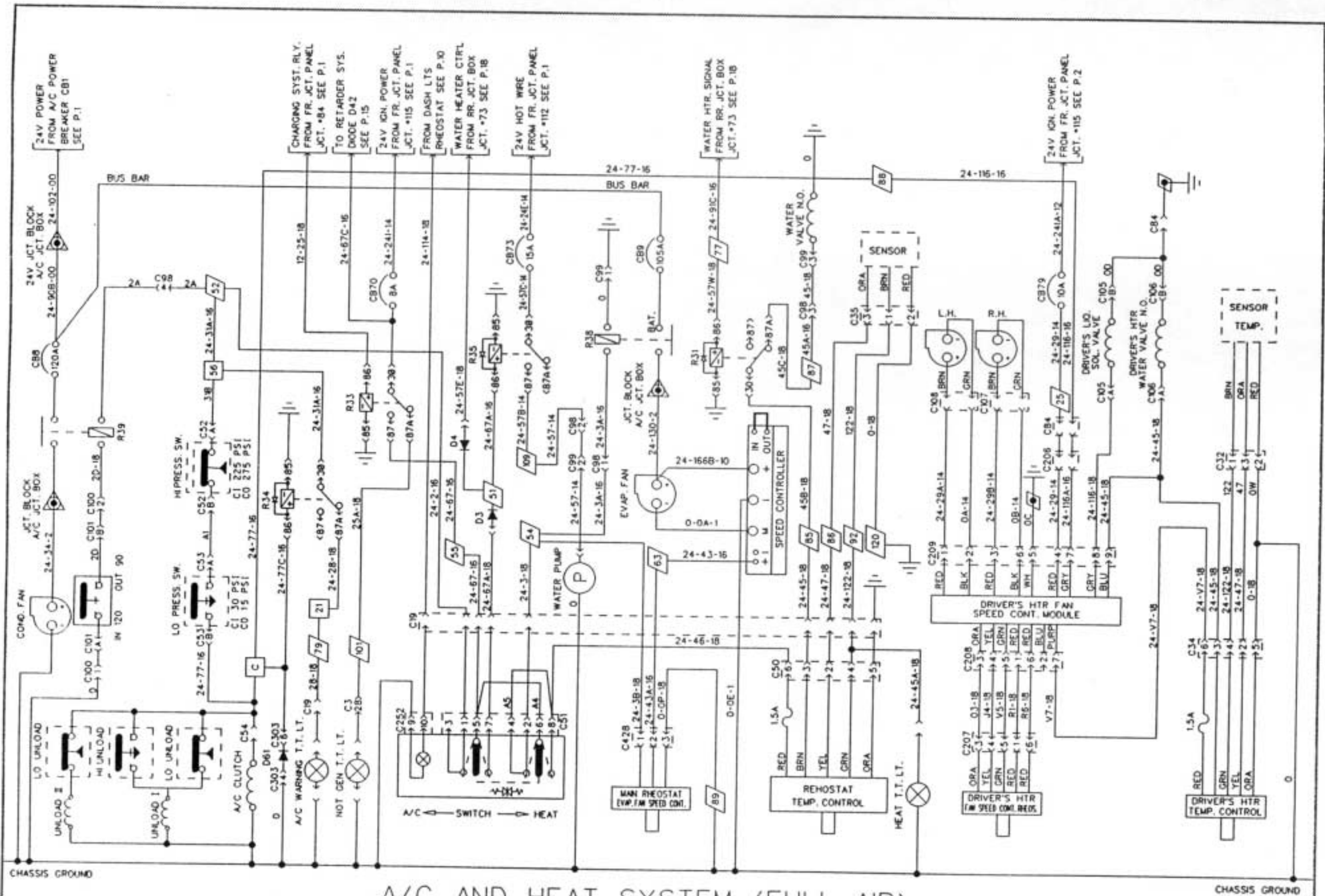

A/C AND HEAT SYSTEM (FULL AIR)

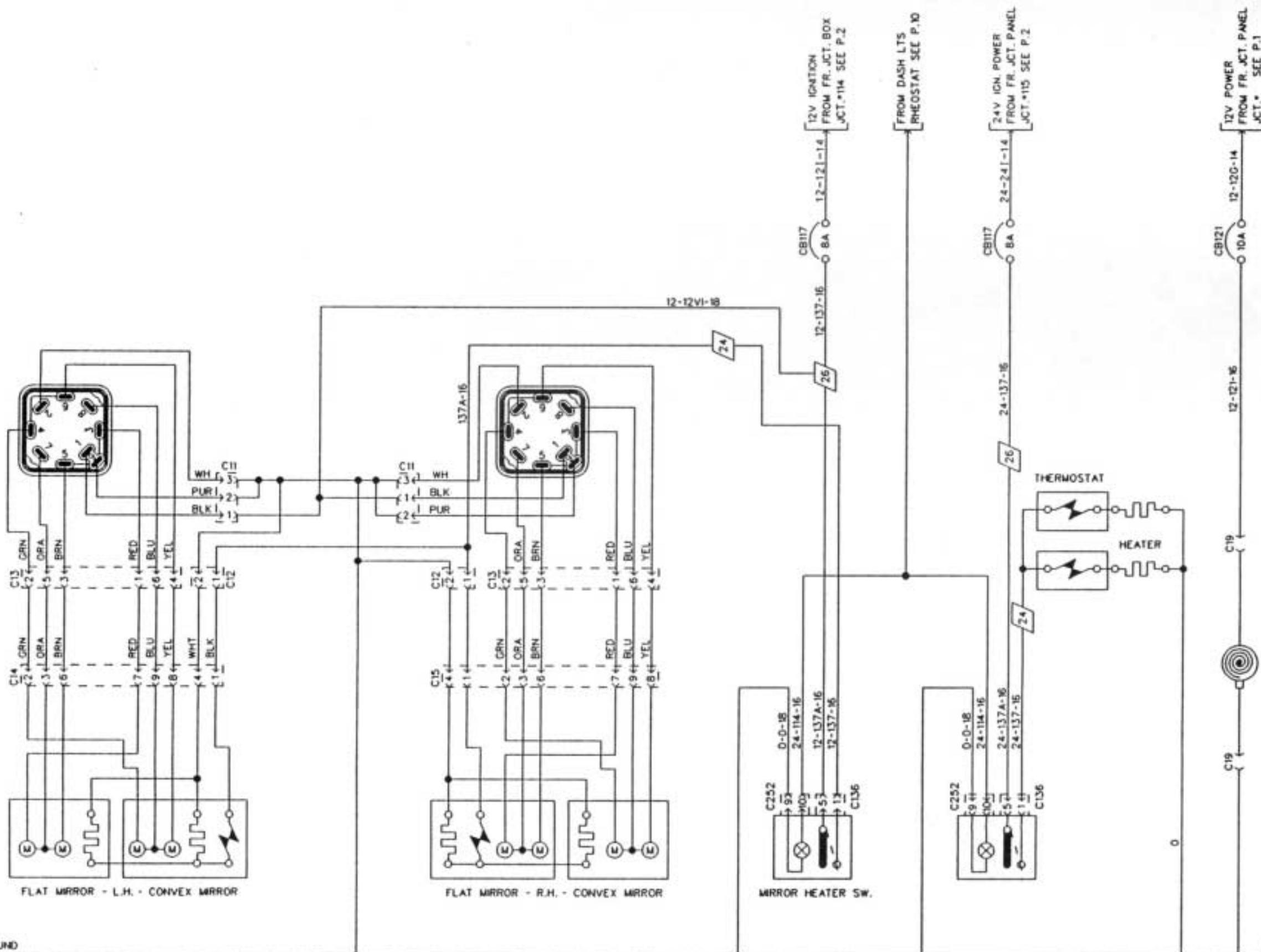

REAR VIEW MIRROR - ADJUSTMENT & HEATER SW.

MIRROR - IKI

CIGAR LIGHTER

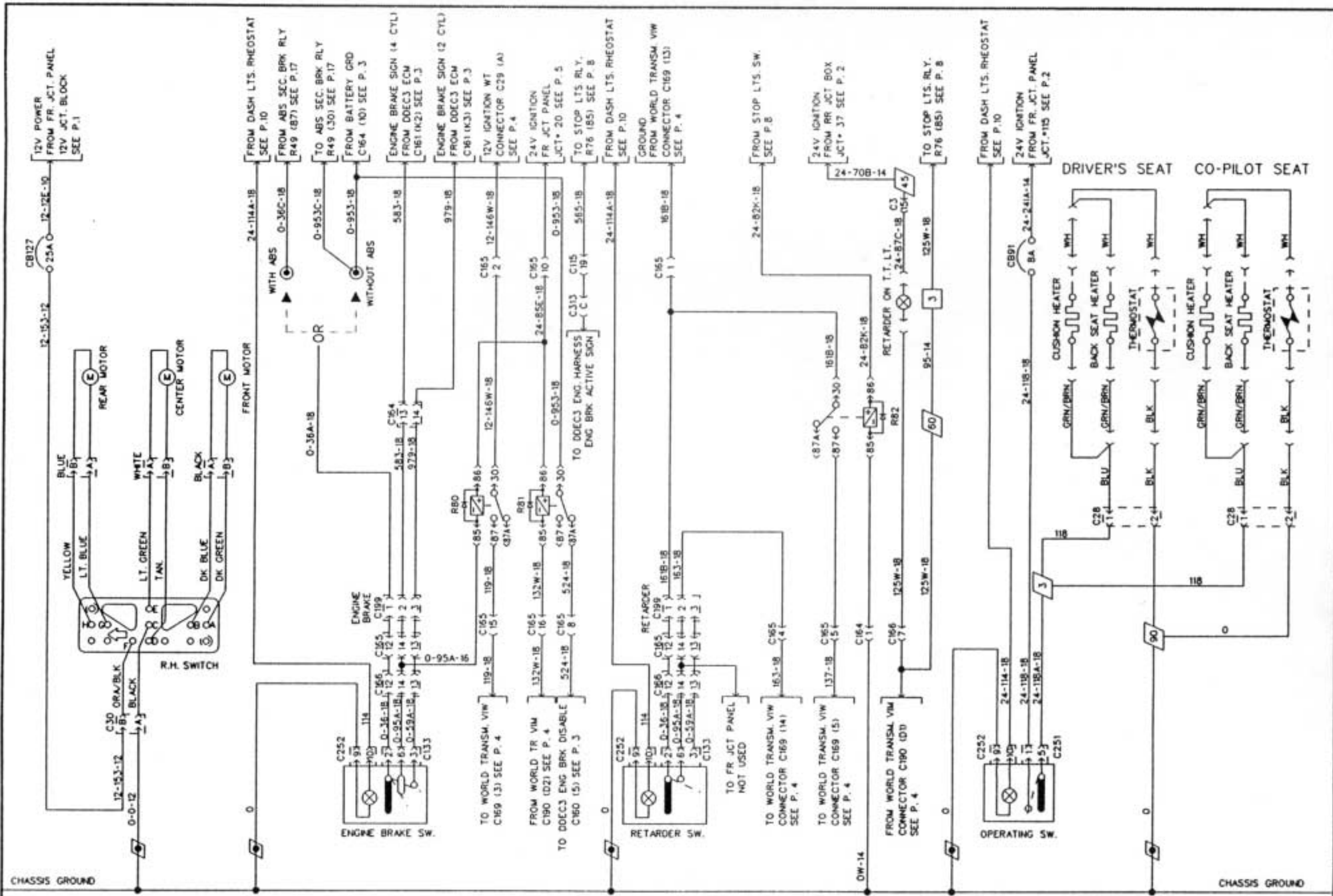

ELECTRIC DRIVER'S SEAT | ENGINE BRAKE SYSTEM | RETARDER SYSTEM (WORLD TRANSMISSION) | DRIVER'S & CO-PILOT SEAT HEATER

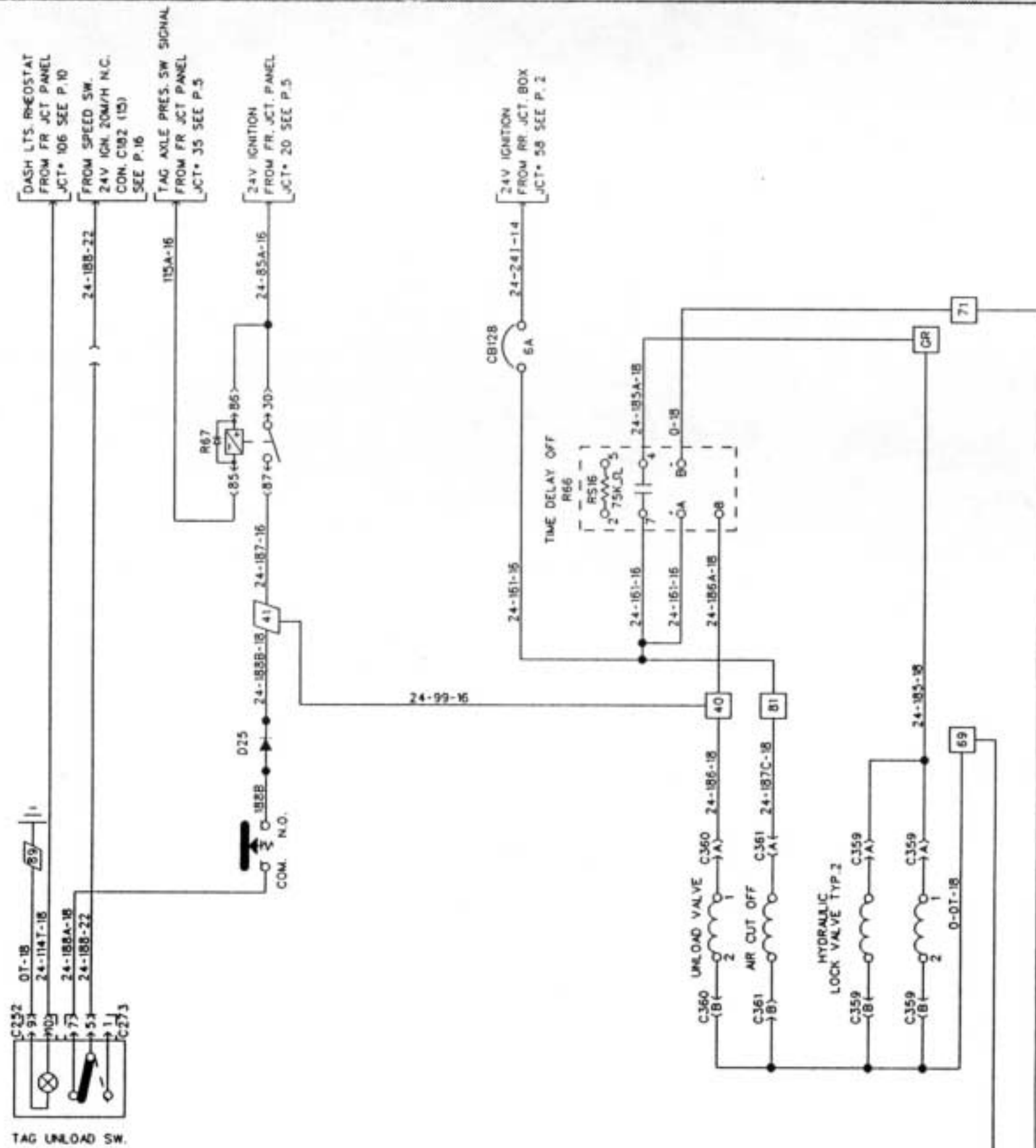

UNLOAD TAG SYSTEM

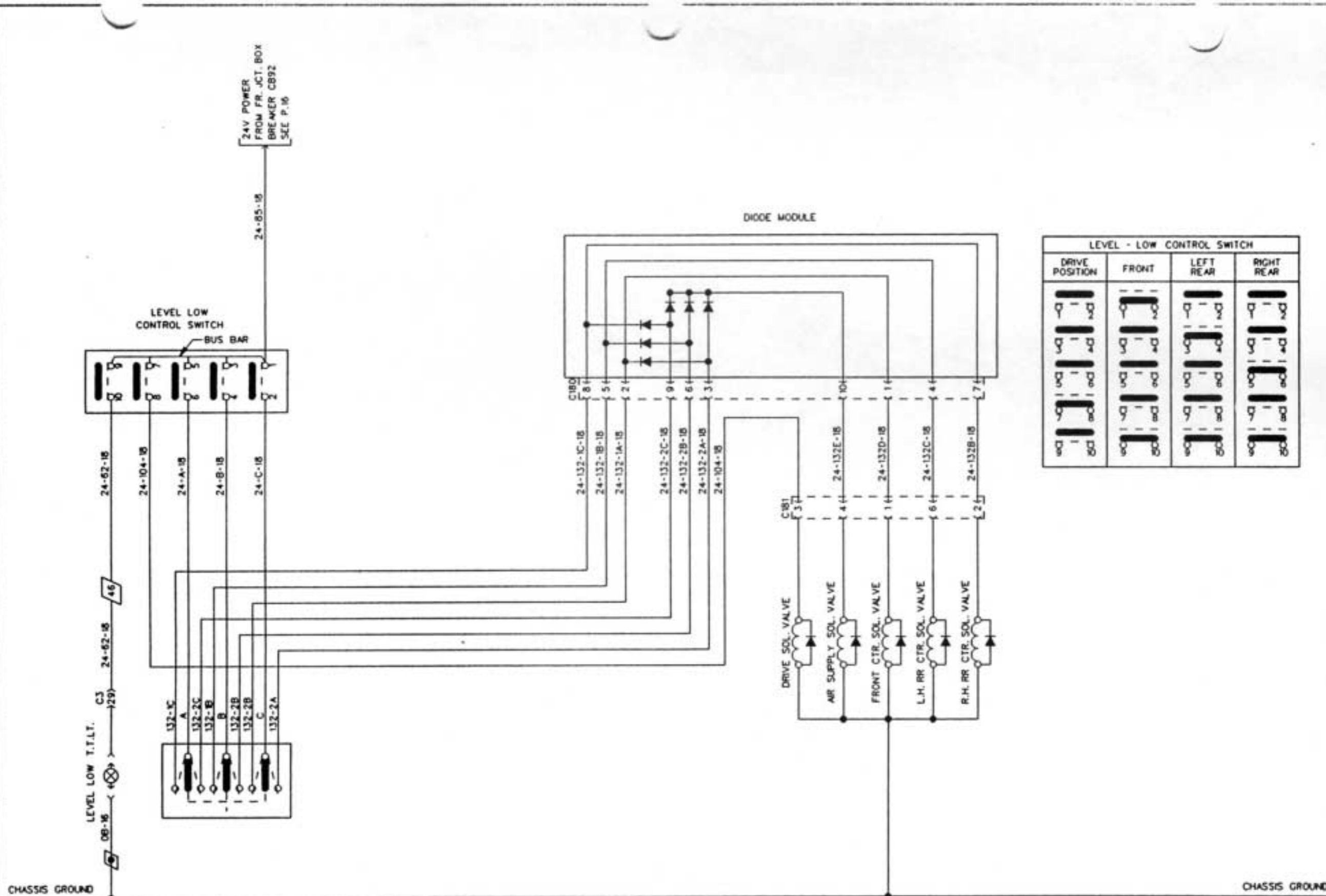

LEVEL - LOW CONTROL SWITCH			
DRIVE POSITION	FRONT	LEFT REAR	RIGHT REAR

LEVEL - LOW SYSTEM

