

****Ground distribution:****

0-Electric gnd
00- Electronic Gnd

A-Dash - Lh console harness
F-Front junction box harness
FH-Front harness
R-Rear junction box harness
FR-Front to rear

Chassis ground distribution

Front GND stud

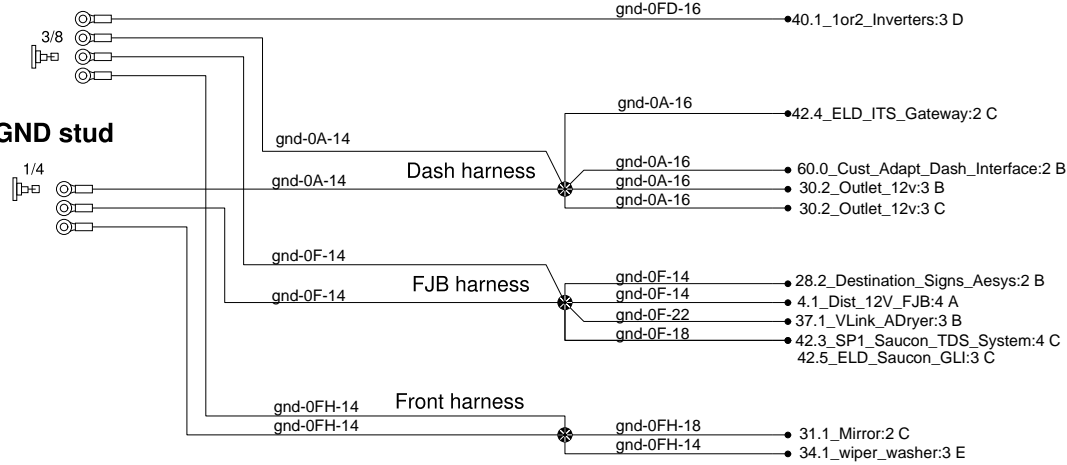

Condensor cmpt. stud

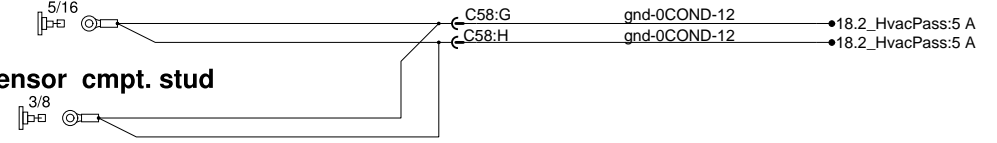

Condensor cmpt. stud

RJB stud



RJB stud



Front radiator stud



Rear radiator stud



Rad door stud



Evaporator cmpt. stud



Evaporator cmpt. stud

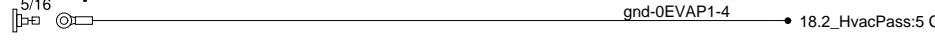

Urea cmpt. stud

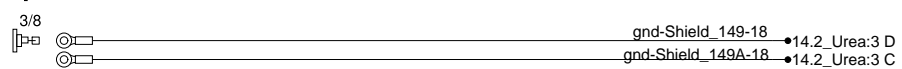

Urea cmpt. stud



Parcel rack stud #1

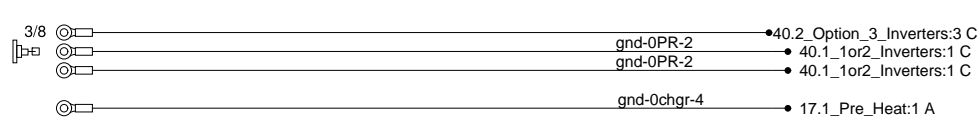

Parcel rack stud #2



Located on the top of the luggage compartment

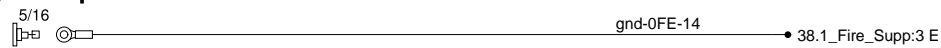

Luggage chassis stud



Trailer stud

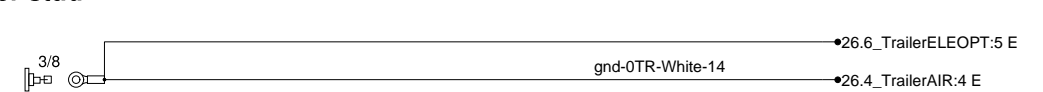

Engine studs

Engine cmpt. studs

