

****Ground distribution:****

0-Electric gnd
00- Electronic Gnd

A-Dash - Lh console harness
F-Front junction box harness
FH-Front harness
R-Rear junction box harness
FR-Front to rear

Chassis ground distribution

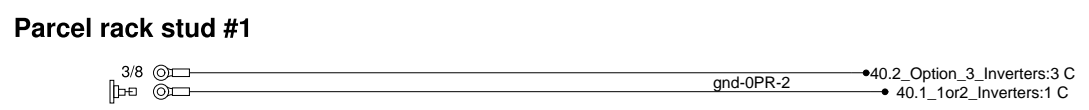
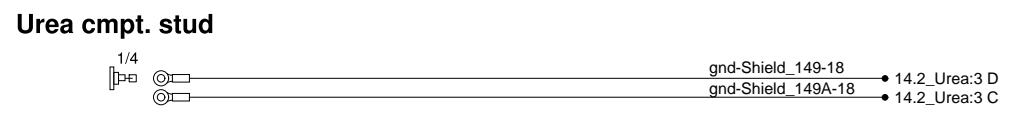
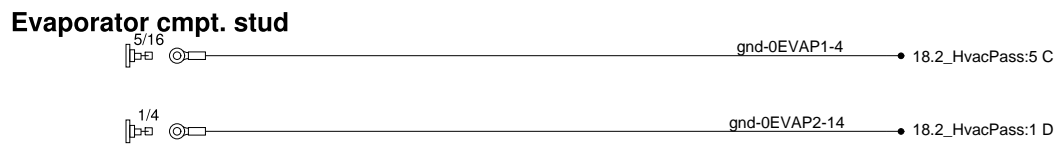
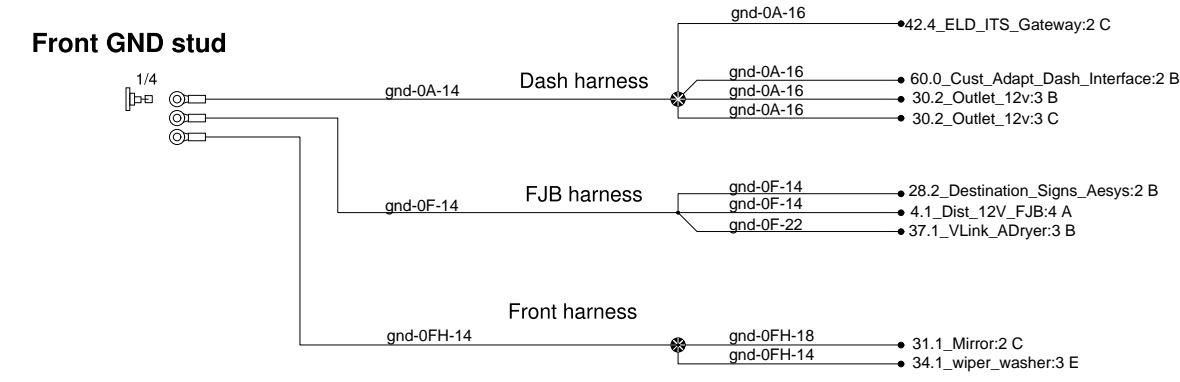

Condensor cmpt. stud

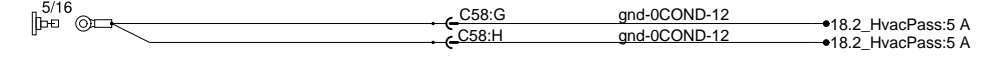

RJB stud



Front radiator stud

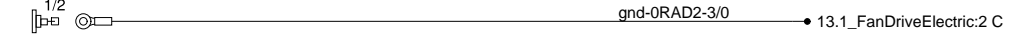

Rear radiator stud



Rad door stud

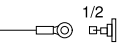

Trailer stud



Engine studs

Engine cmpt. studs

