

FANS, BLINDERS & MIRRORS

JA

WIRING DIAGRAM

SWITCH, DRIVER AND GUIDE FAN

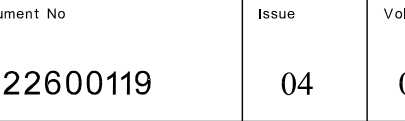
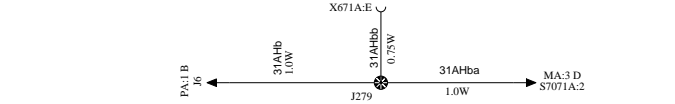
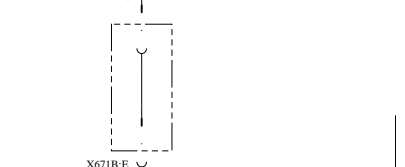
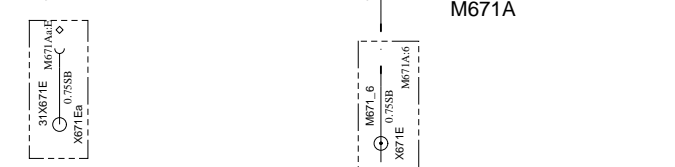
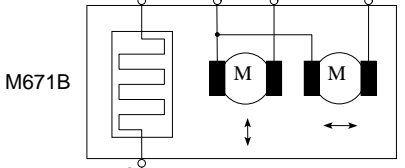
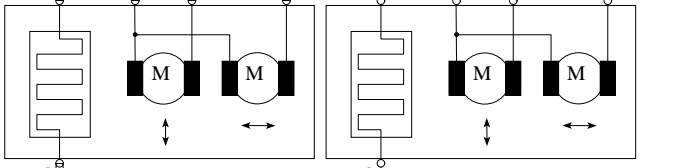
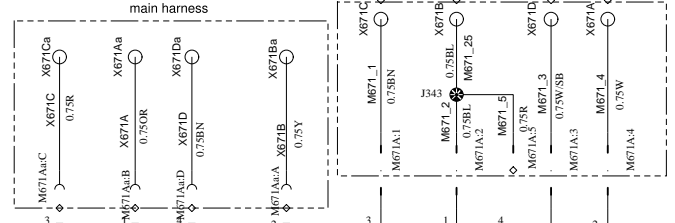
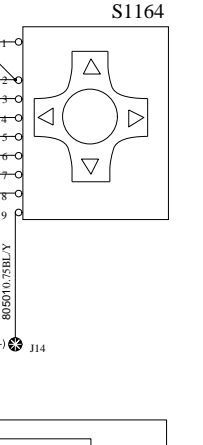
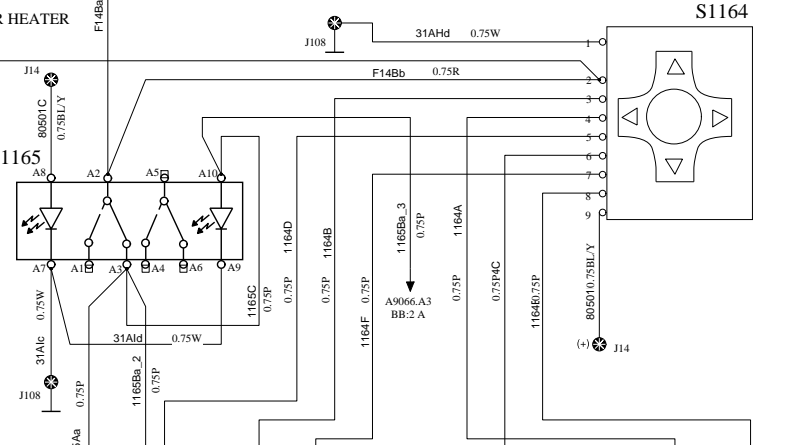
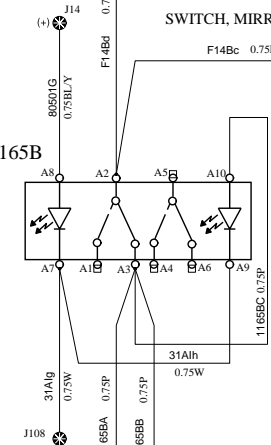
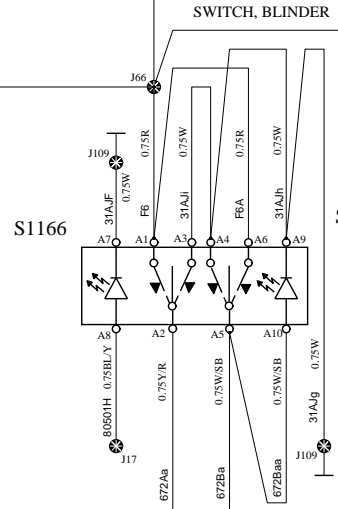
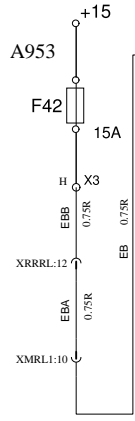
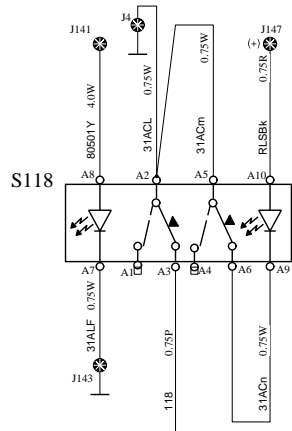

Volvo Bus Corporation

Document title
WIRING DIAGRAM

Document type
PRODUCT SCHEMATIC

Document No

22600119

Issue

04

Volume

01

Page

47/74