

AUDIO

LB

WIRING DIAGRAM

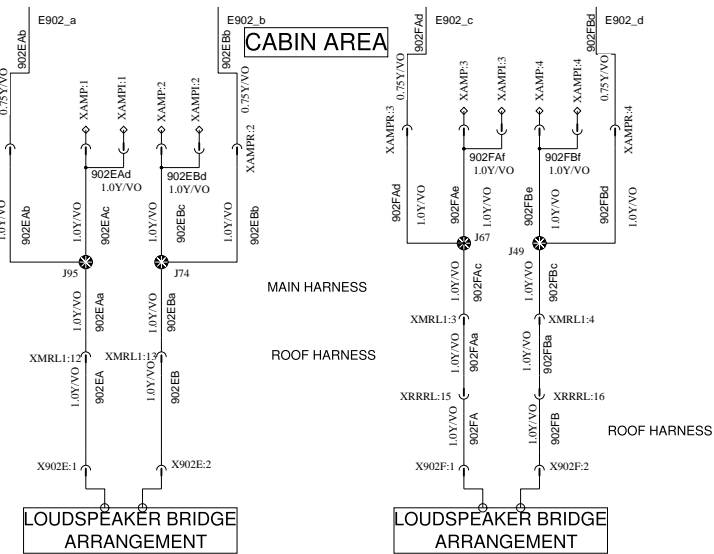

**LOUDSPEAKER'S BRIDGES BY ENVIRONMENTAL SOUND**

ARRANGEMENT TYPE 1

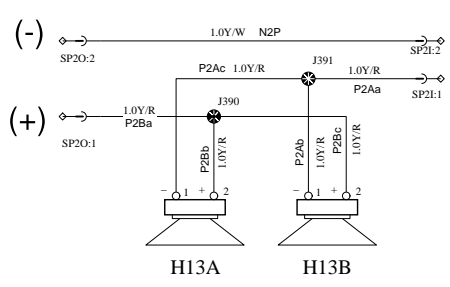

ARRANGEMENT TYPE 2

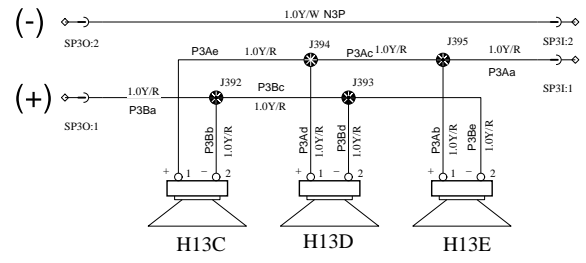

ARRANGEMENT TYPE 3

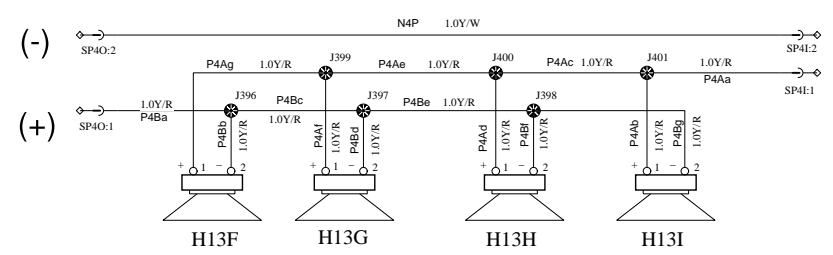

DRIVER'S SPEAKERS

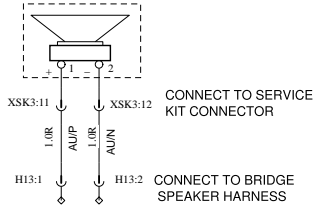
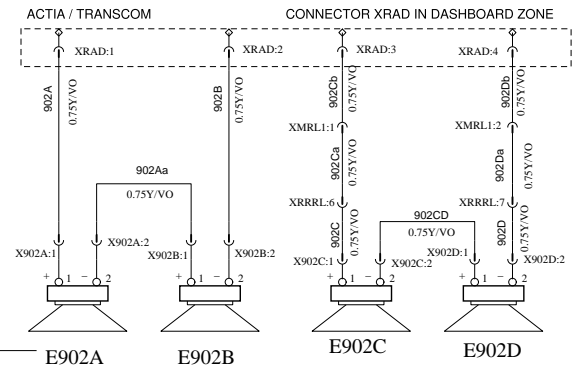
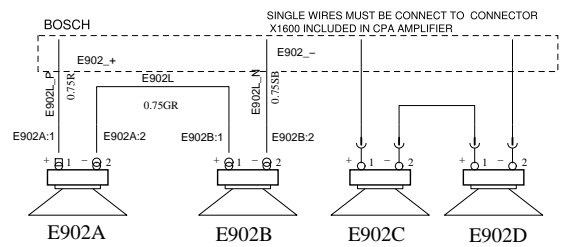

BRIDGE A

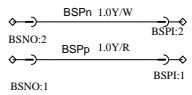

BRIDGE B (WCL & DL-110)

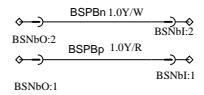

BRIDGE END JOINT

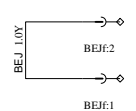

Volvo Bus Corporation

Document title	WIRING DIAGRAM
Document type	PRODUCT SCHEMATIC

Document No	Issue	Volume	Page
22600119	04	01	53/74