

# PREVOST

## *XL Series Motorcoach*

### TABLE OF CONTENTS

<b>FOREWORD</b>	<b>1 - 1</b>	Engine compartment components .....2 - 34
<b>CONTROLS/INSTRUMENTS</b>	<b>2 - 1</b>	Baggage compartment .....2 - 35
Keys.....	2 - 1	Spare wheel & tire compartment .....2 - 35
Main battery disconnect switch.....	2 - 2	A/C & heating and condenser compartment doors.....
Fuel tank filling.....	2 - 2	Service doors .....2 - 36
Controls and instrument panels.....	2 - 3	L.H. side rear service compartment and main power compartment .....2 - 36
L.H. side control panel.....	2 - 4	Battery compartment.....
Cruise control switches.....	2 - 6	Interior compartments.....
Dashboard (without tachograph).....	2 - 9	Lavatory.....
Dashboard (with tachograph).....	2 - 10	Parcel racks.....
Dashboard indicator/warning lights.....	2 - 11	Safety equipment compartment.....
L.H. lower switch panel.....	2 - 15	Accessories.....
R.H. lower switch panel.....	2 - 16	Preheating system timers (auxiliary).....
R.H. console.....	2 - 16	
Detroit diesel PRODRIVER™ controls.....	2 - 17	<b>SAFETY</b>
R.H. lateral console.....	2 - 20	<b>3 - 1</b>
Automatic transmission.....	2 - 21	Brakes.....
Manual transmission.....	2 - 23	Antilock braking system (ABS).....
Steering column controls.....	2 - 24	Air system emergency fill valve.....
Foot-operated controls.....	2 - 25	Back up alarm.....
Tilt steering wheel and telescopic steering column.....	2 - 26	Kneeling system.....
Entrance door.....	2 - 26	Hi-buoy system.....
Seats.....	2 - 27	Low-buoy system.....
Driver's seat.....	2 - 28	Emergency exits.....
Seat belts.....	2 - 28	Day time running lights.....
Passenger seats.....	2 - 29	Fog lights.....
Tour guide seat.....	2 - 29	Horns.....
Mirrors.....	2 - 29	Alarm system.....
Exterior compartments (XL-40).....	2 - 31	Safety equipment.....
Exterior compartments (XL-45).....	2 - 32	Safety precautions.....
Engine compartment doors.....	2 - 33	Defensive driving.....
Engine air intake ducts.....	2 - 33	
Fuel tank filling door.....	2 - 33	
Entrance door.....	2 - 33	

**PREVOST****XL Series Motorcoach  
SAFETY**

(see items #14 & 19 on page 2-9)

**BRAKES**

There are two (2) brake systems on your vehicle, the service brakes and the combination emergency & parking brakes, both of which are described below.

Your vehicle may also be supplied with ABS brakes (antilock braking system) and an additional retardation system. ABS brakes system information is available in this section on page 3-2; for information regarding both optional retardation systems, see "ENGINE RETARDER SYSTEM (JACOB)" on page 4-4 and "AUTOMATIC TRANSMISSION OUTPUT RETARDER" on page 4-5.

**Service brakes**

The service brakes use air pressure from a footpedal-operated master cylinder to actuate cylinders which apply the brakes at each wheel. The air system is divided into two (2) independent circuits to isolate front brakes from rear brakes, thus providing safe braking if one (1) circuit fails. Front axle brakes operate from the secondary air system, while brakes on both the drive axle and tag axle operate from the primary air system.

**NOTE:** *The tag axle service brakes operate only when the axle is in normal ride position (loaded & down).*

Furthermore, the brake application sequence, which starts with rear brakes and then front brakes, provides uniform braking on slippery surfaces.

For safe brake effectiveness, vehicle air system pressure should reach at least 95 psi (655 kPa) in both primary and secondary air circuits.

A warning light turns on (see Dashboard items #7 & 8, page 2-9) and a buzzer sounds when airpressure in one of the primary or secondary circuits drops below 60 psi (413 kPa). Vehicle must then be stopped and cause of pressure loss must be corrected before further operation.

**WARNING:** *"FANNING" or "PUMPING" brake pedal is not recommended. This practice will not increase brake system effectiveness, but will instead waste air and thereby reduce brake effectiveness.*

*"RIDING" the brake by resting foot on brake pedal when not braking can cause abnormally high brake temperatures, excessive lining wear, possible damage to the brake drums, and loss of brake efficiency.*

**Combination emergency and parking brakes****Emergency brakes**

In normal operation, if air pressure in both brake circuits drops below approximately 40 psi (276 kPa), spring-loaded emergency parking brakes will immediately be applied at full capacity on drive and tag axle wheels to stop vehicle (tag axle emergency brakes are optional on XL-40 vehicles). In an extreme condition, the emergency brakes might be applied quite rapidly. Vehicle must then be stopped and cause of pressure loss must be corrected before resuming operation.

**Parking brakes**

Spring-loaded parking brakes are manually applied by pulling up the control valve knob, located on R.H. lateral console (see page 2-20).

They are not designed to be used as service brakes. In normal driving conditions, control valve knob must be pushed all the way down.

**NOTE:** Parking brakes can supplement service brakes to stop the vehicle in an emergency condition only. The stopping distance will be considerably longer than with a normal brake application.

Before releasing parking brakes by pushing down control valve knob, pressure gauges should be checked to ensure that brake system air pressure has built up to a minimum of 95 psi (655 kPa).

**WARNING:** Always apply parking brake before leaving driver's seat.

**NOTE:** Each time the parking brake is applied and ignition key is turned or left to the "ON" position, the stoplights automatically light up.

## ABS BRAKES (antilock braking system) (Optional)

The purpose of the antilock braking system is to preserve the stability and steerability of a vehicle during braking, and to minimize its stopping distance whatever the road conditions.

On slippery roads and in emergency situations, overbraking frequently induces wheel locking. Antilock braking system provides maximum braking performance while maintaining adequate steerability on slippery roads.

Also, on smooth or slippery surfaces, the stopping distance with locked wheels is greatly extended; on rough surfaces the problem is tire abrasion.

The basis of ABS is constant monitoring of the wheel behaviour during braking. Sensors on each wheel of front and drive axles continually monitor the wheel speed during braking, transmitting this information to a four-channel electronic processor which senses when a wheel is about to lock. Modulating valves quickly adjust the brake pressure (up to 5 times per second) to prevent wheel from locking. Each wheel is thereby controlled according to the grip available between its tire and the road.

In this way the vehicle is brought to a halt in the shortest possible time, while remaining stable and under driver's control.

**CAUTION:** On slippery roads, motorists behind you may not be able to brake as fast as you; so whenever possible, give a prior warning by lightly depressing brake pedal several times before braking.

## AIR SYSTEM EMERGENCY FILL VALVE

The vehicle is equipped with two air system emergency fill valves to supplement the air system when air pressure is low and engine cannot be operated. The rear valve is located in engine compartment and is accessible from engine R.H. side door: On XL-40 vehicles, the valve is positioned next to battery booster block, close to door hinge; on XL-45 vehicles, the valve is positioned directly under back up alarm, close to L.H. side of door opening.

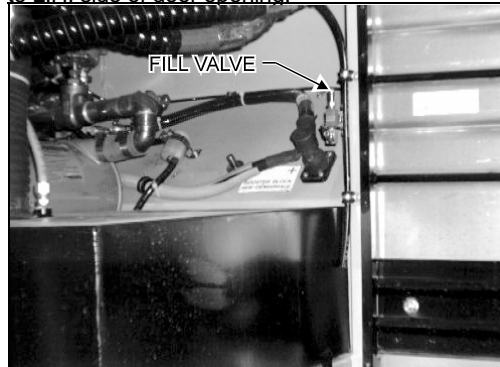

XL-40 rear valve location

12057

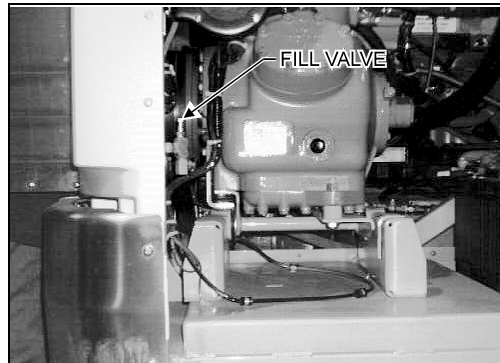

XL-45 rear valve location

12011

The front valve is located in the steering compartment close to R.H. side of door frame.

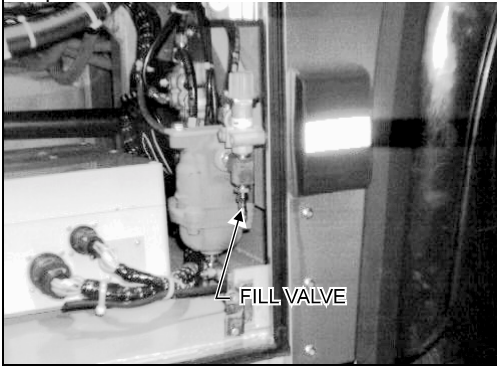

**Front valve location**

12012

These two air system emergency fill valves are fitted with the same valve stems as standard tires, and can be filled by any standard external air supply line.

The rear air system emergency fill valve will supply air for all systems (brakes, suspension and accessories) while the front fill valve will supply air for accessories only.

**CAUTION:** Air filled through these two points will pass through the standard air filtering system provided by Prévost. Do not fill air through any other points.

## **BACK UP ALARM**

The back up alarm system serves to warn bystanders of vehicle moving in reverse range. Driver should take extra precautions when backing up. If in doubt, have someone guide you.

## **KNEELING SYSTEM**

This system enables passengers to get on and off the coach without any difficulty by lowering the front end. The system operates rapidly; taking only 5 seconds to lower and 9 seconds to raise.

**NOTE:** This coach is equipped with an interlock system which will automatically apply the parking brake when the kneeling system is activated.

To operate, stop the coach, set the transmission to neutral(N), then push down the rocker switch located on the L.H. side control panel (Item #12 on page 2-4). The parking brake will be automatically applied and a warning flasher (item #1 on page 2-9) will indicate that the front of the coach is being lowered.

To raise the front of the coach to its normal height, push up the rocker switch. The front end will rapidly rise up. Release the parking brake, and shift transmission to the desired range.

**CAUTION:** Avoid parking the coach too close to the sidewalk or other obstacles that could damage the coach during kneeling operations.

**NOTE:** The kneeling system does not operate when the coach is travelling over 5 mph (8 km/h). Consequently, the driver cannot inadvertently operate the kneeling system at higher speeds.

## **HI-BUOY SYSTEM**

The coach can be equipped with a front Hi-Buoy or full Hi-Buoy.

The front Hi-Buoy system has the same functions as front kneeling. It enables passengers to get on or off the coach easily by raising the front end about 4 inches (100 mm). The front Hi-Buoy is combined with front kneeling to increase flexibility of the system (See item #12 on page 2-4).

The full Hi-Buoy system raises both the front and rear sections of the coach about 4 inches (100 mm). It can be used to enable passengers to get on or off the coach easily, to safely travel roads with high obstacles and to board Ferry Boats etc. (see item #12 on page 2-4 and indicator light #1 on page 2-9).

**NOTE:** The Hi-Buoy system does not operate when the coach is travelling over 5 mph (8 km/h). Consequently, the driver cannot inadvertently operate the Hi-Buoy system at higher speed.

## **LOW-BUOY SYSTEM**

This system lowers both the front and the rear sections of the coach about 4 inches (100 mm). It

enables the coach to drive through underpasses where the height is less than 130.7 " (3.3 m), the ground is level and your vehicle is equipped with standard tires.

Operation of the Low-Buoy is controlled by a valve (Item #4 on page 2-20) located on the R.H. lateral console. The valve can be switched to either LOW-BUOY or NORMAL positions. The coach will be lowered automatically. A warning light (item #1 on page 2-9) on the central dashboard will indicate that the coach is being lowered.

**CAUTION:** Avoid parking the coach too close to the sidewalk or other obstacles that could damage the coach during the operation of the low-buoy.

**NOTE:** The Low-Buoy system does not operate when the coach is travelling over 5 mph (8 km/h). Consequently, the driver cannot inadvertently operate the Low-Buoy system at higher speeds.

## EMERGENCY EXITS

### Side windows

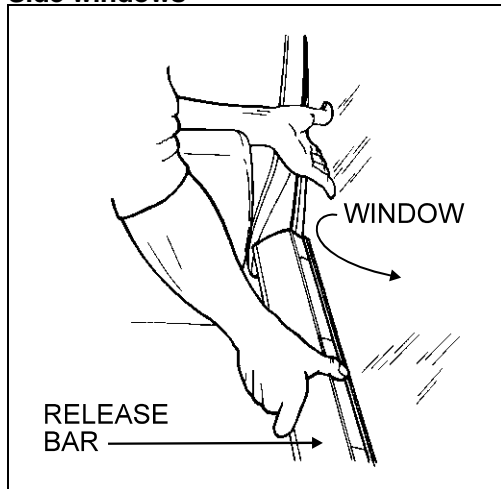

18122

Some side passenger windows can be opened from the inside for emergency escape purposes (XL-40 = 4 on driver side and 3 on curb side - XL-

45 = 4 on driver side and 4 on curb side). A decal indicating location of nearest emergency exit window is affixed at bottom of each side window. The upper section of each emergency side window is equipped with two blue lights that are activated by the exterior lighting switch located on R.H. lower switch panel (item #3 on page 2-16).

To open window, slide fingers under release bar, then push out bottom of window. Instruction decals are affixed to the release bar of each emergency exit window.

To close window, lift window release bar and pull window towards you.

**CAUTION:** All emergency exits should be kept closed during normal operation. Avoid slamming windows shut; this could damage emergency exit system.

### Emergency opening of entrance door from the inside

In the event of a malfunction in the front entrance door air lock mechanism, press the door override button located on R.H. lateral console (see item #3 on page 2-20) to release mechanism, and complete the opening procedure by turning the entrance door opening handle counterclockwise.

### Emergency roof escape

An emergency escape hatch is located in the roof at the rear of the coach, and is designed to be opened by passengers. An optional emergency roof hatch can also be installed at the front of the coach. In case of an emergency, fully push out ventilation hatch, then while depressing black tab towards rear of vehicle, push handle out in the same direction; this will release emergency hatch catch.

**NOTE:** These instructions are also affixed to escape hatch.

In the event of ventilation systems failure, hatch can be used to provide air circulation, by simply pushing hatch upwards.

**CAUTION:** If running with roof hatch(es) open, beware of low overhead clearances.

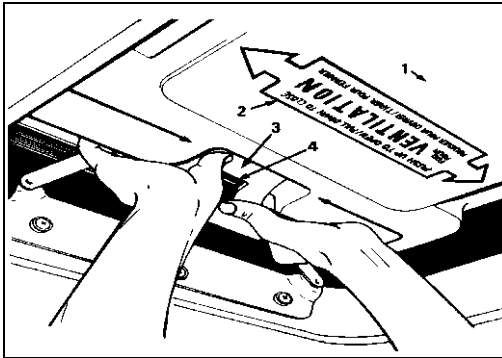

18051

- 1 .....Emergency escape hatch
- 2 .....Instructions decal
- 3 .....Hatch handle
- 4 .....Black tab

To relatch handle after use, push vent arms upright in "full open vent" position, then insert edge into bracket and pull handle in. Finally, pull hatch inward, one side at a time.

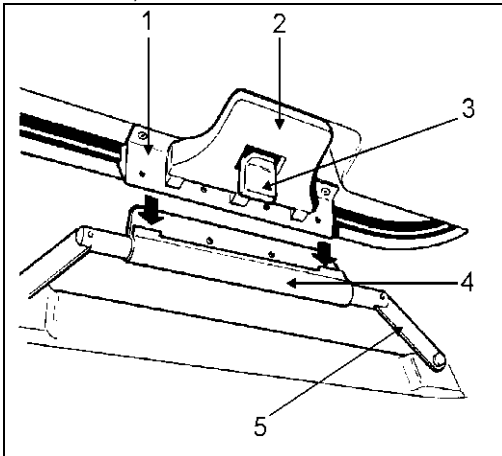

18052

- 1 .....Edge
- 2 .....Handle
- 3 .....Black tab
- 4 .....Bracket
- 5 .....Vent arm

## DAY TIME RUNNING LIGHTS

This system turns on automatically the low beams at a lower intensity as soon as engine is started and parking brake is released.

This system will be cancelled;

- when engine is stopped
- when parking brake is applied
- when the headlight switch is turned on.

**WARNING:** Never run vehicle at night with these lights only as they have a lesser intensity, and the system does not turn on the marker and clearance lights.

## FOG LIGHTS (Optional)

The halogen fog lights recessed in front bumper allow the driver a better visibility in foggy weather, and improve the range of vision just ahead of vehicle. They are also a useful "active safety" factor. For location of ON/OFF switch, see page 2-16, item #2.

**NOTE:** Some States or Provinces may restrict the use of these lamps. Verify regulations governing each State and/or Province before using fog lights.

## HORNS

### Air horns

The air horns can only be used on highways. When the push-button valve located on the floor next to driver's left foot is activated, the valve releases air which sounds the horn.

### Electric horns

Use the electric horns in cities and suburban areas. They are activated by simply pushing on button located in the center of steering wheel.

## ALARM SYSTEM

As an added protection to indicator lights, Prévost vehicles are equipped with audible alarms to inform the driver of the following operating conditions:

Indicator lights	Audible alarm	Condition
Air primary	Buzzer	Low air pressure
Air secondary	Buzzer	Low air pressure
"Do not shift"	Buzzer	Inhibits shifting of transmission
N/A	Buzzer	Lavatory emergency button is activated
N/A	Chime	Service button activated by passenger
Front kneeling	Beep	Front kneeling, low-buoy or high-buoy is selected (N/A from V.I.N. 2P9L33496S1001570)
Tag axle	Beep	Tag axle raised or unloaded
N/A	Bell ringing	Fire in engine compartment

**NOTE:** The alarms for both primary and secondary low air pressure are produced by the same buzzer.

## SAFETY EQUIPMENT

### First aid kit

A first aid kit is supplied as standard equipment and is located in the Safety Equipment Compartment (see page 2-38).

### Extinguishers

Two fire extinguishers are provided with the vehicle and are installed underneath the front L.H. side passenger seat. Use Fire Extinguishers as required, while carefully following instructions on Extinguishers' Labels. Learn how to operate fire extinguishers beforehand in case of an emergency.

### Emergency warning reflectors

A kit of triangular reflectors (Qty=3) is provided to warn approaching motorists of an immobilized vehicle in a Breakdown Situation. This device indicates an Emergency Situation by reflecting the light emanating from a light source. The three reflectors should be placed as illustrated on inside face of box cover. This kit complies with FMVSS 125 (Federal Motor Vehicle Safety Standards).

The Kit is located inside Forward Baggage Compartment and can be removed by simply

unscrewing Wing Nut and removing Retaining Rod.

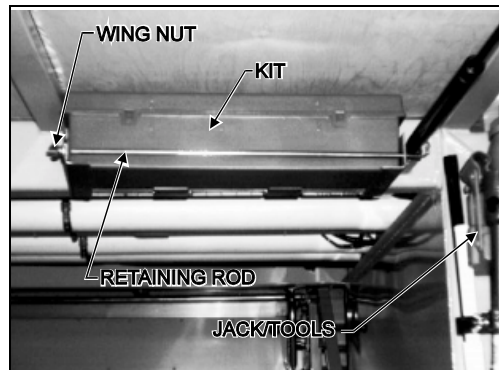

### Jack/Tools

A kit for jacking vehicle is stored inside Forward Baggage Compartment (See above figure). The kit includes a 12.5 ton hydraulic jack and a wheel nut wrench.

### Fire hatchet (Optional)

The fire hatchet is stored within the Safety Equipment Compartment (see page 2-38).

## **SAFETY PRECAUTIONS**

To ensure safe and reliable operation, take note of the following safety precautions:

- a)** Operation and maintenance of the coach must only be performed by qualified personnel.
- b)** Use caution when embarking and disembarking passengers.
- c)** Always pay attention to pedestrians passing in front and behind the coach. Always yield to pedestrians at pedestrian walkways.
- d)** Inspect the coach before operating (see "DAILY WALK-AROUND INSPECTION" on page 6-15).
- e)** Make sure good visibility is maintained at all times. Keep windshields clean and free of obstructions.
- f)** Make sure all doors are closed and secure before operating the coach. Before driving, conduct a walkaround inspection to check for security of all baggage compartment doors and equipment access doors.
- g)** Adjust the driver's seat so that all controls can be easily reached.
- h)** Always wear safety belt when driving.
- i)** Check the instrument panel frequently. Do not operate the coach when dials or indicators are not in the normal operating condition.
- j)** Switch from high beams to low beams when meeting or following other vehicles within 500 feet (150 meters).
- k)** Do not drive over obstacles on the road. Empty cartons, piles of leaves, and snowdrifts could conceal hidden dangers that could damage the coach suspension and/or underbody.
- l)** When turning or changing lanes, signal your intention well in advance.
- m)** When approaching to make a right turn, reduce spacing between coach and curb to make sure other vehicles cannot pass on the right. Since the coach makes wide turns, allow enough space to make safe turns.
- n)** Never leave the coach unattended with the engine running, or with the key in the ignition. Turn off the engine, remove keys and apply the parking brake before leaving the coach.
- o)** The service life of the coach depends on the kind of maintenance it receives. Always record any problems and report them immediately to maintenance personnel.
- p)** Shut-off engine before fueling, adding oil or performing maintenance or servicing tasks, unless stated otherwise.
- q)** Do not run the engine or HVAC system with access doors left open. Close compartment doors before operating any equipment.
- r)** Do not remove the surge tank filler cap or the cooling system pressure cap when the engine is hot. Let the engine cool down before removing filler caps.
- s)** Fuel is highly flammable and explosive. Do not smoke when refueling. Keep away from open flames or sparks.
- t)** Do not attempt to push or pull-start a coach equipped with an automatic transmission. To avoid damaging gears or bearings in manual transmission-equipped coaches, do not push, pull or roll-start in first or reverse gears.
- u)** For additional information about safe driving practices, contact the local department of motor vehicles authority.



## **DEFENSIVE DRIVING**

- a)** To keep the coach from drifting across lanes during highway driving, always look over the horizon on the road ahead.
- b)** Don't stare at the road ahead. Keep your eyes moving. Check all mirrors and dashboard instruments frequently.
- c)** Establish eye-to-eye contact with other drivers and with pedestrians. Use headlights, high-beams and low-beams, turn signals and horn(s) as needed.
- d)** For city driving, allow a four to six second travel interval between the coach and the vehicle ahead. Increase this travel interval to six to eight seconds for highway driving. Use increased travel interval for night driving and in bad weather.
- e)** Adjust your speed according to the road conditions, traffic and visibility. Never exceed the posted speed limits.
- f)** Reduce your speed if another vehicle is following too close behind to let the vehicle pass.
- g)** Be prepared to stop when approaching an intersection. The stopping distance of the coach increases with the weight and speed of the coach.
- h)** For additional information about defensive driving practices, contact the local department of motor vehicles authority.