

# SECTION 09: PROPELLER SHAFT

---

## CONTENTS

1. PROPELLER SHAFT .....	09-2
1.1 Description .....	09-2
2. REMOVAL, DISASSEMBLY, REASSEMBLY AND INSTALLATION .....	09-2
3. CLEANING, INSPECTION AND LUBRICATION.....	09-2
3.1 Cleaning and Inspection .....	09-2
3.2 Lubrication.....	09-2
4. EXPLANATION OF COMMON DAMAGES .....	09-3
5. TROUBLESHOOTING.....	09-3
6. SPECIFICATIONS.....	09-4

## LIST OF ILLUSTRATIONS

FIG. 1: PROPELLER SHAFT ASSEMBLY.....	09-3
---------------------------------------	------

## **1. PROPELLER SHAFT**

### **1.1 Description**

The propeller shaft transmits power from the transmission to the differential (Fig.1). According to the transmission model with series 60 engine, two lengths of propeller shafts are available. Refer to paragraph "6. Specifications" at the end of this section for details. Both propeller shafts are "Dana 1810" type and each shaft is tubular. They are provided with two heavy-duty universal joints (Fig. 1).

The propeller shaft has a full round end yoke at each end. The tube yoke is connected to the differential by a full round end yoke with four needle bearings.

The other extremity (slip yoke assembly) is connected to the transmission by a half round end yoke with two needle bearings.

Furthermore, a slip joint on the propeller shaft compensates for variations in distance between the transmission (manual or automatic) and the differential, or between the output retarder (optional on the automatic transmission) and differential.

These variations are brought about by the rise and fall of the drive axle as the vehicle passes over uneven surfaces. The slip joint also eases removal of the transmission or the drive axle.

## **2. REMOVAL, DISASSEMBLY, REASSEMBLY AND INSTALLATION**

Refer to the "Spicer Universal Joint and Driveshafts" annexed to the end of this section, under headings Heavy Duty - Removal, Disassembly, Reassembly and Installation.

Where applicable:

- Remove or install propeller shaft safety guard.
- Screw bolts to the specified torque ( Fig. 1).

**Note:** *Disregard the procedure on lock straps mentioned in the Spicer Universal Joints and Driveshafts Manual.*

## **3. CLEANING, INSPECTION AND LUBRICATION**

### **3.1 Cleaning and Inspection**

Thoroughly clean grease from bearings, journal, lubricating grease fittings and other parts. Needle bearing assemblies may be soaked in a cleaning solution to soften hard grease particles. It is extremely important that bearing assemblies be absolutely clean and blown out with compressed air, since small particles of dirt or grit can cause rapid bearing wear. Do not attempt to disassemble needle bearings.

Bearing journal areas should be inspected for roughness or grooving. If light honing does not remove roughness, the entire bearing assembly should be replaced. Excessive wear of the needle bearing is indicated if the needles drop out of the retainer, or if marks are present on the journal bearing surface. In such case, replace bearing assembly. Finally, inspect yokes for cracks, wear or distortion.

**Note:** *Repair kits are available for overhaul of the propeller shaft assembly. Refer to the paragraph "6. Specifications" of this section.*

### **3.2 Lubrication**

Lubricate propeller shaft universal joints and slip yoke periodically, every 6,250 miles (10 000 km) or twice a year, whichever comes first. Apply grease gun pressure to the lube fitting. Use a good quality lithium-base grease such as: NLGI No.2 (suitable for most temperatures) or NLGI No.1 (suitable for extremely low temperatures). Refer to "Spicer Universal Joints and Driveshafts, Service Manual", under heading, "Inspection and Lubrication". See lubrication procedures for U-joints and lubrication for slip splines.

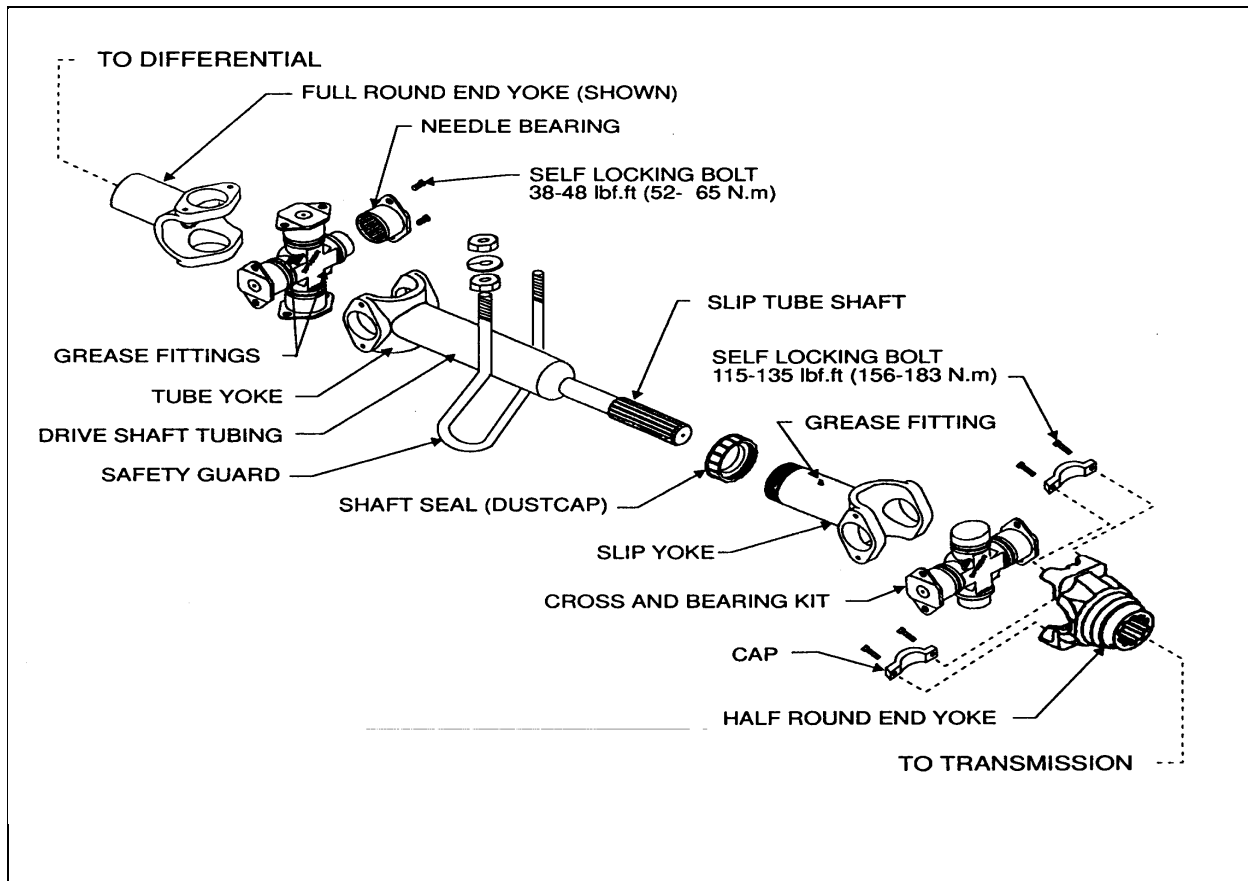

FIGURE 1: PROPELLER SHAFT ASSEMBLY

09001

## 4. EXPLANATION OF COMMON DAMAGES

1. **Cracks:** Stress lines due to metal fatigue. Severe and numerous cracks will weaken the metal until it breaks.
2. **Galling:** Scraping off of metal or metal displacement due to friction between surfaces. This is commonly found on trunnion ends.
3. **Spalling (surface fatigue):** Breaking off of chips, scales, or flakes of metal due to fatigue rather than wear. It is usually found on splines and U-joint bearings.
4. **Pitting:** Small pits or craters in metal surfaces due to corrosion. If excessive, pitting can lead to surface wear and eventual failure.

5. **Brinelling:** Surface wear failure due to the wearing of grooves in metal. It is often caused by improper installation procedures. Do not confuse the polishing of a surface (false brinelling), where no structural damage occurs, with actual brinelling.

6. **Structural Overloading:** Failure caused by a load greater than the component can stand. A structural overload may cause propeller shaft tubing to twist under strain or it may cause cracks or breaks in U-joints and spline plugs.

## 5. TROUBLESHOOTING

Refer to "Spicer Universal Joints and Driveshafts, Service Manual". See heading "Troubleshooting".

## 6. SPECIFICATIONS

### PROPELLER SHAFT

#### For H3 Vehicles Equipped with a 6-Speed Manual Transmission

Make ..... Hayes-Dana Inc.  
Series..... 1810  
Supplier number.....819325-2200  
Prevost number..... 080072

#### For H3 Vehicles Equipped with an Automatic World Transmission or a 7-Speed Manual Transmission

Make ..... Hayes-Dana Inc.  
Series..... 1810  
Supplier number.....819325-1900  
Prevost number..... 080068

#### Repair kits

Make ..... Hayes-Dana Inc  
U-joint kit (tube yoke), Supplier number..... 5-281X  
U-joint kit (tube yoke), Prevost number..... 580043  
U-joint kit (slip yoke), Supplier number ..... 5-510X  
U-joint kit (slip yoke), Prevost number ..... 580062  
Cap and bolt kit, bolt torque 115-135 lbf•ft (156-183 N•m), Supplier number ..... 6.5-70-18X  
Cap and bolt kit, bolt torque 115-135 lbf•ft (156-183 N•m), Prevost number ..... 580063  
Bolts kit, bolt torque 38-48 lbf•ft (52-65 N•m), Supplier number.....6-73-209  
Bolts kit, bolt torque 38-48 lbf•ft (52-65 N•m), Prevost number..... 580071

#### Half Round End Yoke

Make ..... Hayes-Dana Inc  
(6-speed), Supplier number ..... 6.5-4-3021-1  
(6-speed), Prevost number ..... 580072  
Make ..... Dana-Spicer  
(7-speed), Supplier number ..... 6.5-4-3821-1  
(7-speed), Prevost number ..... 571690

**Note:** *U-joint kits will come equipped with the serrated bolt and lock patch and will no longer contain a lock strap.*

**COMPANION FLANGE (1)**

(2 STYLES)



**FLANGE YOKE (2)**

(2 STYLES)

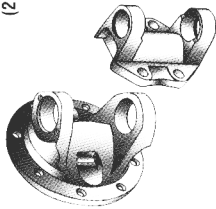

**SLIP YOKE ASSEMBLY (3)**

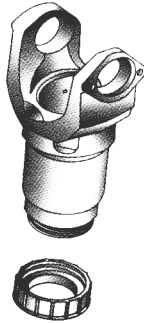

**END YOKE (4)**

(3 STYLES)



**JOURNAL & BEARING KIT**

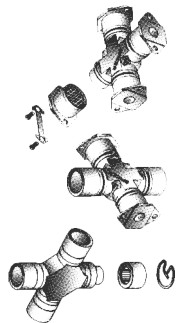

# SPICER® LIFE™ DRIVELINE COMPONENTS

Quick Disconnect™ Half Round End Yoke  
(Double Spline Design)

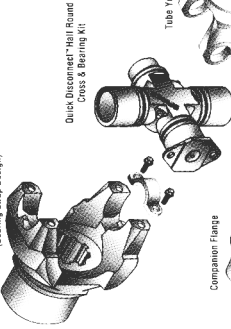

Quick Disconnect™ Half Round  
Cross & Bearing Kit

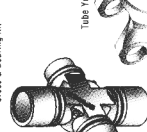

Tube Yoke



Companion Flange



Flange Yoke



Tube Yoke



Driveshaft Tubing



**3 JOINT ASSEMBLY DRIVESHAFT**

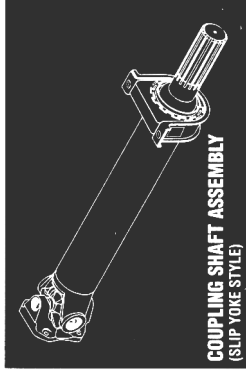

**COUPLING SHAFT ASSEMBLY  
(SLIP YOKE STYLE)**

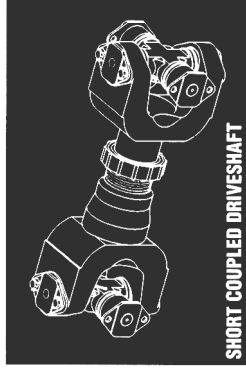

**SHORT COUPLED DRIVESHAFT**

**2 JOINT ASSEMBLY DRIVESHAFT**

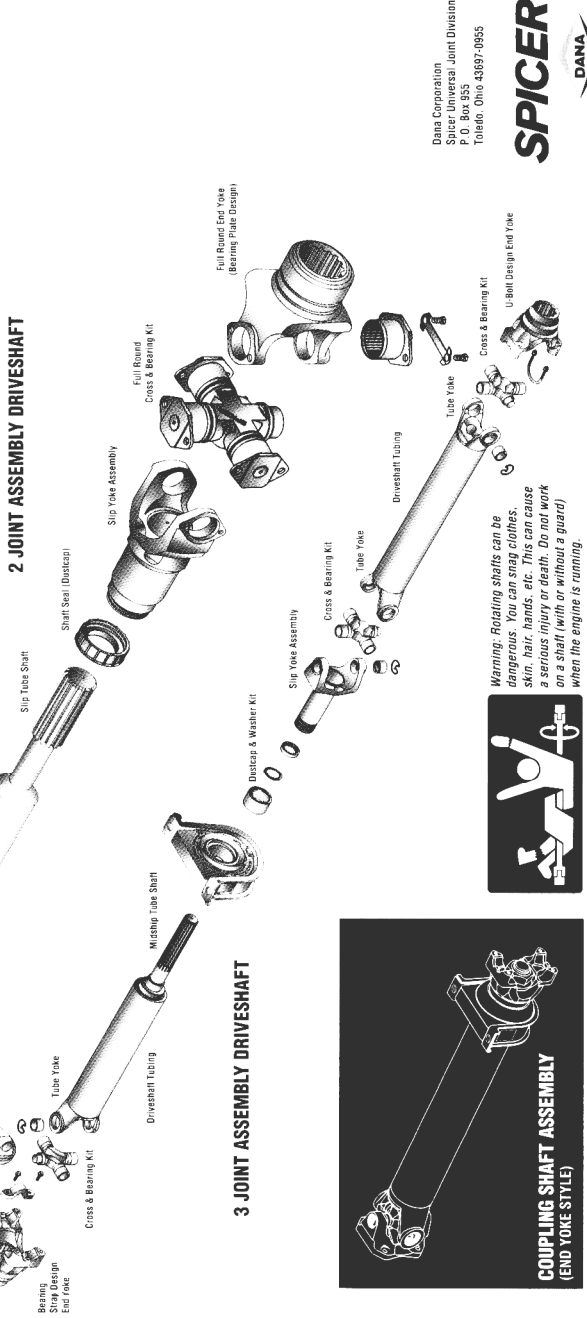

Slip Tube Shaft



Shaft Seal (Dustcap)



Slip Yoke Assembly



Full Round End Yoke  
(Bearing Plate Design)



U-Bolt Design End Yoke



**Warning: Rotating shafts can be dangerous. You can snag clothes, skin, hair, hands, etc. This can cause a serious injury or death. Do not work on a shaft (with or without a guard) when the engine is running.**



1994 Dana Corporation - Printed in U.S.A.

Dana Corporation  
Spicer Universal Joint Division  
P. O. Box 955  
Toledo, Ohio 43697-0955



Boletín 3221-Z

**TUBING (30 or 32)**

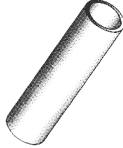

**TUBE SHAFT (40-42)**

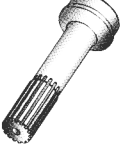

**MIDSHIP TUBE SHAFT (53-57)**



(SLIP STYLE)

(END YOKE STYLE)

**SERRATED BOLTS w/LOCK PATCH (73)**



**LOCK STRAP (98)**



After Spring 94

Pre-Spring 94

**U-BOLT ASSEMBLY (94)**



**SOCKET YOKE (83)**

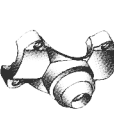

**DUST CAP & WASHER KIT (VARIOUS PART NOS.)**



**STRAP OR CAP & BOLT ASSEMBLY (70)**



**SHAFT SUPPORT BEARING ASSEMBLY**

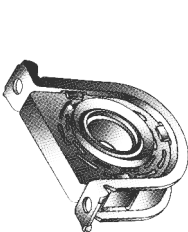

**CENTER YOKE (26)**

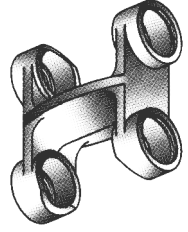

**YOKE SHAFT (82)**

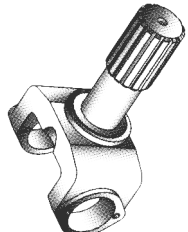

**TUBE YOKE (28)**

(2 STYLES)

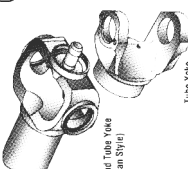

Centering Slip Tube Yoke  
(Double Cardan Style)

Tube Yoke

**TUBE YOKE w/TUBE (27)**

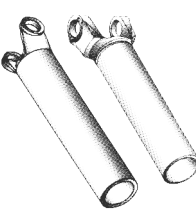

**COMPANION FLANGE (1)**

(2 STYLES)



**FLANGE YOKE (2)**

(2 STYLES)

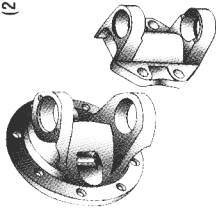

**SLIP YOKE ASSEMBLY (3)**

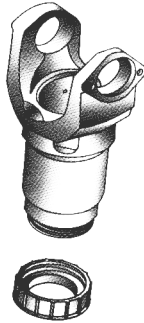

**END YOKE (4)**

(3 STYLES)



**JOURNAL & BEARING KIT**

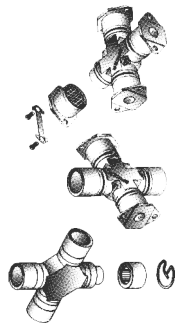

# SPICER® LIFE™ DRIVELINE COMPONENTS

Quick Disconnect™ Half Round End Yoke  
(Double Spring Design)

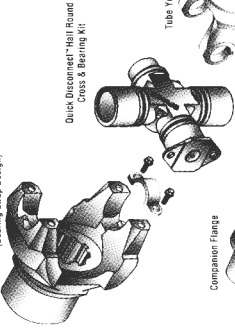

Quick Disconnect™ Half Round  
Cross & Bearing Kit

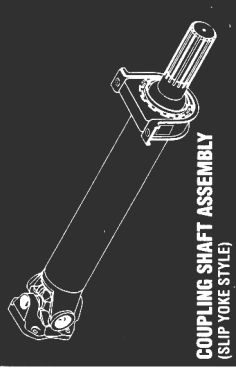

**COUPLING SHAFT ASSEMBLY  
(SLIP YOKE STYLE)**

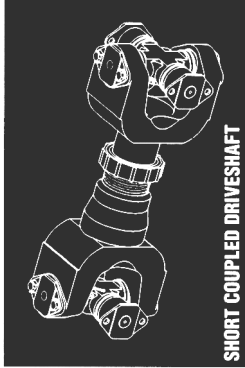

**SHORT COUPLED DRIVESHAFT**

**2 JOINT ASSEMBLY DRIVESHAFT**

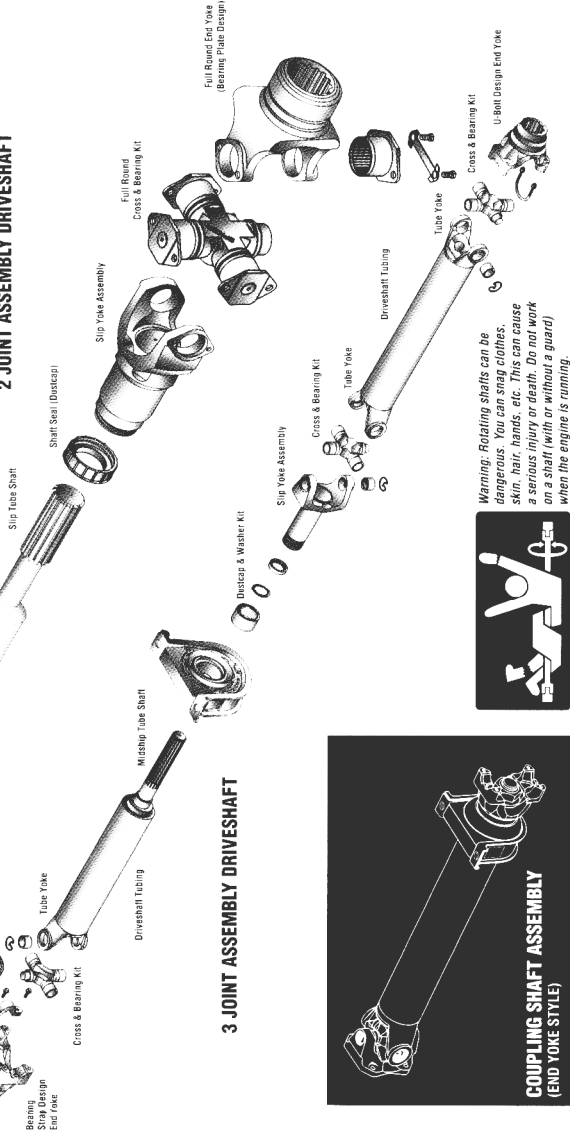

Quick Disconnect™ Half Round End Yoke  
Cross & Bearing Kit

Companion Flange

Flange Yoke

Tube Yoke

Driveshaft Tubing

Midship Tube Shaft

Slip Tube Shaft

Shaft Seal (Dustcap)

Slip Yoke Assembly

Full Round Cross & Bearing Kit

U-Bolt Design End Yoke

Dustcap & Washer Kit

Slip Yoke Assembly

Cross & Bearing Kit

Tube Yoke

Driveshaft Tubing

U-Bolt Design End Yoke

Cross & Bearing Kit

U-Bolt Design End Yoke

U-Bolt Design End Yoke

U-Bolt Design End Yoke

U-Bolt Design End Yoke

U-Bolt Design End Yoke

U-Bolt Design End Yoke

**TUBING (30 or 32)**

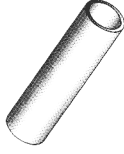

**TUBE SHAFT (40-42)**



**MIDSHIP TUBE SHAFT (53-57)**

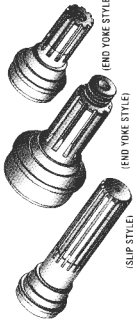

**SERRATED BOLTS w/LOCK PATCH (73)**



**LOCK STRAP (88)**

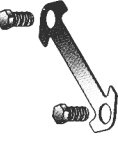

**U-BOLT ASSEMBLY (94)**



**SOCKET YOKE (83)**



**DUST CAP & WASHER KIT (VARIOUS PART NOS.)**



**STRAP OR CAP & BOLT ASSEMBLY (70)**

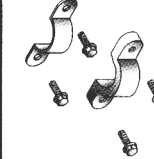

**TUBE YOKE w/TUBE (27)**



**TUBE YOKE (28)**

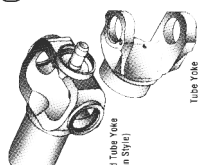

(2 STYLES)

**YOKE SHAFT (82)**

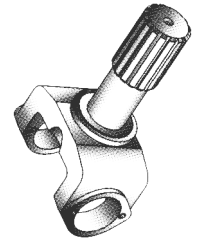

**CENTER YOKE (26)**

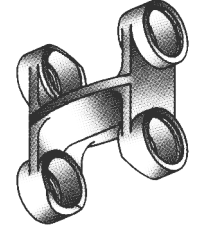

**SHAFT SUPPORT BEARING ASSEMBLY**

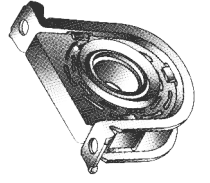

Dana Corporation  
Spicer Universal Joint Division  
P. O. Box 955  
Toledo, Ohio 43697-0955

**SPICER®**



Boletín 3221-Z

**Warning:** Rotating shafts can be dangerous. You can snag clothes, skin, hair, hands, etc. This can cause a serious injury or death. Do not work on a shaft (with or without a guard) when the engine is running.

1994 Dana Corporation - Printed in U.S.A.

# SPICER DRIVELINE COMPONENTS TROUBLESHOOTING GUIDELINES

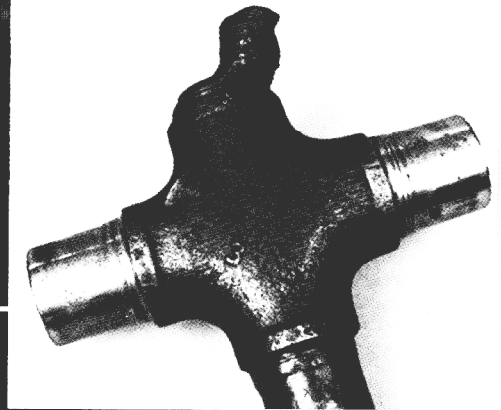
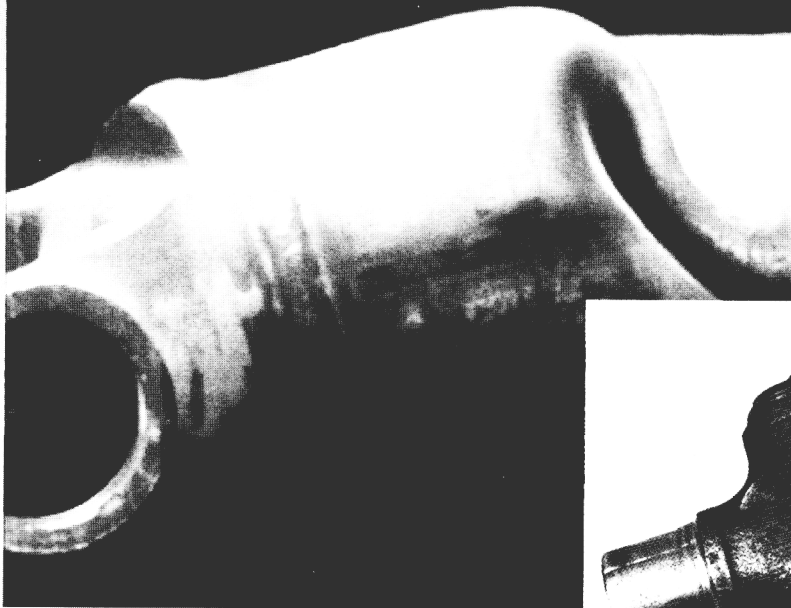

Causes and Solutions  
To Field Problems

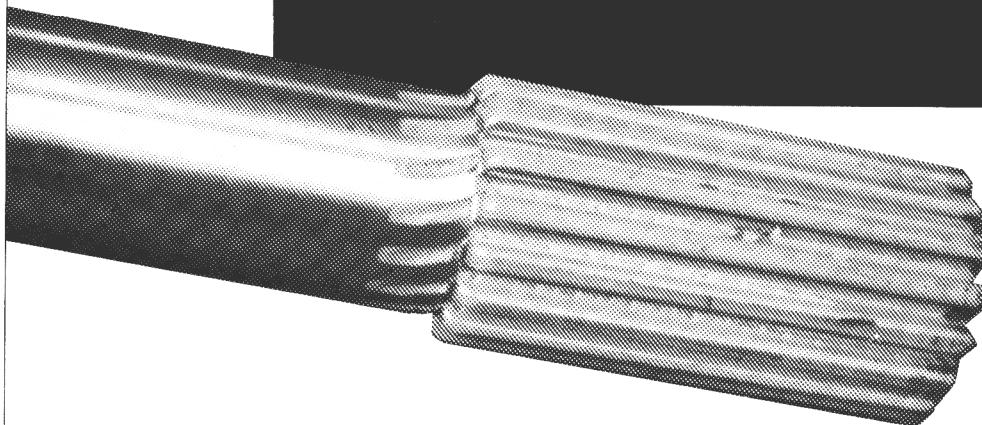

**SPICER®**



# SAFETY PRECAUTIONS

## GENERAL SAFETY INFORMATION

To prevent injury to yourself and/or damage to the equipment:

- Read carefully all owners manuals, service manuals, and/or other instructions.
- Always follow proper procedures and use proper tools and safety equipment.
- Be sure to receive proper training.
- Never work alone while under a vehicle or while repairing or maintaining equipment.
- Always use proper components in applications for which they are approved.
- Be sure to assemble components properly.
- Never use worn-out or damaged components.
- Always block any raised or moving device that may injure a person working on or under a vehicle.
- Never operate the controls of the power take-off or other driven equipment from any position that could result in getting caught in the moving machinery.



## WARNING: ROTATING DRIVESHAFTS

- Rotating auxiliary driveshafts are dangerous. You can snag clothes, skin, hair, hands, etc. This can cause serious injury or death.
- Do not go under the vehicle when the engine is running.
- † Do not work on or near an exposed shaft when engine is running.
- Shut off engine before working on power take-off or driven equipment.
- Exposed rotating driveshafts must be guarded.

## WARNING: GUARDING AUXILIARY DRIVESHAFTS

We strongly recommend that a power take-off and a directly mounted pump be used to eliminate the auxiliary driveshaft whenever possible. If an auxiliary driveshaft is used and remains exposed after installation, it is the responsibility of the vehicle designer and PTO installer to install a guard.

## WARNING: USING SET SCREWS

Auxiliary driveshafts may be installed with either recessed or protruding set screws. If you choose a square head set screw, you should be aware that it will protrude above the hub of the yoke and may be a point where clothes, skin, hair, hands, etc. could be snagged. A socket head set screw, which may not protrude above the hub of the yoke, does not permit the same amount of torquing as does a square head set screw. Also, a square head set screw, if used with a lock wire, will prevent loosening of the screw caused by vibration. Regardless of the choice made with respect to a set screw, an exposed rotating auxiliary driveshaft must be guarded.

# A

THIS SYMBOL WARNS OF POSSIBLE PERSONAL INJURY.



# INTRODUCTION

Universal joint failures, as a rule, are of a progressive nature, which, when they occur, generally accelerate rapidly resulting in a mass of melted trunnions and bearings.

Some recognizable signs of universal joint deterioration are:

- 1 ) Vibrations - Driver should report to maintenance.
- 2) U-joint Looseness - End play across bearings.
- 3) U-joint discoloration due to excessive heat build-up.
- 4) Inability to purge all four trunnion seals when relubing U-joint.

Items 2) thru 4) should be checked at re-lube cycle and if detected, reported to the maintenance supervisor for investigation.

Experience with universal joint failures has shown that a significant majority are related to lubricating film breakdown. This may be

caused by a lack of lubricant, inadequate lube quality for the application, inadequate initial lubrication or failure to lubricate properly and often enough.

Failures which are not the result of lubrication film breakdown are associated with the installation, angles and speeds and manufacturing discrepancies.

Driveshaft failures through torque, fatigue and bending are associated with overload, excessively high U-joint angles and drive shaft lengths excessive for operating speeds.

The trouble shooting chart in this bulletin is intended to provide service people with an aid to enable them to associate complaints with some of the **probable causes** and **probable corrections**. Through normal vehicle maintenance and recognition of discrepancies, this may enable them to make necessary corrections to ward off a serious breakdown.

# DRIVESHAFT TORQUE

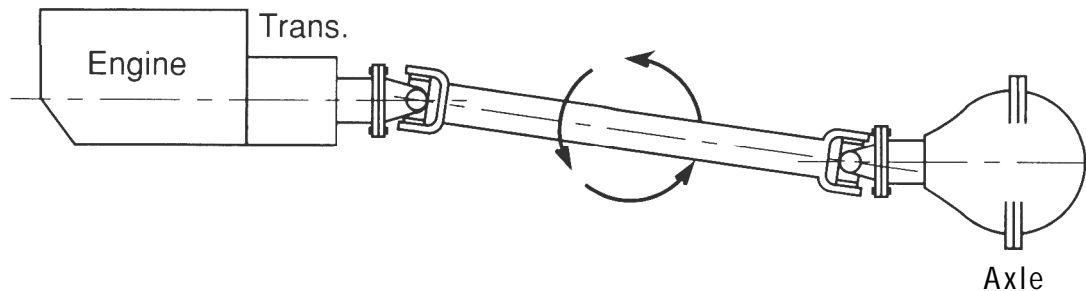

Twisted driveshaft tube?  
Broken yoke shaft?  
Broken journal cross?

Usually a result of torque overload— How much torque can be generated in your application?

**Here is how to figure torque:**

L.G.T. = N.E.T. x Trans L.G.R. x .85 (efficiency factor)

$$D.L.T. \text{ (to Slip Wheels)} = \frac{W_R \times C.O.F. \times R.R.}{12 \times A.R.}$$

A.R. = Axle ratio

C.O.F. = Coefficient of friction (.7)

D.L.T. = Drive line torque

L.G.R. = Low gear ratio

L.G.T. = Low gear torque

N.E.T. = Net engine torque

R.R. = Tire loaded rolling radius

$W_R$  = Weight on drive axle

Relate the lesser of above to Spicer U-joint ratings. If your torque exceeds the Spicer rating for the U-joint used in your application, switch to a size with a rating compatible to your calculation.

# U-JOINT OPERATING ANGLES

U-joint operating angles are a primary source of problems contributing to:

- Vibrations
- Reduced U-joint life
- Problems with other drivetrain components that may include:
  - Transmission gear failures
  - Synchronizer failures
  - Differential problems
  - Premature seal failures in axles, transmissions, pumps or blowers
  - Premature failure of gears, seals and shafts in Power Take-Offs

Every U-joint that operates at an angle will vibrate.

U-joint operating angles are probably the most common causes of driveline vibrations in vehicles that have been re-worked or in vehicles that have had auxiliary equipment installed.

To correct or eliminate these causes of driveline vibrations from your vehicle or new installation, you must determine the TRUE OPERATING ANGLE of each U-joint in your system.

The TRUE OPERATING ANGLE of a U-joint is a combination of the angle that occurs in the top view and the angle that occurs in the side view.

To determine the TRUE OPERATING ANGLE of a U-joint you must follow the instructions outlined in the following sections, numbered I and II, and calculate the TRUE OPERATING ANGLE using the information detailed in Section III.

## I. TO DETERMINE OPERATING ANGLES IN TOP VIEW

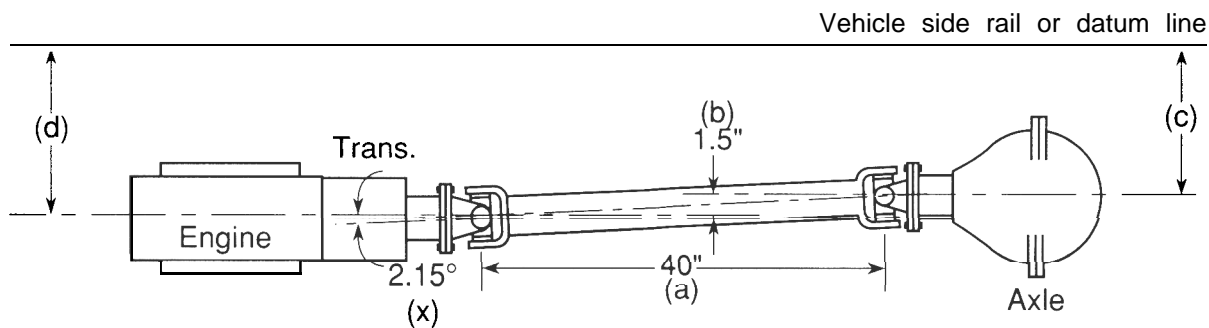

1. From side rail or convenient datum, measure offset dimensions c & d.
2. Calculate dimension  $b = d - c$
3. Measure dimension a
4. Using dimensions a & b, determined through measurement, calculate U-joint angle x by using the chart provided.

Example:

Where  $a = 40.0''$   
 $b = 1.5''$   
 $X = 2.15^\circ$  operating angle

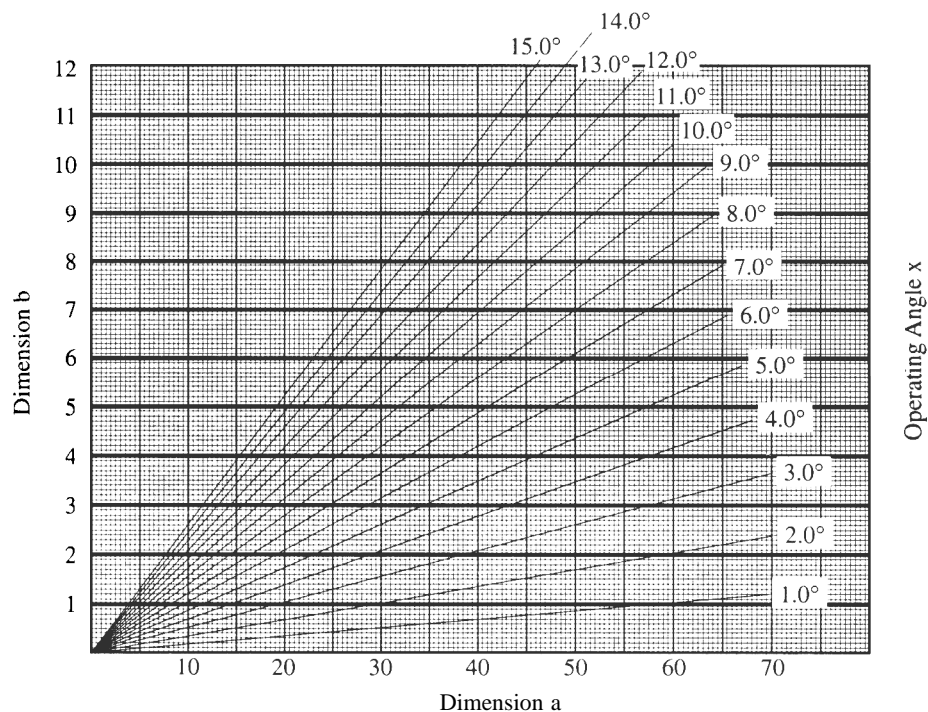

# U-JOINT OPERATING ANGLES

## II. TO DETERMINE OPERATING ANGLES IN SIDE VIEW

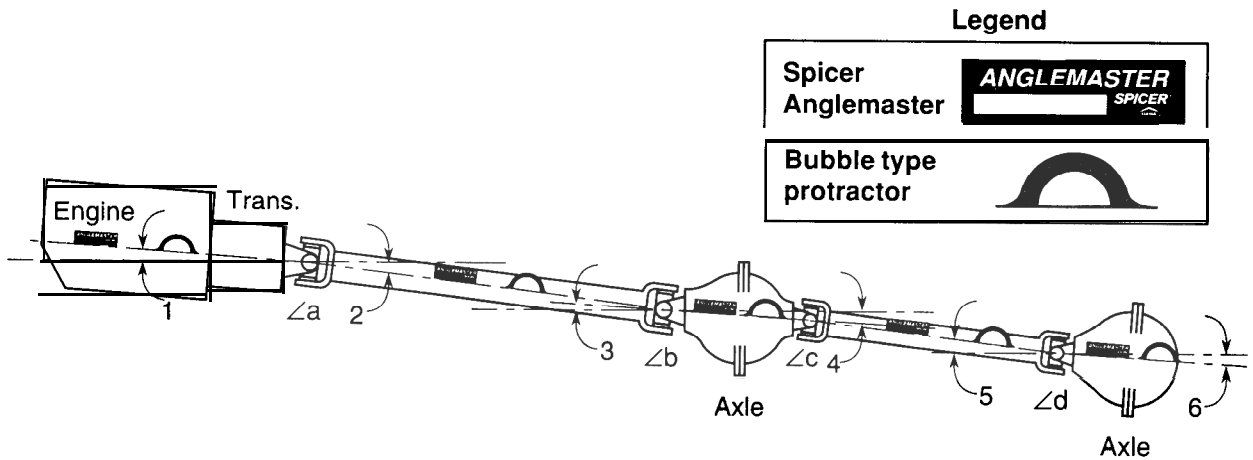

The most convenient way to determine U-joint angles in the side view is through use of a Spicer Anglemaster™ or a bubble type protractor. Procedure is as follows:

Step 1. Using an Anglemaster or a bubble protractor, record inclination angles of drivetrain components. Set Anglemaster or protractor on machined surfaces of engine, transmission, axle or on machined lugs of transmission output and axle input yokes.

Note: U-joint angles can change significantly in a loaded situation. Therefore, check vehicle loaded and unloaded to achieve the accepted angle cancellation. (See Step IV.)

### Example:

Eng-Trans Output	4°30' Down (1)
Main Drive Shaft	7°00' Down (2)
Input 1st Rear Axle	4°00' Up (Input Shaft Nose Up) (3)
Output 1st Rear Axle	4°00' Down (4)
Inter-axle Shaft	7°00' Down (5)
Input 2nd Rear Axle	4°15' Up (Pinion Shaft Nose Up) (6)

Note: If inclination of driveshaft is opposite connecting component, add angles to obtain the U-joint operating angle.

$$\angle a = (2) - (1) = 7^{\circ}00' - 4^{\circ}30' = 2^{\circ}30' (2.50^{\circ})$$

$$\angle b = (2) - (3) = 7^{\circ}00' - 4^{\circ}00' = 3^{\circ}00' (3.00^{\circ})$$

$$\angle c = (5) - (4) = 7^{\circ}00' - 4^{\circ}00' = 3^{\circ}00' (3.00^{\circ})$$

$$\angle d = (5) - (6) = 7^{\circ}00' - 4^{\circ}15' = 2^{\circ}45' (2.75^{\circ})$$

## III. CALCULATING THE TRUE U-JOINT OPERATING ANGLE

The true U-joint operating angle is the sum of the U-joint angles in both the top view and the side view. The true U-joint operating angle is calculated in the following manner:

True operating angle =  $\sqrt{x^{\circ 2} + a^{\circ 2}}$   
Where  $x = 2.15^{\circ}$  as determined by use of chart in Section I.

$a = 2.5^{\circ}$  as determined in Section II.

$$\text{True operating angle} = \sqrt{2.15^2 + 2.5^2} = 3.297^{\circ} \text{ or } 3^{\circ}18'$$

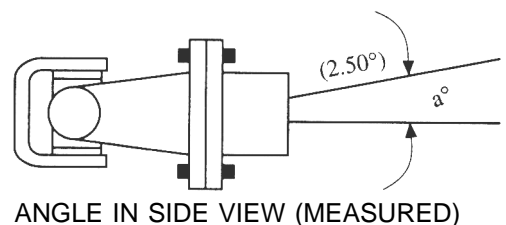
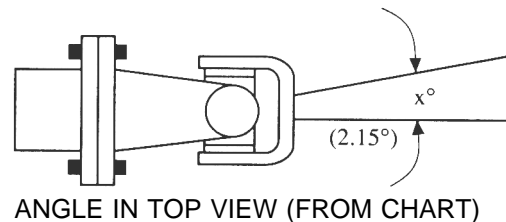

## IV. U-JOINT ANGLE CANCELLATION

After calculating the TRUE OPERATING ANGLE of each U-joint in your driveline:

- Make sure the inboard yoke ears of each driveshaft are in line within each other.
- Compare the TRUE OPERATING ANGLE of each U-joint on each end of each shaft. They must be within one degree of each other or they will be a potential source of vibration.

If adjustments must be made to the system:

- Install shims between the axle housing and springs to rotate the axle input yoke to change operating angles.
- Change operating angle on torque arm type suspensions by lengthening or shortening torque arms.
- Raise, lower, or shift side to side a pump, blower or other piece of auxiliary equipment to change operating angles.

**IMPORTANT TO REMEMBER:** Keep the centerlines of two components that are connected by a driveshaft parallel in both the top and side views, so the operating angles will ALWAYS be equal.

## V. MAXIMUM TRUE OPERATING ANGLES\*

### For Two Joint Shafts with Equal or Intersecting Angles

When you settle on a true operating angle that is correct, make sure it doesn't exceed the angles shown in this chart for the driveshaft RPM.

R.P.M. is the main factor in determining maximum allowable operating angles. As a guide to maximum normal operating angles, refer to the chart below.

Driveshaft RPM	Max. Normal Operating Angles	Driveshaft RPM	Max. Normal Operating Angles
5000	3.2°	3000	5.8°
4500	3.7°	2500	7.0°
4000	4.2°	2000	8.7°
3500	5.0°	1500	11.5°

\*Based on application experience (1000 rad/sec acceleration).

# THE FUNCTION OF A DRIVESHAFT

The basic function of a driveshaft is to transmit power from one point to another in a smooth and continuous action. In automobiles, trucks and construction equipment, the drivetrain is designed to send torque through an angle from the transmission to the axle (or auxiliary transmission).

The driveshaft must operate through constantly changing relative angles between the transmission and axle. It must also be capable of changing length while transmitting torque. The axle of a vehicle is not attached directly to the frame, but rides suspended by springs in an irregular, floating motion.

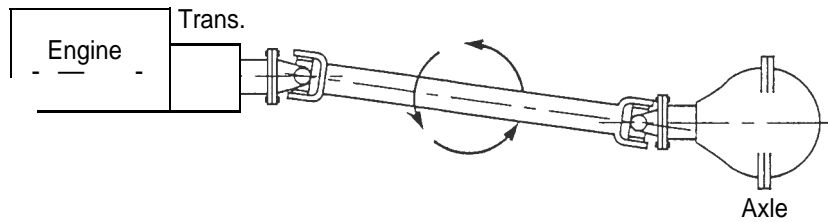

*The geometry of a driveshaft in side view – vertical offset*

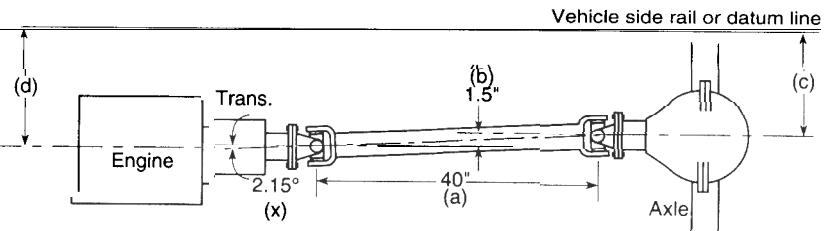

*The geometry of a driveshaft in p/an view – horizontal/ offset*

## CONSTRUCTION OF A DRIVESHAFT (ALL TYPES)

To transmit required torque loads, the driveshaft must be durable and strong. Forged steel and high strength cast yokes, including the Spicer Quick Disconnect™ end yoke for heavy duty vehicles, are used to provide the necessary rigidity required to maintain bearing alignment under torque loads. Spicer heavy-duty u-joint kits and Low Effort™ light-duty u-joint kits are designed to give extended driveshaft life.

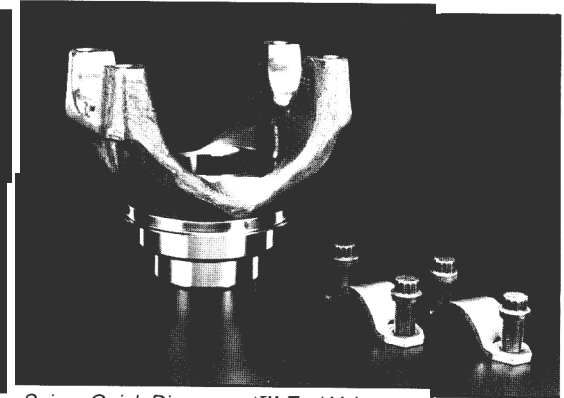

*Spicer Quick Disconnect™ End Yoke*

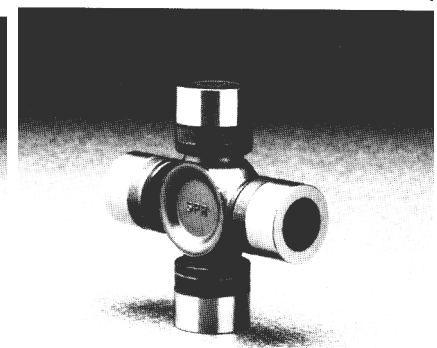

*Spicer Low Effort™ U-Joint Kit*

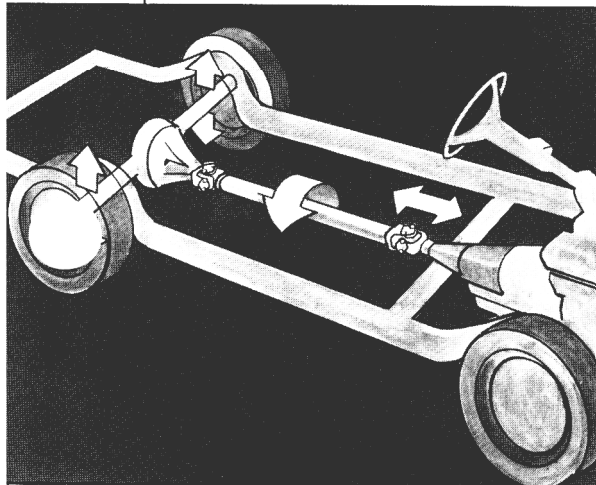

This means the driveshaft must be able to contract, expand and change operating angles when going over bumps or depressions. This is accomplished through universal joints, which permit the driveshaft to operate at different angles, and slip joints, which permit contraction or expansion to take place.

# DRIVESHAFT PARTS LISTING

Quick Disconnect™ Half Round End Yoke  
(Bearing Strap Design)

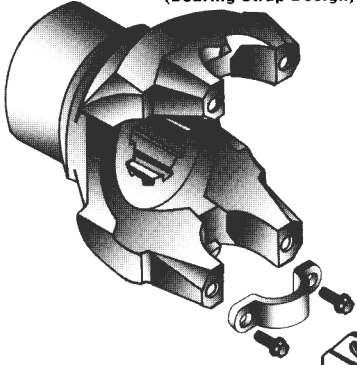

Quick Disconnect™ Half Round  
Cross & Bearing Kit

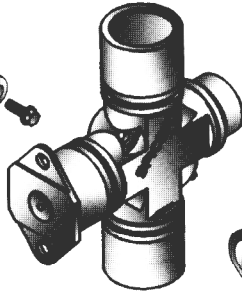

Tube Yoke

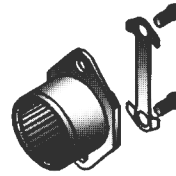

Driveshaft Tubing

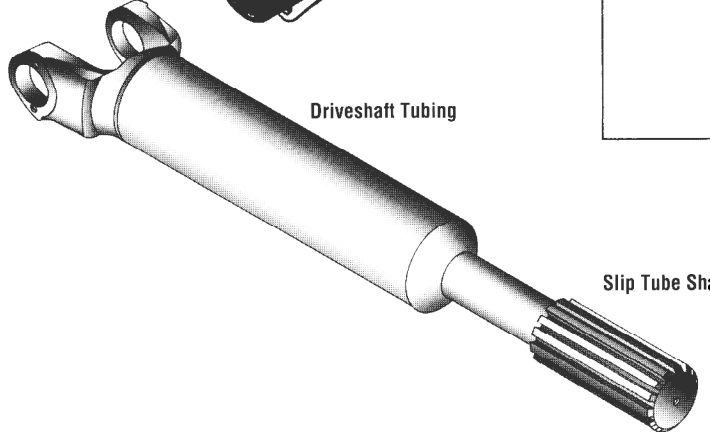

Slip Tube Shaft

Companion Flange

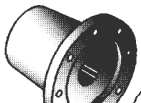

Flange Yoke

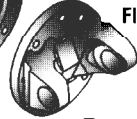

Bearing  
Strap Design  
End Yoke

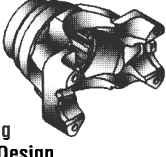

Cross & Bearing Kit



Tube Yoke



Driveshaft Tubing

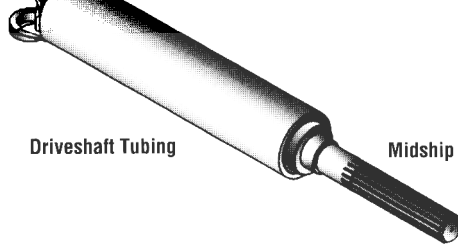

Midship Tube Shaft

## 3 JOINT ASSEMBLY DRIVESHAFT

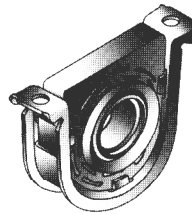

Slip Yoke Assembly

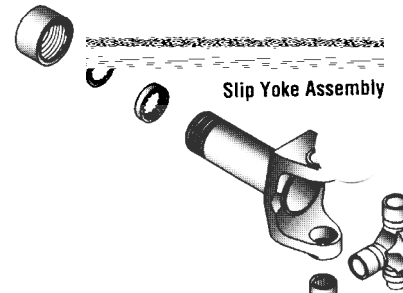

Cross & Bearing Kit

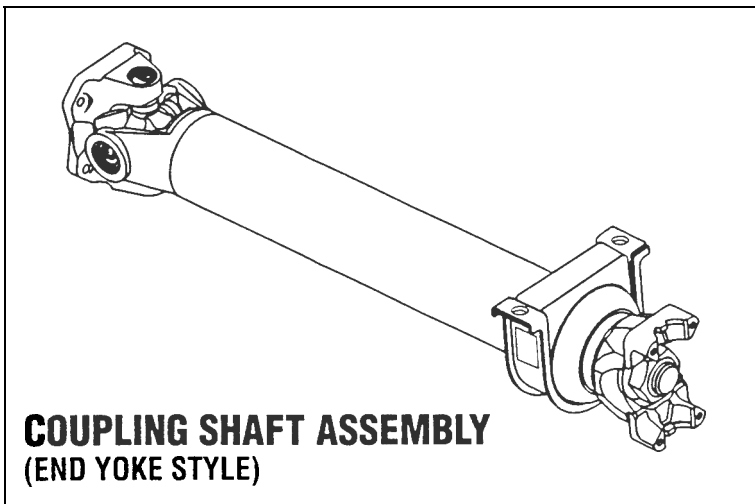

COUPLING SHAFT ASSEMBLY  
(END YOKE STYLE)

**COUPLING SHAFT ASSEMBLY  
(SLIP YOKE STYLE)**

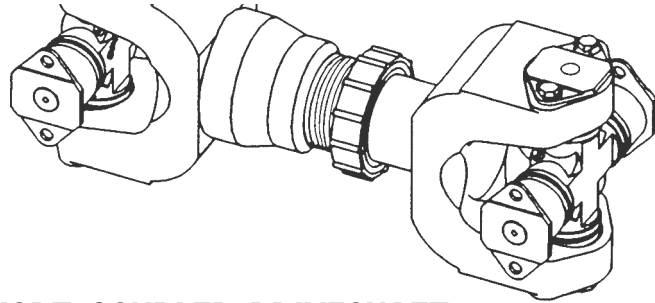
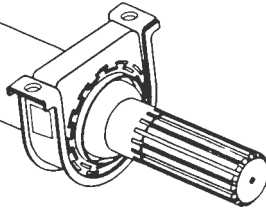

**SHORT COUPLED DRIVESHAFT**

**2 JOINT ASSEMBLY DRIVESHAFT**



*Warning: Rotating shafts can be dangerous. You can snag clothes, skin, hair, hands, etc. This can cause a serious injury or death. Do not work on a shaft (with or without a guard) when the engine is running.*

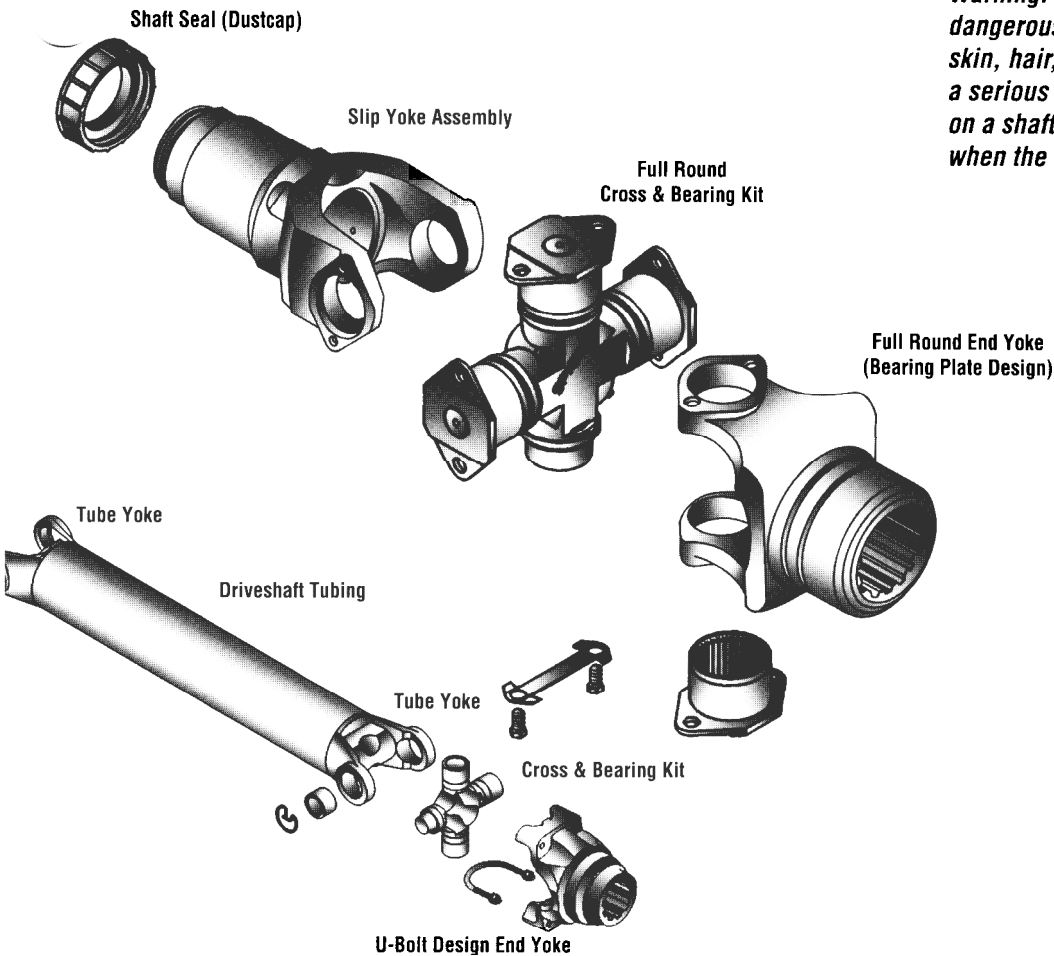

# CONSTRUCTION OF A DRIVESHAFT

Anti-friction bearings are used to withstand required oscillating loads while the driveshaft is rotating at high speeds. The needle roller bearings on the trunnions of the cross carry large loads and are used because of their high capacity in a limited space.

composite (aluminum wrapped in graphite) driveshafts have been developed to meet the vehicular industry needs.

## INSPECTING AND LUBRICATING THE DRIVESHAFT (All Types)



**WARNING:** Rotating shafts can be dangerous. You can snag clothes, skin, hair, hands, etc. This can cause serious injury or death. Do not work on a shaft (with or without a guard) when the engine is running.

## INSPECTION

To keep a vehicle operating smoothly and economically the driveshaft must be carefully inspected at regular intervals. Vibrations and u-joint and shaft support (center) bearing problems are caused by such things as loose end yokes, excessive radial (side to side or up and down) looseness, slip spline radial looseness, bent shaft tubing, or missing plugs in the slip yoke.

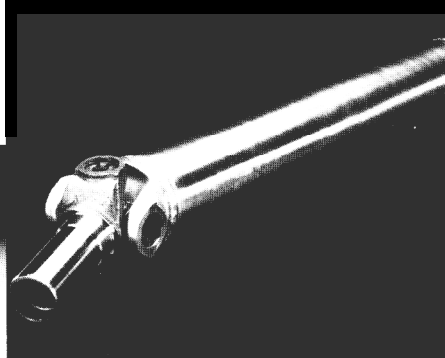

*Spicer Lite™ Aluminum Driveshaft*

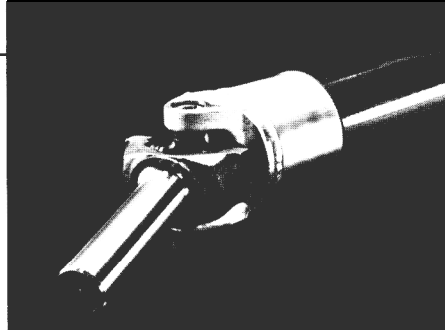

*Spicer Graph Life™ Driveshaft*

The sliding splines between slip joint and permanent joint must support the driveshaft and be capable of sliding under full torque loads. To aid in this axial or slip movement, Spicer Glidecote™ was developed to reduce sliding friction thereby reducing thrust loads under high torque. This non-metallic coating also prevents spline galling and extends spline life.

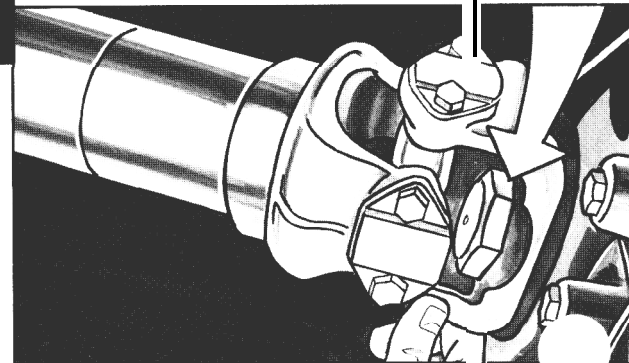

1. Check the output and input end yokes on both the transmission and axle, or axles, for looseness. If loose, disconnect the driveshaft and retorque the end yoke retaining nut to specification. If yoke replacement is required, check for manufacturer's recommendation regarding replacement frequency of the end yoke retaining nut.

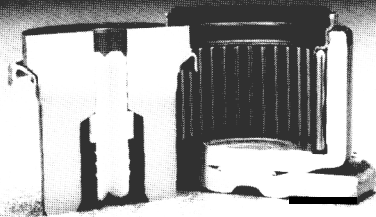

*Spicer Positive Purging valve and exclusive crowned bearing race inside diameter.*

Spicer's exclusive bearing assembly inside diameter crowning and tapered thrust pads distribute loads more evenly on needle roller bearings and cross trunnion ends to significantly reduce end galling. Bearing assemblies are individually sealed to provide retention of lubricants and prevent the entry of foreign material. If lubricants become contaminated with water or abrasive matter, needle roller bearing life is seriously affected.

Abrasive material is a major problem when a vehicle operates under conditions of extreme moisture and dirt. To combat this problem, synthetic rubber seals were developed and resulted in increased life, ability to withstand high temperature and a less critical relubrication cycle for driveshafts.

Special high-strength tubing is used to provide maximum torque carrying capacity at minimum practical weight. In addition to steel tubing in use for many years now, Spicer Lite™ aluminum and Graph-Lite™



# INSPECTING AND LUBRICATING THE DRIVESHAFT (ALL TYPES)

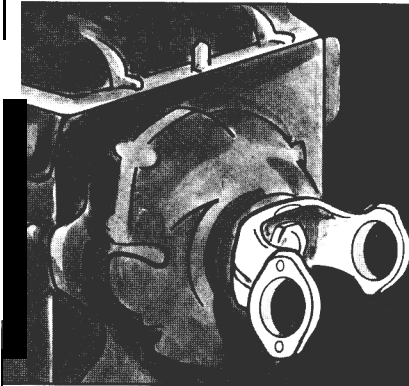

2. If the end yokes are tight, check for excessive radial looseness of the transmission output shaft and axle input and output shafts in their respective bearings. Consult transmission and axle manufacturer's specifications for acceptable radial looseness limits and method of checking.

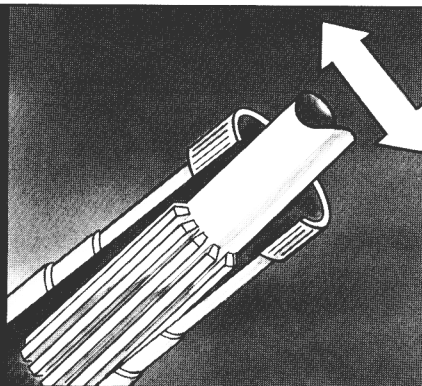

4. Check the slip spline for excessive radial movement. Radial looseness between the slip yoke and the tube shaft should not exceed .007 inches.

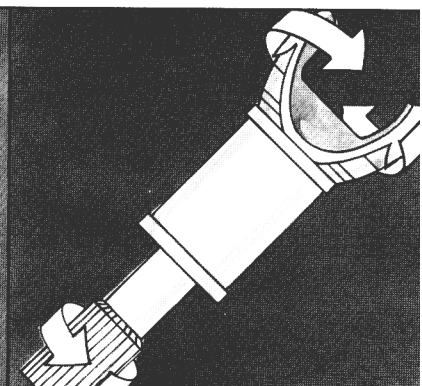

6. If runout readings are required, they should be taken with the driveshaft mounted in the vehicle, with the transmission in neutral and the axle shafts pulled, or by jacking rear wheels off the ground and placing axles on jack stands. This will allow rotating the driveshaft by hand to check indicator readings. The runout readings taken at the various locations should not exceed an additional 0.010 T.I.R. over the manufacturer's specified runout. (See page 24)

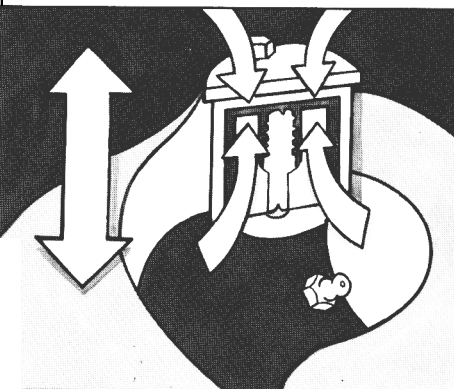

3. Check for excessive looseness across the ends of the bearing assemblies and trunnions. This looseness should not exceed .006 inches maximum.

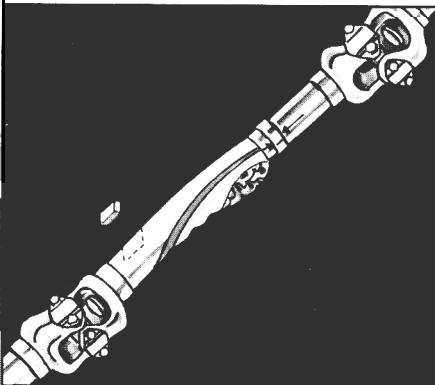

5. Check the shaft for damaged, bent tubing or missing balance weights. Make certain there is no build up of foreign material on the shaft, such as undercoat or concrete. If found, they should be removed carefully to avoid damage to the driveshaft.

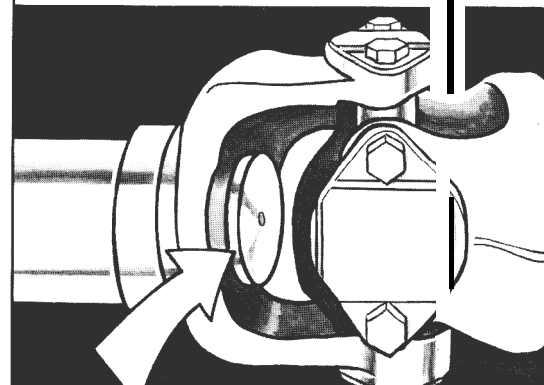

7. For an inboard and outboard slip yoke assembly design, check to be sure the plug is not loose or missing . . . if it is, repair or replace it. Loose or missing plugs are commonly caused by not enough driveshaft slip capability.

# INSPECTING AND LUBRICATING

## LUBRICATION

Among the most common causes of joint and slip problems is lack of proper lubrication. Properly sized Spicer U-joints that are adequately relubricated at recommended intervals will normally meet or exceed vehicle operation requirements. Relubrication flushes the joints thus removing abrasive contaminants from the bearings.

## LUBRICANTS FOR UNIVERSAL JOINTS

For a standard application, use a good quality E.P. (extreme pressure) grease (Timkin Test Load 45 lbs. min) meeting \*N.L.G.I. Grade 2 specifications.

Grease must have an operating range of +325°F/+163°C to -10°F/-23°C and be compatible with commonly used multi-purpose greases such as Lithium Soap Types.

For driveshaft applications involving shaft speeds below 500 RPM, a mineral oil in the SAE 140 to 250 viscosity range should be used.

Consult your local lubricant source for greases that meet these specifications.

## N.L.G.I. \*E.P. Grade 2 Lubricating Grease

\* National Lubricating Grease Institute

## INITIAL LUBRICATION AND RELUBE CYCLES

Spicer replacement universal joint kits contain only enough grease to provide needle roller bearing protection during storage. It is therefore necessary to completely lubricate each replacement kit prior to assembly into the yokes. Each cross lube reservoir should be fully packed with a recommended grease and each bearing assembly should also be wiped with the same grease, filling all the cavities between the needle rollers and applying a liberal grease coating on the bottom of each bearing assembly. Too much grease may cause hydraulic "lock-up", making installation difficult. After the kits are installed into the yokes and prior to placing into service, they should be relubed, through the lube fitting, using the same grease.



Relubrication cycles vary depending on the service requirements and operating conditions of the vehicle. A recommended relube cycle for various types of service is shown below.

*NOTE: On-highway is defined as all applications requiring less than 10% of operating time on gravel, dirt or unimproved roads. If longer than 10% operating time off-highway use off-high way recommendations.*

TYPE OF SERVICE	MILES	or	TIME
CITY	5000/8000		3 MONTHS
ON HIGHWAY (MID-RANGE)	10,000/15,000		3 MONTHS
ON HIGHWAY (LINE-HAUL)	10,000/15,000		30 DAYS
ON/OFF HIGHWAY	5,000/8,000		3 MONTHS
OFF HIGHWAY/ INDUSTRIAL			500/200 HRS.*

\*Relubrication cycles for off highway and industrial use vary depending on the application and operating conditions. In general, to obtain maximum life, relubrication should occur every 500 hours for normal service and every 200 hours for continuous service or severe environmental conditions.

## LUBRICATION PROCEDURE FOR U-JOINTS

(Except Constant Velocity Type Joints)



**WARNING:** Rotating shafts can be dangerous. You can snag clothes, skin, hair, hands, etc. This can cause serious injury or death.

Do not work on a shaft (with or without a guard) when the engine is running.

Do not go under the vehicle when the engine is running.

In order to avoid becoming entangled install power take-off and/or shaft behind the frame rail, tanks, battery box, etc.

If power take-off and/or shaft are still exposed after installation, install a guard.

# INSPECTING AND LUBRICATING

1. Use the proper lubricant to purge all four seals of each u-joint. This flushes abrasive contaminants from each bearing assembly and assures all four are filled. Pop the seals. Spicer seals are made to be popped.
2. On center twin zerk design or single zerk kits, if any of the seals fail to purge, move the driveshaft from side to side and then apply gun pressure. This allows greater clearance on the thrust end of the bearing assembly that is not purging. On two-zerk kits, try greasing from the opposite lube fitting. For light-duty kits, check for a fully seated snap ring or burrs on the snap ring or burrs on the snap ring or groove.
3. Because of the superior sealing capability of the Spicer Seal design on the 1610, 1710, 1760, 1810 and 1880 Series, there will occasionally be one or more bearing assembly seals that will not purge.

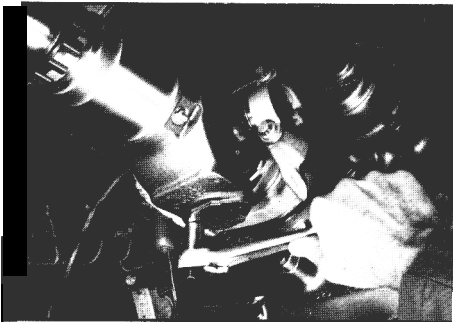

Release seal tension by loosening the bolts holding the bearing assembly that doesn't purge. It may be necessary to loosen the bearing assembly approximately 1/16 inch minimum. If loosening it does not cause purging, remove the bearing assembly to determine cause of blockage.

4. Install new bolts and torque to specifications.

**CAUTION:** Retaining bolts should not be reused. If loosening or removal of bolts is necessary, install new bolts and torque to specification.

## LUBRICATION FOR SLIP SPLINES

The lubricant used for u-joints is satisfactory for slip splines. Glidecote™ and steel splines both use a good E.P. grease meeting N. L.G. I. Grade 2 specifications.

Relube splines at the intervals recommended in the chart for u-joints.

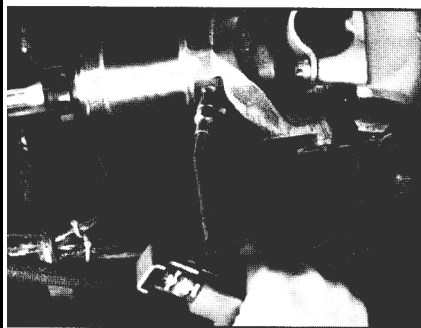

1. Apply grease gun pressure to the lube fitting until lubricant appears at the pressure relief hole in the plug at the slip yoke end of the spline.

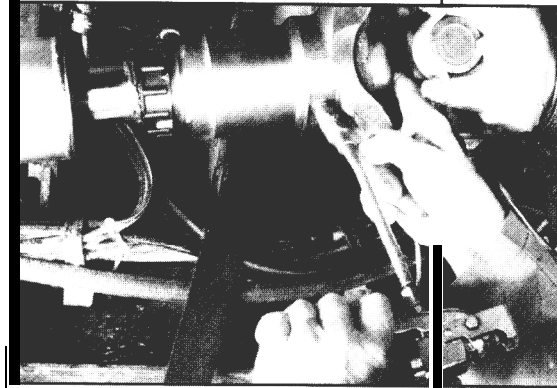

2. Now cover the pressure relief hole with your finger and continue to apply pressure until grease appears at the slip yoke seal.

**CAUTION:** In cold temperatures be sure to drive the vehicle immediately after lubricating. This activates the slip spline and removes the excessive lubricant. Failure to do so could cause the excess lubricant to stiffen in the cold weather and force the plug out. The end of the spline would then be open to collect contaminants and cause the spline to wear and/or seize.

## SHAFT SUPPORT BEARING ASSEMBLIES

Bearing manufacturers do the initial lubrication and all Spicer shaft support (center) bearings are lubed for life. When replacing a shaft support bearing assembly, be sure to fill the entire cavity around the bearing with waterproof grease to shield the bearing from water and contaminants. Enough grease must be put in to fill the cavity to the extreme edge of the slinger surrounding the bearing. Lubricants must be waterproof. The following chart lists recommended waterproof lubricants for use with center bearings.

# SERVICING THE DRIVESHAFT

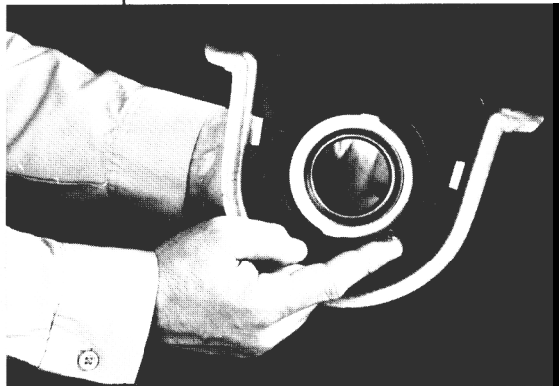

**NOTE:** There are numerous instances when special lubrication is required by vehicle specification or customer request. The lubrication recommendations listed in this manual are what Spicer U-Joint engineers suggest. Any alternate lubricants, or lubrication procedures, are the responsibility of the user.

## Recommended Lubricants - Source

- Rykon Premium No. 3
  - Amoco Oil Company
- Sun C-34 Grease (Cup No. 4)
  - Sun Oil Company
- Amolith 8516
  - Amoco Oil Company
- Van Talgar No. 4
  - Exxon Company

## Special Tools:

- Torque wrench (125 lb./ft.)
- Journal locator
- U-joint press
- V-block
- Alignment bar/No Go wear gauge
- Common hand tools

One of the following is recommended:  
 Owatonna tool kit (#7057)  
 (Two-jaw puller)  
 Tiger tool kit  
 JJAG tool kit  
 J & J tool kit

\*Available only from Dana Corporation Spicer Service Representatives.

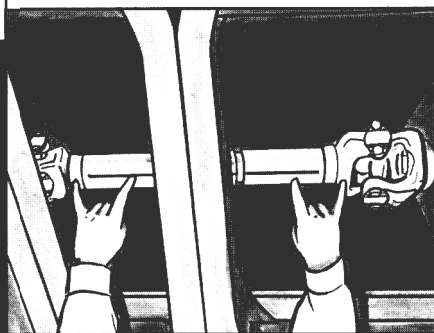
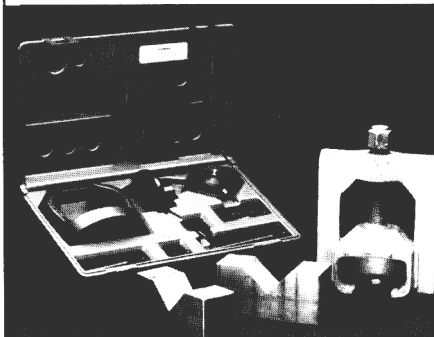

**NOTE:** Before removal of the driveshaft set the brakes, block the wheels, and mark the slip yoke assembly and tube shaft with a marking stick or paint to assure proper alignment when reassembled. This is known as keeping the driveshaft yokes "In Phase."

**CAUTION:** Never heat components or use sledge hammers and floor jacks to disassemble driveshafts. This can result in damaged, weakened or bent components.



**WARNING:** Rotating shafts can be dangerous. You can snag clothes, skin, hair, hands, etc. This can cause serious injury or death. Do not work on a shaft (with or without a guard) when the engine is running.

## REMOVAL

### (Full Round End Yoke Style)

1. The method of driveshaft removal should be one that assures safety and ease of removal to the mechanic without damage to the driveshaft, transmission or axle components. Suggested method is use of a u-joint puller:  
 Owatonna tool kit #7057, Tiger tool kit, JJAG tool kit, or J&J tool kit.



2. Bend tabs of lock straps away from bolt heads with a chisel.

**NOTE:** The self-locking bolt design for full-round end yokes uses serrated bolts with lock patch and DOES NOT require a lock strap.

## SERVICING THE DRIVESHAFT\*

### Heavy Duty Application

Cross and Bearing Kit Replacement  
 Bearing Plate Design

Full Round and Quick Disconnect End Yoke Designs

# SERVICING THE DRIVESHAFT

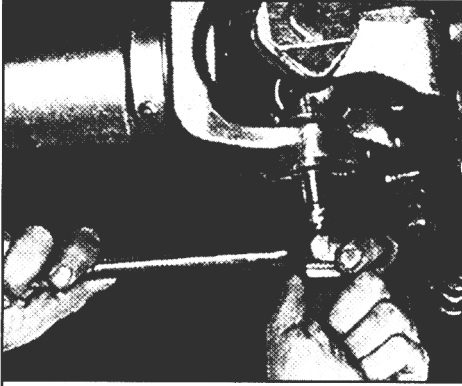

3. Remove bolts (four) from each bearing assembly connected to the transmission and axle end yoke.

**CAUTION:** If a u-joint kit is to be reused, care should be taken not to nick trunnions or damage slingers.

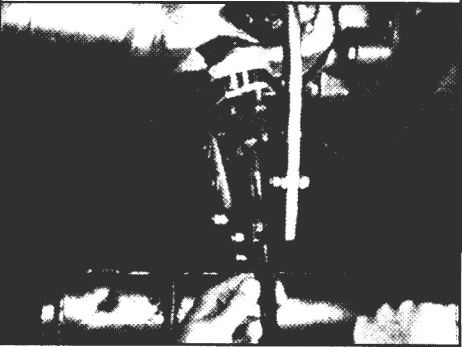

4. Remove bearing assemblies from the yoke cross holes using a u-joint removal tool kit.

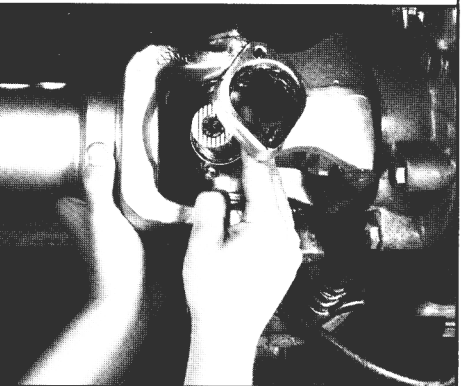

5. Free the trunnion from the end yoke by tilting the trunnion and collapsing the driveshaft.

**NOTE:** If only one end of the driveshaft requires service, disconnect that end, unscrew the slip shaft seal (dustcap) from the slip yoke assembly and then pull apart or slide off the assembly. When removing the entire driveshaft, disassemble one end at a time, laying the disconnected end on the floor carefully. When reassembling, **BE SURE** that the marks on the shaft and slip joint are in line to keep the driveshaft yokes in phase.

## REMOVAL (Quick Disconnect™ Half Round End Yoke Style)

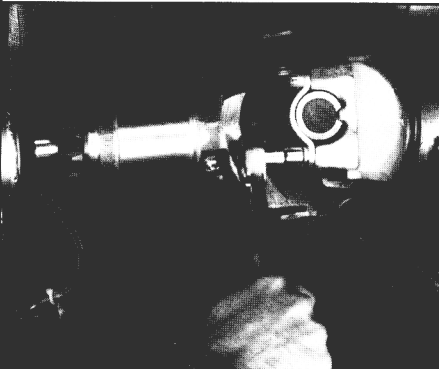

For half round end yoke disassembly install a nylon support strap, remove the bearing strap retaining bolts, one end at a time, and release the driveshaft.

## REMOVAL (Flange Yoke Style)

1. Install nylon support strap. Loosen and remove nuts and bolts securing flange yoke to transmission or axle companion flange.
2. Holding driveshaft firmly, tap loose and compress from one end and lower to floor.
3. Repeat at other end.

## DISASSEMBLY (Full Round Style)

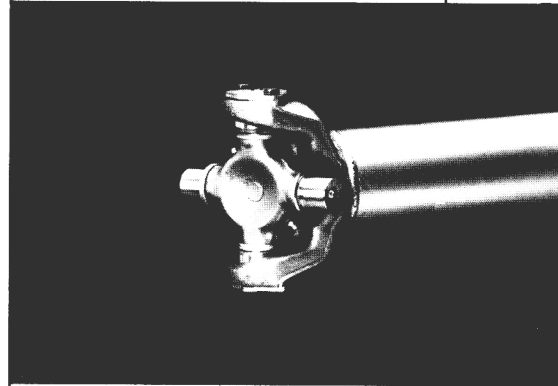

1. Place the driveshaft in v-blocks to remove the cross and bearing assemblies.

**CAUTION:** Do not distort the tube with excessive grip.

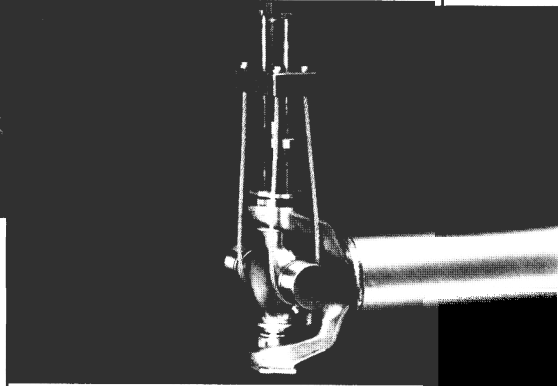

2. Completely remove the cross and bearings from both ends of the driveshaft by disassembling the bearing assemblies from the slip yoke and the tube yoke (and flange yoke where applicable) using a tool kit.

# SERVICING THE DRIVESHAFT

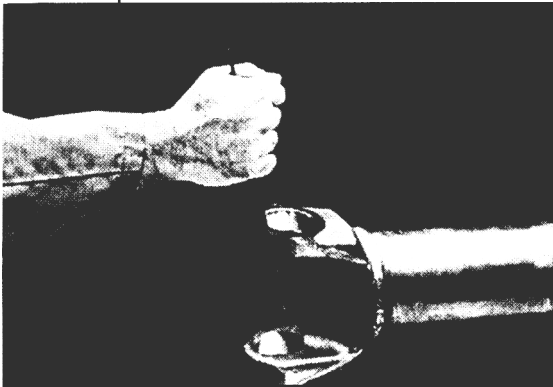

If after proper cleaning of the cross holes the alignment bar will not pass through simultaneously, the yoke lugs are distorted and the yoke or yokes should be replaced.

**CAUTION:** Use a journal locator to avoid nicking journal cross trunnions or damaging oil seal slingers.

## DISASSEMBLY

### (Quick Disconnect™ Half Round End Yoke Style)

1. Place the driveshaft in v-blocks to remove the cross and bearing assemblies.
2. Completely remove the cross and bearings from both ends of the driveshaft by removing the bolts and bearing straps.
3. Remove the end yoke from the driveshaft and place in a soft jawed vise to inspect the crosshole surfaces. Raised metal can be removed with a rat tail or half round file. Emery cloth should be used to remove all rust and corrosion from crosshole bores.
4. Check the yoke for crosshole alignment using the Spicer Alignment gauge. Place the correct bushing in each lug ear allowing a .03 to .06 clearance between the tang and the bushing.

3. After removing the cross and bearings, both ends, inspect the cross hole surfaces for damage or raised metal. Raised metal can be removed with a rat tail or half round file and emery cloth. Check the yoke lug crossholes with a No-Go Wear Gauge and then use a Spicer Alignment Bar to inspect for damage by sliding through both cross holes simultaneously. The alignment bar will identify yoke lugs that have taken a set because of excessive torque. The raised metal or distorted lugs can be a cause of premature cross and bearing problems.

At this time, clean the cross holes of the yokes on the transmission and axle and inspect with an alignment bar gauge as described above.



Assemble bearing straps and bolts, tightening bolts a minimum of 30 ft. lbs. Insert the alignment gauge into one crosshole. If the gauge enters and passes through the opposite crosshole, alignment is correct. If the alignment gauge will not enter the opposite crosshole, reinspect for burrs.

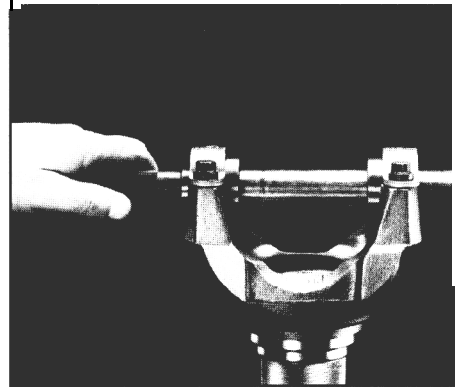

If, after proper cleaning, the alignment gauge still does not pass through both crossholes, the yoke lugs are distorted and the yoke should be replaced.

## REASSEMBLY

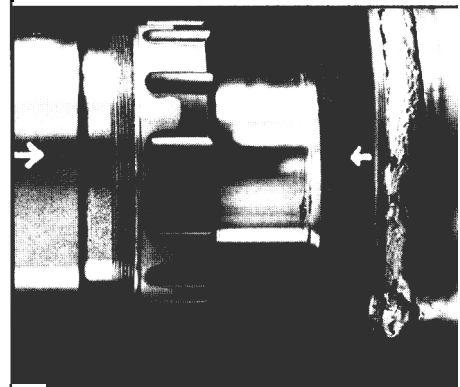

1. Place each end of the driveshaft, less cross and bearing kits, on v-blocks. Check the paint marking placed on the tube and slip yoke assembly prior to removing from the vehicle to be sure they are lined up or "in phase."

# SERVICING THE DRIVESHAFT

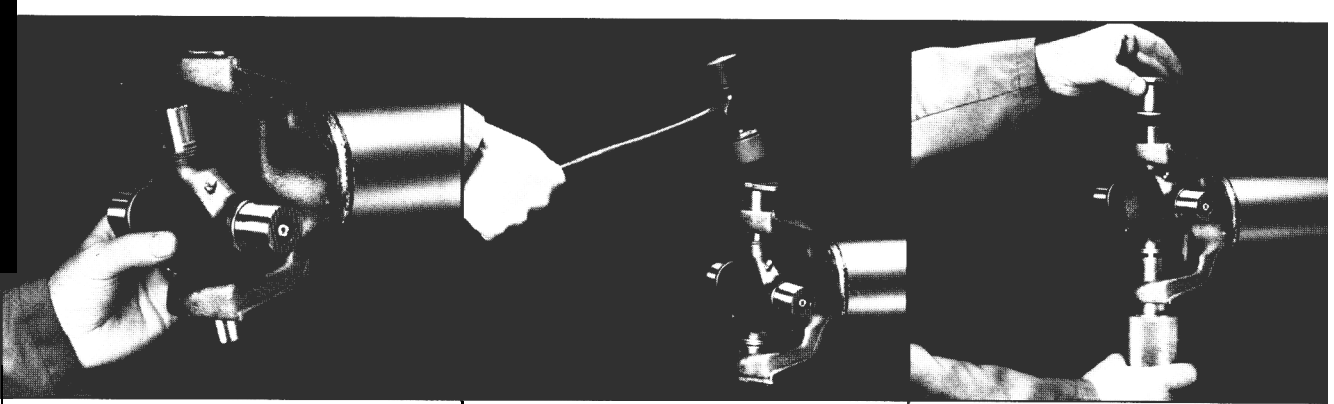

2. Remove the cross and bearings from the box and remove all four bearing assemblies.

Rotate the cross to inspect for presence of the positive purging valve in each lube hole of all four trunnions. Then position the cross into the end yoke with its lube fitting in line as near as possible with the slip spline lube fitting. Keep the lube fitting on the inboard side.

yoke lug. Place a bearing assembly over the trunnion diameter and align it to the cross hole.

Holding the trunnion in alignment with the cross hole, using the journal locator, press bearing assembly flush to face of end yoke by hand.

A journal locator should be used to prevent damage to the u-joint trunnions and slingers. If the u-joint bearing cap is pressed into place, the bearings and bearing surfaces could be damaged.

If bearing assembly binds in cross hole, tap with soft hammer directly in center of bearing assembly plate. Do not tap outer edges of bearing plate.

Exact fit of all driveline components is extremely important. The correct parts and clean mating surfaces are essential for safe operation and good repair.

5. When the bearing assembly is completely seated, put the lock plate tab in place and use the "Grade Eight" cap screws that are furnished with the kit and insert them through the cap screw holes in both

the lock strap and bearing assembly. Thread with hand or wrench into tapped holes in yoke. Do not torque down bolts.

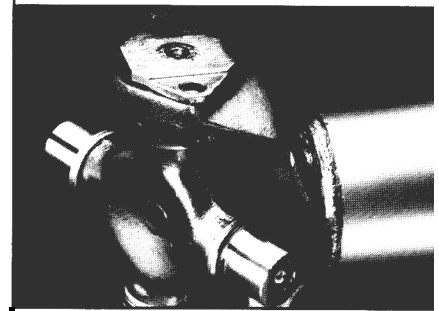

**NOTE:** The self-locking bolt design for full-round yokes uses serrated bolts with lock patch and DOES NOT require a lock strap. DO NOT reuse ANY retaining bolt. If loosening or removal of a bolt is necessary, replace with a new one.

6. Move the cross laterally to the opposite side and through the cross hole beyond the machined surface of the yoke lug. Place a bearing assembly over the cross trunnion and slide it into the cross hole, seating the plate to the face of the lug. Put the lock plate tab in place and thread the bolts with hand or wrench into tapped holes in yoke.

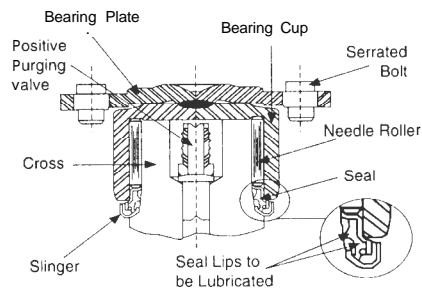

3. The lips of the seal on the u-joint **must** be lubricated with a light weight oil to prevent the seal from turning inside out upon installation. Also, each cross reservoir must be packed with grease and **each** cap bearing wiped with grease prior to assembly.

4. Move one end of the cross to cause a trunnion to project through the cross hole beyond the outer machined face of the

# SERVICING THE DRIVESHAFT

*NOTE: Projecting the trunnion through a cross hole beyond the machined surface of the lug will provide a surface to help align the bearing assembly with the cross hole. This method should also be followed when assembling driveshaft to yokes of vehicle at transmission and axle or axles.*

7. Repeat process of installation of cross and bearing kit at opposite end of the driveshaft. Make sure to position the cross in the yoke so that the lube fitting is in line with the lube fitting at the other end.
8. For flange yoke applications, install the flange yoke, bearing assemblies and bolts at this time.

*CAUTION: Worn bearing assemblies used with a new cross or new bearing assemblies used with a worn cross will wear rapidly making another replacement necessary in a short time.*

*Always Replace the Cross, Four Bearing Assemblies and Bolts as a Unit.*

## INSTALLATION IN VEHICLE

The installation of a driveshaft does not present any unusual mechanical difficulties. Before actual installation the driveshaft should be checked for the following items:

- ✓ Damage or dents on the driveshaft tubing.
- ✓ Splines should slide freely with slight drag from slip shaft seal.
- ✓ Cross should flex and be free from excessive bind. A slight drag is the most desirable condition on a new cross and bearing kit. Excessive looseness is not desirable and will

result in an unbalanced driveshaft.

- ✓ Mounting flanges and pilots should be free from burrs, paint and foreign substances which would not allow proper seating at assembly.

When servicing system balanced assemblies it is imperative that the following rules be strictly adhered to:

1. Sleeve yokes to midship shafts, end yokes, companion flanges, etc. must not be rotated from their original position during reassembly.
2. It is strongly recommended that an indexing mark or line be painted down the entire length of all assemblies prior to removal from the vehicle.
3. Upon reassembly, all components must be reinstalled exactly as removed. Do not turn yokes or sleeves from their original position.

For Spicer slip yoke interaxle applications, the slip yoke should be installed with the yoke ears "up hill" from the seal.

In main driveshaft applications, the slip yoke seal should be up hill or with the slip yoke at the transmission in transmission-to-axle applications.

4. If at all possible, do not remove boots or dust caps from sleeve assemblies.
5. Inspect boots for any damage (rips or holes). If boot is damaged, it must be discarded. Do not reuse clamps.
6. Push on dust caps are not serviceable. If dust cap must be removed, replace it with a new one.

7. If a boot must be disconnected, remove the clamp at the sleeve end and leave the other end attached. Do not reuse clamp.
8. **IMPORTANT:** If any major component is replaced on any of the assemblies (any component other than boots, dust caps, or u-joints), the entire system balanced assembly must be rebalanced by a competent driveshaft repair facility capable of system balancing.

Failure to adhere to these recommendations can cause excessive driveline vibration and/or premature component failure.

*NOTE: The unitized one piece seal now used on Spicer driveshafts is not intended to be removed in service. When servicing driveshafts with the pop on seal, DO NOT remove the seal from the slip yoke. Pull the tube shaft out of the slip yoke and carefully realign the splines on the tube shaft with the slip yoke upon reassembly. To separate the tube shaft from the slip yoke, pull the tube out of the slip yoke, leaving the seal in place. A significant amount of force will be required to remove as well as reinstall the tube shaft through the seal. Removal of the unitized seal causes damage to the seal lip where it contacts the slip yoke. If removal of the seal is absolutely necessary, it should be replaced with a new unit.*

To remove the old seal, hold the yoke assembly firmly in a vise. Using a large chisel, drive the seal off of the yoke. To install a new seal, generously lubricate the seal lip and press the new seal into place using a small arbor press or equivalent.



**WARNING:** Rotating shafts can be dangerous. You can snag clothes, skin, hair, hands, etc. This can cause serious injury or death.



# SERVICING THE DRIVESHAFT

Do not go under the vehicle when the engine is running.

Do not work on a shaft (with or without a guard) when the engine is running,

Do not engage or disengage driven equipment by hand from under the vehicle when the engine is running,

In order to avoid becoming entangled, install the power take-off and/or shaft behind the frame rail, tanks, battery box, etc.

If power take-off and/or shaft are still exposed after installation, install a guard,

Install a support strap when servicing a driveshaft to prevent personal injury.

## FULL ROUND END YOKE STYLE

1. Rotate the transmission end yoke by putting the transmission in neutral and the axle end yoke by jacking up one rear wheel, so the cross holes are in a horizontal position.

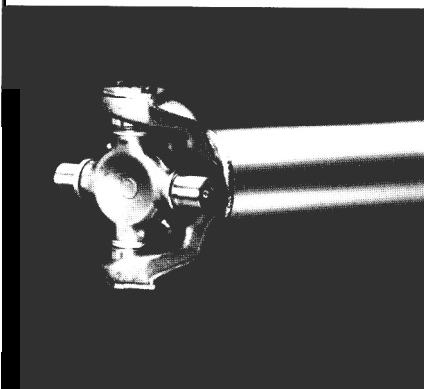

2. Tilt the cross trunnions of the driveshaft, both ends, with trunnions pointing toward each other from end to end, one side. Install with the slip joint nearest the source of power. Use a nylon support strap to aid in handling the driveshaft.

**CAUTION:** Use a journal cross locator to avoid nicking journal cross trunnions or damaging oil seal slingers.

3. Holding the driveshaft firmly, project a trunnion in an outward position

between the lugs of either the axle or the transmission end yoke and through a cross hole. Repeat at opposite end. The driveshaft is being supported at each end by one trunnion surface in a cross hole and the nylon support strap.

Tilt a cross trunnion until the opposite side can be inserted through a cross hole. Repeat at opposite end. The driveshaft is now being supported at each end by two trunnion surfaces in the cross holes and the nylon support strap.

4. Move one end of the shaft to cause a trunnion to project through the cross hole beyond the outer machined face of the yoke lug. Place a bearing assembly over the trunnion diameter and align it to the cross hole.

Holding the trunnion in alignment with the cross hole, press bearing assembly flush to face of end yoke by hand.

If bearing assembly binds in cross hole, tap with soft hammer directly in center of bearing assembly plate. Do not tap outer edges of bearing plate.

5. Slide the shaft to project an opposite trunnion through the cross hole beyond the face of the end yoke. Again, place a bearing assembly over the trunnion, align and place hands on opposite bearing assembly, and press both inward flush to yoke faces. If assembly binds, tap with soft hammer as outlined above. Put the lock plate tab in place and insert the "Grade Eight" cap screws through the holes in the lock plates and bearing assemblies. Thread cap screws into end yokes. Tighten with wrench until plates are flush against end yoke faces.

6. Lubricate the cross and bearing assembly until lube appears at all four seals. If any seal fails to purge, see "Lubrication Procedure for U-Joints." Also check slip yoke lubrication.

7. Torque all eight bolts to specification (see chart below). Bend lock plate tabs to flat of cap screwheads to lock in place.

**NOTE:** The self-locking bolt design for full-round yokes uses serrated bolts with lock patch and DOES NOT require a lock strap. DO NOT reuse ANY retaining bolts.

8. Repeat at opposite end. Remove nylon support strap.

## FULL ROUND END YOKE

SERIES	THREAD SIZE	TO QUE					
		LOCK STRAP DESIGN			SERRATED BOLT w/LOCK PATCH		
		(Lb./Ft.)	(NM)	Bolt P/N	(Lb./Ft.)	(NM)	Bolt P/N
1610	.312-24	26-35	35-48	5-73-109	26-35	35-48	5-73-709
1710	.375-24	38-48	52-65	6-73-109	38-48	52-65	6-73-209
1760	.375-24	38-48	52-65	6-73-109	38-48	52-65	6-73-209
1810	.375-24	38-48	52-65	6-73-109	38-48	52-65	6-73-209
1880	.438-20	60-70	81-95	7-73-115	60-70	81-95	7-73-315

# SERVICING THE DRIVESHAFT

## QUICK DISCONNECT™ HALF ROUND END YOKE

SERIES	THREAD SIZE	BOLT P/N	BOLT TORQUE	
			(Lb./Ft.)	(NM)
SPL90	.375-24	6-73-412	45-60	61-81
1610	.375-24	6-73-412	45-60	61-81
1710	.500-20	8-73-316	115-135	156-183
1760	.500-20	8-73-316	115-135	156-183
1810	.500-20	8-73-316	115-135	156-183

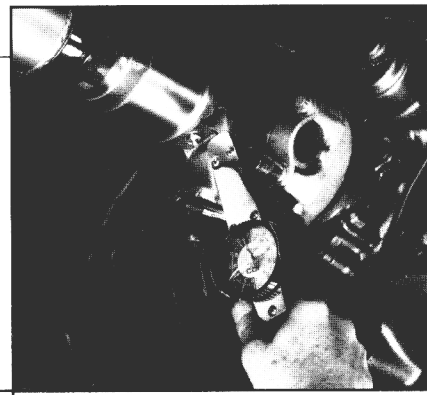

On Quick Disconnect applications, the bearing saddles of the end yoke must be clean and free of any contaminants.

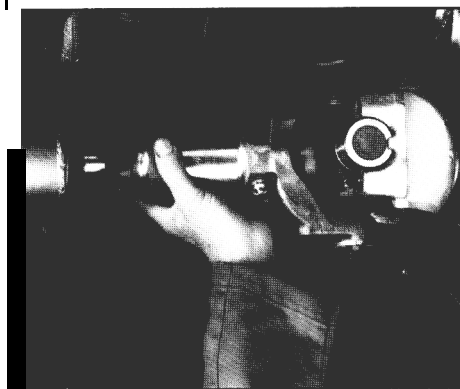

Using a soft hammer, tap the bearing assemblies until they are fully seated into the end yoke. Check to be sure the cups are fully seated in the bearing saddles of the yoke behind the yoke tabs as shown below.

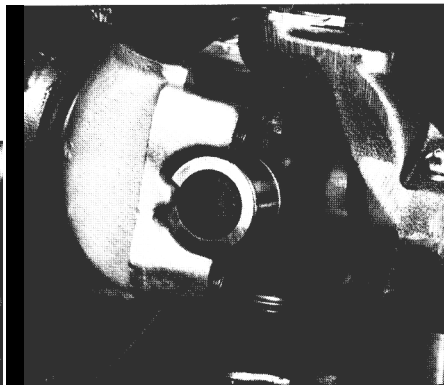
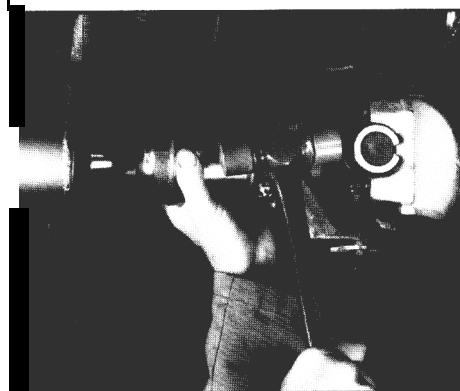

Install the bearing straps and bolts and torque all eight bolts to the proper specification. Bend lock plate tabs to flat of cap screwheads to lock in place.

*NOTE: The self-locking bolt design for full-round yokes uses serrated bolts with lock patch and DOES NOT require a lock strap. DO NOT reuse ANY retaining bolts.*



Lubricate the cross and bearing assembly until lube appears at all four seals. If any seal fails to purge, see "Lubrication Procedure for U-Joints." Also check slip yoke lubrication.

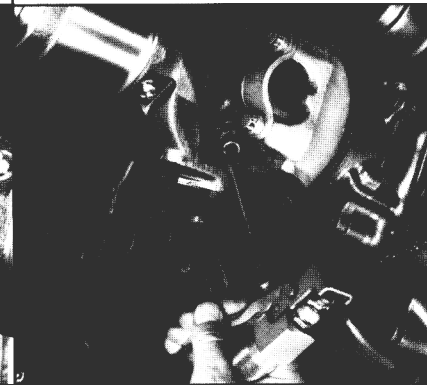

*CAUTION: Excessive bearing rotation could cause premature wear of components involved. The causes of rotation are:*

1. Use of non-Spicer parts with Genuine Spicer components.
2. Improper torque on retaining strap bolts.
3. Failure to firmly seat both bearing assemblies in the end yoke saddles before the strap bolts are tightened.
4. Dirty bearing saddles.

*CAUTION: Half Round self-locking retaining bolts should not be reused. Follow instructions implicitly to prevent danger of serious personal injury or death from loss of driveshaft function.*

# SERVICING THE DRIVESHAFT

## FLANGE YOKE

SERIES	THREAD SIZE	BOLT TORQUE	
		(Lb./Ft.)	(NM)
SPL90	.375-24	40-48	54-65
1610	.375-24	40-48	54-65
1710	.375-24	40-48	54-65
1760	.438-20	63-75	85-102
1810	.438-20	63-75	85-102
1880	.625-18	194-232	263-315

### FLANGE YOKE STYLE

With nylon support strap in place and holding the driveshaft firmly, align the (permanent end) flange pilots of the driveshaft flange yoke and axle companion flange with each other. Align bolt holes and install bolts, lock washers and nuts to temporarily secure driveshaft to axle. Compress the slip assembly to position the opposite end of the driveshaft to the transmission companion flange. Align bolt holes and install bolts, lock washers, and nuts. Torque to specifications, both ends.

*NOTE: 1650 Series Bearing Assemblies with Locking Flats.*

*When installing new bearing assemblies into cross holes, the locking flat on the bearing assembly must be aligned with the locking flat in the yoke cross hole. Proper location of locking flats will assure that the bearing assembly will not rotate.*

### LIGHT AND MEDIUM DUTY APPLICATION

Cross and Bearing Kit replacement

Inside and Outside Snap Ring, J-Bolt and Bearing Strap Design



**!** **WARNING:** Rotating shafts can be dangerous, You can snag clothes, skin, hair, hands, etc. This can cause serious injury or death. Do not go under the vehicle when the engine is running,

### TOOLS (1000 -1500 SERIES):

Common Hand Tools  
**Soft Hammer**

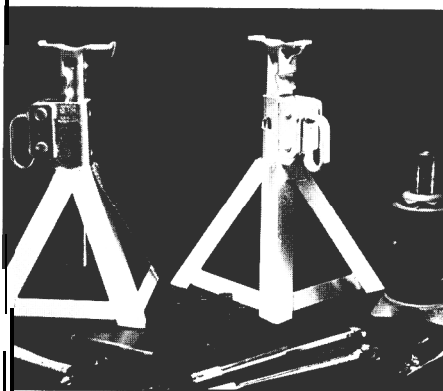

### REMOVAL

Procedures for removing the driveshaft from light and medium duty vehicles are nearly the same as for heavy duty applications. One difference is that the cross and bearings vary in the method of attaching to the vehicle. Methods of attachment include u-bolt, bearing strap and flange yoke design.

For heavy driveshafts, support with a nylon support strap. Remove the u-bolts or strap cap screws from the end yoke. Slide the slip yoke toward the shaft to free the bearings from their seats between the yoke tabs in the end yokes, Care should be taken to avoid dropping the bearing assemblies. Repeat at opposite end.



For double flange applications, disassemble as a complete assembly by removing the companion flange bolts.

For flange yoke and end yoke combination-type driveshafts, remove as described above for whatever design applies.

### OUTSIDE SNAP RING DESIGN (RELURABLE)

#### Disassembly

With the shaft removed, the following procedure should be followed

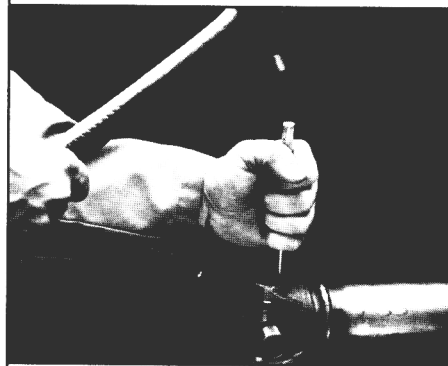

1. Using a soft drift, tap the outside of the bearing assembly to loosen snap ring. Tap bearing only hard enough to break assembly away from snap ring.

# SERVICING THE DRIVESHAFT



2. Remove snap ring from yoke. Turn joint over, tap bearing away from snap ring, then remove opposite snap ring.

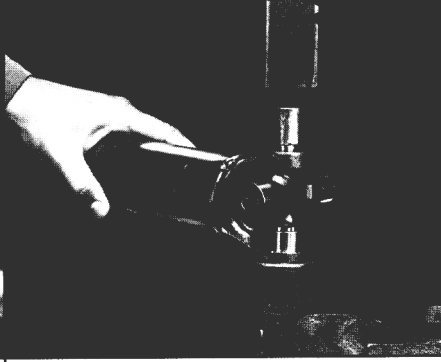

5. To remove the opposite bearing assembly, turn the yoke over and straighten the cross in the open cross hole. Then carefully press on the end of the cross so the remaining bearing assembly moves straight out of the bearing cross hole. If the cross or bearing assembly are cocked, the bearing assembly will score the walls of the cross hole and ruin the yoke.

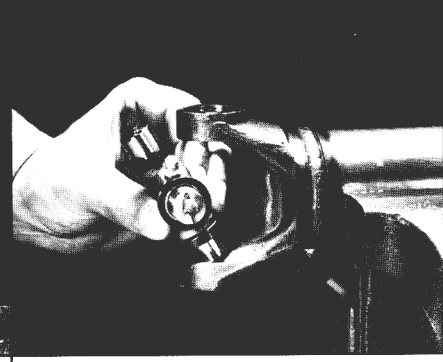

2. Position the cross in the yoke with its lube fitting on the inboard side (toward driveshaft).

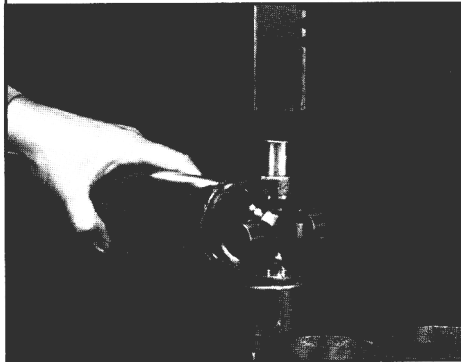

3. Set the yoke in the arbor press with a piece of tube stock beneath it. Position the yoke with the lube fitting pointing up to prevent interference during disassembly. Place a solid plug on the upper bearing assembly and press it through to release the lower bearing assembly.

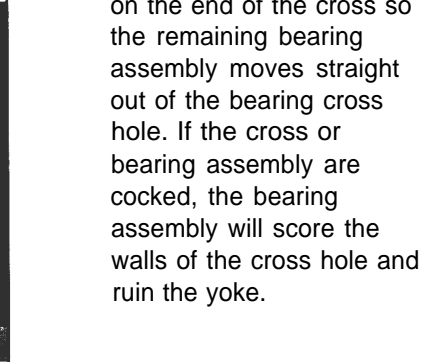

6. Repeat this procedure on the remaining bearing assemblies to remove the cross from the yoke.

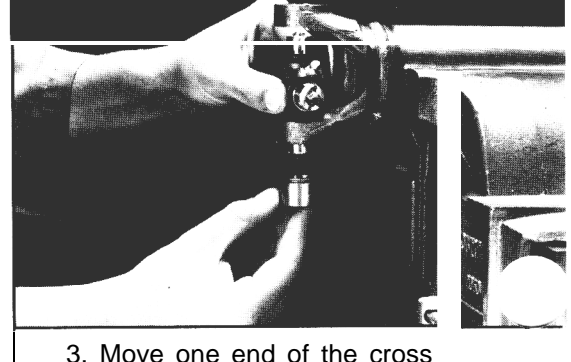

3. Move one end of the cross to cause a trunnion to project through the cross hole beyond the outer machined face of the yoke lug. Place a bearing assembly over the trunnion diameter and align it to the cross hole. Using an arbor press, hold the trunnion in alignment with the cross hole and place a solid plug on the upper bearing assembly. Press the bearing assembly into the cross hole enough to install a snap ring.

## Reassembly

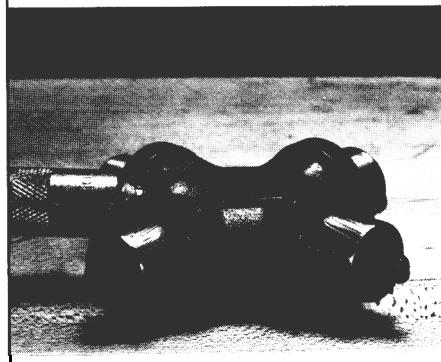

4. If the bearing assembly will not pull out by hand after pressing, tap the base of the lug near the bearing assembly to dislodge it.

1. Pack the four grease cavities of the cross with a high quality extreme pressure N.L.G.I. Grade 2 grease (refer to page 6). Also pack each bearing assembly approximately 1/4 full with this grease.

# SERVICING THE DRIVESHAFT



4. Install a snap ring.



5. Repeat steps 3 and 4 to install the opposite bearing assembly. If the joint is stiff, strike the yoke ears with a soft hammer to seat the needle bearings.



**CAUTION:** Be sure snap rings are properly seated in grooves.

6. Repeat steps 2-5 at the opposite end of the driveshaft if installing a second kit. Make sure to keep lube fittings at each end of the driveshaft in line.

7. Install the reassembled driveshaft in the vehicle. If bearing straps or u-bolts hold the shaft in vehicle, be certain the bearing assemblies are fully seated between bearing locating shoulders.

8. Torque bolts to specification.

**CAUTION:** Self-locking bolts used with bearing straps should not be reused. Follow instructions implicitly to prevent danger of serious personal injury or death from loss of driveshaft function.

9. Apply more grease through the lube fitting until grease appears at all four bearing seals.

## INSIDE SNAP RING DESIGN (RELUBABLE)

### Disassembly



Removing an inside snap ring.

Repeat outside snap ring design disassembly instructions.

### Reassembly

Repeat outside snap ring design reassembly instructions.



**WARNING:** Rotating shafts can be dangerous. You can snag clothes, skin, hair, hands, etc. This can cause serious injury or death. Do not go under the vehicle when the engine is running.

In order to avoid becoming entangled install power take-off and/or shaft behind the frame rail, tanks, battery box, etc.

If power take-off and/or shaft are still exposed after installation, install a guard.

## PRELUBE OR LUBE-FOR-LIFE™ DESIGNS



Spicer Prelube or Lube-for-Life™ U-joint Kit

Some Spicer crosses and bearings are prelube or lube-for-life designs and have no lube fittings. Since lubrication is critical, special seals are used to contain the lubricant in the cross/bearings in this design.

Service instructions are nearly the same for relubable and prelube or lube-for-life design, whether it is inside or outside snap ring, u-bolt or bearing strap design.

The difference is that lifetime lubrication is done by Spicer at the time of manufacture and relubrication should not be necessary. Replacement of the cross and bearing kit rather than relubrication is recommended.

# SERVICING THE DRIVESHAFT

## TORQUE SPECS FOR LIGHT AND MEDIUM DUTY

POSITION	BOLT SIZE	TORQUE	
		(Lb./Ft.)	(NM)
U-Bolts	(5/16) .312-24	14-17	19-23
	(3/8) .375-24	20-24	27-33
	(7/16) .438-20	32-37	43-50
Bearing Strap	(1/4) .250-28	13-18	18-24
	(5/16) .312-24	25-30	34-41
	(3/8) .375-24	45-60	61-81
Flange Bolts	(5/16) .312-24	22-26	16-35
	(3/8) .375-24	40-48	54-65
	(7/16) .438-20	63-75	85-102
	(1/2) .500-20	97-116	132-157

## DOUBLE-CARDAN CONSTANT VELOCITY TYPE JOINT

(Light Duty)

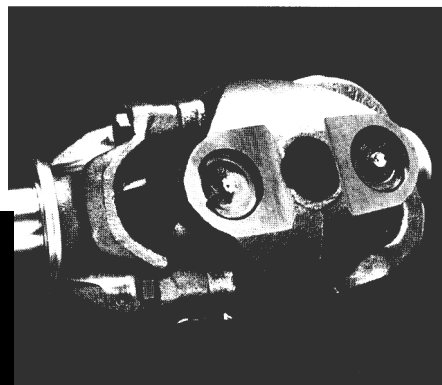

The double-cardan constant velocity (CV) type u-joint is a special design to accommodate necessary installation angles not compatible with single-cardan u-joints. The CV joint also requires special attention. Neglect is its main enemy.

The CV joints need lubrication to live. Some of the older assemblies using flush-type fittings require special lube gun fittings, such as a needle nose attachment. The crosses may or may not have lube fittings.

The centering socket and ball is critical to proper function of the CV joint and smooth operation. Without lubrication it will wear out, causing vibration and serious damage. Rebuilding the CV joint will be necessary.

## LUBRICATION

The lube fitting for the centering socket in the CV joint can be difficult to reach and requires a special lube technique. It is necessary to rotate the driveshaft to a position with the flush type lube fitting in the centering socket up toward the floor board. The yokes spread or open in this position to allow access with the needle nose tip. It is still an awkward and blind procedure. That explains why neglect is so common.



**WARNING:** Rotating shafts can be dangerous. You can snag clothes, skin, hair, hands, etc. This can cause serious injury or death. Do not work on a shaft (with or without a guard) when the engine is running.

A more positive, less frustrating approach is to disconnect the driveshaft. The lube fitting will come into view but it may be necessary to jack one front wheel and rotate the driveshaft. This can be done to all 4WD vehicles with the double-cardan u-joint.

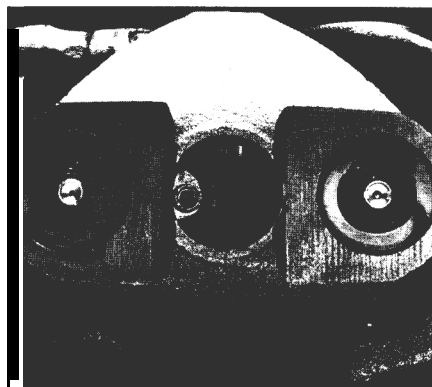

Lubrication access hole in late-design Spicer Double Cardan Joints

The later-design Spicer CV joints simplify lubrication by making easy access to the lube fittings. Service replacement kits have been modified with a lube fitting in one or more bearing assemblies to aid in lubrication access. Also, an access hole has been provided in the center yoke for easy lubrication of the centering ball. This new design eliminates the need to disconnect the shaft and puts the fittings in plain view.

Look for signs of u-joint trouble when lubricating u-joints:

- ✓ Lube spray from a leaky seal indicates need for u-joint replacement.
- ✓ Any looseness or noticeable "slop" at a u-joint in the driveshaft calls for immediate replacement of the u-joint, assuming the snap rings or bolts are already in place or torqued down.

# SERVICING THE DRIVESHAFT

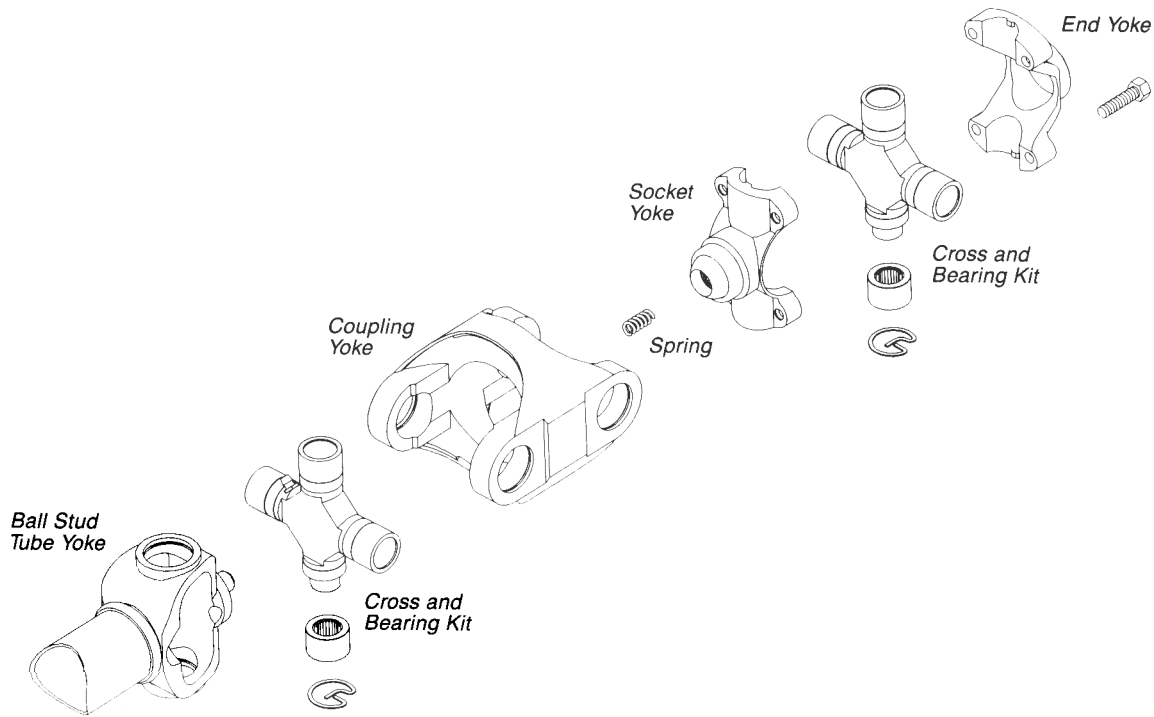

Spicer Double Cardan Constant Velocity Type Joint

## SPICER STYLE REPAIR KIT

The Spicer style double cardan CV joint has outside snap rings. CV joint repairs should be made whenever inspections show any noticeable sign of loose fit, corrosion or loss/lack of lube at u-joint or centering ball.

Centering socket/ball repair kits are available from Spicer with installation instructions for replacement. The correct repair kit depends on whether the CV joint is the older or newer type. The advantage of easy access lube fittings for the new style center kit would be lost when installed in an old style u-joint. The centering kits have a different location for the lube fitting.

The disassembly and reassembly of both types is basically the same procedure. It is important that both styles be reassembled with all lube fittings

will make service lubrication more

convenient and reduce the possibility of overlooking lube points.

## DISASSEMBLY

1. Disconnect u-bolts or bearing straps at the single-cardan end yoke position. Disconnect cap screws from the CV end yoke or flange bolts from the CV companion flange. This will allow driveshaft removal from the vehicle.

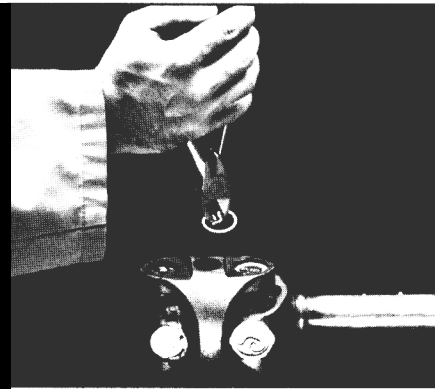

2. Remove all snap rings from the bearing assemblies.

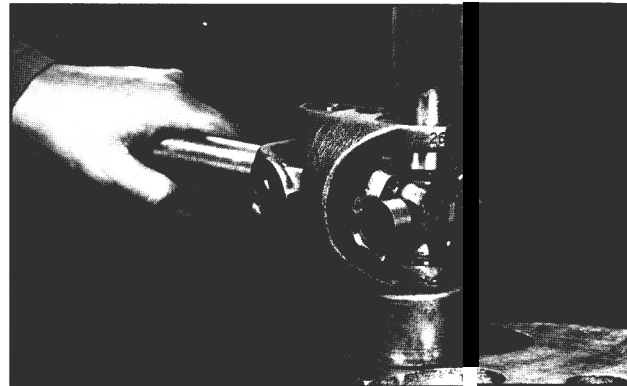

3. Press the bearing assembly partially from the outboard side of the center yoke — enough to grasp by vise jaws. Do not press the bearing assembly completely through.

**NOTE:** Be sure to remove lube fitting if it interferes with bearing assembly press-out.

# SERVICING THE DRIVESHAFT

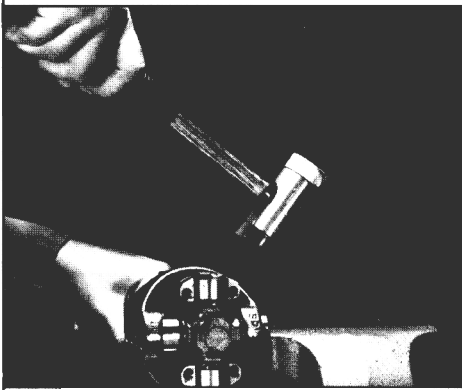

4. Grasp the protruding bearing assembly by vise jaws. Tap the tube yoke with a mallet and drift to dislodge the bearing assembly from the yoke hole.



## REASSEMBLY

1. Fit a cross into the tube yoke.
2. Place a bearing assembly in a tube yoke hole and over a trunnion. Keep the needle rollers upright in the bearing assembly. A needle roller lying at the bottom of the bearing assembly will prevent proper assembly.

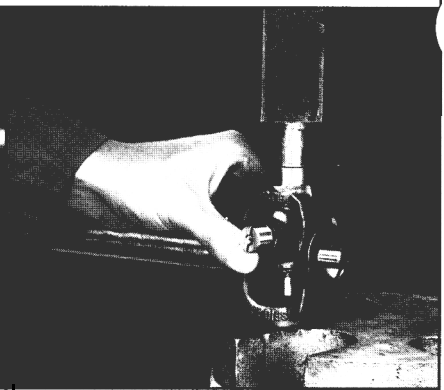

3. Press the bearing assembly in place and install a snap ring.



5. Flip the assembly and repeat steps 3 and 4 for removing the opposite side bearing assembly. This will then allow removal of the cross centering kit assembly and spring.
6. Press the remaining bearing assemblies out on the other cross as described above to complete disassembly.

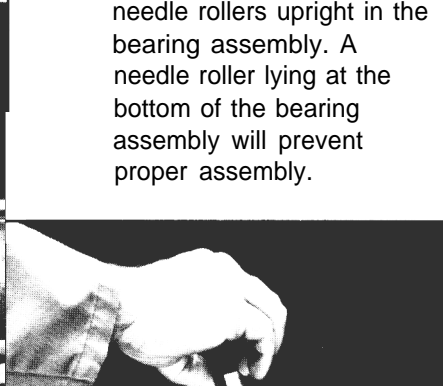

**NOTE:** Be sure to remove the lube fitting if it interferes with bearing assembly press-up.

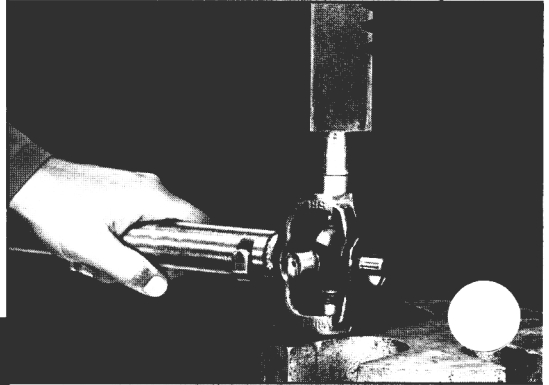

4. Flip the tube yoke and repeat bearing assembly installation on the opposite trunnion. Install a snap ring.



5. Fit the center yoke on the remaining two trunnions and press bearing assemblies in place, both sides. Install snap rings.

**CAUTION:** Tap in the center of the "H" yoke. Never strike the yokes at the bearing assembly holes because the snap ring grooves may collapse and make reassembly impossible.



# SERVICING THE DRIVESHAFT

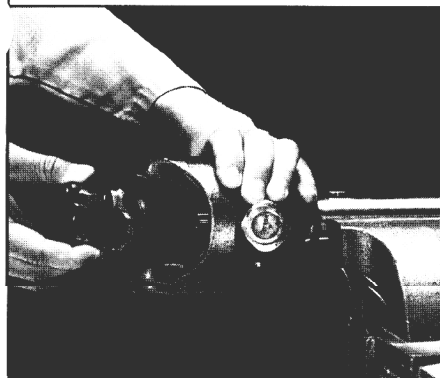

6. Next install the centering kit assembly inside the center yoke making sure the spring in the tube yoke is in place. Align the lube fitting on the centering kit assembly with the lube fitting on the installed cross.

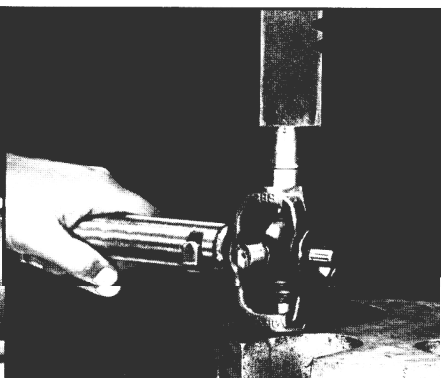

8. Press the remaining two bearing assemblies into place and install snap rings.

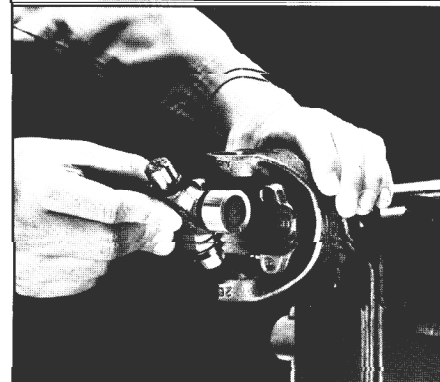

7. Place two bearing assemblies on the remaining cross (opposite sides). Fit the open trunnions into the center yoke holes and the bearing assemblies into the centering kit assembly. Make sure the lube fitting on the cross is in line with the other two lube fittings.



9. Tap the snap rings to allow them to set into the grooves. A bearing cup from a used u-joint works well for this.



10. Check for proper assembly. Flex the CV joint beyond center. It should snap "over center" in both directions when all needle rollers and components are correctly assembled.

11. Reinstall in the vehicle.
12. Torque all bolts and cap screws to specifications shown below.
13. Add grease to all three lube fittings.

## TORQUE SPECIFICATIONS FOR DOUBLE-CARDAN CONSTANT VELOCITY TYPE JOINTS

1210 CV-Standard Grade Eight Bolts  
Bolt Torque -13-18 lb./ft.  
(.250-28)

1310/1330CV-Standard Grade Eight Bolts  
Bolt Torque -22-26 lb./ft.  
(.312-24)

**CAUTION:** Self-locking bolts used with bearing straps should not be reused. Follow instructions implicitly to prevent danger of serious personal injury or death from loss of driveshaft function.



**WARNING:** Rotating shafts can be dangerous. You can snag clothes, skin, hair, hands, etc. This can cause serious injury or death.

Do not go under the vehicle when the engine is running.

In order to avoid becoming entangled install power take-off and/or shaft behind the frame rail, tanks, battery box, etc.

If power take-off and/or shaft are still exposed after installation, install a guard.

# SERVICING THE ADVANCED MATERIALS DRIVESHAFT

## SERVICING THE DRIVESHAFT

Assembly and disassembly procedures for Spicer Lite™ aluminum and Spicer Graph-Lite™ driveshafts are similar to those of other driveshafts. However, some unique instructions must be followed to service advanced technology materials.

### SPICER LITE™ ALUMINUM DRIVESHAFT

#### Inspecting and Lubricating

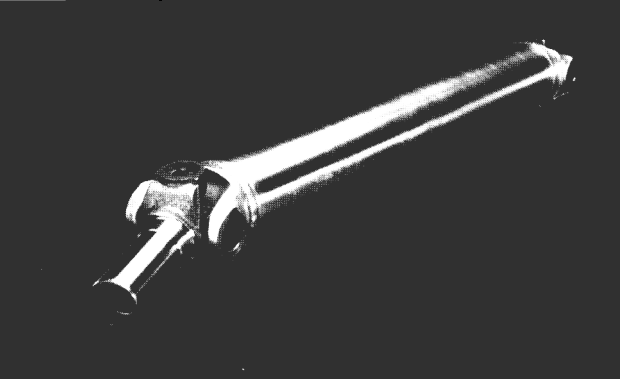

- 1 ) Inspect Spicer Lite™ aluminum driveshafts following the same procedures for steel driveshafts as outlined on pages 4-7.
- 2) Inspect the aluminum tubing for surface scratches and dents. These scratches may **not** exceed 0.008 inches in depth.



- 3) Visually inspect the circle welds and end fittings for any signs of cracks or

signs of deterioration. If there are any cracks that exceed 0.008 inches in depth, the assembly must be replaced.

- 4) Check to be sure there are no missing balance weights. If balance weights are missing and a void has occurred in the aluminum tubing greater than 0.008 inches, the assembly must be replaced.

## SERVICING

- 1 ) Service Spicer-Lite™ aluminum driveshafts following the same procedure for steel driveshafts as outlined on pages 13-15.
- 2) After removing the cross and bearings from both ends of the driveshaft, inspect the cross hole surfaces for damaged or raised metal. Raised metal can be removed with an emery cloth. The raised metal can cause premature cross and bearing problems.

**CAUTION:** Aluminum is softer than steel. Care must be taken not to remove excessive material or damage cross holes.

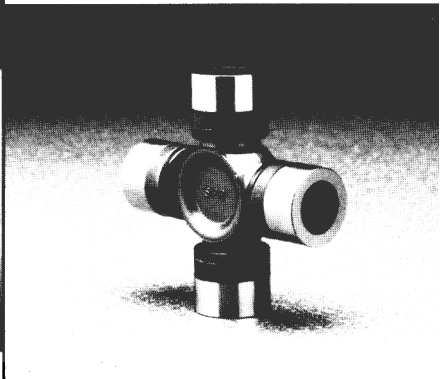

- 3) If the universal joint kit is replaced, it must be

replaced with a kit designed specifically for use with aluminum. The use of non-endurion coated kits will result in damage to the driveshaft through galvanic corrosion.

**CAUTION:** When replacing universal joint kits in aluminum driveshafts, use kits designed specifically for aluminum to avoid galvanic corrosion.

## Straightening and Balancing

- 1 ) Our Spicer Lite™ aluminum driveshaft can be straightened following the same procedure for steel driveshafts as outlined on page 24.

## GRAPH-LITE™ DRIVESHAFTS

### Inspecting and Lubricating

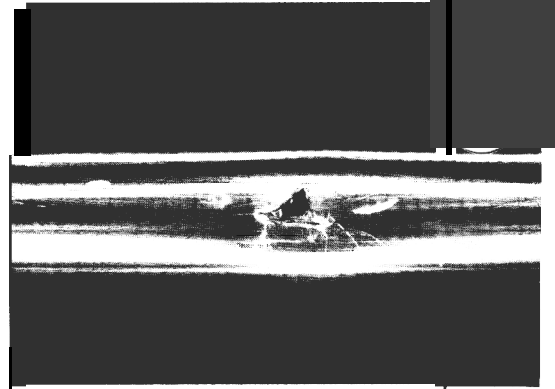

- 1 ) Inspect driveshaft for any surface imperfections in the black graphite covering. Look for torn graphite near the ends of the covering and surface scratches or cracks deeper than 0.008 inches along the length of the covering. If any imperfections such as these exist, the assembly must be replaced. The black graphite must be securely attached to the aluminum tubing in all areas. If there is any relative movement between the two materials (aluminum and carbon graphite), the assembly must be replaced.

# SERVICING THE ADVANCED MATERIALS DRIVESHAFT

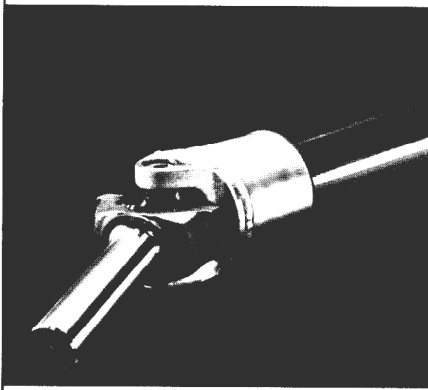

- 2) Inspect the driveshaft following the same procedures for steel driveshafts as outlined on pages 4-7.
- 3) Inspect the aluminum tubing for surface scratches and dents deeper than 0.008 inches.



- 4) Visually inspect the circle welds and end fittings for any signs of cracks or deterioration. If there are any cracks that exceed 0.008 inches in depth, the assembly must be replaced.
- 5) Check for any missing balance weights. If balance weights are missing, and a void has occurred in the aluminum tubing greater than 0.008 inches, the assembly must be replaced.

## Servicing

- 1) Service Spicer Graph-Lite™ driveshafts following the same procedure for steel driveshafts outlined on pages 13-15.
- 2) After removing the cross and bearings from both ends of the driveshaft, inspect the cross hole surfaces for damaged or raised metal. Raised metal can be removed with an emery cloth. The raised metal can cause premature cross and bearing problems.

**CAUTION:** Aluminum is softer than steel. Care must be taken not to remove excessive material or damage cross holes.

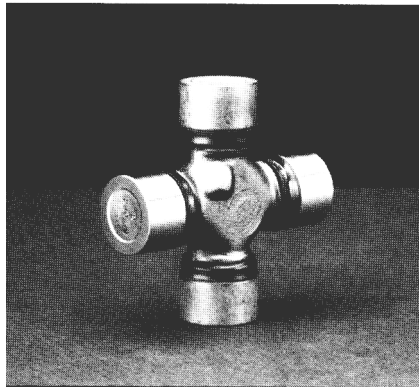

- 3) If the universal joint kit is replaced, it must be replaced with a kit designed specifically for use with aluminum. The use of non-endurion coated kits will result in damage to the driveshaft through galvanic corrosion.

**CAUTION:** When replacing universal joint kits in Graph-Life™ driveshafts, use kits designed specifically for aluminum to avoid galvanic corrosion.

## Straightening and Balancing

**DO NOT, UNDER ANY CIRCUMSTANCES, ATTEMPT TO STRAIGHTEN ALUMINUM GRAPHITE DRIVESHAFTS.** Any attempt to do this will cause damage to the carbon graphite covering resulting in decreased performance of the driveshaft. The entire driveshaft assembly must be replaced if the tubing is bent or twisted.



**WARNING:** Rotating shafts can be dangerous. You can snag clothes, skin, hair, hands, etc. This can cause serious injury or death.

Do not go under the vehicle when the engine is running.

Do not work on a shaft (with or without a guard) when the engine is running.

Do not engage or disengage driven equipment by hand from under the vehicle when the engine is running.

In order to avoid becoming entangled, install the power take-off and/or shaft behind the frame rail, tanks, battery box, etc.

If power take-off and/or shaft are still exposed after installation, install a guard.

Install a support strap when servicing a driveshaft to prevent personal injury.

A serious or fatal injury can occur ...

- ▲ if you lack proper training
- ▲ if you fail to follow proper procedures
- ▲ if you do not use proper tools and safety equipment
- ▲ if you assemble driveline components improperly
- ▲ if you use incompatible driveline components
- ▲ if you use worn-out or damaged driveline components
- ▲ if you use driveline components in a non-approved application

This manual contains detailed safety instructions. Read, understand and follow this manual.

- ▲ Get proper training
- ▲ Learn and follow safe operating procedures
- ▲ Use proper tools and safety equipment
- ▲ Use proper components in good condition

# STRAIGHTENING AND BALANCING ANGLES AND PHASING

## STRAIGHTENING AND BALANCING THE DRIVESHAFT

(Excluding Aluminum)

The rebuilding of a driveshaft assembly usually consists of replacing worn cross and bearing assemblies with a new kit. These kits replace the part of a driveshaft most subject to wear in operation. The potential off-center condition present in the cross and bearing assemblies makes it desirable to balance every assembly after installing new cross and bearing kits.

When the tubing is bent or twisted or the tube fittings are distorted, it will be necessary to replace the damaged parts.

Properly assemble the new components into the tube and straighten the shaft assembly before tack welding, to be sure the parts are on center. This can be done by mounting the complete assembly in the appropriate tooling and straightening until the ends of the tube run concentric within 0.005 T.I.R. Recheck for runout.

### RUNOUT VERSUS OVALITY

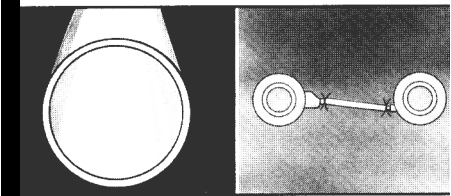

Runout-circular diameter, bent tubing

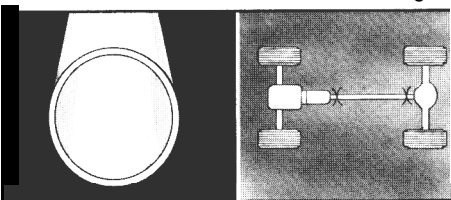

Ovality-oval diameter straight tubing

When checking for runout, it is important to distinguish between runout and ovality. Runout is when the tube is slightly bent but still maintains its circularity throughout the tube. During dynamic balancing, a dial indicator will show runout ONCE per revolution.

Ovality occurs when the tube is not circular but oval in shape.

During dynamic balancing, a dial indicator will display ovality TWICE per revolution. Even though a tube may be straight, ovality will make it seem bent. A tube with ovality may be used up to a 0.010 T.I.R. runout reading. Beyond this limit the tube must be discarded for driveshaft purposes.

After welding, the entire driveshaft should be straightened to the following limits:

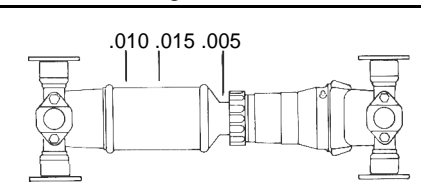

Heavy Duty Driveshaft Runout Limits

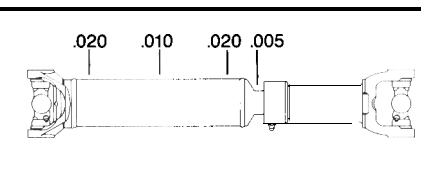

Light and Medium Duty Driveshaft Runout Limits for Unbalanced Driveshaft

### Heavy Duty

- 0.005 T.I.R. on the neck of the slip tube shaft
- 0.010 T.I.R. on ends of tubing 3" from welds
- 0.015 T.I.R. at linear center of the tube

### Light and Medium Duty

- 0.005 T.I.R. on the neck of the slip tube shaft
- 0.010 T.I.R. on ends of tubing 3" from welds
- 0.015 T.I.R. at linear center of the tube
- 0.015 T.I.R. for full length of tube with 30" or less

(T.I.R. – Total Indicator Reading)

These runouts should be taken with entire driveshaft assembly mounted on master tooling which locates on the outboard bearing assemblies of the u-joint kit (light and medium duty), or the trunnions

of the outboard u-joint kit (heavy duty) or on selected flange yokes or yokes.

All flange yokes or yokes should be selected for dynamic balance to eliminate as much unbalance as possible. During balancing, the driveshaft again should be mounted on the same master tooling or selected flanges or yokes.

After straightening, balance the entire assembly to Original Equipment Manufacturer specifications.

## ANGLES AND PHASING

(All Types)

Proper driveshaft angles and correct phasing of the yokes are very important in maintaining long life and quiet running shafts.

When in phase, the slip yoke lugs (ears) and tube yoke lugs (ears) are in line. Normally, this is the ideal condition and gives the smoothest running shaft. There may be an alignment arrow stamped on the slip yoke and on the tube shaft to assure proper phasing when assembling these components. If there are no alignment marks, they should

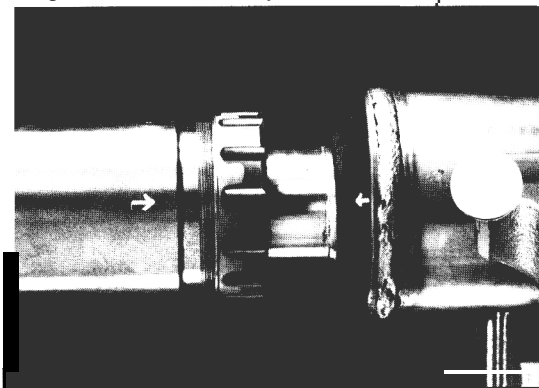

An "In Phase" Driveshaft

be added before disassembly of the shaft to assure proper reassembly.

Phasing is relatively simple on a two-joint set . . . be sure that the slip yoke lugs and the tube yoke lugs are in line. Driveshaft angles are a little more complicated.

**COMPANION FLANGE (1)**

(2 STYLES)



**FLANGE YOKE (2)**

(2 STYLES)

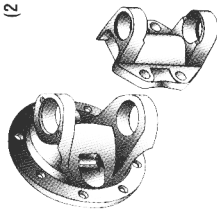

**SLIP YOKE ASSEMBLY (3)**

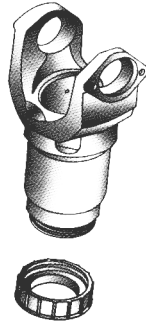

**END YOKE (4)**

(3 STYLES)



**JOURNAL & BEARING KIT**

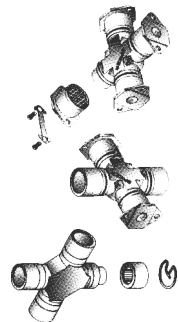

# SPICER® LIFE™ DRIVELINE COMPONENTS

Quick Disconnect™ Hill Round End Yoke (Double Strap Design)

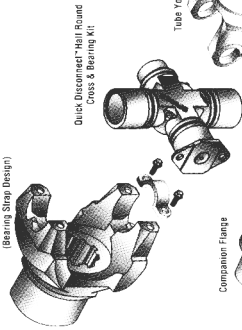

Quick Disconnect™ Hill Round Cross & Bearing Kit



Companion Flange

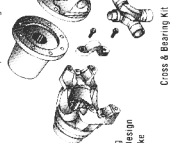

Flange Yoke



Bearing Strap Design End Yoke



Cross & Bearing Kit



Driveshaft Tubing



Meshup Tube Shaft



**3 JOINT ASSEMBLY DRIVESHAFT**

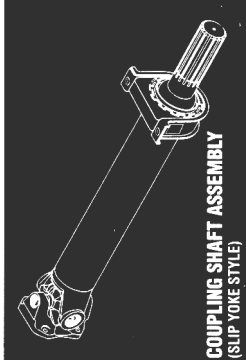
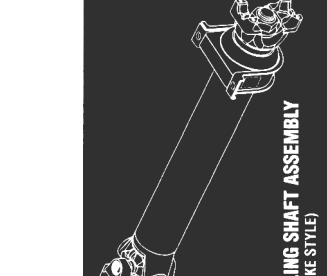

**COUPLING SHAFT ASSEMBLY (SLIP YOKE STYLE)**

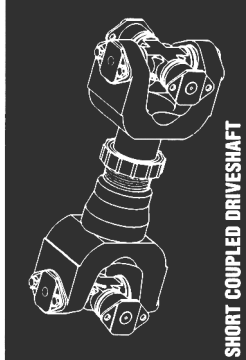

**SHORT COUPLED DRIVESHAFT**

**2 JOINT ASSEMBLY DRIVESHAFT**

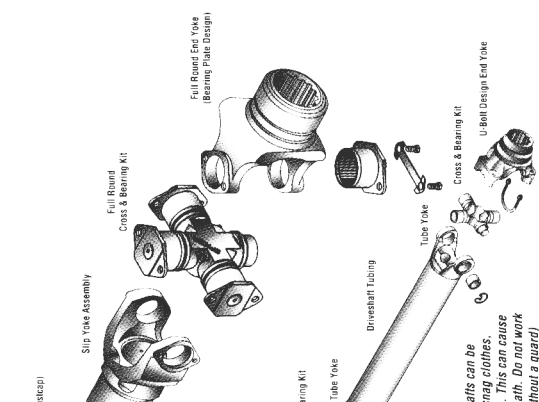

Slip Tube Shaft



Shaft Seal (Dustcap)



Slip Yoke Assembly



Full Flared Cross & Bearing Kit



Full Flared End Yoke Bearing Plate Design



Slip Yoke Assembly



Cross & Bearing Kit

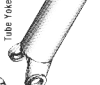

Tube Yoke



Driveshaft Tubing



Cross & Bearing Kit



U-Bolt Design End Yoke



Warning: Rotating shafts can be dangerous. You can snag clothes, skin, hair, hands, etc. This can cause a serious injury or death. Do not work on a shaft (with or without a guard) when the engine is running.



**COUPLING SHAFT ASSEMBLY (END YOKE STYLE)**

1994 Dana Corporation Printed in U.S.A.

Dana Corporation  
Spicer Universal Joint Division  
P.O. Box 955  
Toledo, Ohio 43697-0955



Bulletin J3211-2

**TUBING (30 or 32)**



**TUBE SHAFT (40-42)**

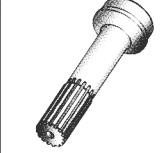

**MIDSHIP TUBE SHAFT (53-57)**



**SERRATED BOLTS w/LOCK PATCH (73)**

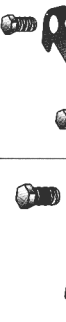

**LOCK STRAP (88)**



**U-BOLT ASSEMBLY (94)**



**SOCKET YOKE (83)**



**DUST CAP & WASHER KIT (VARIABLE PART NO.)**



**STRAP OR CAP & BOLT ASSEMBLY (70)**



**JOURNAL & BEARING KIT**



**CENTER YOKE (26)**

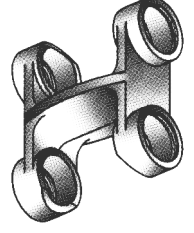

**YOKE SHAFT (82)**

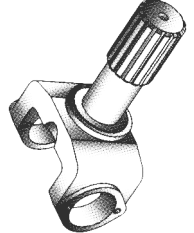

**TUBE YOKE (28)**

(2 STYLES)

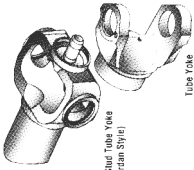

**TUBE YOKE w/TUBE (27)**

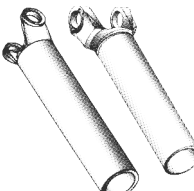

**JOURNAL & BEARING KIT**

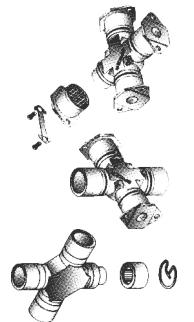

**SHAFT SUPPORT BEARING ASSEMBLY**

