

## SECTION 6      STARTING AND STOPPING PROCEDURES

<b>STARTING THE ENGINE</b> .....	<b>2</b>
STARTING FROM THE DRIVER'S SEAT .....	2
STARTING FROM THE ENGINE COMPARTMENT .....	3
COLD WEATHER STARTING .....	3
JUMP STARTING .....	3
<b>IDLE SHUTDOWN TIMER</b> .....	<b>5</b>
<b>ENGINE BLOCK HEATER</b> .....	<b>5</b>
<b>ENGINE WARM-UP</b> .....	<b>5</b>
<b>ALLISON TRANSMISSION WARM-UP</b> .....	<b>6</b>
<b>I-SHIFT TRANSMISSION – STARTING THE VEHICLE AT LOW TEMPERATURES</b> .....	<b>6</b>

## 6-2 STARTING AND STOPPING PROCEDURES

### STARTING THE ENGINE

In normal circumstances, the engine should be started from the driver's seat. However, a rear-start panel in the engine compartment permits starting of the engine from that location, mainly for maintenance purposes.

### STARTING FROM THE DRIVER'S SEAT

1. Apply the spring-loaded parking brake by pulling the parking brake control button all the way up;
2. Make sure the starter selector switch located in the engine compartment is set to the NORMAL position;
3. Check that the battery master switch in the main power compartment is set to the ON position;

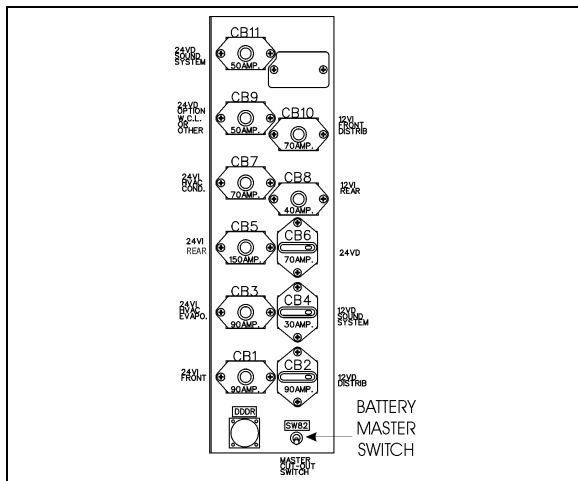

INSIDE MAIN POWER COMPARTMENT

4. Place transmission in neutral;
5. Turn ignition key to START position (refer to Section 4 *Controls and Instruments*), release the key after the engine starts.

#### NOTE

*Brake pedal must be applied when selecting Drive (D) otherwise the transmission will stay in neutral (N).*



### CAUTION

Do not engage starter for more than 15 seconds at a time. If engine does not start within 15 seconds, release ignition key and let starter cool for one minute before attempting to restart.



### CAUTION

Do not press the accelerator pedal before starting. This could result in an electronic control unit fault and degrade the fuel system control.



### CAUTION

Special precautions are necessary with turbocharged engines to avoid possible turbine damage. After starting, run the engine at normal idle for two minutes to allow lubricating oil to reach the turbocharger. Then run the engine at fast idle. Let oil pressure reach normal operating range before driving.

#### NOTE

*If engine does not start, return key to OFF position before attempting to restart.*

#### NOTE

*If the accelerator pedal is depressed before starting, release and wait 30 seconds before attempting to restart.*

### Stopping the Engine

6. Apply parking brake and place transmission in neutral (N);
7. Shut off all electrical loads;
8. Allow engine to idle for at least two minutes before shutting down the engine. This insures that the turbine speed drops and allows time for the engine exhaust gas temperature to drop to about 300°F (150°C);
9. Turn the ignition key to the OFF position.



### CAUTION

Do not shut off the engine when running above normal idle.

 **CAUTION**

Set the Safety switch to the OFF position after parking and when left unattended for an extended period of time.

**STARTING FROM THE ENGINE COMPARTMENT**

Switches to start and stop the engine from inside the engine compartment are mounted on a small panel.

 **WARNING**

Apply parking brake before starting engine from inside the engine compartment.

1. Set the battery master switch to the ON position;
2. Set the starter selector switch to the REAR START position;
3. Press the REAR START push-button switch. Release the push-button after the engine starts.

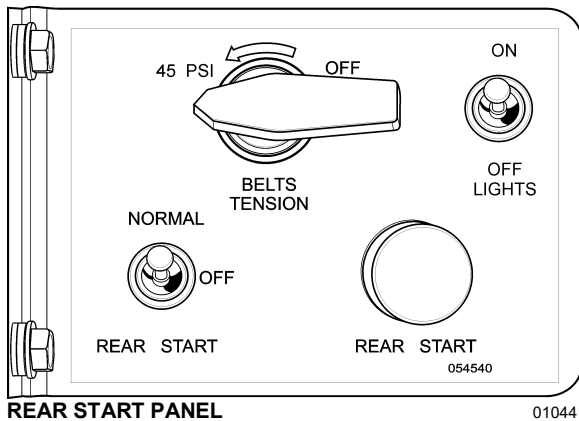

 **WARNING**

Do not wear loose clothing when working near engine. Stand clear of rotating components.

 **CAUTION**

Refer to cautions in “Starting from the driver’s seat” and “Stopping the engine” in this section.

**Stopping the Engine**

To stop the engine, set the starter selector switch to the OFF position.

 **CAUTION**

Do not stop engine by any other method.

**COLD WEATHER STARTING**

When starting a cold engine, the intake air will be warmed up with the intake air preheater. Turn the ignition switch to the ON position. The intake air preheater will not engage at coolant temperature above 54°F (12°C). If the coolant temperature is below 54°F (12°C), the intake air preheater will engage and will light the preheater telltale between 0 and 50 seconds, depending on the engine coolant temperature. Wait before the preheater telltale has turned off before starting the engine.

If necessary, once the engine has started, the preheater will reengage (post heating) for the same length of time as the preheat time.

 **WARNING**

Do not use ether or other combustable starting aid fluid on any engine equipped with an intake air preheater. If the engine is equipped with a preheater, introduction of ether or similar starting aids could cause a fire or explosion resulting in severe property damage, serious personal injury or death.

Engines not equipped with an intake air preheater may, depending on coolant temperature, take longer to start. If this should happen, DO NOT release the ignition key until the engine has started (while still observing the 15 second maximum cranking time).

**JUMP STARTING**

In order to avoid damage to solid-state electrical components, it is important that jumper (booster) cables be used correctly and only in emergencies. To jump start, use another 24 volt DC, negative grounded, power source. Use only jumper cables rated at 500 cranking amperes.

## 6-4 STARTING AND STOPPING PROCEDURES



### WARNING

Injury, explosion, battery acid damage or charging system overload may result if these jump starting procedures are not precisely followed.



### WARNING

Wear eye protection and remove rings, metal jewelry and watches with metal bands.



### WARNING

The battery could rupture or explode if jump started when the run-down battery fluid is frozen or if the battery fluid level is low. Check condition of run-down battery before attempting to jump start.



### WARNING

The gases given off by batteries while jump starting are explosive. Do not smoke near batteries.



### CAUTION

Do not let the two vehicles touch. Keep a walk-through distance between the two vehicles. Make sure positive (red) and negative (black) jumper cable clamps do not touch.



### CAUTION

Never connect the jumper cable to the negative terminal post of the run-down battery.



### CAUTION

Do not jump start if a maintenance-free battery has a yellow test indicator. Have the battery replaced.



### CAUTION

Before attempting to jump start, make sure the parking brake is applied and the transmission is in neutral (N). Turn off all lights, heaters and other electrical accessories.



### CAUTION

Choose a booster vehicle which produces comparable amperage as your vehicle.



### CAUTION

Off-board battery charger with a start boost facility must not be used to jump start the vehicle. This could damage the electrical system.

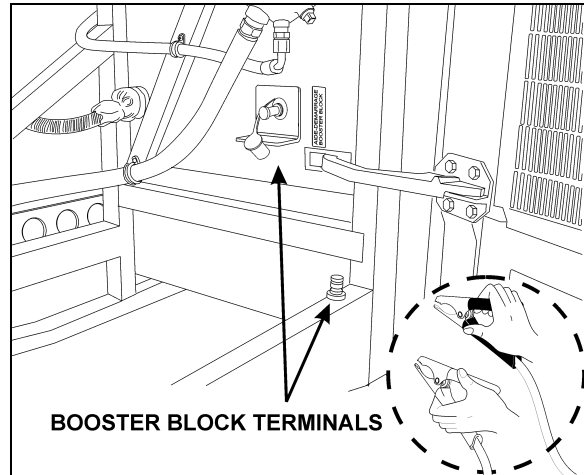

BOOSTER BLOCK TERMINALS

18645

To jump start, proceed as follows:

1. Remove the protective caps from the booster block terminals located in compartment at the right of the engine;
2. Connect one end of the red jumper cable to the positive (+) post of the booster power source. If the good battery is in another vehicle, that vehicle's engine must be shut *OFF* before connecting;
3. Connect the other end of the same red jumper cable to the positive (+) terminal on the booster block;

4. Connect one end of the black jumper cable to the negative (-) post on the booster power source;
5. Connect the other end of the same black jumper cable to the negative (-) terminal on the booster block; If the good battery is in another vehicle, start that vehicle's engine;
6. Let the engine run for a few minutes, then start the vehicle with the run-down battery;
7. Disconnect the jumper cables in reverse order given in steps 2 through 5;
8. Install protective caps on the booster block terminals.

**NOTE**

*Jumper cables must be rated at 500 cranking amperes. If jumper cable length is 20 feet (6 m) or less, use 2/0 (AWG) gauge wires. If cable length is between 20 to 30 feet (6 to 9 m), use 3/0 (AWG) gauge wires.*

**IDLE SHUTDOWN TIMER**

The idle shutdown timer (optional) is programmed to shut down the engine after a specific engine idling time. The idling time cannot be changed by the driver but can be changed with the use of a laptop computer and Premium Tech Tool. In this case, the engine idling time can be set from 30 seconds up to 1 hour.

The engine will shut down at the set time under the following conditions:

- Vehicle speed is 0
- Engine is running at normal idle speed
- Engine coolant temperature above 120°F (49°C)
- Parking brake applied
- Transmission into neutral (N)
- Wheelchair lift system not in use

Pressing the fuel pedal will prevent engine shutdown and restart countdown.

**ENGINE BLOCK HEATER**

The vehicle is equipped with an engine immersion-type electric block heater to assist cold weather starting. A connector is located on the engine compartment curbside door. Using an extension cord, connect to a 120 VAC outlet.



**CAUTION**

Connect only to a 120 VAC power source. Use only grounded (three prongs) extension cords with a minimum rated capacity of 15 A. Disconnect the extension cord before starting. Before driving, make sure the extension cord is disconnected.

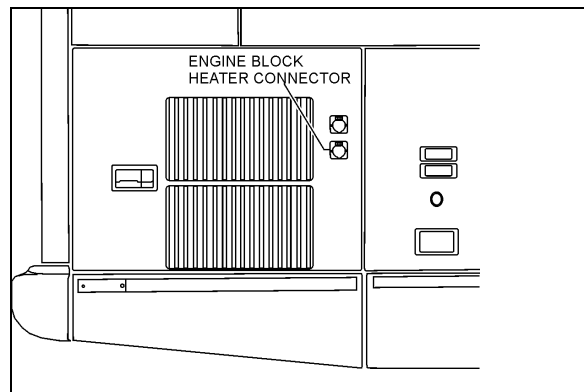

120 VOLTS CONNECTOR

18443

**ENGINE WARM-UP**

After starting the engine, keep the parking brake applied and let the engine run at normal idle for two minutes to allow lubricating oil to reach the turbocharger. Increase engine speed to fast idle, using the fast idle switch located on the dashboard for five minutes, without loading the engine. Monitor the gauges and indicator lights to make sure all conditions are normal. If an abnormal condition is observed, stop the engine immediately and have the condition corrected.



**WARNING**

Never let the engine run in an enclosed, non-ventilated area. Engine exhaust fumes contain dangerous gases which can be fatal if inhaled. Before warming up the engine, open the door(s) or move the vehicle outside.

## 6-6 STARTING AND STOPPING PROCEDURES

---

### *NOTE*

*The engine will reach normal operating temperature shortly after driving. Avoid driving at full throttle until engine coolant temperature reaches 140°F (60°C).*

### **ALLISON TRANSMISSION WARM-UP**

With an automatic transmission, when the temperature falls below -20°F (-29°C), the CHECK TRANS telltale light illuminates after the engine is started, and a reminder tone will sound. In this case, the transmission will be locked in neutral (N) until the transmission temperature rises above -20°F (-29°C) and the CHECK TRANS telltale light goes out. The transmission will only operate in first or reverse gears until it reaches normal operating temperature.

### **I-SHIFT TRANSMISSION – STARTING THE VEHICLE AT LOW TEMPERATURES**

**For outside temperatures between -4°F (-20°C) and -22°F (-30°C)**, the transmission will require a warming up phase once the engine is started. The engine must be operated for at least 10 minutes with the vehicle at a standstill until the transmission oil has warmed up.

**For outside temperatures below -22°F (-30°C)**, warm air must be used to heat the transmission up to a temperature above -22°F (-30°C) before the engine is started.