

## SECTION 5 OTHER FEATURE

<b>EXHAUST AFTERTREATMENT SYSTEM .....</b>	<b>2</b>
FILTRATION AND REGENERATION UNIT .....	2
SELECTIVE CATALYTIC REDUCTION UNIT.....	4
<b>DRIVER INFORMATION DISPLAY (DID) MENUS .....</b>	<b>9</b>
« DRIVING » MODE MENUS .....	ERREUR ! SIGNET NON DEFINI.
« NON-DRIVING/STATIONARY » MODE MENUS .....	ERREUR ! SIGNET NON DEFINI.
<b>TRANSMISSION RETARDER .....</b>	<b>19</b>
<b>ENGINE BRAKE .....</b>	<b>20</b>
EXHAUST BRAKE .....	20
VOLVO ENGINE BRAKE (VEB) .....	20
<b>ANTILOCK BRAKING SYSTEM–AUTOMATIC TRACTION CONTROL–ELECTRONIC STABILITY CONTROL.....</b>	<b>21</b>
<b>RETRACTABLE AUXILIARY AXLE .....</b>	<b>21</b>
<b>KEYLESS ENTRY SYSTEM.....</b>	<b>22</b>
KEYLESS OPERATING INSTRUCTIONS .....	22
PROGRAMMING A PERSONAL CODE .....	22
REMOTE ENTRY TRANSMITTER.....	23
<b>SLIDE-OUT OPERATION .....</b>	<b>24</b>
SAFETY PRECAUTIONS .....	24
FRONT AND REAR SLIDE-OUT OPERATION.....	24
SLIDE-OUT MANUAL OVERRIDE PROCEDURE .....	25
SLIDE-OUT TROUBLESHOOTING .....	28
TROUBLESHOOTING – OPERATING CONDITIONS, CONTROL & MECHANICAL COMPONENTS .....	29

## 5-2 OTHER FEATURES

---

### EXHAUST AFTERTREATMENT SYSTEM

The exhaust aftertreatment system consists of two units, the filtration and regeneration unit and the selective catalytic reduction SCR unit.

#### FILTRATION AND REGENERATION UNIT

The main purpose of the filtration and regeneration unit is to capture and oxidize (regenerate) the particulate matter (soot) in the engine exhaust gas. The exhaust gas first enters the Diesel Oxidation Catalyst (DOC) and then flow through the Diesel Particulate Filter (DPF); together they capture and regenerate the soot on a regular or passive basis. Through constant monitoring of the exhaust gas temperature and the system back pressure, the engine control module is able to manage regeneration.

#### Passive regeneration

Passive regeneration is the process by which the particulate matter is oxidized due to the heat generated by the engine internal combustion process. During normal highway operation, exhaust temperatures alone are usually high enough to oxidize accumulating soot. In low ambient temperatures, however, or in some stop-and-go applications, the system needs a little help to regenerate, or clean itself. This process is called "active" regeneration.

#### Active regeneration







Active regeneration is necessary when the engine internal combustion process alone does not generate enough heat. A dosing system injects a mist of diesel fuel into the exhaust system to increase and maintain the aftertreatment system temperature. Exhaust temperature must be above 572°F (300°C) to initiate the oxidation catalyst, which in turn oxidizes the injected diesel fuel molecules to achieve up to 1200°F (650°C) exhaust temperature at the particulate filter. This process of active regeneration takes place during the normal operation cycle of the vehicle without charges in performance or control for the operator. EPA2010 compliant Volvo engines produce less soot, so less active or stationary regeneration will be required.

#### Stationary (parked) regeneration

In a small number of specific engine duty cycles, engine control module may not be capable of completing an active regeneration. In these situations, the operator will be notified that a stationary or parked regeneration may be required. A DPF telltale light will illuminate indicating the need for user interaction. The lamp gives the operator a grace period to allow this process to take place at a time when most convenient for the operator. This process requires the vehicle to be parked while a driver or maintenance technician initiates the regeneration process using the DID menus. Once initiated, the stationary regeneration process will be complete in about 45 minutes.

The driver will be notified of the need for a stationary regeneration (parked) by illumination of the DPF REGENERATION telltale light.

Diesel particulate filter clogging sequence – Instrument cluster telltale light

<p><b>LEVEL 1</b></p>	 solid	<p><b>REGENERATION NEEDED</b></p> <p>Diesel particulate filter is becoming full</p> <p>The DPF REGENERATION telltale light illuminates to notify the driver that a stationary regeneration (parked) will be required soon. When this lamp is lit, initiate stationary regeneration process at an appropriate time of day. <b>THERE IS NO URGENCY AT THIS LEVEL.</b></p>
<p><b>LEVEL 2</b></p>	 flashing	<p><b>REGENERATION REQUIRED</b></p> <p>Diesel particulate filter full</p> <p>If no DPF regeneration occurs after the initial DPF REGENERATION telltale light illumination, the lamp will begin blinking and a stationary regeneration should be initiated as soon as possible in order to prevent from entering into Level 3.</p>
<p><b>LEVEL 3</b></p>	 flashing + 	<p><b>ATD SERVICE REQUIRED</b></p> <p><b>ENGINE DERATE ACTIVE</b></p> <p>Diesel particulate filter overfull</p> <p>If the flashing DPF REGENERATION telltale light is still ignored, the CHECK telltale light will illuminate. In that situation, engine performance is limited. Perform a parked regeneration IMMEDIATELY to avoid further derate and prevent from entering into Level 4.</p>
<p><b>LEVEL 4</b></p>	 flashing +  + 	<p><b>ATD SERVICE REQUIRED</b></p> <p><b>ENGINE SHUTDOWN ACTIVE</b></p> <p>A serious engine problem has occurred. The DPF may be over its maximum capacity.</p> <p>If a stationary regeneration is still not initiated, a standard Engine Protection Shutdown sequence will occur. All of the following dashboard lamps will be present:</p> <p>Blinking DPF REGENERATION telltale light;          Solid CHECK telltale light;          Solid STOP telltale light.</p> <p>Once engine derate and/or shutdown sequence is completed, a stationary regeneration must occur to continue vehicle operation. If the driver continues to operate the vehicle without regeneration, additional measures will be taken to protect the engine and ATD from damage, up to and including engine shutdown. Parked regeneration might no longer be possible.</p> <p><b>If engine protection has been initiated and forces the engine to shutdown, you CAN immediately re-start the engine and perform the necessary steps in order to initiate a stationary regeneration.</b></p>

## 5-4 OTHER FEATURES

### Initiating a Stationary (Parked) Regeneration

#### NOTE

At starting of the engine, if a stationary regeneration is required, the engine coolant temperature must reach 140°F (60°C) before any stationary regeneration may be initiated and completed. Permit the engine to idle for a short while or drive the vehicle until engine temperature increases sufficiently.



#### WARNING

Do not initiate a stationary regeneration in a closed area like a garage. Stationary regenerations must be undertaken outdoors only.



#### WARNING

During stationary regeneration, exhaust temperature may reach up to 1200°F (650°C) at the particulate filter. Before initiating stationary regeneration, make sure that the DPF outlet diffuser is clear of objects and that no one is working near the DPF outlet diffuser.



#### WARNING

Hot surfaces. Keep yourself clear of all hot Aftertreatment Device components, particularly during and after active or stationary regeneration. Hot surfaces can cause serious burns.

#### NOTE

#### STATIONARY REGENERATION

This process requires the vehicle to be parked while the driver or a maintenance technician initiates the regeneration process.

The DPF REGENERATION telltale light illuminates to notify the driver of the need and urgency of a manual stationary regeneration.



DPF REGENERATION telltale light

If stationary regeneration is not performed, this telltale light will blink, indicating that a stationary regeneration is required immediately. If stationary regeneration is still not performed,

“engine power derate and shutdown” sequence may occur as per level 1 to level 4 sequence.

To initiate a stationary regeneration:

- Park the vehicle in a clear area, vehicle speed must be 0 mph (0 km/h);
- Engine must be on normal idle and fully warmed up (coolant temperature above 140°F/60°C);
- Apply service brakes and set the transmission to the neutral (N) position.
- Press the DID ENTER button and then get to the DID Aftertreatment menu. Select sub-menu Request Parked REGEN and press ENTER button to confirm and initiate regeneration.

The regeneration will begin. Turn off the air conditioning to reduce engine load. The engine idling speed will increase to 1600 rpm. Once the regeneration is completed, the engine speed will return to normal idle.

### Voluntary Interruption of a Stationary Regeneration

It is possible to interrupt a stationary regeneration at all time. To do so, set the ignition key to the OFF position or get to the DID's Aftertreatment menu, select Cancel REGEN and press ENTER button to confirm. You can stop regeneration simply by releasing the parking brake. Use this procedure in order to move the vehicle in a safe area.

If regeneration is interrupted, it is very important to reinitiate the regeneration as soon as possible.

### SELECTIVE CATALYTIC REDUCTION UNIT

Selective Catalytic Reduction (SCR) is a technology that uses Diesel Exhaust Fluid (DEF) and a catalytic converter to reduce nitrogen oxides (NOx) emissions.

SCR is an exhaust aftertreatment system that injects small amount of DEF into the exhaust gas between the DPF and the selective reduction catalytic converter. DEF turns to ammonia and carbon dioxide when heated. The exhaust stream then passes over a catalyst, the ammonia reacts with the NOx to form nitrogen and water vapor.

The basic elements of the SCR system consist of a 15.9 gallons (60 liters) DEF tank complete with pump, lines and heating system, a dosing

injector, a catalytic converter and the control and monitoring system.

### Diesel exhaust fluid DEF

When handling DEF solution, it is important that electrical connectors to be connected or well encapsulated, otherwise there is a risk that the DEF will cause oxidation that cannot be removed. Water or compressed air will not help, since DEF quickly oxidizes certain metals. If a disconnected connector comes into contact with the DEF solution, it must be replaced immediately to prevent the DEF solution from creeping further into the copper wiring, which takes place at a speed of about 2.4 in (60 mm) per hour.



### CAUTION

Diesel Exhaust Fluid (DEF) is a nontoxic aqueous solution of urea (32.5%) and ultra-pure water (67.5%). Urea is a compound of nitrogen that turns to ammonia when heated. The fluid is non flammable, and is not dangerous when handled as recommended. However, it is highly corrosive to certain metals, especially copper and brass.

When detaching hoses and components, do not spill DEF on disconnected or unsealed connectors. If DEF is spilled on a disconnected or unsealed connector, the connector must be removed immediately and replaced.

Things to know about spilt diesel exhaust fluid (DEF):

- If urea solution comes into contact with the skin, rinse with plenty of water and remove contaminated clothing.
- If urea solution comes into contact with the eyes rinse for several minutes and call for medical help if necessary.
- If inhaled breathe fresh air and call for medical help if necessary.
- Do not allow the DEF solution to come into contact with other chemicals.
- The DEF solution is not flammable. If the DEF solution is exposed to high temperatures, it breaks down into ammonia and carbon dioxide.

- The DEF solution is highly corrosive to certain metals, including copper and aluminum.
- If the DEF solution is spilled onto the vehicle, wipe off the excess and rinse with water. Spilled DEF solution can form concentrated white crystals on the vehicle. Rinse off these crystals with water.



### WARNING

DEF spilt onto hot components will quickly vaporize. Turn your face away!

### Diesel Exhaust Fluid (DEF) Consumption







DEF consumption is related to fuel consumption. In order to meet EPA2010 requirements, DEF tanks are sized so one refill will be necessary every two refills of the fuel tank.

### Selective catalytic reduction – Driver warning and inducement

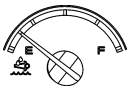
SCR system components must not be removed, altered or modified in any way. In order to protect the SCR system from tampering, inducement measures will occur if the following states are detected:

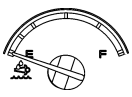
- Disconnection of DEF tank level sensor
- Blocked DEF line or dosing valve
- Disconnection of DEF dosing valve
- Disconnection of DEF pump
- Disconnection of SCR wiring harness
- Disconnection of NOx sensor

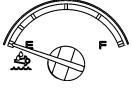
## 5-6 OTHER FEATURES



DEF TANK LEVEL DRIVER WARNING AND INDUCEMENT			
CONDITION	TELLTALE LIGHT AND MESSAGE IN THE DRIVER INFORMATION DISPLAY	INDUCEMENT	
<p>There is only 2.6 gallons (10 liters) of DEF remaining in the tank. The actual DEF level gauge indicates about 12% DEF remaining</p> 	 lighted solid	<p><i>message:</i></p> <ul style="list-style-type: none"> <li>• DEF TANK LEVEL LOW</li> <li>• REFILL DEF SOON TO PREVENT ENGINE DERATE</li> </ul>	<p>none</p>
<p>There is only 0.8 gallons (3 liters) of DEF remaining in the tank. The actual DEF level gauge hand points to "E"</p> 	 flashing	<p><i>message:</i></p> <ul style="list-style-type: none"> <li>• DEF TANK EMPTY</li> <li>• REFILL DEF TO AVOID 5 MPH LIMIT</li> <li>• ENGINE IN DERATE</li> </ul>	<p>Engine torque reduction of 25% for 1 hour then 40% torque reduction</p>
<p>The DEF tank is empty and the DEF level gauge hand points to "E"</p> <p><b>moreover</b></p> <p>a diesel fuel refueling is done and the diesel fuel level gauge increases <u>more than</u> 15% (approx. 34 gallons/130 liters)</p> <p><b>or</b></p> <p>the vehicle remains stationary (speed=0) for 20 minutes with engine off or at idle</p> 	 flashing	<p><i>message:</i></p> <ul style="list-style-type: none"> <li>• VEHICLE SPEED LIMITED TO 5 mph (8 km/h)</li> <li>• REFILL DEF TANK</li> </ul>	<p>Vehicle road speed limited (RSL) to 5 mph (8 km/h)</p> <p><i>Note: The vehicle has to remain stationary before 5 mph (8 km/h) road speed limit becomes active</i></p>

DEF QUALITY DRIVER WARNING AND INDUCEMENT			
CONDITION	TELLTALE LIGHT AND MESSAGE IN THE DRIVER INFORMATION DISPLAY		INDUCEMENT <sup>(1)</sup>
Poor DEF quality <sup>(2)</sup> detected (dilution)  Emission of initial diagnostic troubleshooting code (DTC)	<b>CHECK</b>  lighted solid	<i>message:</i> <ul style="list-style-type: none"> <li>SCR PERFORMANCE LOW</li> <li>ENGINE WILL DERATE IN XXX MINS</li> </ul>	none
1 hour after poor DEF quality detection (chronological time after the initial tampering DTC emission)	<b>CHECK</b>  lighted solid	<i>message:</i> <ul style="list-style-type: none"> <li>SCR PERFORMANCE LOW</li> <li>ENGINE IN DERATE</li> <li>5 mph (8km/h) LIMIT IN XXX MINS</li> </ul>	Engine torque reduction of 25%
3 hours after poor DEF quality detection (chronological time after the initial tampering detection)  <p style="text-align: center;"><b>moreover</b></p> a diesel fuel refueling is done and the diesel fuel level gauge increases <u>more than</u> 15% (approx. 34 gallons/130 liters)  <p style="text-align: center;"><b>or</b></p> the vehicle remains stationary (speed=0) for 20 minutes with engine off or at idle.	<b>CHECK</b>  lighted solid	<i>message:</i> <ul style="list-style-type: none"> <li>SCR PERFORMANCE LOW</li> <li>REPAIR NEEDED</li> <li>5 MPH LIMIT NEXT VEHICLE STOP</li> </ul>	Engine torque reduction of 40%
			<ul style="list-style-type: none"> <li>SERVICE SCR SYSTEM</li> <li>VEHICLE SPEED LIMITED TO 5 mph</li> </ul>
<p><b>Conditions to temporarily exit the 5 mph (8 km/h) road speed limit inducement</b></p> <p><b>First engine restart:</b> At the first engine restart, the engine returns to the 25% torque reduction until proper DEF quality evaluation occurs. If poor DEF quality is detected during the next monitoring cycle then the 8 km/h (5 mph) speed limitation will resume after vehicle is stationary for 20 minutes.</p> <p>After the second engine restart, Premium Tech Tool is required to exit the 5 mph (8 km/h) RSL.</p> <p><b>With Premium Tech Tool:</b> Invoke 25% torque reduction until proper DEF quality evaluation occurs. If poor DEF quality is detected during the next monitoring cycle then the 8 km/h (5 mph) speed limitation will resume after vehicle is stationary for 20 minutes.</p> <p>Repeating poor DEF quality within 40 hours since correction will resume the inducement stage.</p> <p>If correction occurs during road speed limitation, repeating poor DEF quality will invoke immediate 25% engine torque reduction, then 5 mph (8 km/h) road speed limitation upon vehicle stationary state of 20 minutes.</p>			

<sup>1</sup> Correcting the poor DEF quality condition will exit inducement

<sup>2</sup> Based on a confirmed NOx sensor evaluation of measured versus predicted SCR NOx conversion

## 5-8 OTHER FEATURES

SCR SYSTEM TAMPERING DRIVER WARNING AND INDUCEMENT		
CONDITION	TELLTALE LIGHT AND MESSAGE IN THE DRIVER INFORMATION DISPLAY	INDUCEMENT <sup>(3)</sup>
Tampering detected Tampering DTC confirmed	 lighted solid	<ul style="list-style-type: none"> <li>• SCR SYSTEM FAULT</li> <li>• ENGINE WILL DERATE IN XXX MINS</li> </ul> <p>none</p>
1 hour after tampering DTC detection (chronological time after the initial tampering DTC emission)	 lighted solid	<ul style="list-style-type: none"> <li>• SCR SYSTEM FAULT</li> <li>• ENGINE IN DERATE</li> <li>• 5 mph (8km/h) LIMIT IN XXX MINS</li> </ul> <p>Engine torque reduction of 25%</p>
3 hours after tampering detection (chronological time after the initial tampering detection)	 lighted solid	<ul style="list-style-type: none"> <li>• SCR SYSTEM FAULT</li> <li>• 5 MPH LIMIT NEXT VEHICLE STOP</li> </ul> <p>Engine torque reduction of 40%</p>
<p><b>moreover</b></p> <p>a diesel fuel refueling is done and the diesel fuel level gauge increases <u>more than</u> 15% (approx. 34 gallons/130 liters)</p> <p><b>or</b></p> <p>the vehicle remains stationary (speed=0) for 20 minutes with engine off or at idle.</p>		<ul style="list-style-type: none"> <li>• SCR SYSTEM FAULT</li> <li>• VEHICLE SPEED LIMITED TO 5 mph</li> </ul> <p>Vehicle road speed limited (RSL) to 5 mph (8 km/h)</p> <p><i>Note: The vehicle has to remain stationary before 5 mph (8 km/h) road speed limit becomes active</i></p>
<p>Correcting the SCR tampering condition will exit inducement.</p> <p>Repeating SCR tampering within 40 hours since correction will resume the inducement at the same inducement stage and timer status existing at the time of correction.</p> <p>If correction occurs during road speed limitation, repeating tampering will invoke immediate 25% engine torque reduction, then 5 mph (8 km/h) road speed limitation upon vehicle stationary state of 20 minutes.</p>		

<sup>3</sup> Correcting the poor DEF quality condition will exit inducement



## DRIVER INFORMATION DISPLAY (DID) MENUS

There are Driving and Non-Driving menus. Several sub-menus are password-protected while the vehicle is parked. The Non-Driving menu is accessible only when the vehicle is parked.

DRIVING MODE MENUS	NON-DRIVING/STATIONARY MODE MENUS
<b>Gauges</b> <ol style="list-style-type: none"> <li>1. Current Gear Position (I-Shift)</li> <li>2. Outside Temperature</li> <li>3. Engine Oil Temperature</li> <li>4. Transmission Fluid Temperature</li> <li>5. Prevost Liaison Compass</li> <li>6. Accessories Air Pressure</li> <li>7. A/C Compressor Pressure</li> <li>8. Battery Voltage</li> <li>9. Allison Transmission Oil Life</li> </ol>	<b>Display Settings</b> <ol style="list-style-type: none"> <li>1. Language</li> <li>2. Units</li> <li>3. Time/Date</li> <li>4. Favorite Display Setting</li> <li>5. Display Light</li> <li>6. Change Password</li> </ol>
<b>Fuel Data</b> <ol style="list-style-type: none"> <li>1. Fuel Flow</li> <li>2. Trip Fuel Used</li> <li>3. Distance to Empty</li> </ol>	<b>Diagnostics</b> <ol style="list-style-type: none"> <li>1. View Active Faults</li> <li>2. View Inactive Faults</li> <li>3. Cluster Self Test</li> <li>4. Part Number</li> <li>5. Reset Inactive Faults</li> <li>6. Vehicle Tests</li> </ol>
<b>Time-Distance</b> <ol style="list-style-type: none"> <li>1. Time and Date</li> <li>2. Alarm Clock</li> <li>3. Trip Odometer 1 and 2</li> <li>4. Average Trip Speed</li> <li>5. Estimated Time of Arrival (ETA)</li> </ol>	<b>Pre-Trip Assistance</b> <ol style="list-style-type: none"> <li>1. Exterior Light Inspection</li> <li>2. Air Leakage Monitor</li> </ol>
<b>Prevost Liaison</b> <ol style="list-style-type: none"> <li>1. Read Message</li> <li>2. Send Message</li> <li>3. Other Info</li> </ol>	<b>Datalog</b> <ol style="list-style-type: none"> <li>1. Vehicle ID</li> <li>2. Total Data</li> <li>3. Trip Data</li> <li>4. Reset Trip Data</li> </ol>
<b>Vehicle Messages</b>	<b>Aftertreatment</b> <ol style="list-style-type: none"> <li>1. Request Parked REGEN</li> <li>2. ATS Status</li> <li>3. Cancel REGEN</li> </ol>
<b>Reset Trip Data</b>	<b>Password</b> <ol style="list-style-type: none"> <li>1. Enter Password</li> </ol>

## 5-10 OTHER FEATURES

### « GAUGES » MENU

There are several gauges in this menu. The gauges are used to view current status of important functions in the vehicle.

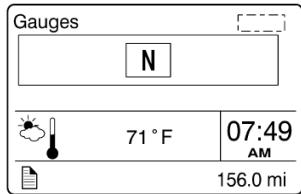

#### 1. Current Gear Position (I-Shift transmission)

Indicates the current gear position selected on the I-Shift transmission.

D= drive

N= neutral

R= reverse

M= manual

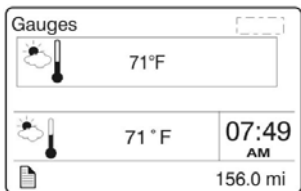

#### 2. Outside Temperature

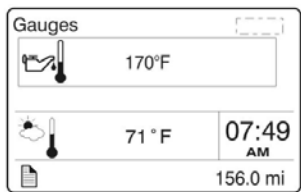

#### 3. Engine Oil Temperature

Selecting this gauge will display the engine oil temperature.

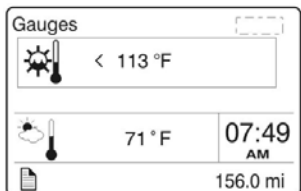

#### 4. Transmission Fluid Temperature

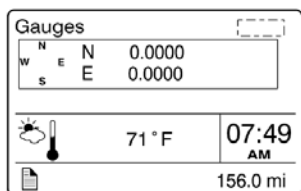

#### 5. Compass

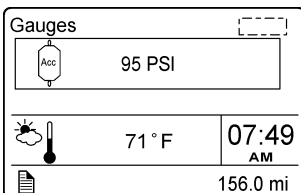

#### 6. Accessories Air Pressure

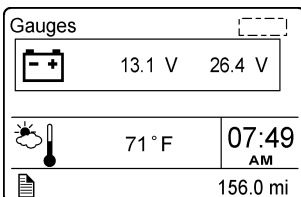

#### 7. Battery Voltage

Displays current 12-volts and 24-volts system voltage.

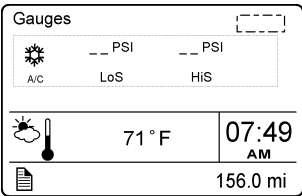

**8. A/C Compressor Pressure**

Displays the A/C compressor suction pressure value (LoS=low side) and discharge pressure value (HiS=high side).

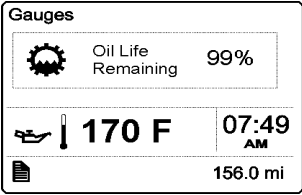

**9. Allison Transmission Oil Life**

Displays the percentage of the calculated remaining life of the transmission oil. New oil is displayed as 99%. Refer to Appendix C for more details.

**« FUEL DATA » MENU**

The Fuel Data menu provides information on the fuel consumption of the vehicle in various situations. For example, how much fuel has been used, how much fuel is remaining before refueling the vehicle.

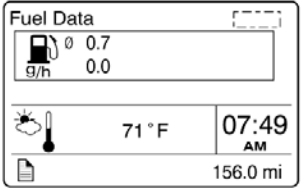

**1. Fuel Flow (gph)**

The lower numerical value indicates the instantaneous fuel consumption. In this menu, you can reset the upper numerical value which is the average fuel consumption. To reset, hold ENTER button for 1 second.

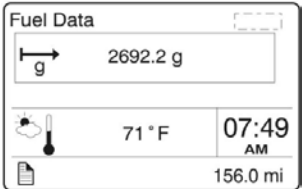

**2. Trip Fuel Used**

Indicates the total fuel consumption since the last reset. Note: Use Reset function before each new trip.

You can reset the fuel consumption value in this menu. To reset, hold ENTER button for 1 second.

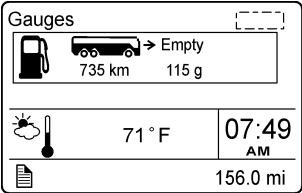

**3. Distance to Empty**

The left numerical value indicates the distance that can be traveled with the quantity of fuel that remains in the tank as indicated by the right numerical value.

**« TIME/DISTANCE » MENU**

The time and date can be set in the Time/Distance menu. The alarm clock can also be set from this menu. Following the alarm clock menu is the Trip Odometer 1 and 2 selection, which allows the operator to see the distance to travel before destination. Average trip speed is also shown. By specifying the distance to your destination, the vehicle can calculate the estimated time of arrival (ETA).

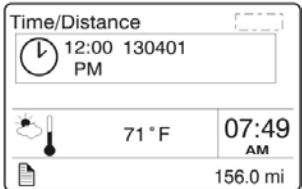

**1. Time And Date**

Adjust time and date with this menu. The instrument cluster has its own internal battery, so the date and date setting is keep in memory even if the vehicle's battery is disconnected.

## 5-12 OTHER FEATURES

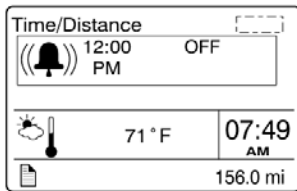

### 2. Alarm Clock

Use this function to program and activate an alarm on the instrument cluster clock. When the alarm clock goes off, a warning signal is sounded. The alarm shuts off after 60 seconds or if the ESCAPE button is depressed.

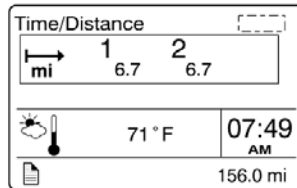

### 3. Trip Odometer 1 and 2

Allows the operator to see the distance travelled since the last reset. You can reset the trip odometer 1 or 2 in this menu. To reset, depress ENTER button, use UP/DOWN button to select between odometer 1 or 2 and then hold ENTER button for 1 second.

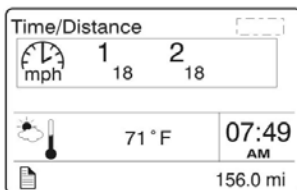

### 4. Average Trip Speed

This function displays the average speed for the current travel. The average trip speed is calculated as the distance traveled divided by the time the engine has been running (since the last reset). Two average trip speeds can be measured, corresponding to leg 1 and leg 2. Use Reset function before each new travel to start new measurements.

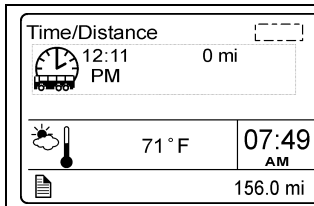

### 5. Estimated Time of Arrival (ETA)

This function will display the estimated time of arrival if the distance to be traveled is entered first, in this menu. To set distance to be traveled, press ENTER and enter the distance left to drive in mile or km using ENTER and UP/DOWN buttons.

## « PREVOST LIAISON (option) » MENU

The Prevost Liaison system provides cellular communication between the driver and the fleet operator. The driver can send and receive short text messages, which are visible through the Driver Information Display.

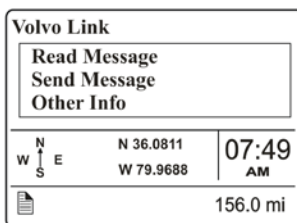

The following menus are available:

1. **Read Message**
  - Quick Response (only available if there is a message available)
2. **Send Message**
  - Driver & Equipment
  - Dispatch Messages
  - Free Text
3. **Other Info**
  - Comm Liaison Info
  - Mailbox Info
  - GPS Info
  - INI Info
  - Configuration Info

« VEHICLE MESSAGES » MENU

Use this function to consult the vehicle active messages that were previously displayed as pop-up messages and then acknowledged. When consulting a message, the corresponding STOP, CHECK or INFORMATION warning light will illuminate. Scroll through the messages using the up/down button. Press ESC button to return to main menu.

« RESET TRIP DATA » MENU

When the Reset Trip Data menu is open, pressing and holding down the Enter button for more than 1 second resets the functions listed below. This function will permit to the system to calculate new value from the point of resetting.

- Fuel Flow
- Trip Fuel Used
- Average Trip Speed

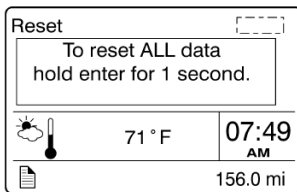

« DISPLAY SETTINGS » MENU

The Display Settings menu is used to change languages and units. The password, time and date can also be changed. The backlight and contrast of the display screen can be adjusted.

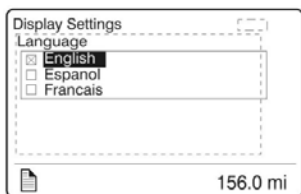

1. Language

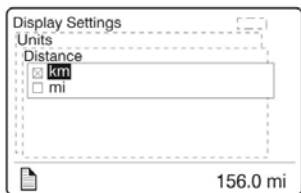

2. Units

Use this function to select desired unit formats for:

- Distance (miles or km);
- Fuel consumption (km/l, l/100km, mpg US or IMP);
- Temperature (°C or °F).

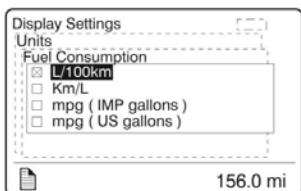

## 5-14 OTHER FEATURES

---

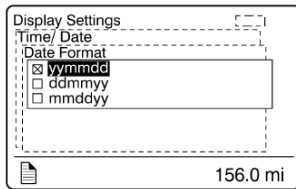

### 3. Time/Date

Select the time and date format (am, pm, 24h) using this function.



### 4. Favorite Display Setting

Use this menu to select your favorite display gauges 1, 2 and 3 and replace the default gauges. On vehicles provided with the I-Shift transmission, Favorite Display Gauge 3 cannot be edited as it is kept for display of the transmission status.

Example: You wish to display the engine oil temperature at the Gauge 1 position.

1. Use UP/DOWN button until Gauge 1 position is selected.

2. Press ENTER button to confirm.

Use UP/DOWN button to scroll through the available gauges. When the engine oil temperature gauge is displayed, press ENTER button to confirm (repeat steps 1-3 to change Gauge 2 and Gauge 3 if needed).

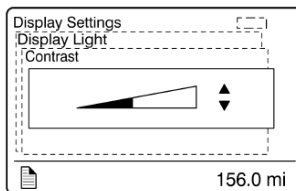

### 5. Display Light

The Display Light menu has three sub-menus:

#### • Contrast

Adjust the contrast with the UP/DOWN button and press ENTER button to confirm.

#### • Backlight

In this menu, the display lighting can be adjusted relative to other instrument lighting with the UP/DOWN button.

#### • Night/Day

Use the Night/Day menu to choose a dark background with light text and images or a light background with dark text and images. Press ENTER button to toggle between Night and Day.

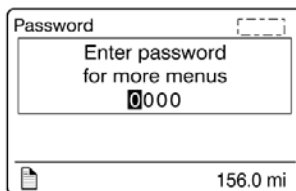

### 6. Change Password

Use this menu to change the current password. This menu is only accessible if the correct password is entered. The default password is 0000.

1. Mark which password is to be changed with the display UP/DOWN button.

2. Confirm with ENTER button.

3. Set the first digit with the UP/DOWN button.

4. Step to the next digit using ENTER button.

5. Step backwards with ESC button.

## « DIAGNOSTICS » MENU

---

The Diagnostics menu enables fault tracing on the control units in the vehicle to check for faults. Instrument tests are available to check the telltales, gauges, display and speaker. The part number of a control unit can be identified in the part number menu.

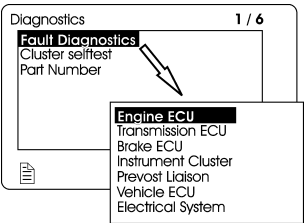

**1. View Active Fault**

A list of the control units on the vehicle is displayed. Use this function to check for active faults on specific control units.

**2. View Inactive Fault**

Use this function to check for inactive faults on specific control units.

**3. Cluster Selftest**

Use this menu to check proper functioning of the following components:

- Telltale lights
- Analog gauges
- Display
- Speakers

The following table describes the available tests. To cancel a test, press the ESC button).

Telltale lights test	Telltale lights illuminate for approximately five seconds. Press the Esc button to cancel the test.
Analog gauges	The indicators move forwards and backwards between the end positions. They do not show any particular value. This is just a check to confirm that the indicators move, and to make sure the operators are working. Press the Esc button to cancel the test.
Display test	The entire display lights up until the Esc button is pressed.
Speaker Test	A sound is emitted through the speakers. Press the Esc button to cancel the test.

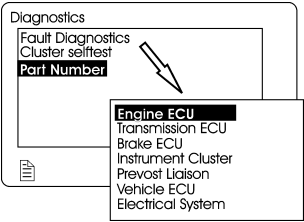

**4. Part Number**

A list of the control units on the vehicle with their part numbers is displayed in the Part Number menu.

**5. Reset Inactive Faults**

Use this menu to delete an inactive fault for a particular control unit. Note: it is not possible to delete inactive faults of the Engine ECU.

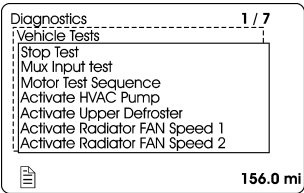

**6. Vehicle Test**

Use this menu to perform tests on several components and systems:

- dashboard switches (Mux Input Test)
- electric motors, valve and pump contactors (Motor Test Sequence)

In case of overheating of the engine due to a malfunction of the radiator fan clutch control, you can force activation of the fan clutch using ACTIVATE RADIATOR FAN SPEED 1, SPEED 2.

The DID status line will show TEST to confirm that one of the test modes is active. To cancel an active test, turn the ignition switch to the OFF position or press ESCAPE button, select STOP TEST submenu and then press ENTER button twice. "TEST" will disappear from the DID status line.

## 5-16 OTHER FEATURES

For further information concerning these functions, refer to section 06: Electrical, under “Troubleshooting And Testing The Multiplex Vehicles” paragraph of the Maintenance Manual.

### « PRE-TRIP ASSISTANT (option) » MENU

The Pre-Trip Assistance option is a tool to assist the driver in completing the pre-trip inspection of the vehicle. This option is not a substitute for a complete pre-trip inspection. If any system of the vehicle does not pass inspection, the error must be corrected before operating the vehicle. The available pre-trip tests include the Exterior Light Inspection check, and the Air Leakage check.

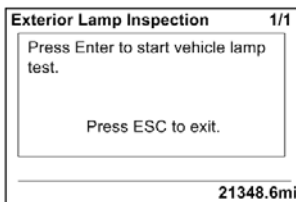
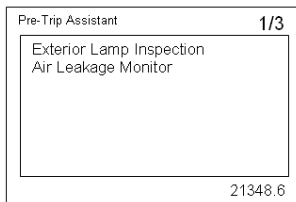

#### 1. Exterior Light Inspection

The Exterior Light Inspection function turns on all the exterior lights simultaneously. This allows the operator to start the test, exit the vehicle and do a visual check that all exterior lights function properly. Press ESCAPE button to end the test and turn off all the exterior lights.

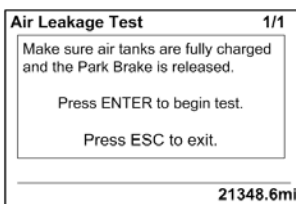
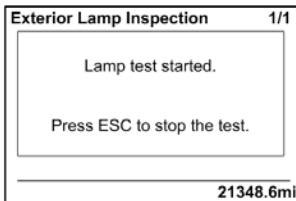

#### 2. Air leakage Monitor

The Air Leakage check allows the driver to accurately measure the amount of air pressure drop in the front and rear brake air systems. After selecting this test from the DID, you are prompted to apply the service brake for 60 seconds. After applying and holding the service brake for 60 seconds, the DID will display the amount of pressure drop in the brake system.

Before starting the test through the DID, complete the following:

- Start the engine and check that the brake systems air pressure is greater than 100 psi.
- Turn engine off.
- Release the brakes and allow the system to settle (air gauge needle stops moving).
- Press the ENTER button to start the test.
- If the air tanks pressure is too low to perform the test (pressure must be greater than 100 psi), the following messages will appear.

Primary Brake Pressure < 100 psi.  
Unable to perform Air Leakage Test.



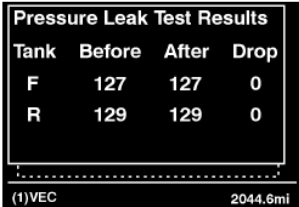
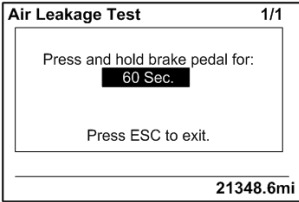
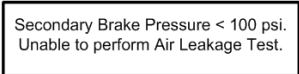

- f. You must press and hold brake pedal for 60 seconds, as instructed.
- g. Once the brake pressure test is completed the pressure leak test results are displayed.

« DATA LOG » MENU

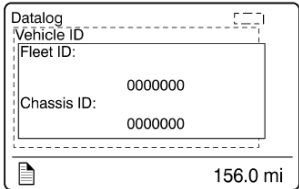

1. Vehicle ID

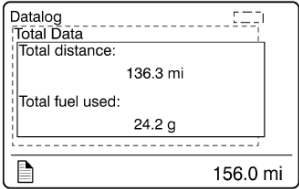

2. Total Data

Total Data menu indicates the accumulated engine values that have been logged during the lifetime of the engine ECU.

Available information:

- Total distance traveled
- Total fuel used
- Total engine hours
- Total idle time
- Total PTO hours
- total engine revolutions

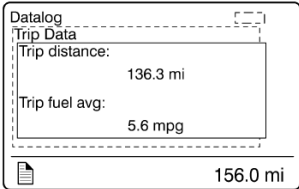

3. Trip Data

This menu displays the trip information listed below. This function must be reset before each measurement (before each new trip or leg) using the Reset Trip Data menu.

Available information for the trip or leg is:

- Trip distance (miles or km)
- Trip fuel average (mpg, liter/100km; km/liter)
- Trip fuel used (gallons or liters)
- Trip duration on cruise control (hours)
- Trip duration with engine rpm greater than economy rpm (hours)
- Trip duration while engine rpm is greater than the desire maximum rpm RPM Limit set in Fleet Limits sub-menu (hours)
- Trip fuel used with engine rpm greater than the economy rpm (gallons/liters)
- Trip average speed (mph, km/h)

## 5-18 OTHER FEATURES

- Trip duration with speed greater than the maximum desired speed as set in Fleet Limits sub-menu (hours)
- Trip engine hours
- Trip duration on engine idle (hours)
- Trip fuel used while in engine idle (gallons, liters)

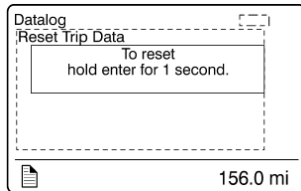

### 4. Reset Trip Data

This menu can only be accessed if the correct password has been entered. Use this function to reset measurements of the Trip Data menu before each new trip or leg.

## « AFTERTREATMENT » MENU

This menu permits to the driver to initiate a stationary regeneration, to check the status of the aftertreatment system and to interrupt regeneration.

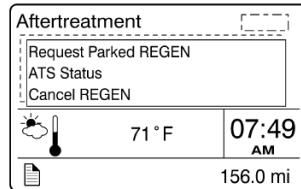

### 1. Request Parked REGEN

Use this function to initiate a stationary (parked) regeneration.

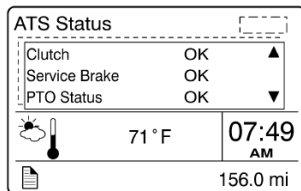

### 2. ATS Status

The Aftertreatment status sub-menus provide information about the conditions required for performing regeneration. The status can be OK (regeneration allowed), CHECK (regeneration not allowed) or N/A (not applicable). When ATS Status is selected, the following sub-menus are available.

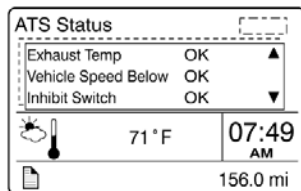
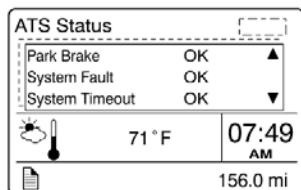
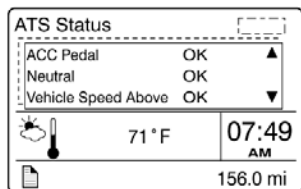

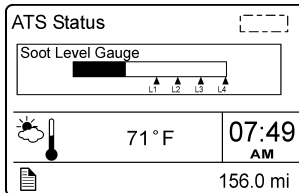
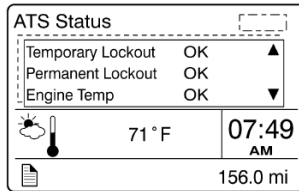

**Soot Level Gauge**

From the ATS Status sub-menu, you can view the soot level for the Aftertreatment system. When the soot level is high, regeneration is necessary. L1, L2, L3 and L4 under the scale correspond to Level 1 up to Level 4 (see Diesel particulate filter clogging sequence – Engine indicator lamp).

**3. Cancel REGEN**

From the Aftertreatment main menu, you can cancel a REGEN cycle.

**« PASSWORD » MENU**

Certain functions are password-protected. These passwords give the user access to all password-protected functions. The default password is 0000.

**1. Password**

The following menus are password-protected and marked with a key symbol in the menus:

- Change Password
- Fleet ID
- Reset Trip Data
- Fault Diagnostics
- Inactive Faults

**TRANSMISSION RETARDER**

The transmission retarder is an optional device that helps to reduce the speed of a vehicle. It improves vehicle control, increases driving safety and permits more economical operation. The retarder provides slowing power when it is most needed, such as when descending mountain roads, in stop-and-go traffic and on crowded freeways.

The transmission retarder is a vehicle-slowng device, not a vehicle-stopping device. It is not a substitute for the service braking system. The service brake must be used to bring the vehicle to a complete stop.

The retarder is provided with control buttons on the steering wheel and a lever on the steering column (refer to *Controls and instruments* chapter).

**NOTE**  
*Extended use will raise the temperature of the transmission fluid.*

The retarder helps reduce speed on grades without using the vehicle's conventional service braking system. This virtually eliminates brake overheating and reduces the risk of a runaway vehicle. A retarder greatly increases the service life of brake pads and discs, resulting in reduced brake maintenance costs.

**NOTE**

## 5-20 OTHER FEATURES

*The stoplights automatically illuminate when the vehicle is slowing down after application of the transmission retarder.*

### **NOTE**

*For vehicles equipped with the Antilock Braking System (ABS), as the wheels start to lock up on slippery roads, the output retarder automatically deactivates until the wheels roll freely.*

## ENGINE BRAKE



### **WARNING**

A vehicle speed retarding device (such as engine brake) is not intended to replace the service brake systems on your vehicle nor intended to bring your vehicle to a stop. A vehicle speed retarding device is only intended to reduce the speed of your vehicle under certain conditions.

Several types of engine brake can be installed or are standard on certain engines. All are used to reduce wear on the vehicle brake linings.



### **WARNING**

When descending significant grades, use the service brake as little as possible. If the engine does not slow the vehicle to a safe speed, apply service brake and shift to a lower range. Let the engine (and engine brake) slow the vehicle. Keep brakes cool and ready for emergency stopping.

### **NOTE**

*When driving with cruise control, the exhaust brake automatically engages if the selected cruise speed is exceeded by approximately 4 mph (7 km/h). The exhaust brake is then disengaged when the speed has returned close to selected cruise speed, provided that the engine brake was previously enabled.*

## EXHAUST BRAKE

The exhaust brake provides about 66 % of the total available engine braking power. The exhaust brake is most effective at high engine

speeds (1500 to 2300 rpm). The exhaust brake is automatically disengaged if the engine speed drops to or below 1100 rpm.

This engine brake mode provides low braking power by containing the exhaust gases in the exhaust manifold, thereby making the engine work against the back pressure. This provides a retarding force on the drive wheels.

The following must be in effect for the exhaust brake function:

- The engine brake switch found on the dashboard is set to the ON position
- The **Retarder/Engine Brake Low** (1) button on the steering wheel controls is depressed
- Accelerator pedal is fully released
- Engine speed exceeds 1150 rpm

## VOLVO ENGINE BRAKE (VEB)

VEB has a higher braking effect than the exhaust brake. This engine brake mode is most effective at high engine speeds (1500 to 2300 rpm). It is automatically disengaged if engine speed drops below 1000 rpm.

The VEB is engaged using the **Retarder/Engine Brake High** (2) button located on the steering wheel. It works together with the exhaust brake to provide to provide 100 % of the maximum available braking power.

The engine brake control on the steering wheel is achieved by the use of three buttons: OFF, LOW (1) and HIGH (2). With the Engine Brake LOW (1) button depressed, only the exhaust brake is engaged. With the Engine Brake HIGH (2) button, both the exhaust brake and the compression brake are activated.

VEB = Exhaust Brake + Compression Brake

The following must be in effect for the VEB to function:

- The engine brake switch found on the dashboard is set to the ON position
- The **Retarder/Engine Brake Low** (2) button on the steering wheel controls is depressed
- The vehicle speed is over 7.5 mph (12 km/h)
- Engine temperature is greater than 110°F (43°C)
- Accelerator pedal is fully released
- Engine speed exceeds 1150 rpm

## ANTILOCK BRAKING SYSTEM (ABS) – [AUTOMATIC TRACTION CONTROL (ATC) – ELECTRONIC STABILITY CONTROL (ESC) (OPTIONAL)]

The purpose of the Antilock Braking System (ABS) is to maintain vehicle stability and control during braking and to minimize the stopping distance in any road condition.

On slippery roads and more generally in emergency situations, over-braking frequently induces wheel locking. Wheel locking greatly increases braking distance on any road surface. Locked wheels also impede directional control and cause severe tire abrasion. An antilock braking system provides maximum braking performance while maintaining adequate control on slippery roads.

The basis of ABS is constant monitoring of wheel parameters during braking. Sensors on each wheel of the front and drive axles constantly measure wheel speed during braking. This information is transmitted to a four-channel electronic processor which senses when any wheel is about to lock. Modulating valves quickly adjust brake pressure (up to 5 times every second) to prevent wheel lock. Each wheel is therefore controlled according to the available grip.

In this way, the vehicle is brought to a stop in the shortest possible time while remaining stable and under the driver's control.



### WARNING

Vehicles following ABS-equipped vehicles may not be able to brake as fast on slippery roads.

In addition to the ABS function, advanced models of Bendix controllers may be installed (Optional) to provide an **Automatic Traction Control (ATC)** feature and also provide ABS-based stability features referred to as **Esc Electronic Stability Control**. Bendix ATC can improve vehicle traction during acceleration, and lateral stability while accelerating through curves. ATC utilizes **Engine Torque Limiting (ETL)** where the ECU communicates with the engine's controller and/or **Differential Braking (DB)** where individual wheel brake applications are used to improve vehicle traction.

The Bendix ESC system is an ABS-based stability system that enhances vehicle stability by both reducing engine throttle and by applying

vehicle braking based on actual vehicle dynamics. Accordingly, the ESC system is available only on specific approved vehicle platforms after vehicle application and development efforts and validation testing. Only certain limited variations of an approved vehicle platform are permitted without further validation of the ESC system application.



### WARNING

In the case where a vehicle equipped with the ESC system pulls a trailer, the latter must be equipped with ABS.

ESC stability system consists of Yaw Control (YC) and Roll Stability Program (RSP) features.



### CAUTION

Even with ESC-equipped vehicles, the driver remains responsible for ensuring vehicle stability during operation.

## RETRACTABLE AUXILIARY AXLE

Lifting of the auxiliary axle is controlled by a valve located on the left lateral console. The valve can be switched to either the WHEELS UP or WHEELS DOWN position. The axle will be raised or lowered by air pressure according to the position of the valve switch. Refer to Controls and Instruments chapter.

The auxiliary axle service brakes and parking brakes operate only when the auxiliary axle is in the WHEELS DOWN position. When the auxiliary axle is in the WHEELS UP position, the corresponding pictogram will appear in the DID status line. An audible alarm will sound to warn the driver if the vehicle speed exceeds 12 mph (20 km/h) with auxiliary axle raised. Lifting the auxiliary axle shortens the wheelbase and allows tighter turning. This is very useful in tight maneuvering areas like in a parking lot or when negotiating a tight corner. Raising the auxiliary axle transfers extra weight and additional traction to the drive wheels providing improved control on slippery surface when needed.



### CAUTION

## 5-22 OTHER FEATURES

Do not use auxiliary axle in raised position for an extended period. Raising auxiliary axle increases load on the drive axle, suspension and tires.

Do not drive vehicle with auxiliary axle raised when speed is exceeding 12mph (20 km/h).

In order to prevent damage to the suspension, always raise the auxiliary axle before lifting the coach.

### KEYLESS ENTRY SYSTEM

By this system, you can lock or unlock the entrance door and the baggage compartment doors. Unlocking the entrance door using the keyless entry system will also disarm the intrusion protection and anti-theft system. The keyboard is located below the outside entrance door handle. The microprocessor/relay module is pre-programmed by the manufacturer and this code can not be deleted. Moreover, you can program your own entry code.

The manufacturer's code is:

- On your owner's wallet card;
- Taped to the keyless module in the front electrical & service compartment;
- Three stickers are joined to your owner's wallet card.

When you use the keyless entry system, the keyboard illuminates. Do not push the buttons with a key, pencil or any other hard object as it could damage the buttons. Although each button is provided with two digits separated by a vertical line, there is only one contact per button. Press in center of button, i.e. between the two digits.

You must unlock the entrance door before you unlock the baggage compartment doors. If you let more than five seconds pass between the numbers you press, the system shuts down, and you have to enter your code again. If the keyless entry system does not work properly, use the key or the remote entry transmitter to lock or unlock entrance door or the baggage compartment doors.

### KEYLESS OPERATING INSTRUCTIONS

- 1) To unlock the entrance door, enter the five numbers of the code. After pressing the fifth number, the stepwell lights and entrance overhead light turn on and the door unlocks. During the night, press any

button to illuminate the keyboard and then enter the code.

When pressing any button, the keyboard lights up for five seconds.

- 2) To unlock the baggage compartment doors, press button 3-4 within five seconds after the code that unlocks the entrance door.
- 3) To lock the entrance door, the baggage compartment doors and arm the intrusion protection and anti-theft system all at the same time, press buttons 7-8 and 9-0 simultaneously.

### PROGRAMMING A PERSONAL CODE

#### *NOTE*

*To avoid erasing the code from the system memory, you should connect the keyless entry system to house batteries, otherwise the code will be erased each time battery main disconnect switches are set to the OFF position.*

You can program one personal code to unlock the entrance door and compartments. This code does not replace the permanent code that is factory programmed into the system. Use your personal code in the same manner that you would use the original code.

Do not choose a code that presents the numbers in sequential order, such as 1-2, 3-4, 5-6, 7-8, 9-0. Studies show that people who idly press the buttons usually press a sequential pattern. Also, do not select a code that uses the same button five times. Thieves can easily figure out these types of codes.

1. Choose and memorize your personal code.
2. Enter the original code, and within eight seconds, press button 1-2.
3. Within five seconds of pressing button 1-2, enter your personal code, pressing each button within five seconds of the previous digit. The keyboard light will immediately turn off if the code is correctly entered.

The keyless entry system registers your personal code. To unlock the entrance door, you can use either code.

To erase your personal code, enter the original code, press button 1-2, then wait six seconds.

**REMOTE ENTRY TRANSMITTER**

Up to four hand held (key fob) transmitters can control electronic door lock system.

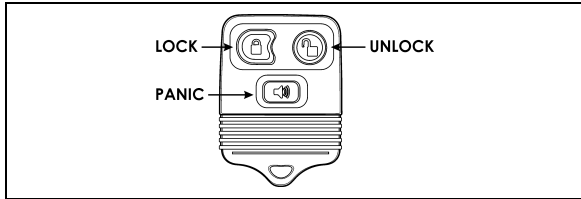

REMOTE ENTRY TRANSMITTER 23383

**To lock the entrance door and the baggage compartment doors simultaneously and arm the intrusion protection and anti-theft system:**

- Press LOCK  on the transmitter once.

**NOTE**

*The intrusion protection and anti-theft system will be set after a 30 seconds delay.*

**To confirm that the entrance door and baggage compartment doors have been locked and that the intrusion protection and anti-theft system is armed:**

- Press LOCK  again within five seconds of the first lock. The front and rear side markers will flash once if the doors have locked. If the entrance door or one of the baggage compartment doors is open, a door ajar signal prevents arming of the system.

**To unlock the entrance door:**

- Press UNLOCK  on the transmitter. This will unlock the door and disarm the intrusion protection and anti-theft system.

**To unlock the baggage compartment doors:**

- Press UNLOCK  a second time within five seconds of the first unlock.

**To set off the personal security alarm:**

- Press the red PANIC  button on any transmitter. The horn will sound and the marker lights will flash for a maximum of three minutes.

**To deactivate the personal security alarm:**

- Press the red PANIC  button again on any transmitter or turn the ignition key ON.

**NOTE**

*The remote entry features will not function*

*when the ignition is in the ON or ACC. position.*

**Programming Transmitters**

To program additional transmitters or replacing a lost or broken transmitter, all transmitters for a vehicle must be programmed at the same time. The receiver assembly module erases all previous transmitters from memory. When the transmitters are programmed or reprogrammed, the receiver assembly module can store up to four transmitters in memory.

To program or reprogram transmitters into the remote/keyless entry system, perform the following steps:

1. Make sure that the anti-theft system is not armed or triggered.
2. Turn the ignition key from OFF to ON and wait about 10 seconds. If you do not respect this 10 seconds delay, the remote entry transmitters reprogram will not be possible.
3. On the dashboard, press the Front Entrance Door Lock switch 4 times (to lock position) slowly to enter programming mode.

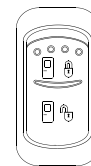

If the system has successfully entered programming mode, the horn will beep one time.

4. Press UNLOCK  on the transmitter. The horn will beep to confirm that the transmitter has been programmed.
5. Repeat step 4 for each other transmitters (up to 3 other transmitters).
6. Turn ignition OFF to exit programming mode.
7. Test each transmitter separately (try all the functions).

## 5-24 OTHER FEATURES

### SLIDE-OUT OPERATION

#### SAFETY PRECAUTIONS

Before operating both slide-out units, proceed to the following verifications:

- Make sure that the area outside the slide-out is clear and that there are no persons or objects within 3 feet of the slide-out outside wall. ***Serious personal injury or damage to the vehicle components may occur.***
- Make sure that the area inside the motor home where the room retracts (30" for the front and 24" for the rear slide-out) is free of people or obstacles. ***Serious personal injury or damage to the vehicle components may occur.***
- In temperatures below freezing point, make sure that the entire sliding surface outside the slide-out is free of snow, ice or sleet. ***Failure to clear all ice or snow may seriously damage the inflatable seal.***
- The parking brake must be applied.
- The transmission must be in the "NEUTRAL" position.
- Open a window to avoid slide-out movement restriction.
- Level the vehicle.

#### FRONT AND REAR SLIDE-OUT OPERATION

##### Preliminary condition for the slide-out operation

Before extending or retracting the slide-out, please make sure that all the following conditions are met:

1. Allow enough time for air pressure to build up.
2. Make sure the parking brake is applied and that transmission is in the NEUTRAL position.
3. Turn the ignition key to the ON position, start the engine and set the RPM to fast idle.



#### CAUTION

Prevost does not recommend operation of the slide-out with the engine being shut off.

Running the engine will assure a sufficient air pressure and reserve, and high voltage for proper operation of the slide-out.



#### CAUTION

Before extending or retracting the slide-out, always open a window to avoid movement restriction and to prevent the motor from stopping in overcurrent condition because of a vacuum or pressure build up inside the vehicle.

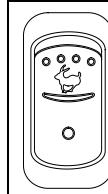

FAST IDLE BUTTON

06264

#### Slide-out extending operation

With the engine running, press and hold down the handheld control rocker switch to the OUT position. The green indicator light ROOM IN OPERATION will come on to indicate that the slide-out operation cycle is activated. The following actions will be done in sequence:

- Deflation of the inflatable seal
- Movement of the slide-out to its full OUT position

Then releasing the rocker switch will permit the following actions:

- Re-inflation of the seal

When the rocker switch is released, the green indicator light goes out. Note that for safety reasons, releasing the rocker switch will stop the slide-out movement instantly. At any time, releasing the rocker switch from the OUT position and pressing it to the IN position will reverse the operation.



#### CAUTION



The inflatable seals can be re-inflated only when the slide-out is in its full OUT or full IN position. Do not leave the slide-out in any position other than the full extended or closed position as water infiltration may occur.

**NOTE**  
*Handheld control green indicator light blinking. A green light blinking indicates an error condition or missing operation condition on the slide-out operated by this handheld control. Refer to SLIDE-OUT TROUBLESHOOTING at the end of this section if that situation occurs.*

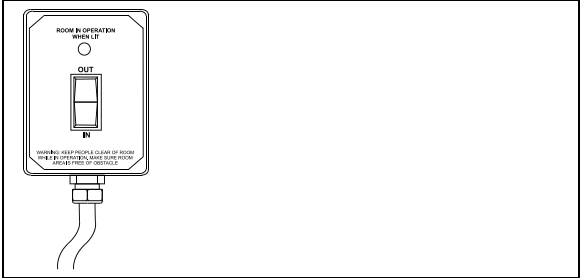

**SLIDE-OUT HANDHELD CONTROL** 26034

**Slide-out retracting operation**

With the engine running, press and hold down the rocker switch to the IN position to retract the slide-out. Note that the green indicator light ROOM IN OPERATION will come on. When the movement of the slide-out to its full IN position is completed, the rocker switch can be released to allow the re-inflation of the seal. The green indicator light goes out as the rocker switch is released. At any time during the slide-out movement, releasing the rocker switch will stop the operation instantly.

**CAUTION**  
 The inflatable seals can be re-inflated only when the slide-out is in its full OUT or full IN position. Do not leave the slide-out in any position other than the full extended or closed position as water infiltration may occur.

**SLIDE-OUT MANUAL OVERRIDE PROCEDURE**

In case of power retracting system failure, it is possible to use the manual override procedure to retract or extend the slide-out.

The manual override procedure consist in rotating the slide-out motor shaft extension using a cordless power drill with a 3/8" hexagonal bit.

However, it is very important to follow all the instructions very carefully to assure that the inflatable seal or the retraction mechanisms are not damaged.

**Preliminary conditions for manual override procedure**

Before using the slide-out manual override procedure, make sure that the problem cannot be solved by one of the following simple checks:

- Make sure that none of the breakers are tripped (slide-out circuit breakers CB9 & CB11 are located inside the main power compartment on the breaker panel).
- Make sure the parking brake is applied and that transmission is in the NEUTRAL position.
- Make sure the voltage is high enough by running the engine at fast idle or having a battery charger connected.

**CAUTION**  
 Before extending or retracting the slide-out, always open a window to avoid movement restriction and to prevent the motor from stopping in overcurrent condition because of a vacuum or pressure build up inside the vehicle.

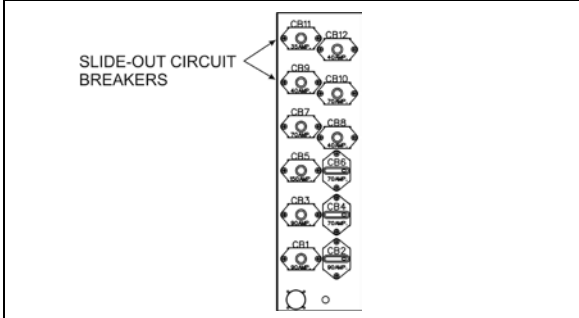

**SLIDE-OUT CIRCUIT BREAKERS CB9 & CB11 IN MAIN POWER COMPARTMENT** 26091

## 5-26 OTHER FEATURES

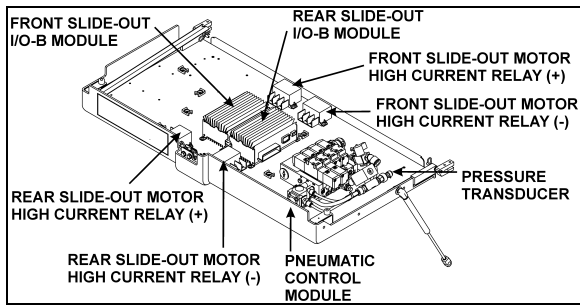

SLIDE-OUT CONTROL PANEL IN FIRST BAGGAGE COMPARTMENT  
26107

### Manual retracting procedure – Front and rear slide-out

1. Turn the ignition switch to the OFF position, and remove the ignition key for more safety.
2. Deflate the inflatable seal by using the relieving shut-off valve located on the slide-out control panel. Turn the handle clockwise to deflate the seal. Make sure the pressure indicator reading is "0 psi".



### CAUTION

The pressure in the inflatable seal must be completely relieved to prevent any damage to the seal. Also, check that the security pin is retracted so it does not stop slide-out movement.

### NOTE

When air pressure is relieved using the shut-off valve, the normal extending and retracting operation cycle is disabled, for that reason the slide-out cannot be moved using the handheld control.

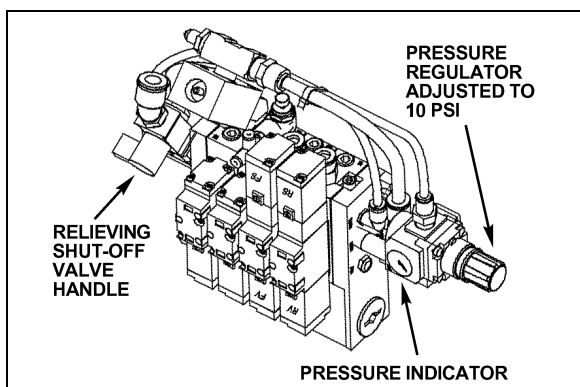

INFLATABLE SEAL RELIEVING SHUT-OFF VALVE  
26098

3. To move the slide-out, use a cordless power drill with a 3/8" hexagonal bit on the shaft extension of the slide-out motor.
4. Rotate the slide-out motor shaft extension with the cordless power drill until the slide-out comes to its closed position.
5. Once the slide-out room is lined up to its closed position, remove the tool from the motor shaft extension.

### NOTE

The **front slide-out motor** is located inside the 2<sup>nd</sup> baggage compartment while the **rear slide-out motor** is accessible from inside the vehicle, under the bed structure.

### RETRACTING

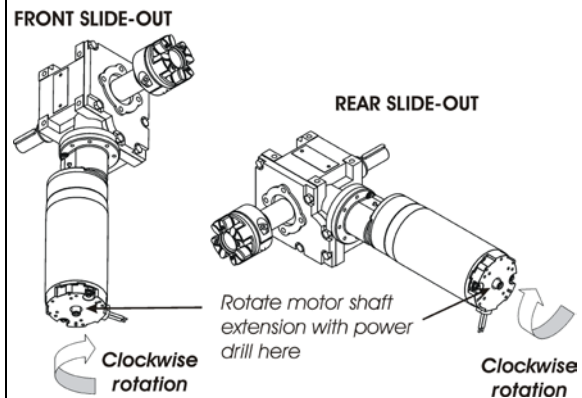

SLIDE-OUT MOTOR ROTATION

26038



### CAUTION

Slow down on the closing speed as the slide-out approaches its closed position. As soon as the "in limit" stoppers come in contact with their bearing surface, stop immediately the cordless power drill rotating movement. Not doing so could overload the drive mechanism and cause damage to the reduction gearbox.

6. Finally, the inflatable seal can be re-inflated by turning the shut-off valve handle counterclockwise. Check the pressure gage on the inflatable seal regulator to see if the pressure is increasing to 10 psi.

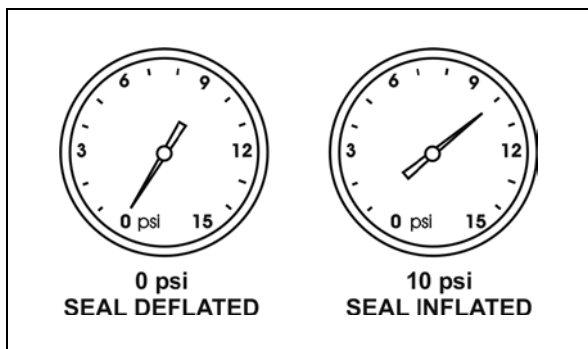

INFLATABLE SEAL PRESSURE GAGE 26108

**NOTE**

The slide-out control system inhibits transmission range selection to prevent the vehicle from moving if the slide-out is not in its full "IN" position.

**Manual extending procedure – Front and rear slide-out**

1. Apply parking brake to disengage the security pin from the receptacle.
2. Turn the ignition switch to the "OFF" position, and remove the ignition key for more safety.
3. Deflate the inflatable seal by using the relieving shut-off valve located in the slide-out control panel. Turn the handle clockwise to deflate the seal. Make sure the pressure indicator reading is "0 psi".



**CAUTION**

The pressure in the inflatable seal must be completely relieved to prevent any damage to the seal. Also, check that the security pin is disengaged from the receptacle so it does not stop slide-out movement.

**NOTE**

When air pressure is relieved using the shut-off valve, the normal extending and retracting operation cycle is disabled, for that reason the slide-out cannot be moved with the handheld control.

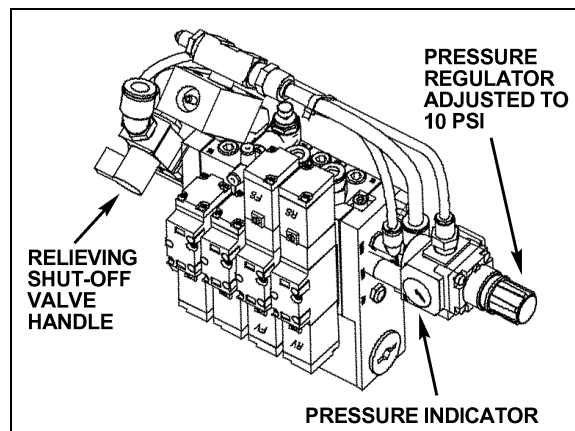

INFLATABLE SEAL RELIEVING SHUT-OFF VALVE 26098

4. To move the slide-out, use a cordless power drill with a 3/8" hexagonal bit on the shaft extension of the slide-out motor.
5. Rotate the slide-out motor shaft extension with the cordless power drill until the slide-out comes to its opened position.
6. Once the slide-out is lined up to its opened position, remove the tool from the motor shaft extension.

**EXTENDING**

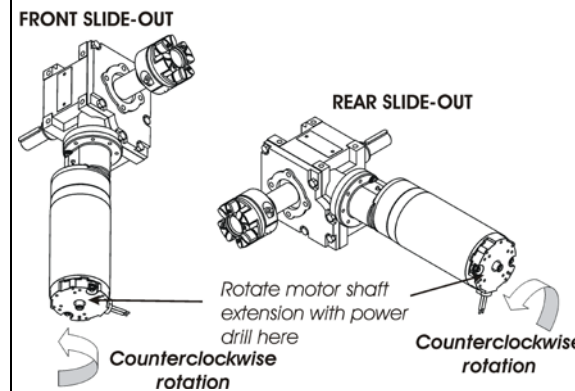

SLIDE-OUT MOTOR ROTATION 26038

**NOTE**

The **front slide-out motor** is located inside the 2<sup>nd</sup> baggage compartment while the **rear slide-out motor** is accessible from inside the vehicle, under the bed structure.

## 5-28 OTHER FEATURES



### CAUTION

Slow down on the closing speed as the slide-out approaches its extended position. As soon as the "out limit" stoppers come in contact with their bearing surface, stop immediately the cordless power drill rotating movement. Not doing so could overload the drive mechanism and cause damage to the reduction gearbox.

7. Finally, the inflatable seal can be re-inflated by turning the shut-off valve handle counterclockwise. Check the pressure gage on the inflatable seal regulator to see if the pressure is increasing to 10 psi.

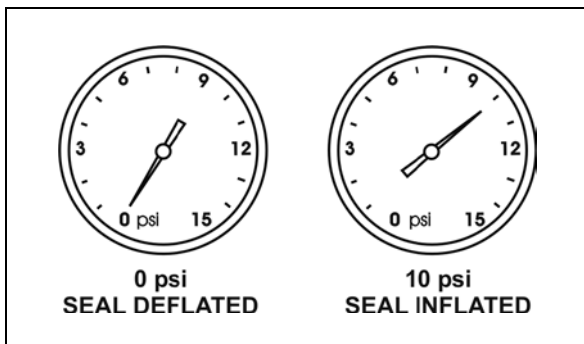

INFLATABLE SEAL PRESSURE GAGE

26108

### NOTE

*The slide-out control system inhibits transmission range selection to prevent the vehicle from moving if the slide-out is not in its full "IN" position.*

To get more specific information about the error condition or the missing operation condition, request a diagnostic from the slide-out CECM using the dashboard message center display (MCD). Check if there are active errors in the slide-out electrical system. With the SYSTEM DIAGNOSTIC menu, highlight FAULT DIAGNOSTIC and then highlight ELECTRICAL SYSTEM to request a diagnostic of the electrical system from the CECM. Press the enter key. If applicable, the MCD shows the device ID, the fault messages or fault codes recorded. When more than one fault is recorded, an arrow pointing down appears on the right of the display. Use the down arrow to see all the fault messages.

## SLIDE-OUT TROUBLESHOOTING

### Error condition or missing operation condition

When an error condition or a missing operation condition is present on a slide-out, the green indicator light on its respective handheld control starts blinking upon releasing of the IN/OUT rocker switch.

Turning the ignition OFF and ON again, will stop the blinking and reset the fault. If the error condition or a missing operation condition is still present, the blinking will start again the next time that the slide-out is operated. So, to get a fault diagnostic, use the MCD right after operating the slide-out without cycling the ignition switch.

### Fault diagnostic

Once the problem corrected, the MCD still shows the fault as being active. You have to leave the FAULT DIAGNOSTIC menu, wait approximately 20 to 30 seconds and then return to FAULT DIAGNOSTIC to request a new diagnostic of the ELECTRICAL SYSTEM from the CECM. The MCD should display the fault as being inactive.

**TROUBLESHOOTING – OPERATING CONDITIONS, CONTROL & MECHANICAL COMPONENTS**

PROBLEM	CAUSE	CORRECTIVE ACTION
<p>The slide-out functions normally but the handheld control green indicator light blinks</p>	<p>Something is defective and may eventually create an issue if not repaired. The problem may be:</p> <ul style="list-style-type: none"> <li>A. Faulty limit sensor causing the slide-out to stop in overcurrent;</li> <li>B. CAN network problem causing the transmission inhibit safety to be non-operational;</li> <li>C. Vacuum pressure transducer disconnected or damaged (vacuum is applied for a fixed time of 7 seconds);</li> <li>D. Seal inflating valve solenoid open circuit (the seal is not re-inflated and water can penetrate in the vehicle);</li> <li>E. Security pin valve solenoid open circuit (the security pin is not extended while vehicle is riding).</li> </ul>	<p>Request a diagnostic from the electrical system using the MCD SYSTEM DIAGNOSTIC menu.</p>
<p>The slide-out does not extend</p>	<ul style="list-style-type: none"> <li>A. The parking brake is not seen by the controller as being applied;</li> <li>B. Not enough air pressure in the accessory air tank to permit proper operation of the vacuum generator;</li> <li>C. Faulty vacuum generator, connection to the vacuum generator open, seal deflating valve solenoid open circuit;</li> <li>D. I/O-B module output defective, regulated 5-volt supply to sensors shorted to ground, "out limit" sensor shorted to ground, connection to the motor negative relay solenoid open circuit;</li> </ul>	<ul style="list-style-type: none"> <li>A. Make sure the parking brake is applied. Confirm parking brake application with the parking brake light on the telltale panel.</li> <li>B. Run the engine at fast idle a few minutes to increase air pressure in the accessory air tank and try again.</li> <li>C. Turn the relieving shut-off valve handle clockwise to deflate the inflatable seal, disconnect the pressure transducer. Do not forget to reconnect the pressure transducer and to close the relieving shut-off valve. Failure to do so could damage the seal and lead to water infiltration;</li> <li>D. Operate the slide-out with the manual override procedures.</li> </ul>
<p>The slide-out does not retract</p>	<ul style="list-style-type: none"> <li>A. Not enough air pressure in the accessory air tank to permit proper operation of the vacuum generator;</li> <li>B. Faulty vacuum generator, connection to the vacuum generator open, seal deflating valve solenoid open circuit;</li> </ul>	<ul style="list-style-type: none"> <li>A. Run the engine at fast idle a few minutes to increase air pressure in the accessory air tank and try again.</li> <li>B. Turn the relieving shut-off valve handle clockwise to deflate the inflatable seal, disconnect the pressure transducer.</li> </ul>

## 5-30 OTHER FEATURES

PROBLEM	CAUSE	CORRECTIVE ACTION
	C. I/O-B module output defective, "in limit" sensor shorted to ground, connection to the motor positive relay solenoid open circuit;	CAUTION, do not forget to reconnect the pressure transducer and to close the relieving shut-off valve. Failure to do so could damage the seal and lead to water infiltration;  C. Operate the slide-out with the manual override procedures.
When extending, the slide-out stops after having extended by 1 inch	A. The security pin valve solenoid circuit is shorted to (+) 24-volt and the security pin remains engaged;	A. Disconnect air supply from the security pin cylinder;
Transmission DRIVE range or REVERSE cannot be selected (the slide-out telltale light is illuminating).	A. Slide-out not in full "in" position;  B. Faulty "in limit" sensor. The slide-out is retracted but the controller doesn't see it as retracted.	A. Retract slide-out.  B. Confirm that all slide-outs are retracted. On the slide-out control panel, disconnect the 5 pins green connector on the I/O-B module to disable the transmission inhibit. CAUTION, this is a temporary measure, the vehicle must be serviced as soon as possible.
Slide-out does not retract or extend when depressing the control switch.	A. Electrical motor failure;  B. Speed reduction gearbox failure;  C. Security pin still engaged in receptacle;	A. Replace motor.  B. Inspect gearbox components, particularly: bronze wheel or first reduction stage output shaft. Replace damaged components.  C. Disengage pin and check if air cylinder is damaged.
Slide-out is not straight once retracted or during retracting or extending operation.	A. Broken rack tooth;  B. Faulty rack attachment;  C. Faulty shaft key at speed reduction gearbox or jaw coupling;  D. Pinion keyless bushing slipping;  E. Shaft breaking;  F. Flange bearing attachment loosen;	A. Replace rack.  B. Tighten mounting bolts, apply proper torque and use Loctite threadlocker (replace rack if necessary).  C. Replace key or component having a damaged keyway.  D. Realign slide-out and apply proper torque to keyless bushing.  E. Replace shaft.  F. Reposition shaft and tighten flange bearing mounting bolts.
Slide-out moves out slightly when vehicle is traveling.	A. Lower "in limit" stoppers are not leaning against the structure at the moment when the "in limit" sensor detects the magnet;	B. Adjust the sensor position in order to have contact of the stoppers against the structure at the time when the system stops the slide-out retraction.
Slide-out moves when vehicle is moving.	A. Inflatable seal not inflated	A. Check seal condition and seal air supply system.
Slide-out retracts or extends difficultly.	A. Foreign matters accumulated in the linear bearing;	A. Inspect the linear bearing end seals to see if they are in good condition. If not, replace the end seals and clean the inside of linear bearing.
Slide-out oscillates vertically when	A. Linear bearing balls hardened due to a too heavy load;	C. If balls clearance is excessive, replace linear bearing.

retracting or extending	B. Linear bearing mounting bolts loosen;	D. Tighten mounting bolts.
Slide-out vibrating or noisy when extending or retracting	A. Acetal plastic block rubbing against the slide-out structure; B. Worn-out anti-friction coating on wiper seal around slide-out; C. Lower acetal plastic block rubbing against rail;	A. Realign acetal plastic block. B. Replace wiper seal. C. Remove lower acetal plastic block and machine down 1mm (0.039").
Top of slide-out moves sideways when vehicle is moving	A. Roof reinforcing rod misadjusted;	A. Readjust as per procedure.
Slide-out does not retract up to its full "in" position	A. Interference between the exterior extrusion and the vehicle upper horizontal member above the slide-out;	A. Check for straightness of horizontal member and adjust the roof reinforcing rod. B. Check for outer wiper seal lip straightness on the slide-out roof.
Bottom of slide-out not flush with vehicle body	A. Broken or misadjusted lower "in limit" stopper; B. Lower "in limit" stoppers are not leaning against the structure at the moment when the "in limit" sensor detects the magnet; C. Acetal plastic block serving as leaning surface for lower "in limit" stopper broken or moved;	D. Replace or adjust lower "in limit" stopper. E. Adjust the sensor position in order to have contact of the stoppers against the structure when slide-out is stopped. F. Replace or adjust acetal plastic block proper position.
Top of slide-out not flush with vehicle body	A. Broken or misadjusted leveling or retaining screw; B. Faulty upper "in limit" stopper;	A. Check and replace screw. B. Replace upper "in limit" stopper.
Lower edge of slide-out not parallel with vehicle body opening	A. Faulty leveling and retaining screw (8 screws each side).	C. Inspect screw, replace and adjust slide-out level.
Watertightness problem	A. Inflatable seal and/or wiper seal damaged or unstuck; B. Insufficient air pressure in the seal; C. No air pressure in the slide-out pneumatic system; D. Sealant missing; E. Wiper seal draining hole clogged; F. Faulty water recovery pan; G. Faulty internal gutter;	A. Check both seals condition. B. Check the pressure regulator, the relieving shut-off valve and the seal valve condition. C. Check the slide-out air pressure inlet valve condition and the accessory air tank pressure. D. Check the exterior extrusion screws, the windows and the exterior panels sealant condition. E. Unclog draining hole. F. Check the recovery pan. G. Check internal gutter.
Knocking sound at end of travel when	A. Inner stoppers misadjusted;	A. Readjust the inner stoppers.

## 5-32 OTHER FEATURES

extending slide-out		
Knocking sound when parking brake is released	A. Security pin retracts too rapidly;	A. Adjust security pin air flow regulator.
Inflatable seal damaged or removed, or wiper seal unstuck from the structure.	<p>A. Slide-out has been retracted or extended with the manual procedure with the inflatable seal not deflated;</p> <p>B. Pressure transducer malfunction;</p> <p>C. Faulty roof reinforcing rod adjustment;</p> <p>D. Seal valve malfunction;</p> <p>E. Excessive load in the slide-out;</p> <p>F. Slide-out not centered in the structure opening;</p>	<p>A. Always deflate the seal when manually retracting or extending the slide-out.</p> <p>B. Check the pressure transducer condition, replace if necessary.</p> <p>C. Readjust the roof reinforcing rod.</p> <p>D. Check the seal valve condition.</p> <p>E. Reduce load or distribute load evenly in order to respect the deflection criterion and slide-out load capacity.</p> <p>F. Readjust the slide-out height and center horizontally in opening.</p>
Friction at end of travel when in full OUT position or at beginning of retraction	A. Interference between upper structure key and upper inner stopper;	A. Readjust the upper inner stopper.