

Safety Features And Equipment 117

EMERGENCY EXITS	118
ELECTRIC AWNING WINDOWS	118
ELECTRIC SLIDING WINDOWS.....	118
FIXED WINDOWS	118
EMERGENCY AIR-FILL VALVES	118
EMERGENCY AND PARKING BRAKES	119
SAFETY EQUIPMENT	119
AUTOMATIC FIRE DETECTION AND SUPPRESSION SYSTEM (ASSS)	119
TIRE PRESSURE MONITORING SYSTEM (TPMS)	120
FIRE EXTINGUISHERS	124
FIRST AID KIT	124
WARNING REFLECTORS	124
JACK AND TOOLS	125
SPARE PARTS KIT	125
CHANGING WHEELS	125
JACKING POINTS	125
HYDRAULIC JACK	126
TOWING	126
DAYTIME RUNNING LIGHTS	127
FOG LIGHTS	127
CORNERING AND DOCKING LIGHTS	127
COMPARTMENT LIGHTING	127
MUD FLAPS AND SPLASH GUARDS	127
BACK-UP CAMERA	127
BACK-UP ALARM	127
BACK-UP ALARM CANCEL SWITCH.....	127

EMERGENCY EXITS

Locate and learn how to use all possible emergency exits. Inform all guests or passengers of the location of exits and how to use them in case of an emergency.

ELECTRIC AWNING WINDOWS

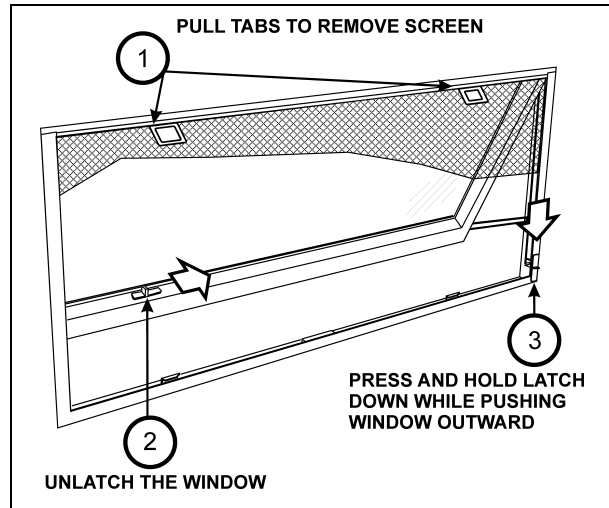

ELECTRIC AWNING WINDOW

18584

ELECTRIC SLIDING WINDOWS

Electric (power) sliding windows can be used as emergency exits.

- Remove the screen assembly,
- Pull down on both red release latches simultaneously and rotate the sash inwards approximately 10 degrees.
- Lift the sash up and out to disengage the bottom of the sash from the window frame.

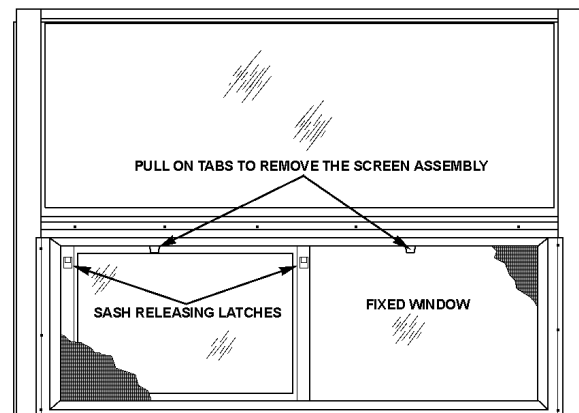

ELECTRIC SLIDING WINDOW

18206

FIXED WINDOWS

Fixed windows are glued to the structure of the vehicle; they do not open and are very hard to break. Do not attempt to open, instead find and use the entrance door, the nearest awning or sliding window or a roof escape hatch.

EMERGENCY AIR-FILL VALVES

The vehicle is equipped with two air system emergency fill valves to supplement the air system when air pressure is low and the engine cannot be operated. One valve is located inside the front service compartment. The other valve is located inside the engine compartment.

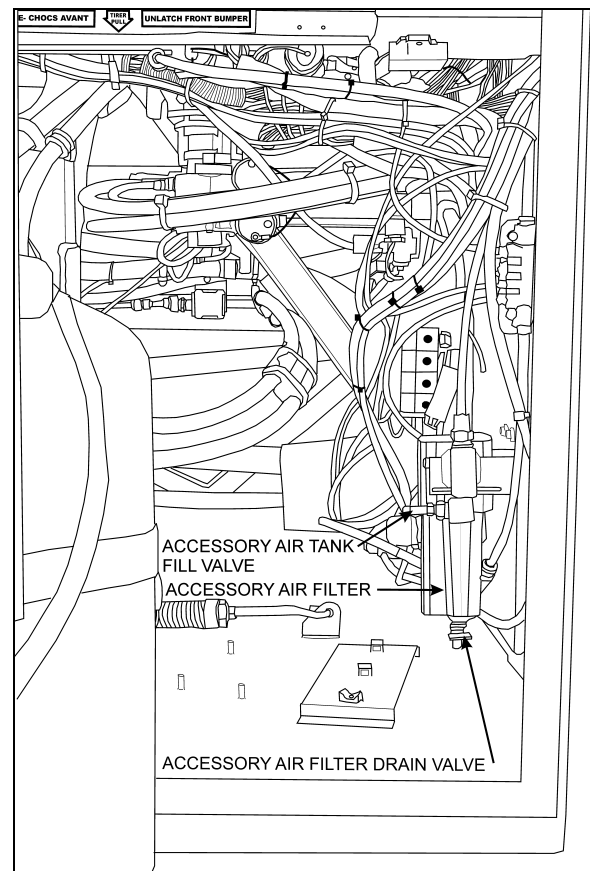

FRONT SERVICE COMPARTMENT

12218

Both air system emergency fill valves are fitted with standard tire valve stems. The air systems can be filled using any standard external air supply line. The fill valve located in the engine compartment supplies air for all systems (brakes, suspension and accessories). The fill valve located in the service compartment supplies air for accessories only.



CAUTION

Air filled through the two emergency fill valves will pass through the standard air filtering system. Do not fill air at any other location. Do not exceed 120 psi (827 kPa).

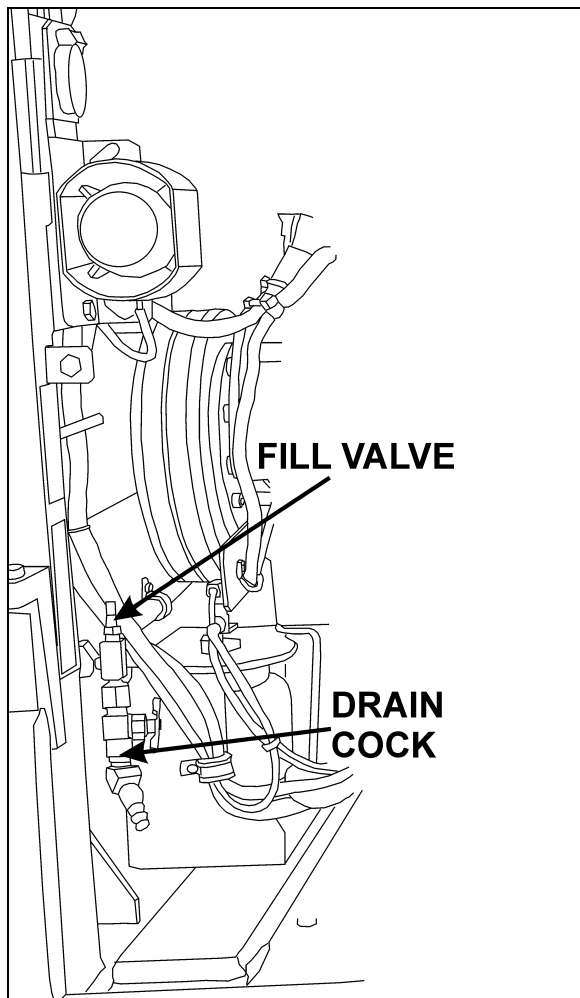

FILL VALVE IN ENGINE COMPARTMENT 12162

EMERGENCY AND PARKING BRAKES

During normal operation, if air pressure in both brake circuits drops below 40 psi (276 kPa), spring-loaded emergency parking brakes will be immediately applied at full capacity to the drive axle wheels to stop the vehicle.

Spring-loaded parking brakes are applied by pulling up the control valve knob located on the L.H. lateral console.

Parking brakes are not designed to be used as service brakes. For normal driving conditions,

the control valve knob must remain in the down position.



DANGER

Always apply the parking brakes before leaving the driver's seat.

NOTE

Only use the parking brakes to supplement the service brakes to stop the vehicle in emergency conditions. The stopping distance will be considerably longer than when using normal service brakes.

NOTE

Before releasing the parking brakes by pushing down the control valve knob, check the pressure gauges to make sure that the brake system air pressure is greater than or equal to 95 psi (655 kPa).

NOTE

A beep will sound if the ignition switch has been turned off without applying the parking brakes. The same beep will sound if pressure is still applied to the service brake pedal.

NOTE

The stoplights will automatically turn on when the parking brake is applied and the ignition key is turned to the ON position.

SAFETY EQUIPMENT

AUTOMATIC FIRE DETECTION AND SUPPRESSION SYSTEM (AFSS) (OPTIONAL)

The vehicle may be equipped with the optional Automatic Fire Detection and Suppression System (AFSS).

System operation

When a fire is detected inside the engine compartment, the system sends a fire alarm signal to the **Protection Panel** located in the Driver's area near the lateral control panel. The **Protection Panel** immediately turns on the fire "ALARM" lamp and sounds the audio alarm. After a 15-second time delay the engine is automatically shut down. The fire extinguisher is discharged simultaneously with engine shutdown.

NOTE

The **Manual Activation Switch** is used when immediate discharge of the fire extinguisher and engine shutdown is desired.

NOTE

The **Protection Panel** continuously monitors system integrity and displays the information via the “SYSTEM OK” and fire “TROUBLE” indicators.

Operational sequence (fire)

1. A fire detector or liner thermal detector detects a fire in the engine compartment and sends a signal to the **Protection Panel** in the driver’s area.
2. The fire “ALARM” lamp on the **Protection Panel** will illuminate solid red and an audible alarm will sound.
3. The operator shall bring the vehicle to a safe stop.
4. The system automatically shuts down the vehicle engine and discharges the extinguisher into the engine compartment 15 seconds after the fire alarm starts unless advanced or delayed by the operator.
 - o If the operator presses the **Manual Activation Switch**, all delays will terminate and the engine shutdown and extinguisher discharge will occur immediately.
 - o If the operator presses and releases the **Delay Engine Stop** switch once, the engine shutdown and extinguisher discharge will be delayed by an additional 15 seconds.



WARNING

The engine will stop 15 seconds after the fire alarm starts. The operator must be prepared to bring the vehicle to a safe stop as soon as the alarm sounds. Steering may become difficult after engine shutdown. If more time is required, the “DELAY ENGINE STOP” switch may be pressed and released for an additional 15 seconds delay.



WARNING

The extinguisher discharge may cause an obscuring cloud behind and near the vehicle.

5. The red fire “ALARM” lamp and audible alarm will stay on. The yellow fire “TROUBLE” lamp will also be on indicating a discharged extinguisher.
6. The system must be reset and the fire extinguisher removed and replaced in accordance with the System Reset portion of the Kidde Dual Spectrum Operation & Maintenance Manual.

TIRE PRESSURE MONITORING SYSTEM (TPMS) (OPTIONAL)

The vehicle may be equipped with the optional Tire Pressure Monitoring System (TPMS).

Description

System includes the following elements:

- Special tire valves;
- RF sensor inside each tire, fixed to the valve;
- 3 antennas to receive the sensors RF signal (one in the front spare tire compartment, one above the L.H. side rear wheels and one above the R.H. side rear wheels);
- A TPMS receiver connected to the antennas and located in the front electrical compartment, above the CECM;
- A TPMS display built in the L.H. dashboard panel;
- A “FLAT TIRE” telltale panel indicator.

The section of the special tire valves located inside the tire is dome-shaped to allow fixing the sensor.

Sensors provide continuous tire pressure and temperature reading.

The normal sensor battery lifespan is 5 years. The remaining lifespan is displayed as a percentage in the TPMS display.

NOTE

It is recommended to check the remaining battery lifespan when changing the tires in order to replace the sensors at the same time if they are due for replacement before the next change.

The screw fixing the sensor to the valve can only be used once because the threads are powder-coated to lock the sensor in place and prevent unfastening.

The telltale panel indicator illuminates for 3 seconds when the ignition switch is turned ON to check the display operation and the communication between the display and the vehicle multiplex system. This confirms the communication between the TPMS display and CECM.

Settings Menu

- Set Wheel ID

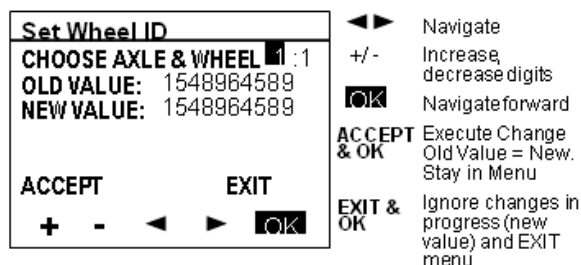
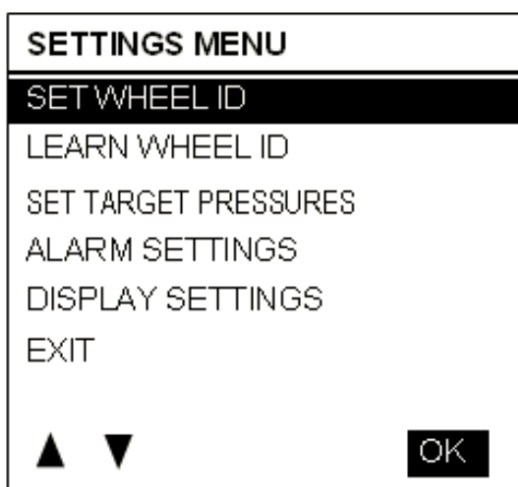

- Learn Wheel ID

This menu allows learning new wheel sensors ID. The user can learn only one wheel, several wheels or all wheels of the vehicle. The sequence automatically jumps to the next wheel such that a user can initiate all wheels without having to come back to the display between each wheel.

The display uses a pressure change as the criteria to recognize which wheel sensor the operator wants to get assigned to a given location. The amount of pressure change required is established at 2 PSI.

A pressure change of about 3 PSI is needed to wake up a sensor and then an extra amount of pressure change of 2 PSI is needed to trigger the display. The operator has to create a pressure change by at least 6 PSI and then wait for the display to recognize the pressure change. The wait time correspond to the sensor sampling rate.

When entering the menu, the axle 1, wheel 1 is selected by default as a starting point for the learning. The user can select another axle with +/- , move the cursor to the wheel number with the right arrow and select another wheel with the +/- or move the cursor down to the start learning button.

After the start learning button is selected, the display stores the first transmission it gets from each sensor ID into the "initial pressure" for that sensor ID. Then it compares each subsequent pressures received for that sensor ID with the initial one and when the comparison shows a delta pressure exceeding the defined level required, this sensor ID is assigned to the selected tire location.

Once a wheel ID has been assigned, the display increments the number of Wheels done and it moves the axle/wheel to the next one in the sequence waiting for another sensor to come up with a pressure change. Within one learning session, the display remembers which sensor has been assigned and it will not assign it twice.

The sequence increments to the next wheel on the same axle counting wheels from left to right and then moves to the next axle counting axles from front to rear.

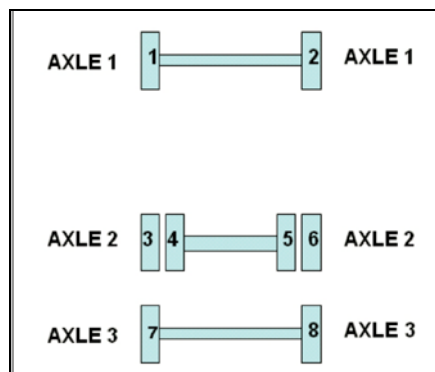

The display activates the next wheel parameter each time a wheel is done. This parameter is use by the vehicle electronic to activate an audible signal on the vehicle thus providing a feedback to the user that he can move to the next wheel.

The spare Tire can be done by selecting the axle/wheel “spare” which is internally encoded to 15:1.

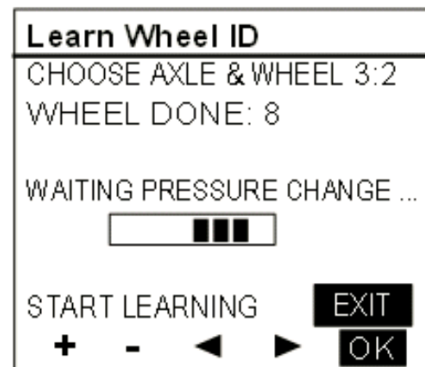
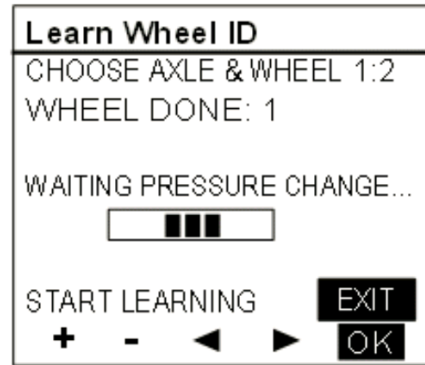
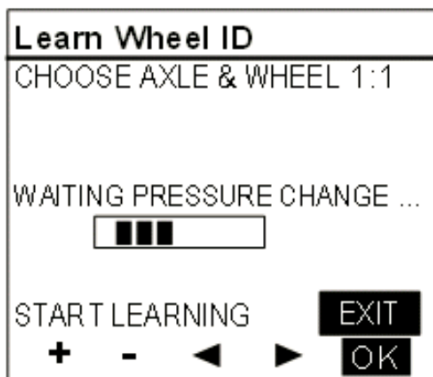
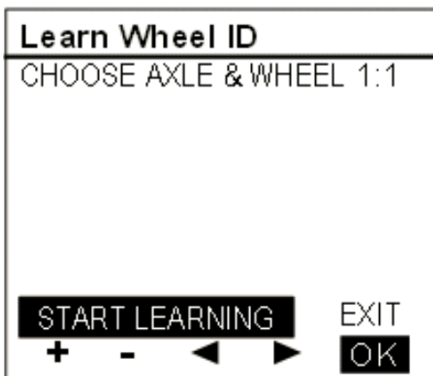
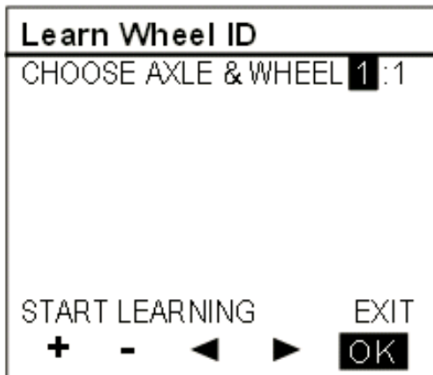
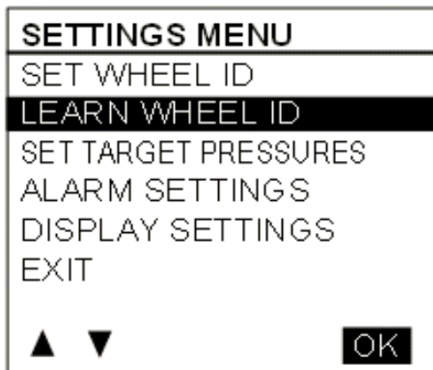

- Set Target Pressures

This menu allows the end user fine tuning the target pressure setting to account for the specific operating conditions (cold weather operation or unloaded operation). The end user can readjust the target pressure within +30% and -20% of the factory set target pressure but not outside this range.

The factory set target pressure is always kept in permanent memory into the TPMS display and cannot be edited by the end user.

When the user enters a new target value, the user cannot select values outside the valid range.

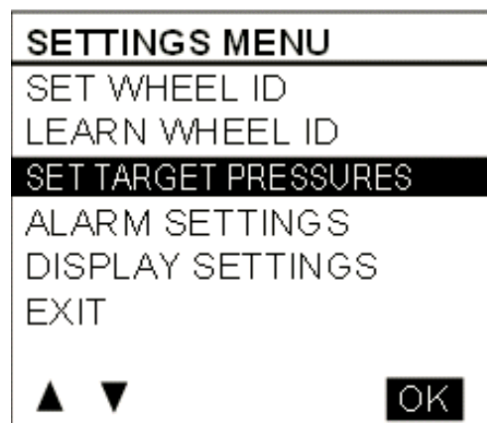

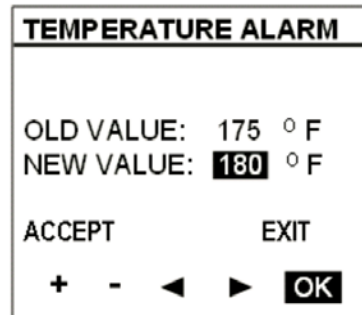
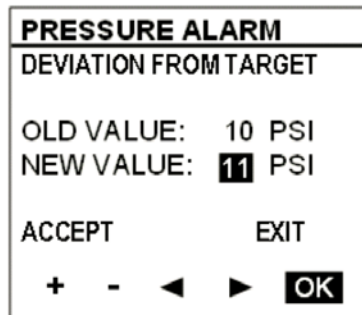
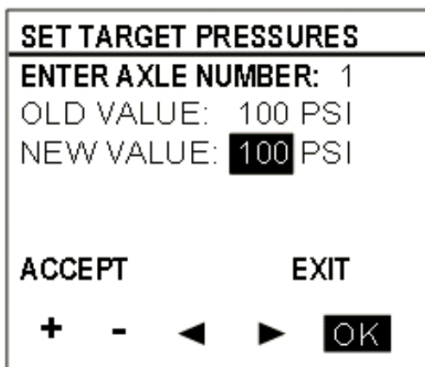

- Alarm Settings

When selecting the Alarm Settings Menu, a sub menu containing Pressure Alarm and Temperature Alarm appears.

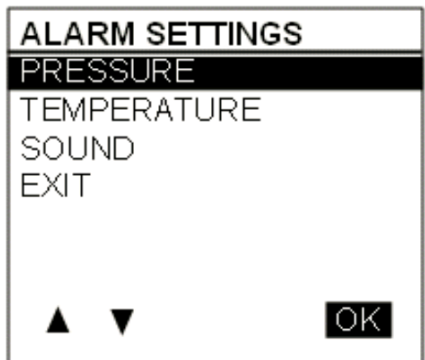
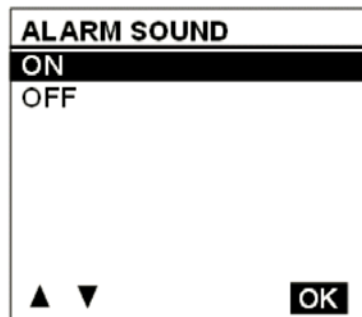
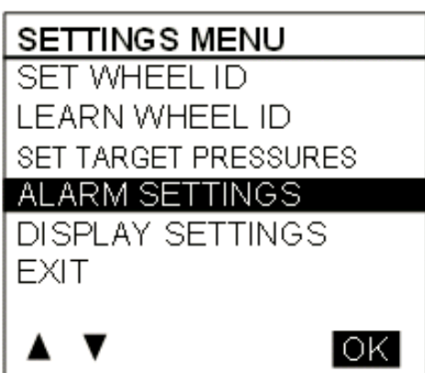

- Display Settings

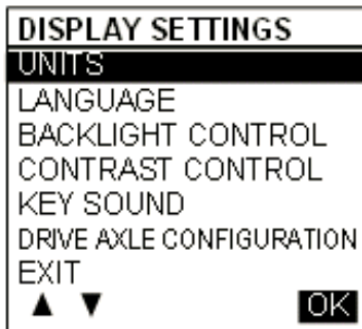

When selecting Pressure Alarm the screen pressure alarm shown below appears. A similar screen is defined for temperature settings. The cursor can be moved to highlight the number beside “new value”, “ACCEPT” or “EXIT”. +/- allows increasing or decreasing the numbers. Pressure alarms changes are allowed in steps of 1 PSI in the range from 5 to 20 PSI. Temperature alarms in steps of 5°F (2°C) in the range from 150 to 180 °F (64 to 82 °C). Pressing OK with “ACCEPT” highlighted applies the change and exits to the previous menu. Pressing OK when “EXIT” is highlighted exits without changes.

Units

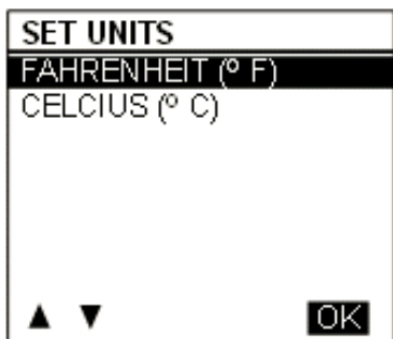

Languages



Backlight Intensity

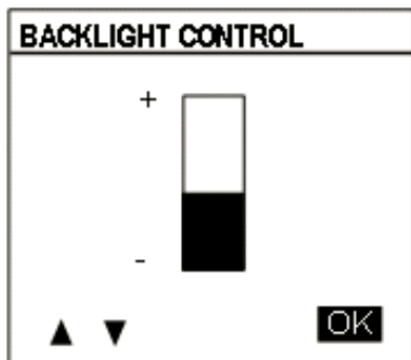

Key Sound

Turns key press sound ON/OFF.

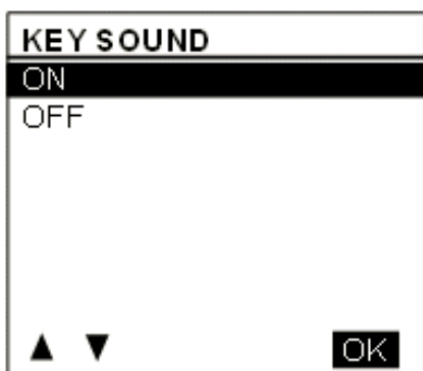

Tire / Axle Configuration

Pressing the up down arrow when the number of tires is highlighted allows flipping the number to 2 or 4 which are the only valid choices.

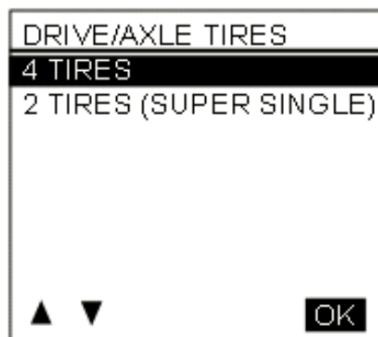

Refer to "Appendix E" for Troubleshooting Guide on TPMS system.

FIRE EXTINGUISHERS

Two fire extinguishers are located on the vehicle L.H. side just behind the driver's seat. Instructions for use are found on the extinguishers. Make sure you know how to operate fire extinguishers in case of an emergency.

FIRST AID KIT

The optional first aid kit is usually stored near the driver's seat. A white cross over red background decal identifies the first aid kit.

WARNING REFLECTORS

A kit containing three triangular reflectors is provided to warn other drivers on the road in case of a breakdown. The kit is located on the ceiling of the first R.H. side baggage compartment, but may have been relocated by the converter. The reflectors provide visible warning of an emergency situation. The three reflectors should be placed as indicated on the box cover. These reflectors comply with FMVSS 125 (Federal Motor Vehicle Safety Standards).

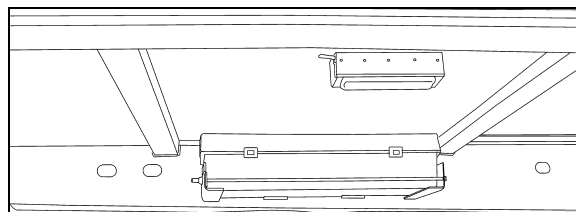

FRONT BAGGAGE COMPARTMENT

JACK/TOOLS

A kit for jacking up the vehicle is stored in the first R.H. side baggage compartment, attached to the forward bulkhead of the compartment. The kit includes a:

- 30 ton bottle jack;
- Bumper wrench;
- Wheel nut wrench and lever.

SPARE PARTS KIT

The vehicle may be equipped with a spare parts kit (optional). The kit contains parts such as bulbs, circuit breakers, belts, etc. The spare parts kit is stored in the first baggage compartment.

CHANGING WHEELS

In case of a flat tire, turn *ON* the hazard flashers and bring the vehicle to a stop on the side of the road. Apply the parking brake. Make sure the vehicle is parked safely away from traffic. Set up the triangular reflectors in accordance with applicable highway regulations.

We suggest that you **do not** attempt to change a wheel. First, the wheel and tire are very heavy and usually there is no space available to put the removed flat. Second, the wheel nuts, especially those on inner dual, can become very tight after being on for only a short time. Often a heavy air wrench is required to get these nuts loose. We suggest you get help via CB radio or cellular phone. There are tire service trucks all over the country that can bring a wheel and make the change safely.

JACKING POINTS

Twelve jacking points are located on the vehicle: three are located on each side of the frame and two are located under each axle. Refer to the following illustrations for the location of jacking points.

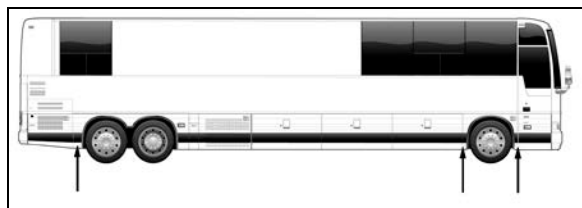

JACKING POINTS ON FRAME

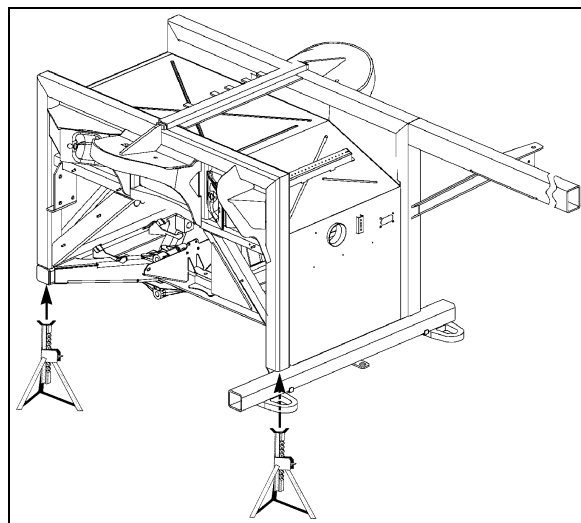

FRONT SUB-FRAME JACKING POINTS

18645

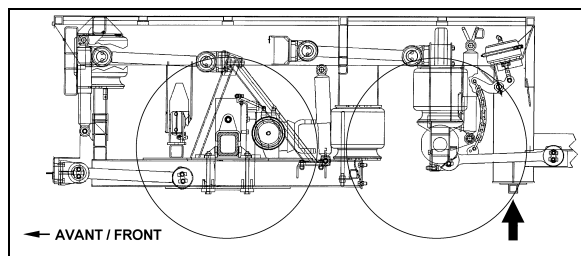

REAR SUB-FRAME JACKING POINTS



WARNING

The suspension of the vehicle must be in the normal ride position before jacking. The level low system must be in the *OFF* position prior to turning *OFF* the ignition key.

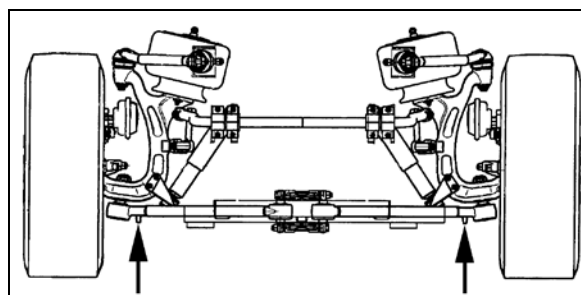

JACKING POINTS ON FRONT SUSPENSION

16139

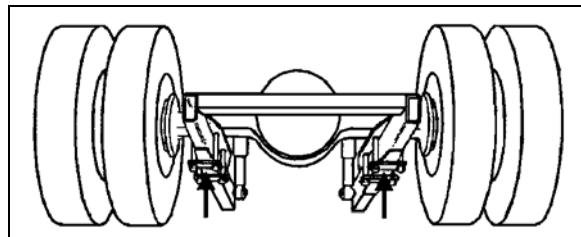

JACKING POINTS ON DRIVE AXLE

11005



WARNING

Always retract the tag axle before jacking the vehicle from the front and drive axle jacking points to prevent damage to suspension components.

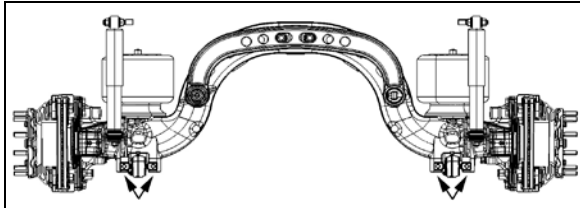

JACKING POINTS ON TAG AXLE

11029



WARNING

The jacking points on the tag axle must be used for raising the tag axle only.

Several kinds of hydraulic jacks can be used. Only jack at the specified jacking points. Jack must support the following capacities:

Front axle: 20,000 lb (9 100 kg);

Drive axle: 40,000 lb (18 200 kg).

HYDRAULIC JACK

To raise: turn release valve clockwise. Insert handle in socket and raise by pumping.

To lower: remove handle and turn the release valve slowly counterclockwise.

Always keep ram and extension screw retracted when jack is not in use.

Service: Check oil level when jack fails to raise to full height. Lower ram completely with release valve open and jack in upright position, remove filler plug and refill to level of filler hole with hydraulic jack oil. Never use brake fluid.



DANGER

Jack is intended for lifting only. Do not get under the vehicle or load for any reason unless it is properly supported with safety stands and securely blocked.



DANGER

Do not overload jack above rated capacity. Prevent "side loading", make sure load is centered on ram. Do not push or tilt load off jack.

TOWING

To prevent damage to the vehicle, use the two tow eyes located under the back bumper and/or fixed to the vehicle's frame between the front axle and the front bumper. Use only a solid link tow bar and a safety chain to tow the vehicle. If required, connect an auxiliary air supply to the vehicle so brakes can be operated while towing.

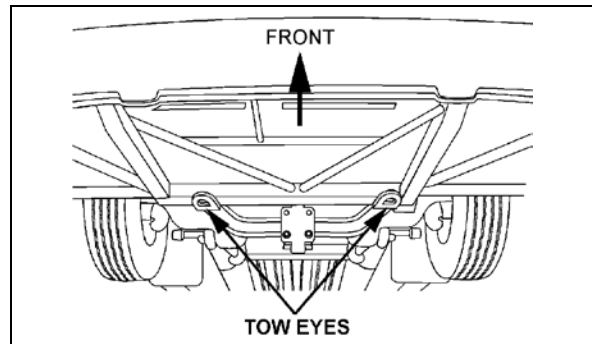

TOW EYES

18003A



DANGER

During a towing operation, the driver should be alone inside the vehicle.



CAUTION

To prevent damage to the drive train components, disconnect axle shafts or driveshaft before towing. Do not attempt to push or pull-start a vehicle equipped with an automatic transmission.

NOTE

Make sure axle shafts or driveshaft are installed correctly after towing. Tighten axle shaft and driveshaft nuts to the correct torque settings. Do not invert shafts.

DAYTIME RUNNING LIGHTS

The low beams come *ON* automatically at reduced intensity when the engine is started and the parking brake is released. The daytime running lights provide added safety by making the traveling vehicle more visible to other drivers.

The lights are not used when:

- Engine is stopped;
- Parking brake is applied;
- The exterior lighting switch is turned to the OFF position.

 WARNING
<p>Do not drive with the daytime running lights at night. For night driving, turn <i>ON</i> the headlights by depressing the exterior lighting rocker switch to the second position. The daytime running lights do not provide sufficient illumination for safe driving at night.</p>

FOG LIGHTS

Fog lights provide better visibility in fog and precipitation. They improve visibility immediately in front of the vehicle. They also provide added safety.

<p>NOTE</p> <p><i>Some states or provinces may restrict the use of fog lights. Verify local state or provincial regulations before using.</i></p>
--

CORNERING AND DOCKING LIGHTS

The vehicle may be equipped with up to four halogen cornering lights. Two lights are installed at the front of the vehicle, on each side as standard equipment. Two optional lights may be installed on each side at the rear of the vehicle. When activated, the front lights illuminate at the same time as the turn signal flashers to increase lateral visibility while turning. The rear lights illuminate when the reverse (R) range is selected to increase visibility while backing-up the vehicle. All four lights will illuminate when the docking position is selected using the rocker switch. Refer to chapter: "Controls and Instruments".

COMPARTMENT LIGHTING

Baggage and front service compartment lights are automatically turned *ON* when the corresponding compartment door is opened. A telltale light on the dashboard illuminates when the baggage compartment door is open.

MUD FLAPS AND SPLASH GUARDS

Mud flaps are installed behind each front and tag axle wheel in order to minimize dirt on the lower panels of the vehicle and prevent stones and debris from being thrown at vehicles traveling behind the vehicle. Splash guards may be installed behind each dual wheel of the drive axle to prevent stone projectiles from being thrown at the tag axle wheels.

BACK-UP CAMERA

An optional back-up camera is available which provides the driver with visual assistance when backing-up.

The TV monitor may be mounted on the left side pillar. It switches *ON* automatically when the transmission is in the reverse (R) range.

BACK-UP ALARM

The back-up alarm alerts pedestrians and other drivers when the vehicle is being backed-up. Take extra precautions whenever backing-up. If necessary, use a guide to provide directions when backing-up. Both the alarm and optional camera are automatically activated when the transmission is put in the reverse (R) range.

BACK-UP ALARM CANCEL SWITCH

A rocker switch located on the L.H. side dashboard panel allows the driver to cancel the back-up alarm system (as for example: at night on a camping site).

<p>NOTE</p> <p><i>After use, return to normal operation.</i></p>
