

SECTION 07: TRANSMISSION

CONTENTS

1. DESCRIPTION	3
1.1 ALLISON AUTOMATIC TRANSMISSION	3
1.1.1 Retarder (if applicable)	3
1.2 VOLVO I-SHIFT TRANSMISSION	3
2. WELDING PROCEDURES	4
3. ALLISON TRANSMISSION MAINTENANCE	4
3.1 MANUAL FLUID LEVEL CHECK	4
3.1.1 Cold Check	5
3.1.2 Hot Check	5
3.2 FLUID LEVEL CHECK USING THE PUSHBUTTON SHIFT SELECTOR	6
3.3 RECOMMENDED AUTOMATIC TRANSMISSION FLUID	7
3.3.1 Importance of Proper Fluid Level	7
3.3.2 Keeping Fluid Clean	7
3.3.3 Oil Contamination	7
3.3.4 Metal Particles	7
3.3.5 Coolant Leakage	8
3.4 CONTROL SYSTEM PROGNOSTICS	8
3.4.1 Normal Prognostics Indication at Engine Start	8
3.4.2 Oil Life Monitor	8
3.4.3 Filter Life Monitor	9
3.4.4 Transmission Health Monitor	10
3.5 OIL AND FILTER CHANGE INTERVAL	12
3.5.1 Oil and Filter Change Interval with Prognostics Mode Disabled	13
3.5.2 Oil and Filter Change Interval with Prognostics Mode Enabled	13
3.6 FLUID AND FILTER CHANGE PROCEDURE	14
3.6.1 Drain	14
3.6.2 Refill transmission	14
3.7 CLEANING AND INSPECTION OF ALLISON AUTOMATIC TRANSMISSION	15
3.7.1 Breather	15
4. TRANSMISSION OIL COOLER REMOVAL	15
4.1 TRANSMISSION WITHOUT RETARDER	15
4.2 TRANSMISSION WITH RETARDER	15
5. ALLISON TRANSMISSION INSTALLATION	16
6. ALLISON TRANSMISSION TROUBLESHOOTING	17
6.1 DIAGNOSTIC TROUBLESHOOTING CODES (DTC) — ALLISON 5TH GENERATION CONTROLS	17
6.1.1 Using Shift Selector for Accessing Diagnostics Information	18
6.1.2 Display Sequence	18
6.1.3 Diagnostic Code Display and Clearing Procedure	18
6.1.4 Exiting Diagnostic Mode	18
6.1.5 Diagnostic Trouble Code Response	18
6.2 DIAGNOSTIC TROUBLESHOOTING CODES (DTC) LIST - ALLISON 5 TH GENERATION CONTROLS	19
7. ALLISON TRANSMISSION REMOVAL	22
8. VOLVO I-SHIFT TRANSMISSION MAINTENANCE	23
8.1 TRANSMISSION OIL	23

Section 07: TRANSMISSION

8.2 CHECKING OIL LEVEL 23
8.3 OIL CHANGE INTERVAL 24
8.4 OIL CHANGE 24
9. VOLVO I-SHIFT TRANSMISSION TECU FAULT CODES 25
10. VOLVO I-SHIFT TRANSMISSION GSECU FAULT CODES 64
11. SPECIFICATIONS 65

ILLUSTRATIONS

FIGURE 1: ALLISON TRANSMISSION 07136 3
FIGURE 2: ALLISON TRANSMISSION CONTROL PAD 07142 3
FIGURE 3: VOLVO I-SHIFT TRANSMISSION 07XXX 4
FIGURE 4: OIL LEVEL DIPSTICK (AUTO. TRANS.) 07113 4
FIGURE 5: COLD CHECK 07050 5
FIGURE 6: HOT CHECK 07049 6
FIGURE 7: DRAIN PLUG AND FILTERS 07052 14
FIGURE 8: COOLER WITH RETARDER 07073 15
FIGURE 9: AIR PRESSURE REGULATOR (TYPICAL) 07037 17
FIGURE 10: TRANSMISSION CONTROL MODULE 07140 17
FIGURE 11: VOLVO ENGINE CRANKING POSITION 23
FIGURE 12: I-SHIFT TRANSMISSION OIL CHANGE 23
FIGURE 13: SIGHT GLASS FOR CHECKING OIL LEVEL 24
FIGURE 14: OIL FILTER HOUSING DRAIN PLUG 24
FIGURE 15: OIL FILTER 24

1. DESCRIPTION

X3 Series coaches may be provided with either an Allison automatic transmission or a Volvo I-Shift transmission while X3-45 VIP and XLII Bus Shells are provided with an Allison automatic transmission.

1.1 ALLISON AUTOMATIC TRANSMISSION

The Series 4000 (B500 for coaches and 4000MH for motorhomes) Allison Transmission has 6 speeds with two top range (fifth and sixth) overdrives. Total coverage is determined by dividing the highest gear ratio by the lowest gear ratio. Total coverage expresses the transmission gear ratio versatility. Transmissions with larger total coverage number have a wider variety of available ratios.

An electronic control allows the transmission to shift at exactly the right point on the engine's fuel consumption curve for best economy. Early lockup maintains the highest possible mechanical efficiency through the closely-spaced gear steps, culminating in two overdrive ratios. This combination allows progressive shifting techniques, where engine speeds are reduced for higher efficiency and lower fuel consumption.

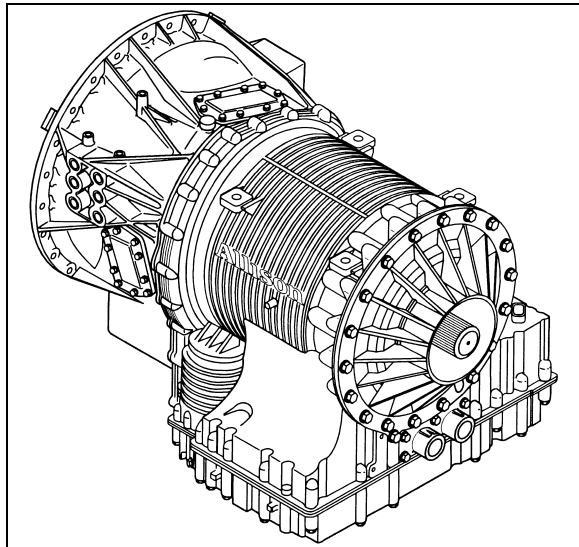

FIGURE 1: ALLISON TRANSMISSION 07136

Gear selection and torque converter modes are controlled by a microcomputer-based electronic transmission management system. It is fed information regarding throttle position, operator range selection, engine speed, turbine speed, transmission output speed and various system pressures from special electronic sensors. With this information, it computes shift points and clutch pressures to meet immediate needs.

Using closed loop adaptive logic; the electronic control looks at a number of parameters during the shift, and makes minute adjustments to match the shift to desired profile stored in its memory. It then looks at these adjustments and resets the parameters, which allow the transmission to quickly compensate for variations in load, terrain or environment and to adjust for clutch wear and engine power changes. A Diagnostic Data Reader can be connected to the electronic control unit to provide a self-check of all systems in the transmission. Five-digit trouble codes greatly reduce the time it takes to pinpoint potential problems. (Refer to paragraph "8. TROUBLESHOOTING" in this section).

1.1.1 Retarder (if applicable)

This optional auxiliary braking device for the automatic transmission is integrated into the basic envelope of the transmission and transmits its braking force directly to the propeller shaft. It requires no additional length and adds only 75 pounds (34 kg) of weight. Operation of the retarder is controlled electronically by the driver's use of the brake and/or by hand control lever.

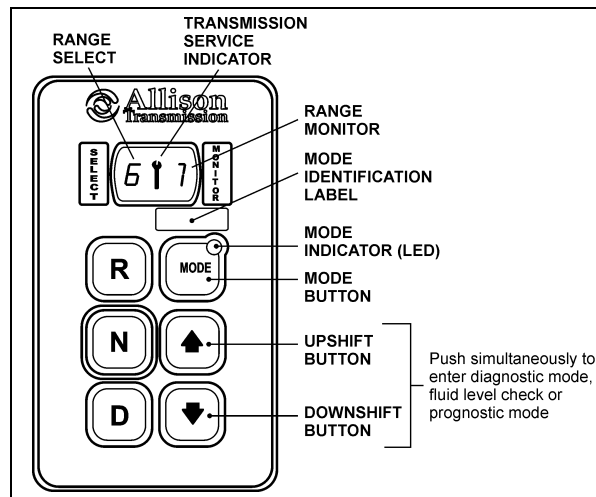

FIGURE 2: ALLISON TRANSMISSION CONTROL PAD 07142

When activated, fluid enters a cavity and provides resistance to the turning of rotor blades revolving with the output shaft. This effectively slows the vehicle to the point where the service brakes are needed only for final stopping. The retarder is fully modulated and is compatible with ABS.

1.2 VOLVO I-SHIFT TRANSMISSION

The Volvo I-Shift transmission is a single countershaft transmission with 12 forward gears and two reverse gears. The I-Shift is an automated mechanical transmission.

Section 07: TRANSMISSION

If the I-Shift transmission system is to be used, the vehicle must have an electronic engine control unit as well as CAN communication. Since the clutch is automated (clutch pedal no longer fitted), the driver no longer has to activate the clutch.

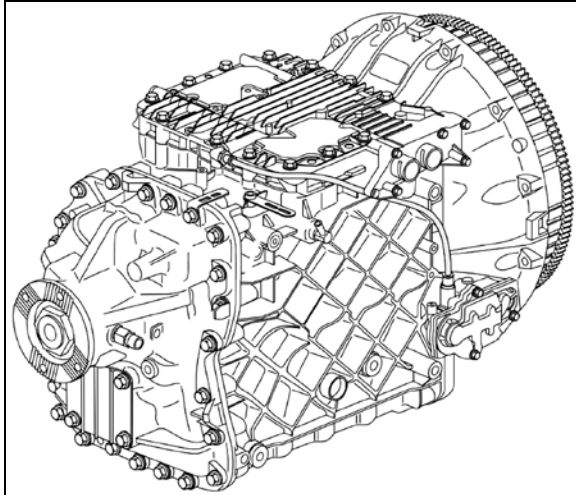

FIGURE 3: VOLVO I-SHIFT TRANSMISSION 07XXX

The transmitted torque (both engine and braking) will be interrupted during gear shifting, in both driving and coasting conditions. There is no clutch pedal and the gear shifting is controlled by the transmission or the driver through the pushbutton shift selector.

When in fully automatic mode, gears are selected and shifts made by the electronic control unit. The driver can still intervene if he wishes to. All system functions required are shown on the display, e.g. neutral, gear change, clutch overload and diagnosis information.

2. WELDING PROCEDURES

These procedures are intended only for vehicles equipped with transmission electronic controls. When frame or other welding is required on the vehicle, precautions are to be taken to protect the electronic control components. Refer to section 00: GENERAL INFORMATION, paragraph 3: "Precautions to be observed before welding" for complete procedure.

3. ALLISON TRANSMISSION MAINTENANCE

3.1 MANUAL FLUID LEVEL CHECK

Take note that an oil level sensor (OLS) is standard in your transmission. With the OLS and Allison 5th generation shift selector, you can get

a more accurate electronic fluid level check than with a dipstick.

To gain access to the dipstick, open the engine compartment rear doors; dipstick is located on the radiator side of the engine (Figure 4).



DANGER

When checking the oil level, be sure that the parking brake and/or emergency brakes are set and properly engaged, and the wheels are chocked. Unexpected and possible sudden vehicle movement may occur if these precautions are not taken.

- Special care must be taken not to touch the engine coolant tubing and/or exhaust pipe, since this could cause severe burns.
- Do not wear loose clothing and, stay away from rotating parts during procedure; personal injury could occur.

Clean all dirt from around the end of the oil filler tube before removing the dipstick. Dirt or foreign matter must not be permitted to enter the oil system since it will cause valves to stick, undue wear of transmission parts, and clogged passages. Check the oil level using the procedures in Cold Check and Hot Check. Record any abnormal level on your "Maintenance Records".

Always check the oil level reading at least twice when the engine is running. Consistency is important in maintaining the accuracy of the reading. If inconsistent readings persist, check the transmission breather to ensure it is clean and free of debris.

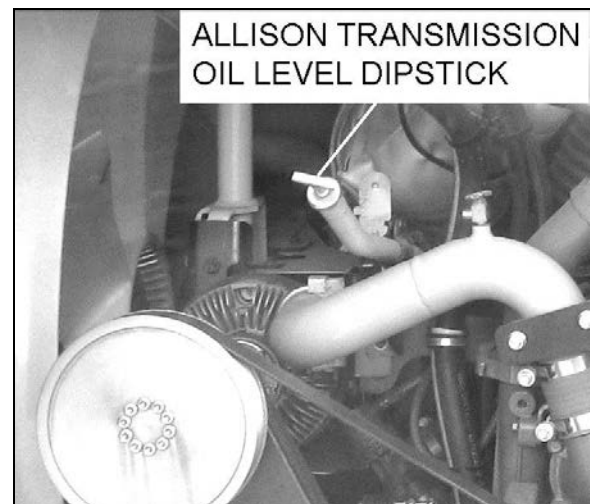

FIGURE 4: OIL LEVEL DIPSTICK (AUTO. TRANS.) 07113

3.1.1 Cold Check

The purpose of the **Cold Check** is to determine if the transmission has enough fluid to be operated safely until a **Hot Check** can be made.

 **CAUTION**

The oil level rises as sump temperature increases. **DO NOT** fill above the Cold Run band if the transmission oil is below normal operating temperature. During operation, an overfull transmission can become overheated, leading to transmission damage.

1. Move the vehicle to a level surface, put transmission in «N» (Neutral), and set the parking brake.
2. With the engine idling (500 - 800 rpm), shift to «D» (Drive) and then shift to «R» (Reverse) to clear the hydraulic system of air.
3. Run the engine at idle in «N» (Neutral) for about one minute.
4. While the engine is running, remove the dipstick from the tube and wipe it clean (Figure 4). Insert the dipstick into the fill tube, pushing down until it stops.
5. Remove the dipstick and observe the fluid level. Repeat the check procedure to verify the reading. If the fluid on the dipstick is within the **COLD CHECK** band, the level is satisfactory for operating the transmission until the oil is hot enough to perform a **Hot Check**. If the fluid level **is not** within this band, add or drain fluid as necessary to bring the level within the **COLD CHECK** band.
6. Perform a **Hot Check** at the first opportunity after the normal operating temperature of 160°F to 200°F (71°C to 93°C) is attained.

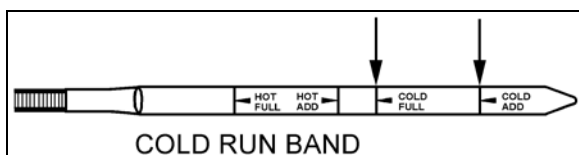

FIGURE 5: COLD CHECK

07050

 **CAUTION**

DO NOT operate the transmission for extended periods of time until a **Hot Check** has verified

proper fluid level. Transmission damage can result from extended operation at improper fluid level conditions.

 **CAUTION**

Obtain an accurate fluid level by imposing the following conditions:

- Engine is idling (500-800 rpm) in «N» (Neutral).
- Transmission fluid is at normal operating temperature.
- The vehicle is on a level surface.

3.1.2 Hot Check

To perform a **Hot Check**, do the following:

1. The **Hot Check** can be performed when the transmission oil reaches the normal operating temperature (160°F to 200°F / 71°C to 93°C). The transmission oil temperature can be checked with the Driver Information Display (DID) when selecting the Gauge menu (refer to the "Operator's Manual" for added information).

 **CAUTION**

The oil **must be hot** to obtain an accurate check because the fluid level rises as temperature increases.

2. Park the vehicle on a level surface and shift to «N» (Neutral). Apply the parking brake and allow the engine to idle (500 - 800 rpm).
3. Remove the dipstick from the tube and wipe it clean. Insert the dipstick into the fill tube, pushing down until it stops.
4. Remove the dipstick and observe the fluid level. The safe operating level is anywhere within the **HOT RUN** band on the dipstick. Repeat the check procedure to verify the reading.
5. If the level **is not** within this band, add or drain fluid as necessary to bring the level within the **HOT RUN** band.
6. Be sure fluid level checks are consistent. Check level more than once and if readings are not consistent, check to be sure the transmission breather is clean and not clogged. If readings are still not consistent,

Section 07: TRANSMISSION

contact your nearest Allison dealer or distributor.

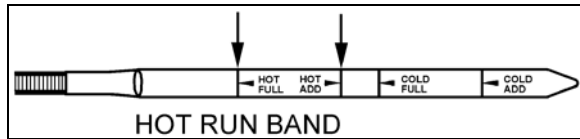

FIGURE 6: HOT CHECK

07049

NOTE

The Cold Check is more appropriate for verifying the oil level after the first fill-up. In case of conflict, the Hot Check has priority over the Cold Check; **the fluid level check using the pushbutton shift selector has priority over the Hot Check.**

3.2 FLUID LEVEL CHECK USING THE PUSHBUTTON SHIFT SELECTOR

The oil level sensor (OLS) is standard in your transmission. With the OLS and Allison 5th generation shift selector, you can get a more accurate electronic fluid level check than with a dipstick.

Oil level codes are obtained as follows:

1. Park vehicle on a level surface, select «N» (neutral) on the pushbutton shift selector and apply parking brake.
2. Wait for at least 2 minutes to allow the oil to settle;
3. Press simultaneously the ▲ (Upshift) and ▼ (Downshift) arrow buttons once.
4. Oil level codes are displayed once the following parameters are met :
 - **The vehicle has been stationary for approximately 2 minutes to allow the oil to settle;**
 - **Engine at idle;**
 - **Oil at normal operating temperature, between 104°F (40°C) and 220°F (104°C);**
 - **Transmission in «N» (Neutral);**
 - **Transmission output shaft stopped;**
 - **Oil level sensor present and working.**

5. Correct fluid level is displayed as shown.



6. Low fluid level is displayed as shown. The number indicates the number of quarts of fluid the transmission requires.



7. High fluid level condition with the number of quarts in excess is displayed as shown.



NOTE

Confirm a low fluid level condition by making a manual fluid level check.

8. To exit the Oil Level Display Mode, press any range button «R», «N» or «D» at any time.

NOTE

Note that the quantities LO 4 and HI 3 are the largest values displayed and that the actual variation in oil level may exceed these numbers.

If the fluid level check cannot be completed, an Invalid for Display fault is reported. Refer to table below to review the codes and conditions.

CODE	CAUSE OF FAULT CODE
SETTLING OK	Settling time too short
ENG RPM TOO LOW	Engine speed (rpm) too low
ENG RPM TOO HIGH	Engine speed (rpm) too high
MUST BE IN NEU	N (Neutral) must be selected
OIL TEMP TOO LOW	Sump fluid temperature too low
OIL TEMP TOO HIGH	Sump fluid temperature too high
VEH SPD TOO HI	Output shaft speed
SENSOR FAILED	Sensor failure

3.3 RECOMMENDED AUTOMATIC TRANSMISSION FLUID

Only use fluids meeting Allison Transmission specification TES295 or TES389 in your transmission. Refer to TES295 or TES389 Approved Fluids list, found under the Service/Fluids heading on the home page of the Allison Transmission web site www.allisontransmission.com.

Allison Transmission recommends you take the following into consideration when selecting the appropriate fluid type for your transmission:

- Fluids meeting specification TES295 are preferred over TES389 fluids for use in all 4000 Product Families transmission applications.
- TES295 fluids are fully qualified for Severe Duty and Extended Drain intervals.
- A TES295 fluid allows you to operate at a lower ambient temperature than a TES389 type fluid.
- TES389 fluid is the minimum fluid requirement approved for use in 4000 Product Families transmissions.
- To extend the TES389 fluid drain intervals beyond the recommended mileage or hours change interval, use a fluid analysis program.

When choosing a fluid type to use, consider what the minimum fluid operating temperature of the fluid will be based on the ambient temperatures reached in the geographical location for the vehicle.

Transmission Fluid Operating Temperature Requirements

Fluid type	Minimum operating temperature	
	Celsius	Fahrenheit
TES295	-35	-31
TES389	-25	-13



CAUTION

Disregarding minimum fluid temperature limits can result in transmission malfunction or reduced transmission life.

NOTE

The use of an arctic preheat kit is recommended at temperatures below -25°F (-32°C). If a preheat kit is not available, the TCM will restrict full operation until the sump temperature is increased.

3.3.1 Importance of Proper Fluid Level

It is important that the proper fluid level be maintained at all times because the transmission fluid cools, lubricates, and transmits hydraulic power. If the fluid level is too low, the converter and clutches do not receive an adequate supply of fluid. If fluid level is too high, the fluid can aerate, causing the transmission to shift erratically or overheat.

3.3.2 Keeping Fluid Clean

Oil must be handled in clean containers, fillers, etc., to prevent foreign material from entering the transmission. Place the dipstick on a clean surface area while filling the transmission.



CAUTION

Containers or fillers that have been used to handle antifreeze or engine coolant must NEVER be used for handling transmission fluid. Antifreeze and coolant solutions contain ethylene glycol that, if introduced into the transmission, can cause the clutch plates to fail.

3.3.3 Oil Contamination

At each oil change, examine the drained oil for evidence of dirt or water. A nominal amount of condensation will emulsify during operation of the transmission. However, if there is evidence of water; check the cooler (heat exchanger) for other signs of leakage. This, however, may also indicate leakage from the engine oil system.

3.3.4 Metal Particles

Metal particles in the oil (except for minute particles normally trapped in the oil filter) indicate damage has occurred in the transmission. When these particles are found in the sump, the transmission must be disassembled and closely inspected to find the source. Metal contamination will require complete disassembly of the transmission and cleaning of all internal and external circuits, coolers, and all other areas where the particles could lodge.



CAUTION

If excessive metal contamination has occurred, replacement of the oil cooler and replacement of all bearings within the transmission is recommended.

3.3.5 Coolant Leakage

If engine coolant leaks into the transmission oil system, immediate action must be taken to prevent malfunction and possible serious damage. The transmission must be completely disassembled, inspected, and cleaned. All traces of the coolant contamination must be removed. Friction clutch plates contaminated with ethylene glycol must be replaced.

3.4 CONTROL SYSTEM PROGNOSTICS

The transmission control system includes the provision for the user to monitor various transmission operating parameters. Transmission operating parameters monitored by the prognostics feature are:

- Oil Life Monitor
- Filter Life Monitor
- Transmission Health Monitor

NOTE



*The prognostics package requires the use of **TranSynd™** or an **Allison approved TES295 or TES389 licensed fluid** in the transmission and **Allison High Capacity filters**. If any other fluids or filters are used, Prognostic mode **must be disabled**. Prognostic information will not be accurate with any other fluids or filters and could result in missed maintenance activities resulting in transmission damage.*

Refer to TES 295 or TES389 Approved Fluids list, found under the Service/Fluids heading on the home page of the Allison Transmission web site.



www.allisontransmission.com

When a specified threshold is detected for any of the serviceable conditions, the TRANSMISSION SERVICE indicator  is illuminated to alert the operator. Failure to attend to the service condition and reset the TRANSMISSION SERVICE indicator within a defined operating period will result in illumination of the CHECK light with associated message in the DID,

indicating the increased probability that the service condition will develop into a more serious condition.

To access the Prognostic Mode functions, simultaneously press the  (Upshift) and  (Downshift) arrow buttons repeatedly.

3.4.1 Normal Prognostics Indication at Engine Start

- A system bulb check illuminates the TRANSMISSION SERVICE indicator  approximately 0.5 seconds.
- If Prognostics features are enabled, the TRANSMISSION SERVICE indicator  illuminates again for 3 seconds after the bulb check. If Prognostics features are disabled, the TRANSMISSION SERVICE indicator  does not illuminate again after the bulb check.

3.4.2 Oil Life Monitor

The display message denotes the calculated remaining life of the transmission fluid. This value is based on the established life for the required baseline fluid, and then is continuously adjusted for cumulative effects of such operating parameters as operating time, retarder operation, output shaft revolutions and shift frequency.

Display

The display is a two-digit number, denoting percentage of the fluid life which remains. New fluid is displayed as 99%.

The TRANSMISSION SERVICE indicator  will be illuminated, denoting a required change of transmission fluid, when the remaining fluid life reaches approximately 1 %. The indicator will be lit steadily upon each initialization of the TCM, and will remain on steady for approximately 2 minutes after the first selection of "D" (drive) range each time, until service is performed and the indicator is reset.

Failure to perform maintenance and reset the TRANSMISSION SERVICE indicator within a defined period will result in the illumination of the CHECK light with associated message in the DID and diagnostic code P0897 Transmission Fluid Deteriorated.

Reset

The TRANSMISSION SERVICE indicator can be reset by a message over the SAE J1939 communication interface, with the Allison DOC™ for PC diagnostic program, or by depressing and holding the MODE button for ten (10) seconds while the Oil Life Monitor function is displayed. It may also be reset by selecting N-D-N-D-N-R-N on the shift selector, pausing briefly (less than 3 seconds) between each selector movement, with the ignition on and the engine not running. The TRANSMISSION SERVICE indicator illuminates briefly following a reset to acknowledge the reset was successful.

Setting Fluid Type for Prognostics

The fluid type can be programmed if the specific calibration allows it. The operator can do the following:

With the engine off and the ignition on, perform the following sequence on the selector, N-R-N-D-N-R-N-D-N-R-N-D-N.

The TRANSMISSION SERVICE indicator flashes if TES389 is the current setting and illuminates solidly if TES295 is the current setting. To change the transmission fluid type, wait 5 seconds after entering transmission fluid type mode and perform the following sequences to select the proper transmission type:

N-R-N to select TES295

N-D-N to select TES389

The selector exits 30 seconds after entering transmission fluid type mode or the ignition may be turned off to exit earlier. Only one transmission fluid type selection may be made after entering transmission fluid type mode. All other attempt will be ignored. Transmission fluid type mode needs to be entered again if the wrong type of fluid is selected.



CAUTION

Verify prognostics fluid type setting matches transmission fluid type. Oil Life Monitor notifications will be inaccurate when mismatched. This could result in transmission damage from running a TES389 fluid too long or cause shortened TES295 fluid changes to occur.



CAUTION

Required calendar-based oil & filter change intervals (based on month) still apply because Oil Life Monitor function cannot measure time while ignition power is OFF.

If the Oil Life Monitor function has not indicated the need for a fluid change before 60 months have passed when using TES295 fluid type or before 24 months have passed when using TES389 fluid type, it will be necessary to change the fluid and filters per calendar requirements and reset the system.

3.4.3 Filter Life Monitor

This feature provides an alert when the transmission's fluid filters need to be replaced. It helps extend filter change intervals to reduce routine maintenance downtime while providing maximum protection for the transmission.

The filter life indicator pressure switch signals the transmission control module when fluid exiting the main filter drops below a predetermined pressure. Both the main and lube filters **must be** changed when the TRANSMISSION SERVICE indicator  shows the main filter should be changed.

Filter Change Notification

The TRANSMISSION SERVICE indicator  will flash for 2 minutes after the first selection of "D" (drive) range. Once the Filter Monitor mode has been accessed via the shift selector, the "OIL FILTER OK" or "REPLACE FILTERS" message is displayed in the selector display window. An acceptable filter life status is displayed as "OIL FILTER OK". An unacceptable filter life status is displayed as "REPLACE FILTERS".

Once the programmed threshold for maximum filter pressure drop has been observed and verified, the diagnostic code P088A Transmission Filter Maintenance Alert will be recorded to indicate that the filter has reached the end of its designed life. At the next initialization of the TCM, the TRANSMISSION SERVICE indicator  will flash for 2 minutes after the first selection of "D" (drive) range. Thereafter, the indicator will illuminate and flash upon each TCM initialization, continuing to flash for 2 minutes after the first selection of a drive range each time, until service is performed and the indicator is reset.

Failure to perform maintenance and reset the monitor after a calibration-defined number of warnings will result in the illumination of the CHECK light with associated message in the DID and diagnostic code P088B will be recorded to indicate a highly deteriorated filter.

Read and Reset Filter Life Monitor from Selector

To enter the filter life monitor, press simultaneously the ▲ (Upshift) and ▼ (Downshift) arrows three times. An acceptable filter life status is displayed as "OIL FILTER OK". An unacceptable filter life status is displayed as "REPLACE FILTERS".

The feature will **reset** automatically when the main fluid filter has been changed and the pressure drop across the filter no longer exceeds the threshold value. A manual reset can be performed by depressing and holding the MODE button for ten (10) seconds while the Filter Life Monitor function is displayed. It may also be reset by selecting N-R-N-R-N-D-N on the shift selector, pausing briefly (less than 3 seconds) between each selector movement, with the ignition on and the engine not running. The TRANSMISSION SERVICE indicator  illuminates briefly following a reset to acknowledge the reset was successful.

3.4.4 Transmission Health Monitor

This prognostic feature determines clutch life status of the transmission's clutches and alerts you when clutch maintenance is required. The clutch life status is determined by monitoring changes and the calculated running clearance of the transmission clutches.

Clutch Maintenance Notification

The transmission health monitor feature determines when clutch maintenance is needed. If any of the clutches (except lockup) reaches a remaining life of approximately 10% or if any of the clutch running clearances exceeds a maximum value, then the TRANSMISSION SERVICE indicator is steadily illuminated from just after ignition on until ignition is turned off. Thereafter, the indicator will be lit upon each initialization of the TCM, and will remain on steady during all vehicle operation until service is performed and the indicator is reset. If the transmission health monitor mode has been accessed via the shift selector, a "TRANS HEALTH OK" or "TRANS HEALTH LO" is displayed. An acceptable clutch life status is

displayed as "TRANS HEALTH OK". An unacceptable clutch life status is displayed as "TRANS HEALTH LO".

Read and Reset Transmission Health Monitor from Selector

To enter the transmission health monitor, press simultaneously the ▲ (Upshift) and ▼ (Downshift) arrows four times. An acceptable clutch life status is displayed as "TRANS HEALTH OK". An unacceptable filter life status is displayed as "TRANS HEALTH LO".

The feature will **reset** automatically upon elimination of the clutch clearance condition which initiated it. The indicator can also be manually reset using the Allison DOC™ for PC diagnostics program if necessary.

The following table illustrates how to access Oil Level Check, Prognostics & Diagnostic Troubleshooting Codes functions on the Allison pushbutton shift selector.

▲ (Upshift) & ▼ (Downshift) arrow buttons pressed simultaneously *	Description	Message	
1 st press	Allison transmission oil level check		
2 nd press	Oil Life Monitor	" O "	" M "
	Oil life remaining will range from 99% down to 00%	Some number from 9 to 0	Some number from 9 to 0
3 rd press	Filter Life Monitor	" F "	" M "
	Present life of filter is acceptable	OIL FILTER OK	
	Present life of filter is unacceptable	REPLACE FILTERS	
4 th press	Transmission Health Monitor	" T "	" M "
	Shows " TRANS HEALTH OK " until remaining life of one or more of the clutch(es) wear enough so that the programming changes	TRANS HEALTH OK	
	One or more of the clutches have worn enough to change the program	TRANS HEALTH LO	
5 th press	Display of diagnostic codes		

* With the engine off and ignition on.

Section 07: TRANSMISSION

3.5 OIL AND FILTER CHANGE INTERVAL

TABLE 1

Allison Transmission Recommended Fluid And Filter Change Intervals With Prognostics Mode <u>Disabled</u>					
Using TES389 or Mixture					
Severe vocation³			General vocation⁴		
Coaches or MTH equipped with retarder			Coaches or MTH without retarder		
Fluid	Filters		Fluid	Filters	
	Main & Lube	Internal		Main & Lube	Internal
Whichever is the first of the following: 12,000 Miles (20 000 km) 6 Months/ 500hrs <i>Note: always replace main and lube filters with the fluid change</i>	Whichever is the first of the following: 12,000 Miles (20 000 km) 6 Months/ 500hrs <i>Note: always replace main and lube filters with the fluid change</i>	Overhaul	Whichever is the first of the following: 25,000 Miles 40 000 km 12 Months/ 1000hrs <i>Note: always replace main and lube filters with the fluid change</i>	Whichever is the first of the following: 25,000 Miles 40 000 km 12 Months/ 1000hrs <i>Note: always replace main and lube filters with the fluid change</i>	Overhaul

TABLE 2

Allison Transmission Recommended Fluid And Filter Change Intervals¹ With Prognostics Mode <u>Disabled</u>					
Using 100% TranSynd or TES295 Approved Fluid²					
Severe vocation³			General vocation⁴		
Coaches or MTH equipped with retarder			Coaches or MTH without retarder		
Fluid	Filters		Fluid	Filters	
	Main & Lube	Internal		Main & Lube	Internal
Whichever is the first of the following: 150,000 Miles (240 000 km) 48 Months/ 6000hrs <i>Note: always replace main and lube filters with the fluid change</i>	Whichever is the first of the following: 75,000 Miles (120 000 km) 36 Months/ 3000hrs <i>Note: always replace main and lube filters with the fluid change</i>	Overhaul	Whichever is the first of the following: 300,000 Miles (480 000 km) 48 Months 6000hrs <i>Note: always replace main and lube filters with the fluid change</i>	Whichever is the first of the following: 75,000 Miles (120 000 km) 36 Months 3000hrs <i>Note: always replace main and lube filters with the fluid change</i>	Overhaul

¹ Extended TransyndeTES295 fluid and filter change intervals are only allowed with Allison High-Capacity filters.

² Less than 100% concentration of TranSynd or TES295 approved fluid is considered a mixture and should utilize TES389 change intervals. If the customer replaces non-TranSynd or non-TES295 fluid with TranSynd or TES295 equivalent, the change interval recommendations of TES389 or mixture must be followed. Upon the next oil change, if the customer reinstall TranSynd or TES295 equivalent, the fluid & filter change recommendation outlined in 100% TES295 approved fluids must be followed.

³ Severe vocation= All retarder, On/Off highway, transit and intercity coach with duty cycle greater than one (1) stop per mile.

⁴ General vocation= intercity coach with duty cycle less than or equal to one (1) stop per mile and all other vocations not listed in severe vocation.

TABLE 3

Recommended Fluid And Filter Change Intervals With Prognostics Mode <u>Enabled</u>			
	FLUID CHANGE INTERVALS	HIGH CAPACITY MAIN & LUBE FILTERS CHANGE INTERVALS	SUCTION FILTER ASSEMBLY CHANGE INTERVAL
TES295	Whichever is the first of the following: <ul style="list-style-type: none"> If the TRANS SERVICE indicator in the shift selector is illuminated steady for 2 minutes after D (drive) is selected 60 calendar months <i>Note: always replace main and lube filters with the fluid change</i>	Whichever is the first of the following: <ul style="list-style-type: none"> If the TRANS SERVICE indicator in the shift selector is illuminated steady for 2 minutes after D (drive) is selected 60 calendar months Any time fluid is changed 	At time of transmission overhaul
TES389	Whichever is the first of the following: <ul style="list-style-type: none"> If the TRANS SERVICE indicator in the shift selector is illuminated steady for 2 minutes after D (drive) is selected 24 calendar months <i>Note: always replace main and lube filters with the fluid change</i>	Whichever is the first of the following: <ul style="list-style-type: none"> If the TRANS SERVICE indicator in the shift selector is illuminated steady for 2 minutes after D (drive) is selected 24 calendar months Any time fluid is changed 	At time of transmission overhaul
Prognostics Mode requires the use an Allison approved TES295 or TES389 transmission fluid and Allison High Capacity filters.			
A mixture of TES295 and TES389 fluid must continue to use the TES389 fluid change intervals, until two fluid changes with only TES295 fluid have occurred, at which time the TES295 schedule may be used.			

3.5.1 Oil and Filter Change Interval with Prognostics Mode Disabled

Allison transmissions are factory fill with **Castrol TranSynd** fluid. Oil change must be performed with the vehicle on a flat and level surface and with parking brake applied. Oil and filter change frequency is determined by the severity of service and operating conditions of the transmission and by the filter equipment installed. See "TABLE 1 or TABLE 2" for oil and filter change intervals when PROGNOSTIC MODE is **disabled**. More frequent changes may be required when operations are subject to high levels of contamination or overheating. Filters must be changed at or before recommended intervals.

IMPORTANT NOTE

Your transmission is equipped with **High Capacity filters**. High Capacity filters allow for increased fluid and filter change intervals in transmissions utilizing TES295 approved fluid or TranSynd. High Capacity filters eliminate the requirement of the initial 5000 miles (8000km) main filter change.

IMPORTANT NOTE

Allison Transmission recommends that customers use fluid analysis as the primary method for determining fluid change intervals. Many customers have a systematical annual transmission fluid change while, in many cases, fluid analysis could demonstrate that the transmission fluid is still in good condition and a fluid change is not required. In the absence of a fluid analysis program, the fluid change interval listed in TABLE 1 & TABLE 2 should be used.

3.5.2 Oil and Filter Change Interval with Prognostics Mode Enabled

Oil Life Monitor and Filter Life Monitor of the Prognostics mode provide indicators of required maintenance actions. They are designed to maximize fluid and filter utilization. **Prognostics enabled require the use of an Allison approved TES295 or TES389 transmission fluid and Allison High Capacity filters**. If any other fluids or filters are used, Prognostic mode

Section 07: TRANSMISSION

must be disabled. Prognostic information will not be accurate with any other fluids or filters and could result in missed maintenance activities resulting in transmission damage. See "TABLE 3 for oil and filter change intervals with PROGNOSTIC MODE **enabled**.

IMPORTANT NOTE

A mixture of TES295 and TES389 fluid must continue to use the TES389 fluid change intervals, until two fluid changes with only TES295 fluid have occurred, at which time the TES295 schedule may be used.

Calendar-based change intervals of TABLE 3 must still be adhered to for both fluid and filter changes even if Prognostics has not indicated the need for either fluid or filter maintenance, unless fluid analysis is used.

3.6 FLUID AND FILTER CHANGE PROCEDURE

3.6.1 Drain

1. The transmission should be at an operating temperature of 160°F (71°C) to 200°F (93°C) when the oil is drained. This will ensure quicker and more complete fluid drainage.
2. Remove the drain plug from under the transmission (Figure 7) and allow the oil to drain into a suitable container. Check the condition of the oil as described previously.
3. Remove twelve bolts (item 1), two filter covers (item 2), two gaskets (item 3), two O-rings (item 4), two O-rings (item 5) and the two filters (item 6) from the bottom of the control module (Figure 7).
4. When reinstalling parts, lubricate and install new O-rings (4) and (5) on each cover (2). Lubricate O-ring inside filter (6) and push filter onto cover (2). Install new gaskets (3) on cover (2) and align holes in gaskets with holes in cover.



CAUTION

Do not use bolts to draw the cover to sump. This can damage the cover, seal, or sump.

5. Install filter and cover assemblies into the filter compartment. Align each filter/cover assembly with the holes in the channel plate/sump. Push the cover assemblies in by hand to seat the seals.

6. Install twelve bolts and both covers, and then tighten to 38-45 Ft-lbs (51-61 Nm).
7. Inspect the drain plug and O-ring. Replace if necessary. Reinstall the drain plug and tighten to 18-24 Ft-lbs (25-32 Nm).

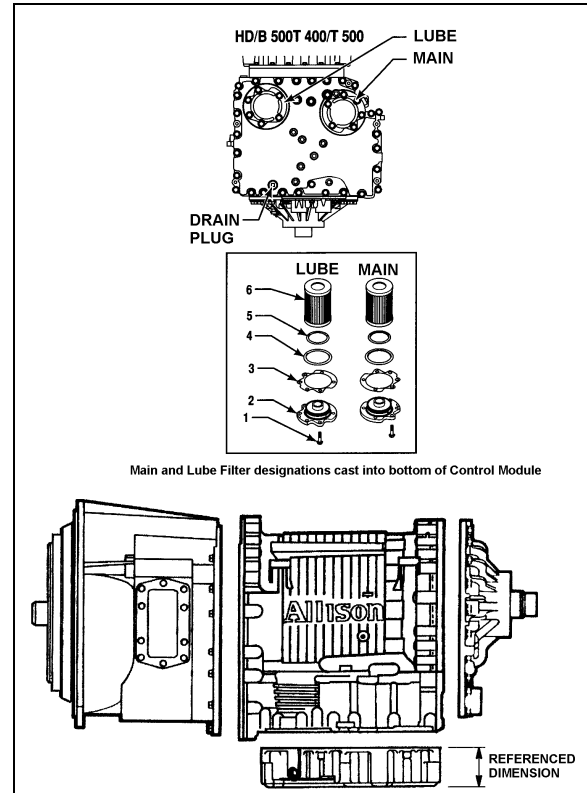

FIGURE 7: DRAIN PLUG AND FILTERS

07052

Fluid loss with filter change only

When changing main and lube filters at recommended intervals, approximate fluid loss for each filter as follows:

Main filter = 2 quarts (1.9 liters)

Lube filter = 8 quarts (7.6 liters)

3.6.2 Refill transmission

The amount of refill fluid is less than the amount used for the initial fill. Fluid remains in the external circuits and transmission cavities after draining the transmission.

NOTE

Quantities listed below are approximations and do not include external oil cooler lines.

Using the oil level dipstick filler tube, refill with 24 US qts (23 liters), 28 US qts (26.5 liters) if equipped with retarder, and check the oil level

using the **Fluid Level Check Using Pushbutton Shift Selector** procedure in this section. Add transmission fluid according to pushbutton shift selector fluid level check.

3.7 CLEANING AND INSPECTION OF ALLISON AUTOMATIC TRANSMISSION

The exterior of the transmission should be cleaned and inspected at regular intervals. The length of service and severity of operating conditions will determine the frequency of such inspections. Inspect the transmission for:

1. Loosen bolts (transmission and mounting components);
2. Oil leaks (correct immediately);
3. Loose, dirty, or improperly adjusted throttle sensor linkage;
4. Damaged or loose oil lines;
5. Worn or frayed electrical harnesses, improper routing;
6. Worn or out of phase drive line U-joint and slip fittings.



CAUTION

DO NOT pressure wash the transmission electrical connectors. Water and detergent will cause the contacts to corrode or become faulty.

3.7.1 Breather

The breather is located on the engine, flywheel side near the valve cover. It serves to prevent pressure build-up within the transmission and must be cleaned to keep the passage opened. The prevalence of dust and dirt will determine the frequency at which the breather requires cleaning. Use care when cleaning the engine. Spraying steam, water or cleaning solution directly at the breather can force the water or solution into the transmission. Always use care when removing the hose connector from transmission to prevent the entry of foreign matter.

4. TRANSMISSION OIL COOLER REMOVAL

4.1 TRANSMISSION WITHOUT RETARDER

Stop engine and allow engine to cool. Close both heater line shutoff valves (refer to Section 05 "Cooling").

To drain the cooling system, proceed as per Section 05 "Cooling", paragraph 5: Draining. If the cooling system is contaminated, flush system as per Section 05 "Cooling", paragraph 7: Flushing.

1. Remove the rear L.H. side tag axle wheel, then remove the rear L.H. side fender panel.
2. Disconnect the two transmission hoses from oil cooler. Cover hose ends and fittings to prevent fluid contamination (Figure 8).



WARNING

A significant amount of oil may drain from oil lines when they are disconnected.

3. Unfasten the constant-torque hose clamps and remove the two hoses.
4. Unscrew the four holding nuts and remove the U-bolts, remove the oil cooler from engine compartment.
5. Reinstall transmission oil cooler by using reverse procedure.

4.2 TRANSMISSION WITH RETARDER

Stop engine and allow engine to cool. Close both heater line shutoff valves (refer to Section 05 "Cooling").

1. To drain the cooling system, proceed as per Section 05 "Cooling", paragraph 5: Draining. If the cooling system is contaminated, flush system as per Section 05 "Cooling", paragraph 7: Flushing.
2. Remove the rear L.H. side tag axle wheel, then remove the rear L.H. side fender panel.
3. Disconnect the transmission hoses from oil cooler. Cover hose ends and fittings to prevent fluid contamination.

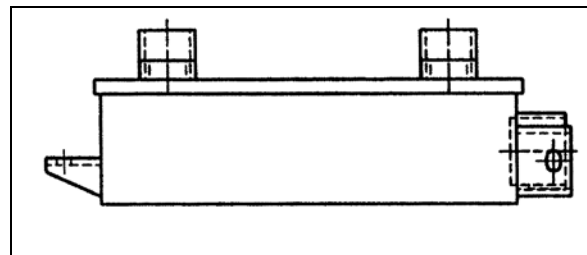

FIGURE 8: COOLER WITH RETARDER 07073



WARNING

A significant amount of oil may drain from oil lines when they are disconnected.

4. Unfasten the constant-torque hose clamps and remove the two hoses.
5. Unscrew the holding bolts and nuts and remove the oil cooler from engine compartment.

5. ALLISON TRANSMISSION INSTALLATION

1. Place the transmission on a transmission jack.
2. Install a headless guide bolt into one of the 12 threaded holes for flexible plate attaching screws in the flywheel.

NOTE

For more clearance between the tag axle and transmission, the tag axle may be unloaded and jacked up, or retracted (if applicable).

With the starter motor removed, align one of the 12 attaching screw holes in the flexible plate with the access opening.

3. Lubricate the flywheel center pilot boss with molybdenum disulfide grease (Molycote G, or equivalent).
4. Raise transmission and position the flywheel pilot boss into the flexible plate adapter. Align the guide bolt previously installed in the flywheel with the flexible plate hole facing the access opening in the flywheel housing.



WARNING

Severe damages and/or personal injury can occur if transmission is not adequately supported.

5. Seat the transmission against the engine flywheel housing. **NO FORCE IS REQUIRED.** If interference is encountered, move the transmission away from engine, then investigate the cause.



CAUTION

The torque converter housing must be seated against the flywheel housing prior to tightening any screws. **DO NOT USE SCREWS TO SEAT THE HOUSING.**

6. Start all torque converter housing screws, and then tighten four of them gradually and in a criss-cross sequence around the housing. Tighten the 12 remaining screws. Recommended torque is between 42-50 Lbf-ft (57-68 Nm).
7. Remove the guide bolt through the access opening in the flywheel housing. Replace it with a self-locking screw, finger-tighten then start the remaining screws; tighten to 17-21 lbf-ft (23-28 Nm). Place a wrench on the crankshaft pulley attaching screw to turn the converter to gain access to the threaded holes.

NOTE

Remove the plug located below starter motor and install cranking tool (88800014). Crank the engine to gain access to the threaded holes by turning the cranking tool using a suitable adapter.

Reinstall starter motor and connect cables.

Reinstall access plug below starter motor.

8. Remove jack from under transmission.
9. Connect all sensors.
10. Connect the main wiring harness.
11. Connect the air supply line (steel-braided hose) to the retarder control valve (if applicable).
12. Connect the two transmission oil cooler hoses as they were previously.
13. Reinstall clamps and brackets, and replace locking ties previously removed during removal procedure.
14. Install propeller shaft and its safety guard. Refer to Section 09, "PROPELLER SHAFT".
15. Install transmission dipstick and filler tube.
16. Install cross member under transmission.
17. Install engine splash guards.
18. Adjust the retarder pressure to 80 ± 3 psi with the air pressure regulator. For more information refer to Section 12, "BRAKE AND AIR SYSTEM", under heading "AIR PRESSURE REGULATOR". The air pressure regulator is located at back of engine compartment, on R.H. side (Figure 9) or in the R.H. side rear service compartment.

19. Make sure that the drain plug is in place, and then remove the transmission dipstick and pour approximately 24 US quarts (23 L) of automatic transmission fluid through the filler tube. Check and adjust oil level.

**CAUTION**

Do not overfill the transmission. Overfilling can cause oil aeration (milky appearance) and overheating. If overfilling occurs, drain oil as required to bring it to the proper level.

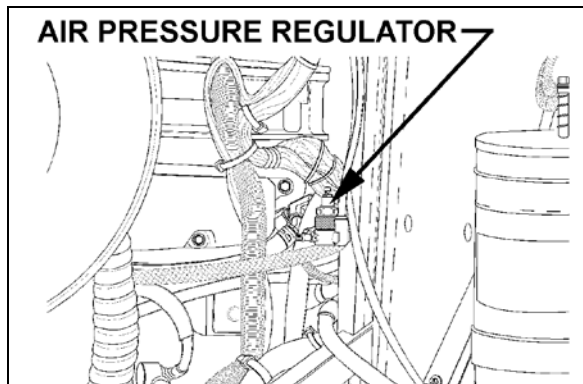

FIGURE 9: AIR PRESSURE REGULATOR (TYPICAL) 07037

6. ALLISON TRANSMISSION TROUBLESHOOTING

The Allison transmission has a new Transmission Control Module (TCM) which involves specific diagnostic incident codes. The TCM unit is located in the coach main power compartment.

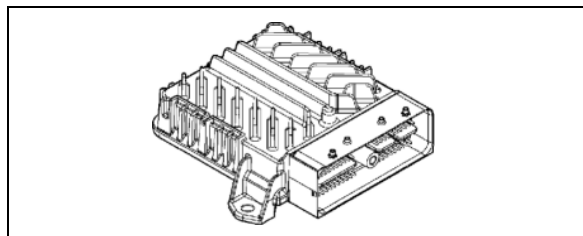

FIGURE 10: TRANSMISSION CONTROL MODULE 07140

TCM Replacement

The TCM is a non-serviceable electronic device. When it fails, it must be replaced using the following procedure:

- Open the coach main power compartment in order to get access to the TCM;
- Remove the electrical cable connectors;

- Unscrew the TCM unit;
- Replace by reversing the procedure.

**CAUTION**

Place the battery master switch to the "OFF" position.

6.1 DIAGNOSTIC TROUBLESHOOTING CODES (DTC) — ALLISON 5TH GENERATION CONTROLS

Diagnostic features are provided with the transmission control system to assist in troubleshooting of malfunctions and/or the monitoring of specific operating parameters. When a control system malfunction is detected, a series of Diagnostic Trouble Codes (DTCs) are used to identify and clarify the nature of the malfunction. These DTCs are each named by a 5 character alphanumeric string that refers to a diagnostic algorithm running pass/fail tests to help identify a malfunction in the transmission or vehicle operation. Most DTCs have some kind of diagnostic response that the operator notices, such as an illuminated CHECK light, selector display change, lock in range, or inhibit shifts condition.

DTCs are logged in the Transmission Control Module (TCM) memory by severity and by their active/inactive status with the most severe and active codes listed first. A maximum of five DTCs (numbered d1- d5) from most recent to oldest may be read from the shift selector. As DTCs are added, the oldest inactive DTC (historic) is dropped from the list. If all DTCs are active, the DTC with the lowest priority is dropped from the list.

An active code is any code that is current in the TCM decision-making process and has failed the DTC test(s) associated with that specific diagnostic algorithm. Historical codes, which are by definition inactive, are codes that are no longer failing their algorithm but are retained in the TCM in order to help the technician analyze possible causes and provide them direction if the vehicle is brought in before they are cleared from the queue.

DTCs can be cleared manually by the operator or they clear automatically from last (d5) to first

(d1) in the queue after a number of engine starts, without becoming active again.

6.1.1 Using Shift Selector for Accessing Diagnostics Information

DTCs can be displayed on the display portion of the shift selector. A DTC is either active or historic. An active DTC is a DTC that is current in the TCM decision-making process. Historic DTCs are retained in the TCM memory and do not necessarily affect the TCM decision-making process.

6.1.2 Display Sequence

Up to five DTCs may be displayed one at a time from the selector once the diagnostic display mode has been initiated by the operator. Each DTC is 5 characters in length. The DTC status active or inactive is shown below the DTC.



Shows active DTC P0730

The operator presses the MODE button to read the next OTC in the queue (if any) or requests to exit diagnostics mode. The diagnostics mode times out and returns the selector to normal operating mode after approximately 10 minutes of operator inactivity.

6.1.3 Diagnostic Code Display and Clearing Procedure

Diagnostic codes can be read and cleared by two methods:

- Using an Allison DOC™ diagnostic tool. For specific instructions on how to use an Allison DOC™ diagnostic tool, refer to the User Guide.
- Using the pushbutton shift selector.

To begin the diagnostic process:

1. Bring the vehicle to a stop at a safe location.
2. Apply the parking brake.

To display stored codes:

1. Simultaneously press the ▲ (Upshift) and ▼ (Downshift) arrow buttons five times (Prognostics enabled) to access the Diagnostic Display Mode. With Prognostics disabled, press the ▲ (Upshift) and ▼ (Downshift) arrow buttons twice.

2. Press the MODE button to read the next code in the queue, if any.

To clear all active stored codes:

While in Diagnostic Mode, clear all active codes by pressing and holding the MODE button for approximately three seconds until the MODE message flashes. Release the MODE button. The MODE message should not remain illuminated if the active DTC shown in the display has cleared.

While in Diagnostic Mode, press and hold the MODE button for 10 seconds to clear both active codes and inactive codes. The MODE message flashes a second time indicating all codes are cleared from the queue.

6.1.4 Exiting Diagnostic Mode

Exit the diagnostic mode by one of the following methods:

1. Press simultaneously the ▲ (Upshift) and ▼ (Downshift) arrow buttons at the same time on the pushbutton shift selector.
2. Press any range button «D», «N» or «R» on the pushbutton shift selector.
3. After approximately 10 minutes of inactivity at the pushbutton shift selector, the diagnostic mode automatically exits and returns to normal operating mode.
4. Turn off power to the TCM (shut off the engine using the ignition key).

NOTE

Be sure to record all codes displayed before they are cleared. This is essential for troubleshooting.

NOTE

If clearing a code while locked in a «D» (Drive) or «R» (Reverse) position (fail-to-range), the transmission will still be in «D» (Drive) or «R» (Reverse) when the clearing procedure is completed. «N» (Neutral) must be manually selected.

6.1.5 Diagnostic Trouble Code Response

The electronic control system is programmed to inform the operator of a problem with the transmission system via the CHECK light and shift selector display while it automatically takes

action to protect the operator, vehicle, and transmission. When the Transmission Control Module (TCM) flags a Diagnostic Trouble Code (DTC) as active, the TCM may take a combination of diagnostic responses as listed in the following table.

CATEGORY OF RESPONSE	ACTIONS TAKEN
DNS - Do Not Shift	Release lock up (LU) clutch and inhibit lock up operation. Inhibit shifts from the current attained range. Turn on the CHECK light. Display the current attained range in the MONITOR window of the shift selector. Blank the SELECT window of the shift selector. Ignore any range selection inputs from the shift selector.
SOL OFF - SOLEnoid OFF	All solenoids are commanded off, resulting in hydraulic default operation of the transmission – PCS1 & PCS2 are on hydraulically when off electrically.
RPR - Return to Previous Range	When the speed sensor ratio or PS1 tests do not pass, the TCM commands the same range as commanded before the shift.
NNC - Neutral No Clutches	When certain speed sensor ratio or PS1 tests do not pass, the TCM a neutral condition with no clutches applied.
DNA - Do Not Adapt	The TCM stops adaptive shift control while the code is active.

6.2 DIAGNOSTIC TROUBLESHOOTING CODES (DTC) LIST - ALLISON 5TH GENERATION CONTROLS

DTC	Description	CHECK Light	Inhibited Operation Description
C1312	Retarder Request Sensor Failed Low	No	May inhibit retarder operation if not using J1939 datalink
C1313	Retarder Request Sensor Failed High	No	May inhibit retarder operation if not using J1939 datalink
P0122	Pedal Position Sensor Circuit Low Voltage	No	Use default throttle values. Freezes shift adapts.
P0123	Pedal Position Sensor Circuit High Voltage	No	Use default throttle values. Freezes shift adapts.
P0218	Transmission Fluid Over Temperature	Yes	Use default sump temp
P0562	System Voltage Low	No	Inhibit TCC Operation, DNA
P0602	TCM Not Programmed	Yes	Lock in Neutral
P0604	Control module random access memory (RAM)	Yes	Lock in Neutral
P0614	Torque Control Data Mismatch - ECM/TCM	Yes	Allows operation only in reverse and second range.
P0634	TCM Internal Temperature Too High	Yes	SOL OFF (hydraulic default)
P0642	Sensor Reference Voltage "A" Circuit Low	Yes	Default sensor data used
P0643	Sensor Reference Voltage "A" Circuit High	Yes	Default sensor data used
P0657	Actuator Supply Circuit Voltage 1 Open (HSD 1)	Yes	SOL OFF, DNA, Inhibit TCC operation, Inhibit main modulation
P0658	Actuator Supply Voltage 1 (HSD1) Low	Yes	DNS, SOL OFF (hydraulic default)
P0659	Actuator Supply Voltage 1 (HSD1) High	Yes	DNS, SOL OFF (hydraulic default)

Section 07: TRANSMISSION

DTC	Description	CHECK Light	Inhibited Operation Description
P0703	Brake Switch Circuit Malfunction	No	No Neutral to Drive shifts for refuse packer. TCM inhibits retarder operation if a TPS code is also active.
P0708	Transmission Range Sensor Circuit High Input	Yes	Ignore defective strip selector inputs
P070C	Transmission Fluid Level Sensor Circuit – Low Input	No	None
P070D	Transmission Fluid Level Sensor Circuit – High Input	No	None
P0712	Transmission Fluid Temperature Sensor Circuit Low Input	Yes	Use default sump temp
P0713	Transmission Fluid Temperature Sensor Circuit High Input	Yes	Use default sump temp
P0715	Turbine Shaft Speed Sensor Circuit	Yes	DNS, Lock in current range
P0716	Turbine Shaft Speed Sensor Circuit Performance	Yes	DNS, Lock in current range
P0717	Turbine Shaft Speed Sensor Circuit No Signal	Yes	DNS, Lock in current range
P071A	RELS Input Failed On	Yes	Inhibit RELS operation
P071D	General Purpose Input Fault	Yes	None
P0720	Output Shaft Speed Sensor Circuit	Yes	DNS, Lock in current range
P0721	Output Shaft Speed Sensor Circuit Performance	Yes	DNS, Lock in current range
P0722	Output Speed Sensor Circuit No Signal	Yes	DNS, Lock in current range
P0725	Engine Speed Sensor Circuit	No	Default to turbine speed
P0726	Engine Speed Sensor Circuit Performance	No	Default to turbine speed
P0727	Engine Speed Sensor Circuit No Signal	No	Default to turbine speed
P0729	Incorrect 6 th Gear Ratio	Yes	DNS, Attempt 5 th , then 3 rd
P0731	Incorrect 1 st Gear ratio	Yes	DNS, Attempt 2 nd , then 5 th
P0732	Incorrect 2 nd Gear ratio	Yes	DNS, Attempt 3 rd , then 5 th
P0733	Incorrect 3 rd Gear ratio	Yes	DNS, Attempt 4 th , then 6 th
P0734	Incorrect 4 th Gear ratio	Yes	DNS, Attempt 5 th , then 3 rd
P0735	Incorrect 5 th Gear ratio	Yes	DNS, Attempt 6 th , then 3 rd , then 2 nd
P0736	Incorrect Reverse Gear ratio	Yes	DNS, Lock in Neutral
P0741	Torque Converter Clutch System Stuck Off	Yes	None
P0752	Shift Solenoid 1 Valve Performance-Stuck On	Yes	DNS
P0776	Pressure Control Solenoid (PCS) 2 Stuck Off	Yes	DNS, RPR
P0777	Pressure Control Solenoid 2 Stuck On	Yes	DNS, RPR
P0796	Pressure Control Solenoid 3 Stuck Off	Yes	DNS, RPR
P0797	Pressure Control Solenoid 3 Stuck On	Yes	DNS, RPR
P0842	Transmission Fluid Pressure Switch 1 Circuit Low	Yes	DNS, Lock in current range
P0843	Transmission Fluid Pressure Switch 1 Circuit High	Yes	DNS, Lock in current range
P0847	Transmission Fluid Pressure Switch 2 Circuit Low	Yes	None
P0848	Transmission Fluid Pressure Switch 2 Circuit High	Yes	None
P088A	Transmission Fluid Filter Maintenance Alert	No	None
P088B	Transmission Fluid Filter Maintenance Required	No	None
P0880	TCM Power Input Signal	No	None
P0881	TCM Power Input Signal Performance	No	None
P0882	TCM Power Input Signal Low	Yes	DNS, SOL OFF (hydraulic default)
P0883	TCM Power Input Signal High	No	None
P0894	Unexpected Mechanical Gear Disengagement	Yes	DNS, Lock in first
P0897	Transmission Fluid Deteriorated	No	None
P0960	Main Pressure Modulator Solenoid Control Circuit Open	Yes	None
P0962	Main Pressure Modulator Solenoid Control Circuit Low	Yes	DNS, SOL OFF (hydraulic default)
P0963	Main Pressure Modulator Solenoid Control Circuit High	Yes	None
P0964	Pressure Control Solenoid 2 (PCS2) Control Circuit Open	Yes	DNS, SOL OFF (hydraulic default)
P0966	Pressure Control Solenoid 2 (PCS2) Control Circuit Low	Yes	DNS, SOL OFF (hydraulic default)
P0967	Pressure Control Solenoid 2 (PCS2) Control Circuit High	Yes	DNS, SOL OFF (hydraulic default)
P0968	Pressure Control Solenoid 3 (PCS3) Control Circuit Open	Yes	DNS, SOL OFF (hydraulic default)
P0970	Pressure Control Solenoid 3 (PCS3) Control Circuit Low	Yes	DNS, SOL OFF (hydraulic default)
P0971	Pressure Control Solenoid 3 (PCS3) Control Circuit High	Yes	DNS, SOL OFF (hydraulic default)
P0973	Shift Solenoid 1 (SS1) Control Circuit Low	Yes	DNS, SOL OFF (hydraulic default)
P0974	Shift Solenoid 1 (SS1) Control Circuit High	Yes	DNS, SOL OFF (hydraulic default)

DTC	Description	CHECK Light	Inhibited Operation Description
P0976	Shift Solenoid 2 (SS2) Control Circuit Low	Yes	7-speed: Allow 2 through 6, N, R Inhibit TCC operation
P0977	Shift Solenoid 2 (SS2) Control Circuit High	Yes	7-speed: Allow 2 through 6, N, R
P097A	Shift Solenoid 1 (SS1) Control Circuit Open	Yes	Lock in range
P097B	Shift Solenoid 2 (SS2) Control Circuit Open	Yes	7-speed: Allow 2 through 6, N, R
P0989	Retarder Pressure Sensor Circuit Low	No	None
P0990	Retarder Pressure Sensor Circuit High	No	None
P1739	Incorrect Low Gear Ratio	Yes	Command 2 nd and allow shifts 2 through 6, N, R
P1790	Gear Shift Module 1 Calibrated Invalid	Yes	Shift selector language or units incorrect
P1791	Gear Shift Module 2 Calibrated Invalid	Yes	Shift selector language or units incorrect
P1891	Throttle Position Sensor PWM Signal Low	No	Use default throttle values
P1892	Throttle Position Sensor PWM Signal High	No	Use default throttle values
P2184	Engine Coolant Temperature Sensor 2 Circuit Low Input	No	Use default engine coolant values
P2185	Engine Coolant Temperature Sensor 2 Circuit High Input	No	Use default engine coolant values
P2637	Torque Management Feedback Signal (A)	Yes	Inhibit SEM
P2641	Torque Management Feedback Signal (B)	Yes	Inhibit LRTP
P2669	Actuator Supply Circuit Voltage 2 Open (HSD2)	Yes	SOL OFF, Inhibit TCC operation, Inhibit Main modulation, ONA
P2670	Actuator Supply Voltage 2 (HSD2) Low	Yes	DNS, SOL OFF (hydraulic default)
P2671	Actuator Supply Voltage 2 (HSD2) High	Yes	DNS, SOL OFF (hydraulic default)
P2684	Actuator Supply Circuit Voltage 3 Open (HSD3)	Yes	SOL OFF, Inhibit TCC operation, Inhibit Main modulation, ONA
P2685	Actuator Supply Voltage 3 (HSD3) Low	Yes	DNS, SOL OFF (hydraulic default)
P2686	Actuator Supply Voltage 3 (HSD3) High	Yes	DNS, SOL OFF (hydraulic default)
P2714	Pressure Control Solenoid 4 (PCS4) Stuck Off	Yes	DNS, RPR
P2715	Pressure Control Solenoid 4 (PCS4) Stuck On	Yes	DNS, SOL OFF (hydraulic default)
P2718	Pressure Control Solenoid 4 (PCS4) Control Circuit Open	Yes	DNS, SOL OFF (hydraulic default)
P2720	Pressure Control Solenoid 4 (PCS4) Control Circuit Low	Yes	DNS, SOL OFF (hydraulic default)
P2721	Pressure Control Solenoid 4 (PCS4) Control Circuit High	Yes	DNS, SOL OFF (hydraulic default)
P2723	Pressure Control Solenoid 1 (PCS1) Stuck Off	Yes	DNS, RPR
P2724	Pressure Control Solenoid 1 (PCS1) Stuck On	Yes	DNS, RPR
P2727	Pressure Control Solenoid 1 (PCS1) Control Circuit Open	Yes	DNS, SOL OFF (hydraulic default)
P2729	Pressure Control Solenoid 1 (PCS1) Control Circuit Low	Yes	DNS, SOL OFF (hydraulic default)
P2730	Pressure Control Solenoid 1 (PCS1) Control Circuit High	Yes	DNS, SOL OFF (hydraulic default)
P2736	Pressure Control Solenoid 5 (PCS5) Control Circuit Open	Yes	Inhibit retarder operation
P2738	Pressure Control Solenoid 5 (PCS5) Control Circuit Low	Yes	Allow 2 through 6, N, R. Inhibit retarder and TCC operation
P2739	Pressure Control Solenoid 5 (PCS5) Control Circuit High	Yes	Inhibit retarder operation
P273F	Retarder Oil Temperature Sensor Over Temperature Condition	No	None
P2742	Retarder Oil Temperature Sensor Circuit – Low	No	Use default retarder temp values
P2743	Retarder Oil Temperature Sensor Circuit – High	No	Use default retarder temp values
P2761	TCC PCS Control Circuit Open	Yes	Inhibit TCC operation
P2763	TCC PCS Control Circuit High	Yes	Inhibit TCC operation
P2764	TCC PCS Control Circuit Low	Yes	7-speed: Allow 2 through 6, N, R. Inhibit TCC operation
P2789	Transmission Clutch Life Expired (Clutch Adaptive Learning at Limit)	No	None
P2793	Gear Shift Direction Circuit	Yes	Ignores PWM input from shift selector
P2808	Pressure Control Solenoid 6 (PCS6) Stuck Off	Yes	DNS, RPR
P2809	Pressure Control Solenoid 6 (PCS6) Stuck On	Yes	DNS, RPR
P2812	Pressure Control Solenoid 6 (PCS6) Control Circuit Open	Yes	DNS, SOL OFF (hydraulic default)
P2814	Pressure Control Solenoid 6 (PCS6) Control Circuit Low	Yes	DNS, SOL OFF (hydraulic default)

Section 07: TRANSMISSION

DTC	Description	CHECK Light	Inhibited Operation Description
P2815	Pressure Control Solenoid 6 (PCS6) Control Circuit High	Yes	DNS, SOL OFF (hydraulic default)
U0073	CAN Communication Bus 1 Off	No	Use default values
U0074	CAN Communication Bus 2 Off	No	Use default values
U0100	Lost Communications with ECM A	Yes	Use default values
U0103	Lost Communication with Gear Shift Module (Shift Selector) 1	Yes	Maintain range selected, observe gear shift direction circuit
U0291	Lost Communication with Gear Shift Module (Shift Selector) 2	Yes	Maintain range selected, observe gear shift direction circuit
U0304	Incompatible Gear Shift Module 1 (Shift Selector)	Yes	Ignore shift selector inputs
U0333	Incompatible Gear Shift Module 2 (Shift Selector)	Yes	Ignore shift selector inputs
U0404	Invalid Data Received From Gear Shift Module (Shift Selector) 1	Yes	Maintain range selected, observe gear shift direction circuit
U0592	Invalid Data Received From Gear Shift Module (Shift Selector) 2	Yes	Maintain range selected, observe gear shift direction circuit

7. ALLISON TRANSMISSION REMOVAL

The following procedure deals with the removal of the Allison transmission without removing the power plant cradle from vehicle. The methods used to support the transmission and engine depend upon conditions and available equipment.

1. Select transmission's "NEUTRAL" positions, apply parking brake, and then set battery master switch to the "OFF" position.
2. Jack up vehicle, then place safety supports underneath body.



CAUTION

Only the recommended jacking points must be used as outlined in Section 18, "BODY".

NOTE

For more clearance between the tag axle and transmission, the tag axle may be unloaded and jacked up or retracted (if applicable).

3. Remove engine splash guards and protective panels surrounding transmission.
4. Remove cross member from under transmission.
5. Remove the transmission drain plug and allow oil to drain. Inspect the drain plug washer and replace it if necessary. Reinstall the drain plug and tighten to 33-41 Lbf-ft (45-56 Nm) (see "3.5 Oil and Filter Change" in this section).
- 6.



WARNING

It is better to drain oil when it is still warm. Avoid contact with oil since it can be very hot and cause personal injury.

7. Remove transmission dipstick and filler tube.
8. Disconnect propeller shaft from transmission and remove its safety guard. Refer to Section 09, "PROPELLER SHAFT".
9. Disconnect the two oil cooler hoses from transmission. Cover hose ends and fittings to prevent fluid contamination.



WARNING

A significant amount of oil may drain from oil lines when they are disconnected.

9. Disconnect all sensors on L.H. side of the transmission.
10. Disconnect main wiring harness.
11. Disconnect the air supply line (steel-braided hose) from retarder control valve (if applicable).
12. Remove any locking tie, clamp and bracket that may interfere with the removal of transmission.
13. Support transmission using a suitable transmission jack.

NOTE

Remove starter motor located on engine L.H. side. Removing the starter motor will allow access to unfasten the 12 converter-to-flexible plate attaching screws. Remove the plug located below starter motor and install cranking tool (88800014). Cranking the engine to gain access to the attaching screws may be done by turning the cranking tool using a suitable adapter (Figure 11).

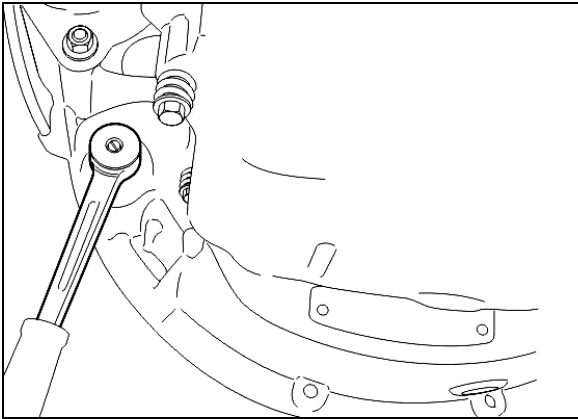

FIGURE 11: VOLVO ENGINE CRANKING POSITION

**CAUTION**

Do not rotate alternator shaft clockwise to avoid removing tension on belt.

14. Remove the 12 screws retaining the torque converter housing to the flywheel housing.

**CAUTION**

Make sure transmission-to-engine alignment is maintained when removing screws to avoid damaging torque converter housing.

15. Slowly pull transmission straight out to clear the engine.
16. Remove the transmission.

8. VOLVO I-SHIFT TRANSMISSION MAINTENANCE

8.1 TRANSMISSION OIL

Keep the transmission oil at the proper level and change it at the Volvo recommended intervals. Always replace the oil filter when the oil is changed. Always use the Volvo approved

synthetic oil whenever adding or changing the transmission oil.

**CAUTION**

Only use Castrol Syntrans SAE 75W85 (Prevost #684516) gearbox oil in the I-Shift transmission. Using non-approved oil can result in damage to transmission components.

**CAUTION**

Never reuse drained I-Shift oil. The oil must be replaced along with the oil filter. Reusing drained oil can result in damage to transmission components.

8.2 CHECKING OIL LEVEL

Check the transmission oil level at each service interval. Park the vehicle on a level surface. Check the oil level through the sight glass on the side of the transmission. Add oil as necessary. Always use the correct Volvo approved synthetic oil (Castrol Syntrans SAE 75W85).

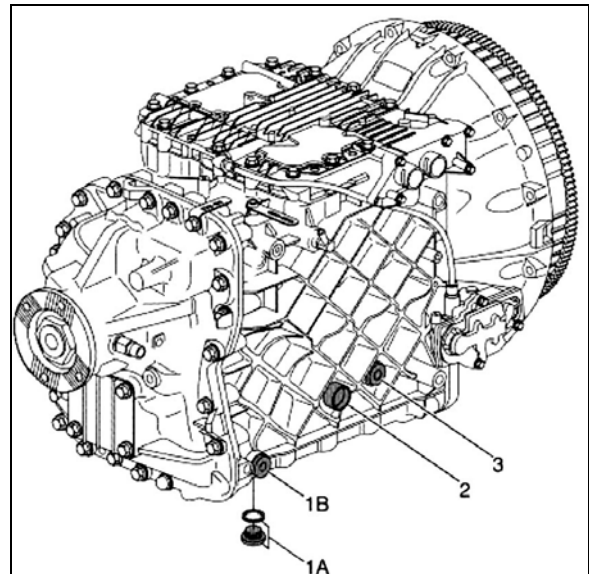

FIGURE 12: I-SHIFT TRANSMISSION OIL CHANGE

- Vehicle should be on horizontal ground when oil is changed;
- Do not check oil level straight after a journey (incorrect measurement). Undertake the check once the transmission oil has cooled down (lower than 104°F or 40 °C);
- Check oil level using transmission sight glass (2) ;

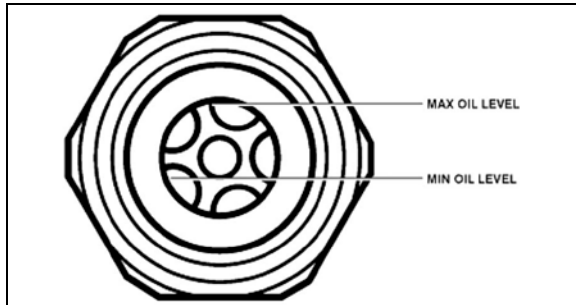

FIGURE 13: SIGHT GLASS FOR CHECKING OIL LEVEL

- Add oil through the oil filling point if necessary (3) ;
- Torque tighten fill plug to 26±4 lb-ft (35±5 Nm).

8.3 OIL CHANGE INTERVAL

The length of time a transmission can operate before an oil change is required depends on the quality of the oil used and the vehicle application.

MAINTENANCE

For on-highway applications, change the transmission oil every 800 000 km (500,000 miles) or every 5 years whichever occurs first. This extended oil change interval only applies when using Castrol Syntans SAE 75W85. Always replace the oil filter when the oil is changed.

For all other vehicle applications and/or when not using Castrol Syntans SAE 75W85, change the transmission oil every 400 000 km (250,000 miles) or every 3 years whichever occurs first.

Always use Volvo approved synthetic oil (Castrol Syntans SAE 75W85) whenever changing the transmission oil.

8.4 OIL CHANGE

Approximately 15 liters (16 quarts) is needed for a complete oil change.

WARNING

Hot oil can cause burns. DO NOT allow hot oil to contact the skin. When changing oil, wear protective gloves.

Remove the drain plug from under the transmission (1A or 1B, Figure 12) and allow the oil to drain into a suitable container.

Inspect the drain plug and O-ring. Replace if necessary. Reinstall the drain plug and tighten to 26±4 lb-ft (35±5 Nm).

CAUTION

Always dispose of all lubricants (engine oil, coolant, transmission oil, etc) and filters according to Federal or local regulations.

Change the oil filter (#20779040) at every oil change. Drain the oil filter housing before you remove the filter.

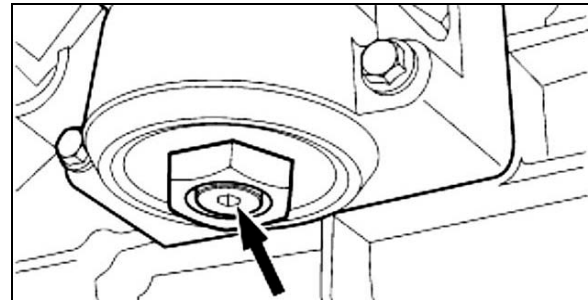

FIGURE 14: OIL FILTER HOUSING DRAIN PLUG

NOTE

Torque tighten oil filter housing drain plug to 16±2 Nm (12±1 lb-ft).

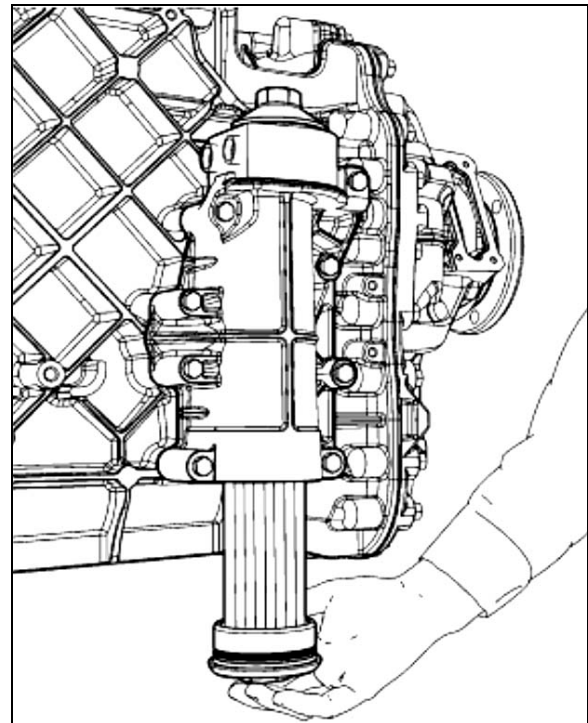

FIGURE 15: OIL FILTER

9. VOLVO I-SHIFT TRANSMISSION TECU FAULT CODES

FUNCTION	PID/SID	FMI J1587	ERROR	CONDITION	SYMPTOM	COMMENT
Brake switch	PID65	FMI14	Brake interlock active	<p>Activate: The gearlever is moved from neutral without prior application of the service brake</p> <p>Deactivate: The gearlever is returned to neutral or the vehicle speed is above 5km/h</p>	White lamp is sent together with a pop-up message The transmission will not engage the selected gear (stays in neutral)	<p>Conditions for activation: (and) The brake interlock function is activated (VTNA vehicles only) The vehicle speed is below 5km/h The gear lever is moved from neutral or in folded position without prior activation of the service brake or parking brake</p> <p>Conditions for deactivation: (either) The vehicle speed is above 5km/h The gearlever is returned to neutral or folded position</p>
Calibration memory	SID253	FMI13	Out of range	<p>Active: Flash CS dataset error or program code missing</p> <p>Deactivate: Flash CS OK</p>	Yellow lamp is sent Cranking is inhibited Engine can not start	
Clutch cylinder slip point position	PPID51	FMI13	Calibration value out of range	<p>Activate: 1. The CS in NVRAM is not correct, or 2. The slip point has not been calibrated</p> <p>Deactivate: Slip point has been successfully calibrated</p>	Yellow lamp is sent The vehicle can not drive	
Clutch load on plates	PID50	FMI0	Data valid but above normal operational range	<p>Activate: The calculated stored energy is above 200kJ. The energy calculation is time-based for VTNA and physical for others.</p> <p>Deactivate: 7.0s after activation and, energy below 180 kJ or neutral, or driving without clutch slip</p>	Yellow lamp is sent Start gear changed to gear 1 in A/D, for RTC also in M The clutch is overheated The clutch is slowly engaged	Clutch load on plates are set without any filtering
Clutch load on plates		FMI11	Clutch protection active (unidentifiable error)	<p>Activate: Only activated for VTNA. Clutch slip more than 8.0s with vehicle movement less than 0.8m (e.g. hill holding)</p>	Yellow lamp is sent Start gear changed to gear 1 in A/D, for RTC also in M There has been unnecessary	

Section 07: TRANSMISSION

FUNCTION	PID/SID	FMI J1587	ERROR	CONDITION	SYMPTOM	COMMENT
				event) Deactivate: 7.0s after activation and, acc pedal released more than 6.0s or neutral, or driving without clutch slip	clutch slip The clutch is slowly engaged	
Clutch load on plates		FMI14	Special instructions	Activate: If there is an attempt to start on a high range gear or above gear 4 in VTNA in manual mode Deactivate: The start gear is changed to an allowed gear	White lamp is sent Not possible to start	This fault code is not saved
Clutch plate wear condition	PID36	FMI0	Data valid but above normal operational range	Activate: The clutch wear is more than or equal to "Service due position" Deactivate: The clutch disc is replaced and calibrated	Yellow lamp is sent If active during a long time the clutch may wear out and become damaged	
Clutch position sensor supply (SEPoC5V)	PPID54	FMI0	Data valid but above normal operational range	Activate: Voltage is above normal range Deactivate: Voltage is within normal range	Yellow lamp is sent Reduced clutch performance Reduced gearbox comfort at start and marshalling Gear changes are slow	
Clutch position sensor supply (SEPoC5V)		FMI1	Data valid but below operational range	Activate: Voltage is below normal range Deactivate: Voltage is within normal range	Yellow lamp is sent Reduced clutch performance Reduced gearbox comfort at start and marshalling Gear changes are slow	
Clutch system	PSID27	FMI0	Unintentional disengagement of the clutch	Activate: 1. The clutch disengages when not commanded and, 2. There is no active fault code on the SEPoC and, 3. There is no active fault code for low air pressure and, 4. There is no active fault code	Yellow lamp is sent Slow gear changes Low clutch performance	Detailed conditions to activate/deactivate The following conditions must be fulfilled three times (only once if the fault code-filter is switched OFF) in a row in order to set the fault code: - The clutch has been engaged for less than 10s with inactive engagement valves - The clutch cylinder position has been at least 1mm below the engaged limit at some point during

FUNCTION	PID/SID	FMI J1587	ERROR	CONDITION	SYMPTOM	COMMENT
				<p>on any of the clutch cylinder valves and, 5. The PCB temperature is above a specific limit</p> <p>Deactivate: The clutch response is OK</p>		<p>this time</p> <ul style="list-style-type: none"> - The clutch leaves the engaged state - The clutch disengagement valves are inactive - There is no active fault code on any of the clutch cylinder position sensor (SEPoC) the clutch valves - There is no active fault code for low air pressure - The PCB temperature is above 10 dgC <p><i>The fault is deactivated if any of the following conditions are fulfilled:</i></p> <ul style="list-style-type: none"> - The clutch has been engaged for more than 20s with inactive engagement valves - There is an active fault code for the clutch cylinder position sensor (SEPoC)
Clutch system		FMI1	Unintentional engagement of the clutch	<p>Activate: 1. The clutch engages when not commanded and, 2. There is no active fault code on the SEPoC and, 3. There is no active fault code for low air pressure and, 4. There is no active fault code on any of the clutch cylinder valves and, 5. The PCB temperature is above a specific limit</p> <p>Deactivate: The clutch response is OK</p>	<p>Yellow lamp is sent Slow gear changes Low clutch performance</p>	<p>Algorithm for activation/deactivation</p> <p>The following sequence must be passed three times (only once if the fault code-filter is switched OFF) in order to activate:</p> <ul style="list-style-type: none"> - The clutch is near the disengaged position - All clutch valves are deactivated - The initial average clutch position is calculated during 0.1s - Wait for 3s - The final average clutch position is calculated during 0.1s - If the position has moved more than 1mm in the engagement direction, the FMI is set, else if the clutch has moved less than 0.2mm in the engagement direction the FMI is reset. <p><i>Additional conditions for activation:</i></p> <ul style="list-style-type: none"> - There is no active fault code on any of the clutch cylinder position sensor (SEPoC) the clutch valves - low air pressure - The PCB temperature is above 10dgC
Clutch system		FMI7	Mechanical system not responding properly	<p>Activate: 1. The clutch does not disengage/engage properly when commanded 2. There is no active fault code on the SEPoC and,</p>	<p>Yellow lamp is sent Slow gear changes Low clutch performance</p>	<p>Detailed conditions to activate/deactivate</p> <p>One of the following conditions must be fulfilled three times in a row in order to activate the fault:</p> <ul style="list-style-type: none"> - The clutch position is more than 2mm from the disengaged position, after

Section 07: TRANSMISSION

FUNCTION	PID/SID	FMI J1587	ERROR	CONDITION	SYMPTOM	COMMENT
				<p>3. There is no active fault code for low air pressure and,</p> <p>4. There is no active fault code on any of the clutch cylinder valves and,</p> <p>5. The PCB temperature is above 10 dgC</p> <p>Deactivate: The clutch response is OK</p>		<p>control of the clutch to the disengaged position during 1.0 s</p> <ul style="list-style-type: none"> - The clutch position is not in the interval [set point +3mm; set point -1mm] after control of the clutch to near the slip point position during 1.0s - The clutch position is more than 2.5mm from the engaged position, after control of the clutch to the engaged position during 1.0s <p><i>The fault is deactivated after three successful occurrences, of control of the clutch to the requested position in 0.5s</i></p> <p>The fault is also deactivated if</p> <ul style="list-style-type: none"> - There is an active fault on the clutch position sensor - There is an active fault on any of the clutch valves - There is an active fault code for low air pressure - The PCB temperature is below 10 dgC
Clutch system		FMI12	Unintentional clutch slip	<p>Activate: The clutch can not transfer a specific torque without slipping</p> <p>Deactivate: The clutch can transfer a specific torque without slipping</p>	<p>Yellow lamp is sent</p> <p>The engine torque is reduced so that the clutch does not continue to slip</p>	<p>Detailed conditions</p> <p>Activation:</p> <ul style="list-style-type: none"> - Clutch slip is detected when the engine torque is already reduced below the "Clutch slip warning torque level" in an attempt to prevent clutch slip. The clutch slip warning level is 2500Nm for MD16 (TMF) variants and 2000Nm for other variants (SMF) - There is no active fault on any of: the sensor for the countershaft speed (SECS) the sensor for the clutch position (SEPoC) and the engine torque & engine speed is received from the engine ECU <p>Deactivation:</p> <p>The clutch can transfer the maximum engine torque without slipping the fault is also deactivated at startup of the system</p>
Clutch system		FMI11	Clutch drag	<p>Activate: The clutch transfers too much torque in disengaged position</p> <p>Deactivate: The clutch transfers no torque in disengaged position</p>	<p>Yellow lamp is sent</p> <p>The clutch wear is high</p>	<p>Algorithm for activation/deactivation</p> <ul style="list-style-type: none"> - Start the check when the counter shaft has been stopped with the brake during slip point calibration when the gearlever is in neutral during normal operation. - Release the brake and

FUNCTION	PID/SID	FMI J1587	ERROR	CONDITION	SYMPTOM	COMMENT
						check the input shaft speed after 0.5s if input shaft speed > 300rpm, activate this fault code if input shaft speed < 300rpm, deactivate this fault code - Continue with the slip point calibration
Digital input flash NVRAM programming enable (DIEE)	PSID254	FMI3	Voltage above normal or shorted high	Activate: The voltage level for DIEE-pin is high Deactivate: The voltage for the DIEE-pin is low	Yellow lamp is sent Cranking is inhibited Engine can not start All communication with the control unit is disabled except from programming of MSW	The boot-program does not save any fault codes
Digital input flash NVRAM programming enable (DIEE)		FMI3	Voltage above normal or shorted high	Active: The voltage level for DIEE-pin is high Deactivate: The voltage for the DIEE-pin is low	Yellow lamp is sent	If the DIEE-pin is high during normal operation the fault code is saved.
Fast clutch valves low side (VAF-)	PSID5	FMI3	Voltage above normal or shorted high	Activate: The low-side drive is short circuit to Ubatt Deactivate: The low-side drive is OK	Yellow lamp is sent Fast engagement/disengagement disabled Reduced clutch performance Gear changes are slow	
Fast clutch valves low side (VAF-)		FMI6	Current above normal or grounded circuit	Activate: 1. The low-side drive is short circuit to Gnd and 2. There is no active fault code for short circuit to Gnd on VAFE or VAFD Deactivate: The low-side drive is OK	Yellow lamp is sent Fast engagement/disengagement disabled Reduced clutch performance Gear changes are slow	
Gearbox brake	PSID28	FMI7	Mechanical system not responding properly	Activate: The gearbox brake does not brake when the valve is activated	Yellow lamp is sent Slow gear changes at standstill	Detailed conditions The following conditions must be fulfilled for five activations (only one with the fault code-filter switched OFF) of the gearbox brake in order to activate the fault code: - The activation must last for at least 0.2s - There is no active fault code on the sensor for the split cylinder position (SEPoS) - The minimum valve of the

Section 07: TRANSMISSION

FUNCTION	PID/SID	FMI J1587	ERROR	CONDITION	SYMPTOM	COMMENT
						<p>derivative of the input shaft speed during activation is greater than -500 rpm/s</p> <ul style="list-style-type: none"> - There is no active fault on any of the gearbox brake valve (VAGB) <p>the sensor for the countershaft speed (SECS) the sensor for the split cylinder position (SEPoS) low air pressure. The following conditions must be fulfilled for one activation of the gearbox brake in order to deactivate:</p> <ul style="list-style-type: none"> - The minimum value of the derivative of the countershaft speed during the activation is greater than -1000rpm/s <p>The fault is also deactivated if there is an active fault on the countershaft speed sensor (SESC), on the gearbox brake valve (VAGB), or the split position sensor (SEPoS)</p>
Gears 1/R engagement system	PSID25	FMI0	Unintentional disengagement of 1:st gear	<p>Conditions to set the fault code:</p> <ul style="list-style-type: none"> -The 1/R cylinder leaves the 1:st position -The 1:st cylinder valves are inactive 	<p>Yellow lamp is sent</p> <p>Loss of torque</p>	<p>Detailed conditions to activate/deactivate</p> <p>The following conditions must be fulfilled three times (only one time if the fault code filter is switched OFF) in a row in order to set the fault code:</p> <p>(engagement of another gear will reset the count)</p> <ul style="list-style-type: none"> - The 1/R cylinder position indicates that the 1/R gear leaves the 1:st position - The 1:st cylinder valves are inactive - There is no active fault on any of the sensor for the position of the 1/R cylinder (SEPo1R) the valve for shift to 1:st gear the valve for shift to reverse gear - There is no active fault code for low air pressure <p><i>Note:</i> The fault will always have the state inactive. Check the fault count and last occurrence to get more information.</p>
Gears 1/R engagement system		FMI1	Unintentional disengagement of reverse gear	<p>Conditions to set the fault code:</p> <ul style="list-style-type: none"> -The 1/R gear leaves the reverse position -The 1/R cylinder valves are inactive 	<p>Yellow lamp is sent</p> <p>Loss of torque</p>	<p>Detailed conditions to activate/deactivate</p> <p>The following conditions must be fulfilled three times (only one time if the fault code-filter is switched OFF) in a row in order to set the fault code:</p> <p>(engagement of another gear will reset the count)</p> <ul style="list-style-type: none"> - The 1/R cylinder position

FUNCTION	PID/SID	FMI J1587	ERROR	CONDITION	SYMPTOM	COMMENT
						<p>indicates that the 1/R gear leaves the reverse position</p> <ul style="list-style-type: none"> - The 1/R cylinder valves are inactive - There is no active fault on any of the sensor for the position of the 1/R cylinder (SEPo1R) <p>the valve for shift to 1:st gear the valve for shift to reverse gear</p> <ul style="list-style-type: none"> - There is no active fault code for low air pressure <p><i>Note:</i> The fault will always have the state inactive. Check the fault count and last occurrence to get more information.</p>
Gears 1/R engagement system		FMI2	Unintentional disengagement of neutral gear (1:st and reverse gear cylinder)	<p>Conditions to set the fault code:</p> <ul style="list-style-type: none"> -The 1/R gear leaves the neutral position -The 1/R cylinder valves are inactive 	<p>Yellow lamp is sent</p> <p>Loss of torque</p>	<p>Detailed conditions to activate/deactivate</p> <p>The following conditions must be fulfilled three times (only one time if the fault code-filter is switched OFF) in a row in order to set the fault code:</p> <p>(engagement of another gear will reset the count)</p> <ul style="list-style-type: none"> - The 1/R cylinder position indicates that the 1/R gear leaves the neutral position - The 1/R cylinder valves are inactive - There is no active fault on any of the sensor for the position of the 1/R cylinder (SEPo1R) the valve for shift to 1:st gear the valve for shift to reverse gear - There is no active fault code for low air pressure <p><i>Note:</i> The fault will always have the state inactive. Check the fault count and last occurrence to get more information.</p>
Gears 1/R engagement system		FMI11	Blocked engagement of 1:st gear	<p>Conditions to set the fault code:</p> <ul style="list-style-type: none"> -The 1:st gear can not engage -There is no active fault code on the SEPo1R -There is no active fault code for low air pressure -There is no active fault code on any of the 1:st and reverse gear cylinder valves 	<p>Yellow lamp is sent</p> <p>Loss of torque</p> <p>The 1:st gears will not be selected by the system for a short while. After five successful gear changes a new attempt to use 1:st gear may be made</p>	<p>Detailed conditions to activate/deactivate</p> <p>The following conditions must be fulfilled three times (only one time if the fault code-filter is switched OFF) in a row in order to set the fault code:(engagement of another gear will reset the count)</p> <ul style="list-style-type: none"> - The valve for reaching 1:st gear is activated for at least 0.8s - The 1/R cylinder position sensor indicates that 1:st position is not engaged - There is no active fault on any of the 1/R position sensor (SEPo1R) the valve for shift to 1:st gear the

Section 07: TRANSMISSION

FUNCTION	PID/SID	FMI J1587	ERROR	CONDITION	SYMPTOM	COMMENT
						valve for shift to reverse gear - There is no active fault code for low air pressure The fault is deactivated if any of the following conditions are fulfilled: - The 1/R position sensor indicates that 1:st position is engaged - There is an active fault code on any of the 1/R position sensor (SEPo1R) the valve for shift to 1:st gear the valve for shift to reverse gear
Gears 1/R engagement system		FMI12	Blocked engagement of reverse gear	Conditions to set the fault code: -The reverse gear can not engage	Yellow lamp is sent The R gear can not engage, but the system will try to engage it as long as the gearlever is in the reverse position	Detailed conditions to activate/deactivate The following conditions must be fulfilled three times (only one time if the fault code filter is switched OFF) in a row in order to set the fault code: (engagement of another gear will reset the count) - The valve for reaching the reverse gear is activated for at least 0.8s - The 1/R cylinder position sensor indicates that R position is not engaged - There is no active fault on any of the 1/R position sensor (SEPo1R) the valve for shift to 1:st gear the valve for shift to reverse gear - There is no active fault code for low air pressure. The fault is deactivated if any of the following conditions are fulfilled: - The 1/R position sensor indicates that R position is engaged - There is an active fault code on any of the 1/R position sensor (SEPo1R) the valve for shift to 1:st gear the valve for shift to reverse gear
Gears 1/R engagement system		FMI7	Blocked engagement of neutral gear (1:st and reverse gear cylinder)	Conditions to set the fault code: -The neutral gear (1:st and reverse gear cylinder) can not engage	Yellow lamp is sent	Detailed conditions to activate/deactivate The following conditions must be fulfilled three times (only one time if the fault code-filter is switched OFF) in a row in order to set the fault code: (engagement of another gear will reset the count) - The valve for reaching the reverse gear is activated for at least 0.8s - The 1/R cylinder position

FUNCTION	PID/SID	FMI J1587	ERROR	CONDITION	SYMPTOM	COMMENT
						<p>sensor indicates that neutral position is not engaged</p> <ul style="list-style-type: none"> - There is no active fault code on any of the 1/R position sensor (SEPo1R) the valve for shift to 1:st gear the valve for shift to reverse gear - There is no active fault code for low air pressure <p>The fault is deactivated if any of the following conditions are fulfilled:</p> <ul style="list-style-type: none"> - The 1/R position sensor indicates that neutral position is engaged - There is an active fault code on any of the 1/R position sensor (SEPo1R) the valve for shift to 1:st gear the valve for shift to reverse gear
Gears 2/3 engagement system	PSID26	FMI0	Unintentional disengagement of 2:nd gear	<p>Conditions to set the fault code:</p> <ul style="list-style-type: none"> -The 2/3 cylinder position indicates that the 2/3 gear leaves the 2:nd position - The 2:nd cylinder valves are inactive 	<p>Yellow lamp is sent</p> <p>Loss of torque</p>	<p>Detailed conditions to activate/deactivate</p> <p>The following conditions must be fulfilled three times (only one time if the fault code-filter is switched OFF) in a row in order to set the fault code:</p> <p>(engagement of another gear will reset the count)</p> <ul style="list-style-type: none"> - The 2/3 cylinder position indicates that the 2/3 gear leaves the 2:nd position - The 2:nd cylinder valves are inactive - There is no active fault on any of the sensor for the position of the 2/3 cylinder (SEPo23) the valve for shift to 2:nd gear the valve for shift to 3:rd gear - There is no active fault code for low air pressure <p><i>Note:</i> The fault will always have the state inactive. Check the fault count and last occurrence to get more information.</p>
Gears 2/3 engagement system		FMI1	Unintentional disengagement of 3:rd gear	<p>Conditions to set the fault code:</p> <ul style="list-style-type: none"> -The 2/3 cylinder leaves the 3:rd position - The 3:rd cylinder valves are inactive 	<p>Yellow lamp is sent</p> <p>Loss of torque</p>	<p>Detailed conditions to activate/deactivate</p> <p>The following conditions must be fulfilled three times (only once if the fault code-filter is switched OFF) in a row in order to set the fault code:</p> <p>(engagement of another gear will reset the count)</p> <ul style="list-style-type: none"> - The 2/3 cylinder position indicates that the 2/3 gear leaves the 3:rd position - The 3:rd cylinder valves are inactive - There is no active fault on

Section 07: TRANSMISSION

FUNCTION	PID/SID	FMI J1587	ERROR	CONDITION	SYMPTOM	COMMENT
						any of the sensor for the position of the 2/3 cylinder (SEPo23) the valve for shift to 2:nd gear the valve for shift to 3:rd gear - There is no active fault code for low air pressure <i>Note:</i> The fault will always have the state inactive. Check the fault count and last occurrence to get more information.
Gears 2/3 engagement system		FMI2	Unintentional disengagement of neutral gear (2:nd and 3:rd gear cylinder)	Conditions to set the fault code: -The 2/3 cylinder leaves the neutral position - The 2/3 cylinder valves are inactive	Yellow lamp is sent	Detailed conditions to activate/deactivate The following conditions must be fulfilled three times (only once if the fault code-filter is switched OFF) in a row in order to set the fault code: (engagement of another gear will reset the count) - The 2/3 cylinder position indicates that the 2/3 gear leaves the neutral position - The 2/3 cylinder valves are inactive - There is no active fault on any of the sensor for the position of the 2/3 cylinder (SEPo23) the valve for shift to 2:nd gear the valve for shift to 3:rd gear - There is no active fault code for low air pressure <i>Note:</i> The fault will always have the state inactive. Check the fault count and last occurrence to get more information.
Gears 2/3 engagement system		FMI11	Blocked engagement of 2:nd gear	Conditions to set the fault code: -The 2:nd gear can not engage	Yellow lamp is sent Loss of torque The 2:nd gear will not be selected by the system for a short while. After five successful gearshifts a new attempt to use 2:nd gear may be made	Detailed conditions to activate/deactivate The following conditions must be fulfilled three times (only once if the fault code-filter is switched OFF) in a row in order to set the fault code: (engagement of another gear will reset the count) - The valve for reaching 2:nd gear is activated for at least 0.8s - The 2/3 cylinder position sensor indicates that 2:nd position is not engaged - There is no active fault on any of the 2/3 position sensor (SEPo23) the valve for shift to 2:nd gear the valve for shift to 3:rd gear - There is no active fault code for low air pressure <i>The fault is deactivated if any of the following conditions are fulfilled:</i>

FUNCTION	PID/SID	FMI J1587	ERROR	CONDITION	SYMPTOM	COMMENT
						<ul style="list-style-type: none"> - The 2/3 position sensor indicates that 2:nd 2:nd position is engaged - There is an active fault code on any of the 2/3 position sensor (SEPo23) the valve for shift to 2:nd gear the valve for shift to 3:rd gear
Gears 2/3 engagement system		FMI12	Blocked engagement of 3:rd gear	<p>Conditions to set the fault code:</p> <ul style="list-style-type: none"> -The 3:rd gear can not engage 	<p>Yellow lamp is sent</p> <p>Loss of torque</p> <p>The 3:rd gear will not be selected by the system for a short while. After five successful gearshifts a new attempt to use 3:rd gear may be made</p>	<p>Detailed conditions to activate/deactivate</p> <p>The following conditions must be fulfilled three times (only once if the fault code-filter is switched OFF) in a row in order to set the fault code:</p> <p>(engagement of another gear will reset the count)</p> <ul style="list-style-type: none"> - The valve for reaching 3:rd gear is activated for at least 0.8s - The 2/3 cylinder position sensor indicates that 3:rd position is not engaged - There is no active fault on any of the 2/3 position sensor (SEPo23) the valve for shift to 2:nd gear the valve for shift to 3:rd gear - There is no active fault code for low air pressure <p><i>The fault is deactivated if any of the following conditions are fulfilled:</i></p> <ul style="list-style-type: none"> - The 2/3 position sensor indicates that 3:rd position is engaged - There is an active fault code on any of the 2/3 position sensor (SEPo23) the valve for shift to 2:nd gear the valve for shift to 3:rd gear
Gears 2/3 engagement system		FMI7	Blocked engagement of neutral gear (2:nd and 3:rd gear cylinder)	<p>Conditions to set the fault code:</p> <ul style="list-style-type: none"> -The neutral gear (2:nd 3:rd gear cylinder) can not engage 	<p>Yellow lamp is sent</p>	<p>Detailed conditions to activate/deactivate</p> <p>The following conditions must be fulfilled three times (only once if the fault code-filter is switched OFF) in a row in order to set the fault code:</p> <p>(engagement of another gear will reset the count)</p> <ul style="list-style-type: none"> - The valve for reaching gear (2:nd and 3:rd gear cylinder) is activated for at least 0.8s - The 2/3 cylinder position sensor indicates that neutral position is not engaged - There is no active fault code on any of the 2/3 position sensor (SEPo23) the valve for shift to 2:nd gear the valve for shift to

Section 07: TRANSMISSION

FUNCTION	PID/SID	FMI J1587	ERROR	CONDITION	SYMPTOM	COMMENT
						3:rd gear - There is no active fault code for low air pressure <i>The fault is deactivated if any of the following conditions are fulfilled:</i> - The 2/3 position sensor indicates that neutral position is engaged - There is an active fault code on any of the 2/3 position sensor (SEPo23) the valve for shift to 2:nd gear the valve for shift to 3:rd gear
J1708/J1587	SID250	FMI9	Abnormal update rate	Activate: The FMI shall be set if any of the messages* have not been received on the bus for 30s Deactivate: The FMI shall be cleared if all messages* are sent on the bus *PID190, PID85 and PPID212	Yellow lamp is sent Fault codes can not be read On-vehicle tests can not be performed	
J1939	SID231	FMI2	Data erratic, intermittent or incorrect	Active: This FMI shall be set if the CAN transceiver signals "bus-off" Deactivate: FMI cleared if CAN-transceiver does not signal "bus-off"	Yellow lamp is sent Much reduced gear selection and gear change performance	
Missing data on J1939 form BECU	PSID204	FMI8	Abnormal frequency, pulse width or period	Activate: The FMI shall be set if the wheel speeds from the BECU (MID136) are incorrect Deactivate: The FMI shall be cleared if the wheel speeds from the BECU (MID136) are correct	Yellow lamp Automatic gear selection enters backup mode with gear changes only at certain vehicle speeds	
Missing data on J1939 form BECU		FMI9	Abnormal update rate	Activate: The FMI shall be set if message WSI from BECU (MID136) is not received within 1s Deactivate: The FMI shall be cleared if message WSI is received at normal rate	Yellow lamp Automatic gear selection enters backup mode with gear changes only at certain vehicle speeds	

FUNCTION	PID/SID	FMI J1587	ERROR	CONDITION	SYMPTOM	COMMENT
Missing data on J1939 from GECU	PSID207	FMI9	Abnormal update rate	Activate: The FMI shall be set if message VP6 from GECU (MID223) is not received within 1s Deactivate: The FMI shall be cleared if message VP6 is received at normal rate	Yellow lamp Slow response on manual gear changes and slow response when buttons are pressed on the gear lever.	
Missing data on J1939 from the adaptive cruise control	PSID211	FMI9	Abnormal update rate	Activate: The FMI shall be set if message ACC1 from ACC (MID219) is not received within 1s, and ACC is installed Deactivate: The FMI shall be cleared if message ACC1 is received at normal rate	Yellow lamp The retarder ACC function does not work	
Missing data on J1939 from the EMS	PSID200	FMI9	Abnormal update rate	Activate: The FMI shall be set if message EEC1 from EECU is not received within 200ms Deactivate: The FMI shall be cleared if message EEC1 is received at normal rate	Yellow lamp If there is no POWERTRAIN_CAN, automatic gear selection enters backup mode with gear changes only at certain vehicle speeds If there is no Powertrain_CAN and the engine does not receive any messages from the TECU, the gear changes will be slow	
Missing data on J1939 from the light control module (LCM)	PSID210	FMI9	Abnormal update rate	Activate: The FMI shall be set if message VP37 from LCM (MID216) is not received within 10s Deactivate: The FMI shall be cleared if message VP37 is received at normal rate	Yellow lamp The start gear might be wrong Automatic gear selection performance might be reduced a certain time after start Automatic gear selection performance might be reduced a certain time after a trailer has been connected/disconnected	

Section 07: TRANSMISSION

FUNCTION	PID/SID	FMI J1587	ERROR	CONDITION	SYMPTOM	COMMENT
Missing data on J1939 from the suspension ECU (ECS)	PSID208	FMI9	Abnormal update rate	Activate: The FMI shall be set if message VW from ECS (MID150) is not received within 10s, and ECS is installed Deactivate: The FMI shall be cleared if message VW is received at normal rate	Yellow lamp The start gear might be wrong after loading and unloading	
Missing data on J1939 from VECU	PSID201	FMI8	Abnormal frequency, pulse width or period	Activate: The FMI shall be set if the acc pedal pos or service brake-switch from the VECU (MID144) is incorrect Deactivate: The FMI shall be cleared if the acc pedal pos and service brake-switch from the VECU (MID144) are correct	Yellow lamp If pedal pos is undefined, automatic gear selection enters backup mode with gear changes only at certain vehicle speeds If pedal pos is undefined, gearbox comfort at start and marshalling might be reduced If service brake is undefined, automatic gear selection enters backup mode with gear changes only at certain vehicle speeds	
Missing data on J1939 from VECU		FMI9	Abnormal update rate	Activate: The FMI shall be set if message VP2 from VECU (MID144) is not received within 100ms Deactivate: The FMI shall be cleared if message VP2 is received at normal rate	Yellow lamp Automatic gear selection enters backup mode with gear changes only at certain vehicle speeds Gearbox comfort at start and marshalling might be reduced	
Powertrain CAN	PSID232	FMI2	Data erratic, intermittent or incorrect	Activate: The FMI shall be set if the CAN transceiver signals "busOFF" Deactivate: The FMI shall be cleared if the CAN-transceiver does not signal "busOFF"	Yellow lamp is sent Reduced automatic gear selection and gear change performance	This fault code is only valid for vehicles where a Pwertrain_CAN link exist between the TECU and the engine.

FUNCTION	PID/SID	FMI J1587	ERROR	CONDITION	SYMPTOM	COMMENT
Powertrain CAN		FMI9	Abnormal update rate	Activate: The FMI shall be set if message VP24/MID128 is not received within 100ms Deactivate: The FMI shall be cleared if message VP24/MID128 is received at normal rate	Yellow lamp is sent Reduced automatic gear selection and gear change performance	
Program memory	SID240	FMI2	Data erratic, intermittent or incorrect	Activate: Flash CS error or program code missing Deactivate: Flash CS OK	Yellow lamp is sent Cranking is inhibited Engine can not start	
Range engagement system	PSID24	FMI0	Unintentional disengagement of low range	Conditions to set the fault code: -The range cylinder leaves the low range position -The range cylinder valves are inactive	Yellow lamp is sent Loss of torque	Detailed conditions to activate/deactivate: The following conditions must be fulfilled three times (only once if the fault code-filter is switched OFF) in a row, in order to set the fault code: (engagement of another gear will reset the count) - The range cylinder position indicates that range gear leaves the low range position - The range cylinder valves are inactive - There is no active fault on any of the sensor for the position of the range cylinder (SEPoR) the valve for shift to high range the valve for shift to low range - There is no active fault code for low air pressure note: The fault will always have the state inactive. Check fault-count and last occurrence to get more information
Range engagement system		FMI1	Unintentional disengagement of high range	Conditions to set the fault code: -The range cylinder leaves the high range position -The range cylinder valves are inactive	Yellow lamp is sent Loss of torque	Detailed conditions to activate/deactivate: The following conditions must be fulfilled three times (only once if the fault code-filter is switched OFF) in a row, in order to set the fault code: (engagement of another gear will reset the count) - The range cylinder position indicates that the range gear leaves the high range position - The range cylinder valves are inactive

Section 07: TRANSMISSION

FUNCTION	PID/SID	FMI J1587	ERROR	CONDITION	SYMPTOM	COMMENT
						<ul style="list-style-type: none"> - There is no active fault on any of the sensor for the position of the range cylinder (SEPoR) the valve for shift to high range the valve for shift to low range - There is no active fault code for low air pressure <p><i>note:</i> The fault will always have the state inactive. Check fault-count and last occurrence to get more information</p>
Range engagement system		FMI11	Blocked engagement of low range	<p>Conditions to set the fault code:</p> <ul style="list-style-type: none"> -The low range gear can not engage 	<ul style="list-style-type: none"> Yellow lamp is sent Loss of torque 	<p>Detailed conditions to activate/deactivate:</p> <p>The following conditions must be fulfilled three times (only once if the fault code-filter is switched OFF) in a row, in order to set the fault code: (engagement of another gear will reset the count)</p> <ul style="list-style-type: none"> - The low range can not engage within 3.8s - The gearbox oil temperature is above 10dgC - There is no active fault code on any of the sensor for the position of the range cylinder (SEPoR) low air pressure the range cylinder valves <p>The fault is deactivated if any of the following conditions are fulfilled:</p> <ul style="list-style-type: none"> - The range cylinder position sensor indicates that low range is engaged - The gearbox oil temperature is below 10dgC - There is an active fault on any of the sensor for the position of the range cylinder (SEPoR) low air pressure the range cylinder valves
Range engagement system		FMI12	Blocked engagement of high range	<p>Conditions to set the fault code:</p> <ul style="list-style-type: none"> -The high range gear can not engage 	<ul style="list-style-type: none"> Yellow lamp is sent Loss of torque 	<p>Detailed conditions to activate/deactivate:</p> <p>The following conditions must be fulfilled three times (only once if the fault code-filter is switched OFF) in a row, in order to set the fault code: (engagement of another gear will reset the count)</p> <ul style="list-style-type: none"> - The high range gear can not engage within 3.8s - The gearbox oil temperature is above 10dgC - There is no active fault on any of the range position sensor (SEPoR) low air

FUNCTION	PID/SID	FMI J1587	ERROR	CONDITION	SYMPTOM	COMMENT
						pressure the range cylinder valves - There is no active fault code for low air pressure The fault is deactivated if any of the following conditions are fulfilled: - The range cylinder position sensor indicates that high range is engaged - The gearbox oil temperature is below 10dgC - There is an active fault code on any of the range position sensor (SEPoR) low air pressure the range cylinder valves
Sensor for the 1:st and reverse gear cylinder (SEPo1R)	PPID10	FMI2	Data erratic, intermittent or incorrect	Activate: The position sensor is distributing a temperature-signal from the sensor ASIC, if the value from this sensor deviates too much this fault code is triggered. Deactivate:	Yellow lamp is sent Slow gear changes	Detailed conditions to activate / deactivate: Activate: The position sensor is distributing a temperature-signal from the sensor ASIC, if the value from this sensor deviates too much this fault code is triggered, the diagnostics are based upon cross-reference between all four position-sensors. This means that if the value differs more than +/- 20dgC from the average-temp, if the temperature is out of boundary -60dgC to +160dgC or if the temperature changes at a rate higher than 10dgC during 15s, then this fault code is set. Deactivate: Fault code stays until a clear DTC command is received
Sensor for the 1:st and reverse gear cylinder (SEPo1R)		FMI3	Voltage above normal or shorted high	Activate: Status from the ASIC is short circuit to Ubatt Deactivate: Status is OK	Yellow lamp is sent Slow gear changes	
Sensor for the 1:st and reverse gear cylinder (SEPo1R)		FMI5	Current below normal or open circuit	Activate: Status from the ASIC is open circuit Deactivate: Status is OK	Yellow lamp is sent Slow gear changes	
Sensor for the 1:st and reverse gear cylinder (SEPo1R)		FMI6	Current above normal or grounded circuit	Activate: Status from the ASIC is short circuit to Gnd Deactivate: Status is OK	Yellow lamp is sent Slow gear changes	
Sensor for the 1:st and reverse gear		FMI13	Calibration value out of range	Activate: The Checksum of the NVRAM is not correct, or the	Yellow lamp is sent Cranking is inhibited	

Section 07: TRANSMISSION

FUNCTION	PID/SID	FMI J1587	ERROR	CONDITION	SYMPTOM	COMMENT
cylinder (SEPo1R)				sensor has not been calibrated Deactivate: Sensor signal has been successfully calibrated	Engine can not start	
Sensor for the inclination of the gearbox (SEIG)	PPID140	FMI2	Data erratic, intermittent or incorrect	Activate: 1. The sensor signal is above or below normal range and 2. The vehicle has been standing still for a specific time Deactivate: The sensor signal is in the normal range	Yellow lamp is sent The start gear might be wrong Gear selection performance might be reduced Downhill and uphill gear change performance may be reduced	
Sensor for the PCB temperature	PPID55	FMI0	Data valid but above normal operational range	Activate: temp above 125dgC Deactivate: temp below 125dgC	Yellow lamp is sent	
Sensor for the position of the 2:nd and 3:rd gear cylinder (SEPo23)	PPID11	FMI2	Data erratic, intermittent or incorrect	Activate: The position sensor is distributing a temperature-signal from the sensor ASIC, if the value from this sensor deviates too much this fault code is triggered. Deactivate:	Yellow lamp is sent Slow gear changes	Detailed conditions to activate / deactivate: Activate: The position sensor is distributing a temperature-signal from the sensor ASIC, if the value from this sensor deviates too much this fault code is triggered, the diagnostics are based upon cross-reference between all four position-sensors. This means that if the value differs more than +/- 20dgC from the average-temp, if the temperature is out of boundary -60dgC to +160dgC or if the temperature changes at a rate higher than 10dgC during 15s, then this fault code is set. Deactivate: Fault code stays until a clear DTC command is received
Sensor for the position of the 2:nd and 3:rd gear cylinder (SEPo23)		FMI3	Voltage above normal or shorted high	Activate: Status from the ASIC is short circuit to Ubatt Deactivate: Status is OK	Yellow lamp is sent Slow gear changes	
Sensor for the position of the 2:nd and 3:rd gear cylinder (SEPo23)		FMI5	Current below normal or open circuit	Activate: Status from the ASIC is open circuit Deactivate: Status is OK	Yellow lamp is sent Slow gear changes	

FUNCTION	PID/SID	FMI J1587	ERROR	CONDITION	SYMPTOM	COMMENT
Sensor for the position of the 2:nd and 3:rd gear cylinder (SEPo23)		FMI6	Current above normal or grounded circuit	Activate: Status from the ASIC is short circuit to Gnd Deactivate: Status is OK	Yellow lamp is sent Slow gear changes	
Sensor for the position of the 2:nd and 3:rd gear cylinder (SEPo23)		FMI13	Calibration value out of range	Activate: The Checksum of the NVRAM is not correct, or the sensor has not been calibrated Deactivate: Sensor signal has been successfully calibrated	Yellow lamp is sent Cranking is inhibited Engine can not start	
Sensor for the position of the range (SEPoR)	PID31	FMI2	Data erratic, intermittent or incorrect	Activate: The position sensor is distributing a temperature-signal from the sensor ASIC, if the value from this sensor deviates too much this fault code is triggered. Deactivate:	Yellow lamp is sent Slow gear changes	Detailed conditions to activate / deactivate: Activate: The position sensor is distributing a temperature-signal from the sensor ASIC, if the value from this sensor deviates too much this fault code is triggered, the diagnostics are based upon cross-reference between all four position-sensors. This means that if the value differs more than +/- 20dgC from the average-temp, if the temperature is out of boundary -60dgC to +160dgC or if the temperature changes at a rate higher than 10dgC during 15s, then this fault code is set. Deactivate: Fault code stays until a clear DTC command is received
Sensor for the position of the range (SEPoR)		FMI3	Voltage above normal or shorted high	Activate: Status from the ASIC is short circuit to Ubatt Deactivate: Status is OK	Yellow lamp is sent Slow gear changes	
Sensor for the position of the range (SEPoR)		FMI5	Current below normal or open circuit	Activate: Status from the ASIC is open circuit Deactivate: Status is OK	Yellow lamp is sent Slow gear changes	
Sensor for the position of the range (SEPoR)		FMI6	Current above normal or grounded circuit	Activate: Status from the ASIC is short circuit to Gnd Deactivate: Status is OK	Yellow lamp is sent Slow gear changes	
Sensor for the position of the range		FMI13	Calibration value out of range	Activate: The Checksum of the NVRAM is not correct, or the	Yellow lamp is sent Cranking is inhibited	

Section 07: TRANSMISSION

FUNCTION	PID/SID	FMI J1587	ERROR	CONDITION	SYMPTOM	COMMENT
(SEPoR)				sensor has not been calibrated Deactivate: Sensor signal has been successfully calibrated	Engine can not start	
Sensor for the position of the Split (SEPoS)	PID32	FMI2	Data erratic, intermittent or incorrect	Activate: The position sensor is distributing a temperature-signal from the sensor ASIC, if the value from this sensor deviates too much this fault code is triggered. Deactivate:	Yellow lamp is sent Slow gear changes	Detailed conditions to activate / deactivate: Activate: The position sensor is distributing a temperature-signal from the sensor ASIC, if the value from this sensor deviates too much this fault code is triggered, the diagnostics are based upon cross-reference between all four position-sensors. This means that if the value differs more than +/- 20dgC from the average-temp, if the temperature is out of boundary -60dgC to +160dgC or if the temperature changes at a rate higher than 10dgC during 15s, then this fault code is set. Deactivate: Fault code stays until a clear DTC command is received
Sensor for the position of the Split (SEPoS)		FMI3	Voltage above normal or shorted high	Activate: Status from the ASIC is short circuit to Ubatt Deactivate: Status is OK	Yellow lamp is sent Slow gear changes	
Sensor for the position of the Split (SEPoS)		FMI5	Current below normal or open circuit	Activate: Status from the ASIC is open circuit Deactivate: Status is OK	Yellow lamp is sent Slow gear changes	
Sensor for the position of the Split (SEPoS)		FMI6	Current above normal or grounded circuit	Activate: Status from the ASIC is short circuit to Gnd Deactivate: Status is OK	Yellow lamp is sent Slow gear changes	
Sensor for the position of the Split (SEPoS)		FMI13	Calibration value out of range	Activate: The Checksum of the NVRAM is not correct, or the sensor has not been calibrated Deactivate: Sensor signal has been successfully calibrated	Yellow lamp is sent Cranking is inhibited Engine can not start	
Sensor for the pressure of the supply	PID37	FMI0	Data valid but above normal operational range	Activate: 1. Sensor signal is in normal range 2. Pressure is	Yellow lamp is sent reduced clutch performance	

FUNCTION	PID/SID	FMI J1587	ERROR	CONDITION	SYMPTOM	COMMENT
air (SEPrSA)				above 10.0 [bar] Deactivate: 1. Sensor signal is in normal range 2. Pressure is below 10.0 [bar]		
Sensor for the pressure of the supply air (SEPrSA)		FMI1	Data valid but below operational range	Activate: 1. Sensor signal is in normal range 2. Pressure is below 5.0 [bar] Deactivate: 1. Sensor signal is in normal range 2. Pressure is above 5.0 [bar]	Yellow lamp is sent The symbol for compressed air, gearbox is sent Gear changes may be absent Reduced clutch performance	
Sensor for the pressure of the supply air (SEPrSA)		FMI3	Voltage above normal or shorted high	Activate: The sensor signal is above normal range Deactivate: The sensor signal is in normal range	Yellow lamp is sent	
Sensor for the pressure of the supply air (SEPrSA)		FMI5	Current below normal or open circuit	Activate: The sensor signal is below normal range Deactivate: The sensor signal is in normal range	Yellow lamp is sent	
Sensor for the speed on the counter shaft (SESC)	PID161	FMI1	Data valid but below operational range	Activate: 1. The sensor signal is within normal range and, 2. The counter shaft speed differs from both the main shaft speed (SESM) and the vehicle speed received from the vehicle ECU when the counter shaft is rotating Deactivate: 1. The sensor signal is within normal range 2. The counter shaft speed and the main shaft speed are equal when the counter shaft is rotating	Yellow lamp is sent Reduced gear change performance Gearbox brake up shifts can not be used Slip point can not be updated which will give reduced performance at starts Start gear engagement only possible at standstill and when the vehicle speed is high enough to synchronize the main box with the engine	Detailed condition to activate: The following conditions must be fulfilled for a time of 2.0s in order to activate: A gear (not neutral) is engaged in the gearbox The value of the input shaft speed calculated from the main shaft speed sensor (SESM) is more than 300rpm, or the value of the input shaft speed calculated from the counter shaft speed sensor (SESC) is more than 300rpm -The values of the input shaft speed calculated from the counter shaft speed sensor (SESC) and the main shaft speed sensor (SESM) differ more than 50rpm -The values of the input shaft speed calculated from the counter shaft speed sensor (SESC) and the vehicle speed received from the vehicle ECU differ more than 30rpm -The values of the input shaft speed calculated from the main shaft speed sensor (SESM) and the vehicle speed received from the vehicle ECU differ less than

Section 07: TRANSMISSION

FUNCTION	PID/SID	FMI J1587	ERROR	CONDITION	SYMPTOM	COMMENT
						<p>30rpm</p> <ul style="list-style-type: none"> -There is no active fault on any of -The sensor for the main shaft speed (SESM) -The sensor for the position of the split cylinder (SEPoS) -The sensor for the position of the shift cylinder1R (SEPo1R) -The sensor for the position of the shift cylinder 23 (SEPo23) -The sensor for the position of teh range cylinder (SEPoR) <p>The fault is deactivated if the following conditions are fulfilled for a time of 2.0s:</p> <ul style="list-style-type: none"> -A gear (not neutral) is engaged in the gearbox -The value of the input shaft speed calculated from the countershaft speed sensor (SESC) is more than 300rpm, or -the value of the input shaft speed calculated from the main shaft speed sensor (SESM) is more than 300rpm -The values of the input shaft speed calculated from the countershaft speed sensor (SESC) and the main shaft speed sensor (SESM) differ less than 50rpm <p>The fault is also deactivated if the following conditions are fulfilled for a time of 2.0s:</p> <ul style="list-style-type: none"> -A neutral gear is engaged in the gearbox -The engine speed is above 400rpm -The clutch is engaged -Direct or indirect split is engaged -The values of the input shaft speed is calculated from the counter shaft speed sensor (SESC) and the engine speed received from the engine ECU differ less than 50 rpm <p>The fault is also deactivated if the signal from the countershaft speed sensor (SESC) is not within normal range or if there is an active fault code on any of:</p> <ul style="list-style-type: none"> -The clutch position sensor (SEPoC) -The sensor for the position

FUNCTION	PID/SID	FMI J1587	ERROR	CONDITION	SYMPTOM	COMMENT
						of the split cylinder (SEPoS) -The sensor for the position of the shift cylinder1R (SEPo1R) -The sensor for the position of the shift cylinder 23 (SEPo23) -The sensor for the position of teh range cylinder (SEPoR)
Sensor for the speed on the counter shaft (SESC)		FMI4	Voltage below normal or shorted low	Activate: The sensor signal is below normal range. Deactivate: The sensor signal is within normal range	Yellow lamp is sent Reduced gear change performance Gearbox brake up shifts can not be used Slip point cannot be updated which will give reduced performance at starts Start gear engagement only possible at standstill and when the vehicle speeds is high enough to synchronize the main box with the engine	
Sensor for the speed on the counter shaft (SESC)		FMI5	Current below normal or open circuit	Activate: The sensor signal is above normal range Deactivate: The sensor signal is within normal range	Yellow lamp is sent Reduced gear change performance Gearbox brake up shifts can not be used Slip point cannot be updated which will give reduced performance at starts Start gear engagement only possible at standstill and when the vehicle speed is high enough to synchronize the main box with the engine	
Sensor for the speed on the main shaft (SESM)	PID160	FMI1	Data valid but below operational range	Activate: 1. Sensor signal is within normal range and 2. The main shaft speed differs from both the value of the	Yellow lamp is sent Reduced gear change performance Reduced gear change comfort	Detailed condition to activate: The following conditions must be fulfilled for a time of 2.0s in order to activate: A gear (not neutral) is engaged in the gearbox The value of the input shaft

Section 07: TRANSMISSION

FUNCTION	PID/SID	FMI J1587	ERROR	CONDITION	SYMPTOM	COMMENT
				<p>countershaft speed and the vehicle speed received from the vehicle ECU</p> <p>Deactivate: 1. <i>Sensor signal is within normal range and,</i> 2. <i>The main shaft speed and the counter shaft speed are equal when the main shaft is rotating</i></p>		<p>speed calculated from the main shaft speed sensor (SESM) is more than 300rpm, or the value of the input shaft speed calculated from the counter shaft speed sensor (SESC) is more than 300rpm</p> <p>The values of the input shaft speed calculated from the main shaft speed sensor (SESM) and the counter shaft speed sensor (SESC) differ more than 50rpm</p> <p>The values of the input shaft speed calculated from the main shaft speed sensor (SESM) and the vehicle speed received from the vehicle ECU differ more than 30rpm</p> <p>The values of the input shaft speed calculated from the counter shaft speed sensor (SESC) and the vehicle speed received from the vehicle ECU differ less than 30rpm</p> <p>There is no active fault on any of</p> <ul style="list-style-type: none"> The sensor for the countershaft speed (SECS) The sensor for the position of the split cylinder (SEPoS) The sensor for the position of the shift cylinder1R (SEPo1R) The sensor for the position of the shift cylinder 23 (SEPo23) The sensor for the position of the range cylinder (SEPoR) <p>The following conditions must be fulfilled for a time of 2.0s in order to deactivate:</p> <ul style="list-style-type: none"> A gear (not neutral) is engaged in the gearbox The value of the input shaft speed calculated from the main shaft speed sensor (SESM) is more than 300rpm, or the value of the input shaft speed calculated from the counter shaft speed sensor (SESC) is more than 300rpm The value of the input shaft speed calculated from the main shaft speed sensor (SESM) and the counter shaft speed sensor (SESC) differ less than 50rpm <p>The fault is also deactivated if The sensor signal (SESM) is not within normal range</p>

FUNCTION	PID/SID	FMI J1587	ERROR	CONDITION	SYMPTOM	COMMENT
						<p>There is an active fault on any of The sensor for the countershaft speed (SECS) The sensor for the position of the split cylinder (SEPoS) The sensor for the position of the shift cylinder1R (SEPo1R) The sensor for the position of the shift cylinder 23 (SEPo23) The sensor for the position of teh range cylinder (SEPoR)</p>
<p>Sensor for the speed on the mainshaft (SESM)</p>		<p>FMI2</p>	<p>Data erratic, intermittent or incorrect</p>	<p>Activate: The sensor indicates wrong traveling direction Deactivate: The sensor indicates correct traveling direction</p>	<p>Yellow lamp is sent Reduced gear change performance</p>	<p>Detailed conditions to activate The following conditions must be fulfilled for a time of 2.0s in order to activate: The input shaft speed calculated from the countershaft speed sensor (SESC) is above 300 rpm and the clutch is engaged or The input shaft speed calculated from the countershaft speed sensor (SECS) is above 600 rpm, the clutch position is more engaged than the slip point and the engine speed is received from the engine ECU and above 600rpm. A forward gear is engaged in the gearbox and the main shaft speed sensor (SESM) indicates reverse movement or a reverse gear is engaged and the main shaft speed sensor (SESM) indicates forward movement There is no other active fault on the sensor for the main shaft speed (SESM) There is no active fault on any of: -The sensor for the countershaft speed (SECS) -The sensor for the clutch position (SePoC) -The sensor for the position of the split cylinder (SePoS) -The sensor for the position of the shift cylinder (1R SEPo1R) -The sensor for the position of the shift cylinder (23 SEPo23) -The sensor for the range cylinder (SEPoR)</p> <p>The fault is deactivated if the following conditions are fulfilled for a time of 2,0s: The input shaft speed calculated from the counter</p>

Section 07: TRANSMISSION

FUNCTION	PID/SID	FMI J1587	ERROR	CONDITION	SYMPTOM	COMMENT
						<p>shaft speed sensor (SECS) is above 300 rpm and the clutch is engaged or The input shaft speed calculated from the counter shaft speed sensor (SECS) is above 600 rpm, the clutch position is more engaged than the slip point and the engine speed is received from the engine ECU and above 600rpm</p> <p>A forward gear is engaged in the gearbox and the main shaft speed sensor (SESM) indicates forward movement or A reverse gear is engaged and the main shaft speed sensor (SESM) indicates reverse movement.</p> <p>The fault is also deactivated if the main shaft speed sensor (SESM) signal is not within normal range, or if there is an active fault on any of the sensors:</p> <ul style="list-style-type: none"> -The sensor for the countershaft speed (SECS) -The sensor for the clutch position (SePoC) -The sensor for the position of the split cylinder (SePoS) -The sensor for the position of the shift cylinder (1R SEPo1R) -The sensor for the position of the shift cylinder (23 SEPo23) -The sensor for the range cylinder (SEPoR)
Sensor for the speed on the main shaft (SESM)		FMI3	Voltage above normal or shorted high	<p>Activate: Signal or supply voltage is above normal range</p> <p>Deactivate: Signal and supply voltage is in normal range.</p>	<p>Yellow lamp is sent</p> <p>Reduced gear change performance</p> <p>Reduced gear change comfort</p>	
Sensor for the speed on the main shaft (SESM)		FMI4	Voltage below normal or shorted low	<p>Activate: Signal and supply voltage is below normal range.</p> <p>Deactivate: Signal and supply voltage is within normal range</p>	<p>Yellow lamp is sent</p> <p>Reduced gear change performance</p> <p>Reduced gear change comfort</p>	
Sensor for the speed on the main shaft (SESM)		FMI5	Current below normal or open circuit	<p>Activate:</p> <ol style="list-style-type: none"> 1.Signal voltage is below normal range and, 2. Supply voltage is in the normal range <p>Deactivate:</p>	<p>Yellow lamp is sent</p> <p>Reduced gear change performance</p> <p>Reduced gear change comfort</p>	

FUNCTION	PID/SID	FMI J1587	ERROR	CONDITION	SYMPTOM	COMMENT
				Signal and supply voltage is in the normal range		
Sensor for the temperature of the gearbox oil (SETeGO)	PID177	FMI0	Data valid but above normal operational range	<p>Activate low: 1. The sensor signal is in normal range 2. Temperature is above 100dgC during 18000s</p> <p>Deactivate low: 1. The sensor signal is in normal range 2. Temperature is below 100dgC</p> <p>Activate medium: 1. The sensor signal is in normal range 2. Temperature above 120dgC during 600s</p> <p>Deactivate medium: 1. The sensor signal is in normal range 2. Temperature is below 120dgC</p> <p>Activate high: 1. The sensor signal is in normal range 2. Temperature is above 140dgC during 30s</p> <p>Deactivate high: 1. The sensor signal is in normal range Temperature is below 140dgC</p>	<p>Low: Yellow lamp is sent Symbol for high gearbox oil temperature is lit</p> <p>Medium: Yellow lamp is sent Symbol for high gearbox oil temperature is lit</p> <p>High: Red lamp is sent Symbol for high gearbox oil temperature is lit</p>	Gearbox oil temperature fault codes are only set if the vehicle has oil temperature sensor functionality installed
Sensor for the temperature of the gearbox oil (SETeGO)		FMI4	Voltage below normal or shorted low	<p>Activate: The sensor signal is below normal range</p> <p>Deactivate: The sensor signal is in normal range</p>	Yellow lamp is sent	
Sensor for the temperature of the gearbox oil (SETeGO)		FMI5	Current below normal or open circuit	<p>Activate: The sensor signal is above normal range</p> <p>Deactivate: The sensor signal is in normal range</p>	Yellow lamp is sent	
Sensor position of the clutch (SEPoC and SEPoCINV)	PID33	FMI2	Data erratic, intermittent or incorrect	Activate: The difference between clutch positions indicated by the sensor signal	Yellow lamp is sent Reduced clutch performance Reduced gearbox comfort	The PID 33 fault code should not be set if there is an active fault code on the clutch position sensor supply (PPID 54) The clutch position sensor

Section 07: TRANSMISSION

FUNCTION	PID/SID	FMI J1587	ERROR	CONDITION	SYMPTOM	COMMENT
				(SEPoC) and the inverted sensor signal (SEPoC INV) is to large and both signals is within normal range Deactivate: The difference between clutch positions indicated by the sensor signal (SEPoC) and the inverted sensor signal (SEPoC INV) is normal	at start and marshalling Gear changes are slow	has four connectors: one supply, one ground and two connectors for the sensor signal. With correct input the input voltage of the sensor signal, the inverted sensor signal and the sensor supply, they will follow the nominal relation $(Usepoc + Usepoc_inv) / Usepoc5V = 100\%$
Sensor position of the clutch (SEPoC and SEPoCINV)		FMI3	Voltage above normal or shorted high	Activate: Sensor signal is short circuit to Ubatt or sensor supply, when at least one of the sensor signals is above normal range. Deactivate: No sensor signal is above normal range	Yellow lamp is sent Reduced clutch performance Reduced gearbox comfort at start and marshalling Gear changes are slow	The PID 33 fault code should not be set if there is an active fault code on the clutch position sensor supply (PPID 54)
Sensor position of the clutch (SEPoC and SEPoCINV)		FMI5	Current below normal or open circuit	Activate: 1. Open circuit on any of the sensor signals is detected when: one of the sensor signals is within normal range and the other sensor signal is below normal range 2. Open circuit on ground, detected when both the sensor signals are within the normal range and the sum of the sensor signals is above a specific value Deactivate: No activation condition is no longer fulfilled	Yellow lamp is sent Reduced clutch performance Reduced gearbox comfort at start and marshalling gear changes are slow	The PID 33 fault code should not be set if there is an active fault code on the clutch position sensor supply (PPID 54)
Sensor position of the clutch (SEPoC and SEPoCINV)		FMI12	Faulty device or component	Activate: Both sensor signals are below normal when: 1. Status of the sensor ASIC reports internal fault on the sensor, or	Yellow lamp is sent Reduced clutch performance Reduced gearbox comfort at start and marshalling gear changes	The PID 33 fault code should not be set if there is an active fault code on the clutch position sensor supply (PPID 54)

FUNCTION	PID/SID	FMI J1587	ERROR	CONDITION	SYMPTOM	COMMENT
				2. Short circuit to Gnd on any of the sensor signals, or 3. Open circuit on supply, or 4. Short circuit between the two sensor signals Deactivate: Both sensor signals are not below normal level	are slow	
Sensor position of the clutch (SEPoC and SEPoCINV)		FMI13	Calibration value out of range	Activate: 1. The CS in NVRAM is not correct 2. The cylinder has not been calibrated Deactivate: Sensor signal has been successfully calibrated	Yellow lamp is sent Cranking is inhibited Engine can not start	The PID 33 fault code should not be set if there is an active fault code on the clutch position sensor supply (PPID 54)
Slow clutch valves low side (VAS-)	PSID6	FMI3	Voltage above normal or shorted high	Activate: The low-side drive is short circuit to Ubatt Deactivate: The low-side drive is OK	Yellow lamp is sent Slow engagement/disengagement disabled Reduced clutch performance, especially at start and marshalling	
Slow clutch valves low side (VAS-)		FMI6	Current above normal or grounded circuit	Activate: 1. The low-side drive is short circuit to Gnd and 2. There is no active fault code for short circuit to Gnd on VASE or VASD Deactivate: The low-side drive is OK	Yellow lamp is sent Slow engagement /disengagement disabled Reduced clutch performance, especially at start and marshalling	
Split engagement system	PSID23	FMI0	Unintentional disengagement of indirect split	Conditions to set the fault code: -The split cylinder position leaves the indirect position -The split cylinder valves are inactive	Yellow lamp is sent Loss of torque	Detailed conditions to activate/deactivate: The following conditions must be fulfilled three times (only once if the fault code-filter is switched OFF) in a row, in order to set the fault code: (engagement of another gear will reset the count) - The split cylinder position indicates that split gear leaves the indirect position - The split cylinder valves are inactive - There is no active fault on any of the sensor for the

Section 07: TRANSMISSION

FUNCTION	PID/SID	FMI J1587	ERROR	CONDITION	SYMPTOM	COMMENT
						position of the split cylinder (SEPoS) the valve for shift to direct split the valve for shift to indirect split - There is no active fault code for low air pressure <i>note:</i> The fault will always have the state inactive. Check fault-count and last occurrence to get more information
Split engagement system		FMI1	Unintentional disengagement of direct split	Conditions to set the fault code: -The split cylinder position leaves the direct position -The split cylinder valves are inactive	Yellow lamp is sent Loss of torque	Detailed conditions to activate/deactivate: The following conditions must be fulfilled three times (only once if the fault code-filter is switched OFF) in a row, in order to set the fault code: (engagement of another gear will reset the count) - The split cylinder position indicates that split gear leaves the direct position - The split cylinder valves are inactive - There is no active fault on any of the sensor for the position of the split cylinder (SEPoS) the valve for shift to direct split the valve for shift to indirect split - There is no active fault code for low air pressure <i>Note:</i> The fault will always have the state inactive. Check fault-count and last occurrence to get more information
Split engagement system		FMI2	Unintentional disengagement of neutral split	Conditions to set the fault code: -The split cylinder position leaves the neutral position -The split cylinder valves are inactive	Yellow lamp is sent	Detailed conditions to activate/deactivate: The following conditions must be fulfilled three times (only once if the fault code-filter is switched OFF) in a row, in order to set the fault code: (engagement of another gear will reset the count) - The split cylinder position indicates that split gear leaves the neutral position - The split cylinder valves are inactive - There is no active fault on any of the sensor for the position of the split cylinder (SEPoS) the valve for shift to direct split the valve for shift to indirect split - There is no active fault code for low air pressure <i>Note:</i> The fault will always have the state inactive.

FUNCTION	PID/SID	FMI J1587	ERROR	CONDITION	SYMPTOM	COMMENT
						Check fault-count and last occurrence to get more information
Split engagement system		FMI11	Blocked engagement of indirect split	Conditions to set the fault code: -The indirect split gear can not engage	Yellow lamp is sent Loss of torque Only direct split gears will be selected by the system for a short while. After five successful gearshifts a new attempt to use indirect split may be made	Detailed conditions to activate/deactivate: The following conditions must be fulfilled three times (only once if the fault code-filter is switched OFF) in a row, in order to set the fault code: - The split valve for reaching indirect split is activated for at least 0.8s - The split cylinder position sensor indicates that indirect position is not engaged - There is no active fault on any of the sensor for the position of the split cylinder (SEPoS) the valve for shift to direct split the valve for shift to indirect split - There is no active fault code for low air pressure The fault is deactivated if any of the following conditions are fulfilled: - The split cylinder position sensor indicates that indirect position is engaged - There is an active fault code on any of the sensor for the position of the split cylinder (SEPoS) the valve for shift to direct split the valve for shift to indirect split
Split engagement system		FMI12	Blocked engagement of direct split	Conditions to set the fault code: -The direct split gear can not engage	Yellow lamp is sent Loss of torque Only indirect split gears will be selected by the system for a short while. After five successful gearshifts a new attempt to use direct split may be made	Detailed conditions to activate/deactivate: The following conditions must be fulfilled three times (only once if the fault code-filter is switched OFF) in a row, in order to set the fault code: - The split valve for reaching direct split is activated for at least 0.8s - The split cylinder position sensor indicates that direct position is not engaged - There is no active fault on any of the sensor for the position of the split cylinder (SEPoS) the valve for shift to direct split the valve for shift to indirect split - There is no active fault code for low air pressure The fault is deactivated if any of the following conditions are fulfilled: - The split cylinder position

Section 07: TRANSMISSION

FUNCTION	PID/SID	FMI J1587	ERROR	CONDITION	SYMPTOM	COMMENT
						sensor indicates that direct position is engaged - There is an active fault code on any of the sensor for the position of the split cylinder (SEPoS) the valve for shift to direct split the valve for shift to indirect split
Split engagement system		FMI7	Blocked engagement of neutral split	Conditions to set the fault code: -The neutral split gear can not engage	Yellow lamp is sent Eco roll is not available	Detailed conditions to activate/deactivate: The following conditions must be fulfilled three times (only once if the fault code-filter is switched OFF) in a row, in order to set the fault code: - The split valve for reaching neutral split is activated for at least 0.8s - The split cylinder position sensor indicates that neutral position is not engaged - There is no active fault on any of the sensor for the position of the split cylinder (SEPoS) the valve for shift to direct split the valve for shift to indirect split - There is no active fault code for low air pressure The fault is deactivated if any of the following conditions are fulfilled: - The split cylinder position sensor indicates that neutral position is engaged - There is an active fault code on any of the sensor for the position of the split cylinder (SEPoS) the valve for shift to direct split the valve for shift to indirect split
TECU Power supply	PID158	FMI0	Data valid but above normal operational range	Activate: 24V system: above 36V 12V system: above 19V Deactivate: 24V system: below 36V 12V system: below 19V	Yellow lamp is sent	
TECU Power supply		FMI1	Data valid but below normal operational range	Activate: 24V system: below 17V 12V system: below 9V Deactivate: 24V system: above 17V 12V system: above 9V	Yellow lamp is sent Reduced gearbox performance	
Valve for activating the	PSID20	FMI3	Voltage above normal or shorted	Activate: The high side drive is short circuit to	Yellow lamp is sent The valve is	PTO fault codes are only set if the PTO exists

FUNCTION	PID/SID	FMI J1587	ERROR	CONDITION	SYMPTOM	COMMENT
PTO number 1 (VAP1)			high	Ubatt Deactivate: The high side drive is OK	activated The PTO can not be deactivated Reduced gear change comfort	
Valve for activating the PTO number 1 (VAP1)		FMI5	Current below normal or open circuit	Activate: The high side drive is open circuit Deactivate: The high side drive is OK	Yellow lamp is sent The valve can not be activated The PTO does not work	
Valve for activating the PTO number 1 (VAP1)		FMI6	Current above normal or grounded circuit	Activate: The high side drive is short circuit to Gnd Deactivate: The high side drive is OK	Yellow lamp is sent The valve can not be activated The PTO does not work	
Valve for activating the PTO number 2 (VAP2)	PSID21	FMI3	Voltage above normal or shorted high	Activate: The high side drive is short circuit to Ubatt Deactivate: The high side drive is OK	Yellow lamp is sent The valve is activated The PTO can not be deactivated Reduced gear change comfort	
Valve for activating the PTO number 2 (VAP2)		FMI5	Current below normal or open circuit	Activate: The high side drive is open circuit Deactivate: The high side drive is OK	Yellow lamp is sent The valve can not be activated The PTO does not work	
Valve for activating the PTO number 2 (VAP2)		FMI6	Current above normal or grounded circuit	Activate: The high side drive is short circuit to Gnd Deactivate: The high side drive is OK	Yellow lamp is sent The valve can not be activated The PTO does not work	
Valve for fast disengagement of the clutch (VAFD)	PSID3	FMI3	Voltage above normal or shorted high	Activate: 1. The high-side drive is short circuited to Ubatt and 2. there is no active fault code for short circuit to Ubatt on VAF- Deactivate: The high-side drive is OK	Yellow lamp is sent Fast engagement/disengagement disabled Reduced clutch performance Gear changes are slow	
Valve for fast disengagement of the clutch (VAFD)		FMI5	Current below normal or open circuit	Activate: The high-side drive is open circuit Deactivate: The high side drive is OK	Yellow lamp is sent Fast disengagement disabled Reduced clutch performance Gear changes are slow	
Valve for fast disengagement of the		FMI6	Current above normal or grounded circuit	Activate: The high-side drive is short circuit to Gnd	Yellow lamp is sent Fast disengagement	

Section 07: TRANSMISSION

FUNCTION	PID/SID	FMI J1587	ERROR	CONDITION	SYMPTOM	COMMENT
clutch (VAFD)				Deactivate: The high-side drive is OK	disabled Reduced clutch performance Gear changes are slow	
Valve for fast engagement of the clutch (VAFE)	PSID1	FMI3	Voltage above normal or shorted high	Activate: 1. The high-side drive is short circuited to Ubatt and, 2. there is no active fault code for short circuit to Ubatt on VAF- Deactivate: The high-side drive is OK	Yellow lamp is sent Fast engagement/disengagement disabled Reduced clutch performance Gear changes are slow	
Valve for fast engagement of the clutch (VAFE)		FMI5	Current below normal or open circuit	Activate: The high-side drive is open circuit Deactivate: The high side drive is OK	Yellow lamp is sent Fast engagement disabled Reduced clutch performance Gear changes are slow	
Valve for fast engagement of the clutch (VAFE)		FMI6	Current above normal or grounded circuit	Activate: The high-side drive is short circuit to Gnd Deactivate: The high-side drive is OK	Yellow lamp is sent Fast engagement disabled Reduced clutch performance Gear changes are slow	
Valve for shifting to direct split (VADS)	SID37	FMI3	Voltage above normal or shorted high	Activate: The high side drive is short circuit to Ubatt Deactivate: The high side drive is OK	Yellow lamp is sent The valve is activated Indirect and neutral split gears are missing Automatic gear selection enters faulty gearbox mode with gear changes only at certain vehicle speeds	
Valve for shifting to direct split (VADS)		FMI5	Current below normal or open circuit	Activate: The high side drive is open circuit Deactivate: The high side drive is OK	Yellow lamp is sent The valve can not be activated Split gears are missing Automatic gear selection enters faulty gearbox mode with gear changes only at certain vehicle speeds	
Valve for shifting to direct split		FMI6	Current above normal or grounded	Activate: The high side drive is short circuit to	Yellow lamp is sent The valve can	

FUNCTION	PID/SID	FMI J1587	ERROR	CONDITION	SYMPTOM	COMMENT
(VADS)			circuit	Gnd Deactivate: The high side drive is OK	not be activated Split gears are missing Automatic gear selection enters faulty gearbox mode with gear changes only at certain vehicle speeds	
Valve for shifting to gear 1 (VAG1)	PSID12	FMI3	Voltage above normal or shorted high	Activate: The high side drive is short circuit to Ubatt Deactivate: The high side drive is OK	Yellow lamp is sent The valve is activated Gears are missing Automatic gear selection enters faulty gearbox mode with gear changes only at certain vehicle speeds	
Valve for shifting to gear 1 (VAG1)		FMI5	Current below normal or open circuit	Activate: The high side drive is open circuit Deactivate: The high side drive is OK	Yellow lamp is sent The valve can not be activated Gears are missing Automatic gear selection enters faulty gearbox mode with gear changes only at certain vehicle speeds	
Valve for shifting to gear 1 (VAG1)		FMI6	Current above normal or grounded circuit	Activate: The high side drive is short circuit to Gnd Deactivate: The high side drive is OK	Yellow lamp is sent The valve can not be activated Gears are missing Automatic gear selection enters faulty gearbox mode with gear changes only at certain vehicle speeds	
Valve for shifting to gear 2 (VAG2)	PSID14	FMI3	Voltage above normal or shorted high	Activate: The high side drive is short circuit to Ubatt Deactivate: The high side drive is OK	Yellow lamp is sent The valve can not be activated Gears are missing Automatic gear selection enters faulty gearbox mode with gear changes only at certain vehicle speeds	
Valve for shifting to gear 2		FMI5	Current below normal or open circuit	Activate: The high side drive is open circuit Deactivate: The	Yellow lamp is sent The valve can not be activated	

Section 07: TRANSMISSION

FUNCTION	PID/SID	FMI J1587	ERROR	CONDITION	SYMPTOM	COMMENT
(VAG2)				high side drive is OK	Gears are missing Automatic gear selection enters faulty gearbox mode with gear changes only at certain vehicle speeds	
Valve for shifting to gear 2 (VAG2)		FMI6	Current above normal or grounded circuit	Activate: The high side drive is short circuit to Gnd Deactivate: The high side drive is OK	Yellow lamp is sent The valve can not be activated Gears are missing Automatic gear selection enters faulty gearbox mode with gear changes only at certain vehicle speeds	
Valve for shifting to gear 3 (VAG3)	PSID15	FMI3	Voltage above normal or shorted high	Activate: The high side drive is short circuit to Ubatt Deactivate: The high side drive is OK	Yellow lamp is sent The valve can not be activated Gears are missing Automatic gear selection enters faulty gearbox mode with gear changes only at certain vehicle speeds	
Valve for shifting to gear 3 (VAG3)		FMI5	Current below normal or open circuit	Activate: The high side drive is open circuit Deactivate: The high side drive is OK	Yellow lamp is sent The valve can not be activated Gears are missing Automatic gear selection enters faulty gearbox mode with gear changes only at certain vehicle speeds	
Valve for shifting to gear 3 (VAG3)		FMI6	Current above normal or grounded circuit	Activate: The high side drive is short circuit to Gnd Deactivate: The high side drive is OK	Yellow lamp is sent The valve can not be activated Gears are missing Automatic gear selection enters faulty gearbox mode with gear changes only at certain vehicle speeds	
Valve for shifting to gear reverse (VAGR)	PSID13	FMI3	Voltage above normal or shorted high	Activate: The high side drive is short circuit to Ubatt Deactivate: The	Yellow lamp is sent The valve is activated Gears are	

FUNCTION	PID/SID	FMI J1587	ERROR	CONDITION	SYMPTOM	COMMENT
				high side drive is OK	missing Automatic gear selection enters faulty gearbox mode with gear changes only at certain vehicle speeds	
Valve for shifting to gear reverse (VAGR)		FMI5	Current below normal or open circuit	Activate: The high side drive is open circuit Deactivate: The high side drive is OK	Yellow lamp is sent The valve can not be activated Gears are missing Automatic gear selection enters faulty gearbox mode with gear changes only at certain vehicle speeds	
Valve for shifting to gear reverse (VAGR)		FMI6	Current above normal or grounded circuit	Activate: The high side drive is short circuit to Gnd Deactivate: The high side drive is OK	Yellow lamp is sent The valve can not be activated Gears are missing Automatic gear selection enters faulty gearbox mode with gear changes only at certain vehicle speeds	
Valve for shifting to high range (VAHR)	SID35	FMI3	Voltage above normal or shorted high	Activate: The high side drive is short circuit to Ubatt Deactivate: The high side drive is OK	Yellow lamp is sent The valve is activated Low range gears are missing Automatic gear selection enters faulty gearbox mode with gear changes only at certain vehicle speeds	
Valve for shifting to high range (VAHR)		FMI5	Current below normal or open circuit	Activate: The high side drive is Open circuit Deactivate: The high side drive is OK	Yellow lamp is sent The valve can not be activated Range gears are missing Automatic gear selection enters faulty gearbox mode with gear changes only at certain vehicle speeds	
Valve for shifting to high range (VAHR)		FMI6	Current above normal or grounded circuit	Activate: The high side drive is short circuit to Gnd Deactivate: The high side drive is	Yellow lamp is sent The valve can not be activated Range gears are missing	

Section 07: TRANSMISSION





FUNCTION	PID/SID	FMI J1587	ERROR	CONDITION	SYMPTOM	COMMENT
				OK	Automatic gear selection enters faulty gearbox mode with gear changes only at certain vehicle speeds	
Valve for shifting to indirect split (VAIDS)	SID38	FMI3	Voltage above normal or shorted high	Activate: The high side drive is short circuit to Ubatt Deactivate: The high side drive is OK	Yellow lamp is sent The valve is activated Direct and neutral split gears are missing Automatic gear selection enters faulty gearbox mode with gear changes only at certain vehicle speeds	
Valve for shifting to indirect split (VAIDS)		FMI5	Current below normal or open circuit	Activate: The high side drive is open circuit Deactivate: The high side drive is OK	Yellow lamp is sent The valve can not be activated Split gears are missing Automatic gear selection enters faulty gearbox mode with gear changes only at certain vehicle speeds	
Valve for shifting to indirect split (VAIDS)		FMI6	Current above normal or grounded circuit	Activate: The high side drive is short circuit to Gnd Deactivate: The high side drive is OK	Yellow lamp is sent The valve can not be activated Split gears are missing Automatic gear selection enters faulty gearbox mode with gear changes only at certain vehicle speeds	
Valve for shifting to low range (VALR)	SID36	FMI3	Voltage above normal or shorted high	Activate: The high side drive is short circuit to Ubatt Deactivate: The high side drive is OK	Yellow lamp is sent The valve is activated High range gears are missing Automatic gear selection enters faulty gearbox mode with gear changes only at certain vehicle speeds	
Valve for shifting to low range		FMI5	Current below normal or open circuit	Activate: The high side drive is open circuit Deactivate: The	Yellow lamp is sent The valve can not be activated	



FUNCTION	PID/SID	FMI J1587	ERROR	CONDITION	SYMPTOM	COMMENT
(VALR)				high side drive is OK	Range gears are missing Automatic gear selection enters faulty gearbox mode with gear changes only at certain vehicle speeds	
Valve for shifting to low range (VALR)		FMI6	Current above normal or grounded circuit	Activate: The high side drive is short circuit to Gnd Deactivate: The high side drive is OK	Yellow lamp is sent The valve can not be activated Range gears are missing Automatic gear selection enters faulty gearbox mode with gear changes only at certain vehicle speeds	
Valve for slow disengagement of the clutch (VASD)	PSID4	FMI3	Voltage above normal or shorted high	Activate: 1. The high-side drive is short circuit to Ubatt and 2. There is no active fault code for short circuit to Ubatt on VAS- Deactivate: The high-side drive is OK	Yellow lamp is sent Slow engagement/disengagement disabled Reduced clutch performance, especially at start and marshalling	
Valve for slow disengagement of the clutch (VASD)		FMI5	Current below normal or open circuit	Activate: The high-side drive is open circuit Deactivate: The high-side drive is OK	Yellow lamp is sent Slow disengagement disabled Reduced clutch performance	
Valve for slow disengagement of the clutch (VASD)		FMI6	Current above normal or grounded circuit	Activate: The high-side drive is short circuit to Gnd Deactivate: The high-side drive is OK	Yellow lamp is sent Slow disengagement disabled Reduced clutch performance	
Valve for slow engagement of the clutch (VASE)	PSID2	FMI3	Voltage above normal or shorted high	Activate: 1. The high-side drive is short circuit to Ubatt and 2. There is no active fault code for short circuit to Ubatt on VAS- Deactivate: The high-side drive is OK	Yellow lamp is sent Slow engagement/disengagement disabled Reduced clutch performance, especially at start and marshalling	
Valve for slow engagement of the clutch (VASE)		FMI5	Current below normal or open circuit	Activate: The high-side drive is open circuit Deactivate: The high-side drive is OK	Yellow lamp is sent Slow engagement disabled Reduced clutch performance, especially at	

Section 07: TRANSMISSION

FUNCTION	PID/SID	FMI J1587	ERROR	CONDITION	SYMPTOM	COMMENT
					start and marshalling	
Valve for slow engagement of the clutch (VASE)		FMI6	Current above normal or grounded circuit	Activate: The high-side drive is short circuit to Gnd Deactivate: The high-side drive is OK	Yellow lamp is sent Slow engagement disabled Reduced clutch performance, especially at start and marshalling	
Valve for the gearbox brake (VAGB)	PSID22	FMI3	Voltage above normal or shorted high	Activate: The high side drive is short circuit to Ubatt Deactivate: The high side drive is OK	Red lamp is sent The valve and the brake are activated The gearbox will be damaged if the vehicle drives The prop shaft has to be removed to move the vehicle	
Valve for the gearbox brake (VAGB)		FMI5	Current below normal or open circuit	Activate: The high side drive is open circuit Deactivate: The high side drive is OK	Yellow lamp is sent The valve can not be activated Shifting to the start gear takes long time	
Valve for the gearbox brake (VAGB)		FMI6	Current above normal or grounded circuit	Activate: The high side drive is short circuit to Gnd Deactivate: The high side drive is OK	Yellow lamp is sent The valve can not be activated Shifting to the start gear takes long time	

10. VOLVO I-SHIFT TRANSMISSION GSECU FAULT CODES

PID/PPID SID/PSID	FM I	LAMP	CONTENT	TEXT	COMMENT	CONSEQUENCES
SID231	2	None	SAE J1939 Data Link	-	-	Redundancy on J1587
SID237	3		Start enable device	Check Gear Selector System at next stop	Only for EMS1.xx vehicles	Start relay not working
SID240	2		Program memory	Gear Selector System failure	Boot	Not possible to engage gear
SID250	9	None	SAE J1708 /J1587 data link	-	-	-
SID253	2		Program memory	Gear Selector System failure	-	Not possible to engage gear
SID254	12		Controller #1	Gear Selector System failure	-	Not possible to engage gear
PSID9	12		Gear level	Check Gear	-	Not possible to

PID/PPID SID/PSID	FM I	LAMP	CONTENT	TEXT	COMMENT	CONSEQUENCES
			position sensors	Selector System at next stop		engage/change gear
PSID36	7		Output actuator (REPS)	Check Gear Selector System at next stop	-	Fault displayed after ignition OFF. Risk of battery discharge if main circuit breaker is not opened when vehicle is not used
PSID36	12		Output actuator (REPS)	Check Gear Selector System at next stop	-	Gearbox not supplied
PSID42	2	None	Ignition signals	-	-	Power supply always on
PSID200	9	None	Data Link, MID128	Check Gear Selector System at next stop	Only for AMT-C, Boot	Affects RT only (can be sent for VT)
PSID201	9	None	Data Link, MID144	Check Gear Selector System at next stop	Only for AMT-C, Boot	Affects RT only (can be sent for VT)
PSID205	9	None	Data Link, MID130	Check Gear Selector System at next stop	Boot	Affects RT only (can be sent for VT)
PSID214	9	None	Data Link, MID249	-	Only when second gear selector is installed, Boot	Not possible to switch to/from secondary gear lever

11. SPECIFICATIONS

ALLISON AUTOMATIC TRANSMISSION WITH OR WITHOUT RETARDER

H3 Buses

Gross input power (maximum).....500 HP (335 kW)

Gross input torque (maximum) 1525 Lbf-ft (2068 Nm)

Rated input speed (minimum-maximum) 1600-2300 rpm

H3-45 VIP

Gross input power (maximum).....525 HP (392 kW)

Gross input torque (maximum) 1650 Lbf-ft (2237 Nm)

Rated input speed (minimum-maximum) 1600-2300 rpm

Mounting:

Engine..... SAE #1 flywheel housing, flex disk drive

Torque converter:

Type One stage, three element, polyphase

Stall torque ratio..... TC 551-1.8

Lockup clutch with torsional damper Integral/standard

Gearing:

Section 07: TRANSMISSION

Type Patented, constant mesh, helical, planetary

Ratio:

First 3.51:1
Second 1.91:1
Third 1.43:1
Fourth 1.00:1
Fifth 0.74:1
Sixth 0.64:1
Reverse 4.80:1

Ratio coverage:

6 speed 5.48:1

- o **Gear ratios do not include torque converter multiplication.**

Oil System:

Oil type TRANSYND, TES295, TES389
Capacity (excluding external circuits) Initial fill 47 US qts (45 liters)
Oil change 24 US qts (23 liters)
Oil change (with retarder) 27.6 US qts (26.5 liters)

Oil Filters:

Make Allison Transmission
Type Disposable cartridge
Prevost part number (2-filters replacement kit) 571709

VOLVO I-SHIFT TRANSMISSION

Oil System:

Oil type CASTROL SYNTRANS 75W85
Oil change 16 US qts (15 liters)

Oil Filter:

Make Volvo
Type Disposable cartridge
Prevost Part Number 20779040