

Driver's Handbook

Volvo 9700 US/CAN
B13R



VOLVO

Foreword

This manual contains information concerning the operation and function of the Volvo 9700 US/Can bus with version 2 of the multiplex electrical system. The information in this manual applies to vehicles built January 2009 and later. Please keep this manual in the vehicle at all times.

Note: Illustrations in this manual are used for reference only and may differ slightly from the actual vehicle. However, key components addressed in this document are represented as accurately as possible.

The National Highway Traffic Safety Administration (NHTSA) and Prevost should be informed immediately if you believe that the vehicle has a defect that could cause a crash, injury or death.

Contact NHTSA by calling the Auto Safety Hotline at 1 (888) 327-4236, by writing to NHTSA, U.S. Department of Transportation, Washington, DC 20590, by TTY at 1 (800) 424-9153, or visit their website at www.nhtsa.dot.gov.

Volvo Bus Corporation

Göteborg, Sweden

Order number: PV776-88913775

© 2009 Volvo Bus Corporation, Göteborg, Sweden

All rights reserved. No part of this publication may be reproduced, stored in retrieval system, or transmitted in any forms by any means, electronic, mechanical, photocopying, recording or otherwise, without the prior written permission of Volvo Bus Corporation

Contents

Introduction	1
Driver's Responsibility	1
Keys	2
Entering the Bus	3
Main Power Switch	3
Emergency Stop	3
Protection Against Battery Discharge	4
Doors and Hatches	5
Doors	5
Opening from Inside	5
Closing	6
Hatches	7
9700 US/CAN (with Wheel Chair Lift)	8
9700 US/CAN (without Wheel Chair Lift)	9
Roof Hatches	10
Driver's Position	11
Driver's Position	11
Driver's Seat	12
Horn	12
Dashboard	13
Instruments and Controls	14
Faults and Warnings	14
Accelerator Pedal Deactivated	14
STOP Message	15
Warning Message	15
Information Message	15
Instrumentation	16
Types of Instruments	16
Instrument Panel Lamps and Symbols	21
Light Switch	23
Switches	24
Main Switch	24
Emergency Stop	24
Kneeling	25
Level Control	26

Increasing Load on the Driving Axle (trailing axle lift)	27
Traction Control System (TCS)	27
Differential Lock	28
Hill Start Assistance	28
Passenger Compartment Lighting	29
Night Lighting	29
Half-light	29
Driver Compartment Lighting	29
Passengers' Individual Lighting	30
Rear Door Lighting	30
Position Lights	30
Lighting Strip	30
Destination Sign Lighting	31
Electrically Heated Rear Mirrors	31
Driver's Window Heating	31
Driver's Blower	32
Central Locking	32
Sun Blind	32
Driver's Window	32
Activation of the Toilet	33
Audio System	33
Opening the Doors from the Outside	33
Middle Door	33
Emergency Window in use Indicator Lamp	34
Switches in the Electrical Center	34
Controls	35
Starting Switch	35
Adjusting External Rear-view Mirrors	35
Door Brake	36
Steering Wheel Adjustment	37
Direction Indicator, Dipped/full Beam Changer	38
Windscreen Wipers, Windscreen/headlight Washer	39
Transmission	40
Transmission, I-shift	40
Retarder	41
Retarder Overheating	42
Transmission Overheating	43
Brakes	44

Parking Brake	44
Blocking Valve	45
Service Brakes	46
Destination sign control	49
A/C Controller	49
Interior Equipment	50
Interior Equipment	50
Toilet	51
Passengers' panel	52
Audiovisual System	53
Audiovisual System	53
Audiovisual Controller	54
Video System	54
Audio System	54
Emergency and Safety Equipment	55
Overview	55
Fire Extinguisher	55
Warning Triangle	56
First-aid Cushion	56
Tire Inflation Valve	56
External Air Supply Connection	57
Jack	57
Toolbox	58
Engine Control Box in Engine Bay	59
Emergency Exits	60
Doors	60
Windows	60
Ceiling, Roof Hatches	61
Starting and Driving	62
Checking Before Driving	62
Checking Warning Lights	63
Daily Inspection	63
Engine	63
Steering Servo/hydraulic Fan	64
Coolant	64
Washer Fluid	64
Refuelling	65

Engine Block Heater	65
Starting the Engine	66
Starting	66
Checks After the Engine Has Been Started.	67
Idling (programming)	68
Cruise Control	69
Retarder	70
Power Steering	72
Exhaust Aftertreatment System	73
Some Advice for Driving	74
Safe Driving	74
Economy Driving	75
Driving in Cold Weather	76
If Something Happens	77
Safety	77
If the Engine is Not Working	78
Punctures	78
Punctured Air Bellows	78
Towing	79
Fire	80
Releasing the Parking Brake	81
Release the Parking Brake with Air from the Bus Tires.	81
Mechanical Releasing of the Parking Brake	82
Regarding Disc Brakes	82
Changing the Batteries	83
Rapid Charging	84
Starting Assistance	84
Battery Cut-off Switch	85
Bulb Replacement	86
Headlamps	86
Rear Lights	86
Xenon Lights	87
Licence Plate Lighting	87
Fuses and Relays (chassis)	88
Relays	88
Fuses	90
Fuses and relays (body)	93
Relays	93

Fuses	94
Technical Data	96
Technical Specification	96
Bulbs	97
Type Plates	98
Identification Plate	98
Vehicle Identification (VIN)	99
Engine	99
Transmission	99
Rear Axle	99
Retarder	99
Service Intervals	100

Safety Information

IMPORTANT: Before driving this vehicle, be certain that you have read and that you fully understand each and every step of the driving and handling information in this manual. Be certain that you fully understand and follow all safety warnings.

IT IS IMPORTANT THAT THE FOLLOWING INFORMATION BE READ, UNDERSTOOD AND ALWAYS FOLLOWED.

The following types of advisories are used throughout this manual:



DANGER

Danger indicates an unsafe practice that could result in serious personal injury or death. A danger advisory banner is in **white** type on a **black** background with a **black** border.



WARNING

Warning indicates an unsafe practice that could result in personal injury. A warning advisory banner is in **black** type on a **gray** background with a **black** border.



CAUTION

Caution indicates an unsafe practice that could result in damage to the product. A caution advisory is in **black** type on a **white** background with a **black** border.

Note: Note indicates a procedure, practice, or condition that must be followed in order for the vehicle or component to function in the manner intended.

Driver's Responsibility

- As the driver, you are responsible for the safety and comfort of the passengers during the journey. Therefore, do not drive the bus before you have read this driver's manual. You must be familiar with all the indicators and warning lights and know what to do if something unexpected happens.
- As the driver of the vehicle, you should be aware of the vehicle weight and loading capacity. See instructions on warning stickers, the vehicle registration book and on the identification plate.
- As the driver of the vehicle, it is your responsibility to foresee any hazards that could threaten your passengers.
- It is also your responsibility to ensure that all the safety equipment of the bus is in place. Therefore check regularly the working order of safety belts, emergency door opening, door sensitive edges, fire extinguishers and first aid equipment.
- The brakes on the bus are operated by compressed air. Never drive if the air pressure is too low or if you discover other problems with the brakes.
- Pay attention to any steering faults. The vehicle can be steered even if the power steering is not working, although the steering will be heavy.
- Never crawl under the bus if it is supported by a jack. Use approved vehicle supports or a solid pallet in case of punctures or wheel changes.
- Lifting devices and supports should stand securely on a horizontal surface. The wheels that are not to be lifted should be blocked to ensure that the vehicle will not start to move.
- Re-tighten the wheel nuts after approximately 200 km (125 mi) if the wheels have been removed.
- Tighten the wheel nuts every 6 months regardless of whether the wheels have been removed or not.
- Follow the recommended service and maintenance programme to maintain the bus's condition and safety.
- Pay attention to exhaust and fuel smells. Any leaks should be taken care of immediately at the garage.
- The bus tires and rims should be approved for the intended load and speed in accordance with current legal requirements.

2 Introduction

Keys

The following keys are delivered with the bus:

- 1 Ignition key
- 2 Glove compartment key
- 3 Door, luggage compartment hatch and toilet
- 4 Service hatch square key
- 5 Electric centre compartment key
- 6 Side glove compartment key
- 7 Fuel filler cap key

There may be alternative versions of the keys, depending on the types of locks that are fitted.

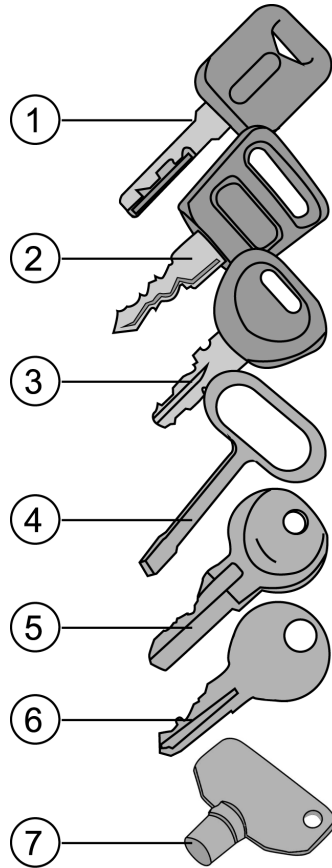

T0015481

Note: Note the number of the ignition key to facilitate ordering of spare keys.

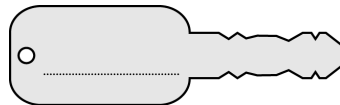

T0013333

Entering the Bus

To open the front door:

- turn the key in the lock to the horizontal position
- turn the knob to the vertical position
- push the pneumatic door opening button

The button for the pneumatic opening of the first door is placed in the door handle.

Note: In case of total or partial emptying of the door pneumatic system, open the door by pushing the right side of the door.

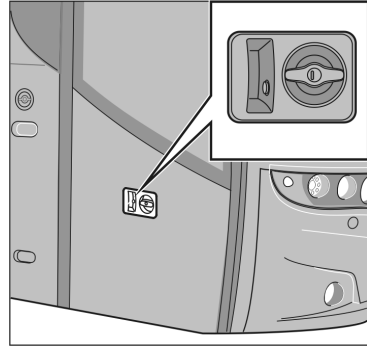

T8012405

Main Power Switch

Is located on the dashboard. Always turn off the power supply with the main switch before leaving the bus.

Note: Never turn off the main switch while the engine is running.

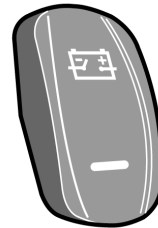

T0012043

Emergency Stop

An emergency switch is located on the left side of the dashboard. Depending on the market specification, the emergency switch may disconnect the bus electrical power supply, cut off the fuel supply and activate the hazard warning lights.

Note: Only use the emergency cut out in an emergency situation.

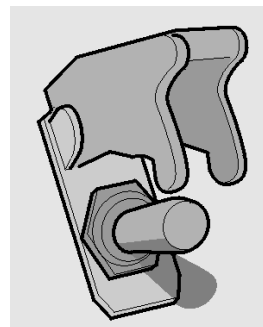

T0009170

Protection Against Battery Discharge

In order to prevent battery discharge while the bus is standing, the Volvo 9700 bus is equipped with a function that disconnects the supply to major electrical consumers such as: the kitchenette, electric heaters, some external lighting etc.

Power to these consumers is switched off around 30 seconds after the engine is shut down, and it is then switched back on once the engine is started and its revolutions reach at least 1000 rpm for 10 seconds.

Doors

The Volvo 9700 bus could be equipped with up to two single-leaf doors opening outwards. The doors are normally operated by pneumatic cylinders.

The doors may be equipped with a system protecting passengers from being trapped in the doorway during opening or closing, this system has sensors measuring the air pressure in the door system.

Note: In the case of excessive drop of the door pneumatic system air pressure, the “Door failure” warning lamp lights in the lower right corner of the bus instrument cluster.



T0012008

Opening from Inside

There are two buttons for door opening on the right hand side of the driver’s dashboard. These buttons are numbered accordingly. Pushing the button causes the door to open. The button indicator lamp is lit when the door is open.



T3018176

Note: Before closing the door/doors ensure that there are no passengers standing in the doorway.

6 Doors and Hatches

Closing

Proceed as follows:

- 1 Move the gear selector into neutral position
- 2 Engage the parking brake
- 3 Turn on the switch that activates the door opening push-button in the door handle
- 4 Open the door
- 5 Turn off the power supply with the main switch
- 6 Leave the bus and close the door using the push-button in the door handle
- 7 Lock the door with the key

Note: After locking the door with the key, the push-button in the door handle becomes inactive.

After turning off the power supply with the main power switch, the light above the entrance door remains on for about 90 seconds.

If the button activating the button in the handle for opening the door **is not switched on**, in order to enter the bus again, the emergency valve must be used.

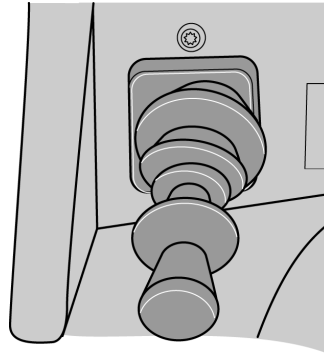

T5014881

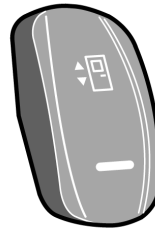

T1008555

Button for outside opening of the door

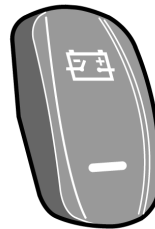

T0012043

Hatches

If any of the bus hatches are open or not properly closed, a “hatch open” symbol will appear on the instrument panel display.

Note: The engine cannot be started unless the engine hatch is closed.

Note: With the engine hatch open, the engine can be started by means of a button in the control box. See: “Engine Control Box in Engine Bay” page 59



T3018116

The configuration of the service and luggage compartment hatches depends on the bus variant. Possible variants are shown below. The description refers to items located behind the hatch.

8 Doors and Hatches

9700 US/CAN (with Wheel Chair Lift)

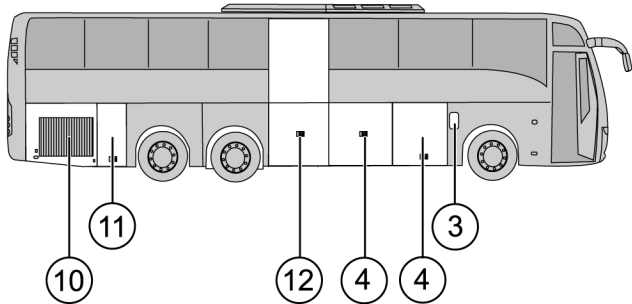
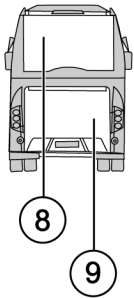
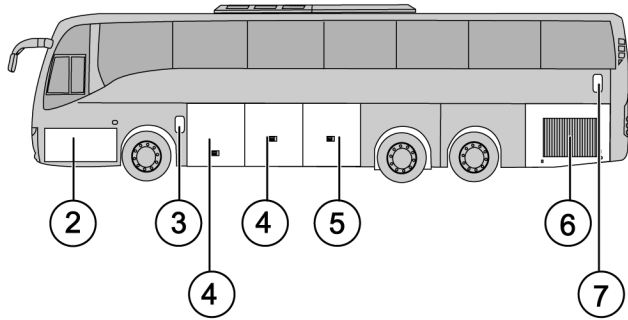
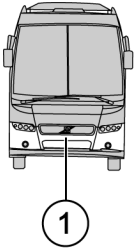

- 1 External air valve, towing point, spare wheel
- 2 Battery box, battery cut-off switch, main fuses, washer fluid reservoir
- 3 Fuel filler
- 4 Luggage compartment hatch
- 5 Wheel chair lift mechanism

- 6 Radiator
- 7 Coolant filler
- 8 DPF
- 9 Engine
- 10 Auxiliary heater
- 11 Waste tank
- 12 Wheel chair lift

T0015488

9700 US/CAN (without Wheel Chair Lift)

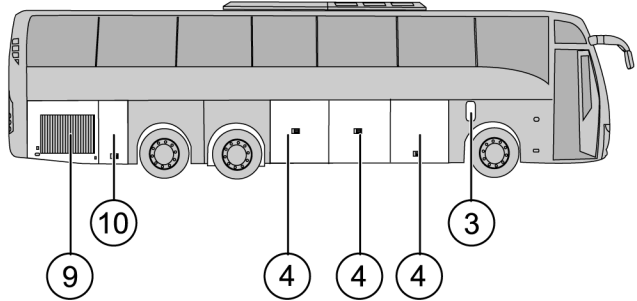
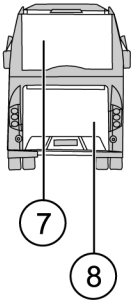
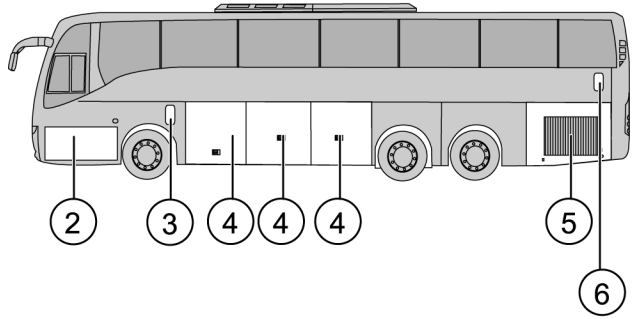
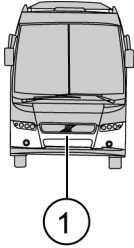

- 1 External air valve, towing point, spare wheel
- 2 Battery box, battery cut-off switch, main fuses, washer fluid reservoir
- 3 Fuel filler
- 4 Luggage compartment

- 5 Radiator
- 6 Coolant filler
- 7 DPF
- 8 Engine
- 9 Auxiliary heater
- 10 Waste tank

T0015489

Roof Hatches

The Volvo 9700 bus is equipped with roof hatches manually operated. Manually operated hatches are opened by the handles on each side of the hatch.

Note: When the A/C is activated in the bus its hatches should be closed, since the air coming in from outside may interfere with the operation of the equipment controlling the temperature inside the bus.

Note: Make sure that the hatches are closed when it's raining and when you leave the bus for a longer period of time.

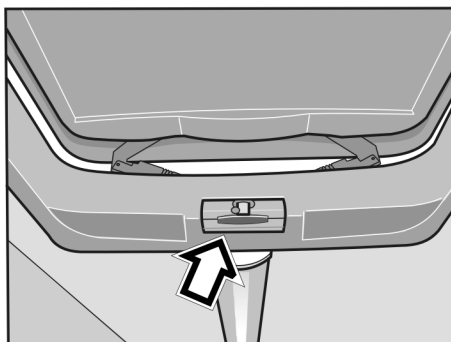

T8010110

Driver's Position



T0015299

- | | | | |
|---|-------------------------------|----|---------------------------------|
| 1 | Side sun visor | 6 | Controller, AC |
| 2 | Side Panel | 7 | Controllers, audiovisual system |
| 3 | Driver's seat | 8 | Locker, audio equipment |
| 4 | Front sun visor | 9 | Steering wheel |
| 5 | Dashboard, instrument cluster | 10 | Gear selector |

12 Driver's Position

Driver's Seat

The Volvo 9700US/CAN bus is equipped with driver's seat type National. For more information see separated instructions "Driver's seat".



DANGER

Adjusting seat position or fastening a seat belt should only be performed when the vehicle is stationary. Attempting this while the vehicle is moving may lead to an accident, causing serious personal injury or death.

Note: The safety belt should not be twisted or blocked when properly fastened.

Note: Before adjusting, check whether there are any objects in front of the seat or behind it, that could hinder adjustment.

Horn

The Volvo 9700US/CAN bus is equipped with one electrical horn (diaphragm) and one operated by compressed air. Pushing the central part of the steering wheel activates the electrical horn, while pushing one of the two small buttons beneath activates the air horn.

Note: Remember that the use of horns is subject to regulations.

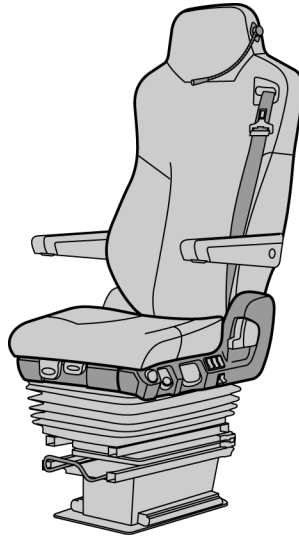

T8010545

Dashboard

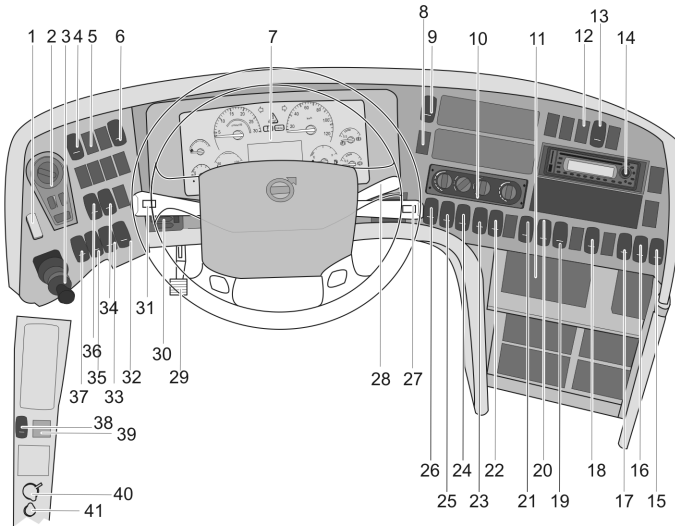

T0015385

- | | | | |
|----|--------------------------------|----|--|
| 1 | Emergency stop | 23 | Night light under seats |
| 2 | Light switch | 24 | Interior lights |
| 3 | Parking Brake | 25 | Reading light |
| 4 | Light for driver's position | 26 | Night light |
| 5 | Over speed | 27 | Display control stalk, wipers and washers control stalk |
| 6 | Front sun visor | 28 | Retarder |
| 7 | Instrument cluster | 29 | Steering wheel adjustment pedal |
| 8 | Emergency Windows Open warning | 30 | Air inlet |
| 9 | Destination sign light | 31 | Control stalk at the steering wheel, direction indicators and cruise control |
| 10 | AC controller | 32 | Traction control system |
| 11 | Video Player DVD | 33 | Hill start auxiliary |
| 12 | Wheel chair lift warning | 34 | Bogie |
| 13 | Wheel chair lift | 35 | Bus level |
| 14 | Audio controller | 36 | Kneeling |
| 15 | Toilet devices | 37 | Main switch |
| 16 | Driver's fan | 38 | Mirror heater |
| 17 | Audio system | 39 | Mirror adjustment |
| 18 | Central lock | 40 | 12V Output |
| 19 | Middle door | 41 | 24V Output |
| 20 | Position lights | | |
| 21 | Service first door | | |
| 22 | Door lock | | |

Faults and Warnings

There are three different types of signals that give the driver all the necessary information on the vehicle:

- STOP message
- warning message
- information message

Above the display there are three lamps (for information, warning and STOP messages), that alert the driver's attention when necessary.

Messages with appropriate symbols are shown automatically on the display.

Several messages can be active simultaneously. A new message will only replace the current message on the display if it is of higher priority. This means that the display always shows the message with the highest priority.

For more detailed information about display functions, see the separate Operating Instruction "Display".

Accelerator Pedal Deactivated

The bus is fitted with prioritized brake function.

This function deactivates a request for acceleration if **both** the accelerator pedal and the foot brake pedal or parking brake have been activated simultaneously.

The accelerator pedal remains deactivated until it is reset, which occurs once the pedal has been fully released.

For additional information on this function, see the separate Operating Instruction "Display".



T0013511

STOP Message

 WARNING
<p>If this lamp lights while driving, stop the bus immediately and turn off the engine. Continuing to drive may severely endanger the vehicle, the driver and/or passengers.</p>

Note: If the STOP message appears while the engine is running, it is accompanied by activation of the audible warning buzzer.



T3014364

Warning Message

If this lamp lights, the vehicle must be taken to a workshop for repair as soon as possible. There is no immediate danger of the vehicle breaking down, and under normal circumstances it should be possible to complete the journey. This lamp is also used to draw the driver's attention to problems other than vehicle failures, e.g. as a warning in the case of an open luggage compartment hatch.



T3014365

Information Message

Simultaneously with this lamp lighting up, a new message is shown on the display. The fact that this lamp lights up does not mean that there is something wrong with the vehicle. This lamp may for example illuminate to draw the driver's attention to low fuel level.



T3014366

16 Instruments and Controls

Instrumentation

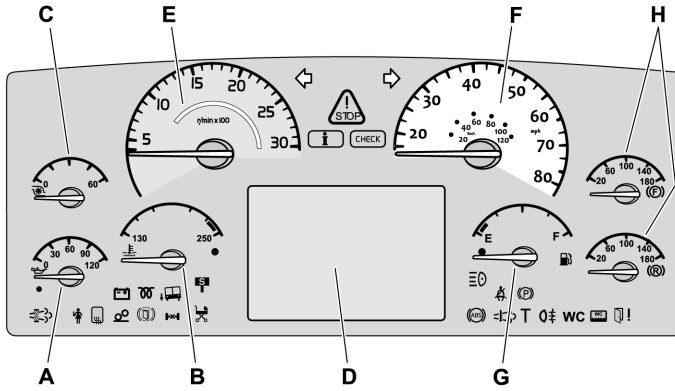

T0015634

Types of Instruments

- A Engine oil pressure gauge
- B Coolant temperature gauge
- C Turbo pressure gauge
- D For the display, see the separate Operating Instruction "Display"
- E Tachometer
- F Speedometer
- G Fuel gauge
- H Air pressure gauge for brakes

Oil Pressure Gauge (A)

The oil pressure gauge indicates the engine oil pressure. While driving with a warm engine, the pointer should show 3–5 bar (40–70 psi).



CAUTION

The bus must not be driven when the pointer is in the red zone! Failure to stop the vehicle immediately may result in engine damage.

Note: It is possible that the pointer will move slightly into the red zone when the engine is idling while it is warm. This does not present any danger as long as the pointer rises above 3 bar (40 psi) when the engine speed increases.

The following will be indicated if the oil pressure in the engine drops too low:

- warning lamp (1) lights,
- STOP– lamp lights
- the acoustic signal sounds (if the engine is running)



CAUTION

If the warning light comes on while driving; stop the engine and locate the cause! Failure to do may result in engine damage.

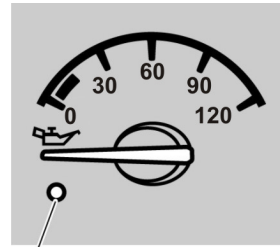

T0015288

1 Warning lamp, red

18 Instruments and Controls

Engine Coolant Temperature Gauge (B)

This gauge indicates the temperature in the engine's coolant system. Under normal driving conditions, the pointer should stay just below the red zone (normal operating temperature is between 80°C (176°F) and 100°C (212°F)).

The engine is fitted with overheating protection, that reduces the engine power output to 50% if the temperature reaches the red zone. The bus can still be driven even after activation of the overheating protection.

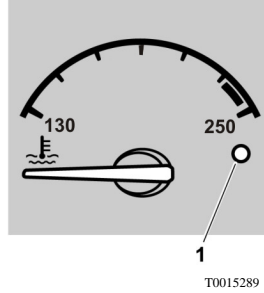

1 Warning lamp, red



CAUTION

The bus must not be driven if the temperature rises even higher as this can result in damage to the engine.

An indicator signals when the cooling system temperature is too high.

- warning lamp (1) lights
- STOP– lamp lights
- the acoustic signal sounds (if the engine is running)

Turbo Pressure Gauge (C)

The turbo pressure gauge indicates the pressure in the intake manifold. A high turbo pressure increases fuel consumption. This gauge helps you drive in the most economical manner. When driving on level roads at constant speed, the pointer should remain still within the green zone.

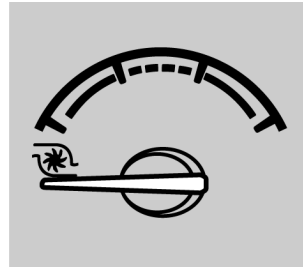

T0011983

Display (D)

The display consists of the main menu and several submenus with their relevant functions. For additional information, see the separate Operating Instruction “Display”.

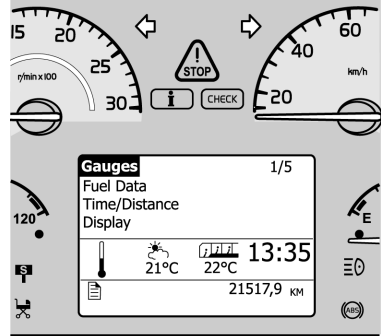

T0012082

Tachometer (E)

The tachometer scale is divided into three zones. During normal driving you should stay within the green zone, which gives the best fuel economy.

	<h3>CAUTION</h3>
<p>Avoid operating the vehicle with the tachometer in the red zone. Such high engine speeds can result in damage to the engine and the transmission.</p>	

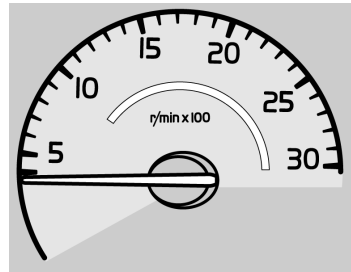

T0011984

Speedometer (F)

The speedometer indicates the speed of the bus in mph. For some markets, speedometers are also available that indicate speed both in mph and km/h.

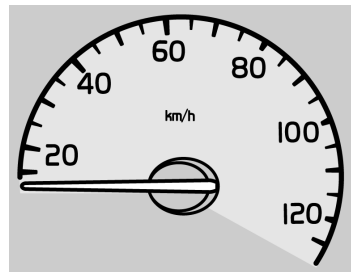

T0011985

20 Instruments and Controls

Fuel Gauge (G)

The fuel gauge shows the amount of fuel in the tank. The red zone and the warning lamp (1) give a warning of low fuel level.

The display gives considerable information on the fuel situation, i.e. fuel consumption, A to B information and remaining fuel. For more information, see separate driver instructions “Display”.

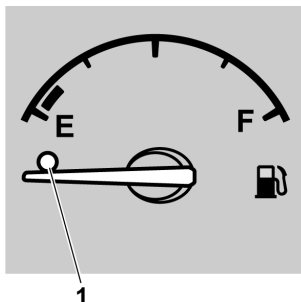

T0011986

Air Pressure Gauge for Brakes (H)



Stop the bus immediately if any of the warning lamps illuminate! A warning lamp will illuminate if there is an excessive pressure drop in the braking system. Investigate the cause of the fall in pressure. Failure to do so may result in failure of the vehicles brakes that may cause an accident, leading to serious personal injury or death.

If the engine remains switched off for a long time, the compressed air pressure may fall to a level which will prevent the bus being started immediately. The warning lamp remains lit until the pressure in the braking system rises to a sufficiently high level. If the compressed air in the braking system has been completely exhausted, it may take quite a long time before the pressure starts to rise.

During driving, the gauge pointer should remain within the green zone, but it can temporarily drop below that zone during braking.

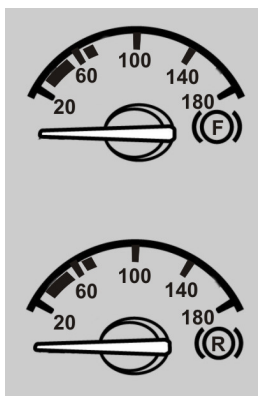







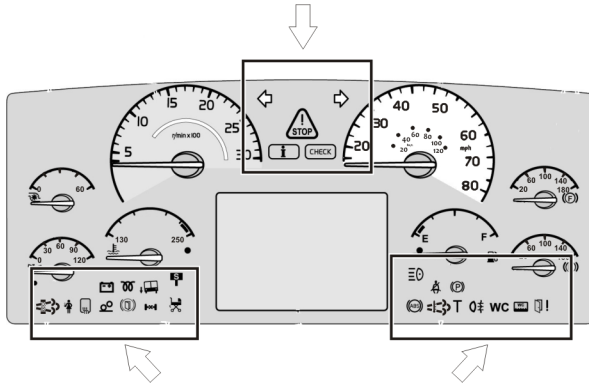







T0015292

- F. Air Pressure, front brake circuit
- R. Air pressure, rear brake circuit













Instrument Panel Lamps and Symbols



T0015293

Symbol	Meaning	Symbol	Meaning
	Left indicator on		Service personnel
	Right indicator on		Screen / mirrors heating activated
	If there is a problem with the bus you must stop.		Battery not charging
	Information message		The switch for increasing load on the drive axle (bogie lift) of the bogie is on
	Check		Pre-heating on
	Door brake activated		Safety belt reminder
	Kneeling activated (for easier access)		Parking brake applied

22 Instruments and Controls

	Differential lock activated		OBD – On-Board Diagnostics
	Stop at the next lay-by		Check the tachograph
	Entering or exiting the bus with a pram		Rear fog lights are on
	Main beam		WC engaged
	ABS not functioning		WC tank full
 T0015482	DPF Regeneration Required		Fault in the door
 T0015483	High Exhaust System Temperature (HEST)		

Light Switch

- a Lights off or automatic activation of dipped beam
- b Parking lights
- c Dipped beam
- d Auxiliary spotlights

- 1 Lighting switch
Pressing the switch turns the front fog lights on and off. Pulling it turns the rear fog lights on and off.
- 2 Indication (repeater) lamp, front fog light
- 3 Indicator light, fog light, rear
- 4 Instrument lighting rheostat
- 5 Hazard warning lights

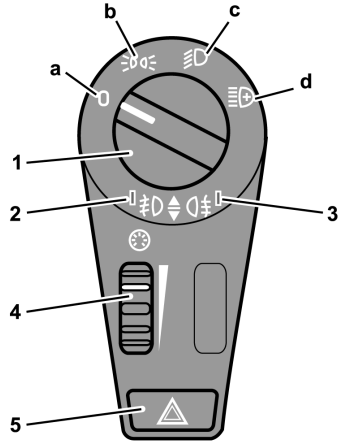

T0012036

Hazard Warning Lights

Pressing this switch in will turn on all the bus hazard warning lights (both sets of direction indicators). The hazard warning lights will work even if both the ignition and power supply are turned off (with the main power switch).

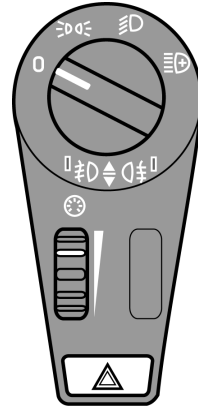

T0014325

DANGER

Use the hazard warning lights if the bus is stopped in a manner that may put other road users at risk. Failure to do so may lead to an accident, resulting in serious personal injury or death.

Switches

The number of switches depends on the bus specification.

Main Switch

The bus is equipped with a main power switch. By switching off the main power before leaving the bus, all the major electrical consumers are switched off, which helps to preserve sufficient battery capacity to enable subsequent bus starting. The main switch does not cut off the power supply to the clocks and auxiliary heater.

Note: Never turn off the main switch while the engine is running.

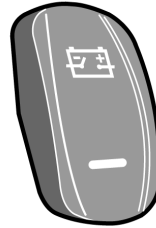

T0012043

Emergency Stop

Note: Only use the emergency cut out in an emergency situation; to switch off the electrical feed in normal conditions use only the main switch.

When the emergency stop is activated the following occurs (can vary from country to country):

- air is exhausted from the door system
- engine is stopped
- power supply to the main electrical consumers is cut off
- fuel supply to the engine is cut off and so is outflow of fuel from the tanks
- hazard lights are switched on
- lights above the doors are switched on

Activate the emergency cut out by lifting the cover upwards and pressing up the switch. When the cover is closed the power switch automatically is pressed down to the disconnected position.

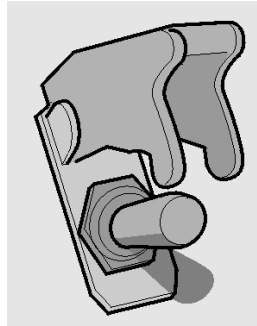

T0009170

Kneeling

This switch allows the right-hand side of the bus to be lowered (kneeling) to a level that facilitates passenger entry and exit.

There are two possible operating modes for the kneeling switch:

- 1 The bus lowers while the kneeling switch is depressed. After reaching the lowest level, i.e. entry/exit level, kneeling stops and the switch can be released. Releasing the switch prior to reaching the lowest level causes the bus to return to the normal ride height.
- 2 Pressing the switch once lowers the bus to its lowest level for entry/exit. When kneeling function is active, three icons in the instrument cluster lit and a blinking lamp is activated at the door as well a acoustic signal

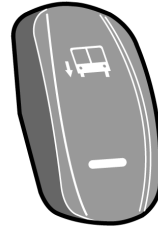

T0012054



T0011996



T0011993



T0011994

Various ways to resume normal riding height:

- pressing the upper part of the switch
- closing the doors
- starting the bus and accelerating beyond 5 km/h (3 mph) road speed (only buses without door brake)
- restarting the engine

Conditions for kneeling:

- engine running (vehicle stopped)
- without extra step



WARNING

Ensure that the bus can kneel without the risk of trapping passengers' feet between the door sill and the kerb. Failure to do so may result in serious personal injury.

Level Control

The ground clearance of the bus can be adjusted with this switch.

- to lower the bus press the lower part of the switch, e.g. while passing under a low bridge.
- to raise the bus press the upper part of the switch, e.g. while driving onto a ferry.

Note: Levelling control should only be used temporarily. During normal driving the switch **must** be in the middle position.

When the bus reaches the selected level a symbol and INFO lamp are shown on the display panel.

The suspension system attempts to keep the bus at the required height irrespective of the load. Any faults in the system are indicated by a symbol and INFO lamp on the display panel.

Note: The speed of the bus must not exceed 30 km/h (20 mph) in the high position or 5 km/h (3 mph) in the low position. If this happens a warning message and warning signal are sent.

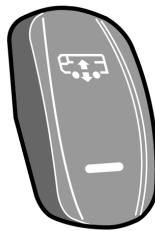

T0012058



T3014366



T0012224

Low pressure in the air suspension system

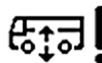

T0012467

Fault in the air suspension system

Increasing Load on the Driving Axle (trailing axle lift)

The drive axle load is increased by pressing this switch. Increase in drive axle load is often an advantage when moving on slippery surfaces.

Pressing this switch increases the load on the driving axle by removing the suspension load on the trailing (non-driving) axle.

The unweighting continues until one of the following takes place:

- speed of the bus rises above 30 km/h (20 mph)
- the switch is pressed again

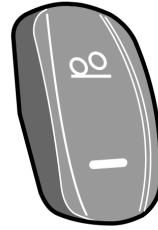

T0012046

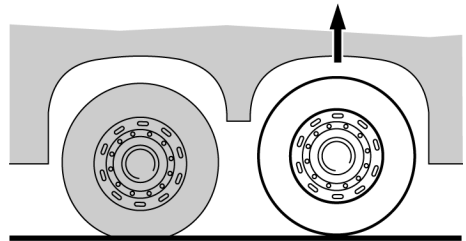

T6009559

Traction Control System (TCS)

The TCS system automatically reduces the driving torque of the engine if the drive wheels start to spin.

At speeds below 40 km/h (25 mph) the TCS system also acts as an automatic differential brake, braking the driving wheel that begins to spin.

For more information, see separate driver instructions "EBS".

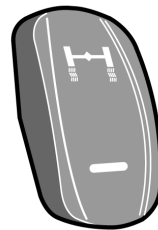

T0012059



CAUTION

Turn off the TCS before towing. Failure to do so may result in damage to the system components.

Differential Lock

Differential lock allows drive axle shafts to be connected together. The wheels then rotate at the same speed, which makes driving on slippery surfaces easier.

The differential lock is only to be used on slippery surfaces. Engage as soon as the bus is on the slippery surface. It can be coupled in during driving, at any speed, but will not actually engage until the bus is travelling at less than 15 km/h (10 mph).

Do not forget to disengage the differential lock when you have left the slippery surface! For more information, see separate driver instructions “EBS”.



CAUTION

The differential lock is only to be used on slippery surfaces. Other uses may result in damage to the drive axle.

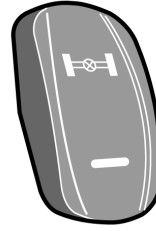

T0012041

3 stage switch for the manual/automatic coupling of the differential lock.

Hill Start Assistance

This function helps the driver to pull away on inclines by holding the bus still until the required torque at the wheels is applied.

This function's mode of operation depends on whether the bus is equipped with a manual or automatic transmission. Additional information, see separate Operating Instruction “EBS”.

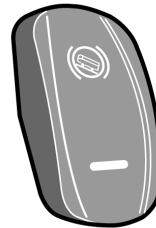

T0012045

Passenger Compartment Lighting

This switch turns on the passenger compartment lighting as follows:
 Press one time— half of the lamps lights up.
 Press two times—all the passenger compartment lighting lights up.
 Press and hold by 3 seconds — to turn off passenger compartment lighting.

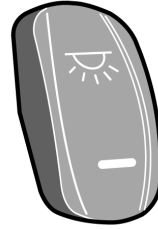

T1008556

Night Lighting

This switch has two positions, on and off. Activation of the night lighting turns on the lamps illuminating the gangway, which are located under the seats. When the night lighting is on, the passenger compartment lighting level is dimmed to 30% regardless of the positions of the other switches.

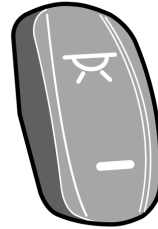

T1008549

Half-light

Switches on small blue lights.
 Press once — to turn on only the blue lights in the passenger compartment.
 Press twice — to turn on the blue lights in the driver's compartment.
 Press three times — to turn on all the blue lights.
 Press and hold for 3 seconds — to turn off all the blue lights.

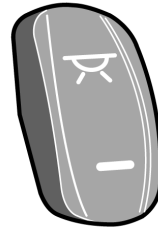

T1008549

Driver Compartment Lighting

This switch has three positions as follows:
 Position I — or bottom position, all lighting is off.
 Position II — or middle position, the lighting is off if the door is close, but the lighting is on if the door is open.
 Position III — or top position, the lighting turns on without any restriction.

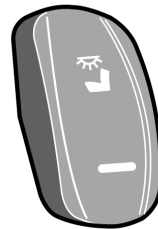

T1008557

Passengers' Individual Lighting

Enabling/disabling of the passengers' individual lighting. Lamps are located in the panels above the passenger seats. See "Passengers' panel" page 52.

Position I - or bottom position all lamps are turned on, which is useful for example when checking whether all bulbs are OK

Position II - or middle position all lamps are turned off.

Position III — or top position every passenger can individually turn on the lighting with the push-button on the panel.

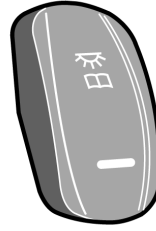

T1008548

Rear Door Lighting

When this button is activated, the entrance lighting of the rear door switches on when it is open.

In some buses there is a double-position control. It operates as follows:

Position I — the light switches on when the door is open.

Position II — the lighting switches on when reverse gear is selected.

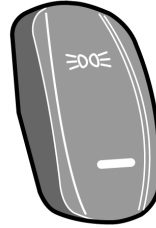

T3019957

Position Lights

This switches allows to make signs with position lights

If the position lights are off, press and hold the switch to turn on the position lights.

If the positions lights are on, press and hold the switch to turn off the position lights.

Press and depress and so on for position lights blinking

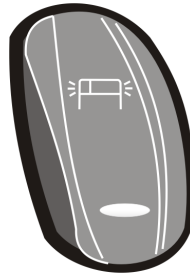

T0015279

Lighting Strip

9700 DOT bus is equipped with a lighting strip mounted along the luggage racks.

These stripes lights 100% on when the main switch is turned on, but when the parking brake is released, the stripes lights 50%.

Destination Sign Lighting

This switch has three positions as follows:
 Position I — or bottom position, destination sign lighting is off.

Position II — or middle position, destination sign lighting turns on when parking lights are on.

Position III — or top position, lighting turns on when the ignition switch is in position II.

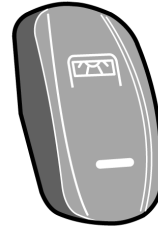

T1008545

Electrically Heated Rear Mirrors

Pressing the button switches on the heating for 8 minutes.

In buses for the Scandinavian market, this button operates as follows: One brief press of the button (less than 1 second) switches on the heating for 8 minutes. Pressing for longer than 1 second switches on the heating permanently until the button is pressed again. Heating can be used to remove water droplets and ice from the mirror glass. Make sure the mirrors are free of mist or ice when driving.

Note: On some buses this switch, besides heating the rear-view mirrors, also switches on heating of the driver's window and front door window.

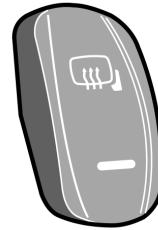

T1008551

Driver's Window Heating

Pressing the button switches on the heating for 8 minutes. Pressing the button again switches off the heating.



T1008580

32 Instruments and Controls

Driver's Blower

Switch for the driver's blower.

It turns on/off two small fans located on the top of the driver's and guide's places. Push the switch to turn on both fans and push again to turn off.

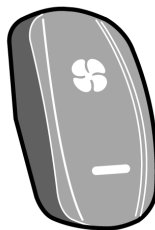

T1008550

Central Locking

This switch locks/unlocks all luggage compartment hatches.

Additionally this switch turns on the luggage compartment lights (Luggage compartment lighting turns off after 10 minutes of luggage hatches stills opened).



T1008543

Sun Blind

This switch facilitates lowering and raising of the front sun blind as follows:

- Lowering — Press at the bottom to low the sun blind, depress to stop the movement.
- Raising — Press at the top to raise the sun blind, depress to stop the movement.



T3018180

Driver's Window

This switch facilitates lowering and raising of the driver's window.

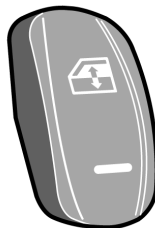

T3018172

Activation of the Toilet

Activates the power for the toilet and disengages the lock.

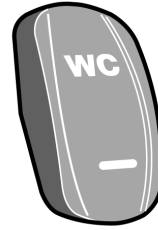

T3018183

Audio System

Once the control is activated, the audio and video system is enable.



T0015523

Opening the Doors from the Outside

Allows for the opening of the doors using the external push-button.

Note: Always press this button on leaving the bus.

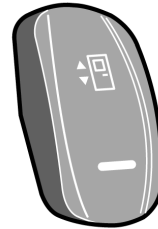

T1008555

Middle Door

Allows for the opening of the middle door for the wheel chair.

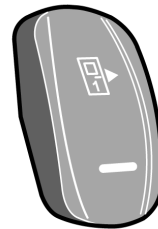

T3018176

34 Instruments and Controls

Emergency Window in use Indicator Lamp

This lamp lights up to indicate that one of the emergency windows has been opened.

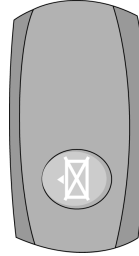

T0015524

Switches in the Electrical Center

The Volvo 9700 bus is equipped with additional push button switches in the electrical distribution box.

Air Conditioning Test.

Using this switch the driver can check if the air condition is working.

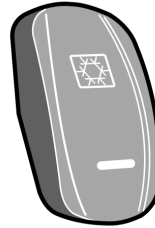

T3018175

Controls

Starting Switch

The ignition switch has four positions:

- 0 Stop position.**
- I Intermediate position.** In this position certain electrical devices can be used according to customer requirements.
- II Drive position.** Between positions II and III there is a spring-return position for preheating.
- III Start position.** Spring-return.

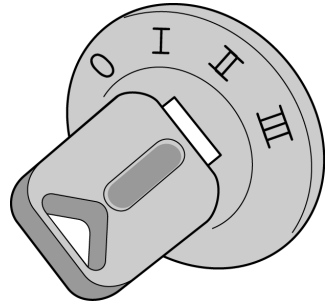

T0014333

Note: Removing the key from the starting switch activates the steering lock.

Note: The key can only be removed from the starting switch when it is in the stop position.

Note: Do not remove the key from the starting switch while driving or when the bus is being towed!

Note: Always remove the key from the starting switch when leaving the bus.

Adjusting External Rear-view Mirrors

Both rear-view mirrors are adjusted using the same switch. The switch can be turned to one of the two positions (adjustment of the right or left mirror). The arrow shows which of the mirrors has been selected. The selected mirror is adjusted by moving the switch in the appropriate direction.

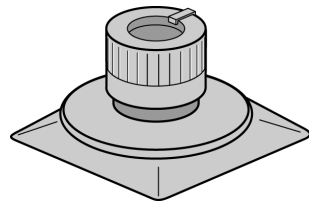

T0014718

Note: Rear-view mirrors should be adjusted before starting to drive.

Door Brake

The door brake can be activated in various ways, depending on its design and customer requirements. The door brake is activated at speeds below 5 km/h (3 mph) if any of the/specified doors are opened. In the event that the door brake is activated, its indicator light comes on the instrument panel.

Note: The door brake does **not** engage if the brake system registers poor traction when the bus is stopping on a slippery surface. This prevents the bus skidding when stopping on a slippery surface.

Door Brake Deactivation

- 1 The accelerator must not be active (fully release the accelerator)
- 2 Doors/The specified door(s) must be completely closed.
- 3 The accelerator must be activated again (depress the accelerator again)

In the event that, due to the bus stopping on a slippery surface, the brake system has not activated the door brake, you must brake again (in a place where no slippery surface is detected) to enable this brake to be reactivated.

General Door Brake Deactivation

Depending on the design, the electrical distribution box may also be equipped with a disabling switch (bypass switch). This switch deactivates the door brake independently of the other functions.

Note: This switch should only be used in the event that the bus cannot be transferred in the normal manner. The door brake should normally be **always** on, i.e. the bus must not be able to move until the doors are closed.

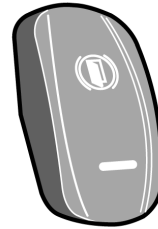

T1008554

Steering Wheel Adjustment

Both the steering wheel height and its tilt allow of continuous adjustment.

Adjust the steering wheel as follows:

- depress the pedal to which the arrow points
- Setting the steering wheel
- after releasing the pedal the steering wheel is locked in its new position.

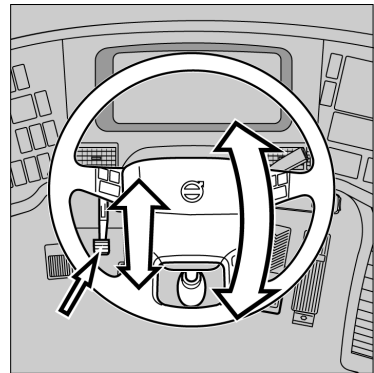

T6010216



DANGER

Steering wheel adjustments should only be performed while the bus is stationary. Adjustments with the vehicle is moving may lead to an accident, resulting in serious personal injury or death.

Direction Indicator, Dipped/full Beam Changer

- Location of point of resistance.**

When making manoeuvres requiring only slight movements of the steering wheel (changing lanes, overtaking), move the stalk up or down and hold it there. After releasing the stalk, it will immediately return to its neutral position.
- Move the stalk beyond the pressure point.**

The direction indicators will continue to flash until the stalk is manually moved back to the neutral position, or the steering wheel is returned to the straight ahead position after the turn.
- Main beam “flash”.**

Pull the stalk towards the steering wheel (until you feel slight resistance). The main beam will stay lit until the stalk is released.

Main/dipped beam switching (lights on).

Pull the stalk towards the steering wheel beyond the “flashing point” and release it. Each time you do this, the headlamps will toggle between main and dipped beam.

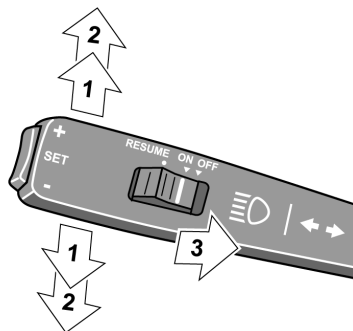

T0012077

In addition, engine idling speed can be controlled with this stalk. See: “Low Idle Adjustment” page 68

Windscreen Wipers, Windscreen/headlight Washer

Note: This stalk also provides control of the display, for additional information about display control, see the separate Operation Instruction “Display”.

1 Interval wiping

Used when driving in mist or drizzle conditions.

The wipers make one sweep every 10 seconds. To reduce the time between sweeps, move the stalk to the normal position, and then, after the desired time interval, back to the interval wiping position. This permits the wiping interval to be set to any value between 1 and 10 seconds.

2 Flick wipe position.

If you want the wiper to make only one or two strokes (e.g. drizzle), move the lever to the flick wipe position and keep it there with your finger. The wipers will stop in parking position after releasing the lever.

3 Windscreen wipers, normal speed.

4 Windscreen wipers, high speed.

5 Windscreen washers + headlight washers.

Moving the stalk to this position will also activate the windscreen wipers, which will make an additional 2-3 sweeps after the stalk has been released.

The headlight washers and windscreen washers have a common fluid reservoir.

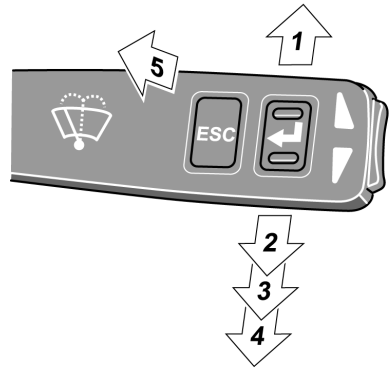

T0012079

Transmission

Transmission, I-shift

The bus may be fitted with an I-shift automatic transmission.

Both clutch operation and gear shifts are performed fully automatically. If necessary the gears can be changed manually.

By pressing the FOLD button and tilting the lever downwards to the position where the lever is on a level with the seat, extra room may be created for the driver.

For more information, see separate driver instructions “I-shift”.

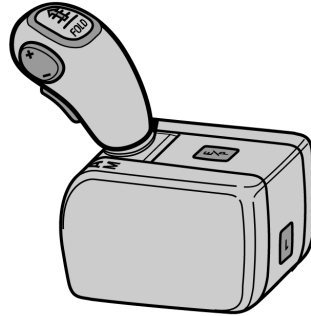

T4021276

Retarder

The transmission has an integrated retarder, which helps to brake the bus reducing the load on the brakes as a result. It is automatically engaged by the initial movement of the foot brake pedal, even before the wheel brakes are engaged.

Note: The retarder brakes only the driving wheels. If the bus is fitted with the Anti-Lock Brake system (ABS), the retarder is automatically disengaged on any signs of the wheels locking. When the retarder is active, its symbol is shown on the display.

The retarder can be disabled by pressing its switch on the dashboard.

Note: Under normal driving conditions, the retarder should not be disabled.

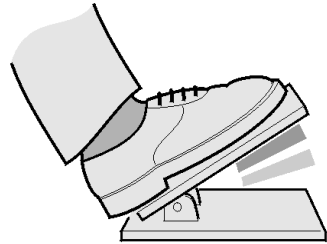

T0009004



T3018117

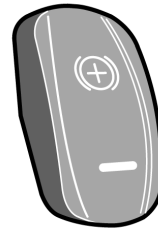

T1008547

 **DANGER**

Avoid using the retarder on slippery roads because of the risk of locking the wheels and skidding (the retarder brakes only the driving wheels). Failure to do so may lead to an accident, resulting in serious personal injury or death.

Retarder Overheating

If the retarder remains engaged for a long time (e.g. during a long downhill stretch) it may overheat, causing an increase in retarder oil temperature.

The first indication of retarder overheating is the white “INFO” lamp lighting and the temperature symbol showing up on the display. If this happens, select a lower gear and make greater use of the main brakes.

If the temperature continues to rise, the red “STOP” lamp will light and there will be an increase in the temperature accompanying the symbol on the display. Stop the bus as soon as possible and select neutral, i.e. N. To increase the circulation of the coolant run the engine at higher idle until the temperature returns to the normal level.

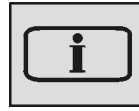

T3014366



T3008844



T3014364



CAUTION

Do not switch off the engine before the temperature is back to normal. Failure to do so may result in component damage.

Transmission Overheating

If the transmission overheats, the white “INFO” lamp will light and the display will show a red symbol.

If the temperature rises further, the red “STOP” lamp will light. Slow down and stop the bus as soon as it is safe to do so. Contact Service for advice.



T3014366



T3014364



T0008817

Brakes

Parking Brake

The parking brake acts on the drive wheels. When the hand control is in the forward position with the compressed air system charged and the blocking valve depressed, the parking brake is released.

When the parking brake hand control is moved backwards, the parking brake is gradually applied. It is fully applied when the hand control is in its backmost, locked position.

To release the parking brake hand control from the locked position, lift the ring upwards and move the lever forwards.

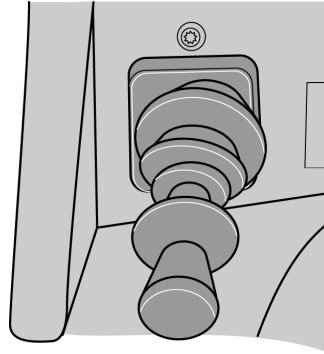

T5014881



DANGER

Never leave the bus without engaging the parking brake. Failure to do so will prevent the bus from staying stationary leading to an accident that may result in seriously personal injury or death.



DANGER

If the warning lamp lights while driving, stop the bus immediately. Failure to do so may result in serious personal injury or death.



DANGER

Never start driving while the brake system warning lamp is still lit. Failure to do so may result in serious personal injury or death.

Emergency Brake

To use the parking brake as an emergency brake, move the lever gradually backwards to the parking position. Keep the catch pulled in all the time, or the control will fasten in the locked position.

Note: The parking brake is only to be used for parking or as an emergency brake in case of malfunction of the foot brake system. The parking brake only brakes the drive wheels, the braking distance will be longer than when using the foot brake. There is also an increased risk of skidding because only the drive wheels are used for braking.

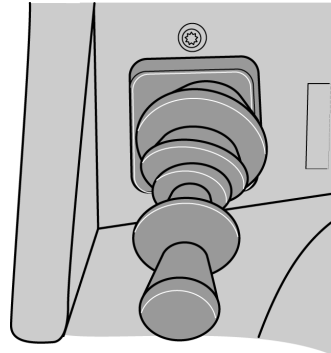

T5014881

Blocking Valve

If the brake system at any point in time is emptied of air, for example by the bus standing parked for a longer time period, the parking brake cannot be released.

To release the parking brake you must first start the engine and wait until the brake system warning light has gone out. Then press the locking valve.

Even if the hand lever for the parking brake has been moved to the forward position, the brake will not be released until the blocking valve has been pressed in.

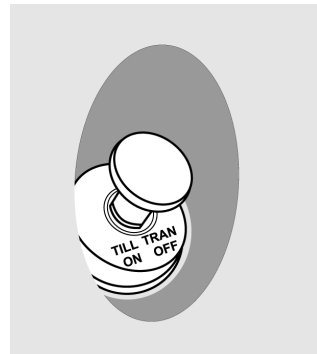

T0015484

Service Brakes

The bus is equipped with an EBS brake system (Electronically-controlled Braking System). This system monitors and controls brake operation. For additional information concerning the EBS system, refer to the separate Operating Instruction “EBS”.

If the main brakes are used without care when driving down steep and long inclines, they will heat up very quickly to extreme temperatures. The low speed that is generally the rule in such cases means that the brakes are not cooled as efficiently as when driving on level roads.

When driving downhill, in the first instance use the retarder brake, and only supplement this with the main brakes as necessary. For additional information about the retarder, see “Retarder” page 70.

If you have to use the footbrake while driving downhill, do not pump the brakes, as this will only use up compressed air. Brake sufficiently hard, and then release the brake pedal completely, or just to the pedal position where only the retarder is engaged. Heat builds up very quickly in the brakes, causing increased wear of the brake linings and reduced brake efficiency.

This system has a reserve pneumatic system. The main purpose of the EBS system is to increase road traffic safety by shortening braking distances.

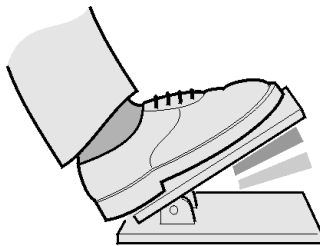

T0009004

Dark zone — only retarder
Light zone — retarder and foot
brake



T0009682



T3008834

EBS controls the ABS and ASR braking forces. It is fitted only on buses with disc brakes. ABS is a part of the EBS system and works completely automatically. The ABS (Anti-lock Brake System) prevents the wheels from locking up during braking. In case of ABS failure, the appropriate symbol appears on the instrument panel.

Note: ABS efficiency is limited. Remember, that on slippery surfaces ABS will not shorten the braking distance significantly. It can nevertheless help in avoiding obstacles during braking.



T0009682



T3008834

Compensating for Differences in the Wear of the Brake Pads

If the brake pads on one of the axles wear down faster than those on the other, braking force is redistributed so that a greater portion of the braking force is applied to the wheels on the axle with less wear.

Note: This function activates when braking lightly. During hard braking the braking force is distributed so as to achieve the most efficient braking.

When the thickness of the brake pads is reduced to 20% of the thickness of new pads, a warning symbol is shown on the display.



 **DANGER**

When brake pad warning symbol is displayed, immediately proceed to the nearest service station to replace the brake pads with new ones. Driving any further with worn out brake pads may lead to losing control of the vehicle and cause an accident resulting in serious personal injury or death.

Brake temperature High Warning

If the temperature of the brakes increases too much, the “CHECK” lamp lights, and the relevant symbol is shown on the display.

Note: If the temperature is allowed to rise further, maintaining the same braking force will require increased pressure on the brake pedal.



T3014365

Destination sign control

The Volvo 9700 bus is equipped with a high definition destination sign.

Use instructions:

- Destination text: Press the select button up to the D letter appears in the display. Insert the destination text code using the buttons of units, tens and hundreds (for example D001)
- Extra text: Press the select button up to the E letter appears into the display. Insert the extra text code using the buttons of units, tens and hundreds (for example E002).
- Departure time: Insert the time into the display in E (Normally E001 is reserved). Press the button up to the S letter appears, adjust the hour with button H and minutes with button M.

Destination sign will be updated 4 seconds after.

For more information see separated instructions “Destination sign”.

A/C Controller

The Volvo 9700 bus is equipped with an AC controller to maintain a constant temperature inside the bus.

For more detailed information, see separate instructions “AC controller”

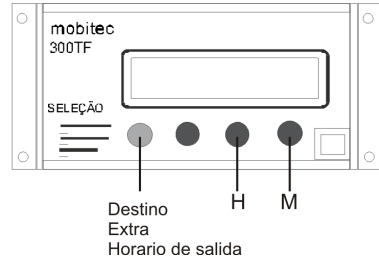

T0015271

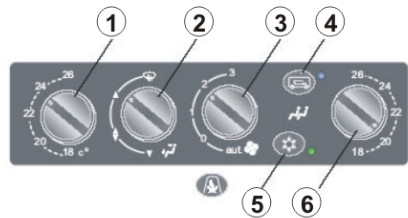

T0015295

Interior Equipment

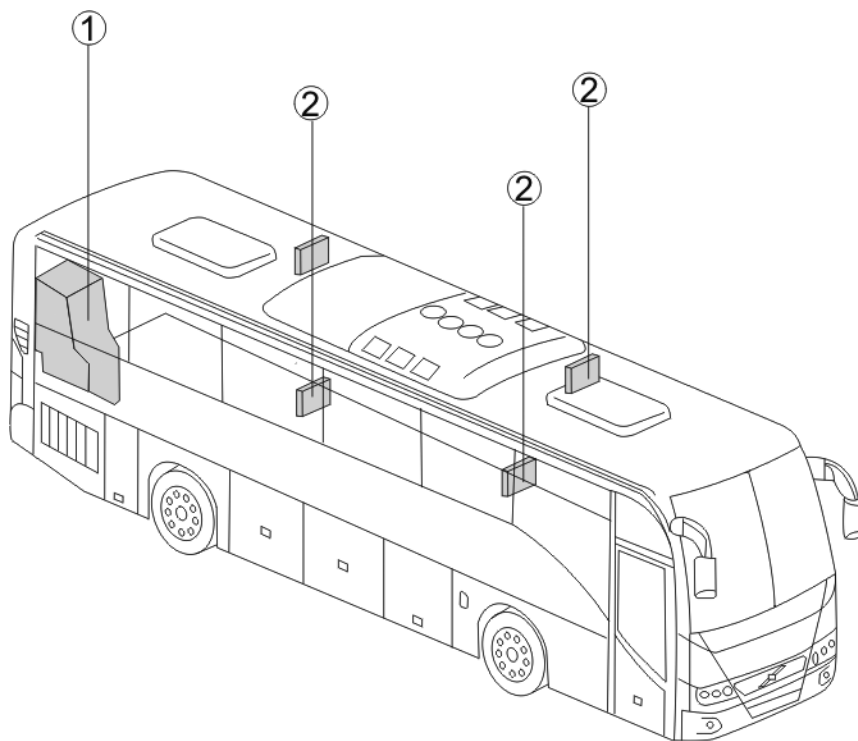

T0015326

To enhance travel comfort, the bus may be fitted with additional interior equipment such as:

- 1 Toilet
- 2 Monitors

Toilet

The bus is equipped with a toilet, located on the right-hand side at the rear of the vehicle. Pressing a switch on the dashboard enables the toilet to be used, by releasing its central lock and switching on the toilet power supply.

While the toilet is occupied (after locking the door) a sign lights up in the passenger compartment.

In the toilet compartment there is an emergency push-button with backlight. After it has been pressed, the toilet indicator lamp flashes on the dashboard.

For additional information and instructions regarding the servicing and maintenance of the toilet, see the separate Operating Instructions “Shades toilet”.

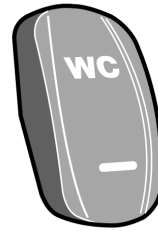

T3018183

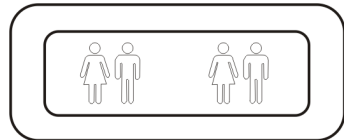

T0015272

52 Interior Equipment

Passengers' panel

Above every pair of passenger seats there is a passenger panel. On each panel there is:

- 1 Reading lights
- 2 Passenger's blowers
- 3 Half light led

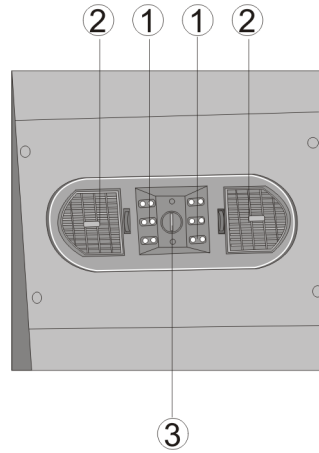

T0015273

Push-button:

- 1 Right reading light (to turn on push the button to the right, pushing again the light turns off)
- 2 Left reading lights (to turn on push button to the left, pushing again the light turns off)

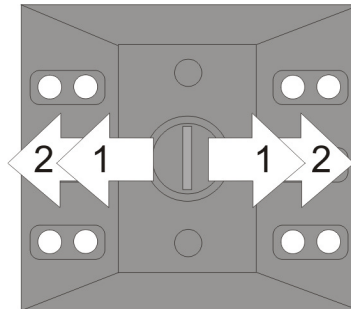

T0015296

Audiovisual System

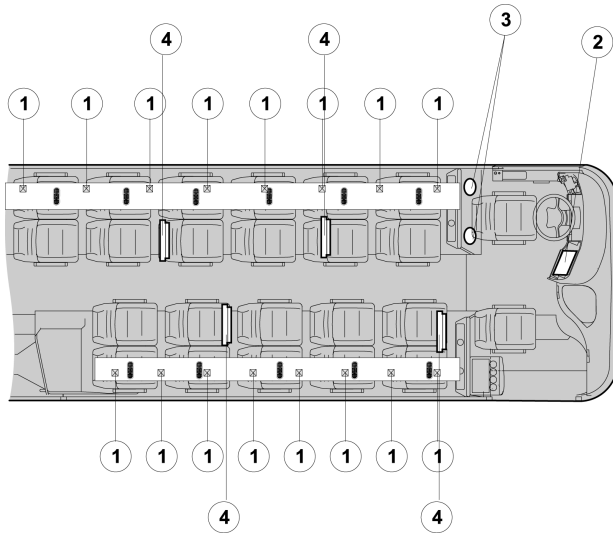

T0015327

To enhance the comfort of the passengers during journeys, the Volvo 9700 bus is equipped with an audiovisual system, whose main components are:

- 1 Loudspeakers in the luggage racks
- 2 CD, DVD player
- 3 Driver's loudspeakers
- 4 LCD monitors

Audiovisual Controller

The Volvo 9700 could be equipped with main unit, giving the driver complete control of the system. See separate Operating Instruction: “Blaupunkt Sound & Vision”.

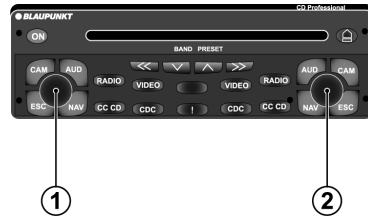

T0015281

Video System

There are four LCD monitors in the bus. They are activated by selecting the VIDEO signal on the audiovisual controller. See separate Operating Instruction. “Blaupunkt Sound & Vision”.

Audio System

The main elements of the audio system are:

- radio with the tape or CD player
- CD changer
- loudspeakers

Overview

As the driver you must always be familiar with the location of the emergency equipment in the bus, and how to use it.

It is essential that all emergency equipment is checked on a regular basis to make sure that it is in working condition and in place. The location of the safety equipment and its scope can vary, depending on the regulations in the country in question. Therefore make sure that you know where the equipment is and check that nothing is missing.

Fire Extinguisher

The fire extinguisher is located in the front of the bus (most often mounted under dashboard on the right-hand side).

The fire extinguisher can be used to put out fires in volatile fluids, wood, fabric, paper and electrical equipment. Check regularly that the pressure gauge indicator is in the green zone.

How to use the fire extinguisher:

- 1 Remove the fire extinguisher from its holder.
- 2 Hold the extinguisher by its handle with one hand, and pull the safety pin with the other.
- 3 Point the rubber hose at the heart of the fire and press the trigger.

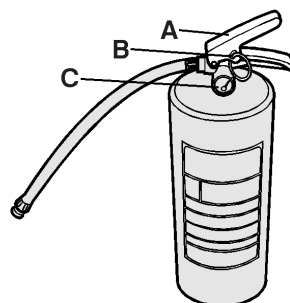

T0008196

- A Trigger
- B Safety pin
- C Pressure gauge

Warning Triangle

The warning triangle is located either in the toolbox, or in a holder to the right of the driver.

The warning triangle is used whenever a fault forces the bus to stop in a hazardous location. Switch on the hazard warning lights and place the warning triangle at a distance stipulated by the traffic regulations of the country in question.

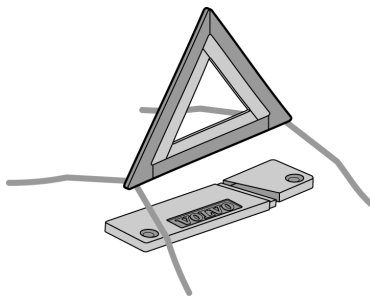

T8011683

First-aid Cushion

The first aid kit contains basic first aid materials.

For location of the first aid kit: see the markings inside the bus.

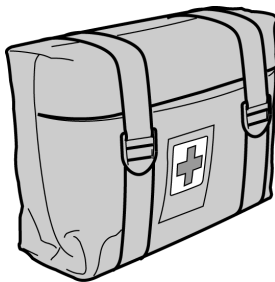

T1008716

Tire Inflation Valve

Tyre inflation valve may be used to:

- inflate a tire using the bus pneumatic system
- release the parking brake with air from a tire

Its main use is to release the parking brake in a situation when the bus cannot supply its own air, e.g. engine breakdown.

The bus toolbox contains a hose that connects between the tire and the tire inflation valve.

The tire inflation valve is located next to the driver's seat or inside the first service hatch.

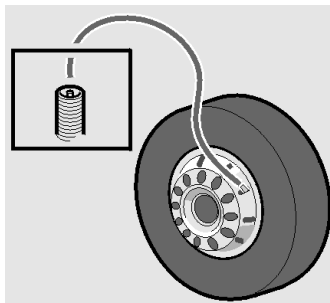

T0009182

External Air Supply Connection

Behind the first service hatch or in the driver's panel beneath the window there is a valve to which an external air supply can be connected. This is used when parking the bus overnight, to prevent emptying of the air system.

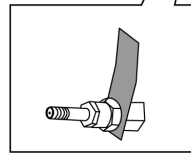
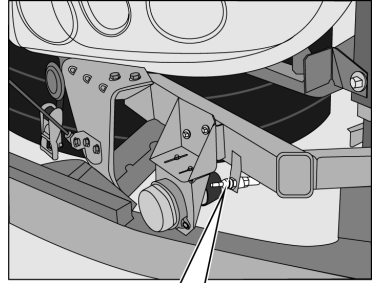

T0015390

Jack

The bus is fitted with special jacking points to comply with safety regulations. For detailed information concerning the use of the jack and changing wheels, see the separate Operating Instruction "Jacking points and puncture"

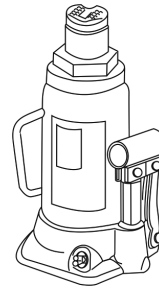

T0015345



Always ensure that the bus is standing on a level surface and chock the wheels so it cannot move. Failure to do so may result in serious personal injury or death.

Note: The jack supplied with the bus should only be used to lift the bus to change a wheel.

58 Emergency and Safety Equipment

Toolbox

The toolbox and tools can be purchased from your local dealer. A complete toolbox contains:

Toolbox	
Jack (2 units)	3124497
Adaptor for the jack	3178753
Wheel wrench	9521826
Towing kit	205465449
Hammer	962207
Pumping hose	942868
Warning triangle	3176488
Key for the hatches	70319047
Female key	70344906
Male key	70344905
Pliers	962042
Adjustable spanner	755
Screwdriver with bits	978201
Spare wheel wrench	1062412
Winch handle	1590997
Extension for pumping valve	1621456
Socket wrench 19/24 mm	8189085
Jack extension	1586079
Jack extension	1577686
Wheel wrench extension	20592217
Tool bag	1577384
Wheel chocks (2 off)	8158698

Engine Control Box in Engine Bay

The engine control box is located behind the engine hatch in the back of the bus. It is used only in conjunction with servicing.



WARNING

When working in the engine bay, the switch (1) must be in position **0**.

The control box has three controls:

- 1 Start enable switch**
When the switch is turned to position **1**, the engine can be started from either the start button on the control box, or the key ignition on the dashboard.
When the switch is turned to position **0**, the engine cannot be started from the engine bay, nor from the dashboard.
- 2 Start button**
When switch (1) is turned to position **1**, pressing this button starts the engine.
To allow the engine to be started from the control box in the engine bay, the transmission must be in neutral position (N), and the ignition key in the "DRIVE" position.
- 3 Emergency stop button**
To stop the engine press the red button.

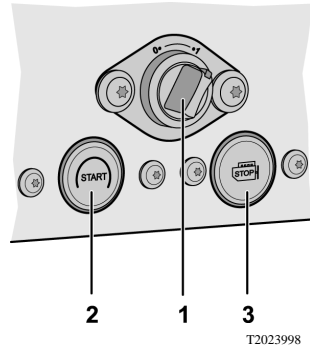

Emergency Exits

Doors

There is a valve for emergency door opening above the door. Turning the knob cuts off the compressed air supply to the door.

After turning the valve knob and hence cutting off the compressed air supply to the door, a warning lamp lights up and a buzzer sounds. To return the compressed air system to its normal state, turn the knob back to its initial position and press the appropriate door button on the dashboard.

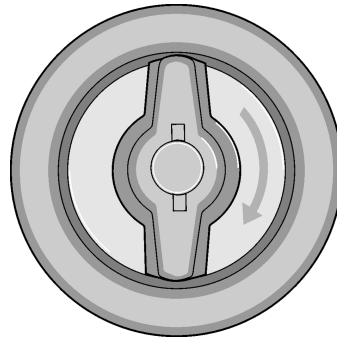

T8009617

Windows

There are windows to be used as exit in case of emergency. These windows can be opened easily with a mechanism. These windows have stickers with the text “Emergency exit”.

Note: To exit the bus:

- 1.- Pull the red bar located at the bottom of the each emergency window
- 2.- Push and hold the window with both hands
- 3.- Leave carefully

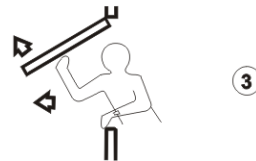
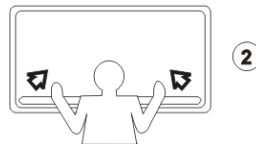

T0015286

Ceiling, Roof Hatches

To open the roof hatch in case of emergency, pull the hatch release handle and push the hatch upwards.

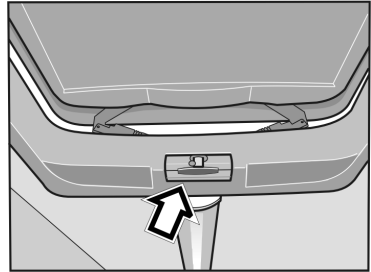

T8010110

Checking Before Driving

Before starting the bus and driving off, check the sensitive edges on the doors. If the door leaf during opening encounters an obstacle, the door should stop. If the door leaf encounters an obstacle during closing, the door should open again. It should not be possible to open the doors by hand while the engine is running.

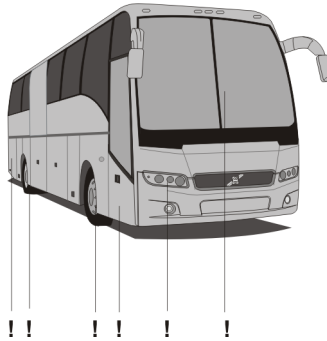

T0015270



WARNING

Make sure that the sensitive edges on the door work prior to vehicle use. Failure to do so may lead to personal injury of passengers.

Make sure that:

- all hatches are closed
- all the lighting is working properly
- the windscreen wipers/washers are working properly
- safety equipment is in place
- the direction indicators and horn are working properly
- the air pressure in the tires is in order (using a hammer) and nothing has got stuck between the back twin wheels.
- destination information and line number are correct
- the emergency opening system for the doors is working properly.

Checking Warning Lights

When the key is in position **I**, the control system checks that all the warning lamps are working properly.

All the warning lamps and the warning LEDs in the meters are lit for about 5 seconds.

ABS/The ABS system indicator lamp will light up for slightly longer than the others.

If it continues to be lit then a fault has been detected in the ABS system./EBS system discovered

Daily Inspection

Engine oil level, as well as the servo fluid and coolant levels in the bus should be checked on a daily basis. The checks are carried out with the engine **warm**, but switched off.

Note: It is a good idea to do these checks after a tour as the engine is then at normal operating temperature.

All tanks are located in the back of the bus.

Engine

When checking the oil level:

- position the bus on level ground.
- if the engine is cold, let it idle for 1-2 minutes
- turn the engine off. Wait at least 2 minutes before carrying out the check
- remove the dipstick and wipe it with a clean cloth
- check the oil level with the dipstick. The oil level should be between MAX and MIN
- top up if necessary.

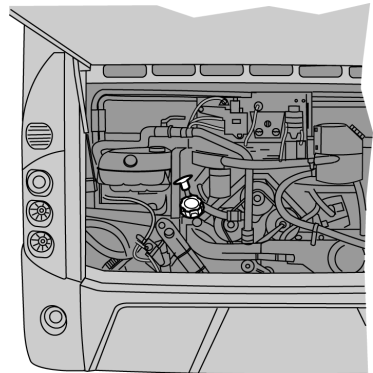

T2024562

64 Starting and Driving

Steering Servo/hydraulic Fan

Check that the oil level is between the MAX and MIN markings on the reservoir (B). Top up if necessary.

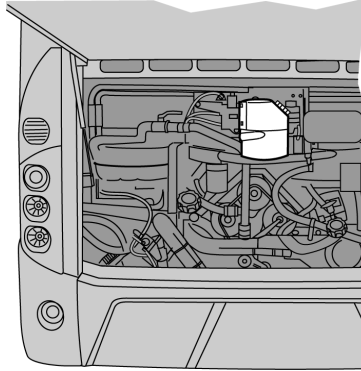

T0015486

Coolant

Check that the coolant level is between the MAX and MIN markings on the reservoir (A). Top up if necessary.
The reservoir is located over the radiator hatch on the rear left side of the bus.

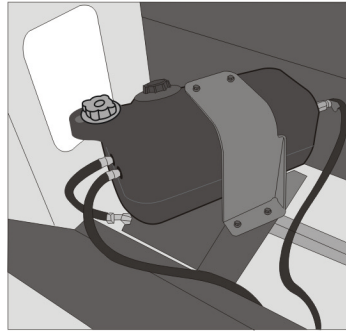

T0015269

Washer Fluid

Check the level of the washer fluid in the reservoir. Top up if necessary.

Note: In winter use appropriate fluid with lower freezing temperature.

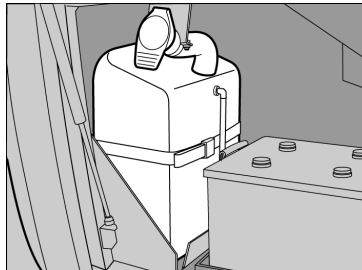

T2024567

Refuelling

Open the flap and the fuel filler cover. Insert the end of the fuel hose into the filler neck. Fill up the tank. After filling up the tank, remove the fuel pipe and put it back on the pump. Close the fuel filler cover and the flap. Volvo 9700 buses have two tanks with 400 liter (105 gallons) capacity each one. To open the filler cap press it hard with the whole palm until its catch releases.

Note: Use only fuel that meets the manufacturer's specifications. Avoid spilling fuel on to painted surfaces. Refuel only at designated places.

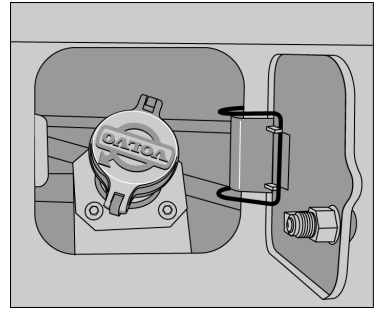

T2022265

Engine Block Heater

An electric engine block heater can be installed for keeping the coolant hot when the vehicle is parked. The heater is mounted through the side of the engine block with the heater coils in the coolant jacket. The heater does not interfere with normal operation and can be permanently installed.

The heater runs on 120V and has an easily accessible plug, located on the right side of the engine compartment. The plug will hook up to a normal extension cable.

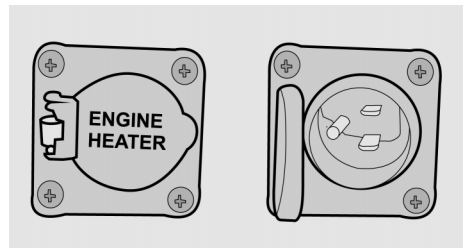

T0015492

Starting the Engine

Starting

When starting the engine, the parking brake must be engaged and the gear selector must be in neutral, i.e. **N**.

Starting a Cold Engine

When starting the engine at temperatures of around 10°C (50°F) and below, the air entering the engine should be heated. To prevent wear and possible damage to the engine when it is cold, gradually bring it up to operating temperature before operating at high engine speeds or full load. After starting and before moving the vehicle run the engine at 800 to 1000 rpm for 3 to 5 minutes. Operate at partial engine load until the coolant temperature reaches 75°C (167°F).



T0014333

Proceed as follows:

Turn the ignition key to the position between **II** and **III**. This starts the preheating, which can take up to about 50 seconds, depending on the temperature of the coolant. The indicator lamp is lit during preheating. Once the lamp has extinguished and the needle of the temperature gauge has moved off its lower stop, the engine can be started.

Do not race the engine when it is cold. This could damage the engine.



CAUTION

Do not let a cold engine run faster than 1000 rpm in very low temperatures (< -20°C (-4°F)). Failure to do so may cause internal engine damage.

Starting a Hot Engine

Start directly by turning the key to the start position.

Stopping the Engine

To shut down the engine, turn the key to the STOP position. In an emergency situation the engine can be shut down by using the emergency stop, see “Emergency Stop” page 24.

Note: Before turning off engine. If the engine has run at high temperature for a significant time before it is shut down, let the engine run at idle for 3 minutes to cool the engine off to avoid heat soak.

Checks After the Engine Has Been Started.

The coolant level warning lamp will stay lit for a few seconds after the engine has started. The parking brake warning lamp is lit when the parking brake is engaged. After releasing the parking brake, the lamp should remain lit until the pressure increases to about 540 kPa (78 psi). The footbrake warning lamp and the “STOP” lamp should remain lit until the pressure in the compressed air tanks reach a sufficiently high level.



Do not drive the vehicle until the warning lamps have gone out, as the brake system needs the correct air pressure to work properly. Failure to do so may lead to an accident, resulting in serious personal injury or death.

Idling (programming)

The engine idling speed is 575–625 rpm. Keeping the idling speed constant is the task of the electronic control system, which makes manual adjustment unnecessary. When the bus is stationary, the idling speed can be temporarily raised to 1200 rpm.

Low Idle Adjustment

Before you start to adjust the idling speed, the engine must be warmed up to operating temperature. The bus must be stationary with the engine idling.

- switch (B) must be in the ON position
- the idling speed is increased by pressing the “+” side of the SET button (A). Each press on this button gives an increase of 10 rpm.
- if the idling speed becomes too high, it can be reduced by pressing the “-” side of the SET button. Each press gives a decrease of 10 rpm.

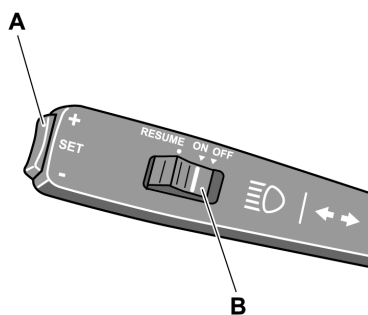

T0012078

Note: The change in idling speed is only temporary. After pressing a pedal, engaging a gear or releasing the parking brake, the idling speed will return to its manufacturer settings.

If new programming of idling rpm is required, keep your foot on the brake pedal and turn off the engine when the new engine rpm has been set.

Note: If the engine does not “run smoothly” at the default programmed by the manufacturer, please visit a Volvo workshop.

Cruise Control

Cruise control is activated by moving the switch (B) to the ON position.

When the bus reached the desired speed, press the “+” or “-” side of the SET button (A). The set speed is increased or decreased by pressing the “+” or “-” side of the switch respectively.

If the speed is temporarily increased, e.g. for overtaking, the vehicle will return to the set speed when the accelerator is released.

Cruise control is deactivated if:

- the brake pedal is depressed
- the retarder stalk is moved to another position
- the switch (B) is moved to its OFF position

After cruise control has been switched off, the most recent set speed can be restored by moving the switch (B) to RESUME. This however does not apply if cruise control has been deactivated by moving switch (B) to its OFF position.

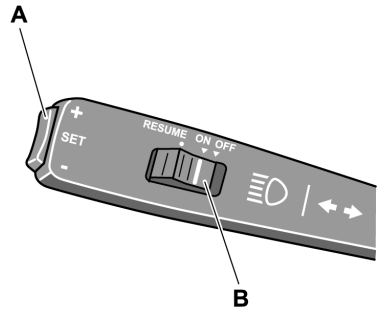

T0012078

Retarder

The function of the retarder is to supplement the main brake, and it acts as an additional brake. This function may be based on an engine brake, or a transmission brake together with the VEB (Volvo Engine Brake), which is an exhaust brake combined with a compression brake.

When the retarder stalk is in its (A) position, depressing the brake pedal will engage both the footbrake and the auxiliary brake. This mode is called “brake blending”, and means that the brake system decides how great a contribution to the total braking force will come from the auxiliary brake, and how much from the footbrake. It allows for optimal use of the auxiliary brake.

In other situations (1-3) the bus is braked by the additional brake as soon as the accelerator pedal is released. The braking force is increased by moving the lever down and decreased by moving the lever up.

Note: The retard function works together with the EBS system. See the separate driver instructions for “EBS”.

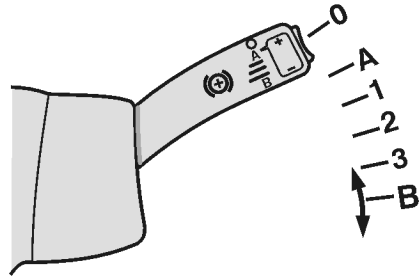

T0010263

The (B) position of the stalk is only present in buses fitted with I-shift. For additional information, see the separate Operating Instruction “I-shift”.



DANGER

Avoid using the retarder on slippery roads because of the risk of locking the wheels and skidding (the retarder brakes only the driving wheels). Failure to do so may lead to an accident, resulting in serious personal injury or death.

Speed Limiting

When the bus is driven downhill with the stalk in position (A), the retarder acts as a speed limiter. When the bus has reached the desired speed, lightly press the "+" or "-" side of the SET button (A). The retarder will maintain the speed of the bus at the setting it had when the SET button was pressed.

The set speed can be increased or decreased by pressing the plus (+) or minus (-) side of the SET button. Each pressing of the switch increases or decreases the speed by 1 km/h. If the switch is held in, the speed is adjusted by 1 km/h for each second it is held in.

Note: Buses that have a retard switch instead of a retard lever do not have this function.

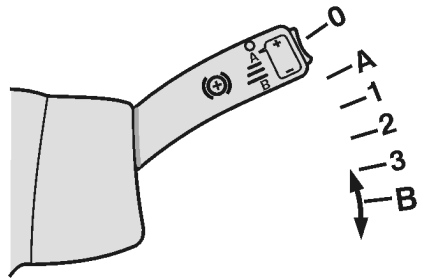

T0010263

Use the SET button on the retard switch to control the speed limitation.

Combined Cruise Control and Speed Limitation

If the bus is equipped with cruise control (see "Cruise Control" page 69), the cruise control system will work together with the retarder. The stalk of the retarder should be in position (A).



T3008844

With cruise control active. While driving downhill with the cruise control active, the retarder will be engaged if the road speed exceeds the set speed by 5 km/h (3 mph). This overspeed value can be modified by means of the +/- button to any value in the range 3–15 km/h (2– 9 mph).

Note: The retarder is automatically deactivated if there is a risk for wheel locking.

Note: If the symbol for high retarder temperature is displayed, a lower gear range must be selected to cool it down. See separate Operating Instruction "Display".

Power Steering

If the wheel is blocked on one side, against a kerb for example, drive carefully forward and turn the steering wheel to allow the bus to move away from the kerb. Never try to force the wheels to turn.

Do not attempt to turn the bus by using excessive force on the steering wheel. Using excessive force on the steering wheel increases pressure in the power steering system, causing risk of overheating that may damage the oil pump.

If the power steering is malfunctioning it may feel as if the steering gear was blocked, this is however not the case, but steering the bus requires the use of much greater force.

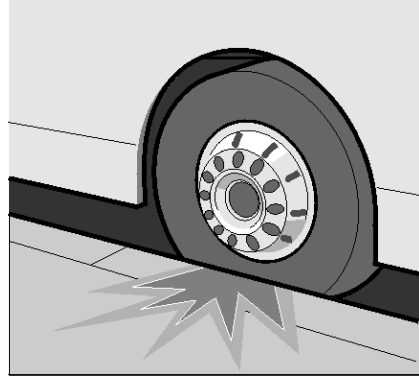

T0008960

Exhaust Aftertreatment System

Volvo 9700 has an exhaust aftertreatment system which includes a Diesel Particulate Filter (DPF). The DPF reduces soot and particulate emissions into the atmosphere. The DPF takes the place of the standard muffler. Soot and other particulate matter are collected by a filter where it is eventually oxidized using a regeneration process. Vehicles equipped with a DPF require the use of EO-O Premium Plus (or VDS-4) specification high performance diesel engine oil and Ultra Low Sulfur Diesel (ULSD) fuel. If the icon “DPF Regeneration Required” lights on, means that the diesel particulate filter is becoming full and regeneration is needed; the icon flashes when the filter is full, maintain uninterrupted highway speed for an automatic regeneration or move the vehicle to a safe location and initiated a parked regeneration. The icon “High Exhaust System Temperature” lights on when a parked regeneration is initiated. It also indicates high exhaust gas temperature during an speed regeneration. When the high exhaust system temperature icon is light on, do not park or operate the vehicle near people, or any flammable materials, vapors, or structures. For more information about Exhaust Aftertreatment System, see separated instruction “Exhaust Aftertreatment System”.

Note: It is important to enable regeneration as soon as possible to avoid engine problems. Long—term engine operation with regeneration disabled will result in a loss of engine performance including horsepower, torque and speed derates.

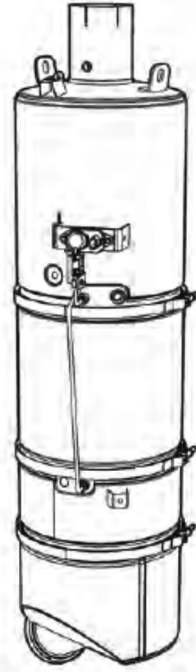

T0015360

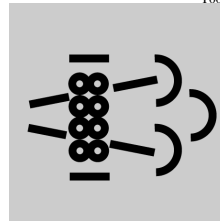

T0015482

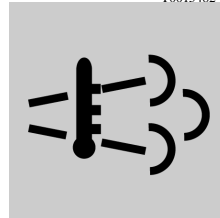

T0015483

Safe Driving

- 1 After starting, and regularly while driving, check that the instruments are giving their normal readings. If any warning lamp lights while driving, stop the bus and investigate the cause.
- 2 Never race a cold engine! Avoid idling for long periods.
- 3 Never cover the radiator! The thermostat keeps the temperature constant regardless of ambient conditions. Check the coolant level regularly and use always the correct type of coolant. Check also hoses/pipes and tensioning of the belts. Do not drive with a leaking cooling or heating system.
- 4 Never drive off before the brake system warning lamps have extinguished. Do not forget the parking brake. The ABS/EBS indicator lamps may light, but this only indicates that the ABS/EBS system is malfunctioning.
- 5 If one of the front wheels is blocked sideways, never try to force it to turn by applying excessive force to the steering wheel.
- 6 While driving downhill and for gradual braking use the retarder function. When driving in slippery conditions take special care, or disable the retarder function altogether.
- 7 When driving on slippery surfaces, e.g. in snow or heavy rain, reduce speed and avoid rapid steering wheel movements. Brake and accelerate gently, to make the journey as safe as possible for the passengers. Driving in slippery conditions requires extra caution when there are strong side winds. Side winds can produce a lifting force acting on the front axle.

Economy Driving

As the driver, you are the most important link in the chain for getting the best overall driving economy.

- 1 **Warm up the engine as quickly as possible.** A warm engine and transmission uses less fuel than a cold one (and there is less wear).
- 2 **Treat the accelerator pedal gently.** Do not “pump” the accelerator pedal. Pumping increases fuel consumption without increasing the speed. A turbo pressure gauge helps you drive economically.
- 3 **High speeds increase fuel consumption** since, among other things, air resistance increases sharply with increase of speed. Strong side and head winds increase fuel consumption even more.
- 4 **Timely and correct servicing will keep the bus in good condition. This will also contribute to preserving low fuel consumption.**

Driving in Cold Weather

Before driving in cold weather conditions (ambient temperature $+40^{\circ}\text{F}$ [5°C] or below), pay attention to the following points:

- 1 The cooling system must be protected against freezing.
- 2 The washer fluid tank must be filled with winter liquid.
- 3 Batteries must be in good condition. In low temperatures, the capacity of batteries to deliver current, e.g. when starting the engine, drops. Make sure that the poles of the batteries are thoroughly clean, with the cable terminals properly tightened and covered with grease, and that there is the correct amount of electrolyte in every cell.
- 4 Engine oil, as well as transmission and rear axle oil, must have the correct viscosity.

Fill up the tanks with winter fuel. This reduces the risk of wax settling in the fuel system. If this has already happened, change the fuel filters and fill up the tanks with winter fuel. Keep the tanks as full as possible.

The compressed air system is particularly sensitive to low temperatures. Excessive condensation in the primary tank indicates that the air drier is not working properly. Drain the tank and change the desiccator cartridge in the air drier. If none of these measures help, use an external heating source to thaw out the system.

Safety



CAUTION

Always make passenger safety your first priority !

If something unexpected happens you should always proceed as follows:

- 1 Stop the bus in a place which is safe for the passengers, and where the bus itself does not constitute an obstacle for other road users.
- 2 Open the doors. If necessary use the emergency valve which is placed in the vicinity of the door.
- 3 Let the passengers out.
- 4 Set the ignition key in position 0.
- 5 Turn off the power with the main switch, see “Main Switch” page 24.
- 6 If necessary, use the emergency stop, see “Emergency Stop” page 24.
- 7 If necessary, switch on the warning lights, see “Hazard Warning Lights” page 23.
- 8 Place a warning triangle behind the bus. Remember that the distance between the warning triangle and the vehicle depends on local regulations.
- 9 Call the service centre and describe the problem.

If the Engine is Not Working

If the engine refuses to start, check that:

- 1 The cover of the emergency switch is folded down.
- 2 The main power switch on the dashboard is set to on.
- 3 The gear selector is in the neutral position, i.e. N.
- 4 The parking brake is engaged.
- 5 The switch in the control box in the engine bay is turned towards **1**.

The engine cannot be started when the battery voltage is too low (below 18 V).

The engine cannot be started if either the engine hatch or the front service hatch is open. In that case the display will show an appropriate symbol. Close the hatch before trying to start the engine.



T3018116

Punctures

There are several safety requirements that need to be considered in the event of a punctured tire. For detailed information concerning wheel changing, see the separate Operating Instruction “Jacking points and puncture”.

Punctured Air Bellows

In the event of puncture of any of the suspension air bellows, the speed **must** be reduced to **20 km/h (12 mph)** and the bus taken to the nearest service facility.

Towing



CAUTION

Failure to disconnect the driveshaft, remove the drive axle shaft(s) or lift the drive wheels off the ground before towing or pushing the vehicle, can cause serious transmission damage.

Note: TCS should be turned off if one of the axles is raised during towing.

For all long distance towing, assure that the tow vehicle has the necessary equipment to reach the front axle, per Bus specifications. Refer to “Technical Specification” page 96 for more information. It may be necessary for the tow vehicle to attach an air supply to the bus during towing. Two positions for attaching are available, one in the front and another in the rear of the bus. See the accompanying illustrations for the general locations.

Towing or moving the bus for short distances can also be performed using a towing rod or bar. Refer to the accompanying illustration for attaching point location.

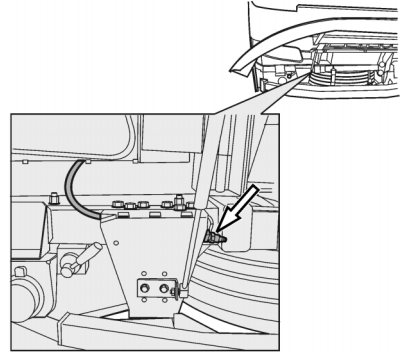

W1000252

Front Air Supply Connection Location

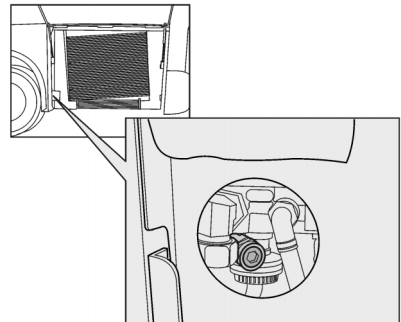

W1000251

Rear Air Supply Connection Location

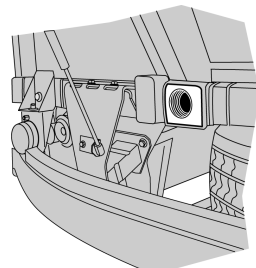

T8012390

Place for towing bar attachment (front)

80 If Something Happens

After mechanically releasing the parking brake, the bus cannot be braked either with the main brake or with the parking brake. Block the wheels or connect to the tow vehicle, so that the bus cannot start moving after the parking brake has been released.

Towing requires either the drive shaft or both drive shafts to be removed, because otherwise the transmission may be damaged due to insufficient lubrication.

If the bus has stopped in a unsuitable place and needs to be moved, it can be towed up to 200 meters (656 ft.) before removal of the drive shaft/drive shafts.

For, punctures, the tire must be repaired before towing begins.

Fire

In the event of fire, the STOP lamp lights up in the engine bay, an audible signal is emitted and a symbol appears on the display.



T0012298



DANGER

Shut down the engine immediately!
Failure to do so may keep the radiator fan running which impels air into the engine bay and fans the fire. This may result in serious personal injury or death.

Releasing the Parking Brake

Release the Parking Brake with Air from the Bus Tires.

- 1 To prevent the bus from moving, block its wheels or attach it to a tow vehicle.
- 2 Connect the clamp head of the tire inflation hose to the valve of one of the tires.
- 3 Move the parking brake control to the drive position.
- 4 While pressing the other end of the tire inflation hose against the pump nipple, press in the blocking valve. Now the brake system is filled with the air from the tire. Filling can be interrupted as soon as the air flow stops.

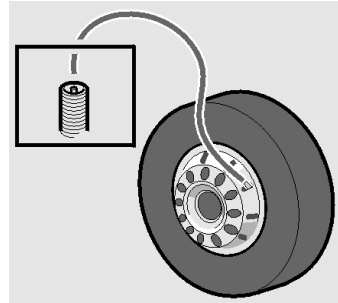

T0009182

Note: Chock the wheels to prevent the bus from moving when releasing the parking brake.

Mechanical Releasing of the Parking Brake

- 1 By blocking the wheels, make sure that the bus will not start rolling after releasing the parking brake.
- 2 On both drive shaft brake cylinders there are release bolts. Screw them out until a red plastic button appears out from the center of the bolt. The brakes are then released. This requires around 45 rotations. Use the designated spanner from the toolkit or the sleeve and locking handle.
- 3 The bus can now be towed. Towing should be performed using a properly equipped tow vehicle that can reach the front axle, since the bus is now completely without brakes.

Note: Do not forget to reset the bolts to their original position and attach the plastic cover after towing has been completed.

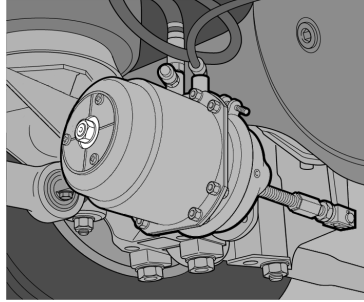

T5014634

DANGER

Chock the wheels to prevent the bus from moving when releasing the parking brake. Failure to do so may result in serious personal injury or death.

Regarding Disc Brakes

The brake cylinder is fitted with a release screw, which does not protrude from the cylinder during manual release. When starting to release the parking brake, a red peg emerges from the centre of the nut. It is fully out after three turns. Full compression of the parking brake spring requires approximately 45 turns. Whenever possible try always to fill the parking brake cylinders with air. It makes it easier to turn the nuts of the release mechanisms.

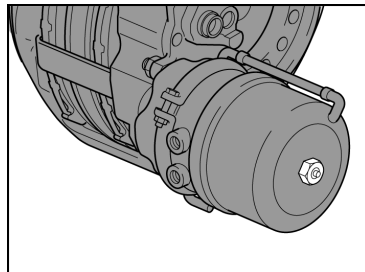

T5014635

Changing the Batteries

When changing batteries, both batteries should have the same capacity and be of the same age. When connecting batteries correct polarity must be observed.

To change a battery:

- turn off the power with the main switch
- disconnect the cable terminal from the negative pole of the battery
- disconnect the cable terminal from the positive pole of the battery
- change the battery
- clean the cable terminals and both poles of the battery
- connect the positive cable terminal to the battery pole
- connect the negative cable terminal to the battery pole
- apply an anti-corrosive agent to the poles with terminals

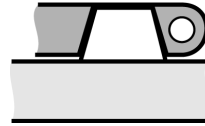
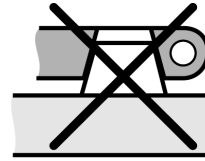

T3019198

Top: Mounted incorrectly, terminal not bottoming on the pole.

Bottom: Mounted correctly, terminal bottoming on the pole.



WARNING

Incorrect connection will seriously damage the electrical system.

If a cable clamp has been incorrectly installed, the battery terminal must be reamed to give a sufficiently large mating surface when correctly installed. Incorrect installation entails a high risk of oxidation in the space between the top of the battery terminal and the battery cable clamp.

Rapid Charging

The bus is equipped with a socket for an external power supply, located next to the battery box. Before rapid charging, the main switch should be turned off to protect the bus power consumers from power surges.

Note: The rapid charge connector is not dimensioned for starting assistance.

Note: Only use the rapid charging socket when the batteries are partially discharged. If the batteries are completely discharged, disconnect them from the bus system and connect directly to a battery charging device.

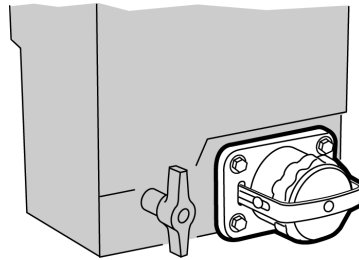

T0014730

Starting Assistance

In the event that the batteries are unable to start the engine, auxiliary batteries can be used to help in starting. These batteries are connected in parallel with the ordinary bus batteries.

Note: Note the polarity. Plus to plus and minus to minus.



CAUTION

Battery chargers with a start boost feature must not be used for starting assistance. Failure to do so may cause damage to the electrical system.

Battery Cut-off Switch

The battery cut-off switch is located next to the batteries and is there to completely cut off the bus power supply. To prevent battery discharge when the bus is standing for 24 hours or more, turn the battery cut-off switch to the OFF position.

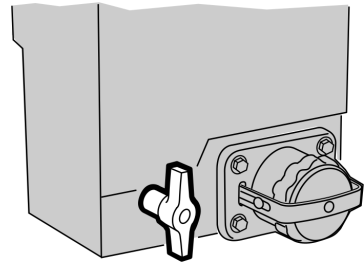

T0014428



CAUTION

Always switch off the power with the cut-off switch when charging the batteries and when connecting an auxiliary batteries to start the engine.



CAUTION

Before using the battery cut-off switch, the power must always be switched off using the main switch on the dashboard. Failure to do so may cause damage to the electrical system.

Note: After using the battery cut-off switch, it may be necessary to re-enter the radio code.

Bulb Replacement

Headlamps

- lift the front bumper
- Loosen the securing screws (A) and (B), delicately lower the lamp module and tilt it open
- disconnect power supply cables
- remove the bulb

Note: Replace it with a new 24 V bulb of the same type and power rating.

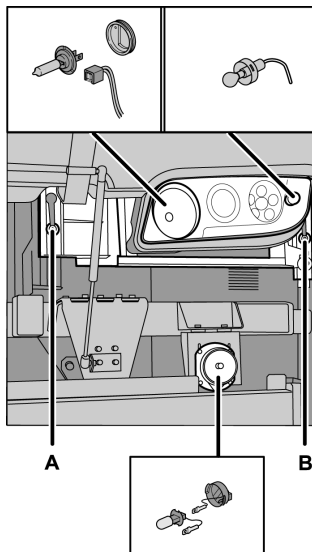

T8012393

Rear Lights

- Unscrew the five screws securing the cover
- replace the bulb
- before fitting the lamp check whether it is working properly

Note: Make sure that the bulb is replaced with a new 24 V bulb of the same type and power rating.

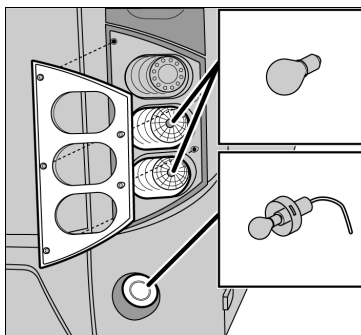

T3019941

Xenon Lights



Xenon lights should only be serviced at an authorized service facility. Never try to repair the lights on your own. Ignition voltage in xenon bulbs is **28,000 V**. Servicing these lights without the necessary knowledge and service information may result in serious personal injury or death.

Licence Plate Lighting

Replace the licence plate light bulbs as follows:

- Unscrew the screws securing the lamp housing
- replace the bulb

Fuses and Relays (chassis)

The fuse and relay box is located at the front of the bus.

Relays

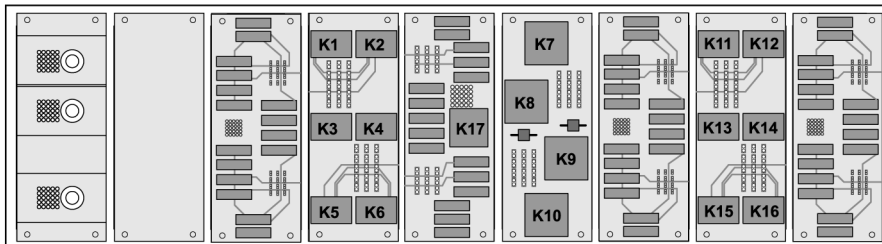

T0012034

Relays			
K1	VECU (Vehicle Electronic Control Unit), EECU (Electronic Engine Control Unit)	K11	Start inhibit relay
K2 ¹	Reversed +15	K12 ¹	Starting signal, starter motor
	Battery warning		Luggage compartment lighting (alternative)
K3	Self-holding relay, ECS	K13	Emergency stop
K4 ¹	TECU (Transmission Electronic Control Unit) GSECU (gear selector electronic control unit) I-shift transmission	K14 ¹	Trailing axle
K5 ¹	Manual transmission EGS	K15 ¹	RECU (retarder control unit)
K6 ¹	Manual transmission EGS	K16 ¹	RECU (retarder control unit)
K7	Baggage hold lighting	K17	Ignition relay (+15)
	Starting signal, starter (alternative)		

Relays			
K8 ¹	Inverting relay, neutral signal (only automatic transmissions)	K48 ₂	Preheating relay
	VECU (Vehicle Electronic Control Unit), EECU (Electronic Engine Control Unit)		
K9	Interval relay, windscreen wiper motor	K51 ₃	Main power supply relay
K10 ₁	Inverting relay, neutral signal (only automatic transmissions)		

¹ Depends on version.

² This is located on the engine bay bracket near the emergency stop.

³ This is located in a steel box next to the battery box.

Fuses

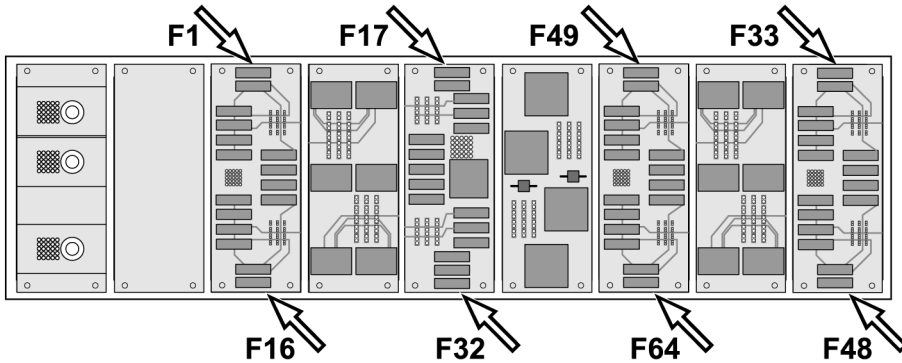

T0012035

Fuses					
F1	5A	ECS (electronic controlled suspension)	F35	25A	LCM (lighting control module)
F2	10A	BIC (instrument), control switch	F36	25A	LCM (lighting control module)
F3	15A	Starting signal, starter motor	F37	25A	LCM (lighting control module)
F4	20A	EBS (electronic brake system)	F38	5A	Reversed +15
F5	5A	Horn	F39 ¹	25A	Exhaust emissions cleaning control unit
F6	5A	Emergency release of parking brake	F40	—	Spare
	30A	Ignition switch (Early version)			
F7 ¹	15A	TECU (transmission electronic control unit), GSECU (gear selector electronic control unit) transmission I-shift	F41 ¹	20A	Radio
				—	Spare
F8 ¹	5A	GECU (gear selector electronic control unit) I-shift	F42	5A	Emergency stop switch, main switch

Fuses					
F9	5A	Starting switch, engine compartment	F43	—	Spare
F10	5A	Fire Alarm	F44	25A	LCM (lighting control module)
F11 ¹	10A	Dynafleet (option)	F45	25A	LCM (lighting control module)
F12	5A	Supply, main switch (+30) to body-builder outlet	F46	25A	LCM (lighting control module)
F13	5A	Spare	F47	5A	Side position lamp, right-hand side
F14	5A	BBM (Body Builder Module)	F48	5A	Side position lamp, left-hand side
F15	15A	EECU (Electronic Engine Control Unit), Control valve * (1) ¹ , radiator fan, preheating relay	F49	5A	Fuel shut-off valve
F16	5A	VECU (vehicle control unit)	F50 ¹	10A	RECU (retarder control unit)
F17	5A	Lighting switch	F51 ²	20A	Radio, 24–12 V (+30) converter
				—	Spare
F18	5A	Alternator 1, 2, 3	F52 ¹	10A	Baggage hold lighting
F19 ¹	10A	PCM (Powertrain Control Module)	F53 ¹	5A	Trailing axle, dehydrator heater
	10A	Preheating relay			
F20	10A	EBS (electronic brake system control unit)	F54	5A	Engine hatch/luggage compartment hatch
F21	15A	Wiper motor, windscreen	F55	10A	VCB (Volvo Compression Brake), EPG (Exhaust Pressure Governor), radiator solenoid valve, fuel bleed pump, preheating relay

92 If Something Happens

Fuses					
F22	5A	TECU (transmission electronic control unit), Voith automatic transmission	F56	5A	Preheating relay
				10A	Dehydrator heater
F23	5A	ACC	F57	5A	Ignition key/Start switch
F24	5A	BIC (instrument panel), OBD	F58	5A	Gas tank control unit
F25	15A	Wiper motor, headlights	F59	10A	TECU (transmission electronic control unit), Voith automatic gearbox
F26	5A	ECS (electronic controlled suspension)	F60	10A	TECU (Transmission Electronic Control Unit), ZF automatic transmission/gearbox
F27	10A	Manual gearbox, EGS	F61	10A	Baggage hold lighting
F28	10A	RECU (retarder control unit)	F62	5A	Dimmed interior lighting
				—	Spare
F29	5A	Power from the ignition (+15) to body electrical system connector	F63	5A	Starter motor relay
				—	Spare
F30	5A	Radio, 24–12 V (+15) converter ²	F64	—	Spare
	20A	Fuel heater			
F31	5/10 A	Hydraulic oil level, hydraulic oil filter, exhaust emissions cleaning control unit	F80 ³	150 A	Main battery fuse (B+)
F32	5A	Tachograph	F81	80A	Power supply main fuse (+30)
F33	5A	BIC (instrument)	F93	5A	Alternator
F34	10A	Tachograph			

¹ Depends on version.

² Loose fuse holder next to it.

³ This is located in a steel box next to the battery box.

Fuses and relays (body)

The fuse and relay box is located at the front of the bus.

Relays

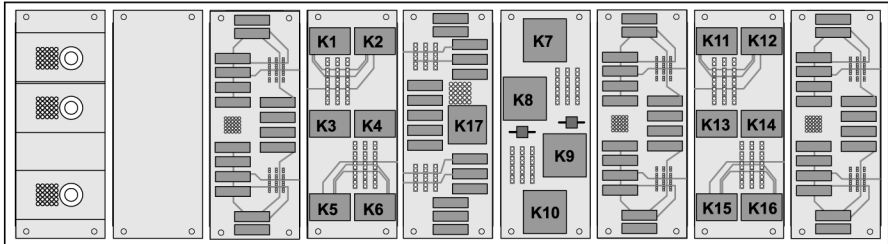

T0012034

Relays			
K1	Flat screens	K4	Defroster, speed 1
K2	Over speed control 95 km/h [59 mph]	K5	Defroster, speed 2
K3	Flat screens	K6	Defroster, speed 3

Fuses

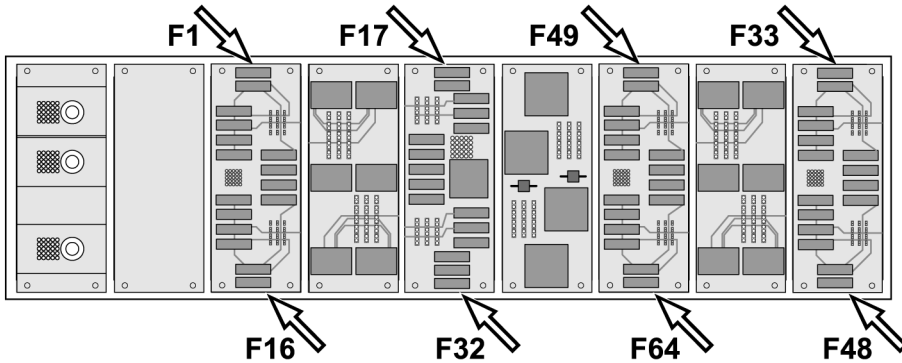

T0012035

Fuses					
F1	3A	Power Master ID	F33	3A	Relays
F2	5A	Transcom	F34	5A	Light under seats
F3	20A	Audio & Video 12V	F35	10A	Park Pilot
F4			F36	30A	Auxiliary Heater
F5	30A	Floor IO B Module	F37		
F6	5A	Climate IO a Module	F38	15A	CECM B
F7			F39	15A	Dashboard converter cigarette output
F8			F40	5A	Middle door, I/O A Module
F9	5A	Climate Unit I/O A	F41	5A	Pressure switch
F10	5A	Defroster Flap	F42	5A	Dashboard, I/O A Module
F11	5A	Red Led Switches	F43		
F12	20A	Defroster	F44	15A	24 VCD output in Dashboard
F13	30A	Roof Left IO B Module	F45	30A	24 VCD output in driver side
F14	7.5A	Destination Sign control	F46		
F15			F47		
F16			F48	5A	Webasto Timer

Fuses					
F17	3A	Over Speed warning, relay K2	F49	5A	Control Panel air
F18	7.5A	Toilet I/O B Module	F50		
F19	20A	Electric Window	F51	5A	Destination sign (+15)
F20			F52		
F21	15A	Roof Left I/O B Module	F53	15A	DRC Air Conditioning
F22	3A	Emergency Window Signal	F54	3A	Audio & Video (+15)
F23			F55		
F24	5A	Webasto Timer	F56	5A	Time & Temperature Display
F25	5A	Copilot TD7	F57	5A	Power +15 TD7
F26			F58	7.5A	Roof Hatch Front
F27			F59	7.5A	Roof Hatch Rear
F28	20A	Audio & Video 24 volts	F60		
F29			F61	15A	Electrical Binder
F30	7.5A	Toilet I/O B Module	F62	5A	Webasto Timer
F31			F63		
F32			F64		

Technical Specification

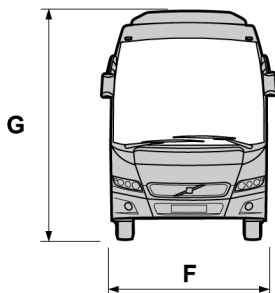
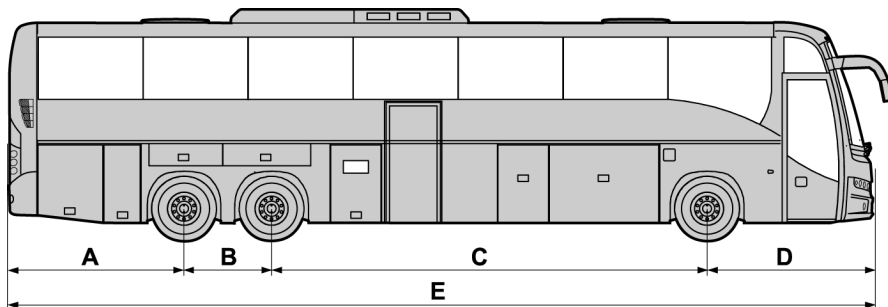

T8012396

Technical Specification	
	3-axle 13.7m
A	2,780 mm (109 in.)
B	1400 mm (55 in.)
C	6660 mm (262 in.)
D	2,850 mm (112 in.)
E	13,690 mm (539 in.)
F	2600 mm (102 in.)
G	3671 mm (145 in.)

Bulbs

Light	Rated Power	Volvo p/n
Main beam	70 W	990037
Dipped beam	70 W	990037
Direction indicator, front	21 W	982558
Direction indicator, rear	21 W	982558
Fog lamps, front	70 W	990037
Side marker	5 W	19926
Fog, rear	21 W	967708
Reversing	21 W	967708
Licence plate	5 W	19926
Side direction indicator	21 W	967708
Entrance	5 W	967709
Engine bay	21 W	967708

Type Plates

The vehicle identification number (VIN) is marked on an identification plate on the bus.

Identification Plate

Within its inside border, the identification plate is subdivided into a legal requirement section, as well as three boxes for the chassis number, drive and wheelbase. These latter are not used for buses, only for lorries. The identification plate is located by the driver's seat and contains the following information:

- G.V.W.R (Gross vehicle weight rating), is the maximum allowable total weight of the vehicle.
- G.A.W.R (Gross axle weight rating), is the maximum distributed weight that may be supported by an axle VIN is the same number that can be found on the frame member.
- Tires dimensions.
- Rims dimensions
- Cold inflation pressure, is the inflation pressure of the tires before the vehicle is driven and the tires warmed up.
- VIN is the same number that can be found on the frame member.



MANUFACTURED BY: VOLVO BUS CORPORATION
 FABRIQUE PAR: VOLVO VIM

DATE OF MFG:
 DATE DE FAB:

G.V.W.R.: 22407 KG. (49400 LBS)
 P.N.B.V.:

AXLES/ ESSIEUX	G.A.W.R/ P.N.B.E.		TIRES/ PNEUS	RIMS/ JANTS	COLD INFLATION PRESS/ PRESS A FROID		SINGLE OR DUAL/ SIMPLE OU DOUBLE
	KG	LBS			KPA	PSI	
FRONT/ AVANT	7484	(1657 00)	315 / 80R22.5J	22,5/9,00	830	(120)	S
MID- DRIVE	10024	(2211 00)	315 / 80R22.5J	22,5/9,00	620	(90)	D
REAR/ ARRIERE	4890	(1078 00)	315 / 80R22.5J	22,5/9,00	500	(85)	S

THIS VEHICLE CONFORMS TO ALL APPLICABLE U.S. FEDERAL MOTOR VEHICLE SAFETY STANDARDS AND CANADIAN MOTOR VEHICLE SAFETY REGULATIONS IN EFFECT ON THE DATE OF MANUFACTURE SHOWN ABOVE. CE VEHICULE EST CONFORME A TOUTES LES NORMES QUI LUI SONT APPLICABLES EN VERTU DES REGLEMENTS SUR LA SECURITE DES VEHICULES AUTOMOBILES DU CANADA EN VIGUEUR A LA DATE DE SA FABRICATION INDIQUEE CI-HAUT.

VEHICLE IDENTIFICATION NO. TYPE: BUS B1A

T0015663

Vehicle Identification (VIN)

This is stamped on the chassis at the right-hand front end of the vehicle, i.e. in the wheel arch in front of or behind the front axle.

Example: **YV3R7G62151106335**

YV3	Manufacturer
R7	Chassis version
G6	Engine version
2	Brake system
1	Check figure
5	Model year
1	Assembly factory
106335	Chassis number

Engine

Type designation, component number and serial number are punched on the top of engine block near the injector pump.

Transmission

The type designation and serial number are punched on the top of the transmission.

Rear Axle

The plate is on the right-hand side of the rear axle housing.

Retarder

Serial number and version are stamped on rear left side of retarder housing.

Service Intervals

Regular servicing in accordance with the special service schedule is required to maintain the bus to its original specifications throughout its service life.

Carry out all servicing and maintenance of the bus at a Volvo workshop or, for Prevost support vehicles, in Prevost service center/provider.

These workshops have the trained personnel, special tools and necessary service literature that are vital in ensuring high quality of servicing. This quality also depends on the use of Volvo Original Spares, which are of identical quality to the components installed at the Volvo works.

For service intervals, see the separate service literature.

When washing the bus, only use agents that are intended for this purpose. See also: Operating Instruction "Interior maintenance".

VOLVO

Volvo Bus Corporation

Göteborg, Sweden