

<b>KEYS .....</b>	<b>4</b>
UTILITY COMPARTMENTS KEY .....	4
<b>KEYLESS IGNITION SWITCH.....</b>	<b>4</b>
OFF .....	4
ON.....	5
START .....	5
<b>LATERAL CONTROL PANEL.....</b>	<b>7</b>
TRANSMISSION CONTROL PAD .....	8
<i>Kneeling System</i> .....	8
<i>Horn Selector</i> .....	8
<i>Power Window Switch</i> .....	8
TAG AXLE CONTROL VALVE .....	9
PARKING BRAKE CONTROL VALVE .....	9
PREHEATER TIMER.....	9
UTILITY COMPARTMENT.....	9
12-VOLT POWER OUTLET.....	9
<b>ON BOARD DIAGNOSTIC RECEPTACLE.....</b>	<b>9</b>
<b>AUTOMATIC FIRE DETECTION AND SUPPRESSION SYSTEM (AFSS).....</b>	<b>10</b>
PROTECTION PANEL .....	10
MANUAL ACTIVATION SWITCH.....	10
<b>CRUISE CONTROL .....</b>	<b>10</b>
<i>Turning the system on</i> .....	10
<i>Setting at a desired speed</i> .....	10
<b>PREVOST AWARE • ADAPTIVE CRUISE BRAKING .....</b>	<b>12</b>
TURNING THE ACB SYSTEM ON .....	13
TURNING OFF THE ACB SYSTEM.....	13
MAINTAINING A SET FOLLOWING DISTANCE.....	13
DRIVER WARNINGS.....	14
<i>Dashboard Telltale</i> .....	14
<i>Speedometer Leds</i> .....	14
<i>Following Distance Alert (Fda)</i> .....	15
<i>Impact Alert</i> .....	15
BRAKE OVERUSE WARNING.....	15
SELF-DIAGNOSTIC AT START-UP .....	17
SYSTEM MALFUNCTION.....	17
<b>TIRE PRESSURE MONITORING SYSTEM (TPMS) .....</b>	<b>17</b>
<i>TPMS Display</i> .....	17
<i>Operation</i> .....	18
<i>Start-up</i> .....	18
<i>Pre-Trip Check</i> .....	18
<i>Spare tire:</i> .....	20
<i>Post Trip Operation</i> .....	20
<b>DASHBOARD .....</b>	<b>21</b>
CONTROL SWITCHES.....	22

## 4-2 Controls and Instruments

---

L. H. DASHBOARD PANEL .....	22
<b>7B</b> Headlights and Exterior Lighting .....	22
R. H. DASHBOARD PANEL.....	24
HVAC CONTROL UNIT.....	26
Heating Mode Indicator.....	27
Cooling Mode Indicator .....	27
Fan Speed .....	27
Recirculate .....	27
Driver's section temperature setting .....	27
Passenger's section temperature setting .....	27
Windshield Defogger .....	28
Panel and Footwell .....	28
Panel .....	28
Temperature Degree Selector.....	28
AUDIO-VIDEO SELECTOR FOR THE PASSENGER'S AREA .....	28
AIR VENTS .....	31
<b>INSTRUMENT CLUSTER.....</b>	<b>32</b>
ANALOG INDICATORS .....	33
TELLTALE LIGHTS.....	36
<b>10B</b> Stop .....	36
<b>11B</b> Check .....	36
<b>12B</b> Information.....	36
<b>13B</b> Turn signal indicators .....	36
<b>14B</b> Parking brake or emergency brake applied.....	37
<b>15B</b> Aftertreatment system malfunction (Malfunction Indicator Lamp).....	37
<b>16B</b> Cruise control.....	37
<b>17B</b> Cruise control set speed.....	37
<b>18B</b> High exhaust system temperature (HEST).....	37
<b>19B</b> DPF regeneration request.....	37
Low DEF level.....	38
<b>20B</b> CHARGING SYSTEM WARNING LIGHT .....	38
<b>21B</b> Intake air preheater on – wait before starting.....	38
<b>22B</b> Flat tire (with optional tire pressure monitoring system) .....	38
<b>23B</b> Hill start assist .....	38
<b>24B</b> Antilock brake system (ABS).....	39
<b>25B</b> Trailer antilock brake system (ABS).....	39
<b>26B</b> TCS/ESC - Traction Control System and Electronic Stability Control.....	39
<b>27B</b> High beam .....	39
STOP, CHECK AND INFORMATION TELLTALE LIGHTS .....	39
STOP Telltale light.....	39
CHECK Telltale light .....	40
INFORMATION Telltale light .....	40
Acknowledging Messages.....	40
DRIVER INFORMATION DISPLAY .....	40
Selecting a menu.....	41
To change settings.....	41
Scrolling through the menus without using the steering wheel buttons.....	41
PICTOGRAMS DISPLAYED ON THE DRIVER INFORMATION DISPLAY (DID) .....	43
Warning pictograms, pop-up message pictograms, verifications and information pictograms.....	43
Status Line Pictograms .....	50
Status Line Pictograms Contd. ....	51
VEHICLE CLEARANCE INFORMATION .....	51

<b>STEERING COLUMN CONTROLS .....</b>	<b>51</b>
MULTI-FUNCTION LEVER .....	51
<i>Turn Signal (1)</i> .....	51
<i>Lane Change Signal (2)</i> .....	51
<i>Headlight Beam Toggle Switch (3)</i> .....	51
<i>Courtesy Blinkers (4)</i> .....	52
<i>Windshield Washer Control (5)</i> .....	52
<i>Windshield Wipers (6)</i> .....	52
STEERING WHEEL CONTROLS .....	53
HORNS .....	54
<b>FOOT-OPERATED CONTROLS .....</b>	<b>54</b>
BRAKE PEDAL .....	54
ACCELERATOR PEDAL .....	55
<b>ALLISON TRANSMISSION .....</b>	<b>55</b>
OPERATION .....	55
PUSHBUTTON SHIFT SELECTOR .....	55
PRIMARY AND SECONDARY SHIFT SCHEDULES .....	56
TRANSMISSION SERVICE INDICATOR.....	56
DESCRIPTION OF AVAILABLE RANGES.....	56
<i>R (Reverse)</i> .....	56
<i>N (Neutral)</i> .....	56
<i>D (Drive)</i> .....	57
<i>2 (Second range)</i> .....	57
<i>3, 4 (Third and fourth ranges)</i> .....	57

### KEYS

Use this key to unlock all the following interior and exterior locks.

- the entrance door;
- the baggage compartment doors;
- WCL door;
- inverter access hatch (lavatory mirror);
- the electrical and service compartment doors;
- Two lockable overhead compartment;

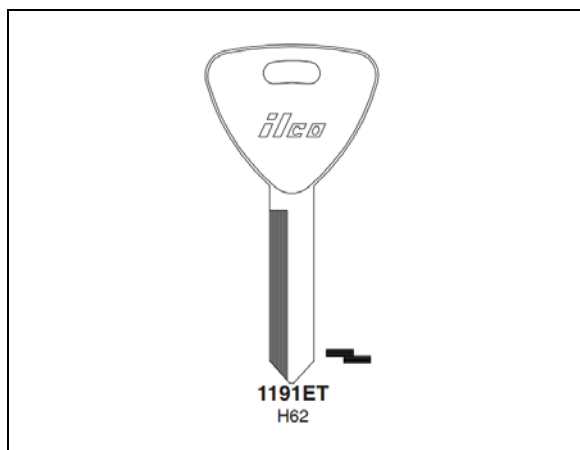

### UTILITY COMPARTMENTS KEY

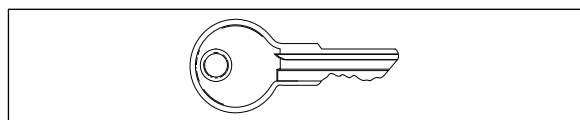

This key locks or unlocks the utility compartments and the utility drawer on the dashboard.

### KEYLESS IGNITION SWITCH

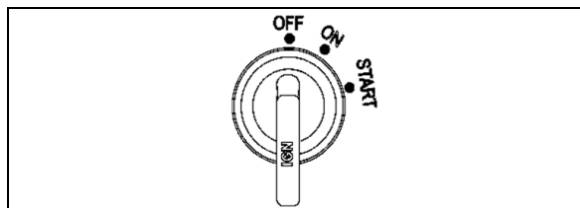

IGNITION SWITCH POSITIONS

06354

Coaches may be equipped with an ignition lever instead of an ignition key. Use the ignition switch to activate the electrical circuit by turning it counterclockwise to the ON position.

To start the engine, turn the key clockwise to the START position, and then release it. The key will set to ON position.



### CAUTION

When the vehicle is parked overnight or for an extended period of time, the battery master switch (ignition switch) should be set to the *off* position.

### NOTE

When the battery master switch (ignition switch) is set to the *off* position, all electrical supply from the batteries is cut off, with the exception of battery equalizer check module, ecm ignition and power supply, Allison tcm, i-shift transmission ecu, coolant electronic, coolant heater and water re-circulating pump, power-verter, fire alarm and entrance door.

The ignition switch doubles as the battery master switch. Any position other than OFF activates the electrical circuits. Electrical circuits are also activated when the hazard switch is depressed. Two auxiliary master switches in series with the ignition switch are installed on the vehicle; one is located on the rear electrical panel and one in the engine compartment on the rear start panel, for maintenance ease.

The ignition switch is located on the lower left side of the dashboard. It has four positions:

### OFF

In the *OFF* position, ignition cannot take place. The key can be removed when in this position.

The electrical circuits are not activated when the switch is in this position. Only the accessories connected directly to the batteries can be activated. These are the coolant heater and water pump, the battery master switch, the baggage compartments locking system, the entrance door and Message Center Display

(MCD). Maintain the switch in this position when parked overnight or for an extended period.

**NOTE**

*The battery master switch is on when the hazard flashers are activated, even if the key is in the off position.*

**ON**

To place ignition switch to *ON*, turn the key clockwise to the first position. The key cannot be removed when in this position.

The electrical circuits activated when the switch is in the *ACC* position plus the transmission, engine and accessories, ABS system, wipers, dashboard cluster gauges and buzzers, air horn and air dryer heater are activated when the switch is in this position. Do not leave the key in this position unless the engine is running.

**START**

Turn the key clockwise to the second position and release as soon as the engine starts. The key will return to the *ON* position. If the engine did not start, return the ignition key to the *OFF* position before trying to restart the engine.

The ignition switch is equipped with a starter protection which inhibits turning the key to the *START* position if the key has not previously been turned to the *OFF* position.



**CAUTION**

To avoid overheating the starter, do not engage the starter for more than 15 seconds at a time. Allow the starter to cool before trying to restart the engine.



**CAUTION**

If the "starter on" indicator light remains illuminated even after releasing the ignition switch, stop the engine immediately and set the battery master switch (ignition switch) to the off position. Have the starter checked immediately.

The features activated when the engine is running are all those described above plus the HVAC system and daytime running lights.



**DANGER**

**Do not** use ether or other combustible starting aid fluid on any engine equipped with an intake air preheater. If the engine is equipped with a preheater, introduction of ether or similar starting aids could cause a fire or explosion resulting in severe property damage, serious personal injury or death.

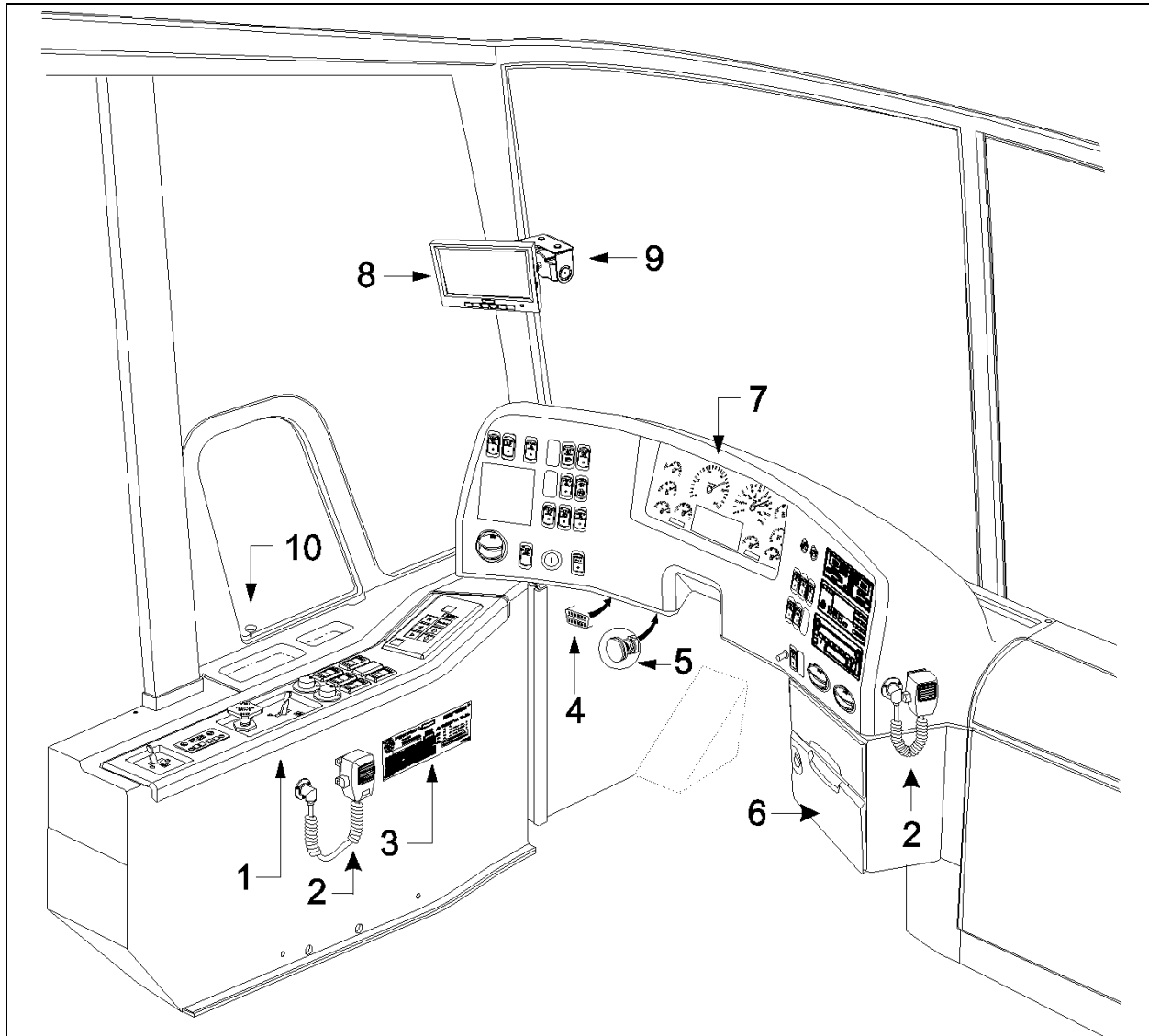

1. Lateral control panel
2. Microphone
3. DOT certification plate
4. OBD (On Board Diagnostics) receptacle
5. Foot-operated steering wheel adjustment release knob
6. Driver's utility compartment
7. Dashboard
8. Rear view monitor (not provided)
9. Front view scenic camera (not provided)
10. Front electrical and service compartment door unlocking pull rod

LATERAL CONTROL PANEL

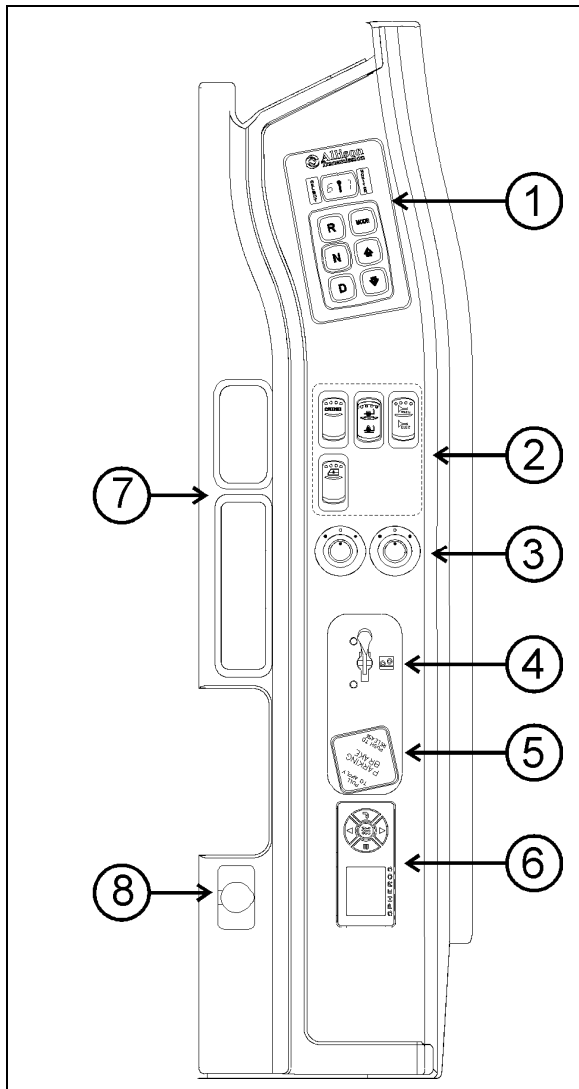

1. Transmission control pad
2. Control switches
3. Not functional (outside rear view mirrors are manually adjustable)
4. Tag axle control valve
5. Parking brakes control valve
6. Coolant preheater timer
7. Utility Compartment
8. 12-volt power outlet

LATERAL CONTROL PANEL

### 1 TRANSMISSION CONTROL PAD

The Allison transmission control pad is located on the lateral control panel. Refer to AUTOMATIC TRANSMISSION in this chapter for operating instructions and more information.

### 2 CONTROL SWITCHES

#### Cruise Control Switch

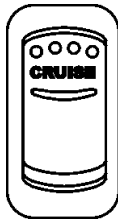

06701

Depress the **crui**se rocker switch to activate the cruise control. This turns the system on. A led on the switch shows that you can now set the vehicle at a desired cruising speed.

For operation of the cruise control, refer to CRUISE CONTROL & PREVOST AWARE-ADAPTIVE CRUISE BRAKING paragraphs in this chapter.

#### Kneeling System

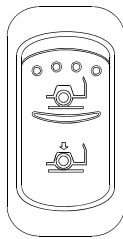

06250

Momentarily press the rocker switch downwards to lower the front end of the coach 4 inches (100 mm). Momentarily press the rocker switch upwards to raise the coach to the normal driving height. Refer to OTHER FEATURES section for more information.

***NOTE***

*The parking brakes must be applied to allow the use of the kneeling.*

#### Horn Selector

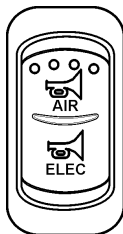

06700

Use this switch to toggle between the air horn and the electric horn when pressing the steering wheel center pad.

#### Power Window Switch

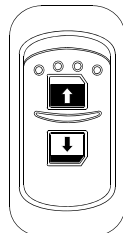

06338

Use this rocker switch to open or close the driver's power window.

***CAUTION***

Close power window when parked or leaving the coach unattended.



4 TAG AXLE CONTROL VALVE

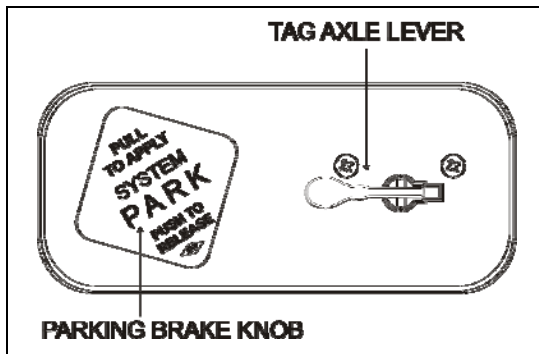

CONTROL VALVES

12129\_EN

Lift the tag axle by pushing the lever forward. Pulling the lever back will lower the tag axle. Refer to "Other Features" chapter for additional information.

**AUTOMATIC UNLOAD**

To reduce the turning radius, the air springs pressure will be automatically reduced by 75% when the coach is moving at speed lower than 5 mph (8 km/h) and with more than 1½ turn from the steering.

5 PARKING BRAKE CONTROL VALVE

Spring-loaded parking brakes are applied by pulling up the control valve knob and protector assembly. Lift the safety cover and push down to release brakes. Refer to SAFETY FEATURES AND EQUIPMENT chapter.

6 PREHEATER TIMER

Use the timer to program the start time of the optional engine coolant preheater. Refer to OTHER FEATURES chapter and supplied manufacturer's manual for additional information.

7 UTILITY COMPARTMENT

To open the compartment, lift the cover.

8 12-VOLT POWER OUTLET

This 12 volts DC power outlet can be used to power small 12 volt DC appliances such as a cellular phone. The maximum power consumption allowed for appliances plugged in this socket is 130 watts.

**ON BOARD DIAGNOSTIC RECEPTACLE**

To ease troubleshooting, you can connect a diagnostic tool through the OBD receptacle to access recorded data. The OBD receptacle is located under the dashboard, on the left side.

## 4-10 Controls and Instruments

### AUTOMATIC FIRE DETECTION AND SUPPRESSION SYSTEM (AFSS)

#### PROTECTION PANEL

The protection panel displays the current system status. The protection panel contains “SYSTEM OK”, fire “ALARM” and “TROUBLE” lamps, the audio alarm, the “TEST/RESET” switch, and the “ALARM SILENCE” switch.

The “SYSTEM OK” lamp indicates power is on the system and that there are no trouble conditions present. The “TROUBLE” lamp blinks if there is a fault in the detection circuitry and illuminates solid if there is a fault in the extinguishing circuitry. When the “TROUBLE” lamp is on, the “SYSTEM OK” lamp will be off and the audible alarm will sound intermittently. The “SYSTEM OK” lamp will flash when the system is low on battery power. Depressing the “TEST/RESET” switch tests the protection panel lamps and audio alarm. The “ALARM SILENCE” switch will disable the audio alarm.

When a fire detector automatically detects a fire, the fire “ALARM” lamp and audio alarm activate. When the Manual Activation Switch is activated, the fire “ALARM” lamp blinks and the audio alarm activates. The lamp will remain blinking until power is cycled to the system.

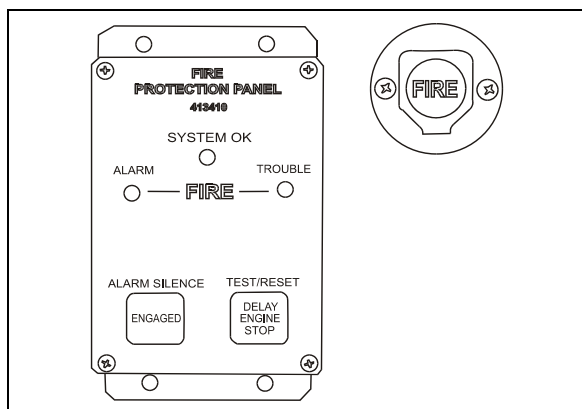

AFSS PROTECTION PANEL & MANUAL ACTIVATION SWITCH

#### MANUAL ACTIVATION SWITCH

The manual activation switch allows immediate system activation (extinguisher discharge and engine shutdown) by the operator at any time. Activation of the switch is accomplished by

twisting and pulling the tamper seal to remove, lifting the cover and pressing the red “FIRE” button for more than half a second. After the manual activation switch has been activated, the protection panel will blink the fire “ALARM” indicator until power has been cycled to the system.

Refer to SAFETY FEATURES AND EQUIPMENT chapter for more information on *Kidde Dual Spectrum* Automatic Fire detection and Suppression System (AFSS).

### CRUISE CONTROL

The cruise control allows you to cruise the vehicle at a desired speed without having to use the accelerator pedal.

Turning the system on

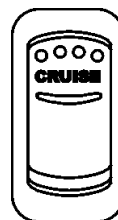

06701

To operate the cruise control, press the **cruise** rocker switch located on the lateral control panel to the on position. This turns the system on. The dashboard telltale turns on; you can now set the vehicle at a desired cruising speed. To turn off the system, press the rocker switch to the off position.

#### NOTE

The **cruise** switch and **resume** button do not operate at speeds below 30 mph (50 km/h).

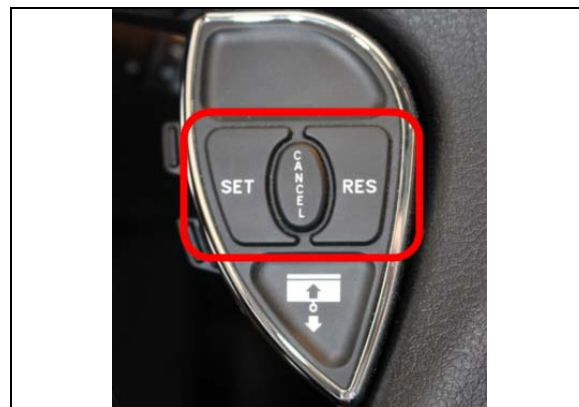

CRUISE CONTROL BUTTONS

Setting at a desired speed

Accelerate the vehicle to the desired cruising speed using the accelerator pedal. Press and

release the **SET** button then remove foot from the accelerator pedal. This will set the vehicle cruise speed and store it in memory. The set speed will appear in the driver information display.

### Increasing set speed

The vehicle cruise speed setting can be increased by one of the following methods.

1. Accelerate using the accelerator pedal until the desired cruising speed is reached. Press and release the **SET** button.

or

2. Press and hold the **RES** (RESUME) button until the desired cruising speed is reached. When the **RES** button is released, the new cruising speed will be stored in the cruise control memory.

or

3. When driving with cruise control, each time the **RES** button is momentarily depressed, the cruising set speed is raised by 1 mph (2 km/h).

#### **NOTE**

*When driving with cruise control, the vehicle can still be accelerated by depressing the accelerator pedal in the usual manner. Once the accelerator pedal is released, the vehicle will return to the previously set cruising speed.*

### Decreasing set speed

The vehicle cruise speed setting can be decreased by one of the following methods.

1. Press and hold the **SET** button until the desired cruising speed is reached. When the **SET** button is released, the new cruising speed will be stored in the cruise control memory.

or

2. Each brief pressing of the **SET** button will decrease set cruising speed by 1 mph (2 km/h).

or

3. Slightly apply the service brake and when desired cruise speed is reached, press and release the **SET** button.

### Canceling the set speed

You can cancel the set cruising speed by:

1. Pressing momentarily the **CANCEL** button;
2. Depressing the brake pedal.

### Automatic Cruise Control Cancellation

The set speed is automatically canceled in any of the following situations:

- The windshield wipers are operating in low or high speed;
- The actual vehicle speed falls below 30 mph (50 km/h).

## 4-12 Controls and Instruments

### Resuming Set Speed

If the set speed is cancelled by pressing the **CANCEL** button or depressing the brake pedal, pressing the **RES** (RESUME) button will restore the speed set prior to cancellation, providing that your speed is above 30 mph (50 km/h).

#### NOTE

*When driving downhill with the cruise control on and set, the engine brake or the transmission retarder engage automatically (if previously activated) when the selected cruise speed is exceeded by approximately:*

- 4 mph (7 km/h) with the engine brake activated;
- 0.6 mph (1 km/h) with the transmission retarder activated.

*The engine brake or the transmission retarder is then disengaged when speed has returned near to selected cruise speed.*

*The engine brake will provide low braking power or high braking power depending on which of the two steering wheel engine brake control buttons is activated;*

① = engine brake low

② = engine brake high

*The transmission retarder maximum braking level is determined by the retarder hand lever position on the steering wheel.*

#### NOTE

*To avoid sudden vehicle hesitation, slightly depress the accelerator pedal before disengaging the cruise control.*

#### NOTE

*When the **cruise** rocker switch is released, the cruise control is completely shut off and the cruise speed setting is erased from the cruise control memory.*

#### IMPORTANT NOTE

*If the engine was stopped and the cruise rocker switch was in the on position, the rocker switch must be reset by turning it off then on again in order for the cruise control to be reactivated.*



### WARNING

Do not use the cruise control when driving speed must be constantly adjusted, such as in heavy traffic or on winding, icy, snow-covered or slippery roads, or on gravel roads.



### WARNING

Do not put the transmission in the neutral (n) position while driving with cruise control. This may cause the engine to over-speed and result in a loss of driving control.

### PREVOST AWARE • ADAPTIVE CRUISE BRAKING

Prevost AWARE Adaptive Cruise Braking (ACB) is an optional cruise control that not only maintains the set speed, but will also intervene, as needed, to help the driver maintain a set following distance behind the forward vehicle by reducing speed as necessary. As soon as the forward vehicle is at a safe distance, the coach will accelerate back to the cruise set speed.

#### NOTE

*The following paragraphs briefly sum up the information concerning the operation and function of the ACB. Before driving the vehicle, be certain that you have read and that you fully understand each and every step of the driving and handling information found in Bendix Wingman ACB Active Cruise with Braking Operator's Manual. The driver should fully understand all the audible alerts and visual indicators that the system provides. Bendix Wingman ACB Active Cruise with Braking Operator's Manual (available on Prevost web site and included on the Technical Publications CD) will assist in explaining what each of them means and what actions the driver may be required to take to avoid potential collisions.*



**WARNING**

Even with ACB, the driver must remain alert, react appropriately and in a timely manner, and use good driving practices. Ultimate responsibility for the safe operation of the vehicle remains with the driver at all times.

Be certain that you have read all safety warnings found in Bendix Wingman ACB Active Cruise with Braking Operator’s Manual.

The driver will benefit all the audible and visual warnings that the system provides whether or not ACB is turned on. In addition to the audible and visual warnings, when the ACB is turned on and a cruise speed is set, the driver benefits from active interventions like engine throttle reduction, retarder or engine brake application and service brakes application to help maintain a set following distance.



**WARNING**

Adaptive Cruise Braking must be used only in the same conditions that are normally recommended for ordinary cruise control. Refer to “Regular Cruise Control” paragraph.

**TURNING THE ACB SYSTEM ON**

Activation of the adaptive cruise braking is similar to the regular cruise control activation. Press the CRUISE rocker switch to the ON position, accelerate the vehicle to the desired cruising speed and then, press the SET button. ACB is now engaged with the set following distance and driver warnings features. Whenever the cruise control is engaged, the ACB is also engaged. You cannot engage the cruise control without also using the ACB features.

**TURNING OFF THE ACB SYSTEM**

You can turn off the ACB system, simply by applying service brakes, setting the CRUISE rocker switch to the OFF position or pressing the cruise control CANCEL button on the steering wheel.

**NOTE**

*Whenever the service brakes are applied by*

*intervention of the ACB or by the driver, normal cruise will automatically be cancelled. The driver must resume or set the cruise mode in order for the vehicle to throttle up.*

**MAINTAINING A SET FOLLOWING DISTANCE**

Using a radar sensor mounted to the front bumper, the ACB system measures the distance between the coach and the forward vehicle and intervenes to help maintain a safe set following distance behind the vehicle. This feature engages automatically once the driver turns on and sets cruise speed.

Following distance refers to the time gap, measured in seconds, between the coach and the vehicle ahead. The actual physical distance between the coach and the vehicle ahead will vary based on your set cruise speed; although the set time gap remains the same for all set cruise speeds. Prevost’s default set time gap is 1.7 seconds.

With cruise control engaged and a cruise speed set, you are maintaining a set following distance between the coach and the forward vehicle:

- **If the vehicle in front of the coach slows down** below your cruise control set speed, the system will progressively intervene as follows, in this order:
  - 1) reduce the engine throttle;
  - 2) apply the engine brake or transmission retarder;
  - 3) apply about 30% of the service brakes available braking power in an attempt to maintain the set following distance.

**The driver must apply additional braking power when required, to avoid collision or to maintain a safe distance from the vehicle ahead.**

**NOTE**

*If the ACB is actively decelerating or braking the coach in an attempt to maintain the set following distance at the moment when the driver cancels the ACB system, the ACB system will continue deceleration or braking intervention until a safe following distance is established, then will cancel.*

*Even though the cruise control doesn’t operate at speeds below 30 mph (50 km/h),*

## 4-14 Controls and Instruments

*the ACB system will continue deceleration or braking intervention in an attempt to maintain the set following distance if the coach speed reduces to less than 30 mph (50 km/h).*

- **If the vehicle ahead slows below your cruise control's set speed**, but then accelerates away, and the ACB system did not need to use the service brakes as it managed the intervention, the coach will automatically accelerate back to the original cruise control set speed, and again maintain a set following distance behind the forward vehicle.

### **NOTE**

*The maximum radar range is approximately 500 feet (150 meters). Rain, snow, fog, ice and other severe weather conditions may affect the performance of the ACB system and shorten radar range.*

### **NOTE**

*As part of your pre-trip vehicle inspection, check to see that there is no mud, snow, ice build-up or other obstruction in front of the radar sensor. You should inspect the radar sensor mounting and remove any obstruction that may impair the sensor functioning.*

### DRIVER WARNINGS

Before using the ACB, the driver should fully understand all the audible and visual warnings that the system provides. Any audible warning (beeping or tone) means that your vehicle is too close from the vehicle ahead.

### Dashboard Telltale

When ACB is turned on and a cruise speed is set, if the forward vehicle is detected (in range) by the radar, the FORWARD VEHICLE DETECTED telltale light on the dashboard will illuminate. This is an indication to the driver that the forward vehicle is being tracked, that the ACB is actively managing the distance between the coach and the vehicle ahead and that the ACB system may automatically intervene to maintain the set following distance.



### FORWARD VEHICLE DETECTED telltale light

There are three types of warnings with this telltale light:

- Green: The forward vehicle is detected (in range).
- Flashing red: Collision alert. The forward vehicle is too close to follow safely or a metallic stationary object such as a stopped or stalled vehicle in your lane of travel is detected. The driver must intervene to avoid a collision.
- Solid red: ACB system malfunction. The ACB system and the alert functions are not available.

### Speedometer Leds

With the cruise control engaged and a cruise speed set, a green LED illuminates above the cruise control set speed on the speedometer.



THE CRUISE SET SPEED IS 80 km/h

With a cruise speed set, the vehicle ahead slows moderately. The system will display to the driver the approximate speed of the vehicle ahead with yellow LEDs above the speedometer.

The vehicle in front of you travels at a speed slower than your vehicle cruise control set speed. The first yellow LED indicates that vehicle's speed as measured by the ACB system.

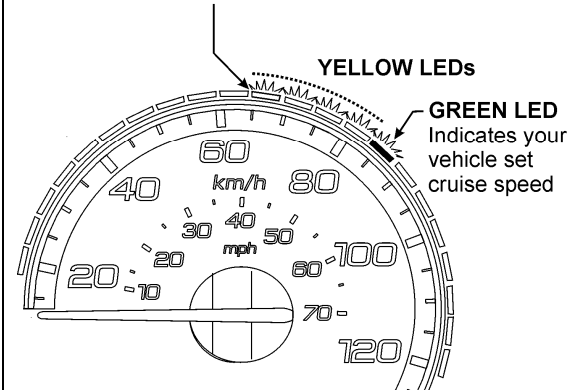

**EXAMPLE OF THE SPEEDOMETER LED DISPLAY WHEN THE FORWARD VEHICLE IS SLOWER WHILE THE COACH TRAVELS WITH THE ACB CRUISE CONTROL ON AND SET**  
06729\_3

The Impact Alert is also applicable to stationary metallic objects such as stopped or stalled vehicles. This alert provides a warning given up to 3.0 seconds before a potential collision with a stationary metallic object in the coach's lane of travel. The driver can either slow down or maneuver in an attempt to avoid the object. The Impact Alert will only warn and will not actively decelerate or brake the coach when approaching stationary objects.



**WARNING**

Impact Alerts are always operational when the vehicle is running, whether or not ACB is turned on. Active interventions of ACB to maintain safe following distance (throttle reduction, engine brake/retarder application, service brakes application) are only operational when the ACB is engaged with a cruise speed set.

Following Distance Alert (Fda)

Following Distance Alert provides both audible and visual warnings whenever the distance between the coach and the forward vehicle is less than the set distance and getting closer. Once the audible warning is given, the driver must increase the distance between the coach and the vehicle ahead until the audible warning stops or maneuver clear of the forward vehicle.



**WARNING**

Following Distance Alert is always active whenever the coach is moving to a speed greater than 37 mph (60 km/h), whether or not ACB is turned on. Active interventions of ACB to maintain safe following distance (throttle reduction, engine brake/retarder application, service brakes application) are only operational when the ACB is engaged with a cruise speed set.

**BRAKE OVERUSE WARNING**

ACB provides a warning when the system is intervening and using the service brakes excessively. Overuse of the foundation brakes can lead to the brakes overheating and a potential loss of braking performance from brake fade. For example, the use of ACB on downhill runs may cause this alert to be activated. It is recommended that ACB be disengaged on downhill grades. The driver should use appropriate gearing and brake techniques, and not rely on ACB, on downhill grades.



If the driver does not respond to the Brake Overuse Warning after a brief delay, the ACB will switch off.

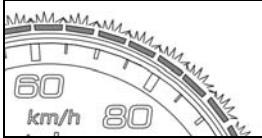
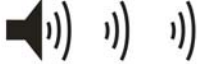

Impact Alert

The Impact Alert warning is the most severe warning issued by the ACB system. This alert indicates that the driver must take immediate evasive action by applying more braking power and/or steering clear of the vehicle ahead to avoid a potential collision.

## 4-16 Controls and Instruments

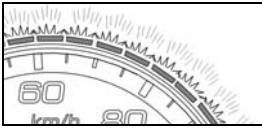
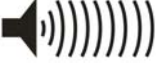
FOLLOWING DISTANCE ALERT	
CONDITION	The Following Distance Alert feature is only available when the coach speed is greater than 37 mph (60 km/h), whether or not ACB is engaged.
	The forward vehicle is slowing down and the distance between your vehicle the coach and the forward vehicle is less than the set distance
ACTIONS BY ACB SYSTEM	<p>“Distance Alert” pop-up message appears on the DID</p>  <p>The speedometer LEDs illuminate in <b>red</b></p>  <p>If the vehicles remain to close from each other for more than 15 seconds, an audible warning will sound (<b>beeping</b>)</p> 

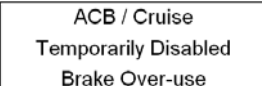
IMPACT ALERT	
SITUATION	ACB system detects a risk of collision with forward moving vehicle or a stationary metallic object in your lane of travel.
ACTIONS BY ACB SYSTEM	<p>On the dashboard, the Forward Vehicle Detected telltale <b>flashes</b> in <b>red</b></p>  <p>“Impact Alert” pop-up message appears on the DID</p>  <p>The speedometer LEDs <b>flash</b> in <b>red</b></p>  <p>An audible warning will sound (<b>continuous modulating tone</b>)</p> 

BRAKE OVERUSE WARNING	
SITUATION	ACB system is using the service brakes excessively to maintain the set following distance (for example, the use of ACB on long, steep downhill runs). Excessive application of the service brakes can cause the brakes to overheat resulting in increasing stopping distances.
ACTIONS BY ACB SYSTEM	<p>After a brief delay, the ACB system will stop functioning and be disabled.</p> <p>On the dashboard, the Forward Vehicle Detected telltale <b>illuminates</b> in <b>red</b></p>  <p>“ACB/Cruise Temporarily Disabled Brake Over-use” pop-up message appears on the DID</p>  <p>“ACB Not Available” pictogram appears on the DID status line</p> 



SELF-DIAGNOSTIC AT START-UP

Initiate the self-diagnostic as follows:

- The engine must be running since at least 15 seconds with parking brake applied.
- Trip the CRUISE rocker switch located on the lateral control panel from OFF to ON position.

The following sequence will begin:

1. Pop-up message “Impact Alert” will show in the DID;
2. The speedometer LEDs will flash in red;
3. FORWARD VEHICLE DETECTED telltale will flash in red;
4. The Impact Alert audible alarm will sound.

At the end of the self-diagnostic sequence, pop-up message « ACB SELF CHECK OK » will show on the DID if the system functions properly or « ACB SELF CHECK NOT OK » if a fault condition is detected.

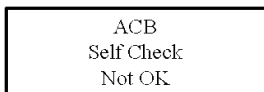
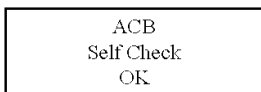

SYSTEM MALFUNCTION

In case of system malfunction, visual warnings will illuminate in the instrument cluster or the driver information display to warn the driver that the ACB is disabled. In that situation, the Impact Alert and Distance Alert functions are not available.

If the ACB is not available, the FORWARD VEHICLE DETECTED telltale light will illuminate in red and will stay on and “ACB NOT AVAILABLE” pictogram will appear on the DID status line.



FORWARD VEHICLE DETECTED telltale light



ACB NOT AVAILABLE pictogram

For proper functioning of the system, the radar must be perfectly aligned and not blocked. If a

radar fault condition is detected, one of the following pop-up messages will show in the DID.

ACB RADAR MISALIGNMENT

ACB RADAR FAULT

ACB RADAR DATA LINK FAILURE

ACB RADAR BLOCKED

TIRE PRESSURE MONITORING SYSTEM (TPMS)

This system is a sensing device designed to identify and display tire operating data and activate an alert or warning when pressure or temperature irregularities are detected.

**NOTE**

*It is the responsibility of the driver to react promptly and with discretion to alerts and warnings. Abnormal tire inflation pressures should be corrected at the earliest opportunity.*

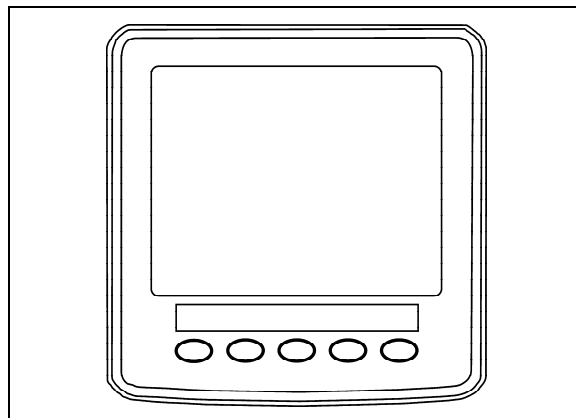

TPMS DISPLAY

06711

TPMS Display

The TPMS display knows where the sensors are located. It receives the raw temperature and pressure readings from the TPMS receiver, it reads several signals from the vehicle and does the calculation required to generate the various screens.

When no readings have been received for a tire location or when the received data corresponds to a parameter range defined as unavailable, then the reading is considered as not available and appears as two dash lines “\_ \_”.

## 4-18 Controls and Instruments

The TPMS display is initially configured to define how many axles and running tires are present on the vehicle. For current Prevost vehicle models, there are two axle / tire configurations. These configurations are:

**Config 1:** Axle 1 (Front) Two tires, Axle 2 (Drive) 4 tires, Axle 3 (Tag) 2 tires.

**Config 2:** Axle 1 (Front) Two tires, Axle 2 (Drive) 2 tires (super Singles), Axle 3 (Tag) 2 tires.

The TPMS display is also configured with several other parameters, including threshold levels for the alarms.

The TPMS display power supply turns OFF when the ignition key is switched OFF.

### Operation

The system will monitor all vehicle tires (6 or 8) plus the spare tire when a spare is supplied.

#### **NOTE**

*Some vehicle models do not come with a spare tire.*

There are two configurations of vehicle tires to be supported. One configuration (the most common) consists of 8 tires total: two tires on the front axle, 4 tires on the drive axle and 2 tires on tag axle. All screen figures shown in this document relates to this vehicle configuration. The second tire configuration consist of 6 tires total: 2 tires on the front axle, 2 tires on the drive axle (super single tires) and 2 tires on the tag axle. The vehicle tire configuration is selected with a parameter (Refer to chapter « SAFETY FEATURES AND EQUIPMENT » for more information). When the display is configured for 6 tires, the drive axle tires appears as one large tire on both side instead of twin tires as illustrated in this document and there is one reading appearing on each side instead of two as illustrated in this document.

### Start-up

When turning the ignition switch to ON, the screen shown below appears on the TPMS Display. Dash lines are displayed meaning that no pressure data have been received by the display.

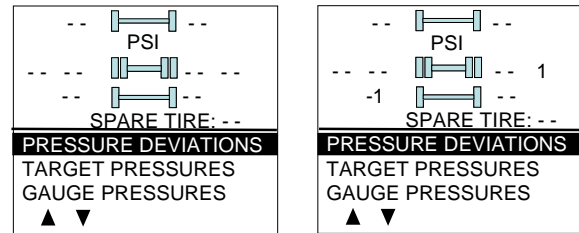

As illustrated, the pressure readings will appear replacing the dash lines as the TPMS display starts to receive pressure data from the TPMS receiver. It can take 1 minute to get all pressure readings updated since the sensors transmit at a one minute interval.

The user can flip through the menus.

### Pre-Trip Check

When one of the preconditions defined to start the pre-trip check is met, the TPMS display enters into a pre-trip check routine and the screen shown below appears. The preconditions to initiate the pre-trip are: Park brake removed Or No activity on the display menu keys for a defined time (Key pressed timeout). After a pre-trip, the display is in a “drive” mode with bottom menu replaced by the alarm status. The display remains in this mode until one of the following occurs: A menu key is touched while the park brake is applied, or the park brake does a transition from released to park brake applied.

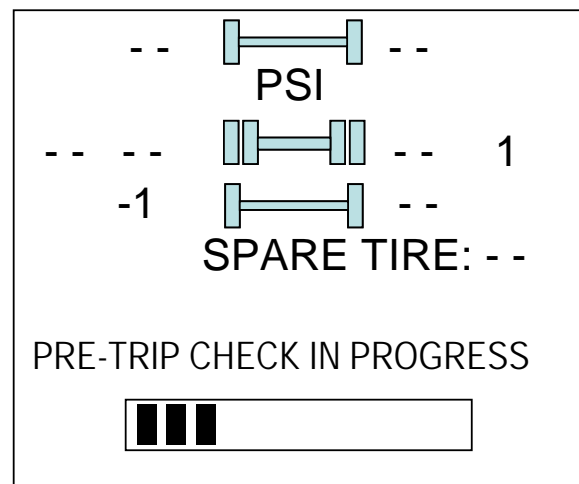

During the pre-trip check, the pressure readings for the different wheels become all available.

The pre-trip check ends, either when the pressure readings have been received for all running wheels or the pre-trip check maximum time has elapsed. It was selected to provide

sufficient time for all wheel sensors to wake-up and send a first reading.

The pre-trip check is aborted and the bottom menu reappears if the park brake was active and the user press one of the menu keys.

Upon completion of the pre-trip check, the TPMS display will come up with one of the screens shown hereafter:

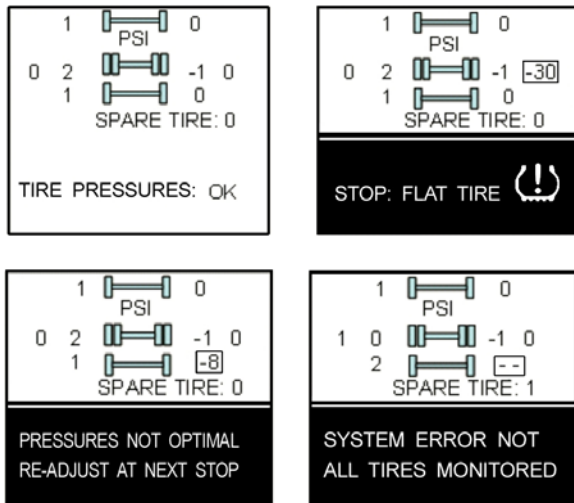

A rectangle around each pressure / temperature reading of the tires that have an issue is blinking to draw the attention to the defective tires.

In the case of multiple errors at the same time, the highest priority error is displayed at the bottom. "Flat Tire" has the highest priority followed by "High Temperature", "Not all tires monitored" and "Tire pressure not Optimal".

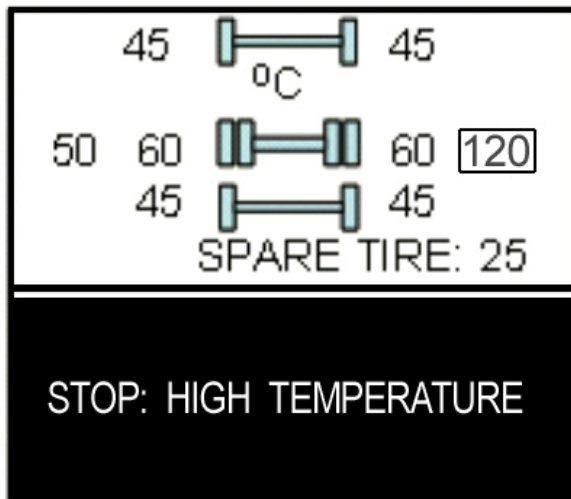

To get the driver's attention to the alarms, the bottom section of the screen where the alarm message appears will blink to reverse contrast

at the following rate: 0.7 sec normal contrast, 0.3 sec reverse contrast. Pressing any key will acknowledge the alarms that are considered as non-critical and stop the blinking of these alarms message for the remaining of the trip. The non-critical alarms are: "Pressure not optimal" and "Not all tires monitored". The "flat tires" and "high temperature" alarms are critical and will keep blinking even when a key is pressed. If a different alarm occurs, blinking will start again. The blinking rectangle around the pressure /temperature readings is not impacted by the acknowledgement and keeps blinking until the error condition disappears.

The spare tire does not contribute to alarms and so never blinks.

On the road, the TPMS display shows one of the 5 previous screens.

In the event of a temperature alarm, the display switches automatically to temperature readings.

The driver can also press any of the menu keys to momentary switch the display to temperature readings. In this case, the temperature reading appears for 15 seconds and the display returns to pressure.

The switching to temperature by pressing a key does not take place if there is an acknowledgeable alarm active, since in this case pressing the key does acknowledge the alarm.

The switching to temperature does not take place either if there is an alarm of Temperature or Flat Tire.

The switching to temperature works when the bottom message indicates either: Tire Pressure OK, Pressure Not Optimal non flashing or not all tires monitored non flashing. When the switch is done to temperature readings, the bottom portion of the screen is not affected and still shows the status message.

**NOTE**  
High temperature is not likely to occur during the pre-trip.

The pressure and temperature readings are continuously updated with the displayed readings of the wheel having issues blinking. The bottom line message is automatically updated to the highest priority alarm prevailing. There is a hysteresis on the alarm levels to assure that the error conditions do not flicker ON and OFF.

## 4-20 Controls and Instruments

On the occurrence of an alarm, a beep will sound. The alarm beep could be turned OFF in the alarm settings menu.

### Spare tire:

The spare tire is monitored but it is not taken into account when setting the bottom alarm messages. This is to prevent unnecessary alarms that would otherwise occur, if for example, the spare tire is removed from a vehicle.

The user will have the possibility to check the pressure of the spare tire by accessing the TPMS display menu. For vehicles that have no spare tires, the title "spare tire" will still appear on the screens but the pressure will remain with two dash lines at all time.

### Post Trip Operation

When parking the vehicle (park brake applied), the TPMS display keep the drive mode display active. The driver can press any keys to get the bottom lines showing the status information replaced with the menus.

The pressure readings are still displayed and updated as new readings are received and the readings are blinking if not within the optimum pressure range.

From this point the user can scroll through the menus to get more detailed information and inflate / deflate the tires to bring them back to their optimum target pressures. Scrolling through these menus is also available prior to departure.

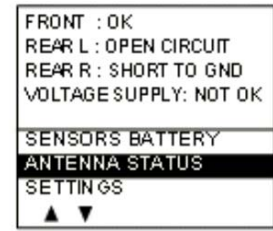
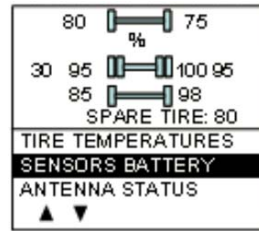

The display remains in this mode with the menus appearing at the bottom until the pre-trip check sequence starts again.

Scrolling down below the Battery life menu will show the Settings menu. Highlighting the Settings and pressing OK allows entering the settings menu. Refer to chapter "SAFETY FEATURES AND EQUIPMENT" for more information on "SETTINGS MENU".

Refer to chapter "Appendix G" for TPMS Troubleshooting Guide.

Highlighting the Exit menu and pressing OK exits the settings and come back to the pressure display mode.

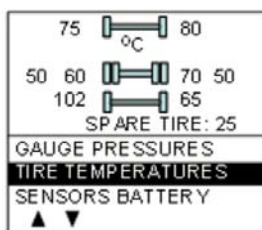
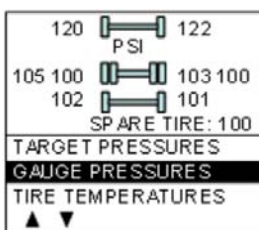
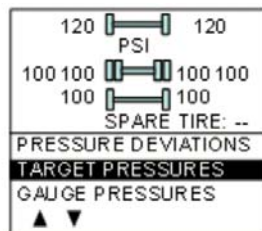
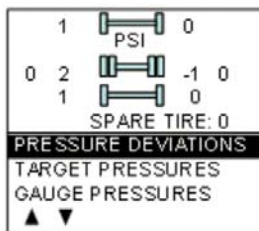
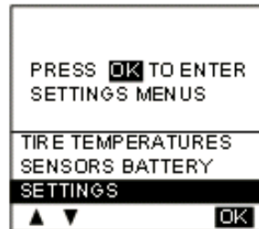

**DASHBOARD**

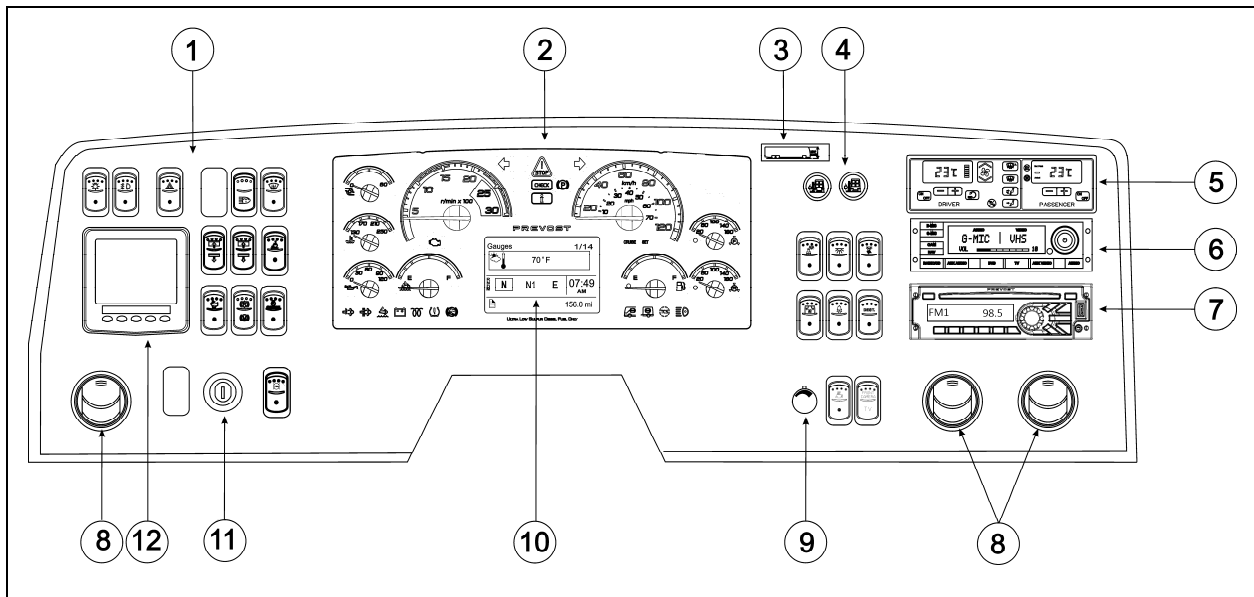

**DASHBOARD**

06761\_3

1. L. H. Dashboard Panel
2. Instrument Cluster
3. Vehicle Clearance Information
4. R. H. Dashboard Panel
5. HVAC Control Unit
6. Audio-video Selector Panel VSS-05
7. AM/FM CD Radio (not equipped)
8. Air Vents
9. Brightness Control
10. Diver Information Display (DID)
11. Ignition Switch
12. Tire Pressure Monitoring System (TPMS) Display

## 4-22 Controls and Instruments

### CONTROL SWITCHES

High quality laser-engraved switches are used to control many of the features of the vehicle. Many switches have an embedded indicator LED to inform the driver at a glance which features are active. Some switches' LED will turn *OFF* after a short while when the engine is running. This is normal and is designed to reduce glare when driving. The functions still operate even if the LED is *OFF*. If the switches are still *ON* when the engine is turned *OFF*, the LEDs will illuminate to warn the driver to turn them *OFF*. Switches are described in the order they appear, from left to right, top to bottom.

### L. H. DASHBOARD PANEL



The L.H. dashboard panel includes controls for the operation of the coach; it also includes the ignition switch and an adjustable air vent.

L. H. DASHBOARD PANEL

06762\_3

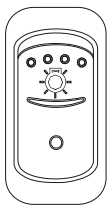

### Headlights and Exterior Lighting

**Off position** – Daytime running lights only

Press this rocker switch to turn on the following lights:

**First position** – Front parking lights, clearance lights, tail lights, license plate lights and marker lights.

**Second position** - Push down fully to turn *ON* the headlights, the controls and instrument lights and all lights from first position.

### **NOTE**

*Daytime running lights will be automatically cancelled when the exterior lighting switch is fully depressed (second position).*

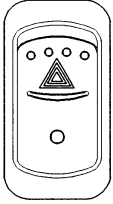

06256

**Hazard Warning Flashers**

Press the rocker switch to make all turn signal lights flash at once. The dashboard telltale lights will flash when the hazard warning flashers are *ON*.



**CAUTION**

Do not use the hazard flashers for an extended period of time unless necessary because the electrical circuits are activated when the hazard switch is depressed.

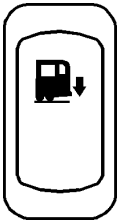

**Rear Axle Load Monitor**

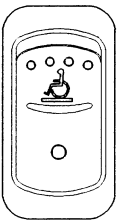

06268

**Wheelchair Lift (Optional)**

Activate the optional wheelchair lift by pressing down on the rocker switch. Refer to “Other Features” section and to wheelchair lift system’s Operator’s Manual for operating instructions.

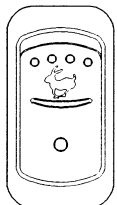

06264

**Fast Idle**

For extended idling periods, run the engine at fast idle. Press down the rocker switch to engage fast idle. This increases the engine speed to approximately 1,000 rpm. Return to normal idle before driving or when stopping engine.



**CAUTION**

Reduce the engine to normal idle before shutting the engine *off*.

**NOTE**

*If the parking brake is released and/or the transmission is engaged with the engine running at fast idle, the engine will return to normal idle and remain there as long as the parking brake is not applied and/or transmission is not placed in neutral (n).*

## 4-24 Controls and Instruments

The engine will return to fast idle once the parking brake is applied or neutral (n) selected.

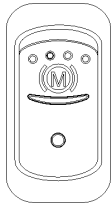

06703

### Engine Brake

The vehicle's engine brake is by default set to automatic (AUTO (A) mode). It is possible to disable the engine brake (OFF mode) using this spring return switch.

Pressing this switch again will enable the engine brake and reset the default mode. Cycling the ignition will have the same effect.

From AUTO mode, the driver can switch to Engine Brake LOW or Engine Brake HIGH mode by using the buttons on the steering wheel. Refer to ENGINE BRAKE in Section 5 Other Features.



06265

### Engine Stop Override (with Automatic Fire Detection and Suppression System)

Press the Engine Stop Override switch on the dashboard or the Delay Engine Stop switch on the AFSS protection panel to delay the engine shutdown and extinguisher discharge by an additional 15 seconds.



### CAUTION

Use this function if you are not prepared to bring the vehicle to a safe stop (i.e. on a railroad track, in intersection).

This switch is functional only if the vehicle is equipped with the Automatic Fire Detection and Suppression System.

## R. H. DASHBOARD PANEL



R. H. DASHBOARD PANEL

06707\_2

The HVAC control module as well as the cluster dimmer switch, interior lighting control switches, entrance door operating buttons as well as miscellaneous control switches and air vents are located on the R.H. dashboard panel.





### Entrance Door Operating Buttons

Press and hold the L.H. button to open the door and the R.H. button to close the door.

06464

Releasing the button at any time will immediately stop door movement.



### WARNING

The door mechanism has no automatic safety protection to avoid injury to bystanders. The driver is responsible for the safe operation of the door.

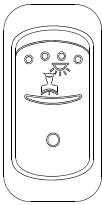

06244

### Driver's Area Lighting

Press the rocker switch to illuminate the ceiling lights in the driver's area as needed.

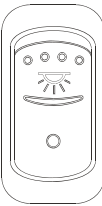

06239

### Interior Lighting

Press this rocker switch to the first position to illuminate the aisle fluorescent lighting. Press down the second position to gradually illuminate the in-station reading lights to 80% of their intensity regardless if they were turned off individually by passengers. Lights will also turn OFF gradually.



### CAUTION

To avoid running down the batteries when the engine is off, turn off the lights or connect the optional battery charger to a 110 - 120 volt AC power supply.

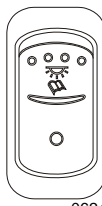

06240

### Reading Lights

This switch powers the reading light circuit enabling passengers to operate their personal reading lights. Refer to "Coach Interior" chapter.

Turning the key or ignition lever to the accessory position "ACC" when the reading lights are on will activate the lights to full intensity, providing a clear view over the entire cabin area.

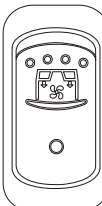

06245

### Passenger Overhead Air Registers With Air Conditioning

Press the switch to the first position to set the fans to low speed. Press the switch to the second position to set the fans to high speed. Activating the fans also engages the dedicated A/C compressor to provide cool air to the passengers through the overhead console air registers.

## 4-26 Controls and Instruments

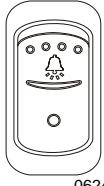

06243

### Stop / Service Chime (Optional)

Press this switch to enable the stop / service chime. When depressed, the service buttons illuminate even when the chime circuit is not enabled.

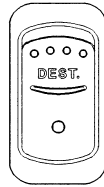

06262

### Destination Sign (Optional)

Press the rocker switch to illuminate the destination sign.



06249

### Brightness Control

Adjusts the brightness of the dashboard instruments and switches.



06240\_1

### Reading Lights Cancel Switch (first rows)

This switch is used to cancel the reading lights in the first two rows. This function is useful to minimize glare in the windshield during night driving.

## HVAC CONTROL UNIT

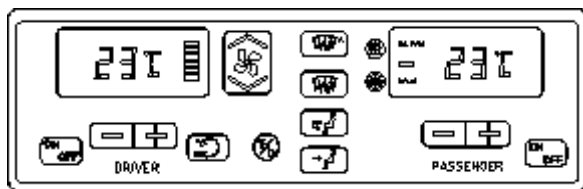

22296

The vehicle is slightly pressurized by the central HVAC system to prevent dust and moisture from entering. Air flow and controls divide the vehicle into two areas: driver's area with defroster and passengers' area.

Fresh air is fed in each area and has a separate return air and discharge air duct.

### NOTE

*To operate the air conditioning system when stationary, run engine at fast idle. When the system is running, keep windows and door closed.*

To prevent battery run-down, the central A/C and heating systems will not operate if the charging system is not working properly.

When the A/C system is running, park at least 4 feet (1,5 m) from other vehicles or buildings to allow sufficient air flow through the condenser core.

Separate driver and passenger heating, ventilation and air conditioning controls are

located on this panel. To operate, the vehicle's engine must be running.

The driver's and the passengers' units may be turned ON by pressing the ON/OFF button.



Also, the driver's HVAC section turns on automatically at starting of the engine and uses the settings that were kept in memory before turning off of the system.

The A/C compressor starts automatically when the two following conditions are satisfied:

1. The outside temperature is above 32°F (0°C).
2. The passenger's area temperature has reached 7°F (4°C) under the set point.

All parameters set before turning the system OFF will be kept in memory for the next power ON.

The HVAC module performs a self-diagnosis every time it is turned ON. Codes are shown on displays or flashed on control buttons. Refer to "Maintenance Manual" for more information on the diagnostic codes.

Heating Mode Indicator



22131

This red LED illuminates when system is heating.

Cooling Mode Indicator



22134

This green LED illuminates when the system is cooling (when the compressor clutch is engaged).

Fan Speed

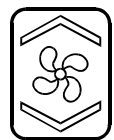

22135

The driver's fan has six speeds. Increase speed by pressing on the upper portion of the button, decrease by pressing on the lower portion.

Recirculate



22138

Closes or opens the driver's and passenger's section fresh air damper.

A red LED in the top right corner of the button illuminates when air is recirculated. Use for faster driver's section heating.

This feature is automatically cancelled when defogging is activated.

Driver's section temperature setting

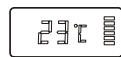

22303

The temperature displayed on the driver's side HVAC control unit is the temperature set point.

To increase the temperature set point, press on the "+" sign, to decrease the temperature set point, press on the "-" sign. Temperature range is between 60°F and 82°F (16°C to 28°C). On the driver's side only, asking for a temperature set point above 82°F (28°C) will keep the coolant valve open and "FUL" will be displayed.

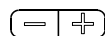

22132

In case of interior temperature sender unit failure, the coolant valve will remain open and three lines "---" will be displayed.

	<h2>WARNING</h2>
<p>Warm temperatures may cause drowsiness and affect alertness while driving. Keep the temperature comfortable but not too high.</p>	

Passenger's section temperature setting

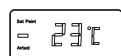

22304

The temperature displayed on the passenger's side HVAC control unit is the actual temperature in the passenger's area.

To increase or decrease the temperature set point in the passenger's area, press on the "+" or the "-" sign. Pressing these buttons will flash the displayed set point and the word "SET" will highlight. Temperature range is between 60°F and 82°F (16°C to 28°C).

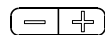

22132

In case of interior temperature sender unit failure, the coolant valve will remain open and three lines "---" will be displayed.

<p><b>NOTE</b></p>
<p>Upon starting, if the outside temperature is above 32°F (0°C) and then drops below 32°F</p>

## 4-28 Controls and Instruments

(0°C), the compressor will keep running up to a temperature of 15°F (-9°C) to prevent condensation from forming on the windows.

### Windshield Defogger

Upon pressing this button, the dashboard damper sends air only to the lower windshield. The fan is turned on to maximum speed, the fresh air damper opens completely (REC off) and the driver set point is increased to 4°F (2°C) over the passenger's section set point.



22305

The dashboard damper sends air only to the lower windshield when activated. The footwell damper is closed also but the fan speed can be reduced or increased.



22139

### Panel and Footwell

The dashboard damper sends air to the panel vents and footwell.

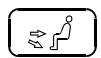

22137

### Panel

Air is sent to panel registers. The footwell damper is closed.

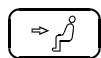

22136

### Temperature Degree Selector

Toggles the HVAV control unit temperature units between Fahrenheit and Celsius. The driver's section must be on. Also toggles the outside temperature units displayed on the telltale panel.



22133

### AUDIO-VIDEO SELECTOR FOR THE PASSENGER'S AREA



The VSS-05 Video and Sound Selector enables the driver to select audio, audio/video and video source with settings of volume level, bass, treble, etc. for the passenger's area only. The

DVD player, TV tuner, P.A. system and auxiliary audio or video sources are controlled with this unit.

### TURNING POWER ON AND OFF

Press  button to turn on the unit.

Press  button again to turn off the unit.

### SETTING OF VOLUME/ BASS/ TREBLE/ BALANCE/ LOUDNESS

**AUDIO**

Press audio button repeatedly to choose the desired mode. Each press changes the modes as follows:

→ **VOL** → **BASS** → **TREB** → **BAL** → **LOUD**

Turn volume knob until the desired sound is obtained in each mode. The final setting will apply to all audio sources for the passenger's area. If no button is pressed within 8 seconds after selecting BASS, TREB, BAL and LOUD modes, the unit automatically sets in the VOL mode. The volume value adjust from 0 (complete mute) to 40 (maximum).

### SELECTION OF AUDIO OR AUDIO/VIDEO SOURCE

**RADIO/CD**

Press RADIO/CD button to select the dashboard radio as current audio source for the passenger's area. Pressing this button will also permit to listen to the CD inserted in the dashboard radio.

**AUDIO IN**

Press AUDIO IN button to select an auxiliary audio input as current audio source. AUDIO IN RCA connections are located at the back of the VSS-05 unit.

**DVD**

Press DVD button to select the in dash DVD player as current audio/video source.

**TV**

If an optional TV tuner is installed, press TV button to select it as current audio/video source.

**VIDEO IN**

Press VIDEO IN button to select an auxiliary video input as current audio/video source.

**NOTE**

If CAM or NAV is already activated, DVD, TV or VIDEO IN cannot be selected and displayed.

OPERATION OF THE OPTIONAL AUDIO-VIDEO MODESTY PANEL

On some vehicles, it is possible to connect and display on the main monitor a laptop or other audio-video equipment (DVD player, gaming console) from an optional audio-video modesty panel located behind the driver's seat.

To do so, connect the laptop to the modesty DB9 connector (9 pins, blue connector), select Video IN on the Video and Sound Selector and turn on the laptop presentation mode.

Devices using RCA connectors (DVD, gaming console) can also be used by connecting them to the 3 modesty RCA connectors and selecting the Video and Sound Selector TV mode.

OPERATION OF THE PANORAMIC VIEW CAMERA

**CAM**

1. Press CAM button to select the optional panoramic view camera signal. The video section of the vss-05 lcd panel will show "CAM". The video monitors turn on automatically.
2. Press CAM button again to turn off the panoramic view camera and return to previous audio/video source.

DISPLAY OF THE GPS NAVIGATION GUIDANCE SCREEN

**NAV**

Not applicable

**NOTE**

When CAM or NAV is selected, the previously selected audio source remains active.

OPERATION OF THE DRIVER MICROPHONE

**D-MIC**

1. Press D-MIC button to turn on the driver microphone. The audio section of the lcd panel will show "D-MIC" and a gong sound can be heard.
2. Turn volume knob to adjust microphone level.

3. Press D-MIC button again to turn off the driver microphone.

OPERATION OF THE GUIDE MICROPHONE

**G-MIC**

1. Press G-MIC button to turn on the guide microphone. The audio section of the lcd panel will show "G-MIC" and a gong sound can be heard.
2. Turn volume knob to adjust microphone level.
3. Press G-MIC button again to turn off the guide microphone.

**NOTE**

BACKGROUND VOLUME ADJUSTMENT

When a microphone is activated, the current audio source volume will reduce to a certain level which has been set at the factory. To adjust this level, proceed as follows:

- 1- Press and hold AUDIO button then press AUDIO IN button. The LCD panel will show "BACK GROUND".
- 2- Turn the volume knob to adjust the background level.
- 3- Press any button to save the setting. If no button is pressed within 8 seconds, the unit automatically saves the setting and exits this mode.

GONG SOUND LEVEL

A gong will sound in the passenger's area upon activating of the microphone. This gong will also sound when a passenger activates the service bell. The gong sound level can be adjusted as follows:

- 1- Press and hold AUDIO button then press VIDEO IN button. The LCD panel will show "GONG PASS".
- 2- Turn the volume knob to adjust the gong level.
- 3- Press any button to save the setting. If no button is pressed within 8 seconds, the unit automatically saves the setting and exits this mode.

**NOTE**

While maintaining the service bell gong active, the gong sound heard upon activation of the

## 4-30 Controls and Instruments

microphones can be disabled. To do so,

- 1- Press and hold audio button then press G-MIC button. The lcd panel will show "GONG-MIC-ON" or "GONG-MIC OFF".
- 2- Turn the volume knob clockwise to activate the microphones gong sound. Turn the volume knob counterclockwise to deactivate the microphones gong sound.

### **NOTE**

Point the remote control in direction of the VSS-05. Remote control battery replacement. Use CR2025 lithium battery.

### USING THE VSS-05 REMOTE CONTROL



#### 1.

Press this button to turn on the unit.

Press this button again to turn off the unit.

#### 2. R/CD, AU IN, DVD, TV, VI IN

Press one of these buttons to select the relevant audio or audio/video source.

#### 3. DMIC

Press DMIC button to turn on the driver microphone.

Press DMIC button again to turn off the driver microphone.

#### 4. GMIC

Press GMIC button to turn on the guide microphone.

Press GMIC button again to turn off the guide microphone.

#### 5. CAM

Press CAM button to select the optional panoramic view camera signal.

Press CAM button again to turn off the panoramic view camera.

#### 6. NAV

Press NAV button to display the optional gps navigation system guidance screen (not applicable).

#### 7. BAS, BAL, TRE, LOUD

Press one of these buttons to select bass, balance, treble and loudness mode.

#### 8. +, -

Press these buttons to increase or decrease the value for bass, balance, treble and loudness mode.

## AIR VENTS

Three adjustable driver air vents in the dashboard and one near the door feed air to the driver's compartment. Use the HVAC control panel to set air temperature and fan speed.

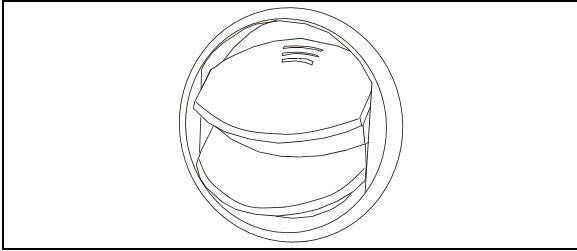

AIR VENT

### INSTRUMENT CLUSTER

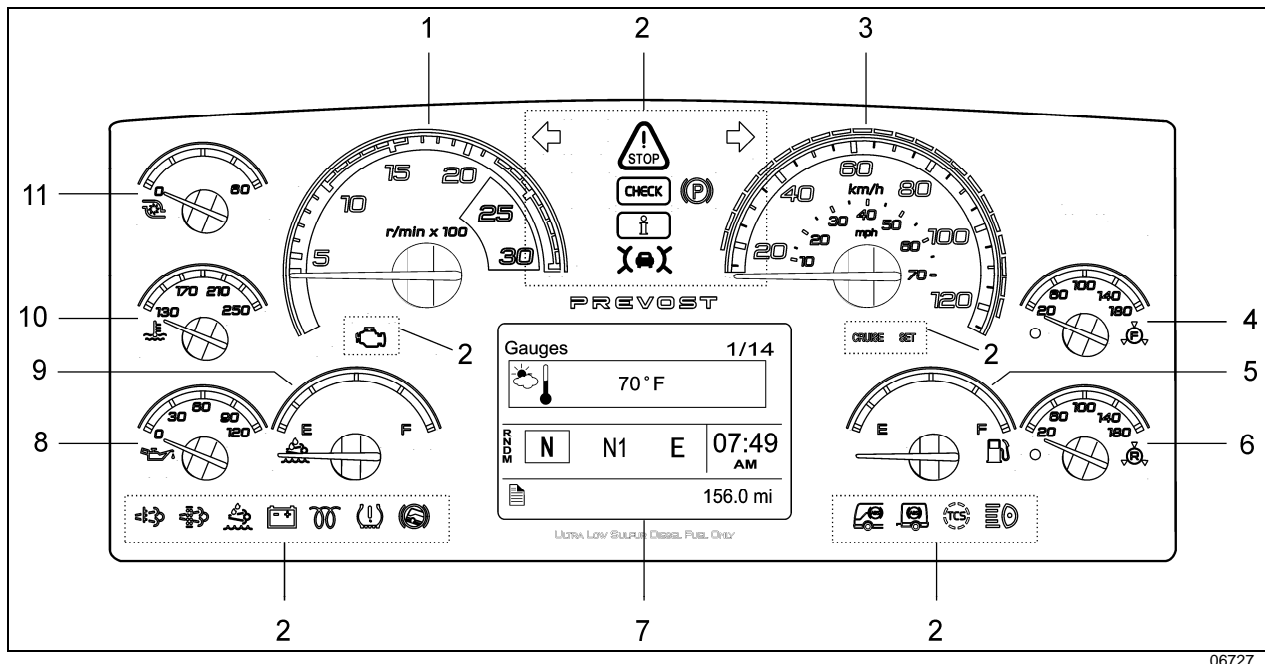

06727

1. Tachometer
2. Telltale lights
3. Speedometer
4. Front brake air pressure (secondary)
5. Fuel level
6. Rear brake air pressure (primary)
7. Driver Information Display (DID)
8. Oil pressure indicator
9. DEF level (Diesel Exhaust Fluid) indicator
10. Engine coolant temperature
11. Turbo boost pressure

The instrument cluster includes the analog instruments. It also presents two devices to communicate information to the driver, the telltale lights and the Driver Information Display (DID).

Indications and warnings are presented according to three levels of attention required:

#### 1. THE TELLTALE LIGHTS

The highest level of attention. The telltale lights are temporary and exceptional; they present information critical to safety or vehicle integrity.

#### 2. POP-UP MESSAGES

The second level of attention. Pop-up messages appear in the Driver Information Display DID without the driver's intervention and

acknowledgement. Pop-up messages present supplemental information to the driver.

#### 3. THE STATUS LINE

The lowest level of attention. The status line monitors certain systems and gives feedback to the driver concerning current actions and functions.



ANALOG INDICATORS

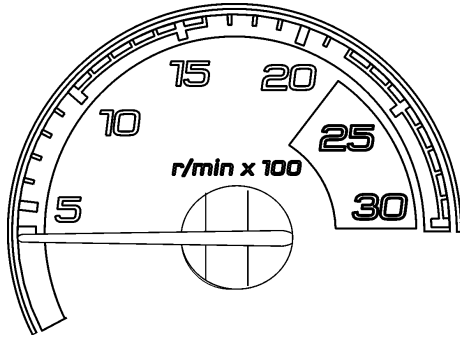

06728

**TACHOMETER (RPM X 100)**

Indicates the operating speed of the engine in hundreds of revolutions per minute. The tachometer serves as a guide for gear shifting and helps to prevent engine over-speeding when driving downhill with the engine brake operating. Use the green field for normal driving (1000 to 1600 rpm).

	<p><b>CAUTION</b></p> <p>Never allow the engine to go into the red field. This could lead to severe engine damage.</p>
---	--

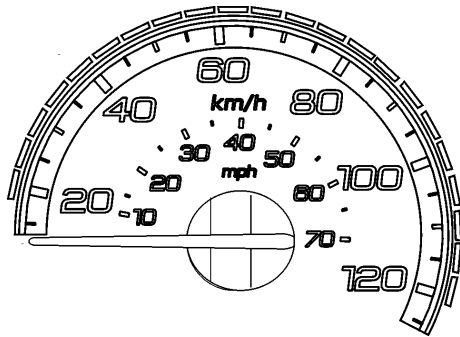

06729

**SPEEDOMETER (MPH, KM/H)**

Indicates the vehicle speed in miles per hour (mph) and kilometers per hour (km/h). The LEDs above the instrument work in conjunction with AWARE Adaptive Cruise Braking (ACB) system. Refer to “Prevost AWARE Adaptive Cruise Braking” paragraph.

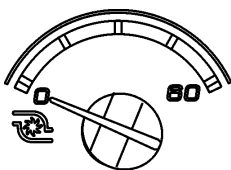

06730

**TURBO BOOST PRESSURE (PSI)**

Indicates the turbo boost pressure in psi. This pressure should be the same at a given engine temperature, speed, and load. An unusual reading could indicate an engine failure.

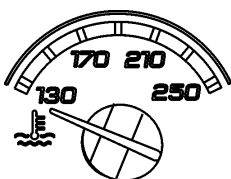

06731

**ENGINE COOLANT TEMPERATURE (°F)**

Indicates the operating temperature of the engine coolant in °f. The normal reading should be between 170°f and 222°f (80°c to 106°c).

The temperature limit is dependent on the electronic program for the engine model. When coolant temperature is excessive, the stop telltale light turns on, an audible alarm sounds and a pop-up message appears on the DID. The engine protection system will automatically derate and stop the engine in 30

seconds. Stop at the first safe place where the problem can be checked.  
 If the temperature remains below or exceeds the normal temperature range, the cooling system should be checked for problems.



STOP TELLTALE LIGHT

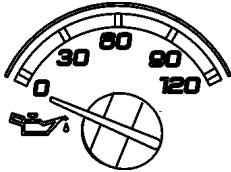

06732

**ENGINE OIL PRESSURE (psi)**

Indicates the engine oil pressure in psi. When the oil pressure is too low, the stop telltale light turns on, an audible alarm sounds and a message appears on the DID. The engine protection system will automatically derate and stop the engine in 30 seconds. Bring the vehicle to a safe stop where the problem can be checked.



STOP TELLTALE LIGHT



OIL PRESSURE PICTOGRAM



**WARNING**

Failure to take necessary action when the stop telltale light is on can ultimately result in automatic engine derate and shutdown.

**Front Brake Air Pressure (Psi) – Secondary System**

Indicates the front brake air system pressure in psi. The normal operating pressure is from 122 to 140 psi.

A low air pressure indicator LED illuminates when the front air system pressure drops below 85 psi. If the air pressure drops further, the STOP telltale light will turn on, an audible alarm will sound and a message will appear on the DID. If the air pressure drops below 60 psi, the emergency spring brake applies at full capacity.

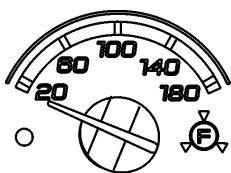

06737



**WARNING**

Do not drive the coach when the brake air pressure is low.

**NOTE**

Do not refer to dashboard instruments during adjustment procedures. Use only calibrated gauges.

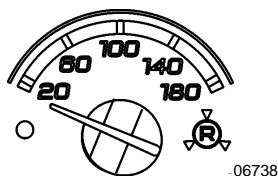

**Rear Brake Air Pressure (Psi) – Primary System**

Indicates the rear brake air system pressure in psi. The normal operating pressure is from 122 to 140 psi.

A low air pressure indicator LED illuminates when the rear air system pressure drops below 85 psi. If the air pressure drops further, the STOP telltale light will turn on, an audible alarm will sound and a message will appear in the DID. If the air pressure drops below 60 psi, the emergency spring brake applies at full capacity.



STOP telltale light

 <b>WARNING</b>
Do not drive the coach when the brake air pressure is low.

**DEF level**

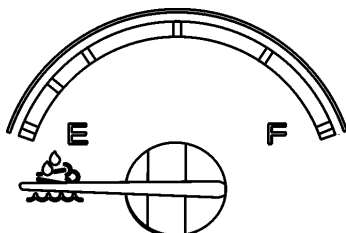

06735

Indicates the amount of DEF (diesel exhaust fluid) remaining in the DEF tank. The DEF tank is considered as being full when it contains 16 gallons (60 liters) of DEF. DEF consumption will be approximately 2% of the diesel fuel consumed.

 <b>CAUTION</b>
DEF will begin to crystallize and freeze at 12°f (-11°c). DEF expands by approximately 7% when frozen. In order to permit DEF expansion without causing damages to the DEF tank, do not fill the DEF tank with more than 16 gallons (60 liters).

**Fuel Level**

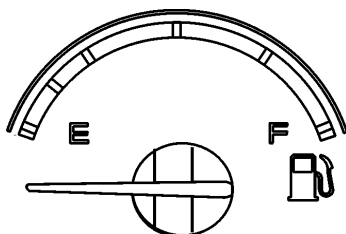

06736

Indicates the amount of fuel remaining in the fuel tank. At the beginning of the red area, there is approximately 48 gallons (182 liters) left in the tank.

<b>NOTE</b>
A pop-up message will appear in the DID informing that there is only 24 gallons (92 liters) left in the fuel tank.

### TELLTALE LIGHTS

The telltale lights illuminate during 5 seconds at the start of every ignition cycle as a light bulb check.



#### Stop

Indicates that a serious problem has been detected. Immediately park the coach in a safe place and stop the engine. This telltale light may be accompanied with a message in the DID and a diagnostic troubleshooting code will be stored to ease identification of the problem. **WARNING:** Failure to take necessary action when the STOP telltale light is on can ultimately result in automatic engine derate and shutdown.



#### Check

Indicates that a problem has been detected and must be checked at the next stop. This telltale light may be accompanied with a message in the DID and a diagnostic troubleshooting code will be stored to ease identification of the problem.



#### **FORWARD VEHICLE DETECTED – ADAPTIVE CRUISE BRAKING**

When the ACB is engaged with a cruise speed set and the forward vehicle is in range, the FORWARD VEHICLE DETECTED telltale light illuminates, indicating the ACB system is actively tracking the forward vehicle.

**GREEN:** The vehicle ahead of you is detected by the radar.

**FLASHING RED:** Impact alert. The vehicle ahead of you is too close. The driver must take immediate evasive action by applying more braking power and/or steering clear of the vehicle ahead to avoid a potential collision.

**RED:** System malfunctions. The Adaptive Cruise Braking is not available.



#### Information

This telltale light illuminates when there is a new information message or an abnormal status is detected by the electronic control unit. A pictogram, text or both are shown in the DID in addition to the info telltale light. Make sure the indicated fault is checked at the next stop.



#### Turn signal indicators

Flashes when the right or left turn signals are activated. Signal right and left turns by operating the multi-function lever. See “Steering Column Controls” in this chapter.

#### **NOTE**

The turn signals are automatically activated when the vehicle is backing up.



Parking brake or emergency brake applied

Illuminates when the emergency/parking brake is applied. The control valve is located on the L.H. control panel. An audible alert will sound if ignition is turned to off and the parking brake is not engaged.



Aftertreatment system malfunction (Malfunction Indicator Lamp)

Indicates a failure of an emission control device. May illuminate at the same time as the CHECK amber warning light. The lamp will go out after 3 completed ignition on-ride-ignition off cycles. Vehicle can be driven to end of shift. Call for service.

**CRUISE**

Cruise control

Indicates that the cruise control is enabled.

**SET**

Cruise control set speed

Indicates that a cruising speed is set and stored in the memory.



High exhaust system temperature (HEST)

06740\_A

Illuminates to notify the driver of potentially hazardous exhaust gas temperature at the exhaust system diffuser.



**WARNING**

During regeneration, exhaust temperature may reach up to 1200°f (650°c) at the particulate filter. When parking the vehicle, if this telltale light is illuminating, make sure that the exhaust system diffuser is away from people or any flammable materials, vapors or structures.



DPF regeneration request

06740\_B

Illuminates to notify the driver that a manual stationary regeneration will be required soon. Refer to "Exhaust Aftertreatment System" paragraph in Other Features chapter.



Low DEF level

06740\_C

Illuminates when there is less than 2.6 gallons (10 liters) of DEF left in the tank.



**CAUTION**

This telltale light starts flashing when there is only 2.5 liters (0.6 gallons) left in the tank.

If the vehicle is kept in operation with an empty DEF tank, and engine derate will eventually occur, limiting the speed to 5 mph.



CHARGING SYSTEM WARNING LIGHT

06740\_D

Indicates a malfunction of the charging system or a low battery voltage condition.

**NOTE**

To identify if an alternator is defective (1=lower alternator, 2=upper alternator), perform a system diagnostic using the Driver Information Display DIAGNOSTICS menu. Select VIEW ACTIVE FAULTS and then ELECTRICAL SYSTEM. Scroll through the active faults. The electrical system active faults will appear. A diagnostic message indicating “alternator 1” or “alternator 2” with failure mode “open circuit” will come in sight.



Intake air preheater on – wait before starting

06740\_E

Illuminates when the intake air preheater element is in function. Wait until this telltale light has turned off before starting the engine. For more information on this feature, refer to paragraph “Cold Weather Starting” in Starting And Stopping Procedures chapter.



Flat tire (with optional tire pressure monitoring system)

06740\_F

Illuminates when a tire pressure is 25% below the target tire pressure.



Hill start assist

06740\_G

Indicates a malfunction of the hill start assist function. This function might not be available.



06740\_H

Antilock brake system (ABS)

Illuminates when the ABS is not available or when the ABS is malfunctioning. Since the ABS system does not operate at less than 4 mph (7 km/h), the indicator will remain illuminated until the coach reaches that speed. Refer to Other Features chapter.



06740\_I

Trailer antilock brake system (ABS)

Illuminates when the trailer ABS is not available or when the trailer ABS is malfunctioning.



06740\_AA

TCS/ESC - Traction Control System and Electronic Stability Control

At vehicle ignition, TCS/ESC telltale lamp illuminates for approximately 3 seconds and then turns off. If it remains on steadily (not flashing) after ignition, or if it illuminates steadily while you are driving, the TCS or ESC system may not be fully functional or their operation may be completely disabled. If this happens, your vehicle will still have normal service braking and it still can be driven, although without the benefits of TCS or an ESC system.

**Flashes slowly** when TCS's Mud/Snow mode is turned on using the Mud/Snow switch.

**Flashes quickly** when ESC or TCS intervenes to reduce risk of loss of control.



06740\_K

High beam

Illuminates when the high beams are selected. High and low beams are selected with the multi-function lever. Refer to "Steering Column Controls" paragraph in this chapter.

STOP, CHECK AND INFORMATION  
TELLTALE LIGHTS

STOP, CHECK and INFORMATION telltale lights illuminate automatically to draw the attention of the driver and their associated messages are displayed in the DID. More than one message (see "Acknowledging Messages" below) can be active at the same time. A displayed message can be replaced by a new message provided the new message has a higher priority. Only fault codes that have a direct impact on vehicle operation are displayed. All fault codes are stored in the appropriate ECU for access by service technicians.

STOP Telltale light

In the event of a serious fault, the red STOP telltale light comes on and an audible alarm will sound if the engine is running. An illuminated stop message light indicates a serious problem has been detected, and the driver must respond immediately to the problem.



When illuminating, this telltale light means the vehicle must be safely pulled off the road and stopped. In some instances, the engine must be switched off immediately.

**WARNING**

Failure to stop and take necessary action when the stop telltale light is on can result in automatic engine derate and shutdown.

In some cases preventive action may be taken by the engine ECU to protect the engine. For further details, refer to “Engine Protection System” in *Starting and Stopping Procedures*.

CHECK Telltale light

This telltale light means that a fault or an abnormal operating condition has been detected. The vehicle must be checked at the next stop.



If the CHECK telltale light illuminates, an associated message is displayed in the DID. Always pay attention to the associated messages (see “Acknowledging Messages” below).

INFORMATION Telltale light

The INFO indicator light comes on when there is a new information message or an abnormal status is detected by the electronic control unit. A pictogram or text or both are shown in the DID in addition to the INFO telltale light (see “Acknowledging Messages” below).



Acknowledging Messages

A fault message associated to a STOP, CHECK or INFORMATION telltale light must be acknowledged by pressing the ESCAPE or ENTER button after which the display returns to the same status that existed before the fault occurred. All messages can be acknowledged. Acknowledged but inactive messages are displayed again when the ignition key is turned to the START position or they can be read in the DID menu. Refer to *Other Features* for more information on the DID menus.

DRIVER INFORMATION DISPLAY

The DID (Driver Information Display) is located in the center of the instrument cluster. It displays digital gauges, main menus and sub-menus that provide necessary and important information to the driver. The information available to the driver depends on vehicle configuration, and whether the vehicle is in operation or parked. For the list of the available menus and sub-menus, refer to “Driver Information Display Menus” in *Other Features* chapter.

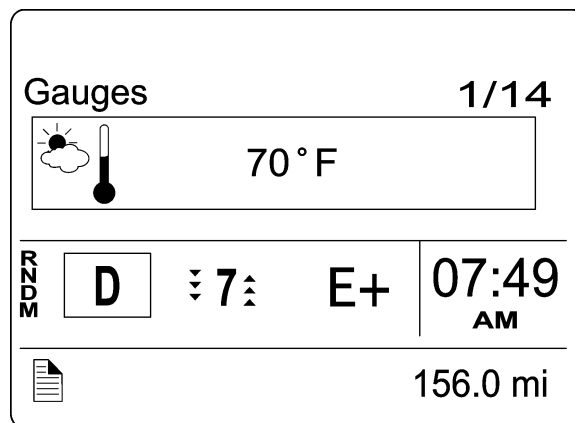

06746

The outside air temperature, fuel flow and the odometer (Allison transmission) are part of the default display. You can replace the default display by your selection of favorite gauges using the Driver Information Display sub-menu Favorite Display Setting. Refer to *Other Features* chapter for more information.

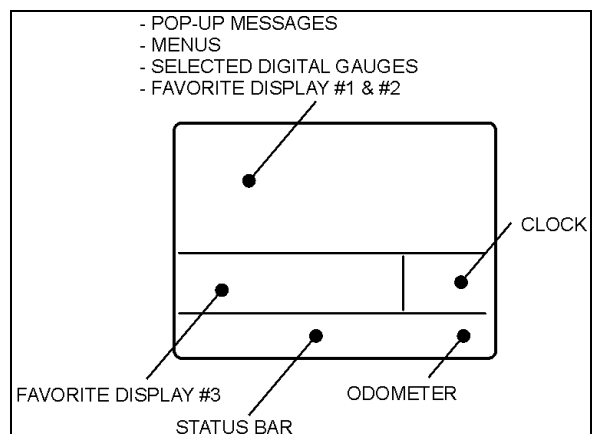

06742



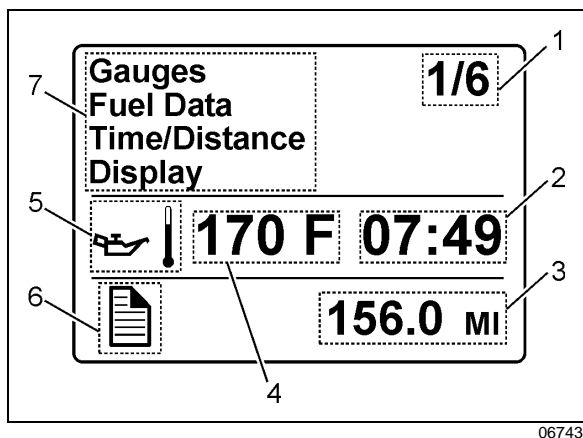

1. Indicates first of six available menus (varies by menu)
2. Clock
3. Odometer
4. Value or data (in this example, the engine oil temperature)
5. Pictogram relevant to the displayed value or data
6. Status bar active pictogram
7. Messages or available menus

#### Selecting a menu

Menus are placed in a cascade arrangement. Use the steering wheel controls buttons to scroll through them.

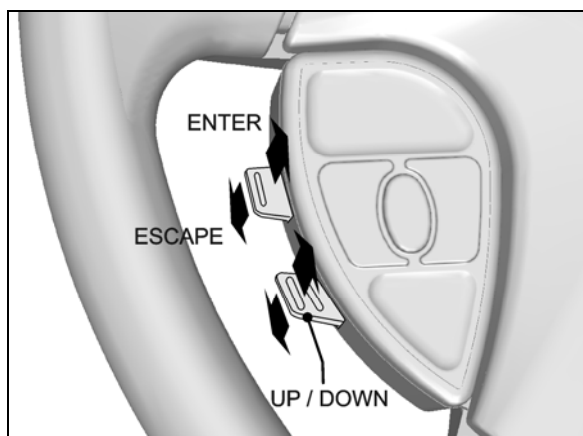

14069\_3

To select a menu:

1. Press the ENTER or ESCAPE button to display the list of available menus.
2. Use the UP/DOWN button to scroll up or down through the menus.
3. Use the ENTER button to open a menu.
4. Use the ESCAPE button to return to the previous menu or display or to cancel a setting or operation.

To change settings

To change a setting, like the clock for example:

5. Use the UP/DOWN button to increase or decrease the numerical value of the selected field.
6. Use the ENTER button to confirm your choice and to move to the next field.
7. Press the ESCAPE button to return to the previous field or to cancel a setting or operation.

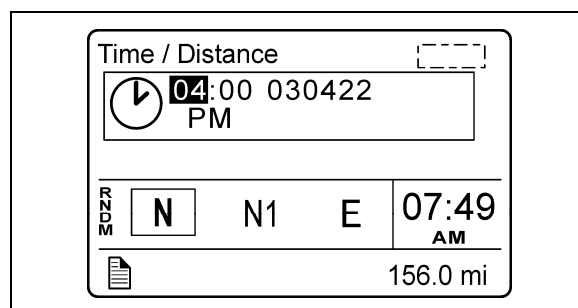

06743

Scrolling through the menus without using the steering wheel buttons

In case of failure of the steering wheel buttons, it is still possible to gain access to the menus or acknowledge the pop-up messages to return to the default display.

This alternate mode is possible only if the steering wheel buttons are faulty.

To enable the alternate mode:

1. Apply the parking brake;
2. Depress and hold the service brake pedal.

## 4-42 Controls and Instruments

---

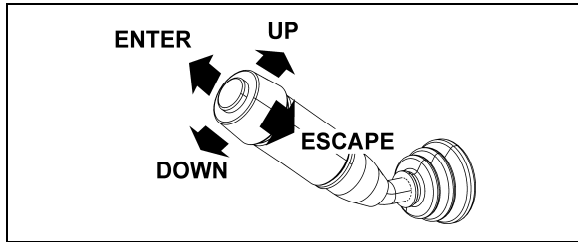

**MULTI-FUNCTION LEVER**

In alternate mode, use the multi-function lever as follows:







- Move the lever up = UP
- Move the lever down = DOWN
- Push the lever away from you = ENTER
- Pull the lever towards you = ESCAPE









PICTOGRAMS DISPLAYED ON THE DRIVER INFORMATION DISPLAY (DID)

**NOTE**

In certain situations, the pictogram displayed represents a system or a function of the vehicle. A particular pictogram may be displayed with different messages. In that situation, it is very important to pay attention to the message displayed with the pictogram.

Warning pictograms, pop-up message pictograms, verifications and information pictograms

DRIVER INFORMATION DISPLAY “GAUGES” MENU PICTOGRAMS	
PICTOGRAM	Description
	<b>Engine oil temperature</b>
	<b>Outside air temperature</b>
	<b>A/c compressor pressure</b> This pictogram is displayed with A/C compressor suction pressure value (low side) and discharge pressure value (high side).
	<b>Accessories air pressure</b> Normal pressure should be between 122 and 140 psi
	<b>Voltmeter</b> This pictogram is displayed with both the 12-volt and 24-volt electrical system current voltage value. When the engine is running, the 24-volt electrical system voltage value should be between 26,5 et 28,0 volts.
	<b>Battery State Of Charge</b> Displays the level of charge for the 12v and 24v battery banks
	<b>Transmission oil temperature</b>

POP-UP MESSAGES	
PICTOGRAM	Description
	<b>High engine oil temperature</b>
	<b>Engine coolant temperature</b>
	<b>Engine oil pressure</b>
	<b>Intake air preheater failure</b>
	<b>Engine temperature too low for Volvo engine brake (VEB) operation</b>
	<b>High transmission oil temperature</b> This pictogram indicates that the transmission oil temperature is too high. Turn the transmission retarder off to allow the oil to cool down.
	<b>Allison transmission– oil or filter replacement required</b> This pictogram may be displayed with many different messages. Pay attention to the displayed message which can advise that the transmission oil or filter change is necessary. Refer to appendix C for more information on the Allison transmission prognostic features (oil life monitor, filter life monitor, transmission health monitor).
	<b>Trailer braking system low air pressure / trailer parking brake</b> This pictogram appears when the trailer emergency/parking brake is unexpectedly applied as when the vehicle is moving and a parking brake air line rupture happens.
	<b>Low brake or ABS air pressure</b>



**A/C system pressure high**

This pictogram indicates that the a/c system pressure is too high. If the a/c pressure is too high, the compressor clutch is disengaged, but the fan remains activated.

**NOTE**

When outside temperature is high, it is possible and normal for that pictogram to appear.



**A/C system pressure low**

This pictogram indicates that the A/C system pressure is too low. If the A/C pressure is too low, the compressor clutch disengages and the fan stops.

**NOTE**

When outside temperature is low, it is possible and normal for that pictogram to appear.



**Compressor/air dryer fault**

This pictogram indicates that a risk of water in the pneumatic system has been detected due to a compressor or air dryer related problem. Possible causes are:

- Compressor is used at an unusual (high) rate.
- A fault with the air system has been detected.

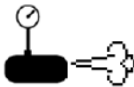

**Air leakage**

This pictogram indicates that an air leak has been detected in the pneumatic system.



**Battery voltage warning**

This pictogram indicates that the battery voltage is too high, too low or the 12V/24V battery arrangement is not equalized.

The value low or high is displayed at the right of the pictogram to indicate if the voltage is too low or too high.

**NOTE**  
This pictogram will illuminate for a few seconds after the engine is started because of the voltage drop when the starter is engaged.

**NOTE**  
This pictogram may appear as a reminder to connect the battery charger if the ignition switch is left in the "ON" position *for twenty minutes* with engine not running and parking brake set.

**NOTE**  
To identify the battery problem (too high, too low or not equalized voltage), using the DID menus, perform a system diagnostic by selecting DIAGNOSTIC, VIEW ACTIVE FAULTS, ELECTRICAL SYSTEM and see the fault messages.

**NOTE**  
To prevent discharge of the batteries when the engine is not running, some functions are automatically switched off if the batteries voltage drops below 24.0 volts for more than 30 seconds. Set the ignition key to the OFF position and then turn the ignition key to the ON position to reactivate the functions for a period of 30 seconds before they switch off again.

**NOTE**  
If the battery equalizer indicator illuminates, make sure that the battery equalizer circuit breakers are reset before requesting breakdown assistance. Wait 15 minutes after setting breakers to allow batteries to equalize. The breakers are located on the rear junction panel, on the engine compartment R.H. side.



**Engine door ajar**

This pictogram indicates that the engine compartment door is ajar.



**Emergency window open**

This pictogram indicates that an emergency window is open or unlocked.



**Baggage compartment door ajar**

This pictogram indicates that one or more baggage bay doors are ajar.



**Low windshield washer or headlights washer fluid level**

Illuminates when the windshield washer or the headlight washer fluid level is low. The washer fluid containers are located inside the front service compartment.



**WARNING**

Do not drive without sufficient washer fluid.



**Wheelchair lift**

This pictogram indicates that the wheelchair lift system is enabled and the wheelchair access door or the lift compartment door is open. It is necessary to stow the wheelchair lift, close the doors and set the wheelchair lift system enable switch to the off position to permit release of the parking brake.



**Lavatory occupied**

This pictogram indicates that the lavatory compartment is occupied. This pictogram will appear only when the engine is shut down in order to advise the driver of the presence of a passenger in the lavatory compartment during a stop.



**Lavatory compartment emergency call**

If the vehicle is moving, this pictogram indicates that a passenger has activated the lavatory compartment emergency call button.



**Differential lock (option)**

This pictogram indicates that the differential action is locked.



**Freezing conditions**

This pictogram appears when the temperature is in the range between 0°C and 2°C (32°F and 35°F), when the road is most slippery.



**Fuel level**

This pictogram appears when approximately 24 US gallons (92 liters) of fuel remains in the tank. Refuel as soon as possible.



**Automatic traction control**

This pictogram appears when the automatic traction control system intervenes to prevent excess wheel spin during acceleration.



**Parking brake applied**



**DPF regeneration**



**High exhaust gas temperature**

This pictogram appears to notify the driver of potentially hazardous exhaust gas temperature at the dpf outlet.

	<p><b>WARNING</b></p>
<p>During regeneration, exhaust temperature may reach up to 1200°F (650°C) at the particulate filter. When parking the vehicle, if this pictogram is displayed, make sure that the DPF outlet diffuser is away from people or any flammable materials, vapors or structures.</p>	



**Fuel economy**

This pictogram is displayed with fuel consumption value of the vehicle. Proper units for the displayed value are written under the pictogram: liters/100km, km/liter, mpg, liters/hour.



**Part of trip made using “free” electricity**

Percentage besides this pictogram represents percentage of trip made with electricity generated when braking or decelerating.



**Leg fuel consumption**

This pictogram is displayed with the value for the fuel consumption for the current leg.



**Trip data**

Function of the DID’s “Time/Distance” menu. Refer to “Driver Information Display Menus” in *Other Features* chapter.



**Estimated time of arrival**

Function of the DID’s “Time/Distance” menu. Refer to “Driver Information Display Menus” in *Other Features* chapter.



**Fuel filter/water separator**

Indicates that the draining the fuel Filter/Water separator is required. See *Care And Maintenance* chapter.





**Raised tag axle**

This pictogram appears if the vehicle speed exceeds 12 mph (20 km/h) while the tag axle is raised.



**Low buoy**

This pictogram appears if the vehicle speed exceeds 12 mph (20 km/h) while the front suspension of the vehicle or the entire vehicle suspension is lowered.



**Cooling fans low voltage**

This pictogram indicates that battery voltage is too low for proper fan operation.



**FIRE IN ENGINE COMPARTMENT**

This pictogram appears if a fire is detected in the engine compartment while the vehicle is on the road. An audible alarm informs the driver when a fire is detected. In case of fire detection when parked (parking brake applied, engine running or not), the electric horn is activated to alert the driver. Refer to *Safety Features And Equipment* Chapter.



**WARNING**

In case of a fire, stop the vehicle immediately, stop the engine and evacuate the vehicle.

**NOTE**

*It is possible to cancel an alarm while on the road. To do so, stop the vehicle. , perform this ignition switch (key) sequence.*

- From the **ON** position,
- Turn to **OFF**, return to **ON** and **START** vehicle within 2 seconds.

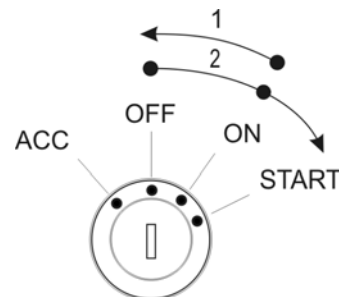

**NOTE**

*To stop the electric horn alarm when parked, cycle the ignition between the on and off position twice within 3 seconds.*

Status Line Pictograms

PICTOGRAM	DESCRIPTION
	<b>MESSAGE ACTIVE</b>
	<b>ALARM CLOCK ACTIVATED</b>
	<b>RAISED TAG AXLE</b>
	<b>KNEELING/FRONT SUSPENSION HI-BUOY ACTIVE</b> This pictogram appears if the vehicle speed exceeds 12 mph (20 km/h) while the front suspension of the vehicle (kneeling – solid ON pictogram) or the entire vehicle suspension is lowered (low buoy – blinking pictogram).
	<b>BAGGAGE COMPARTMENTS LOCKED</b> Indicates that all the baggage compartment doors are locked.
	<b>BAGGAGE COMPARTMENTS UNLOCKED</b> Indicates that at least one baggage compartment door is unlocked.
	<b>ADAPTIVE CRUISE BRAKING (ACB) NOT AVAILABLE</b> Indicates that the adaptive cruise braking system is disabled.
	<b>ENGINE BRAKE</b> Engine brake is disabled (OFF mode).
	<b>ENGINE BRAKE</b> Indicates that the engine brake is in the AUTO mode. When using this mode, the engine brake is activated when pressing on the brake pedal. The engine brake is by default set to AUTO mode when the vehicle ignition switch is cycled from OFF to ON position.
	<b>ENGINE BRAKE – ENGINE BRAKE LOW (1) AND ENGINE BRAKE HIGH (2)</b> Indicates which engine braking power is selected with the steering wheel control buttons.
	<b>ALLISON TRANSMISSION RETARDER</b> Indicates that the Allison transmission retarder is off.

Status Line Pictograms Contd.

①...⑥ **ALLISON TRANSMISSION RETARDER – BRAKING LEVEL 0, 1, 2, 3, 4, 5, 6**  
 Indicates the retarder hand lever position. Each position corresponds to a given braking level. Refer to “transmission retarder” heading in this chapter.

VEHICLE CLEARANCE INFORMATION

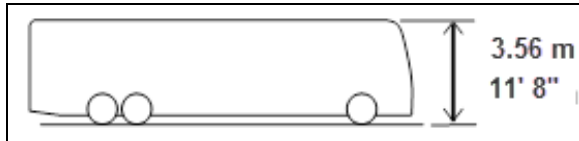

Safe vehicle clearance height is 11'8" (3.56 m).

**CAUTION**  
 Vehicle clearance is higher when the ventilation hatch is open, hi-buoy is selected or if additional equipment is installed on the roof.

STEERING COLUMN CONTROLS

Many of the most frequently used controls are conveniently placed on the steering column or the steering wheel, just like a passenger car. The multi-function lever is located on the left side of the steering wheel while the optional transmission retarder lever is located on the right side of the steering wheel. Switches for the electric horn and the air horn are located directly on the steering wheel.

MULTI-FUNCTION LEVER

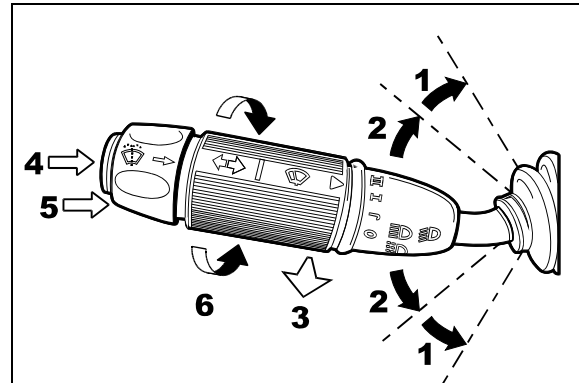

MULTI-FUNCTION LEVER

23133

The multi-function lever is used to operate the following:

Turn Signal (1)

Move the lever all the way up until it locks in position to signal a right turn. Move the lever all the way down until it locks in position to signal a left turn. The lever automatically returns to the horizontal OFF position once the turn is completed.

Lane Change Signal (2)

Move the lever part way to the catch position and hold until the lane change maneuver is completed. The lever will spring back into the OFF position once released.

Headlight Beam Toggle Switch (3)

Toggle between high and low beams by pulling the lever up towards you. To flash the headlights, pull the lever up halfway. The lever will spring back into normal position once released.

## 4-52 Controls and Instruments

---

### Courtesy Blinkers (4)

Clearance and parking lights can be flashed by pressing the button located on the lever tip.

### Windshield Washer Control (5)

Push the external ring at the end of the lever toward the steering column to activate the windshield washers. The wipers come ON and continue wiping for a few seconds after the ring is released.



#### **WARNING**

Before using the windshield washers in cold weather, heat the windshield with the defroster to prevent icing and reduced visibility.



#### **CAUTION**

To avoid damaging the pump mechanism, do

not use the windshield washer when the fluid level is very low or empty.

### Windshield Wipers (6)

Turn the lever counterclockwise to activate the windshield wipers. The first position activates the wipers intermittently. The second position is the slow speed and the third position is for high speed wiping.



#### **CAUTION**

To avoid scratching the windshield, do not operate the wipers when the windshield is dry. To avoid damaging the wiper motor, free wiper blades that may be frozen to the windshield before operating the wipers.

STEERING WHEEL CONTROLS

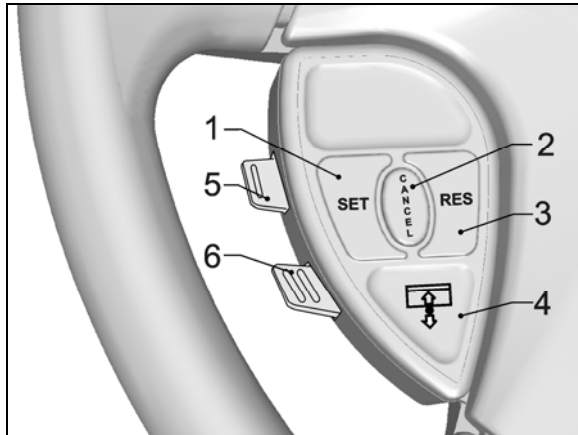

LEFT STEERING WHEEL CONTROLS

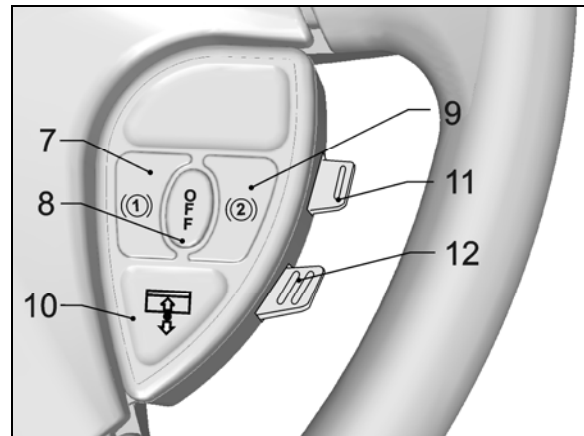

RIGHT STEERING WHEEL CONTROLS

The steering wheel controls include the following functions:

- 1 **SET (CRUISE CONTROL)**  
For the cruise control operating instructions, refer to “cruise control” paragraph in this chapter.
- 2 **CANCEL (CRUISE CONTROL)**  
For the cruise control operating instructions, refer to “cruise control” paragraph in this chapter.
- 3 **RESUME (CRUISE CONTROL)**  
For the cruise control operating instructions, refer to “cruise control” paragraph in this chapter.
- 4, 10 **LEFT SUNSHADE, RIGHT SUNSHADE – NOT FUNCTIONAL**
- 5 **ESCAPE/ENTER (DRIVER INFORMATION DISPLAY)**  
Enter: lift this button briefly.  
Escape: press briefly on this button.
- 6 **UP/DOWN (DRIVER INFORMATION DISPLAY)**  
Use this button to scroll up or down through the menus.
- 7 **ENGINE BRAKE LOW (Ⓐ)**  
The engine brake provides two levels of braking power. Press this button for low engine braking power (about 50 % of full braking power upon release of the accelerator pedal). Refer to Section 5 *Other Features* for more information about the engine brake operation and AUTO (Ⓐ) mode.
- 8 **ENGINE BRAKE OFF**

## 4-54 Controls and Instruments

This button is a momentary switch that will cancel the Engine Brake LOW (1) or Engine Brake HIGH (2) mode and switch the engine brake to AUTO (A) mode. On vehicles so equipped, an engine brake switch located in the dashboard can be used to cancel completely (OFF mode) the engine brake.

### NOTE

Engine brake is safe to use in any road conditions including adverse conditions.

### 9 ENGINE BRAKE HIGH (2)

Pressing this button will allow full application of engine brake (100 % of braking power upon release of the accelerator pedal). Refer to Section 5 *Other Features* for more information concerning the engine brake operation and AUTO (A) mode.

### 11 VOLUME (DASHBOARD RADIO WHEN EQUIPPED)

Use this button to increase or decrease the dashboard radio (driver's radio) volume.

### 12 SEEK (DASHBOARD RADIO WHEN EQUIPPED)

Use this button to seek up or down for a radio station.

## HORNS

The electric horn (city horn) and air horn (highway horn) are operated from the steering wheel center pad. Use the Horn Selector switch located on the lateral control panel to select the appropriate horn type.

### NOTE

When the vehicle is stationary, the electric horn will sound to inform the driver that a fire is detected in the engine compartment.

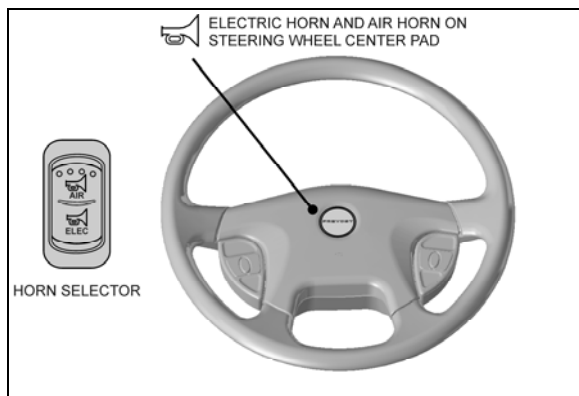

STEERING WHEEL

14068\_1

## FOOT-OPERATED CONTROLS

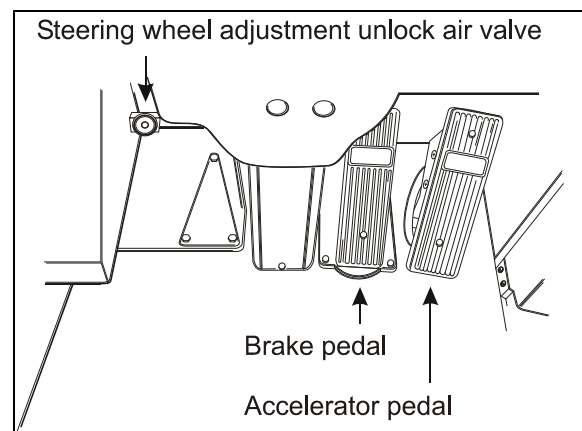

FOOT-OPERATED CONTROLS

00023A

### BRAKE PEDAL

The coach is equipped with a dual braking system. The front brakes operate from a different air pressure source from the drive and tag axle brakes. The dual braking system becomes a modulated emergency system if a pressure drop occurs in the primary brake system.

Service brakes are applied by depressing the brake pedal. Braking increases with the amount of pressure applied to the foot pedal. Refer to

Other Features chapter under Antilock Braking System. When the brake pedal is depressed, the brake lights turn ON automatically.

For safe and effective braking, the air system pressure should reach at least 122 psi in both the primary and secondary circuits. A warning light and an audible alert will sound when the air pressure in either the primary or secondary circuits drops below 85 psi. If this occurs, stop the coach; determine the cause of the pressure loss before proceeding. The brake pedal can be used in conjunction with the transmission retarder. Refer to Transmission Output Retarder in this chapter.

**! DANGER**

Immediately report any brake system problem to your company or directly to the nearest prevost or prevost-approved service center.

Do not "fan" or "pump" the brake pedal. This practice does not increase brake system effectiveness but rather reduces system air pressure thereby causing reduced braking effectiveness.

**! CAUTION**

"Riding" the brake by resting one's foot on the brake pedal when not braking can cause abnormally high brake temperature, can damage and cause premature wear of brake components and reduce brake effectiveness.

**ACCELERATOR PEDAL**

Controls engine RPM as needed.

**NOTE**

*The accelerator pedal will not operate when the entrance door is open.*

**Allison Transmission**

The transmission is fully automatic: Proper ranges should be automatically selected according to driving speeds to improve vehicle performance and control. The speed ratio of the power converter changes automatically as vehicle speed increases and direct-drive goes in

and out as necessary. The speed ratio is modulated by vehicle speed and accelerator pedal position. You will find the complete transmission operation instructions and driving tips in the **Allison 5<sup>th</sup> Generation Bus Series Operator's Manual** included in your vehicle's publication box.

**OPERATION**

When a button is depressed on the transmission control pad, the corresponding letter or number is displayed indicating the transmission is ready to operate in the selected range. If the transmission control module (TCM) detects a serious problem in the transmission, the CHECK telltale lights on the dashboard.

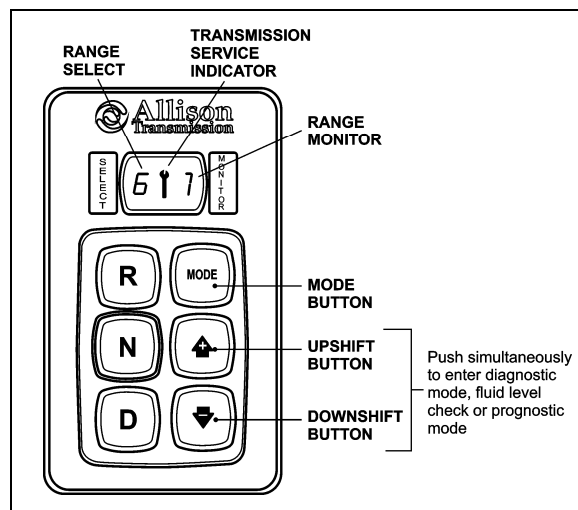

**ALLISON PUSHBUTTON SHIFT SELECTOR** 07142

**PUSHBUTTON SHIFT SELECTOR**

The pushbutton shift selector has the following elements:

**R:** Press to select Reverse gear.

**N:** Press to select Neutral.

**D:** Press to select Drive. The highest forward range available will appear in the digital display window under SELECT. The transmission will start out in the lowest available forward range, displayed under MONITOR, and advance automatically to the highest range.

**▲ ▼ :** Press respectively the ▲ (Upshift) or ▼ (Downshift) arrow button when in DRIVE to

## 4-56 Controls and Instruments

request the next higher or lower range. One press changes gears by one range. If the button is held down, the selection will scroll up or down until the button is released or until the highest or lowest possible range is selected. Protection mechanisms inhibit selecting ranges that are not appropriate for the current speed or which may damage driveline components.

**MODE:** Pressing the MODE button allows the driver to activate the secondary shift schedule that has been programmed into the TCM unit.

### PRIMARY AND SECONDARY SHIFT SCHEDULES

The **primary shift schedule** is the default mode at starting of the engine and is typically specified to accommodate normal vehicle operation. The transmission controller automatically selects between ECONOMY and PERFORMANCE shift strategy, based on the vehicle actual load and the grade on which the vehicle is operating. This is called Load Based Shift Scheduling (LBSS). This can produce improved overall vehicle fuel economy while still enabling high productivity when the vehicle is loaded.

In the **secondary shift schedule**, only the ECONOMY shift strategy is available. No switching is done between shift strategies. The secondary shift mode is available only if selected by the driver, using the MODE button. When the secondary mode is activated, "MODE" illuminates on the display.

#### **NOTE**

*When the diagnostic display mode has been entered, the MODE button is used to view and toggle through diagnostic code information. Refer to appendix C for more details about **diagnostic code display procedure** and **fluid level check** using the pushbutton shift selector.*

### TRANSMISSION SERVICE INDICATOR

**I**: This indicator will be illuminated upon the detection of a service issue relating to clutch, filter or fluid life. The appearance of the indicator (lit steadily, flashing, etc.) varies for each of the conditions monitored by the system. Refer to

appendix C for more details about **diagnostic code display procedure, fluid level check or prognostic features** (Oil Life Monitor, Filter Life Monitor and Transmission Health Monitor) using the pushbutton shift selector.

Illuminated at startup for a bulb check, this indicator will then be turned off if no service conditions exist.

### DESCRIPTION OF AVAILABLE RANGES

#### R (Reverse)

Press the «R» button to select reverse. Completely stop the vehicle and let the engine return to idle before shifting from forward range «D» to reverse «R» or from reverse to forward range. The reverse warning signal will be activated when this range is selected.

#### N (Neutral)

Use this position to start engine. Select «N» (Neutral) when checking vehicle accessories and for extended periods of engine idle operation; parking brake must then be applied. *The pushbutton shift selector automatically select «N» (Neutral) when the ignition switch is turned ON.*

#### **NOTE**

*The automatic transmission does not have a park «P» position. Select «N» (Neutral) and apply parking brake when the vehicle is left unattended. An audible alert will sound if the engine is stopped and the parking brake is not applied.*



#### **WARNING**

Before leaving driver's seat, always put the transmission in NEUTRAL and apply parking brake.



#### **WARNING**

The vehicle service brakes or park brake must be applied whenever NEUTRAL is selected to prevent unexpected vehicle movement.



 <b>CAUTION</b>
Diesel engines should not be idled for extended periods at "slow" idle. For extended idling, engine should run at "fast" idle.

 <b>CAUTION</b>
Do not allow your vehicle to "coast" in neutral «N». This practice can result in transmission damage. Also, no engine braking is available in neutral.

**D (Drive)**

Use this position for all normal driving conditions. After touching this pad, the vehicle will start in first or second range and will automatically upshift to a higher range as output speed increases. As the vehicle slows down, output speed decreases, the transmission automatically downshifts to the correct range. If a locked brake or a slick surface condition should occur, the TCM (Transmission Control Module) will command converter operation (disconnect lockup) and inhibit downshifts for a period of time or until normal wheel speed has been restored.

<b>IMPORTANT NOTE</b>
<i>Brake pedal must be applied when selecting «D» (Drive) otherwise the transmission will stay in «N» (Neutral).</i>

<b>NOTE</b>
<i>The transmission should normally be allowed to shift by itself, but manual shifting can be done as described below.</i>

**1 (First range)**

Select this range when pulling through mud and snow, when speed control is needed for driving up or down steep grades or when maneuvering in tight spaces. This range also provides maximum driving torque and engine braking power or retarder braking effect. In the lower ranges (1, 2, 3 and 4), the transmission will not

upshift above the highest gear selected unless engine overspeed is detected.

**2 (Second range)**

Select this range when operating in heavy and congested traffic. The transmission will start in first and automatically upshift to second. When slowing, the transmission will automatically downshift to first range. Low ranges provide progressively greater engine and retarder braking power (the lower the range, the greater the engine and retarder braking effect).

**3, 4 (Third and fourth ranges)**

Select these ranges when driving on moderate grades or when load and traffic conditions limit speed.

 <b>WARNING</b>
Service brake should not be used to control the speed of vehicle on long, steep descents. Instead, lower transmission ranges should be used (in conjunction with output retarder. Refer to "Engine Brake" and "Transmission Retarder" headings in Section 5 <i>Other Features</i> for details regarding both systems. This procedure keeps service brake cool and ready for emergency stopping.

 <b>CAUTION</b>
When descending in lower ranges, care must be taken that engine speed does not exceed 2,450 rpm.

