

## SECTION 9 TECHNICAL INFORMATION

<b>OVERALL DIMENSIONS</b> .....	<b>2</b>
<b>DIMENSIONS, WEIGHTS AND CAPACITIES</b> .....	<b>4</b>
<b>FUEL TYPE</b> .....	<b>4</b>
BIODIESEL FUELS .....	4
<b>WHEELS AND TIRES</b> .....	<b>5</b>
RECOMMENDED TIRE INFLATION PRESSURE AT MAXIMUM COLD LOAD .....	5
<b>BELTS</b> .....	<b>5</b>
<b>VOLVO D13 ENGINE</b> .....	<b>5</b>
<b>ALLISON TRANSMISSION</b> .....	<b>5</b>
<b>PROPELLER SHAFT</b> .....	<b>5</b>
<b>BRAKES</b> .....	<b>5</b>
BRAKE CHAMBER EFFECTIVE AREA .....	5
<b>AIR SYSTEM</b> .....	<b>5</b>
<b>ANTILOCK BRAKING SYSTEM (ABS)</b> .....	<b>6</b>
<b>STEERING</b> .....	<b>6</b>
<b>ELECTRICAL SYSTEM</b> .....	<b>6</b>
<b>SUSPENSION</b> .....	<b>6</b>
I-BEAM AXLE FRONT SUSPENSION .....	6
DRIVE AXLE .....	6
TAG AXLE .....	6
<b>ALIGNMENT SPECIFICATIONS</b> .....	<b>6</b>
<b>COOLING SYSTEM</b> .....	<b>7</b>
<b>FUEL SYSTEM</b> .....	<b>7</b>
<b>EXHAUST SYSTEM</b> .....	<b>7</b>
<b>HEATING AND AIR CONDITIONING</b> .....	<b>7</b>
<b>OIL SPECIFICATIONS</b> .....	<b>8</b>
ENGINE .....	8
ALLISON TRANSMISSION .....	8
DIFFERENTIAL .....	8
POWER STEERING .....	8
<b>PLATES AND CERTIFICATION</b> .....	<b>8</b>
SAFETY CERTIFICATION .....	9
DOT CERTIFICATION PLATE .....	9
<b>VEHICLE IDENTIFICATION NUMBER (VIN)</b> .....	<b>9</b>
<b>COACH FINAL RECORD</b> .....	<b>9</b>

## 9-2 TECHNICAL INFORMATION

### OVERALL DIMENSIONS

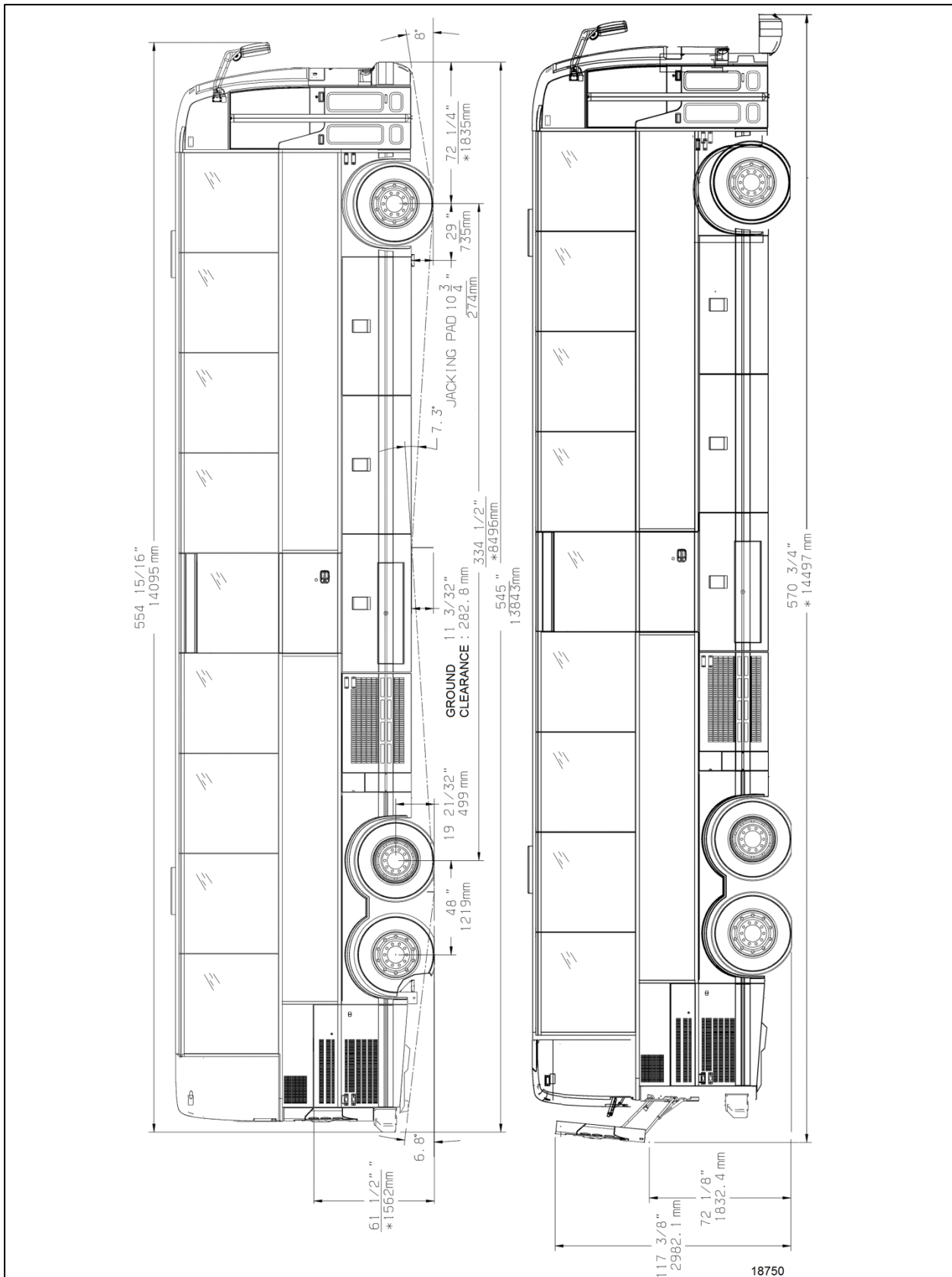

X3-45 COMMUTER OVERALL DIMENSIONS

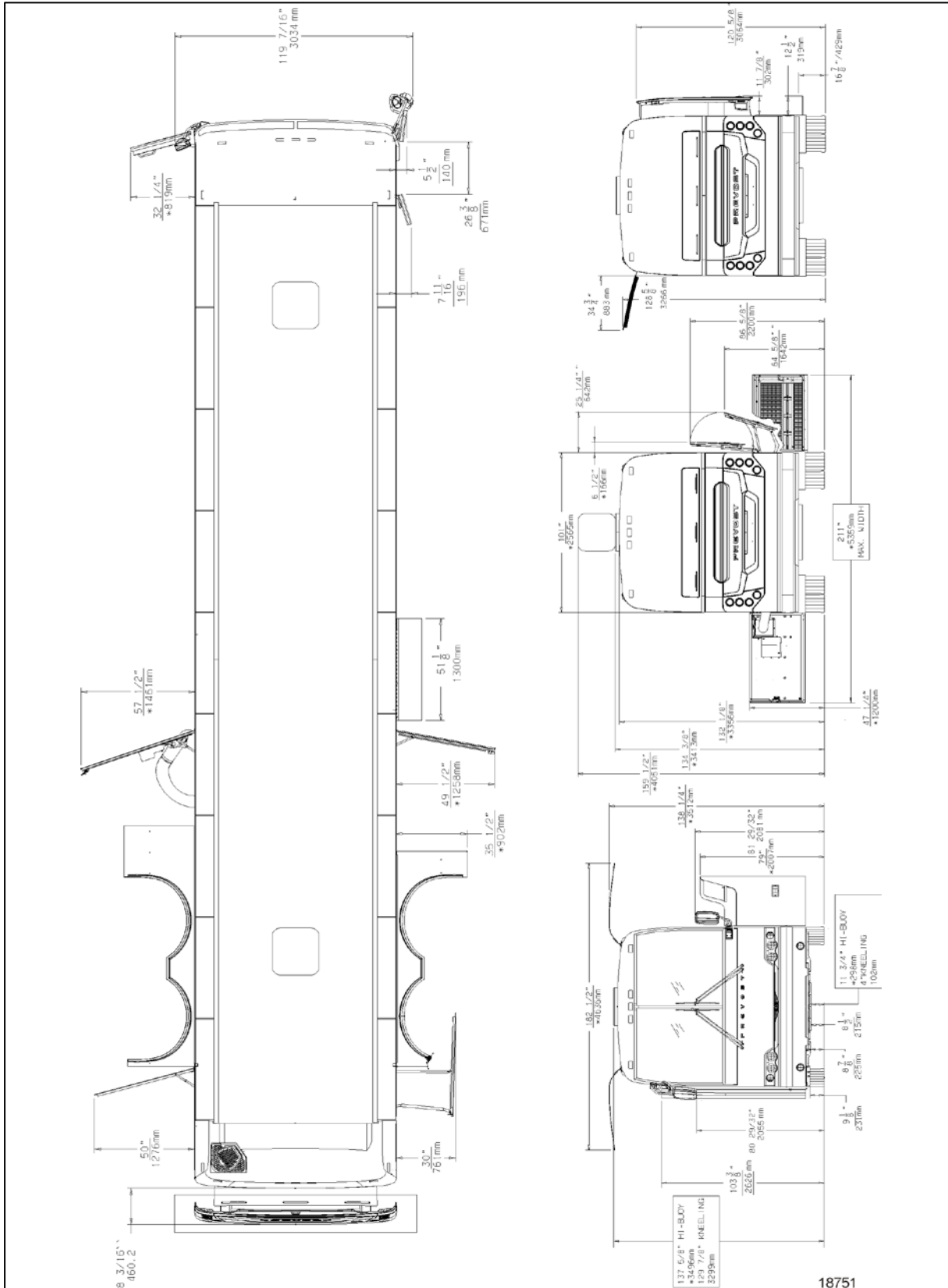

X3-45 COMMUTER OVERALL DIMENSIONS

## 9-4 TECHNICAL INFORMATION

### DIMENSIONS, WEIGHTS AND CAPACITIES

DIMENSIONS AND WEIGHTS	
Overall length (incl. bumpers-mirror)	46 ft
Overall width	101 in
Overall height (hatches up)	138 in
Wheelbase (center of front axle to center of drive axle)	334 ½ in
Floor height from ground	48 ½ in
Ground clearance	11 in
First step height from ground	13 ½ in
Step height (other steps)	7 in
Headroom	80 in
Entrance door opening width	26 in
Front overhang	72 ¼ in
Rear overhang (tag axle down)	90 in
Front track	85.9 in
Drive track	76.7 in
Rear track (Tag axle)	83.6 in
Turning circle radius (I-Beam Axle)	47 ft 3 in
Curb weight	36,000 lbs
Gross Vehicle Weight Rating (G.V.W.R.)	48,000 lbs
Front axle Gross Axle Weight Rating (G.A.W.R.)	16,500 lbs
Drive axle (G.A.W.R.)	22,500 lbs
Tag axle (G.A.W.R.)	14,000 lbs

The Gross Vehicle Weight Rating (G.V.W.R.) and the Gross Axle Weight Rating (G.A.W.R.) for front drive and tag axles are listed on a certification plate located on the L.H. control panel in driver's section.

CAPACITIES	
Volvo D13 Engine oil (Total with filters)	40 U.S. qrts
Fuel tank (corresponding to 95% of gross capacity)	180 U.S. gal.
Cooling system	17.4 U.S. gal.
Diesel exhaust fluid (DEF)	16 U.S. gal.

CAPACITIES	
Allison Automatic Transmission (does not include external circuit)	6 U.S. gallons 6.9 U.S. gallons with retarder
Differential oil (approx)	19 qts
Power steering reservoir	4.0 qts
A/C compressor oil	2.8 qts (2.6L)
Windshield washer reservoir	5.3 U.S. gal.
Refrigerant	30 lb

### FUEL TYPE

Diesel engines for 2007 and later model year vehicles are designed to operate only with **Ultra Low Sulfur Diesel** (ULSD) fuel, which can contain no more than 15 ppm sulfur.



### CAUTION

ULSD fuel is necessary to avoid fouling the engine's Exhaust Aftertreatment System. Use of fuel other than ULSD will reduce the efficiency and durability of the engine.

### BIODIESEL FUELS

Biodiesel up to a maximum of 20% blend (B20) may be used and will not affect the manufacturer's mechanical warranty as to engine and emissions system related components, provided the biofuel used in the blend conforms to ASTM D6751, B1 to B5 blends conform to ASTM D975, and B6 to B20 blends conform to ASTM D7467. Also, any engine performance problem related to the use of biodiesel fuel would not be recognized nor considered as Volvo or Prevost's responsibility.

However, Volvo engines are certified to comply with U.S. EPA and California emissions standards based upon the use of test fuels with specifications established by these regulatory agencies. Alternative fuels, including biodiesel, that are not substantially similar to the required test fuels may adversely affect engine emissions compliance. As a result, Volvo does not warrant the engine will conform to applicable Federal or California emissions limits when operated on biodiesel or other alternative fuels that are not substantially similar to specified test fuels used for certification.

**WHEELS AND TIRES**

Aluminum Durabright wheels .....9" X 22½"

Tires ..... 315/80 R22.5 load range "L"

**RECOMMENDED TIRE INFLATION PRESSURE AT MAXIMUM COLD LOAD**

The recommended tire inflation pressures are given in the applicable documents supplied with the vehicle. In addition, minimum cold tire inflation pressures are listed on the Department of Transport (DOT) certification plate, affixed on the left wall near the driver's seat.

 <b>CAUTION</b>
<p>These tire pressures are established in accordance with the maximum allowable load on each axle. A lower pressure is recommended if the axle load is less than the above specifications. Weigh vehicle fully loaded and pressurize according to tire manufacturer's recommendations. For non standard tire and wheel specifications, see Prevost tire pressure tabulation in "Coach Final Record".</p>

 <b>WARNING</b>
<p>Special tire selection may lower maximum allowable speed limit, even below posted speed limit. For maximum safety, check with tire manufacturer.</p>

**BELTS**

Use	Model	Qty
A/C system Bitzer 4NFCY compressor	V Belt BX71	2
Alternator (twin Bosch, curb side)	Multi-V-8 Rib 8PK1575	1
Alternator (emergency)	Multi-V-8 Rib 8PK1512	1
Alternator (single, driver side)	Multi-V-10 Rib 10PK1695	1
Coolant pump	Multi-V-10 Rib 10PK1512	1

<p><b>NOTE</b></p> <p><i>Belts specifications may vary. For proper belt selection, always consult your vehicle Coach Final Record.</i></p>
--

**VOLVO D13 ENGINE**

Volvo D13 engine displacing 12.8 liters. The engine is an inline six cylinder, four stroke cycle, turbocharged, air to air charge cooled, diesel engine with SOHC with 4 valves per cylinder.

Power ..... 435 HP  
 Torque..... 1,700 lbf•ft (2304 Nm)  
 Operating range ..... 1400-1800rpm  
 Full dress, dry weight ..... 2519 lb

**ALLISON TRANSMISSION**

Allison B500 (B500R with the optional output retarder) electronically controlled six speed automatic transmission.

**Gear Ratios**

1<sup>st</sup> ..... 3.510  
 2<sup>nd</sup> ..... 1.906  
 3<sup>rd</sup> ..... 1.429  
 4<sup>th</sup> ..... 1.000  
 5<sup>th</sup> ..... 0.737  
 6<sup>th</sup> ..... 0.639  
 Reverse..... 4.801  
 Converter ..... 1.9  
 Differential ratio..... 3.54

**PROPELLER SHAFT**

Dana Spicer Life SPL250 type tubular shafts. It is provided with heavy-duty universal joints.

**BRAKES**

The features of the braking system include a dual system where the front and rear circuits are completely independent from each other. The brakes are air operated disc type brakes with automatic slack adjusters on front, drive and tag axles. The emergency/parking brakes are located on the drive axle.

**BRAKE CHAMBER EFFECTIVE AREA**

Front axle ..... 24 in<sup>2</sup>  
 Drive axle ..... 24/24 in<sup>2</sup> (service / emergency)  
 Tag axle ..... 16 in<sup>2</sup>

**AIR SYSTEM**

Compressed air is provided by a twin cylinder, 31.8 cfm Wabco, gear-driven, water-cooled and engine oil lubricated air compressor.

**ANTILOCK BRAKING SYSTEM (ABS)**

The antilock braking system has one Electronic Control Unit (ECU) controlling a four channel system. A wheel slip sensor is mounted at each front axle and drive axle wheel. The Tag axle wheels are slave to the drive axle wheels.

The Electronic Control Unit (ECU) is maintenance free. Its operating voltage is 24 ± 6 volts DC. The thermal operating range for the ECU is from -40 to 167°F (-40 to 75°C).

The solenoid control valves are maintenance free. Their operating voltage is 24 (+4.8, -2.4) volts DC. The rated current draw is 1.65 amps. The thermal operating range of the solenoid control valves is from -40 to 176°F (-40 to 80°C).

**STEERING**

- ZF 8098 integral hydraulic assisted steering gear;
- Volvo hydraulic pump gear driven from engine drive.
- Hydraulic reservoir and dipstick accessible from engine compartment.
- System pressure: 2320 psi (160 bars).
- Steering wheel diameter 18". Tilt steering wheel and telescopic steering column; pneumatically locked with foot operated switch for adjustment.
- Number of turns: 5¾.
- Outside turning radius: See Dimensions and Weight.

**ELECTRICAL SYSTEM**

- 24-volt, negative ground;
- 12-volt exterior lighting;
- Three 28 volts, 150 amp, self-regulated, belt-driven, air-cooled HD 10 Bosch alternators;
- Four 12 volt, Group 31 AGM batteries connected in series/parallel. Cold cranking capacity is 800 amps @ 0°F (-18°C) (each battery) with a reserve capacity of 200 minutes;
- 100 amp battery equalizer.

**SUSPENSION**

Goodyear rolling lobe type air springs (bellows) are used throughout.

**I-BEAM AXLE FRONT SUSPENSION**

- 2 Bellows (12"); for a G.A.W.R. of 16,500 lb;
- 2 Shock absorbers;
- 4 Radius rods;
- 1 Transverse radius rod;
- 1 Height control valve.
- 1 sway bar (1¾" diameter).

**DRIVE AXLE**

- 4 Bellows (11");
- 4 Shock absorbers;
- 3 Radius rods;
- 1 Panhard rod;
- 2 Height control valves.

**TAG AXLE**

- 2 Bellows (11");
- 2 Shock absorbers;
- 3 Radius rods;
- 1 Panhard rod.

**ALIGNMENT SPECIFICATIONS**

Use static wheel alignment systems which work with angle measurements only, such as Josam or Hunter systems. Static alignment specifications are listed in the following tables:

<b>I-BEAM AXLE FRONT SUSPENSION</b>			
	Minimum value	Nominal value	Maximum value
Right camber	-0.250°	0.125°	0.375°
Left camber	-0.250°	0.125°	0.375°
Right caster	2.0°	2.75°	3.5°
Left caster	2.0°	2.75°	3.5°
Total toe	0.04°	0.06°	0.08°

<b>DRIVE AXLE ZF A-132</b>			
	Minimum value	Nominal value	Maximum value
Thrust angle	±0.11°		
Total toe	0.15° toe-in	0°	0.15° toe-out

<b>TAG AXLE</b>			
	Minimum value	Nominal value	Maximum value
Thrust angle* (degrees)	-0.02	0	0.02
Total toe	0.08° toe-in	0°	0.02° toe-out

(\* ) Use the drive axle as reference

**COOLING SYSTEM**

- Extra capacity, copper fin radiator and aluminum charge air cooler arranged one behind the other.
- 3 speed fan clutch engine ECM controlled.
- Rubber insulated from the body.
- Expansion tank above radiator and remote mounted.
- System pressure 13 psi.
- 185° F thermostat.
- System capacity 24 us gal.
- Coolant filter.
- Radiator fan: 38 inches fan belt and drive shaft driven.

**FUEL SYSTEM**

Steel fuel tank

Fuel legal capacity (corresponding to 95% of gross capacity): 180 US gallons (681 liters).

Unusable fuel: 6.3 US gallons (24 liters).

Equipped with:

- Emco Wheaton fuel filling system.
- Provided with filling access on the right side of the coach with safety filler cap.
- Pressure relief valve.
- Electric fuel gauge.

- Low level signal at 26 US gallons/98.4 liters.
- Primary filter 25 microns (standard).
- Fuel pro 382 filter as primary filter.
- Secondary filter 3 to 5 microns.
- Shut-off valve on fuel supply line.

**EXHAUST SYSTEM**

One all stainless steel exhaust aftertreatment system including:

- Catalytic converter to reduce NOx.
- FleetGuard assembly made of a DOC (Diesel Oxidation Catalyst and a DPF (Diesel Particulate Filter). Noise, vibration and heat insulated. This assembly is mounted to the bus structure and is accessible through an exterior access door.
- Tail pipe diffuser and rain deviation device.
- Exhaust pipe with insulation and a flexible section.
- Exhaust to rear left hand top of rear cap.
- Diesel exhaust fluid (DEF) tank (15.9 gal.) and injection system.

**HEATING AND AIR CONDITIONING**

The large capacity A/C provides adequate capacity of conditioned and filtered air for all climatic conditions. Fresh air is drawn into the system from the left (driver's) side of the vehicle. Return air is taken from the middle of the vehicle. The driver's heater and defogger are controlled separately from the central unit. An air mixture selector enables air to be drawn into the system from outside the vehicle or recirculated.

<b>CENTRAL A/C</b>	
Air conditioning capacity	9 tons
Refrigerant type	134A
Heating capacity	152 000 Btu/h
Air flow, overhead parcel rack evap.	450 cfm (12,7 m <sup>3</sup> /min)
Air flow, main A/C	2 600 cfm (73,6 m <sup>3</sup> /min)

## 9-8 TECHNICAL INFORMATION

<b>COMPRESSOR (for central A/C)</b>	
Make and model	Bitzer 4NFCY
Number of cylinders	4
Operating speed	500-3500 rpm
Oil capacity	2.6 quarts (2.5L)
Approved oil	Polyolester (ISO68) Bitzer BSE55 (POE)

### OIL SPECIFICATIONS

#### ENGINE

VDS-4 or VDS-4.5 diesel engine oil is mandatory for use in all 2010 and later emission compliant Volvo engines. VDS-4.5 oils exceed the new API service category CK-4.

#### ALLISON TRANSMISSION

Allison Transmission recommends the following fluids:

- Castrol TranSynd™ or TES-295 specification equivalent fluid;
- TES-389 specification equivalent fluid.

#### DIFFERENTIAL

Mobil Delvac synthetic gear oil 80W/140.

#### POWER STEERING

Use Automatic Transmission Fluid Mobil DEXRON-VI ATF.

### PLATES AND CERTIFICATION

The main components of the vehicle such as engine, transmission, axles and chassis are identified by different serial numbers. It may be necessary to locate these numbers for warranty purposes.

The engine data plate is located on the rocker cover. The engine serial and model number and a list of the optional engine equipment are written on this plate. Refer to this information when ordering replacement parts. Also the engine data plate certifies that the engine conforms to federal and any state exhaust emissions regulations.

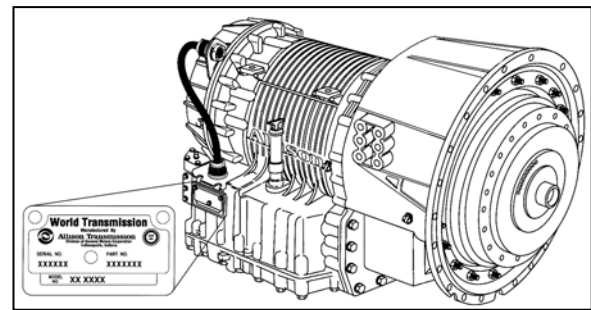

ALLISON TRANSMISSION

07076

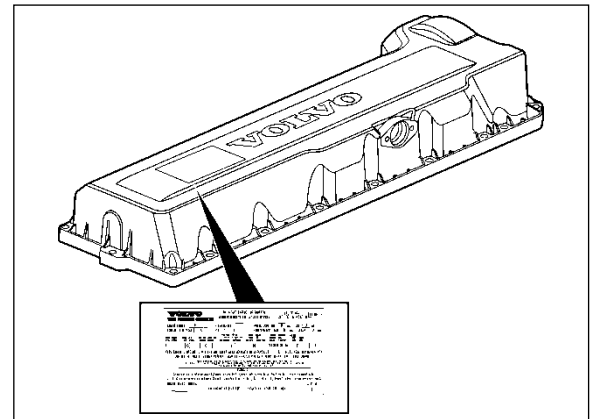

VOLVO D13 ENGINE DATA PLATE

00052

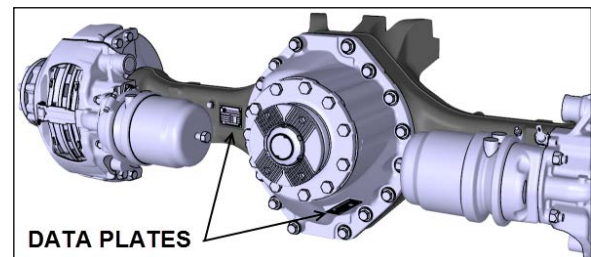

DRIVE AXLE

00007

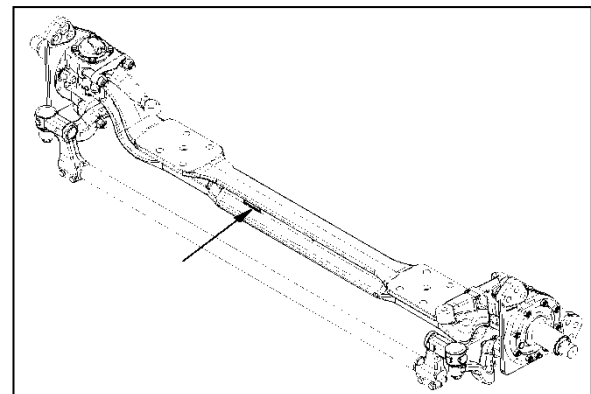

I-BEAM FRONT AXLE

00008





**SAFETY CERTIFICATION**

- Vehicle components meet specifications and standards as follows:
- Material and parts conform to ASTM and/or SAE standards in effect at the time of manufacture.
- All factory-installed interior materials meet FMVSS 302 for fire resistance.
- Certified according to Provincial, State and Federal Safety standards (Canadian and US) BMCSS, FMVSS and CMVSS.
- Other applicable certification labels are affixed to the component.

**DOT CERTIFICATION PLATE**

This certifies that vehicles manufactured by Prevost Car Inc. comply with all Federal Motor Vehicle Safety Standards at the time of manufacture. Information such as date of manufacture, model year, gross vehicle weight rating, tire types and inflation pressure is also etched on this plate. The DOT Certification plate is affixed to L.H. control panel.

		<b>PREVOST</b>			
MANUFACTURED BY : PREVOST FABRIQUE PAR : STE-CLAIRE, QUE.		DATE OF MFG. DATE DE FAB.			
G. V. W. R. : 21772 KG. (48000 LBS). P. N. B. V. :					
AXLES/ ESSEUX	G. A. W. R. / P. N. B. E.	TIRES/ PNEUS	RIMS/ JANTES	COLD INFLATION PRESS. / FROID OU DOUBLE	SINGLE OR SIMPLE OR DOUBLE
	KG (LBS)			KPA (PSI)	
FRONT: AVANT :	7484 (16500)	315/80R22.5 (J)	22.5X9	827 (120)	S
INT. DIFF. :	10206 (22500)	315/80R22.5 (J)	22.5X9	586 (85)	D
REAR: TANDEM :	6350 (14000)	315/80R22.5 (J)	22.5X9	689 (100)	S
THIS VEHICLE CONFORMS TO ALL APPLICABLE U.S. FEDERAL MOTOR VEHICLE SAFETY STANDARDS IN EFFECT ON THE DATE OF MANUFACTURE SHOWN ABOVE.					
VEHICLE IDENTIFICATION NO. NO. IDENTIFICATION VEHICULE		[Blank Box]			
		TYPE: BUS B/A		407644	

DOT CERTIFICATION PLATE

00016

**VEHICLE IDENTIFICATION NUMBER (VIN)**

The Vehicle Identification Number is stamped on a plate located on the windshield frame pillar

(driver's side). The VIN is visible from the outside of the vehicle. Make sure the correct vehicle identification number is given when ordering replacement parts. Using the VIN when ordering parts will facilitate processing.

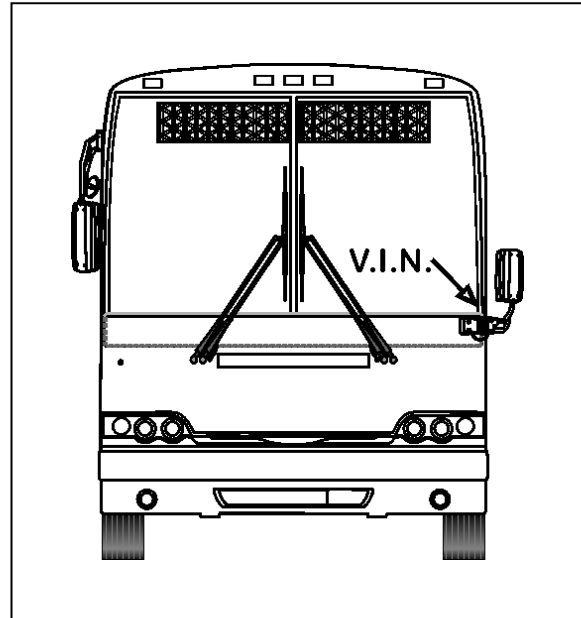

VEHICLE IDENTIFICATION NUMBER

00044

**NOTE**

Record the VIN in the vehicle documentation and keep with company records. The VIN will normally be used for vehicle registration, service reference needs and for obtaining vehicle insurance coverage.

**COACH FINAL RECORD**

The Coach Final Record is a record of all data pertaining to the assembly of the vehicle. This record is shipped to the new customer via a courier company. Retain this record in the company records office for reference and safe-keeping.

## 9-10 TECHNICAL INFORMATION

