

SECTION 8 CARE AND MAINTENANCE

CLEANING..... 3

SEAT UPHOLSTERY 3

Removal Of Stains And Marks..... 3

Beverage Stains..... 3

Alcoholic Beverage Stains 3

Burns..... 3

Cosmetic Stains 3

Ink Stains 3

Blood, Urine Or Vomit Stains 3

Copying Ink - Ball-Point Pen Ink..... 3

Marking Ink (Felt-tip Pens)..... 4

Oil, Grease And Paint 4

Rust Stains..... 4

Tar..... 4

Chewing Gum 4

PLASTIC AND VINYL..... 4

WINDOWS..... 4

STAINLESS STEEL 4

FORMICA 4

CARPET 4

RUBBER COMPONENTS..... 4

FLOOR CLEANING..... 4

EXTERIOR SURFACES..... 4

Tar Or Oil 5

Insects..... 5

Tree Sap 5

WINDSHIELD 5

Wiper Blades..... 5

FLUID LEVEL VERIFICATION..... 5

ENGINE OIL LEVEL..... 5

TRANSMISSION OIL LEVEL 6

Cold Check 6

Hot Check 6

POWER STEERING FLUID LEVEL..... 7

DRIVE AXLE WHEEL HUBS 7

FRONT AND TAG AXLE WHEEL HUBS 7

COOLANT FLUID LEVEL..... 7

Level switches..... 8

WINDSHIELD WASHER RESERVOIR..... 8

OTHER VERIFICATIONS..... 9

AIR TANK PURGE 9

FIRE EXTINGUISHER 9

PRIMARY FUEL FILTER..... 9

A/C COMPRESSOR BELTS 10

FAN AND ALTERNATOR DRIVE BELTS 10

ENGINE AIR FILTER RESTRICTION INDICATOR..... 10

A/C AND HEATING SYSTEM AIR FILTERS 11

Driver's Area Air Filters..... 11

Passengers Area Air Filter 11

Air Filters in the Overhead Compartments 11

HOSE INSPECTION 11

8-2 CARE AND MAINTENANCE

<i>Hose Service Life</i>	12
LUBRICATION	12
WHEELS AND TIRES	12
WHEEL BEARINGS	12
SERVICE BRAKE TEST	12
PARKING BRAKE TEST	12
EXTERIOR LIGHTING VERIFICATION.....	13
<i>Exterior Lighting Test Mode</i>	13
<i>Prior using the test mode</i>	13
<i>Activating the test mode</i>	13
<i>Stopping the test mode</i>	13
FIRST SERVICE ON NEW VEHICLE	14
ENGINE OIL	14
GENERAL RECOMMENDATIONS	14
WALK-AROUND INSPECTION (BEFORE EVERY TRIP)	18

CLEANING

The cleaning information provided in this section is regarded as recommended cleaning practices. Cleaning results may vary depending on the condition of the stain. Always clean stains promptly for best results.

Test an inconspicuous area prior to cleaning and follow the manufacturer's directions.

NOTE

Use only approved cleaning products. Never use stain protection products on new fabrics. To prevent permanent staining of fabrics, clean stains as soon as possible after they occur. Incorrect treatment of stains can worsen them. Get help from a cleaning specialist to remove stubborn stains.



CAUTION

Custom fabrics and materials may require different cleaning and maintenance practices. Consult your supplier.

SEAT UPHOLSTERY

Firmly beat the fabric with a blunt object, such as a wooden paddle, to release dust and dirt. Vacuum the seat fabric in the direction of the stitching using an upholstery nozzle.

NOTE

The abrasive nature of dirt and grit will reduce upholstery life expectancy. Vacuum regularly.

Always begin with lukewarm water and a white cloth for most stain removal before applying any cleaning agent.

Removal Of Stains And Marks

Depending on the nature of the stain, apply one of the two methods explained below to remove stains and marks on wool plush.

Method 1:

1. Apply a nonflammable solvent to stained area with a clean, white absorbent rag;
2. Clean stain by starting at the outer edges of the stain and working in toward the center;
3. Blot affected area frequently with a clean, dry absorbent cloth to prevent stain rings caused by excess solvent.



WARNING

Use solvents in a well-ventilated area. Open all windows and doors.

Method 2

1. Wet the stain with a solution of household detergent and lukewarm water. Do not soak the stain;
2. Rub the stain with a damp cloth;
3. Rinse cloth after each application.



CAUTION

Do not use soap, soap powder, ammonia, soda, bleach or cleaning products containing any of these compounds.

Beverage Stains

Remove beverage stains by following method one. If stain persists, repeat method one using methylated spirits instead of solvent.

Alcoholic Beverage Stains

Remove alcoholic beverage stains by wetting the stain with water, then cleaning following method two.

Burns

Scrape burnt area using a knife or razor blade then clean following method two. Consult an upholstery specialist when dealing with extensive burns.

Cosmetic Stains

Remove stains left by cosmetics by following method one then method two.

Ink Stains

Remove ink stains following method two. If stain persists, apply a warm oxalic acid solution. Rinse with water.

Blood, Urine Or Vomit Stains

Remove such stains by following method two.

Copying Ink - Ball-Point Pen Ink

Treat with methylated spirits, blotting frequently to avoid spreading stain, followed by method two.

8-4 CARE AND MAINTENANCE

Marking Ink (Felt-tip Pens)

Treat with Methyl-Ethyl-Ketone (MEK) followed by method two.

Oil, Grease And Paint

Remove excess using a knife. Treat with method one followed by method two. If stain persists, repeat the procedure.

Rust Stains

Remove rust stains by following method two. Apply a warm oxalic acid solution to stained area. Rinse with water.

Tar

Soften tar with benzene, then treat using method one followed by method two.

Chewing Gum

Soften gum with cyclohexane. Carefully scrape off stains using a sharp knife or razor blade.

PLASTIC AND VINYL

Clean plastic and vinyl trim using a clean damp cloth or sponge. For vinyl trim marks, use a lukewarm all-purpose cleaner or a mild saddle soap. Remove water spots and soap traces using a clean damp cloth or sponge. Dry with a clean soft cloth.

Remove grease, tar or oil stains with a clean cloth or sponge and an all-purpose or solvent-type vinyl cleaner.

Apply a colorless vinyl or leather protective product to maintain the luster and pliability of the plastic or vinyl surface.

WINDOWS

Clean the inside of the windows with a solution of one part vinegar to ten parts water.

STAINLESS STEEL

Use a stainless steel cleaner and follow the manufacturer's instructions. Stainless steel cleaning solution may be ordered from Prevost Car Inc. quoting part number 68-0356.

FORMICA

Remove stains on Formica surfaces with a household detergent, methylated spirits or mineral turps. Clean with a mild abrasive and water solution if stain persists.

CARPET

Vacuum carpets regularly to prolong carpet life.

RUBBER COMPONENTS

Use only pure water or glycerin to clean stains on rubber components.



CAUTION

Never use solvents on rubber components.

FLOOR CLEANING

Clean vinyl floors with a quality nonionic detergent cleaner. Follow the manufacturer's recommendations for cleaning.

Remove any excess detergent solution using a wet/dry vacuum or mop. Rinse floor with a solution of one part Clorox to ten parts warm water.

Polish dry floor using a high-speed buffer and a smooth red 3-M polishing pad.

Mop floor periodically with a solution of 5 per cent Clorox in warm water.

NOTE

For custom or special floor covering materials, consult the manufacturer or your converter for information on how to clean and maintain these types of floors.



CAUTION

Using a water hose to clean the floor is prohibited since it could cause electrical shorts or damage the electrical system.

EXTERIOR SURFACES

Frequent washing and waxing of the vehicle exterior will help protect the finish and luster. The paint finish is attacked by the abrasive effects of airborne particles and corrosive pollutants.

Before washing the exterior of the vehicle, close the fresh air dampers using the "REC" button located on HVAC control panel and on the air intake duct in the evaporator compartment. Install keyhole protectors to prevent water from penetrating. Rinse vehicle with water to remove all loose dirt. Wash vehicle using a quality brand car wash soap. Follow the manufacturer recommendations for cleaning. Rinse well with water.

The vehicle exterior should be cleaned, waxed and buffed when water droplets no longer form on the painted surfaces.

 CAUTION
Hot water can damage paint. Keep water cool or lukewarm.

 CAUTION
<ul style="list-style-type: none"> • Make sure cleaning solutions are not harmful to painted surfaces. Read the manufacturer's instructions before using. • Do not spray water jet directly into fresh-air inlet dampers. • Do not aim high pressure water jet at radiator doors. This could damage the radiator fins.

To prevent corrosion, remove caked-on dirt and road salt from the vehicle underbody using a high pressure water jet. Clean wheel housings, bumpers, muffler, tailpipe and brackets.

Carry out corrosion prevention cleaning at least twice a year. Spray underneath of the vehicle and let soak before cleaning. Let engine and exhaust system cool down before cleaning.

Tar Or Oil

Remove tar or oil as soon as possible with an approved automotive tar and oil remover or turpentine. Thoroughly clean area with car wash soap and water. Let dry, then wax.

Insects

Remove insect stains as soon as possible with a lukewarm soap and water or insect remover.

Tree Sap

Remove tree sap or bird droppings with lukewarm soap and water. Do not allow to harden.

WINDSHIELD

To prevent windshield wiper streaking, keep silicone sprays away from the windshield. Remove road film and wax build-up from windows with lukewarm soap and water or with an alcohol-based cleaning agent. If a chamois is used to dry and polish glass, use it exclusively for that purpose.

Wiper Blades

To avoid tearing frozen wiper blades, loosen them before removing. Remove and clean wiper blades periodically with an alcohol-based cleaning solution. Clean wiper blades using a sponge or soft cloth.

FLUID LEVEL VERIFICATION

Periodic inspection of oil and fluid levels is the most economical and easiest way to help your vehicle perform at its best. Rigorous oil level inspection and replacement will greatly help minimize expensive and unscheduled repairs.

ENGINE OIL LEVEL

Check engine oil level when the engine is still warm and with the vehicle parked on a level surface. Shut *OFF* engine and wait at least 10 minutes for oil to drain into the oil pan before checking. Check engine oil level daily or before each trip. Add oil as required. Do not overfill. Remove dipstick, wipe clean and fully reinsert to ensure an accurate reading. Remove dipstick and check engine oil level.

Do not let the oil level fall below the marking on the dipstick. **Do not** overfill so the level is above the upper marking on the dipstick. Add oil through the oil filler pipe as required in order to maintain level within the safe range

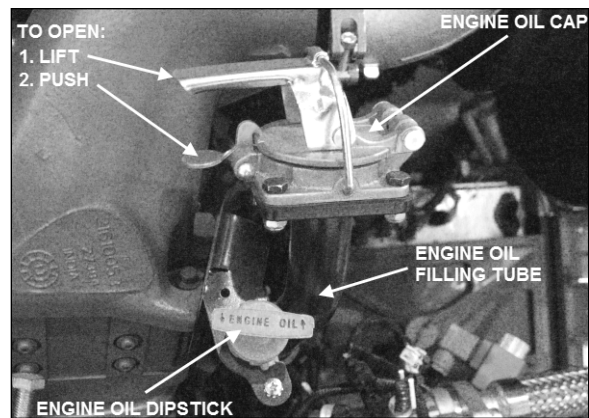

ENGINE OIL DIPSTICK - VOLVO D13 ENGINE 01192

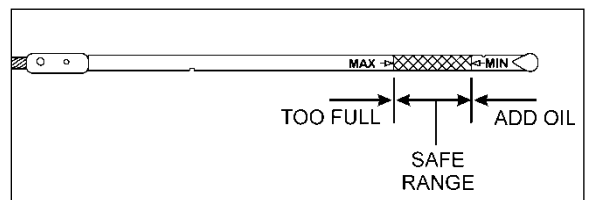

VOLVO D13 ENGINE OIL LEVEL DIPSTICK 01195

TRANSMISSION OIL LEVEL

DANGER

To prevent personal injury, do not service transmission wearing loose clothing. Stand clear of the engine and rotating components while checking the oil level.

CAUTION

Do not mix fluid types or brands because of possible incompatibility.

CAUTION

Use clean fluid and containers when filling transmission. Never use containers that have contained water or antifreeze (Glycol).

Transmission fluid level may be checked using dipstick or transmission control pad display. The oil level sensor (OLS) is standard in your transmission. With the OLS and Allison 5th generation shift selector, you can get a more accurate electronic fluid level check than with a dipstick.

For more information on how to use the shift selector display to check the transmission oil level, refer to Appendix B under "Allison transmission oil level check using the pushbutton shift selector" in this manual.

The transmission fluid level dipstick is accessible through the engine compartment rear door and is located on the left side of the engine.



ENGINE L. H. SIDE

01189_2

To check the transmission fluid level, a "cold check" and a "hot check" must be performed. A

cold check must be made when the transmission fluid is between 60°F and 120°F (16°C and 50°C).

NOTE

Perform the cold check first to verify the transmission fluid level before performing the hot check.

To prevent dirt and foreign matter from entering the transmission, clean the end of the oil fill tube before removing the dipstick. To remove dipstick, unscrew filler cap approximately three turns and pull out the dipstick.

Cold Check

Run the engine until the transmission fluid temperature is between 60°F and 120°F (16°C and 50°C). With the engine idling, make sure the parking brake is applied and the transmission is in neutral (N). Remove and wipe the dipstick with a clean cloth. Check oil level. If the oil level is within the COLD RUN band, the oil level is correct and a hot check can be performed. If the oil level is on or below the lower line of the COLD RUN band, add oil until the level lies within the COLD RUN band. If the oil level is above the COLD RUN band, drain oil until the level is within the band.

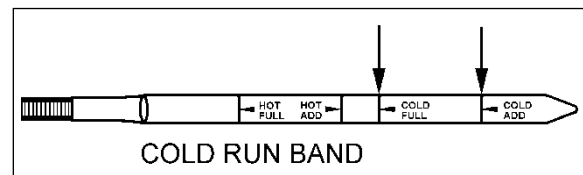

TRANSMISSION FLUID LEVEL DIPSTICK (TYPICAL) 07050



CAUTION

The oil level rises as oil temperature rises. Do not add oil above the "cold run" band before the transmission reaches 180°F to 220°F (82°C to 104°C).

Hot Check

Make sure the transmission fluid temperature is between 180°F and 220°F (82°C and 104°C) before performing the hot check. Run the engine between 1,000 and 1,200 RPM for approximately one minute to purge air from the system. With the engine idling and the parking brake applied, shift transmission from forward (D) to reverse (R) and back into neutral (N) to fill clutch cavities with oil. Remove and clean dipstick, then check oil level. If the oil level is on

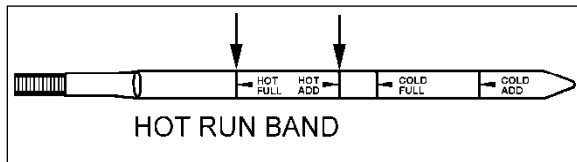
or under the lower HOT RUN line, add just enough oil to bring up the level to the middle of the HOT RUN band.



TRANSMISSION FLUID LEVEL DIPSTICK (TYPICAL) 07049

Replace dipstick and tighten the filler tube cap until the rubber seal is correctly seated.

	<h2>CAUTION</h2>
<p>Do not overfill the transmission fluid reservoir. Severe damage may result.</p>	

POWER STEERING FLUID LEVEL

The power steering hydraulic fluid tank is located in the engine compartment, close to the engine air filter (refer to “Engine Compartment Overview” image in COACH EXTERIOR section).

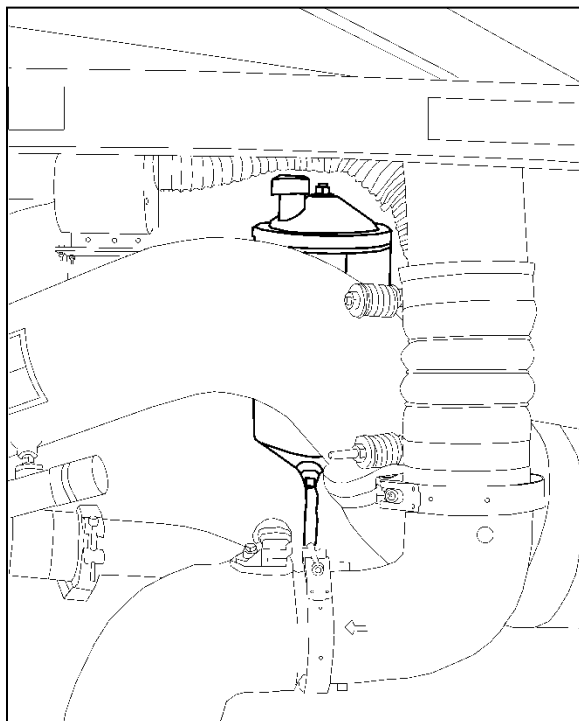

ENGINE COMPARTMENT 14059

Check fluid level as follows:

1. Stop engine, open engine compartment doors and place rear start switch to OFF position;

2. Unscrew and remove the dipstick located on top of the power steering fluid tank and wipe with a clean rag;
3. Replace dipstick in the tank, then remove to check fluid level;
4. Add hydraulic fluid until it reaches the FULL mark on the dipstick;
5. Replace and tighten dipstick;
6. Place engine rear start switch to NORMAL position. Close engine compartment doors.

DRIVE AXLE WHEEL HUBS

The unitized bearings in the axle drive and the wheel ends are pre-lubricated for life and there is no need or facility for re-lubrication. Maintain differential oil at correct level to ensure adequate lubrication of the carrier.

FRONT AND TAG AXLE WHEEL HUBS

The unitized hub bearings used on the NDS range of axles are non-serviceable items. Bearings are pre-adjusted, lubricated and have seals fitted as part of the manufacturing process. The bearings are greased for life and there is no need or facility for re-lubrication.

COOLANT FLUID LEVEL

The coolant system has two tanks; the surge tank (A) and the recovery tank (B).

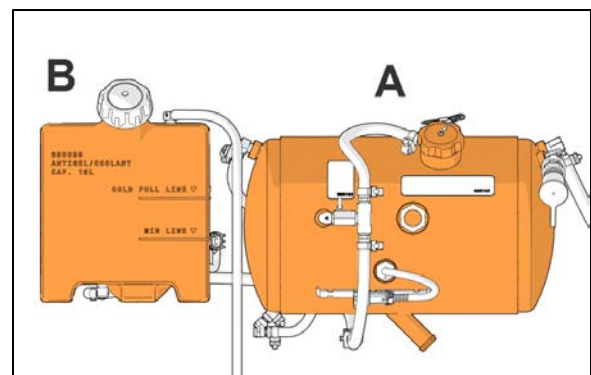

Check the coolant level into the recovery tank (B) when the engine is cold (room or ambient temperature).

- If the coolant level into the recovery tank is lower than the MIN LINE, use the recovery tank filler cap to add coolant until reaching the FULL LINE.

8-8 CARE AND MAINTENANCE

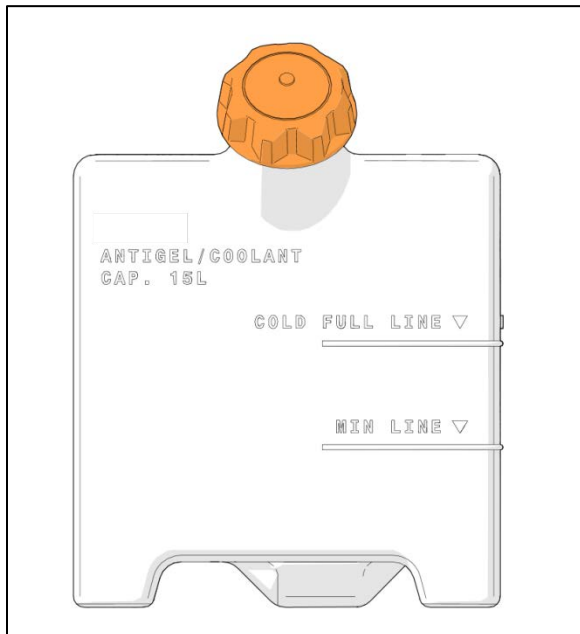

Fill the recovery tank with the same 50/50 water-antifreeze mixture already in the cooling system. **Do not** mix two different types of coolant. Refer to the Maintenance Manual for proper coolant type specifications or see the label affixed near the coolant surge tank on the vehicle.

Level switches

Both tanks are equipped with a level switch. A message (pictogram) will appear on the cluster according to which switch is activated.

The table below shows the pictograms and the description.

PICTOGRAM	DESCRIPTION
CHECK ENGINE COOLANT LEVEL AT NEXT STOP	Low engine coolant level Warns the driver that the engine coolant level has reached the recovery tank low level switch. Add coolant whenever possible. Use recovery tank filler cap.
ENGINE COOLANT LEVEL CRITICALLY LOW	Critically low coolant level Warns the driver that the engine coolant level has reached the surge tank low level switch. Stop and add coolant. Use recovery tank filler cap.

Level from the level switches does not match with the level lines on the recovery tank.



WARNING

Allow engine to cool down before adding coolant. There is no pressure into the recovery tank. If necessary, use the valve attached to the surge tank to release the pressure into the surge tank and the cooling system. Close the valve after releasing the pressure.

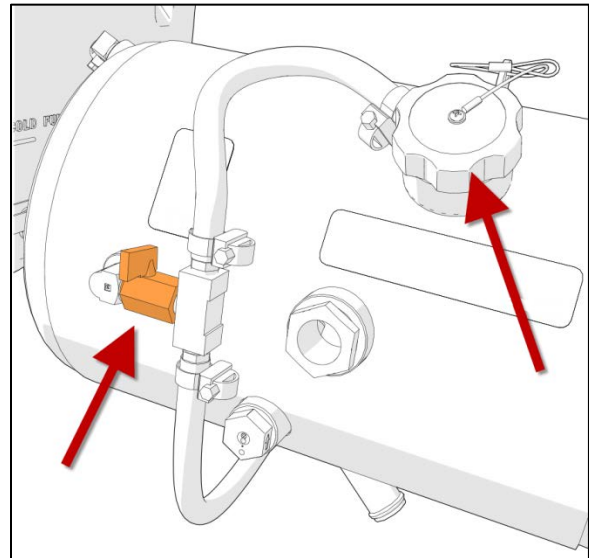

WINDSHIELD WASHER RESERVOIR

The windshield washer reservoir is located in the front service compartment door. The windshield washer reservoir has a capacity of 5.3 US gallons (20 liters). Check fluid level regularly.

The windshield spray jets are located on the windshield wipers and are angled to spray towards the center of the windshield.

You may use water or windshield washer fluid as well.

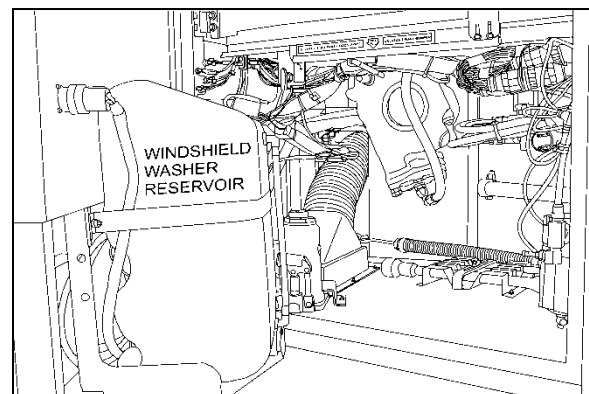

WINDSHIELD WASHER RESERVOIR

18619



CAUTION

During cold weather days, use windshield washer fluid suitable for freezing temperature only.

OTHER VERIFICATIONS

It is good practice to regularly inspect the vehicle for signs of component wear and to perform safety and maintenance routines.

AIR TANK PURGE

The vehicle is equipped with seven air tanks, including the ping tank.

The wet tank is equipped with an automatic drain valve and doesn't need to be purged manually.

The remaining tanks which are the primary, secondary, the accessory, kneeling, and parking brake overrule tanks are equipped with a drain cock underneath the tank and must be purged from moisture and contaminants every 12,000 miles. Drain tanks by turning drain cocks counterclockwise. The accessory air tank drain cock is accessible from the front service compartment. The parking brakes overrule air tank is located at the ceiling of the last baggage compartment. Refer to the "Lubrication and Service Check Point Chart" in this chapter for tank locations.

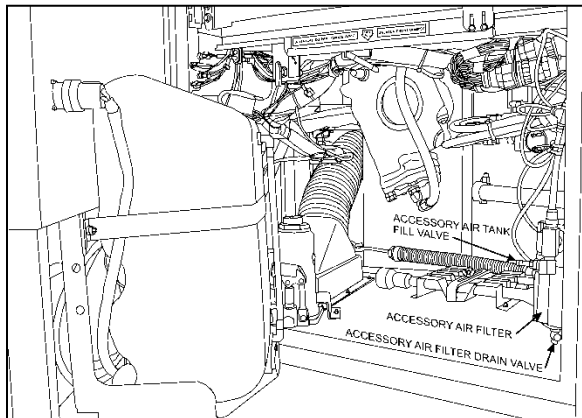

FRONT SERVICE COMPARTMENT

12210

FIRE EXTINGUISHER

Inspect fire extinguisher monthly to insure operation in emergency situations.

On extinguishers with a pressure gage, the needle should be in the green or NORMAL range. Refill or replace extinguisher if pressure is below normal;

Check that seal on handle is intact;

Check that hose nozzle is in good condition and the nozzle is free of obstructions;

Keep fire extinguishers clean.

PRIMARY FUEL FILTER

A primary fuel filter is installed on the engine. This filter may consist of a filter cartridge with a drain valve at the bottom, or a filter cartridge, a water separation bowl and may have a fuel heater built in. It is used to prevent water from entering the fuel system. The primary fuel filter should be drained periodically or when the telltale light on the dashboard illuminates if equipped with this system. To drain water, loosen the drain valve below the separator. Close the drain valve when finished.

The optional Fuel Pro 382 diesel fuel filter system consists of a permanently mounted fuel processor, a replaceable filter element, a filter element cover and collar and a fluid filter base assembly. This system is installed between the fuel tank and the fuel pump and replaces the primary fuel filter. The filter serves as a water separator as well as a fuel filter. To drain, turn ¼ turn the drain valve below the filter, close when water has been flushed out.

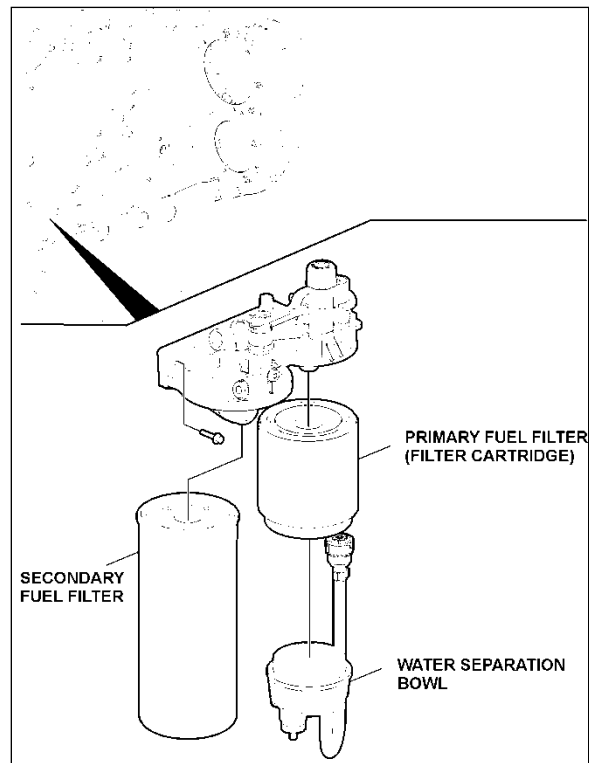

FUEL FILTERS WITH VOLVO D13 ENGINE

03085

8-10 CARE AND MAINTENANCE

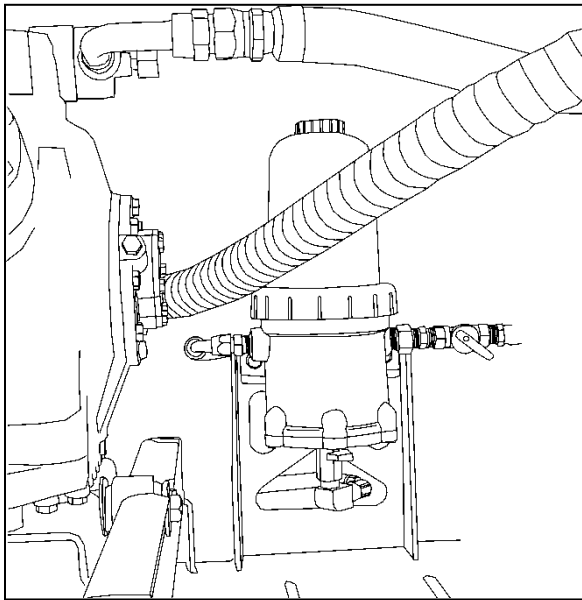

DAVCO FUEL PRO 382 INSTALLATION

03062

A/C COMPRESSOR BELTS

The air conditioning compressor is driven by two V-belts.

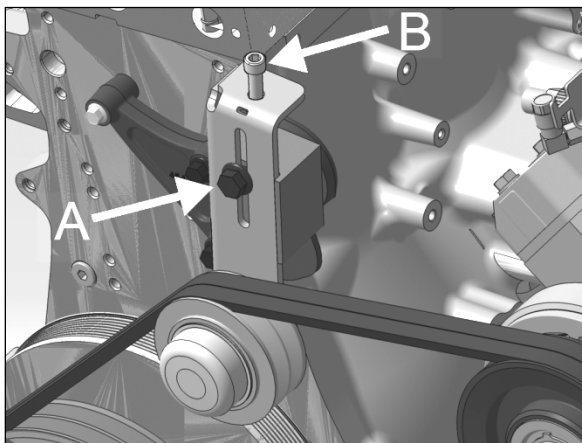

BELT TENSIONER

Belt tensioning is applied through the tensioner adjustment screw B. Loosen lock bolt A prior adjustment. Tighten lock bolt A to 43 lbf-ft once completed.

Belt tension should be within the following values:

New belts: 90-100 lbs.

Used belts: 75-85 lbs.

Check belt tension using a belt strand tension gage.

- Once adjustment is completed, allow the engine to run for about ten minutes. Check belt tension and adjust if needed.

- Do not treat belts with any compounds. Keep belts dry.
- Periodically inspect belt and pulleys for wear or damage;

FAN AND ALTERNATOR DRIVE BELTS

These belts have an automatic belt tensioner to keep the correct tension without the need for adjustment.

ENGINE AIR FILTER RESTRICTION INDICATOR

An engine air filter restriction sensor is located on the turbo air intake duct

It is used to monitor the vacuum level between the air filter and turbo. A red marker is displayed when the air filter is clogged.

Replace the air filter when a red marker is displayed on the indicator or upon illumination of the restriction indication light on the rear start panel. Reset by pressing on the restriction indicator's extremity.

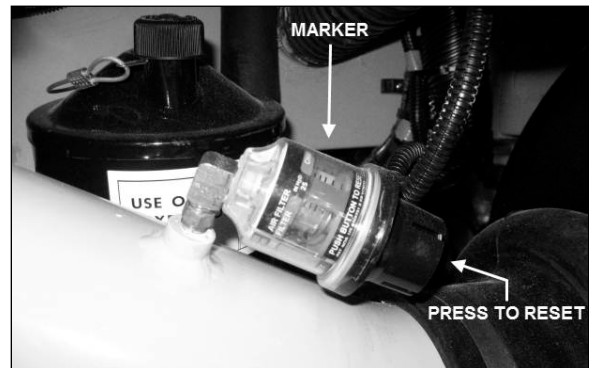

AIR FILTER RESTRICTION SENSOR

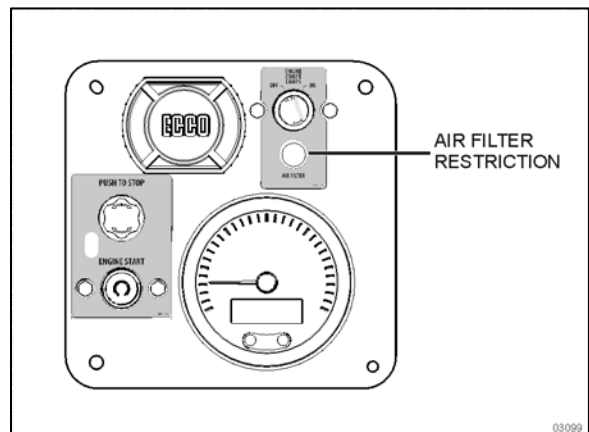

AIR FILTER RESTRICTION INDICATOR

03099

A/C AND HEATING SYSTEM AIR FILTERS

For maximum air conditioning and heating system efficiency, air filters should be inspected, cleaned and replaced as required in maintenance schedule to ensure proper ventilation of the evaporator and heating radiator cores.

Driver's Area Air Filters

The driver HVAC system's air filter is located behind the dashboard R.H. side and it can be removed for cleaning or replacement. To gain access to the A/C filters, unscrew the grill located at the top step of the entrance door steps, remove the plastic cover holding the filter and slide out the air filter.

NOTE

If the windshield is continuously fogged, check that the driver's air filter is not clogged.

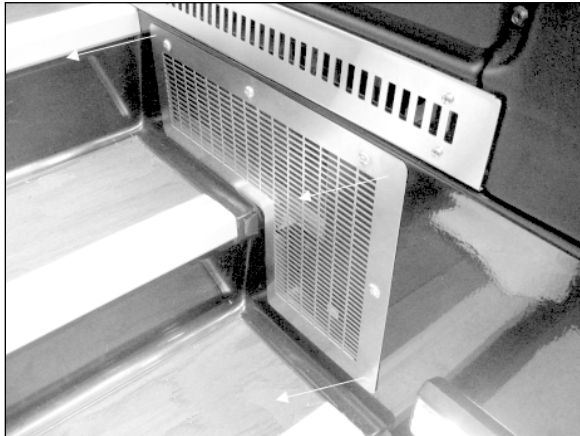

DRIVER'S AREA AIR FILTER GRILL REMOVAL



REMOVING DRIVER'S SECTION AIR FILTER

Passengers Area Air Filter

The central HVAC system's air filter is located in the evaporator compartment on driver's side of the vehicle. To access, open the evaporator compartment. An access panel marked "AIR FILTER" is located above the evaporator and heating coils. It is held shut by quarter-turn screws. Slide out the filters for maintenance purposes.

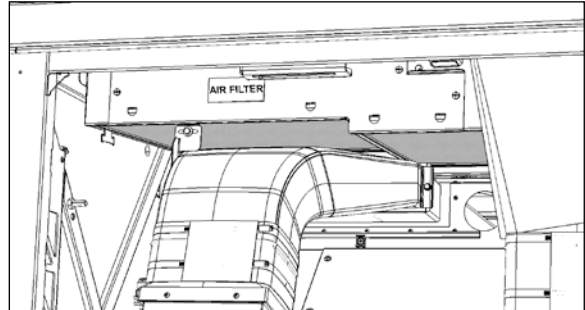

PASSENGERS AREA AIR FILTER REMOVAL 22306



CAUTION

Be sure not to install the filter in inverted position.

Air Filters in the Overhead Compartments

Remove, clean or replace the air filter located behind each overhead baggage compartment fan. Slide the filter in and out using the tab fixed on the side of the filter.

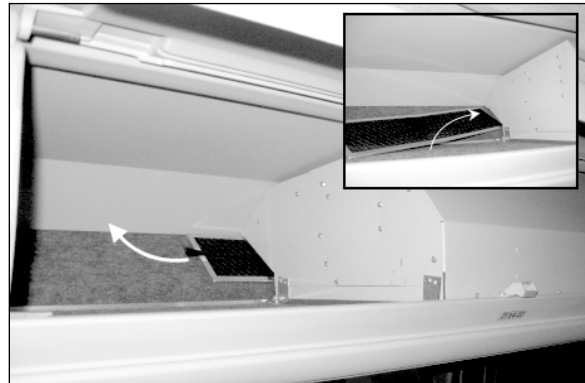

OVERHEAD COMPARTMENT FAN AIR FILTER

HOSE INSPECTION

Inspect hoses for leaks regularly to ensure efficient, economical and safe operation of the engine and related equipment. Carefully inspect all fittings, clamps and ties. To prevent chafing, make sure hoses are not touching shafts, couplings, heated surfaces, sharp edges or other parts. Since hose clamps and ties can

8-12 CARE AND MAINTENANCE

vibrate loose or fail over time, frequently inspect and tighten or replace as necessary.

Correct leaking hoses immediately. Failure to correct leaks can cause severe damage to the equipment, as well as increase operating costs due to lost fluids. Treat fuel and oil leaks as an immediate fire hazard.



WARNING

Personal injury and property damage may result from fire caused by leaking flammable fluids.

Hose Service Life

Hoses have a limited service life. Thoroughly inspect hoses annually. Look for surface damage or indications of twisted, worn, crimped, cracked or leaking lines. Replace damaged hoses immediately.

Hoses should be replaced during major overhaul or after a maximum of seven years' service. Be certain replacement hoses match the original equipment manufacturer's specifications.

LUBRICATION

Grease all lubrication points during scheduled maintenance. For heavy loads or extended use, lubricate more often. Refer to the Maintenance Manual, section 24 for information on lubrication.

WHEELS AND TIRES

Check for loose wheel nuts. Inspect all types of rims for cracks. Cracks can appear in many places but typically radiate out from where a load is applied. Steel wheel nuts should be tightened to 450 to 500 foot-pounds (610 to 680 Nm) torque.

Keep the tires inflated to the recommended inflation pressure to prolong tire life and for safety.

NOTE

Recommended tire inflation pressures are given in the "Coach Final Record", placed in the technical publications package supplied with the vehicle. The cold tire inflation pressures are on the Department of Transport certification plate located on the L.H. console besides the driver's seat. When special tires are installed by Prevost on a new vehicle, a special tire inflation chart is added next to the certification plate.



WARNING

Do not exceed maximum inflation pressure. Incorrect tire pressure increases tire wear and could lead to loss of driving control because of reduced road handling. Check tire pressure regularly.

WHEEL BEARINGS

Check wheel bearing cover for overheating (especially after using the service brakes) during fuel stops by touching the wheel bearing cover.



WARNING

If replacement tires are different from those described on the certification plate, pressure must be adjusted as requested in the Tire and Rim Association Manual.

SERVICE BRAKE TEST

Check for the correct pressure build-up. Stop the engine and check the pressure gage. Pressure loss should not exceed 3 psi/min (21 kPa/min) with the engine stopped and without brake pedal applied. Air loss should not exceed 7 psi/min (48 kPa/min) with the engine stopped and brake pedal fully applied.

A convenient way to proceed to the service brake test is with the use of the DID menu "Air Leakage Monitor". For more information, refer to "Driver Information Display (DID) Menus" in Section 5 *Other Features*.

PARKING BRAKE TEST

Release parking/emergency brake. Pump service brake pedal until air pressure drops to 65 psi (448 kPa). Make sure the warning buzzer operates and that the emergency brakes apply (the control valve knob lifts up). Allow air pressure to reach 95 psi (655 kPa) before releasing parking brake.

Driving the vehicle while the parking brake is applied should not be possible.

EXTERIOR LIGHTING VERIFICATION

Exterior Lighting Test Mode

This useful function allows quick verification of the vehicle exterior lights.

IMPORTANT NOTE

The test mode is useful to check the functioning of the multiplex outputs and the exterior lights. It doesn't test the functionality of the commands related to the exterior lighting. For a complete testing, the directional signal commands, the headlights commands and the brake pedal have to be checked before. Once these commands tested, activate the test mode to check the exterior lighting.

Prior using the test mode

First, test the functionality of the commands related to the exterior lighting:

- Press the right turn signal switch and check that the corresponding telltale light illuminates.
- Press the left turn signal switch and check that the corresponding telltale light illuminates.
- Activate the hazard warning flashers and check that the corresponding cluster telltale lights illuminate.
- Press the headlights rocker switch in first position and confirm that the instrument panel illuminates. Press the headlights rocker switch in second position and confirm that the headlights illuminate.
- Turn on the high beams and check that the corresponding cluster telltale light illuminates.

Once these commands tested, activate the test mode to check the exterior lighting:

- All marker lights, clearance lights and identification lights illuminate.
- High and low beam headlights illuminate.
- All directional signal lights and center stop lights flash.
- Stop lights and center high-mounted stop light (CHSL) illuminate every 4 seconds.

Activating the test mode

When the vehicle is stationary (parking brake applied), press the left and right turn signal foot switches simultaneously and release to activate the test mode.

This test can be done when the engine is running or when it is not running with the ignition switch to the ON position, provided that the battery charge is sufficient (above 24.0 volts).

Once initiated, the exterior lighting test mode will turn off automatically after a delay of **120 seconds**.

NOTE

*You can also **initiate and stop** the exterior lighting test mode with the use of the DID menu "Exterior Lamp Inspection". For more information, refer to "Driver Information Display (DID) Menus" in Section 5 Other Features.*

Stopping the test mode

- The test mode will turn off automatically after a delay of **120 seconds**. To stop the test mode before the end of delay:
 - press either left or right turn signal foot switch
- or
- turn the ignition switch to OFF
- or
- remove the parking brake.

8-14 CARE AND MAINTENANCE

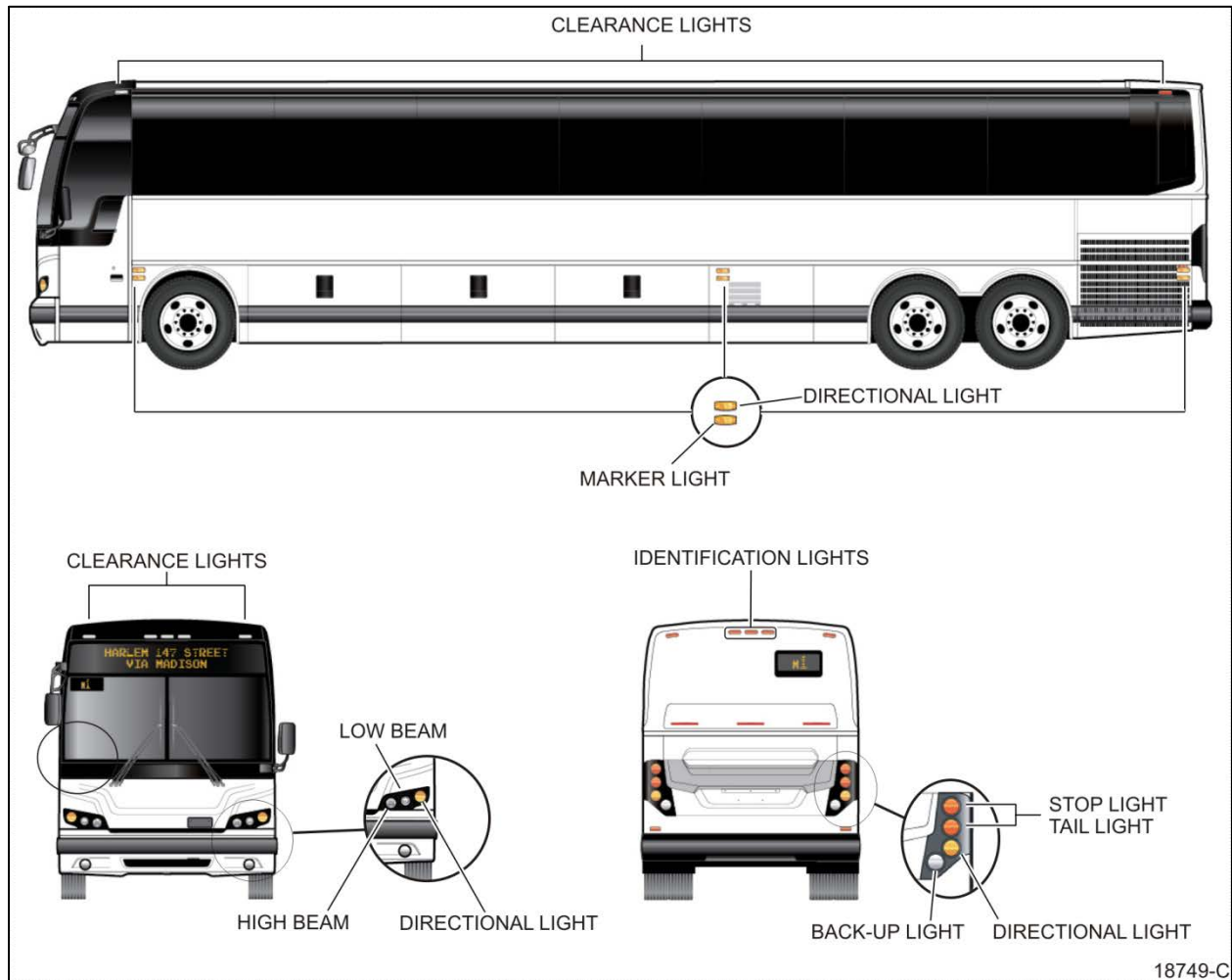

VARIOUS LIGHT LOCATIONS

FIRST SERVICE ON NEW VEHICLE

NOTE

Refer to *Maintenance Manual* for precise service schedule.

ENGINE OIL

Preliminary oil change is not required since the engine has been test-run at the factory. Change oil and filter as specified in Section 24 of the Maintenance Manual.

GENERAL RECOMMENDATIONS

- Understand basic principles of vehicle operation;
- Always maintain the vehicle in good running condition;
- Do not drive with low fuel. If the fuel tank runs dry, the engine will not start until the air is bled from the fuel system. Refer to "Maintenance Manual" for more information;
- Allow engine to run for at least two minutes at normal idle before shutting OFF;
- Engine should be at idle when shifting from neutral (N) to forward (D) or from neutral (N) to reverse (R);
- The automatic transmission does not have a park (P) position. Place transmission in neutral (N) position and apply parking brake when the vehicle is stopped. A warning buzzer will sound if the engine is stopped and the parking brake has not been applied when foot pressure is removed from the brake pedal;
- Always follow the procedures described in this manual;

- Unless stated otherwise, shut *OFF* the engine before performing all servicing, lubrication and maintenance tasks;
- Do not attempt to push or pull-start the coach;
- The vehicle may be damaged if towed with the axle shafts or driveshaft connected;
- The chemical fire extinguisher is located behind the driver's seat. In case of fire, immediately evacuate all occupants. Occupant safety is the first priority. Do not attempt to extinguish the fire if there is immediate danger or risk for personal injury;
- When driving on ice and snow, accelerate and decelerate gradually;



WARNING

Report all problems affecting passenger or driver safety to a Prevost service center or an authorized service center. Have problems corrected immediately.



COMPONENT IDENTIFICATION (REPRESENTATION MAY DIFFER SLIGHTLY FROM AN ACTUAL VEHICLE) 24039_4

1	Accessories air tank drain cock	22	Secondary fuel filter
2	Accessories air filter	23	Power steering fluid tank
3	Steering drag link	24	Engine oil filter
4	Height control valve (front)	25	Cooling fan gearbox
5	Steering tie rod	26	Allison transmission oil dipstick
6	Accessories air tank	27	Engine coolant surge tank
7	Steering column U-joints	28	Coolant filter & conditioner
8	Steering knuckle pins	29	Engine air filter restriction indicator
9	Steering damper cylinder	30	Engine air filter
10	Secondary air tank	31	Engine oil dipstick and filler tube
11	Kneeling air tank	32	DEF tank
12	Air dryer	33	Diesel particulate filter
13	Height control valve (rear)	34	SCR catalytic converter
14	Wet air tank	35	Diesel fuel tank
15	Primary air tank	36	Power steering pump
16	Differential	37	Air compressor
17	Propeller shaft	38	Alternators
18	Tag axle lever pivot	39	Emergency / parking Brakes Overrule Control Valve
19	Transmission	40	Air dryer purge tank
20	Starter	41	Haldex Consep® Condenser / Separator
21	Primary fuel filter		

WALK-AROUND INSPECTION (BEFORE EVERY TRIP)

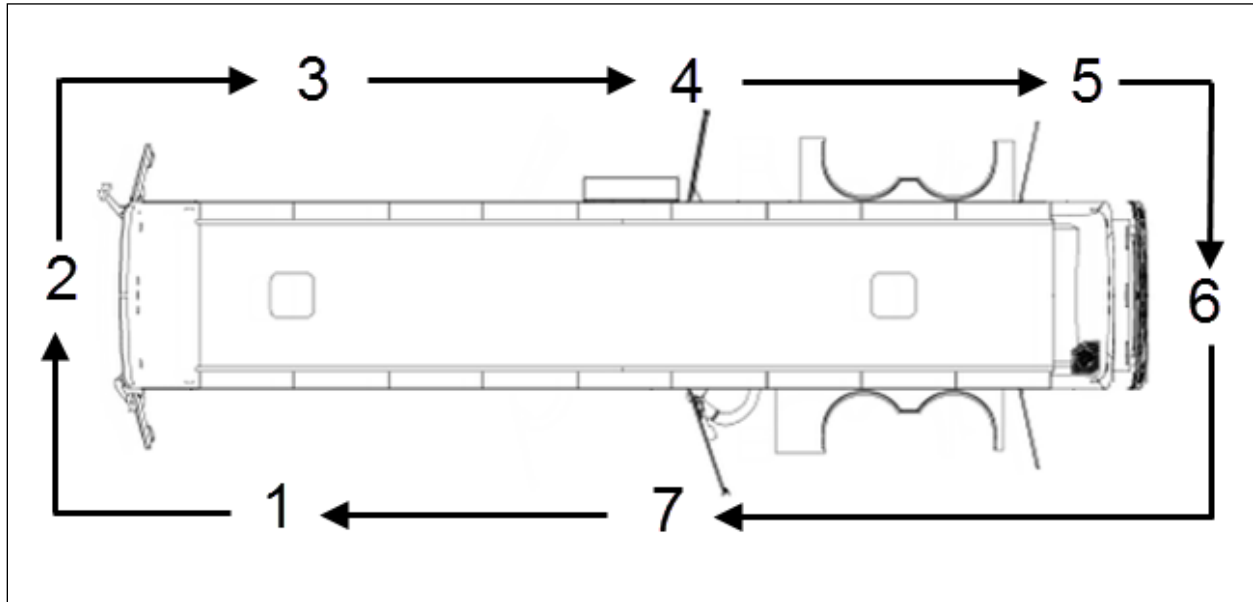

NOTE

Inspect the coach in a circular manner as shown in the illustration.

Approaching the Coach

- Check under the coach for oil, fuel, coolant leaks or other signs of damage.
- Check exterior body surfaces for signs of breaks or damage.

Preparation

- Drain accumulated water from accessories tank.
- Close air tank drain valves.
- Start the engine and let the air pressure build up to normal. Stop the engine.
- Switch on hazard warning flashers.
- Make sure parking brakes are applied.

Step 1: Front Left Side of the Coach

- Check condition of the wheel rim. Especially look for cracks, missing nuts, bent or broken studs.
- Check condition of tires: properly inflated, no serious cuts, bulges, tread wear or any signs of misalignment; valve stem not touching wheel or rim; valve cap in place.
- Check windshield washer reservoir fluid level and add if necessary.

Step 2: Front of the Coach

- Check for damage and clean if dirty.
- Check windshield wiper arms for proper spring tension.
- Check wiper blades for any damage, “dead” rubber and attachment to arm.
- Check clearance and identification lights, they should be clean, operating and of the proper color. Refer to “Exterior Lighting Verification” in this section.
- Turn on headlights. High and low beams should be operating and lenses clean. Refer to “Exterior Lighting Verification” in this section.
- Left and right front turn signal lights clean, operating and proper color. Refer to “Exterior Lighting Verification” this section.

Step 3: Front Right Side of the Coach

- Check condition of the wheel rim. Especially look for cracks, missing nuts, bent or broken studs.
- Check condition of tire: properly inflated, no serious cuts, bulges, tread wear or any signs of misalignment; valve stem not touching wheel or rim; valve cap in place.

Step 4: Rear Right Side of the Coach

- Check condition of wheels and rims. Especially look for cracks, missing nuts, bent or broken studs.
- Check that baggage and service compartment doors are properly closed and cable locks are in place.
- Check condition of tires: properly inflated, no serious cuts, bulges, tread wear or any signs of misalignment; valve stems not touching wheels or rims; valve caps in place and no objects stuck between the wheels.

Step 5: Engine Compartment Right Side Area

- Check engine and surrounding areas for coolant, oil and fuel leaks.
- Check fuel filter/water separator and drain if necessary. Check for leaks.
- Check wiring harness for signs of damage.

Step 6: Engine Compartment

- Check engine and surrounding areas for coolant, oil and fuel leaks.
- Check wiring harness for signs of damage.
- Check condition of drive belts.
- Check engine crankcase oil level, add if necessary.
- Check Allison transmission fluid level (can also be checked from push-button shift selector), add if necessary.
- Check power steering reservoir fluid level, add if necessary.
- Check coolant surge tank fluid level, add if necessary.
- Check air cleaner restriction indicator, replace air cleaner when red signal locks in full view.
- Check that exhaust aftertreatment system access door is properly closed.
- Check stop light, tail light, directional signal light and back-up light assembly; operating, clean and proper color. Refer to "Exterior Lighting Verification" in this section.

Step 7: Rear Left Side of the Coach

- Check condition of wheels and rims. Especially look for cracks, missing nuts, bent or broken studs.
- Check that baggage and service compartment doors are properly closed and cable locks are in place.
- Check that catalytic converter access door is properly closed.
- Check condition of tires: properly inflated, no serious cuts, bulges, tread wear or any signs of misalignment; valve stems not touching wheels or rims; valve caps in place and no objects stuck between the wheels.

Inside the Coach

- Check for proper operation of the entrance door.
- Check steps; clean them if there is any substance that makes them slippery, which makes coach entry/exit hazardous.
- Check that emergency exit windows and roof escape hatches can be open then close all windows and hatches securely.
- Verify the proper operation of the windshield wiper/ washer.
- Adjust and clean mirrors for adequate rear view vision.
- Start the engine and check for the proper operation of all gages and indicator lights.
- Check for the proper operation of electric horns and back-up alarm.

Perform a brake test. Check both primary and secondary pressure gages.

