



**SAFETY
RECALL**

SR17-05A

DATE :	March 2017	SECTION : 14 STEERING
SUBJECT:	STEERING ARM CRACKING ISSUE	

REVISION : A
08/14/2017

THIS BULLETIN SUPERSEDES PREVIOUS VERSION.
INSTALLATION section, step 1, sentence “*Replacement steering arms are identified with an “M” stamped on the machined surface*” removed. This stamping on the machined surface was a temporary measure. Proper replacement parts are no longer identified with the letter M.

APPLICATION

<p>NOTICE TO SERVICE CENTERS</p> <p><i>Verify vehicle eligibility by checking warranty bulletin status with SAP or via ONLINE WARRANTY SYSTEM available on Service / Warranty tab of PreVost website.</i></p>	
Model	VIN
	
H3-45 coaches Model Year: 2017	From 2PCH3349XHC71 <u>3478</u> up to 2PCH33498HC71 <u>3673</u> incl.
X3-45 coaches Model Year: 2017	From 2PCG33499HC73 <u>6116</u> up to 2PCG33497HC73 <u>6146</u> incl. and From 4RKG3349XH973 <u>7335</u> up to 4RKG33497H973 <u>7373</u> incl.
<p>This Safety Recall does not necessarily apply to all the above-mentioned vehicles, some vehicles may have been modified before delivery. The owners of the vehicles affected by this recall will be advised by a letter indicating the Vehicle Identification Number (VIN) of each vehicle concerned.</p>	

DESCRIPTION

On the vehicles affected by this bulletin, it is necessary to replace the steering arm (upper lever on L.H. knuckle).

This document describes the recommended steps for the replacement of the steering arm on the front axle.

MATERIAL

Kit "SR17-05" includes the following parts:

Part No.	Description	Qty
502104	COTTER PIN	1
611031	STEERING ARM, UPPER L.H. SIDE	1
611480	NUT, ¾ x 16	2

NOTE

Material can be obtained through regular channels.

PROCEDURE



DANGER

Park vehicle safely, apply parking brake, stop engine. Prior to working on the vehicle, set the ignition switch to the OFF position and trip the main circuit breakers equipped with a trip button. On Commuter type vehicles, set the battery master switch (master cut-out) to the OFF position.

REMOVAL

1. The steering arm is fixed to the L.H. knuckle with two studs and two nuts (p/n 611480). There is no Loctite used in this assembly.

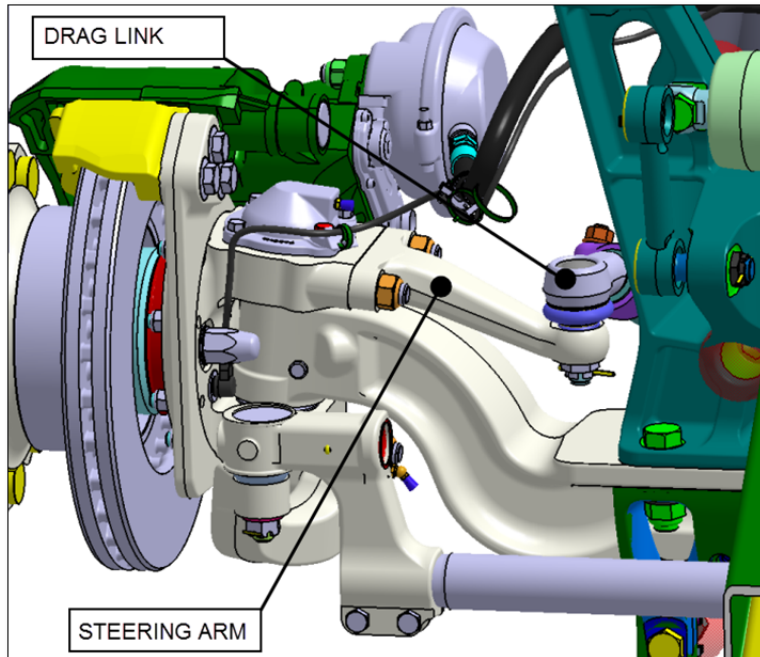

FIGURE 1

2. Raise the vehicle. Support the front of the vehicle from under the **front axle beam**.
3. To gain access to the steering arm nuts, turn the wheels to the left by pushing directly on the front wheels.

NOTE

An alternate method consists in keeping the vehicle on the floor level. Lift and support the left side of the front axle beam with appropriate jack stands and then remove the front L.H. wheel.

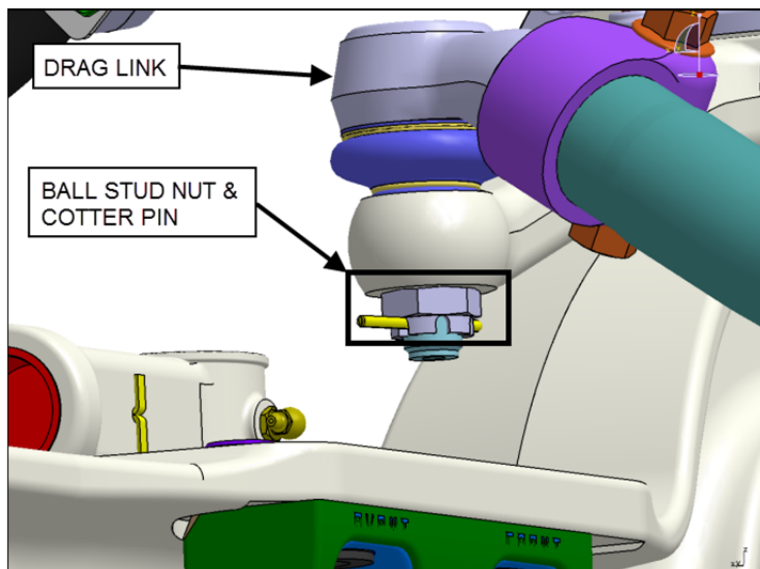

FIGURE 2

4. Remove the cotter pin and then unscrew the drag link ball stud nut (**FIGURE 2**).

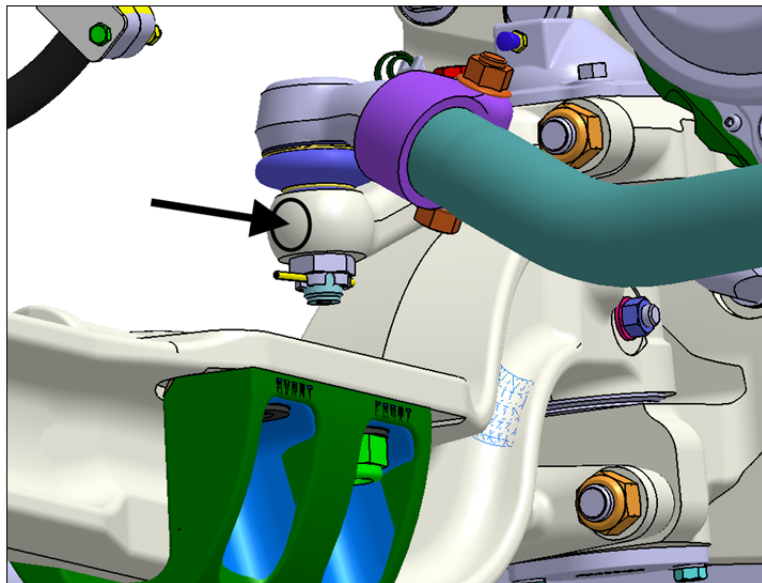

FIGURE 3 : TAP THE SIDE OF THE STEERING ARM TO UNDO THE TAPERED JOINT

5. Disconnect the drag link from the steering arm. Using a hide faced mallet, tap the side of the steering arm to undo the tapered joint (see **FIGURE 3**).

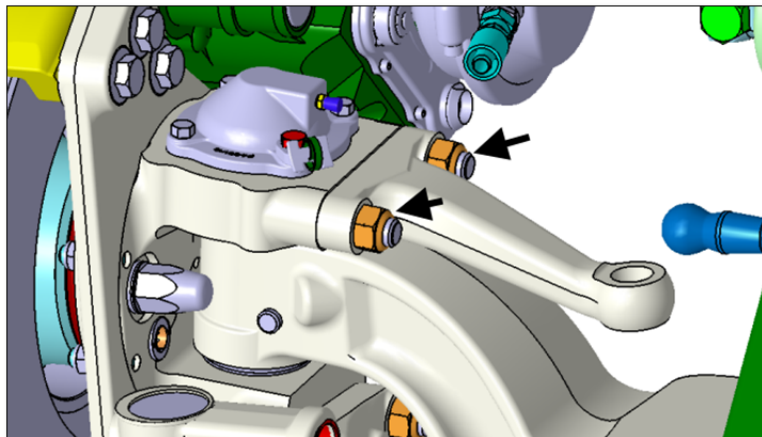

FIGURE 4 : UNSCREW THE STEERING ARM NUTS

6. Using a suitable socket, unscrew the steering arm nuts (nuts are tightened to 285-315 lbf-ft) (**FIGURE 4**).
7. Discard the steering arm nuts.
8. Using a hide faced mallet, tap the steering arm to loosen it from the knuckle face. Do not strike the steering arm with a steel hammer.
9. Carefully remove the steering arm.



CAUTION

Defective steering arm shall never be reused. To prevent it from being reused, apply red paint on the steering arm. DO NOT DISCARD THE STEERING ARM. The steering arm must be returned to Prevost.

10. Using an engine degreaser, properly clean:

- The contact surface between the knuckle and the steering arm;
- On the knuckle, the stud threading (two studs);
- The new nuts threading (two nuts).

Allow to dry

The hardware threading must be free from oil or any other type of protective coating.

11. Check that the threading on the studs is not damaged.

INSTALLATION

1. Install the replacement steering arm on the studs.

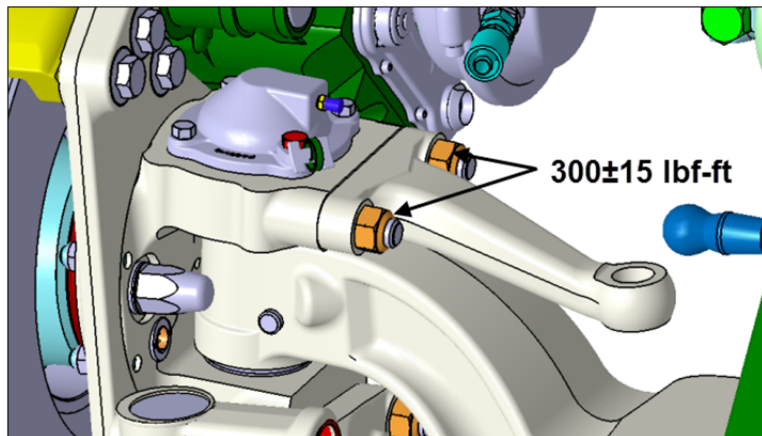

FIGURE 5

2. Fix the steering arm with two new nuts (p/n 611480) and tighten to specified dry thread torque: **300±15 lbf-ft (FIGURE 5)**.
3. If the steering arm is not pre-painted, use a good quality spray paint and cover the entire exposed surface except the boring where the drag link ball will be fitted.
4. Using engine degreaser, clean the drag link **stud threads** and **conical area**. Allow to dry.
5. Connect the drag link to the steering arm.

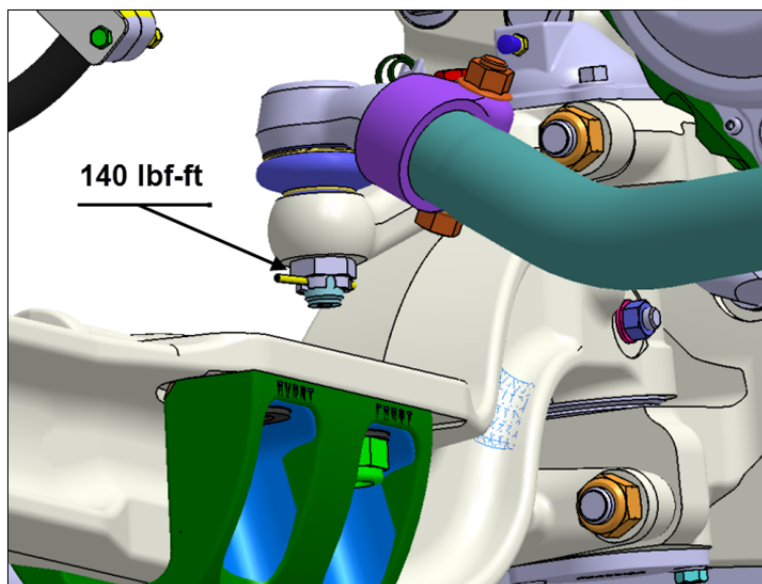

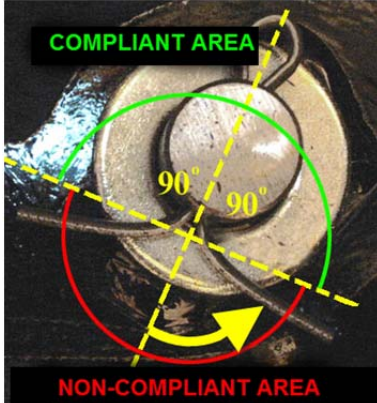
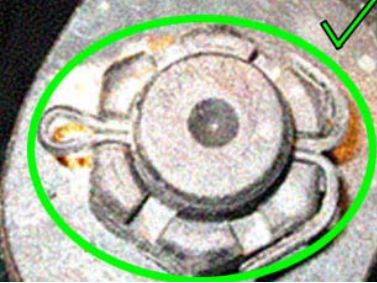
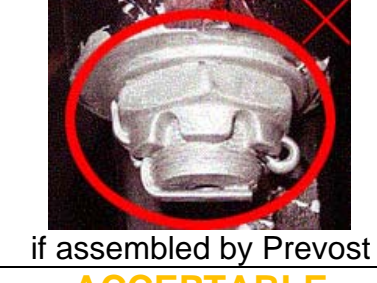



FIGURE 6

6. Tighten the ball stud nut to specified dry thread torque: **140 lbf-ft (FIGURE 6)**.

7. Insert the cotter pin (p/n 502104) through the nut and the ball stud. If the cotter pin cannot be inserted, tighten the nut to next available position.
8. Bend the cotter pin prongs in accordance with the following specifications:

The cutter pin prongs should be bended 90° or more to insure proper locking effect (see pictures below). The cutter pins should not be used twice or bended in such a way that they become ineffective.

<p>Prongs must be bended at an angle of 90° or more</p>	<p style="text-align: center;">ACCEPTED</p> 	<p style="text-align: center;">REJECTED</p> 
<p>Assembly on castellated nut</p>	<p style="text-align: center;">ACCEPTED</p> 	<p style="text-align: center;">REJECTED</p>  <p style="text-align: center;">if assembled by Prevost</p> <p style="text-align: center;">ACCEPTABLE</p>  <p style="text-align: center;">if assembled by supplier</p>

PARTS / WASTE DISPOSAL

The steering arm must be returned to Prevost according to the Return Shipping Instructions available on <https://www.prevostcar.com/content/warranty-documents> for full reimbursement. A copy of the warranty claim form must be enclosed with the shipment.

WARRANTY

This modification is covered by Prevost's normal warranty. We will reimburse you the parts and one hour(s) (1.0) of labor upon receipt of the defective steering arm and a completed A.F.A. Please submit claim via our Online Warranty System, available at www.prevostcar.com (under service \ warranty section). Use Claim Type: "Bulletin/Recall" and select "Safety Recall SR17-05".

Should you only wish to close the safety recall (without reimbursement), fill-in the "Safety Recall Certification Sheet" provided with this bulletin and return it to our warranty department by Email at prevost.onlinewarranty@volvo.com or by fax at 418-831-9301.

OTHER

VBC Bulletin	N/A
Fail Code	14.04
Defect Code	09
Syst.Cond	R
Causal Part	611031

Access all our Service Bulletins on
<http://techpub.prevostcar.com/en/>
or scan the QR-Code with your smart phone.

E-mail us at technicalpublications_prev@volvo.com and type
"ADD" in the subject to receive our warranty bulletins by e-mail.



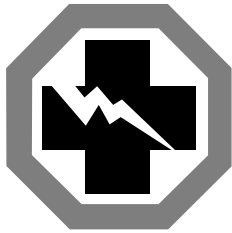

Safety Recall Certification Sheet (Ref: SR17-05)

VEHICLE SERIAL NUMBER:

2	P	C																		
---	---	---	--	--	--	--	--	--	--	--	--	--	--	--	--	--	--	--	--	--

PERFORMED BY		OWNER/OPERATOR	
We hereby certify that Safety Recall Instructions with regard to Safety Recall SR17-05 have been performed.			
Name: _____		Name: _____	
Addr: _____		Addr: _____	
Phone: _____		Phone: _____	
Fax: _____		Fax: _____	
Signature : _____		Signature : _____	
Date: _____		Date: _____	

If the information mentioned above is incorrect or you are not the owner of this vehicle anymore, please fill this section and return to sender.

NEW OWNER: _____

BUSINESS: _____

ADDRESS (including County): _____

TELEPHONE: _____ **FAX:** _____

Please return this completed document with your A.F.A. form