



PREVOST

MAINTENANCE INFORMATION

MI20-15

DATE :	NOVEMBER 2020	SECTION: 18 - Body
SUBJECT :	GLUED FIXED THERMOS WINDOW REPLACEMENT - INSTALLATION/GLUING PROCEDURE	

APPLICATION

Model	VIN	
PREVOST X3-45 COMMUTER	DOB 1300-1606	Contract : B40665, B40668

1.	DESCRIPTION.....	2
	FIXED THERMOS WINDOW PANE	2
2.	PARTS NEEDED	3
3.	MATERIAL & TOOLS	3
4.	PROCEDURE	6
	INTERIOR TRIM REMOVAL	6
	BROKEN WINDOW REMOVAL.....	9
	FRAME PREPARATION	9
	WINDOW PREPARATION	13
	GLUING	17
	SEALANT APPLICATION	22
	INTERIOR TRIMS INSTALLATION	24
5.	PARTS / WASTE DISPOSAL.....	26
6.	APPENDIX.....	27
	GENERAL HEALTH & SAFETY / ENVIRONMENTAL INFORMATION.....	27
	Working environment.....	27
	General information for products cleaning / surface preparation.....	27
	GOOD BONDING PRACTICE - TRIANGULAR BEAD APPLICATION	28
	GOOD BONDING PRACTICE – USE OF SURFACE PREPARATION PRODUCTS	29
	GOOD PRACTICES – USE OF ADHESIVE & SEALANT PRODUCTS	31
	PRODUCT DATE VERIFICATION GUIDE.....	32

1. DESCRIPTION

Use this procedure to perform the replacement of glued fixed thermos window. This procedure may also be used for the replacement of non-thermos fixed window, as the installation method is similar.

FIXED THERMOS WINDOW PANE

When replacing a broken fixed thermos window, refer to the Parts Manual to select the appropriate fixed window. The pre-assembled fixed thermos windows come with the upper aluminum extrusion already glued on the windowpane. The aluminum extrusion will assure perfect vertical positioning and support the windowpane during adhesive curing.

Four different fixed windows are available depending on the location:

Driver side: p/n 290774 (2nd, 3rd & 5th window)

Passenger side p/n 290774 (2nd window)
p/n 290757 (3rd window)
p/n 290758 (5th window)

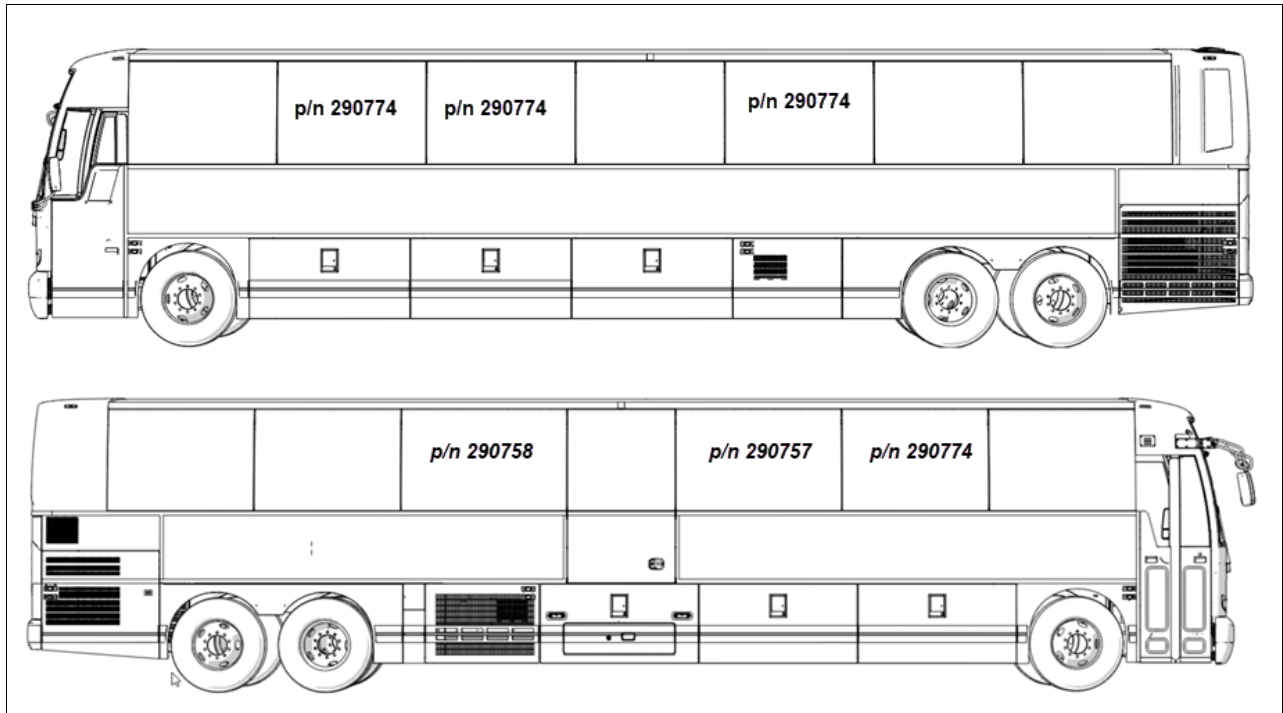

Figure 1: available fixed window part numbers

2. PARTS NEEDED

Order the following parts:











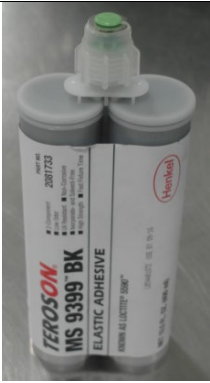





Part No.	Description	Qty
-	WINDOW, FIXED – refer to paragraph Fixed Thermos Window Pane	1
500345	WASHER, FINISHING	4
504108	RIVET POP DOME AL OE 1/8	4
504228	RIVET POP DOME AL OE BK 1/8 (0.376_0.500)	4
790034	SPACER	2
5001970	WASHER, FINISHING	4



3. MATERIAL & TOOLS

Part No	Description	Qty
ADHESIVE		
685387	TEROSON MS9399 MS-POLYMER (<i>twin tube 400 ml</i>)	a.r.
SEALANT		
684685	SEALANT, SIMSON ISR 70-03 BLACK (<i>tube 290 ml</i>)	a.r.
PRIMER		
687965	TEROSON PRIMER PU 8519 P (<i>500 ml bottle</i>)	a.r.
CLEANER		
682989	SILICONE REMOVER (ANTI-SILICONE) <i>5 liters</i>	a.r.
APPLICATOR / TIP		
687958	QUATTRO MIXER/APPLICATOR with V-TIP (<i>1 unit</i>)	a.r.
CLOTH		
682383	BLUE CLOTH (<i>17"x17", 400 units</i>)	a.r.
682384	CHIX CLOTH (<i>11"x15", 600 units</i>)	a.r.

NOTE

Material can be obtained through regular channels.

 <p>#687957 TEROSON MS9399 MS-POLYMER</p>	 <p>#687958 QUATTRO MIXER WITH V-TIP</p>	 <p>#682989 SILICONE REMOVER (ANTI-SILICONE) 5 LITERS</p>	 <p>#684685 SEALANT SIMSON ISR 70-03 BLACK 290ml</p>
 <p>TOOL 400 ml DUAL CARTRIDGE PNEUMATIC APPLICATOR (PREVOST #688467)</p>	 <p>TEROSON PRIMER PU 8519 P</p>	 <p>#682384 CHIX CLOTH</p>	 <p>#682383 BLUE CLOTH</p>
 <p>GLASS CLEANER</p>	 <p>CUTTER</p>	 <p>ALUMINUM STRAIGHT EDGE</p>	 <p>RULER</p>
 <p>CORDLESS DRILL & BITS</p>	 <p>RIVETER</p>	 <p>DRILL BIT SET - METRIC OR SAE</p>	<p>CAULKING GUN</p> 

 <p>PHILLIPS SCREWDRIVER</p>	 <p>MASKING TAPE</p>	 <p>TOOL PUTTY KNIFE</p>	
--	--	---	--

4. PROCEDURE



DANGER

Park vehicle safely, apply parking brake, stop the engine. Prior to working on the vehicle, set the ignition switch to the OFF position and trip the main circuit breakers equipped with a trip button. On Commuter type vehicles, set the battery master switch (master cutout) to the OFF position.

INTERIOR TRIM REMOVAL

1. Inside the vehicle, remove all the finishing trims around the window. Drill the rivets where applicable.

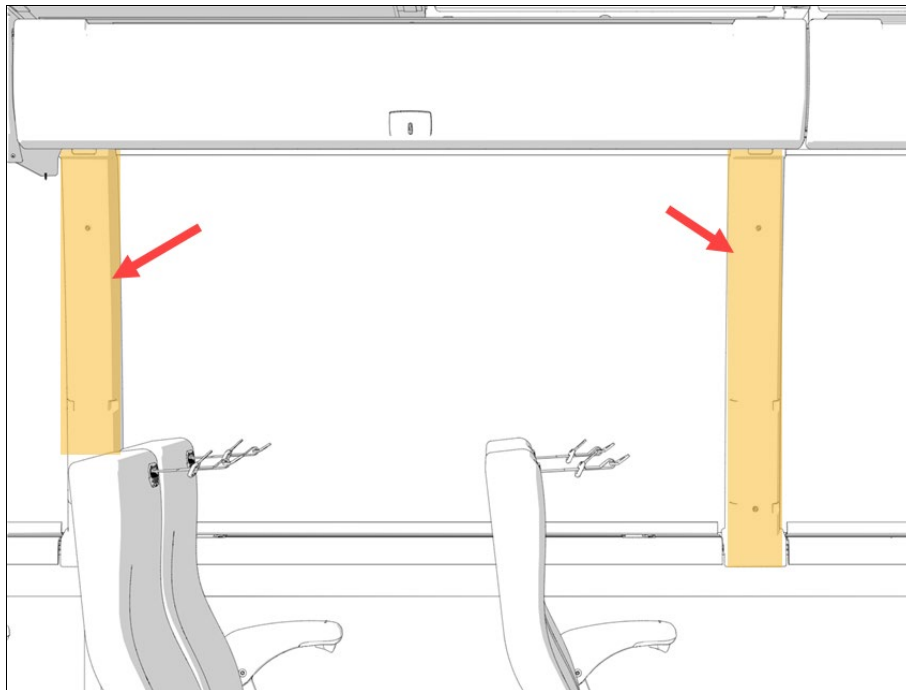

Figure 2: finishing trims

2. Inside the vehicle, remove the extrusion at the bottom of the window.

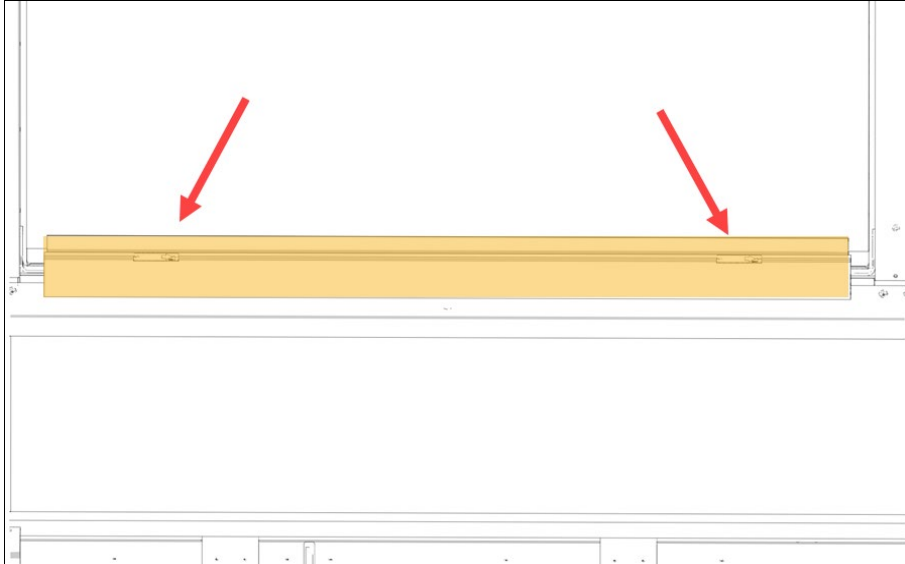

Figure 3: extrusion

- a) First, remove the **two warning plates**. To do so, drill the rivets on the two warning plates.

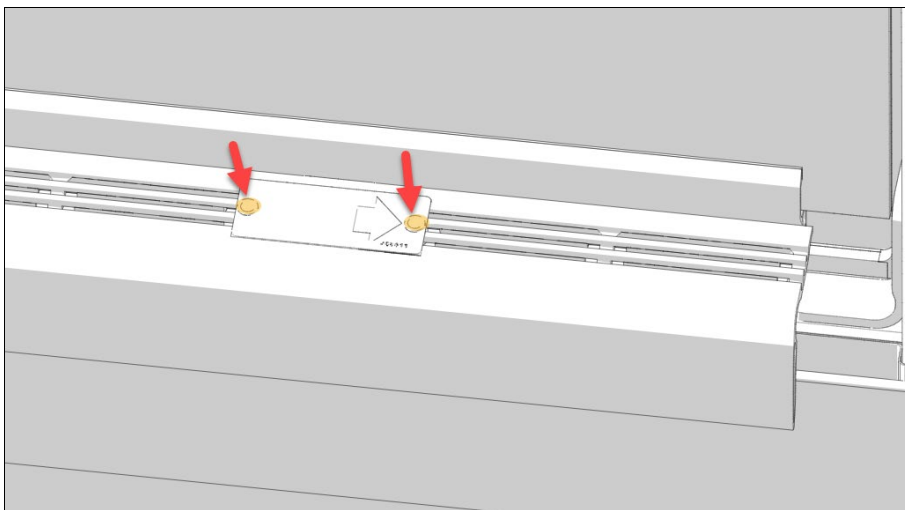

Figure 4: warning plate

- b) Under each warning plates, you will find a screw. Unscrew and then remove the extrusion. Keep hardware for reuse.

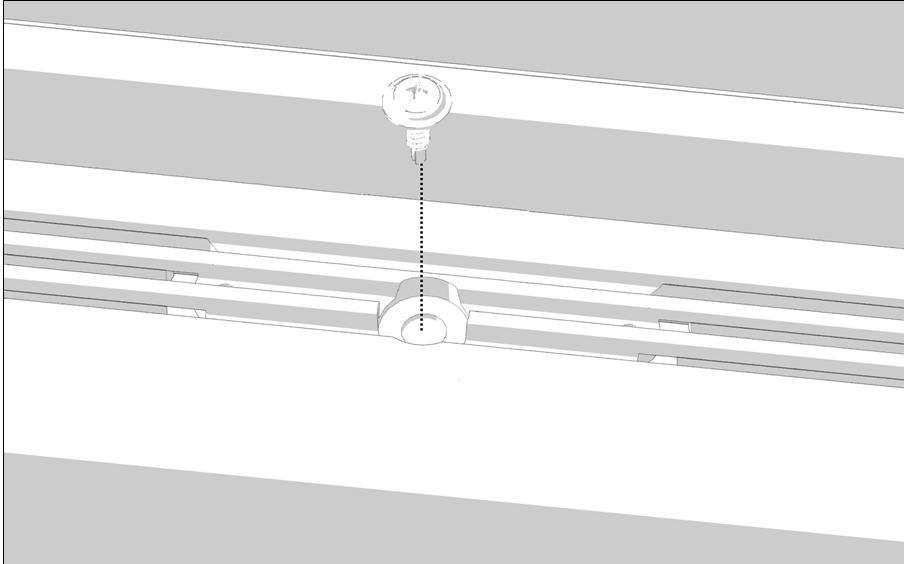

Figure 5: screw under warning plate

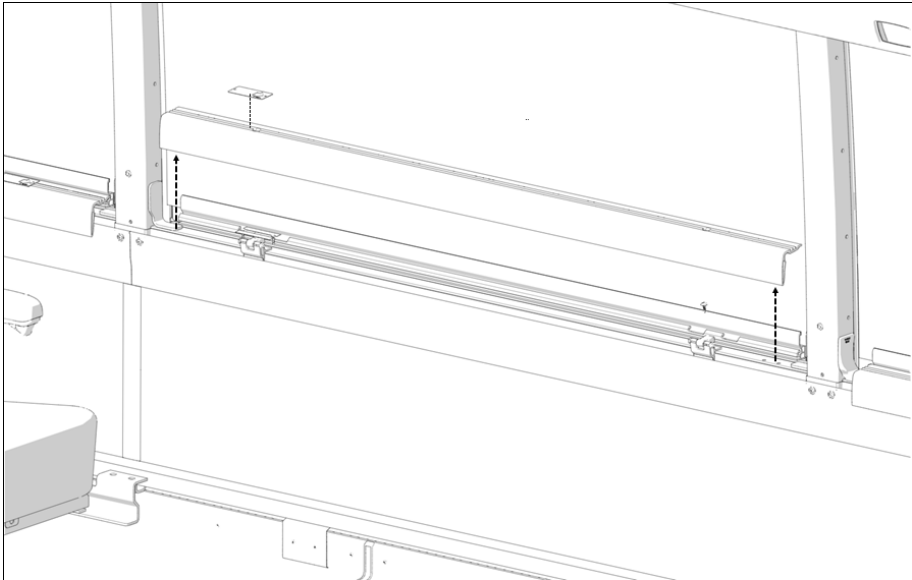

Figure 6: remove the extrusion

BROKEN WINDOW REMOVAL

3. Remove all debris of broken window if applicable.
4. Remove adhesive/sealant on the involved structural members using a putty knife. Read the note below first.

NOTE

Good adherence of glue to surface. Remove excess of glue using a putty knife. It is acceptable to leave a thin layer of glue on the surface instead of breaking the surface of adherence with the blade. If primed surface is slightly scratched: Accept as it is.

If glue or primer become unstuck. Remove glue locally and sand defective area

FRAME PREPARATION

5. Read GENERAL HEALTH & SAFETY / ENVIRONMENTAL INFORMATION in Appendix.
6. The vertical rubber seal found on the L.H. and R.H. side vertical members must be left in place.

NOTE

Rubber seal is stick to the structural member with pre-applied double face adhesive tape

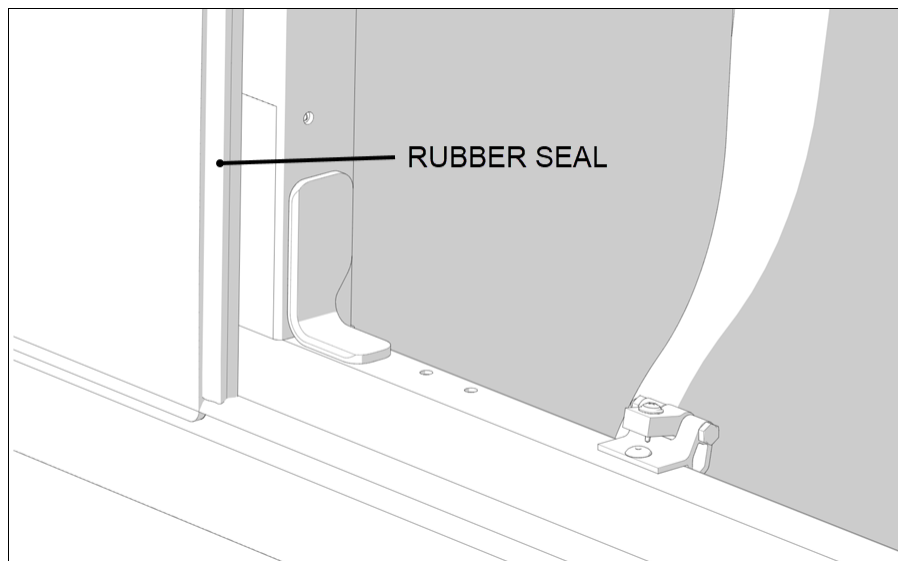

FIGURE 7 : rubber seal

7. To avoid weak bonding, thoroughly clean the old adhesive layer on the structural member identified in Figure 8 and Figure 9 with silicone remover (anti-silicone) p/n 682989 and clean Chix clothes. Wipe and dry surfaces with clean blue clothes.

NOTE

For silicone remover (anti-silicone) application technique, refer to GOOD BONDING PRACTICE – USE OF SURFACE PREPARATION PRODUCTS Section A in Appendix.

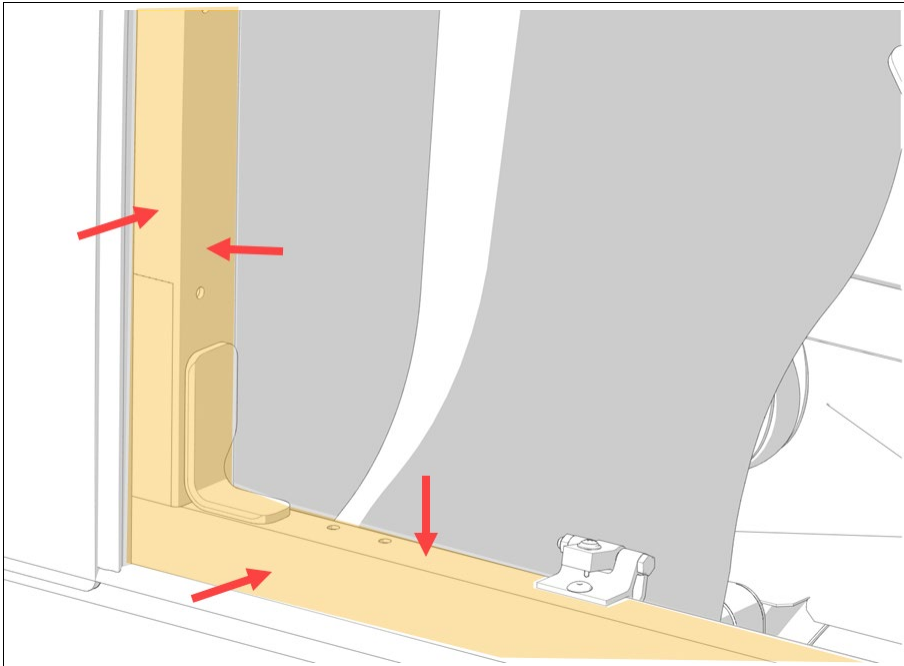

Figure 8: clean all around the inner and outer surface of the frame

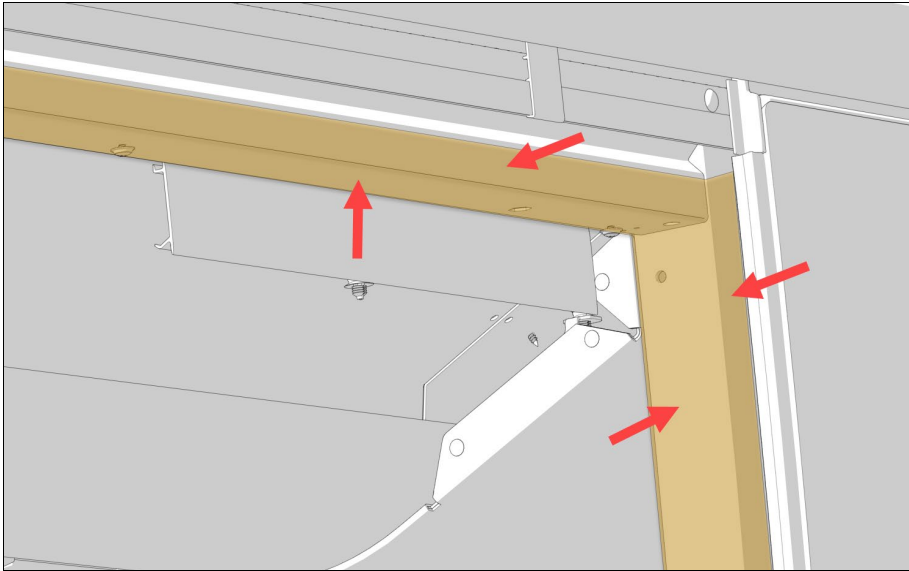

Figure 9: clean all around the inner and outer surface of the frame

8. On the frame surfaces shown, apply masking tape to protect from glue smears.

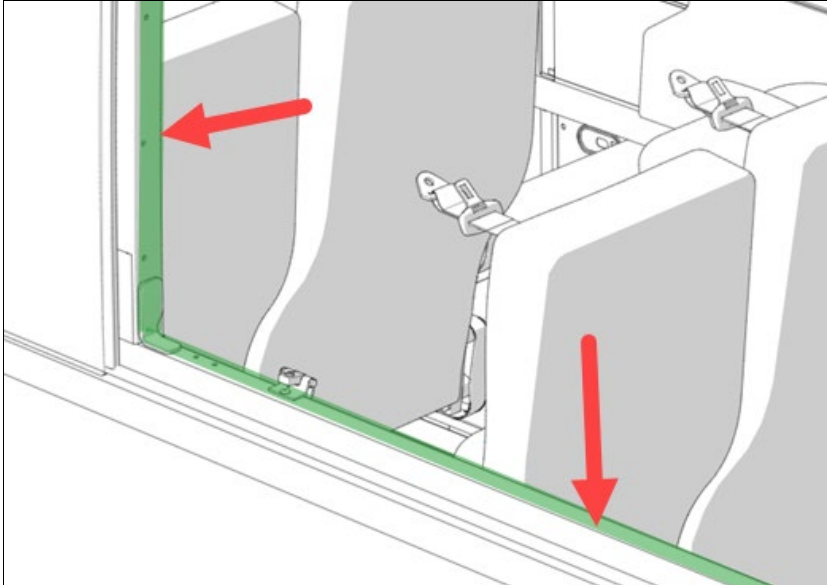

Figure 10: masking tape application

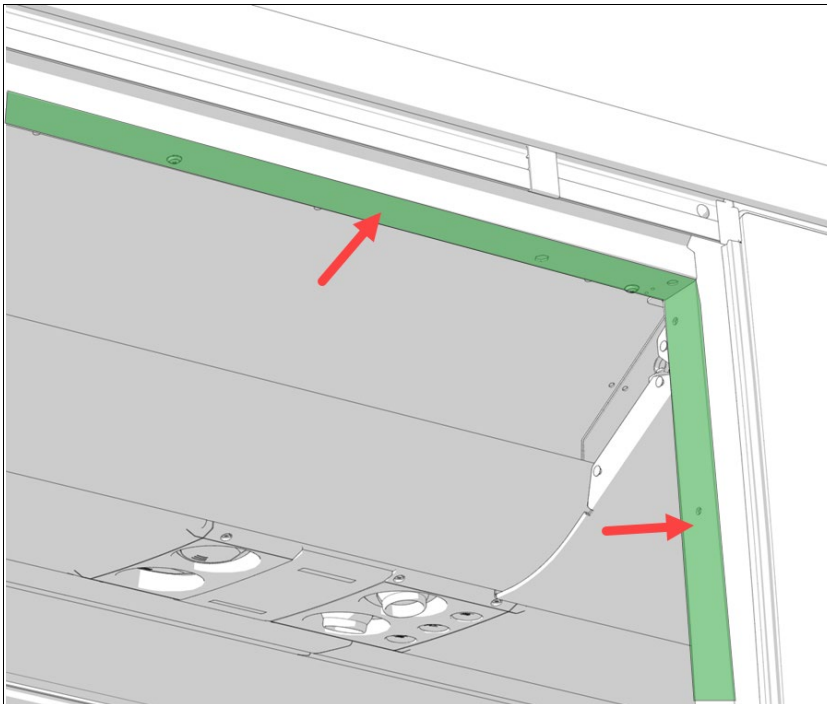

Figure 11: masking tape application

9. With a pencil, mark the outer frame for later glue application as follows:

Top member: 14 mm from the edge

Bottom member: 15 mm from the edge

Right vertical member: 11 mm from the edge

Left vertical member: 11 mm from the edge

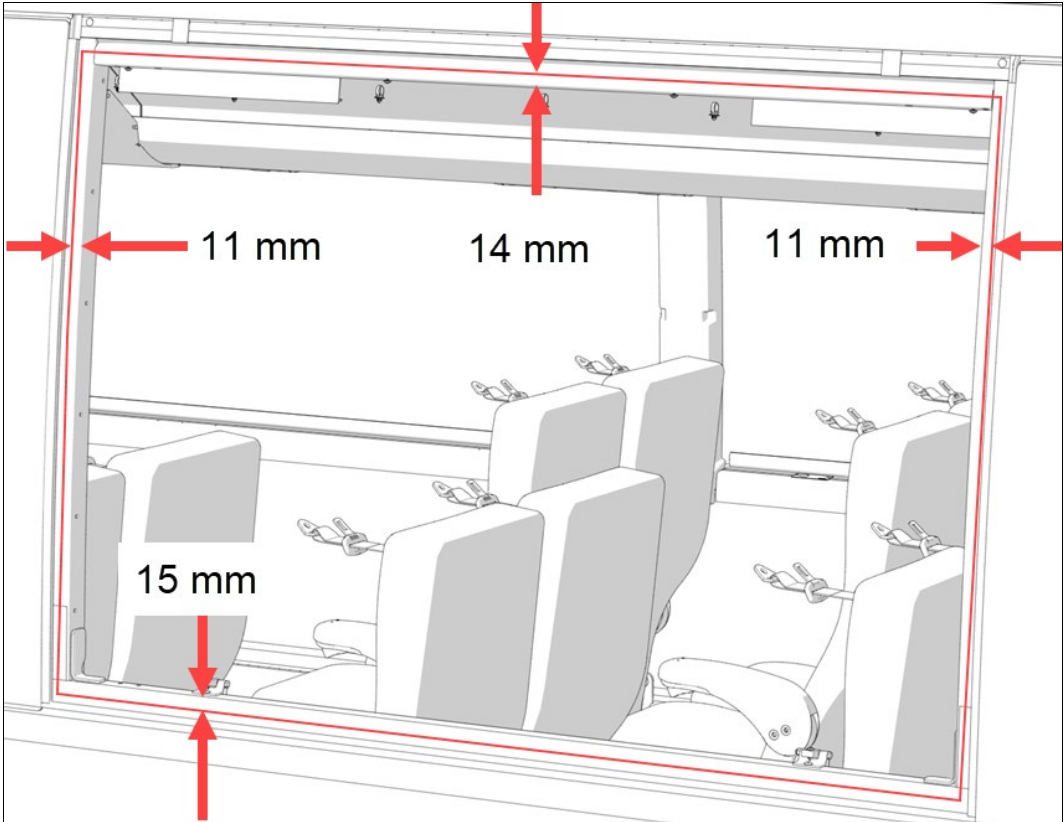

Figure 12 : marking the glue bean position with a pencil

WINDOW PREPARATION

10. In preparation to adhesive application, clean the identified area on the inner side of the windowpane i.e. plastic slat, using silicone remover (anti-silicone) 622989 (refer to Figure 13).

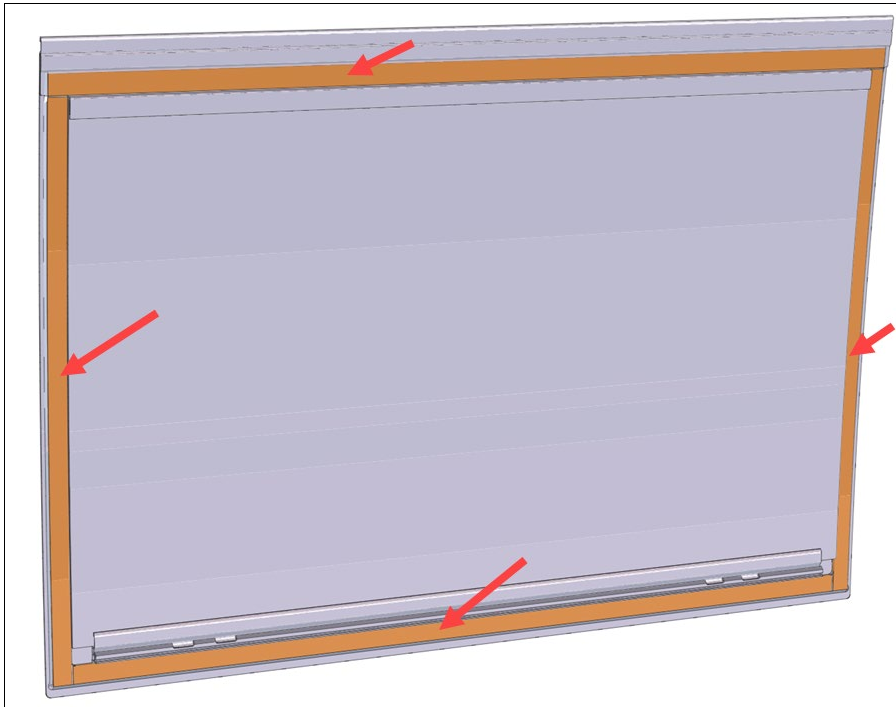

Figure 13 : plastic slat

11. Apply TEROSON PU 8519 P primer p/n 687965 on the identified area (plastic slat) on the inner side of the windowpane. Allow to dry for 2 minutes. CHECK PRODUCT EXPIRY DATE FIRST.

NOTE

For TEROSON PU 8519 P primer application technique, refer to GOOD BONDING PRACTICE – USE OF SURFACE PREPARATION PRODUCTS Section K & PRODUCT DATE VERIFICATION GUIDE in Appendix.

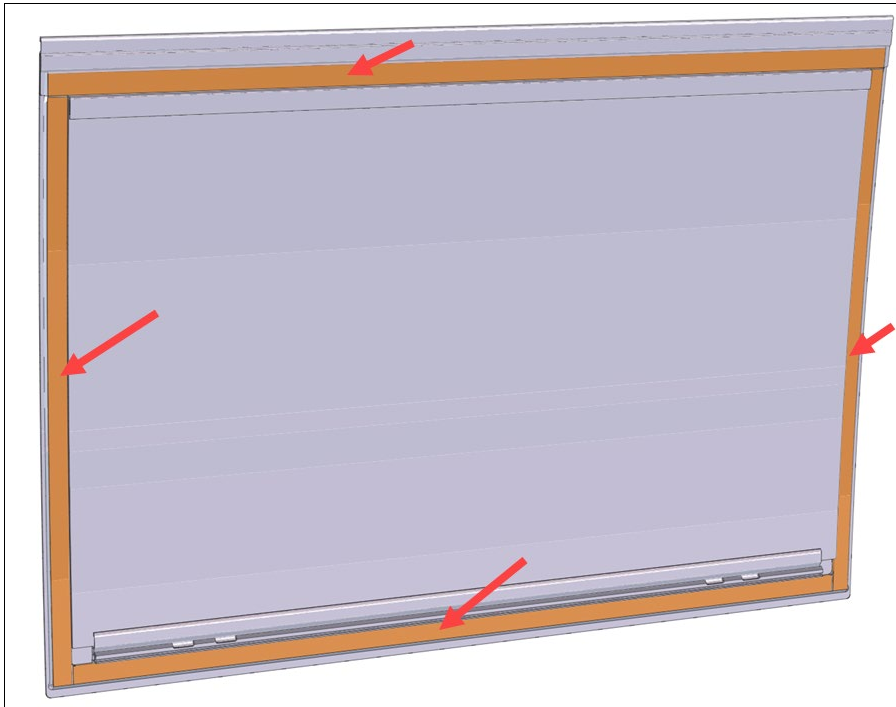

Figure 14 : plastic slat

12. Peel off the back protective film of two spacers 790034 and stick flush with the outer edge of the vertical plastic slats, 548 ± 15 mm from the bottom of the window.

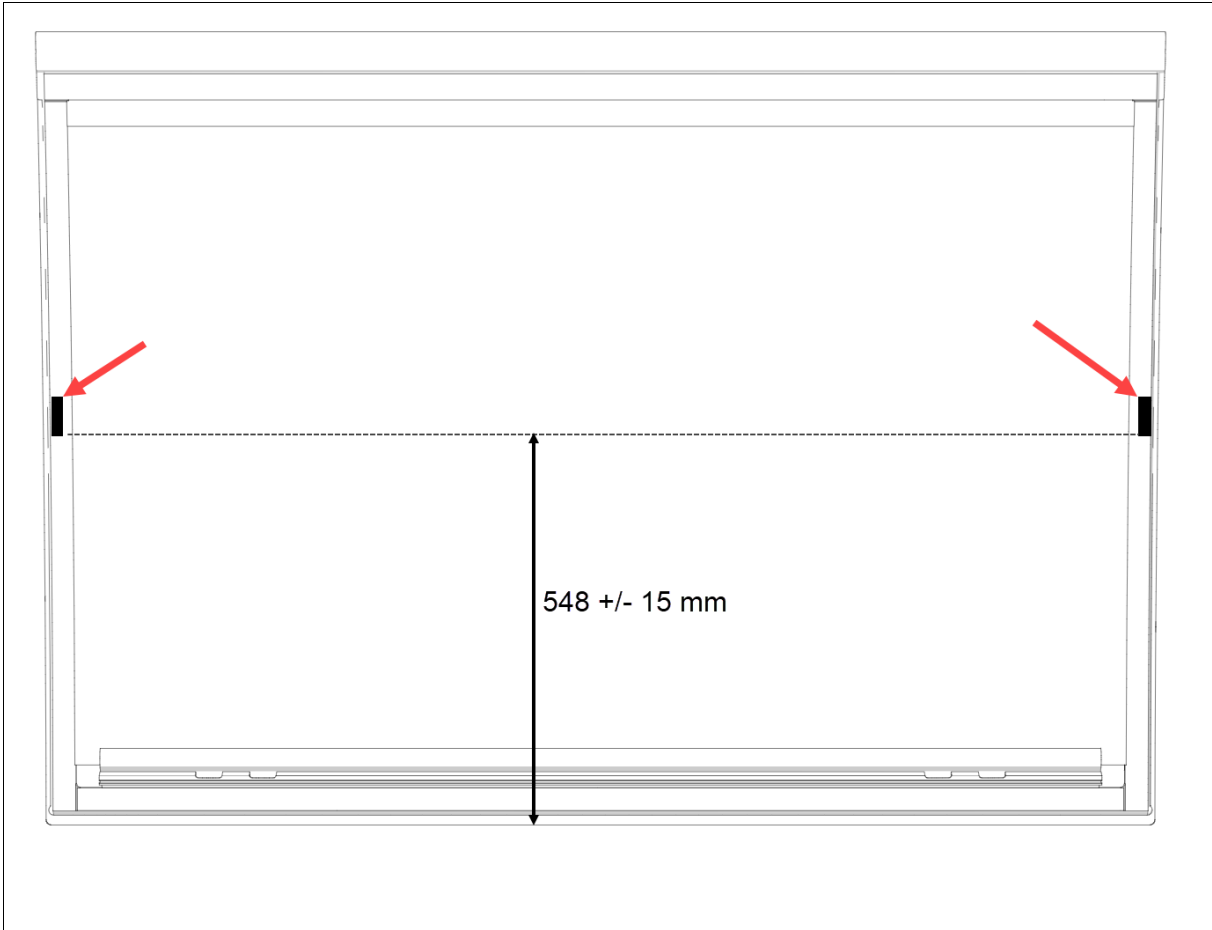

Figure 15 : two spacers 790034

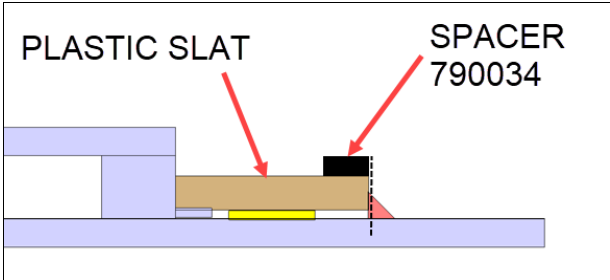

Figure 16 : spacer position

13. On the inner side of the window, apply masking tape on the glass as shown on the image below to protect from glue smears.



Figure 17: masking tape applied

GLUING

14. The adhesive must be applied in a triangular shaped bead of **18 mm X 12 mm** as shown on **FIGURE 18**. Using a cutter, cut the QUATTRO MIXER V-TIP #687958 to match these measurements.

ADHESIVE

#687957 TEROSON MS9399 MS-POLYMER

- Must be applied using special mixer/applicator #687958 with v-tip.
- **Open time: 18 minutes**
- **Clamping time: 90 minutes**
- Vehicle stop time (No driving with vehicle): 90 minutes.
- Cleaning: clean spills with **silicone remover (anti-silicone)**.
- Smoothing: use water or soapy water on a clean cloth.

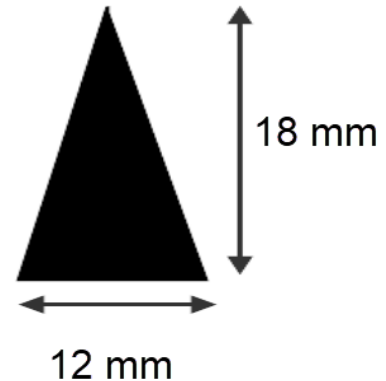

FIGURE 18

ADHESIVE OPEN TIME: the time interval after the application of the adhesive during which successful bonding of substrates can occur.

ADHESIVE OPEN TIME =18 min. max TEROSON MS9399 MS-POLYMER

15. Apply a **continuous** triangular bead of adhesive along the pencil marks previously done. CHECK PRODUCT EXPIRY DATE FIRST.

NOTE

*Refer to **PRODUCT DATE VERIFICATION GUIDE** in Appendix.*

NOTE

*For **TEROSON MS9399 MS-POLYMER** application technique, refer to **GOOD PRACTICES – USE OF ADHESIVE & SEALANT PRODUCTS**.*

NOTE

The adhesive bead must be done carefully to prevent water infiltration.

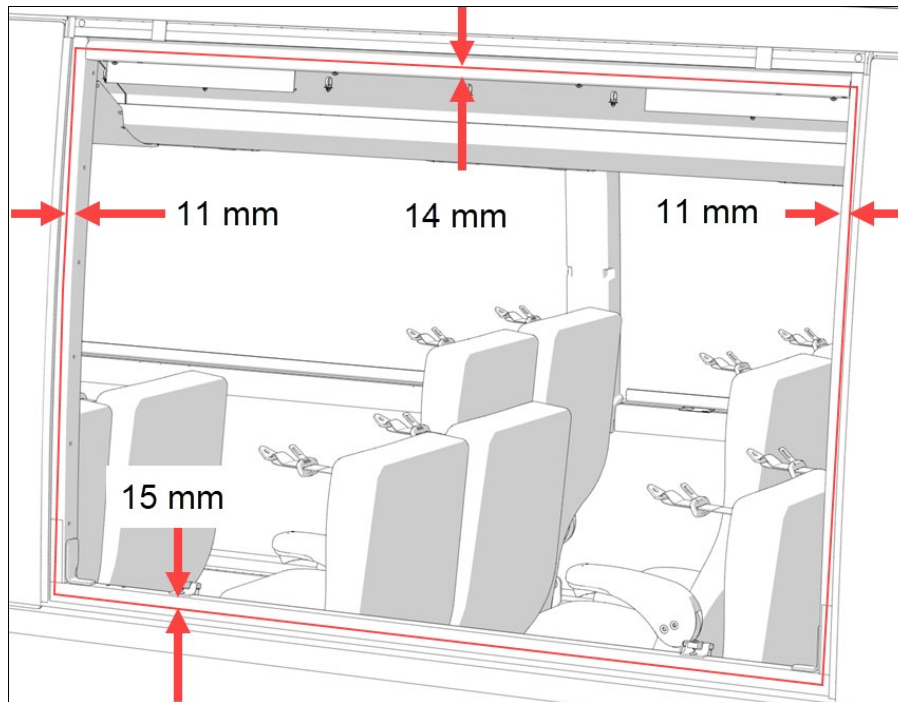

Figure 19

16. Install the window on the structure. Ideally, you would use suction cups (Figure 21) to manipulate the window. Using the aluminum extrusion already fixed to the windowpane, hook the window to the rail found on the vehicle upper horizontal member (Figure 20). **DO NOT PRESS THE WINDOW AGAINST THE FRAME AT THIS MOMENT.**

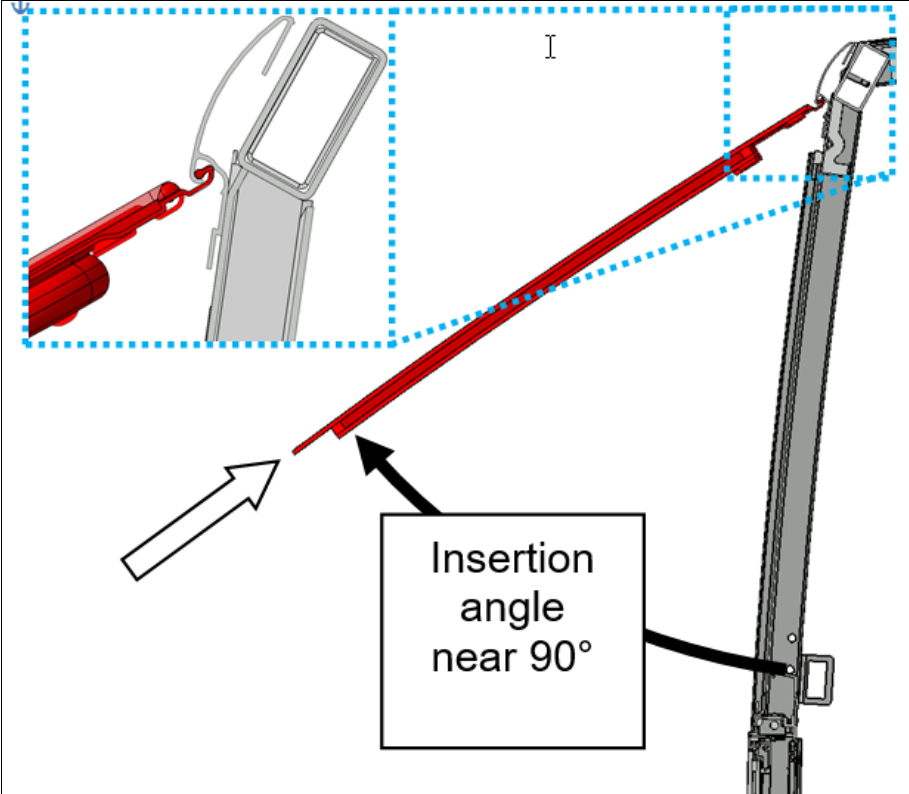

Figure 20



Figure 21: hand suction cup

17. Before pressing the window against the frame, make sure the existing locking piece 290254 shown on the following images are in place, at 150 mm from the R.H & L.H. window edges.

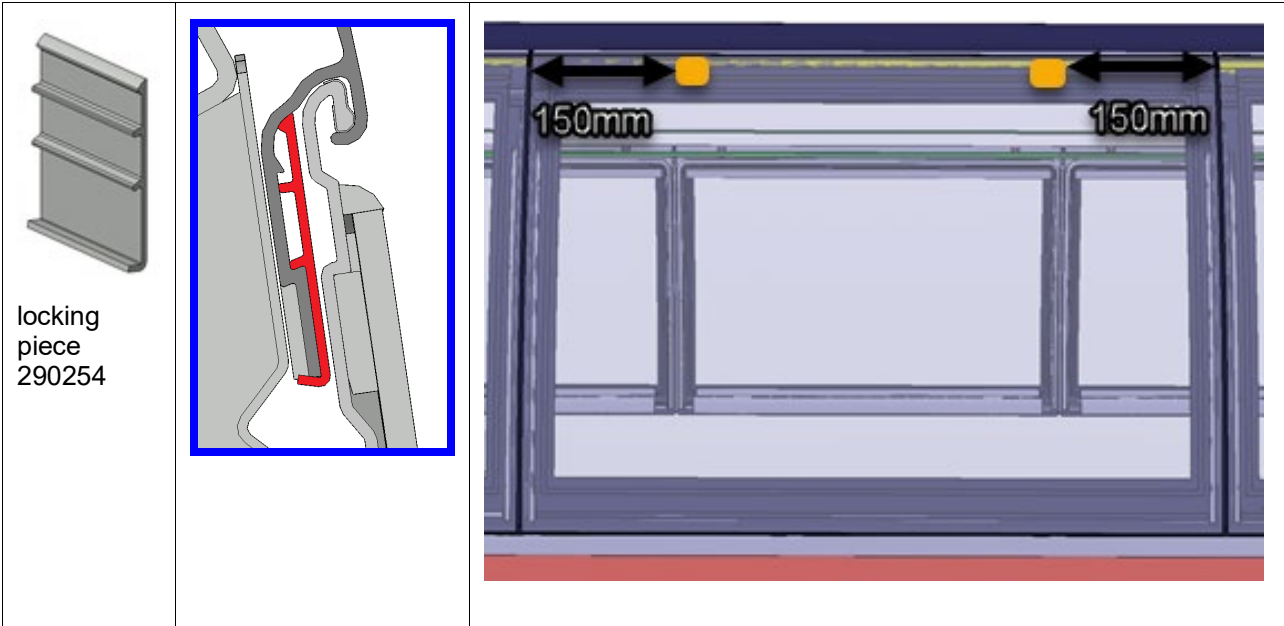
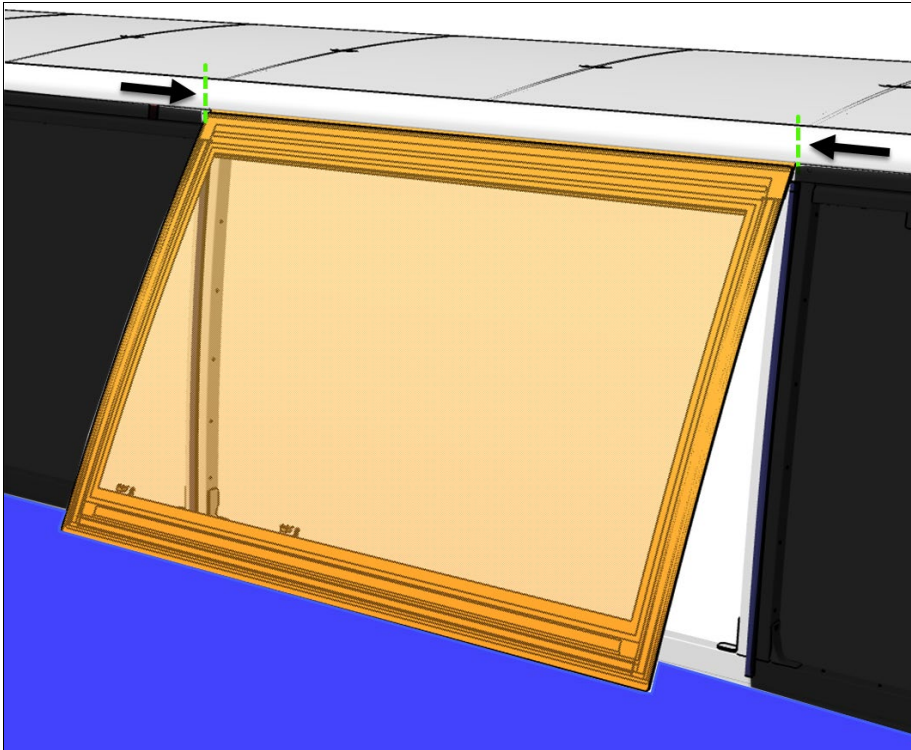



Figure 22

18. Place the window centered between the two adjacent windows before pressing the fixed window against structure. The gaps found on the right side and the left side should be equal. The window edges should be parallel.



 **CAUTION**

Never raise a window once it has been pressed against the structure because the adhesive joint would break.

19. Press the window against the frame. Check window alignment (flatness) with adjacent windows or panels. Using a small ruler (to prevent scratching, do not use a metal ruler onto glass), make sure the windowpane is flush with the windows located on each side of it. Allow enough clamping time for adhesive curing.

TEROSON MS9399 MS-POLYMER

- Clamping time: 90 minutes.

On FIGURE 23, a special jig equipped with suction cups is used to clamp/hold the fixed window on the structural members from inside.



FIGURE 23

SEALANT APPLICATION

20. On the inner frame surfaces and the inner side of the window, apply masking tape to protect from glue smears.
21. **Allow 60 minutes before performing this step.** While the adhesive is curing, from the interior of the bus, fill the gap between the thermos window and the surrounding structural members with **sealant Simson ISR 70-03** (fill the whole window perimeter to ensure water tightness). CHECK PRODUCT EXPIRY DATE FIRST.

NOTE

Refer to PRODUCT DATE VERIFICATION GUIDE in Appendix.

NOTE

For SIMSON ISR 70-03 application technique, refer to GOOD PRACTICES – USE OF ADHESIVE & SEALANT PRODUCTS in Appendix.

22. Remove sealant in excess using putty knife/scrapper. Smooth down (FIGURE 25) the joint with finger or using clean clothes soaked with water or soapy water. The sealant bead must be fully filled, uniformly applied, flush with the thermos surface. Clean sealant in excess using silicone remover (anti-silicone).

OPEN TIME: the time interval after the application of the adhesive during which successful bonding of substrates can occur.

SEALANT SIMSON ISR 70-03 OPEN TIME =10 minutes max

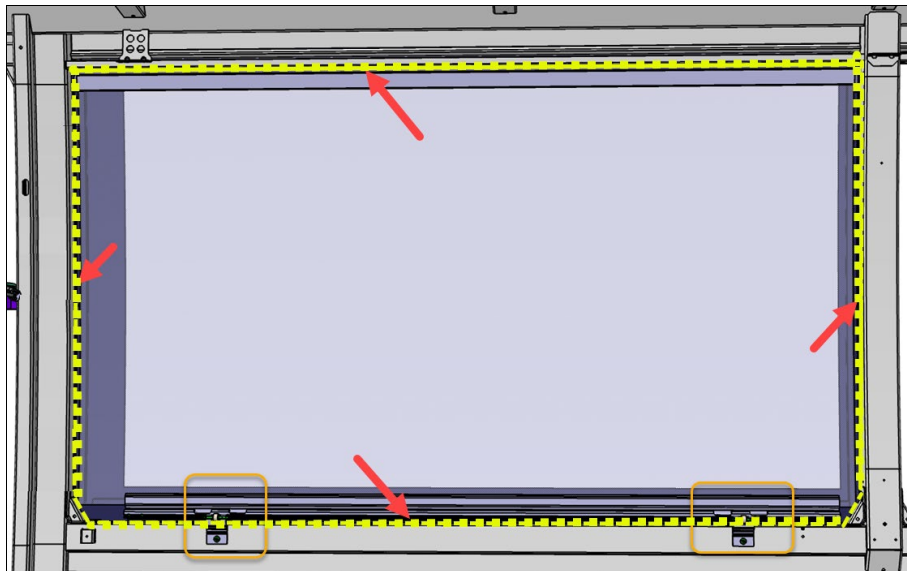

Figure 24

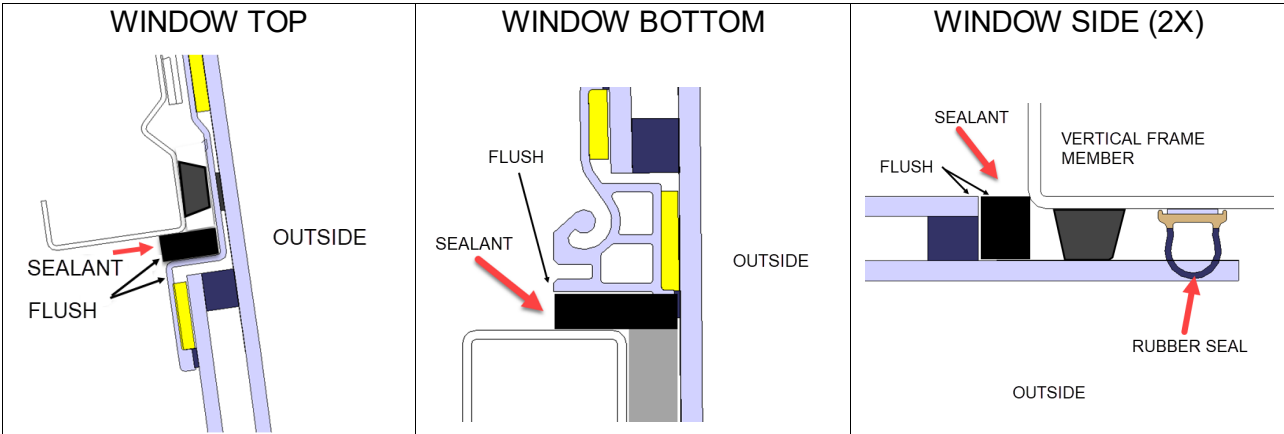

FIGURE 25

23. Allow 90 minutes of curing (vehicle stop time = 90 minutes).

INTERIOR TRIM INSTALLATION

24. Inside the vehicle, reinstall the extrusion at the bottom of the window.

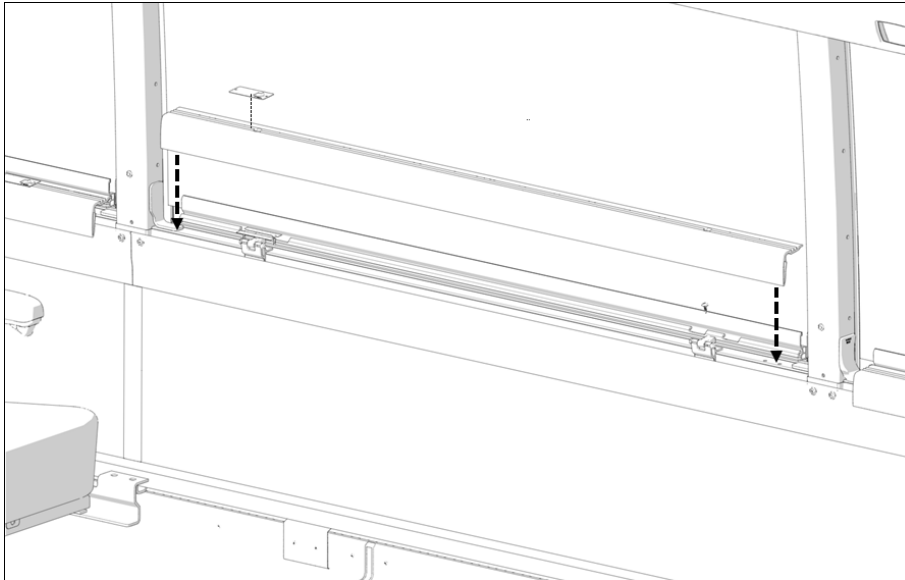

Figure 26

a) Secure the extrusion using the same hardware.

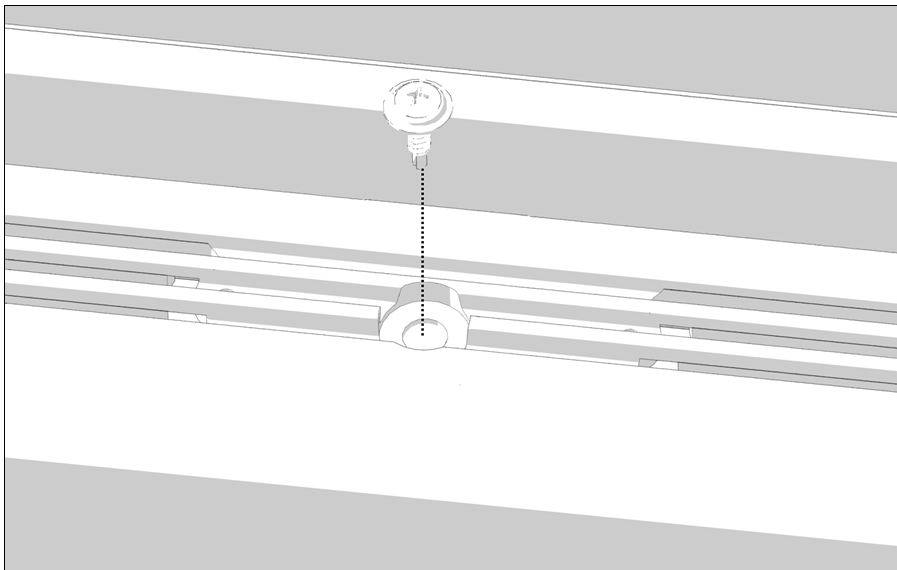

Figure 27: screw under warning plate

b) Reinstall the two warning plates using the following hardware.

Rivet: p/n 504108 RIVET POP DOME AL OE 1/8 Qty: 4

Finishing washer: p/n 5001970 Qty: 4

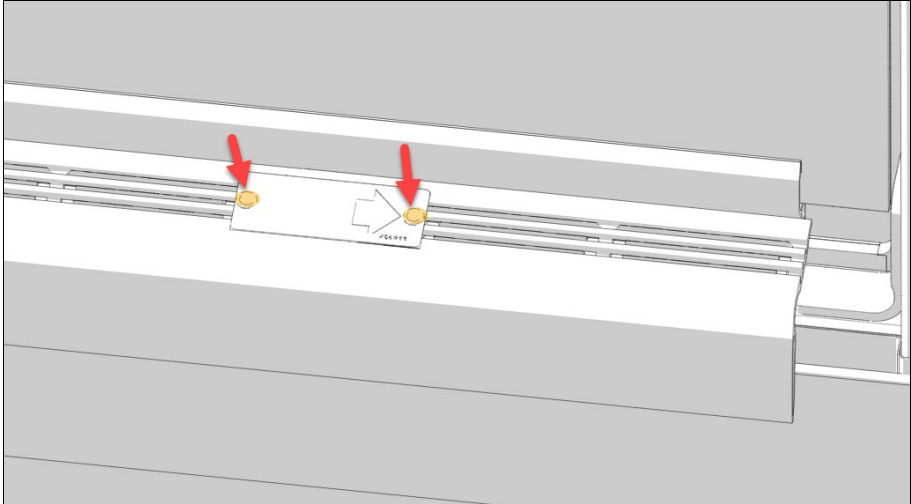

Figure 28: warning plate

25. Inside the vehicle, reinstall the finishing trims around the window. Use the following hardware.

Rivet: p/n **504228 RIVET POP DOME AL OE BK 1/8 (0.376_0.500)** Qty: 4

Finishing washer: p/n **500345** Qty: 4

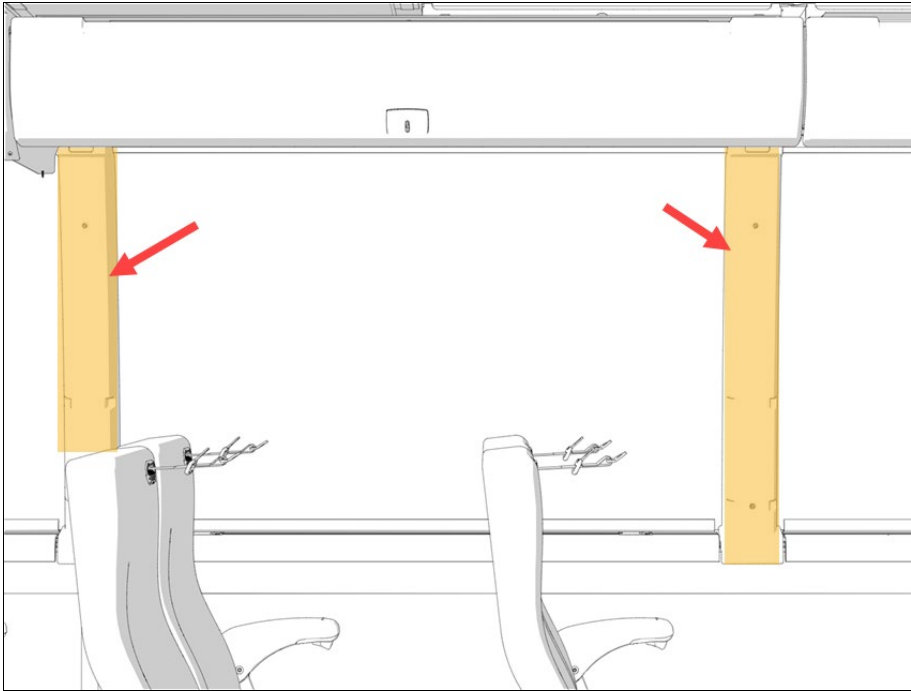

Figure 29: finishing trims

5. PARTS / WASTE DISPOSAL

Discard according to applicable environmental regulations (Municipal/State[Prov.]/ Federal)



Access all our Service Bulletins on <https://secureus5.volvo.com/technicalpublications/en/pub.asp>
Alternatively, scan the QR-Code with your smart phone.

E-mail us at technicalpublications_prev@volvo.com and type "ADD" in the subject to receive our warranty bulletins
by e-mail.

6. APPENDIX

GENERAL HEALTH & SAFETY / ENVIRONMENTAL INFORMATION

<p>DISCARD</p>  <p>ACCORDING TO P908</p>	<p>WEAR</p>  <p>GLOVES</p>	<p>WEAR</p>  <p>SAFETY GLASSES</p>
---	--	---

Working environment

- Free from excessive dust (ensure ventilation).
- Air jet prohibited. (Propels dust into the working environment and causes surface contamination from the oil of the pneumatic system).
- All products containing silicone are prohibited.

Temperature and % humidity: The standard is established at 73 °F and 50% relative humidity.

Effect of temperature;

> 73 °F and/or > 50%, drying time and working time are reduced

< 73 °F and/or < 50%, drying time and working time are increased

On the other hand, usage of products, parts, surface preparation and/or bonding is not allowed below 59°F.

General information for products cleaning / surface preparation

			
<p>Do not rub back and forth</p>	<p>Check the expiry date</p>	<p>Do not pour directly from the bottle</p>	

GOOD BONDING PRACTICE - TRIANGULAR BEAD APPLICATION

The nozzle must be as perpendicular as possible to the surface

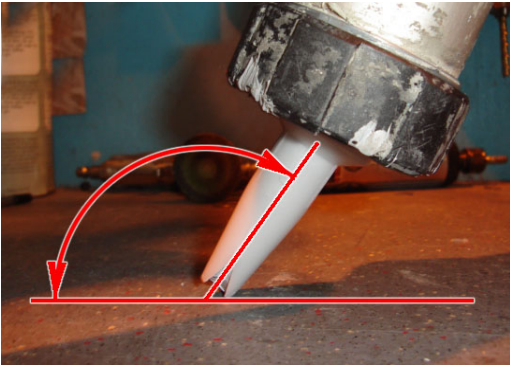
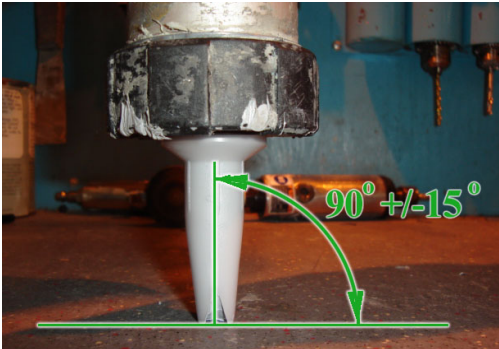

The nozzle must be oriented in the direction of movement (rearward not sideways)

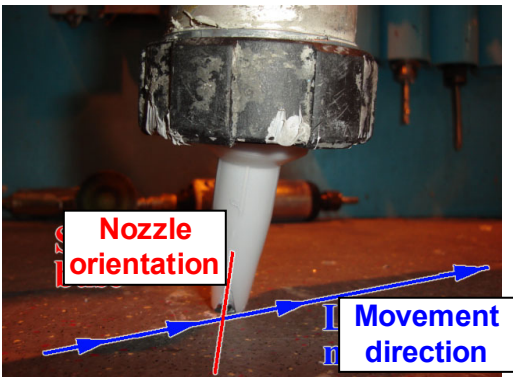
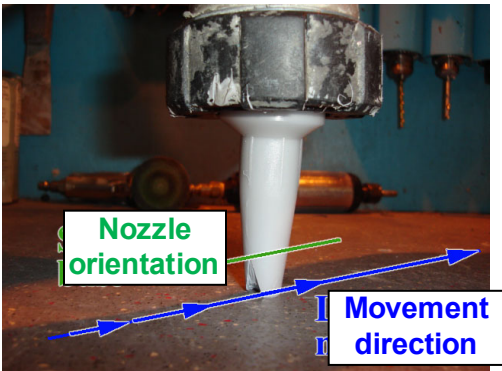

Joints appearance

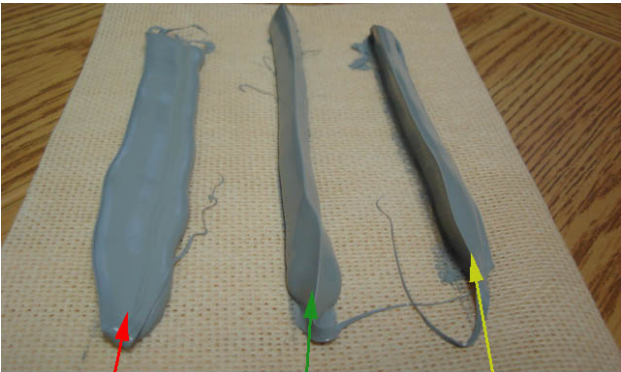

Not acceptable Perfect Just acceptable

GOOD BONDING PRACTICE – USE OF SURFACE PREPARATION PRODUCTS

Section A Anti-silicone (also applicable for alcohol)



1. Apply

CHIX Cloth

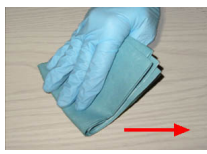

2. Dry off immediately

BLEU Cloth

Note: Cover (surface) as small as possible. Flip the cloth over. Continue until the Chix is clean.



Non acceptable



Non acceptable



Maximum acceptable

3. Let evaporate (Mandatory)

Minimum time: Until product evaporation

Two hours later: Resume cleanup

At the discretion of the crew Before the application of any other product

If the surface still seems dusty, greasy or has fingerprints, repeat the cleaning process.

Section D Glass cleaner



1. Vaporize



2. Dry off

BLEU Cloth

3. Let evaporate

Mandatory

Minimum time: Until complete evaporation of the product

Two hours later: Clean again

At the discretion of the crew Before the application of any other product

If the surface still seems dusty, greasy or has fingerprints, clean again.

Section K Teroson 8519 P



1. Shake the bottle to mix the product.

2. Apply

CHIX Cloth

3. Let evaporate (Mandatory)

Minimum time: 2 minutes

One hour later: Clean using alcohol. Re-apply primer 8519 P.

At the discretion of the crew Before the application of any other product

If the surface still seems dusty, greasy or has fingerprints, clean using alcohol and reapply primer 8519 P (30 minutes minimum between coats).

GOOD PRACTICES – USE OF ADHESIVE & SEALANT PRODUCTS

Note: Adhesive product may be used until the end of the specified month, except when a complete date is specified (yyyy/mm/dd).

B	SIMSON ISR 70-03 BLACK SEALANT, 290 ml (684685), 600 ml (685124) SIMSON ISR 70-03 GREY SEALANT, 290 ml (684517), 600 ml (685126)						
Open time	Simson 70-03 = 10 min. maximum						
Cleaning (smear, excesses)	Anti-silicone						
Smoothing	Water or soapy water (authorized soap 680339; concentration of 0.25%). example : <table border="1" style="display: inline-table; vertical-align: middle;"> <tr><td>710 ml</td><td>1.8ml</td></tr> <tr><td>750 ml</td><td>1.9ml</td></tr> <tr><td>1 litre</td><td>2.5ml</td></tr> </table>	710 ml	1.8ml	750 ml	1.9ml	1 litre	2.5ml
710 ml	1.8ml						
750 ml	1.9ml						
1 litre	2.5ml						
Paint	The bead of sealant may be covered, at minimum, with paint or primer at least after the seal is dry to the touch.						
EXPIRATION DATE VERIFICATION = SEE PRODUCT DATE VERIFICATION GUIDE							

E	TEROSON MS 9399 ADHESIVE, 400ML (685387) TEROSON MS 9399 ADHESIVE, PART A (685385) TEROSON MS 9399 ADHESIVE, PART B (685386)						
Open time	18 minutes maximum						
Cleaning (smear, excesses)	Anti-silicone						
Smoothing	Water or soapy water (authorized soap 680339; concentration of 0.25%). example : <table border="1" style="display: inline-table; vertical-align: middle;"> <tr><td>710 ml</td><td>1.8ml</td></tr> <tr><td>750 ml</td><td>1.9ml</td></tr> <tr><td>1 litre</td><td>2.5ml</td></tr> </table>	710 ml	1.8ml	750 ml	1.9ml	1 litre	2.5ml
710 ml	1.8ml						
750 ml	1.9ml						
1 litre	2.5ml						
Paint	The bead of sealant may be covered, at a minimum, with paint or primer at least after the seal is dry to the touch.						
Mixer	Use mixer 687960 with the drums and pumps. Use Quattro mixer 687958 to do triangular joint with 400 ml cartridges. The mixer enclosed in the 400 ml cartridge boxes may be used for other applications.						
EXPIRATION DATE VERIFICATION = SEE PRODUCT DATE VERIFICATION GUIDE							

PRODUCT DATE VERIFICATION GUIDE

SIMSON ISR 70-03 adhesive, cartridge 290 ml, gray #684517, black #684685

The product is good until the end of the indicated month, in this case January 2017.



GLUE TEROSON MS-9399, 400 ml, #685387

The product is good until the end of the indicated month, in this case January 2021.



TEROSON 8519 P primer, 500 ml, #687965

The product is good until the end of the indicated month, in this case December 2016.

