



# *Trueline* LEVELING SYSTEM

*Installation & Operation Guide*



**Valid Manufacturing Ltd.**

*Advanced technologies... Simple solutions*

# TRUETIME LEVELING SYSTEM

## Installation & Operation Guide

VTL01K004

CONTROLLER V1.60

SENSOR V1.27



**Valid Manufacturing Ltd.**

*Advanced Technologies...Simple Solutions*

Last revision: 7/26/04

Copyright © 2004 Valid Manufacturing Ltd. All rights reserved.

Information in this document is subject to change without notice. No part of this document may be reproduced or transmitted, in whole or in part, in any form, or by any means, electronic or mechanical, for any purpose, without the express written permission of Valid Manufacturing Ltd.

# TABLE OF CONTENTS

For Your Safety .....	5
Introduction .....	7
What You Get in the Box.....	9
Installation .....	11
Level Sensor Modules .....	11
Air Valves and Connectors .....	12
Controller Installation.....	13
System Setup & Configuration.....	17
Leveling System Setup.....	17
Set Orientation.....	18
Set Configuration.....	19
Configuration settings.....	21
Zero Set.....	24
Leveling System Operation.....	27
Auto Level Mode.....	28
Manual Level Mode .....	30
Travel Mode.....	32
Diagnostic Functions.....	33
Test Diagnostics .....	33
Fault Diagnostics.....	35
Emergency Override Procedures.....	37
Travel Override .....	37
Forcing Leveling Valves .....	37
Resetting the Leveling System.....	38
Warranty & Service .....	41
Warranty .....	41
Service.....	41
Glossary .....	43
Index.....	45

Addenda:

- Connection schematic
- Control panel cutout template
- Replacement parts list

## FOR YOUR SAFETY

- Read and understand the entire operator's manual before using or servicing your Trueline Leveling System.
- Do not use the vehicle's suspension to support the vehicle for servicing or inspection. Instead, install adequate blocking before working under any vehicle.
- Ensure that the area around the vehicle is clear of obstructions before operating the leveling system.
- Your Trueline Leveling System should be serviced only by qualified personnel.

**Note:** Leaks in a vehicle's air system can cause the vehicle to lower over time regardless of whether the Trueline Leveling System is operational.



# INTRODUCTION

Using the latest accelerometer technology, the Valid Trueline Leveling System is able to provide exceptional leveling control. By measuring the amount of gravitational pull on the two mounted sensors, it is able to determine the amount of tilt that is being applied to the vehicle.

Each of the fully sealed leveling sensors is capable of very accurately measuring acceleration/tilt in two directions. The rear sensor measures across the rear axle as well as along the longitudinal axis of the vehicle, while the front sensor measures across the front axle of the vehicle and also any vertical accelerations that the vehicle may feel.



Leveling sensor

The level controller is the interface between the vehicle operator and the Trueline Leveling System. It allows the operator to enter commands and provides visual feedback of the vehicle's current status.

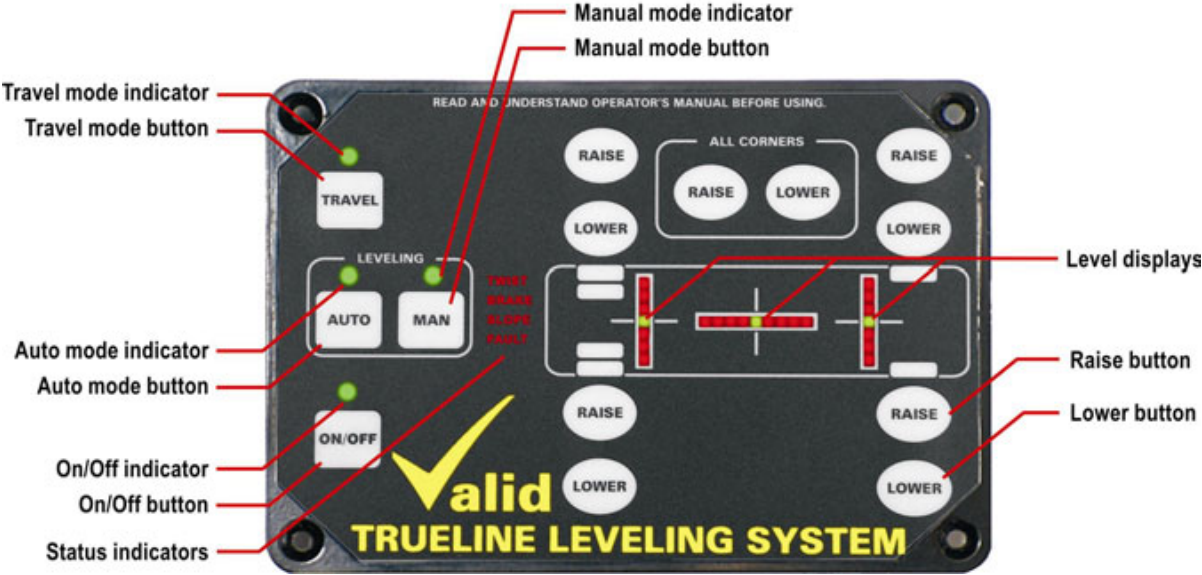

Level controller





## WHAT YOU GET IN THE BOX

When you unpack your VTL01K004 Trueline Leveling System, the following components should be included:

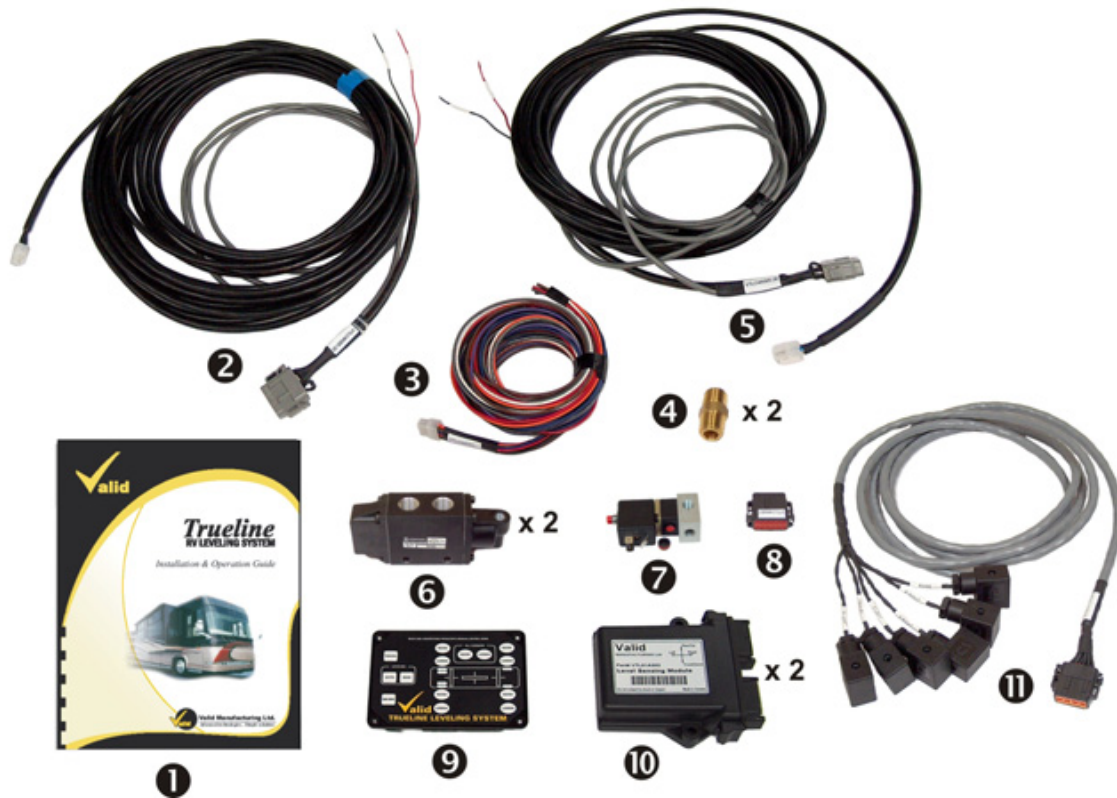

- |     |   |              |
|-----|---|--------------|
| 1.  | VTL01K004 Installation & Operation Manual   |              |
| 2.  | Sensor controller harness, 50-foot          | VTL04A005-50 |
| 3.  | Level controller dash harness               | VTL04A001    |
| 4.  | Air check valve, ¼ NPT SMC (2)              | 14CVS        |
| 5.  | Sensor controller harness, 30-foot          | VTL04A005-30 |
| 6.  | Air valve, Norgren 2pos 3way piloted (2)    | K910026      |
| 7.  | Air valve, Norgren 2pos 3way solenoid 24VDC | D0045A1W2    |
| 8.  | 12-pin termination cap for rear sensor      | VTL04A007    |
| 9.  | Leveling controller                         | VTL02A001    |
| 10. | Leveling sensors (2)                        | VTL01A003    |
| 11. | Harness, sensor to valve, Prevost VIP       | VTL04A006    |



# INSTALLATION

**Note:** Installation of a Valid Trueline Leveling System should be carried out by qualified personnel only.

Installation of the Trueline Leveling System can be broken into 3 basic steps:

1. Mounting the sensors on the axles.
2. Mounting the valve manifolds.
3. Installing the control panel in the vehicle's dash.

Before beginning the installation, ensure that all you have all the required parts and that there is adequate blocking beneath the vehicle you are about to work on.

## Level Sensor Modules

The two level sensing modules are identical and either one can be mounted in the front or the rear. However, they are mounted differently depending on at which end they are put.

**Note:** When mounting the sensors, it is important to place units in such a way that the direction arrows point as true as possible. There is no mechanical adjustment to fine tune the position since the software determines where level is during initial calibration.

### A. To install the front level sensor:

1. Mount it as far forward under the coach as possible.
2. Allow for the connectors to exit the sensor on the right-hand side of the unit with respect to the coach.
3. The front sensor is mounted in the following orientation:
  - Left and Right arrows pointing directly left and right, respectively.
  - Up and Down arrows pointing to the sky and ground, respectively.

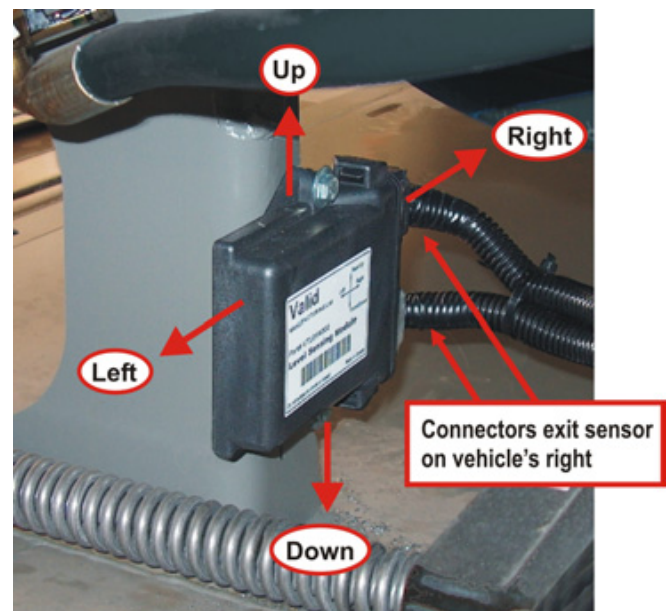

**Front level sensor, mounted**

**Note:** To achieve proper alignment, place a level on either of the sensor body edges that are above and below the label.

**B. To install the rear level sensor:**

1. Mount it on the chassis as close as possible to the centerline of the steering and driving axle, and as far back as possible. To avoid high temperatures, do not place it in the engine compartment.
2. Allow for the connectors to exit the sensor on the right-hand side of the unit with respect to the coach.
3. The rear sensor is mounted in the following orientation:
  - Left and Right arrows pointing directly left and right, respectively.
  - Rear and Front arrows pointing to the rear and front of the vehicle, respectively.

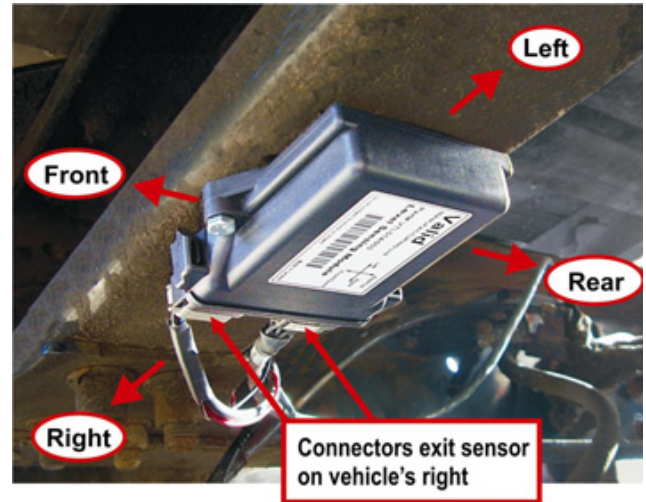

**Rear level sensor, mounted**

**C. Connecting the sensors:**



The sensor connections are indicated on the 4-Axis Schematic (Prevost), found in the back of this manual.

**Air Valves and Connectors**

**Solenoid Air Valves**

There are already 5 manufacturer-installed solenoid air valves. The Trueline Leveling System requires the installation of a sixth, which is included in the kit.

**Piloted Air Valves**

There are 4 manufacturer-installed piloted air valves. The Trueline Leveling System requires 2 more, and these are included in the kit.

The figure below shows the two new piloted valves and one new solenoid valve mounted in position. Note the 5 existing solenoid valves to the left of the new one.

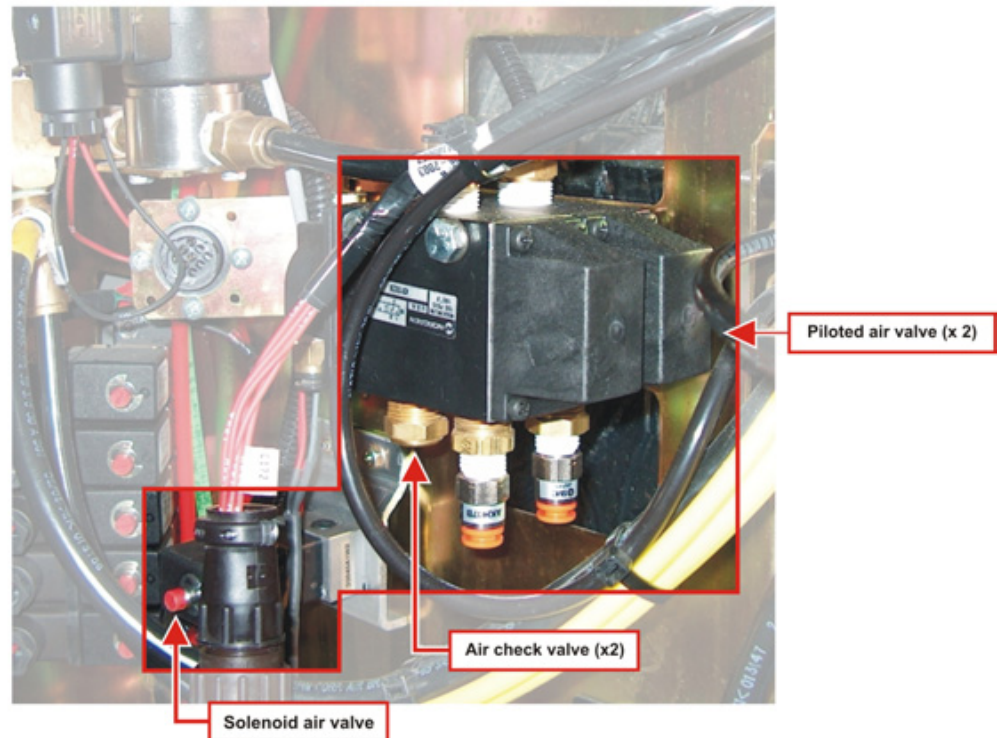

Air valves in position

## Controller Installation



1. Cut a hole in the dash to accommodate the leveling control panel. See the Leveling Display Panel Cutout drawing (VTL02A001 – CUTOUT) at the end of this manual.
2. Route all necessary cabling to the dash access point. Ensure that there is enough cable to connect the control panel before inserting the panel into the cutout.
3. Mount the control panel so the image of the vehicle on the controller is oriented the same as the actual vehicle. This will make it easier for the operator to visualize the operation of the system.
4. Once all cable harnesses are connected to their corresponding port on the controller, fasten the control panel into the dash.
5. See the following paragraphs for information on connecting the vehicle speed signal to the dash harness.



Mounted control panel

### Vehicle Speed Signal Requirements

The Valid Trueline Leveling System requires a standard square wave signal representing the vehicle speed. The signal must have a peak-to-peak voltage between 8 and 30 volts and a maximum frequency of 2 kHz.

The leveling system is pre-calibrated for a speed signal input of 30,000 pulses per mile (500 Hz at 60 MPH). Typically, this signal will originate from the vehicle's transmission. However, to determine an appropriate source for this signal you should contact your dealer.

For most vehicles which incorporate the Allison World-Series Transmission, Wire 157 in the transmission harness is the speed signal and is typically available in both of the vehicle interface module (VIM) connectors (if equipped), at pin B2 on the 18-pin connector (if equipped), or pin H2 on the 30 pin connector (see Fig. 1). The wire color is commonly violet or tan and is labeled '157'.

### Connecting the vehicle speed signal to the dash harness:

1. Connect the violet wire (labeled 'Speed H') on the level controller harness to the '157' wire on the transmission harness.
2. Connect the gray wire (labeled 'Speed L') to the transmission ECU ground (labeled '143C'). On some vehicles this signal may already be available in the dash/cab harness, which could simplify installation. Contact your dealer to determine if this is the case.

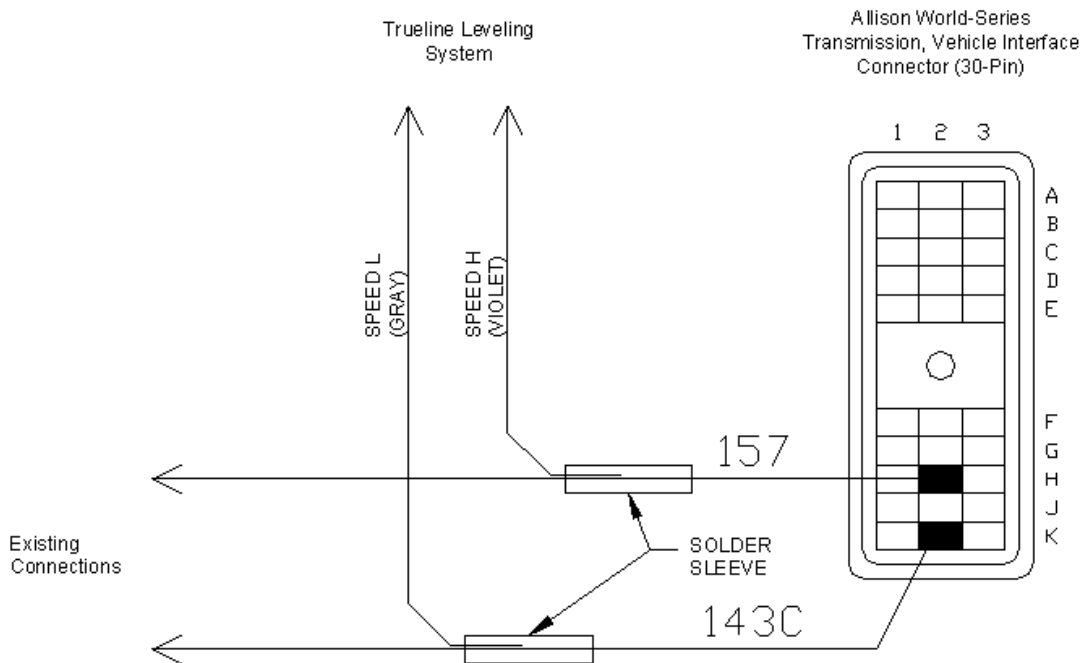

Fig.1



# SYSTEM SETUP & CONFIGURATION

## Leveling System Setup

The Trueline Leveling System has many user-selectable features that should be configured after installing the components. To access these features you must first place the system into 'service mode.'

### To place the unit into service mode:

1. Ensure the system is powered off.
2. Press **ON/OFF** to turn the system on.
3. Press and hold **AUTO** (do not release) for approximately 10 seconds until the 'Auto' and 'Man' indicators flash alternately and an alternating tone is heard.
4. Release **AUTO** and select the desired Primary Service Mode function button (see following pages).

**Note:** If you do not select a function within 5 seconds after the tone is heard, the system will exit service mode.

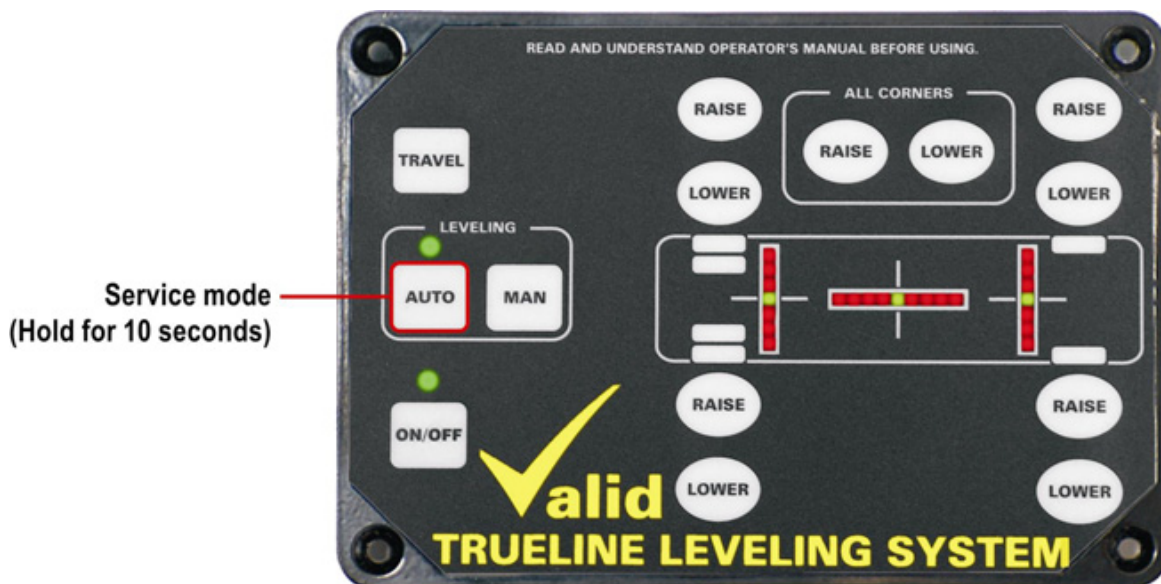



Once the system is installed, the following three steps must be completed as part of the initial setup. As stated previously, you must be in service mode to perform these operations.

1. Set orientation
2. Set configuration
3. Zero set

## Set Orientation

This sets the address of the sensors on the vehicle network (front vs. back).

Enter service mode (see page 17) and press **ALL CORNERS RAISE** to select the ‘Set Orientation’ function. After one or two seconds, the system will beep to indicate completion of the function.

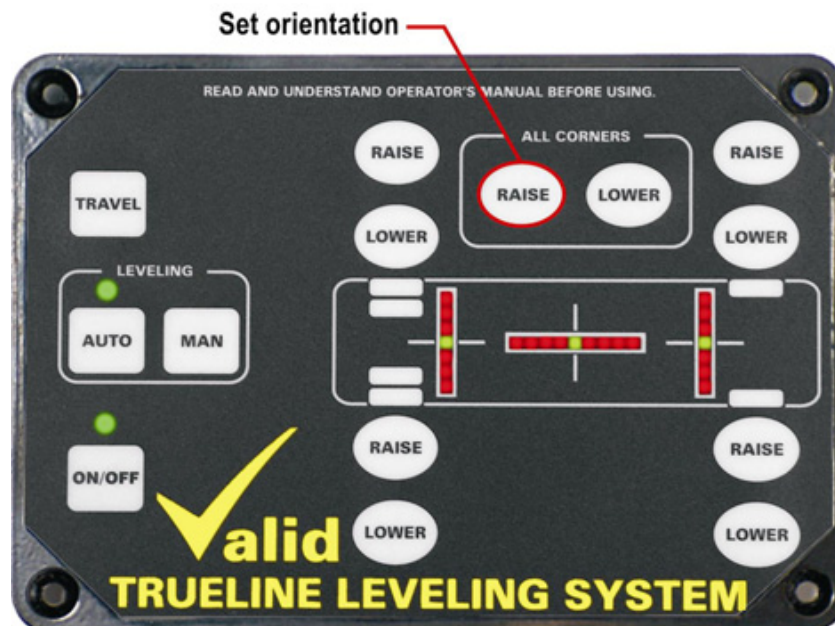

## Set Configuration

There are a number of system configuration items that need to be set prior to using the system.

Enter service mode (see page 17) and press Front Right **RAISE** to select the Configuration function.

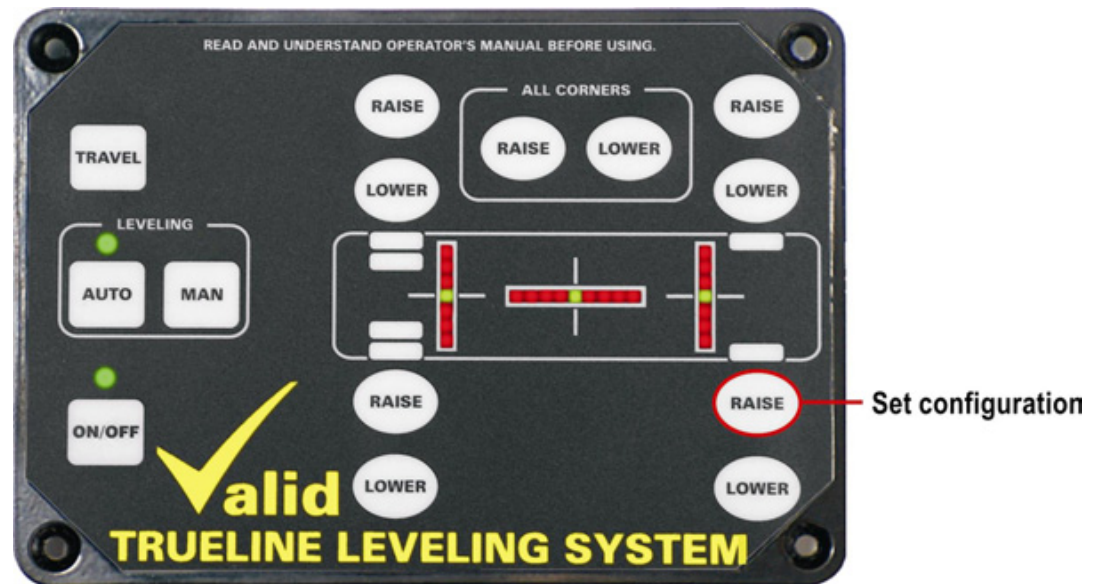

### To adjust settings in configuration mode:

- Press Front Right **RAISE** to increase the setting.
- Press Front Right **LOWER** to decrease the setting.
- The settings for each item can be seen on the flashing indicator bar of the front axle level display. (See diagram on page 20.)

### To select a different configuration item:

- Press Rear Right **RAISE** to advance to the next item.
- Press Rear Right **LOWER** to return to the previous item.
- The item you have selected is indicated on the flashing indicator bar of the rear axle level display (See diagram on page 20.)

**Note:** If you do not press **INCREASE** or **DECREASE** within 30 seconds, the system will exit the configuration mode.

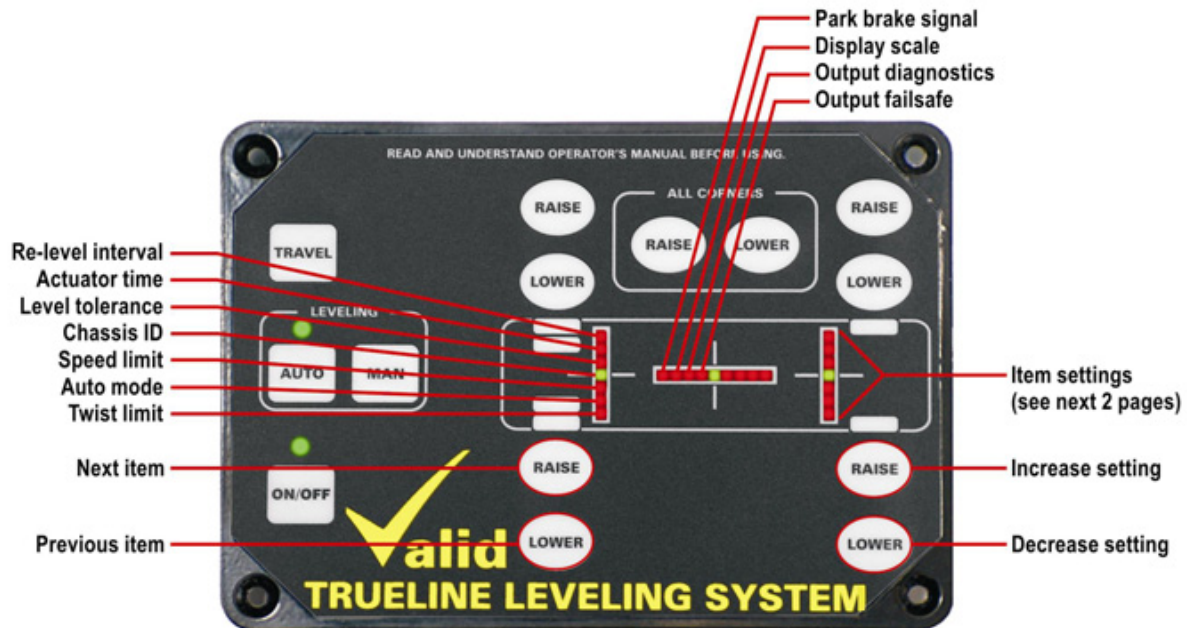

**To save your configuration settings:**

Press **MAN**. This permanently stores the new configuration settings into EEPROM memory.

**Note:** If you change any values without saving them, they will be used temporarily until the system is powered off and back on. Then the system will re-load the saved values from EEPROM memory.

See the following pages for information on the values of each setting.

## Configuration settings

### Twist limit

Select one of seven twist limits to be applied during manual operation of the system. This is the maximum ‘twist’ allowed between the front and rear sensors.

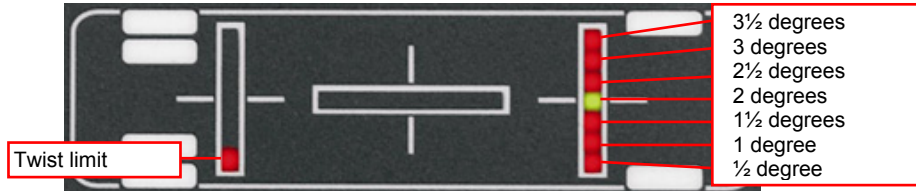

### Auto mode

Select one of five leveling options for automatic mode. The default mode is ‘Level then Lower.’ See page 28 for descriptions of how each of these leveling methods works.

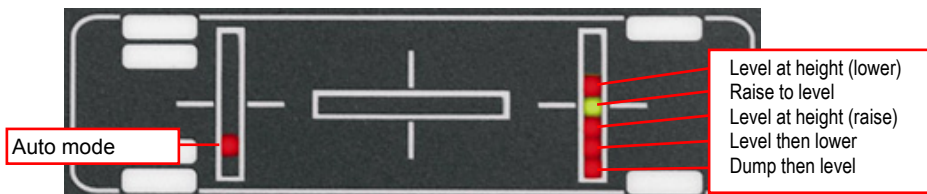

### Speed limit

Select one of four values to limit the maximum vehicle speed at which manual operation is allowed (before the system switches to ‘Travel’ mode).

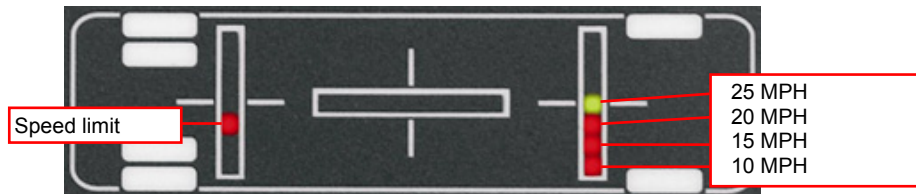

### Chassis ID

Select the appropriate chassis ID. ‘Legacy’ is for systems utilizing sensors with a serial number of 00148 or lower. ‘Standard’ is for most systems utilizing two banks (front/rear) of 6 solenoid valves.

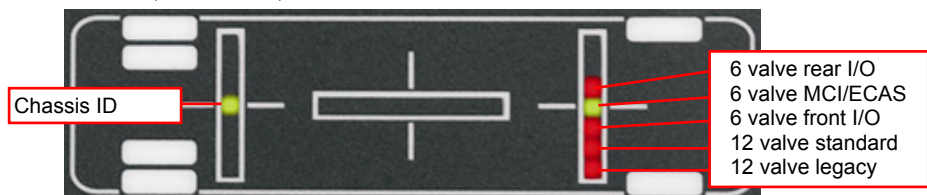

### Level tolerance

This is the window on either side of true level that will be considered level during automatic operation. The left-to-right value is shown first (before the '/'). The front-to-rear value (after the '/') is always half of left-to-right.

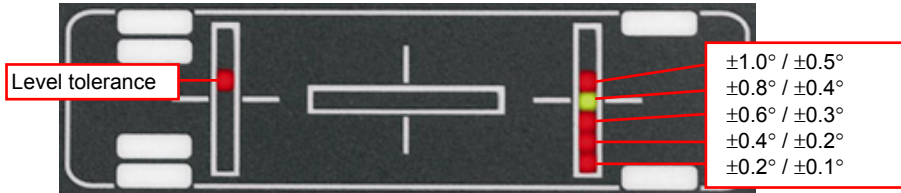

### Actuator time

Select one of seven actuator lower/raise time limits (maximum amount of time required to lower and raise an air spring). Choose the lowest setting that allows for complete movement in each spring.



### Relevel interval

Select one of six values which sets the time between 're-checks' for level while the system is in Auto mode.

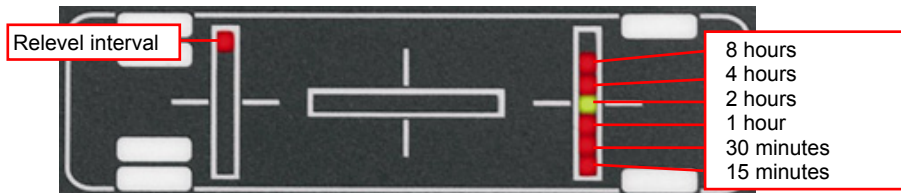

### Park brake signal

Select if the signal to indicate activation of the park brake is either true high (+12v/24v) or true low (ground).

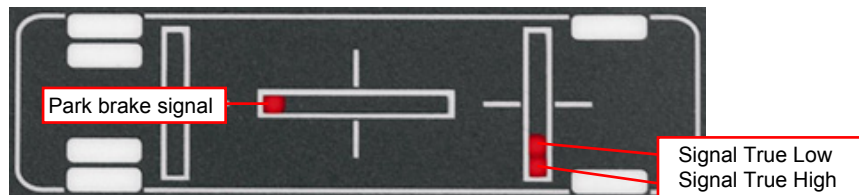



### Display scale

Select one of 6 display resolutions for indicating tilt. Each indicator (LED) will represent a change in tilt of the value chosen. E.g. choosing '6 mG' will have each LED indicate 1/3 of a degree (this is the default).

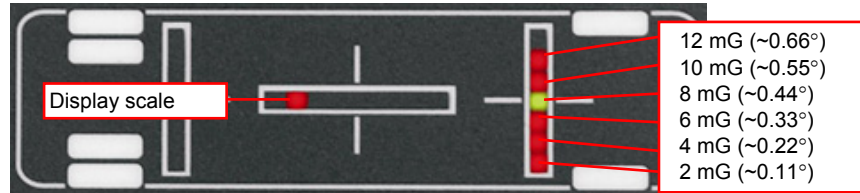

### Output diagnostics

Select whether to enable the online (realtime) output diagnostics that will indicate a fault if an output is overloaded when energized.

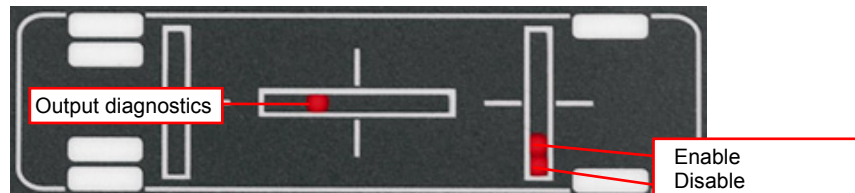

### Output failsafe

The output failsafe mode is automatically enabled. This energizes the 'Travel' mode outputs for the 'Standard Chassis' on sensor reset or power up (after 30 seconds of no communication from the controller). Note that this setting cannot be changed.

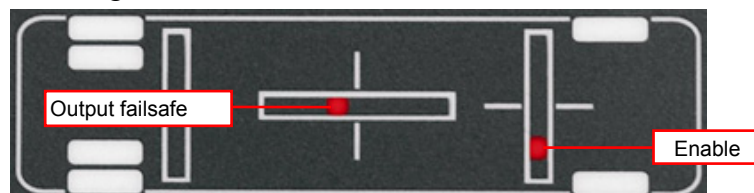

## Zero Set

The Zero Set function resets the system's level reference to the current vehicle position. While it is necessary to do this step as part of the initial configuration of the leveling system, you may also perform this function any time you wish to re-zero the vehicle's level settings.

**Note:** This procedure requires the use of at least one leveling tool (for example, a bubble-type level).

### To set to zero:

1. Ensure that the vehicle is level and on a relatively flat and level surface.
2. Manually level the coach.
  - Note that the control panel's level display will not be accurate at this time, so use a leveling tool to determine where level is. You may wish to measure level in more than one place if you have several leveling tools. Otherwise, choose a key location in the coach such as a table or stove top.
  - To adjust the corners of the vehicle, press and hold **MAN**.
  - While holding **MAN**, press the appropriate **RAISE** or **LOWER** buttons to raise and/or lower corners.
3. Once the vehicle is manually leveled, go into service mode (see page 17) and press Front-Left **LOWER** to select the Zero Set function. This tells the leveling system that the current position is to be considered level.

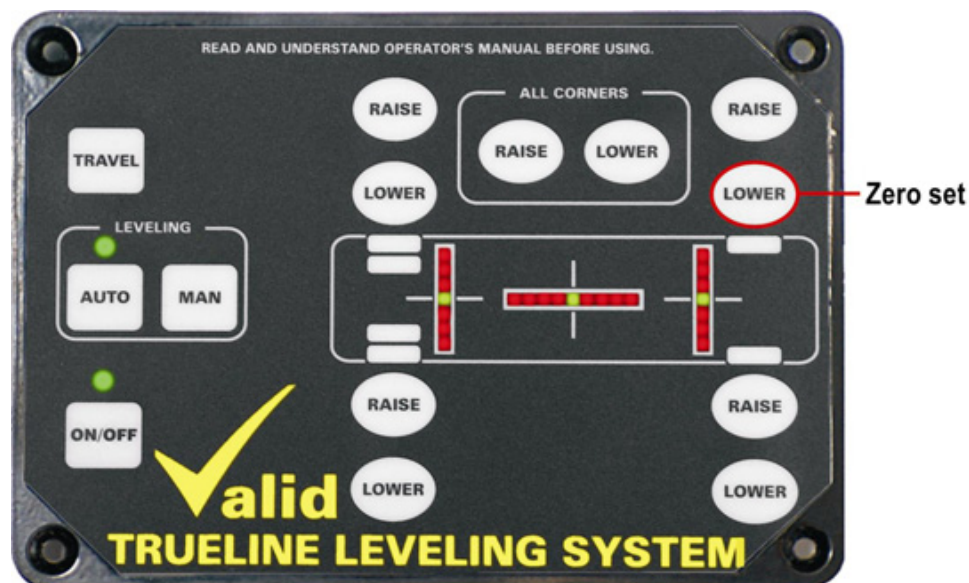

# LEVELING SYSTEM OPERATION

There are three main operational modes of the Trueline Leveling System:

- **Auto Level Mode:** Auto mode should be used by default when the vehicle is at a stop. This mode is the easiest to use and is suitable for most situations.
- **Manual Level Mode:** Manual mode allows you to raise or lower each corner of the vehicle individually, to the level you want. Manual leveling mode can be used if you wish to have control over the leveling process. It can also be used at low traveling speeds when an uneven surface must be negotiated.
- **Travel Mode:** Travel mode is in effect when the vehicle is in motion. By default, this mode will initiate when the vehicle moves at a speed higher than the designated speed limit (set in the initial configuration of the system). However, it is best for the operator to enter this mode before the vehicle begins moving.



Level mode indicators

Since the Trueline Leveling System collects information on the ground speed of the vehicle, the operational mode may change automatically depending on the state of the vehicle.

In each mode, the three level indication displays can be viewed as a building level, with the indicator lamp as the level's "bubble." The lamp displays red if not level, and green if level.

*For example: If the indicator lamp is to the left of center on either of the axle displays, then the left side of that axle is high. If the indicator lamp is forward of center on the longitudinal display, then the front of the vehicle is high.*

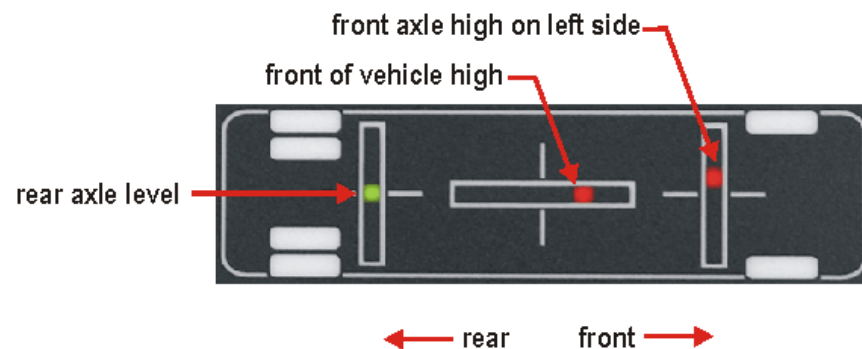

To activate any operational mode, the Trueline Leveling System must first be turned on by pressing and releasing **ON/OFF**.



**Note:** Due to the sensitivity of the leveling sensors, any noticeable movements within the coach can cause difficulty while leveling is in process. Therefore, if you are inside the vehicle while it is leveling, please sit quietly or walk lightly.

## **Auto Level Mode**

As stated earlier, Auto Level Mode is the easiest to use and is suitable for most situations where the vehicle is at a stop.

Depending on the Auto mode setting of your leveling system (see page 21), when the vehicle has been put into Auto mode, it will go through one of the following procedures:

### **Level then lower**

In the rear and then the front, the leveling system detects the lowest side and lowers the higher side to match. When the two ends are each level, the system then lowers the higher end to the height of the lower end. Next, the vehicle continues to lower, and then is leveled by the system.

### **Level at height (raise)**

In this method, the leveling system detects the highest corner of the vehicle, then levels the remaining corners to it.

### **Level at height (lower)**

In this method, the leveling system detects the lowest corner of the vehicle, and then levels the remaining corners to it.

### **Lower then level**

The leveling system releases all the air out of the airbags. It then detects the highest corner of the vehicle and raises the other three to that height. Finally, it levels the vehicle.

### **Raise to level**

This system uses hydraulic jacks, and it will raise the lowest corner to level, then raise/lower the other three corners. Then it will level the vehicle.

### **To use Auto Level Mode:**

1. Ensure that:
  - a. The vehicle's engine is running and the air system is at full pressure,
  - b. The parking brake has been engaged,
  - c. The front wheels are straightened, and
  - d. The control panel is turned on. (If the **ON/OFF** indicator is not lit, press and release **ON/OFF**.)

**Note:** If the level controller will not go into Auto mode it is most likely because the vehicle's parking brake has not been applied (Fig 2). Apply the parking brake to have the system go into Auto mode.

2. Press **AUTO** to initiate a leveling cycle.
3. If you wish to level the vehicle at its current height (e.g. if it hasn't finished raising or lowering), press and hold **AUTO** for 3 seconds. Ensure that the vehicle is at a reasonable height before doing this, or it may be unable to level successfully.

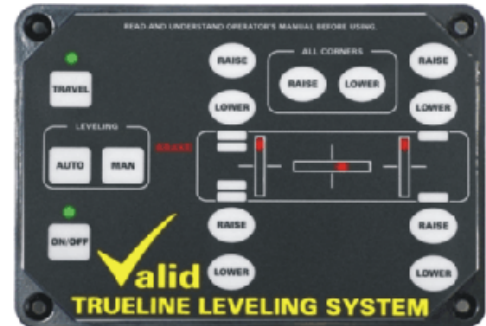

Fig 2

#### What happens during the leveling cycle:

1. During the entire cycle, the **ON/OFF** indicator lamp remains on and the **AUTO** indicator lamp flashes until a level state has been achieved. Then the indicator remains on.
2. Once the vehicle is fully raised or lowered or the raising/lowering has been interrupted by the operator, the Trueline Leveling System will begin three leveling cycles. In each cycle, the rear axle, front axle, and longitudinal axis are leveled. If the vehicle achieves a level state at any time during these cycles, the Trueline Leveling System will simply skip to the next cycle and continue.
3. After the three cycles are complete, the vehicle should be level and all three level displays should be indicating green (Fig 3).

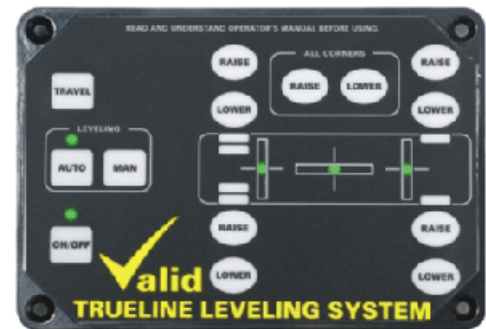

Fig 3

#### Once the vehicle has been leveled:

1. After 15 seconds, the two level sensors go into "sleep" mode in order to minimize parasitic current draw on the vehicle's battery system.
2. After 20 seconds, the level controller goes into "low power" mode indicated by the occasional flashing of the **AUTO** and **ON/OFF** indicator lamps.
3. After a period of time\* in low power mode, the level controller automatically wakes the two sensor units and checks to see if re-leveling is required. (\*depending on the Relevel Interval setting – see page 22.)
  - If no leveling is required, the two sensors are allowed to go back to sleep and the level controller drops back into low power mode after 20 seconds.

**OR**

  - If leveling is required, the Trueline Leveling System again goes through the 3 cycles to properly level the coach.

### Auto Mode – Notes

- Once a leveling cycle has been completed, any subsequent leveling cycles can be initiated if the leveling controller is in Auto mode or low power mode. Simply press and release **AUTO** once.
- If the vehicle begins to move and exceeds a speed of 2MPH, the Trueline Leveling System automatically switches from Auto mode to Manual mode and sounds a warning tone. If the vehicle continues to accelerate, the Trueline Leveling System automatically switches from Manual mode to Travel mode at speeds above the designated speed limit set in the initial configuration. (See page 21.)

### Changing the Height of a Leveled Vehicle:

A leveled vehicle can be raised or lowered to adjust the entry doorstep height.

1. To ensure an adequate amount of air, the coach's engine should be running and its air system should be at full pressure.
2. Press the **ALL CORNERS RAISE** or **ALL CORNERS LOWER** button. This causes the vehicle to move up or down while still level.

## Manual Level Mode

Use manual leveling mode if you wish to have control over the leveling process, or while traveling at low speed when an uneven surface must be negotiated.

### To use Manual Level Mode:

1. Ensure that the leveling system is turned on. If the **ON/OFF** indicator is not lit, press and release **ON/OFF**.
2. With the vehicle either parked (but still running) or traveling slower than the Travel mode speed limit, press **MANUAL**.
3. Press **RAISE** or **LOWER** for each of the four corners you wish to manually adjust.

#### OR

To control all 4 corners simultaneously, use the **ALL CORNERS RAISE** and **LOWER** buttons. This can be useful if you wish to raise or lower the entry step height.

**Note:** You cannot raise or lower multiple corners simultaneously by pressing more than one **RAISE** or **LOWER** button at once. You can only do this using the **ALL CORNERS RAISE** and **ALL CORNERS LOWER** buttons.

### All Corners Raise

When in manual mode, you may be raising your vehicle while either parked or moving slowly. To allow you greater freedom, the **ALL CORNERS RAISE** button has a 'lock' feature that keeps the button activated after you have pressed it.

**To lock the All Corners Raise button:**

In manual mode, hold **ALL CORNERS RAISE** for 3 seconds. This ‘locks’ the button on for a period of one minute.

- During this time, the coach elevates continuously and the control panel sounds a repeated beeping signal.
- After the minute is over, the coach stops elevating.
- You may repeat this process until the coach is at the height you want.
- To stop the elevating process during the one-minute period, press and release **MAN**.

**Note:** Because of the risk of damage to your coach, the **ALL CORNERS LOWER** button does not have this lock feature.

**Manual Mode – Notes**

- If the Trueline Leveling System detects an excess amount of twist in the vehicle frame during the manual adjustments, any further actions that may cause more twist are not permitted by the leveling controller.

*For example: if the vehicle is in a state as indicated by Fig. 4, the leveling controller will not allow the right front to be raised, the left front to be lowered, the right rear to be lowered, or the left rear to be raised.*

- If the vehicle begins to move, the Trueline Leveling System automatically switches from Manual mode to Travel mode at speeds higher than the designated speed limit set in the initial configuration. (See page 21.)

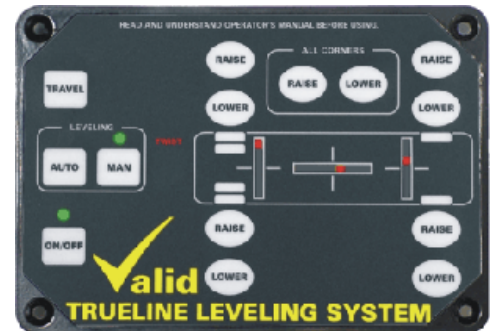

**Fig 4**

**Travel Mode**

Travel mode is the leveling mode used when the vehicle is in motion, and it gives control of the vehicle’s air suspension system to the ride height valves located on the frame of the vehicle.

**To use Travel Mode:**

Press **TRAVEL**. When possible, this should be done before the vehicle is moving.

- If the Trueline Leveling System is turned off or in any mode other than Travel, it will automatically turn on and switch to Travel mode if the vehicle speed exceeds its designated Travel mode speed limit (see page 21.)

- In Travel mode, the three level displays are scaled to indicate +/-0.75g of acceleration at full scale.

**Warning:** The time required to achieve travel height varies with coach design. It is the operator's responsibility to ensure that the coach is at an adequate height before driving. If the coach is too low, severe damage can result to the fenders when the wheels are turned.

# DIAGNOSTIC FUNCTIONS

The Trueline Leveling System has a number of diagnostic features that allow it to provide information about itself.

There are two types of diagnostic functions:

- Test diagnostics – these allow you to test the system for normal functionality.
- Fault diagnostics – these alert you to problems detected in the system.

## Test Diagnostics

### Lamp Test

Enter service mode and press the ‘Lamp Test’ function button (Left Rear **RAISE**). The system will then cycle through all of the indicators, illuminating them one at a time. Visually verify that each of the indicators illuminates.

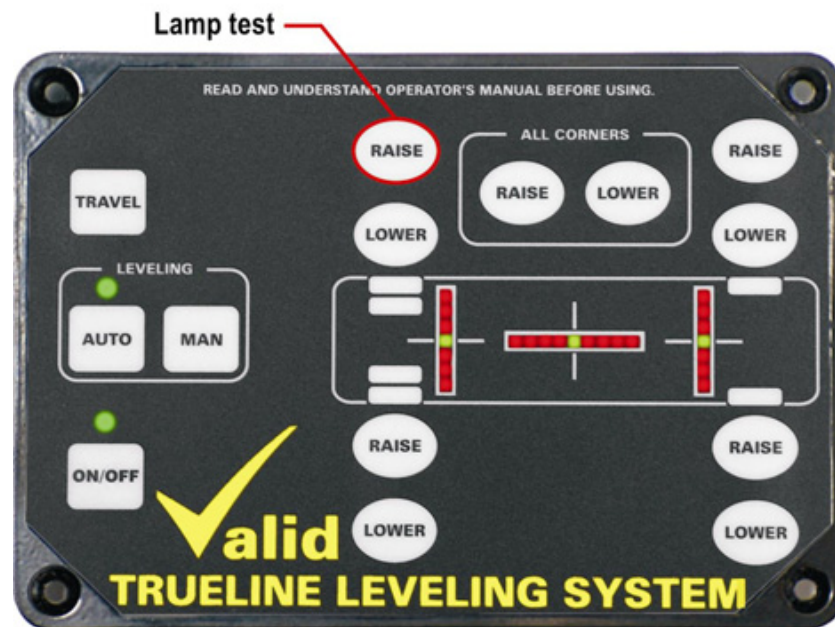

### Output Test

Enter service mode and press the 'Output Test' function button (Left Rear **LOWER**). The system will then cycle the two GP (general purpose) outputs for a few seconds. Electrically verify that each of the outputs activates.

**Warning:** Do not perform this function while the unit is being installed, since this will activate the GP outputs.

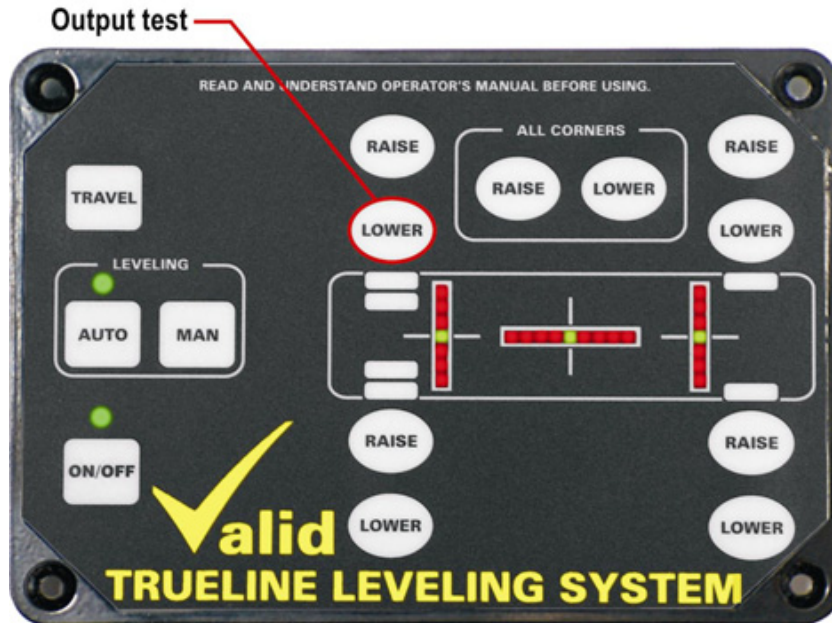



## Fault Diagnostics

Fault diagnostics provide information about loss of communication between the controller and one of the sensors, or short circuits that have been detected in one of the valves.

If there is a fault in the system, the Fault indicator light will illuminate, along with one or more LEDs in the level indication displays.

If you see:	The problem is:	See example below
Fault indicator + a full axle lit up (all red, not the green LED).	A loss of communication in that sensor.	1
Fault indicator + lowest LED on right/left side in front/rear axle.	A short in the Travel valve for the right/left side on the front/rear axle.	2
Fault indicator + middle LED on right/left side in front/rear axle.	A short in the Lower valve for the right/left side on the front/rear axle.	3
Fault indicator + upper LED on right/left side in front/rear axle.	A short in the Raise valve for the right/left side on the front/rear axle.	4

### Examples:



1. Loss of communication in front sensor



2. Short circuit in rear left Travel valve





**3. Short circuit in front right Lower valve**



**4. Short circuit in rear right Raise valve**

# EMERGENCY OVERRIDE PROCEDURES

If there is a problem in the Trueline Leveling System, there are procedures that can be followed to minimize the damage until you can reach a service depot. These include initiating a travel override, forcing valves on or off, and resetting the system.

**Warning:** These procedures must only be used under the direction of qualified service personnel. Do not attempt to use them on your own.

## Travel Override

**To initiate a travel override if a loss of communication is detected:**

If the leveling controller experiences a loss of communication from one of the sensors, you may initiate a travel override procedure by cycling the power to the sensor (for example, by pulling out and reinserting the fuse). Once the power has been interrupted and restored, the leveling system will check for communication for 30 seconds. If no communication is detected after 30 seconds, the system then activates the Travel valve for whatever end had lost communication.

**Warning:** Travel in this condition only in an emergency, and have the communication loss fixed by qualified service personnel as soon as possible

## Forcing Leveling Valves

It is possible to put the leveling system into a ‘forced’ condition, in which you can force one or more leveling valves on. When valves have been forced on, you may not use the system in any other mode.

**To go into forced mode and force a valve on:**

1. Press **ON/OFF** to turn the leveling controller on.
2. Press and hold **AUTO** for about 10 seconds or until you hear an alternating tone. The **AUTO** and **MAN** indicators will begin to flash alternately.
3. Release **AUTO**.
4. Press the right rear **LOWER** button. The Fault light will begin to flash.
5. Press the **RAISE** or **LOWER** button for any corner that you wish to force the valve on. The LED corresponding to your choice will illuminate.

**OR**

to force Travel mode, press the **TRAVEL** button. All four Travel LEDs will illuminate, as shown in the figure below.

**Note:** Once one valve has been forced on, all other valves are forced off. However, you may force on additional valves.

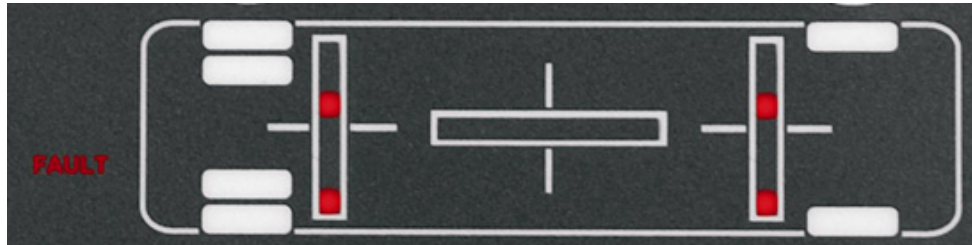

**Forced travel mode**

In forced mode, you may turn valves on or off. If **at least one** valve is forced on, the system is in a forced condition. If **no** valves are forced on, the system will exit the forced condition.

**To turn off forced valves while in the forced condition, and/or exit the forced condition:**

Press the appropriate **RAISE** or **LOWER** button to force off individual valves. Valves can be forced on and off by simply toggling the associated **RAISE** and **LOWER** buttons.

*For example: If you have forced on the front right Lower valve, press Front Right **LOWER** again to force off that valve. If that is the **only** valve that was forced on, the action of turning it off will cause the system to exit the forced condition and return the system to its standard operating mode.*

If you have forced on several valves and wish to turn them all off and exit the forced condition, press the **ALL CORNERS LOWER** button.

**Note:** The leveling system cannot be used in any other mode until all forced valves have been unforced.

## **Resetting the Leveling System**

In rare cases, you may be required to perform a full reset of your leveling system. Note that this will not reset any forced valves. Please do not reset your system unless directed by qualified service personnel.

**To reset the leveling system:**

1. Press **ON/OFF** to turn on the leveling controller.
2. Press and hold **ON/OFF** until an alternating tone is heard. The system will turn itself off after this.



# WARRANTY & SERVICE

## Warranty

Your Trueline Leveling System is warranted for a period of one year against defects of workmanship.

- If you acquired your Trueline Leveling System as a factory-installed option on a new or used coach, then your warranty extends for a one-year period commencing from the date the coach was purchased.
- If you purchased your Trueline Leveling System and had it installed yourself, then your warranty extends for a one-year period commencing from the date the leveling system was purchased.

If, during the warranty period, any component of the leveling system fails to operate as indicated in this manual, simply return the part to the point of purchase for a no-questions replacement of the component.

## Service

For information or service on your Trueline Leveling System, contact your coach manufacturer or Valid Manufacturing Ltd.

Valid Manufacturing Ltd.  
5320-B 48 Ave. SE  
Salmon Arm, B.C.  
Canada  
V1E 1X2

Phone: 250 832-6477  
Fax: 250 832-7746  
Email: [sales@validmanufacturing.com](mailto:sales@validmanufacturing.com)



# GLOSSARY

## **Accelerometer**

Traditionally, a sensor used to measure acceleration. DC-coupled accelerometers can be used to measure the acceleration due to gravity which allows them to be used as an inclinometer to measure tilt.

## **Auto mode**

The leveling mode that should be used by default when the vehicle is at a stop. This mode is the easiest to use and is suitable for most situations.

## **Controller**

The controller is the interface between the operator and the leveling system. It allows the operator to enter commands using keys, and displays information with LEDs.

## **EEPROM**

Electrically Erasable Programmable Read-Only Memory. A memory chip that can be recorded or erased electrically, but that does not lose its content when electrical power is removed.

## **GP output**

General purpose output. The Trueline Leveling System has two GP outputs, which can be optionally used as the operator wishes.

## **Manual mode**

Manual leveling mode allows you to raise or lower each corner of the vehicle individually, to the level you want. Manual leveling mode can be used if you wish to have control over the leveling process. It can also be used at low traveling speeds when an uneven surface must be negotiated.

## **Ride height**

Ride height is a manufacturer-assigned height between a vehicle's axle and the chassis. On the valve manifold, there are two ride height ports (left and right) that connect to the left and right travel valves, respectively.

## **Service mode**

The mode that the control panel must be in before certain features can be accessed, including initial configuration, diagnostic functions, and forcing valves. This mode is entered by turning the controller on and then holding down **AUTO** until an alternating tone is heard.

## **Travel mode**

The leveling mode that is used when the vehicle is in motion. By default, this mode will initiate when the vehicle is moving at a speed higher than the designated speed limit (set in the initial configuration of the system), but it is best for the operator to enter this mode before the vehicle begins moving.

## **Twist**

Occurs at the four points in a vehicle's suspension, and puts stress on the chassis and vehicle frame.





# INDEX

## A

accelerometer, 7  
actuator time, 22  
air valves  
    forcing, 37  
    piloted, 12  
    solenoid, 12  
All Corners Raise, 31  
auto level mode, 21, 28

## C

chassis ID, 21  
components included, 9  
configuration  
    actuator time limit, 22  
    auto mode, 21  
    chassis ID, 21  
    display scale, 23  
    level tolerance, 22  
    output diagnostics, 23  
    output failsafe, 23  
    park brake signal, 22  
    re-level interval, 22  
    saving settings for, 20  
    settings, 21  
    speed limit, 21  
    twist limit, 21  
contact information, 41

## D

dashboard, control panel installation, 13  
diagnostics, 33  
display scale, 23

## E

EEPROM, 43  
emergency override procedures, 37

## G

GP outputs, 34

## H

height, changing when level, 30

## I

installation, 11  
    connecting sensors, 12  
    connecting vehicle speed signal, 14  
    control panel, 13  
    front level sensor, 11  
    rear level sensor, 12

## L

lamp test, 33  
level tolerance, 22  
level, determining manually, 24  
leveling system  
    overview, 7  
lock All Corners Raise, 31  
lower  
    all corners, 30  
    front left, 24  
    front right, 19  
    rear left, 34  
    rear right, 19

## M

manual level mode, 30

## O

operation, 27  
    auto mode, 28  
    manual mode, 30  
    travel mode, 32  
orientation, setting, 18  
output diagnostics, 23  
output failsafe, 23  
output test, 34  
overview, 7

## P

park brake signal, 22

## **R**

raise  
    all corners, 18, 30, 31  
    front right, 19  
    rear left, 33  
    rear right, 19  
re-level interval, 22  
reset, 38

## **S**

safety considerations, 5  
service, 41  
service mode, 17, 43  
setup, initial, 17  
signal loss, 37  
speed limit, 21, 32  
speed signal, connecting, 14  
system reset, 38

## **T**

travel mode, 32  
troubleshooting  
    emergency overrides, 37  
    short circuit, 35  
    signal loss, 37  
twist limit, 21  
twist, in chassis, 43

## **V**

Valid Manufacturing Ltd., contact, 41  
valves  
    short circuit in, 35

## **W**

warranty, 41

## **Z**

zero setting, 24

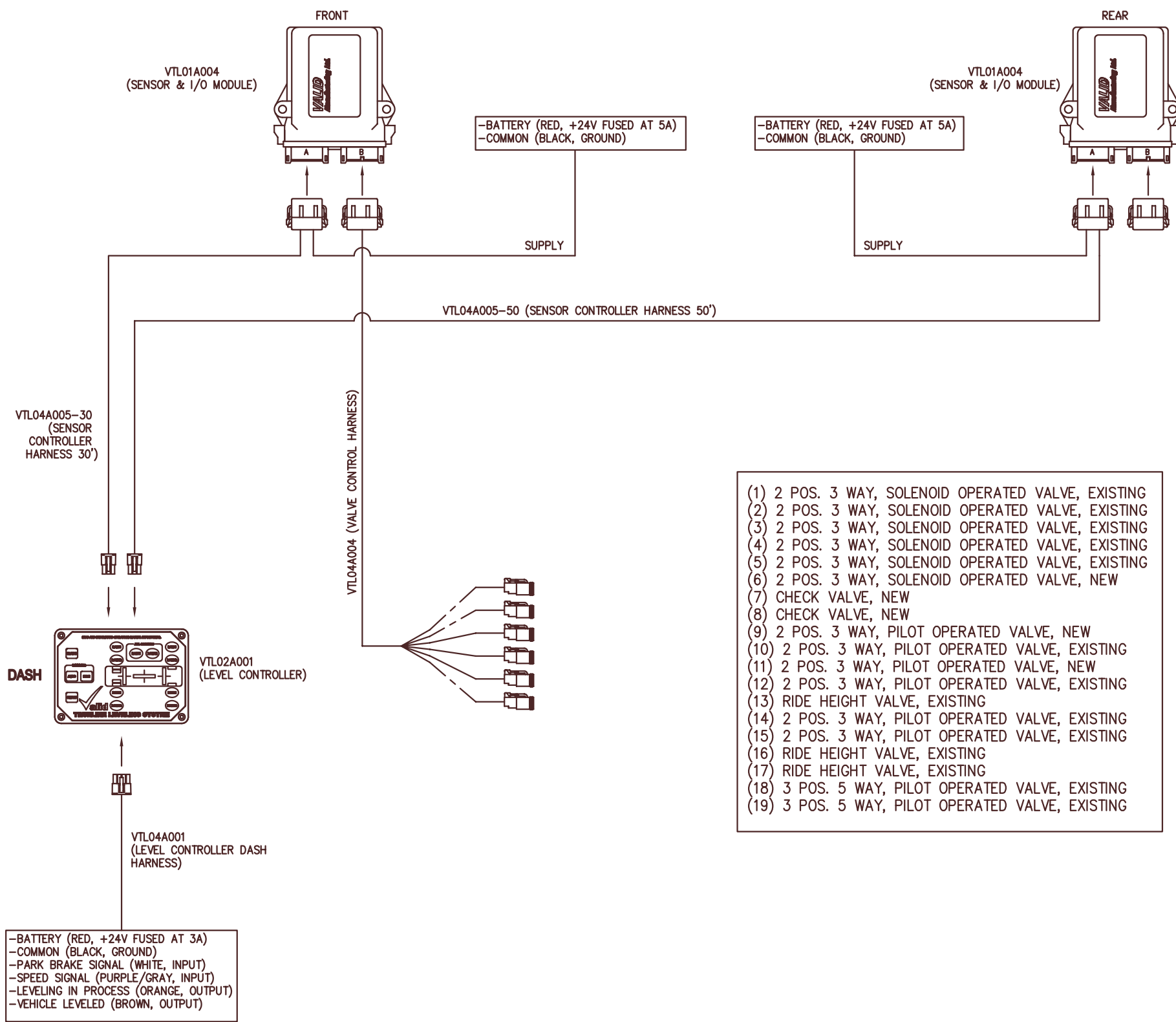

- (1) 2 POS. 3 WAY, SOLENOID OPERATED VALVE, EXISTING
- (2) 2 POS. 3 WAY, SOLENOID OPERATED VALVE, EXISTING
- (3) 2 POS. 3 WAY, SOLENOID OPERATED VALVE, EXISTING
- (4) 2 POS. 3 WAY, SOLENOID OPERATED VALVE, EXISTING
- (5) 2 POS. 3 WAY, SOLENOID OPERATED VALVE, EXISTING
- (6) 2 POS. 3 WAY, SOLENOID OPERATED VALVE, NEW
- (7) CHECK VALVE, NEW
- (8) CHECK VALVE, NEW
- (9) 2 POS. 3 WAY, PILOT OPERATED VALVE, NEW
- (10) 2 POS. 3 WAY, PILOT OPERATED VALVE, EXISTING
- (11) 2 POS. 3 WAY, PILOT OPERATED VALVE, NEW
- (12) 2 POS. 3 WAY, PILOT OPERATED VALVE, EXISTING
- (13) RIDE HEIGHT VALVE, EXISTING
- (14) 2 POS. 3 WAY, PILOT OPERATED VALVE, EXISTING
- (15) 2 POS. 3 WAY, PILOT OPERATED VALVE, EXISTING
- (16) RIDE HEIGHT VALVE, EXISTING
- (17) RIDE HEIGHT VALVE, EXISTING
- (18) 3 POS. 5 WAY, PILOT OPERATED VALVE, EXISTING
- (19) 3 POS. 5 WAY, PILOT OPERATED VALVE, EXISTING

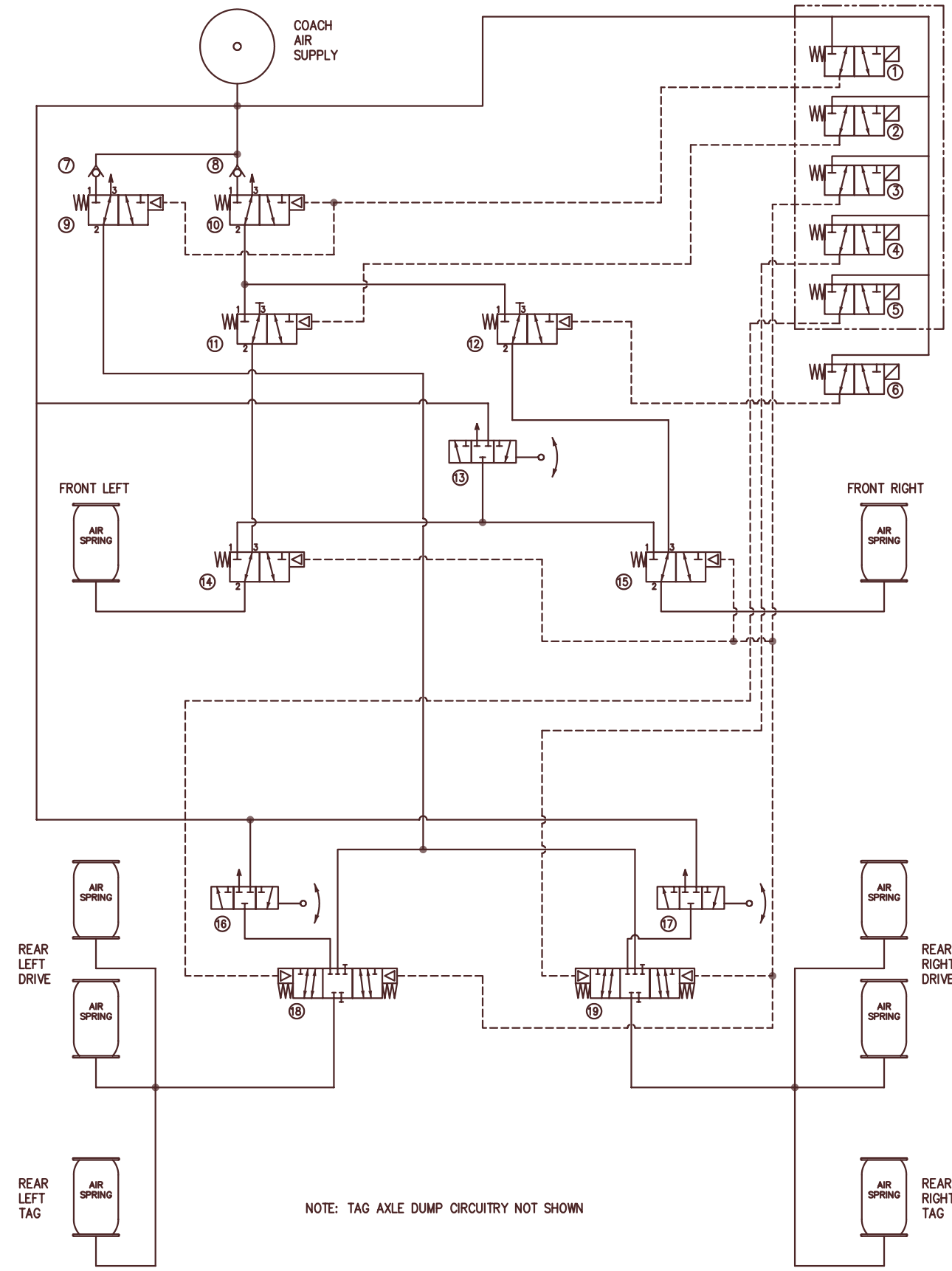

**TOLERANCES**  
(UNLESS OTHERWISE NOTED)

ALL DIMENSIONS ARE IN INCHES  
 FRACTIONAL DIMENSIONS ±1/32"  
 TWO DECIMAL DIMENSIONS ± 0.010"  
 THREE DECIMAL DIMENSIONS ± 0.003"  
 ANGLES ± 0.5°

**NOTICE**

THE DRAWINGS, INFORMATION AND SUBJECT MATTER HEREOF ARE THE CONFIDENTIAL, SOLE AND EXCLUSIVE PROPERTY OF VALID MANUFACTURING LTD. UNAUTHORIZED USE IN WHOLE OR IN PART WITHOUT WRITTEN CONSENT OR DIRECTION IS PROHIBITED.



5320-B 48th Ave. S.E. Phone 250 832-6477  
 Salmon Arm, B.C. Fax 250 832-7746  
 Canada  
 V1E 1X2  
 sales@validmanufacturing.com

**TRUeline LEVELING SYSTEM**  
**4 AXIS SCHEMATIC (PREVOST)**

LEVELING ONLY

DRAWING NUMBER  
 VTL01K004

REV	DATE	BY	DESCRIPTION

DATE	DRAWN BY	CHECKED	SCALE:
16JUNE03	GH		NONE

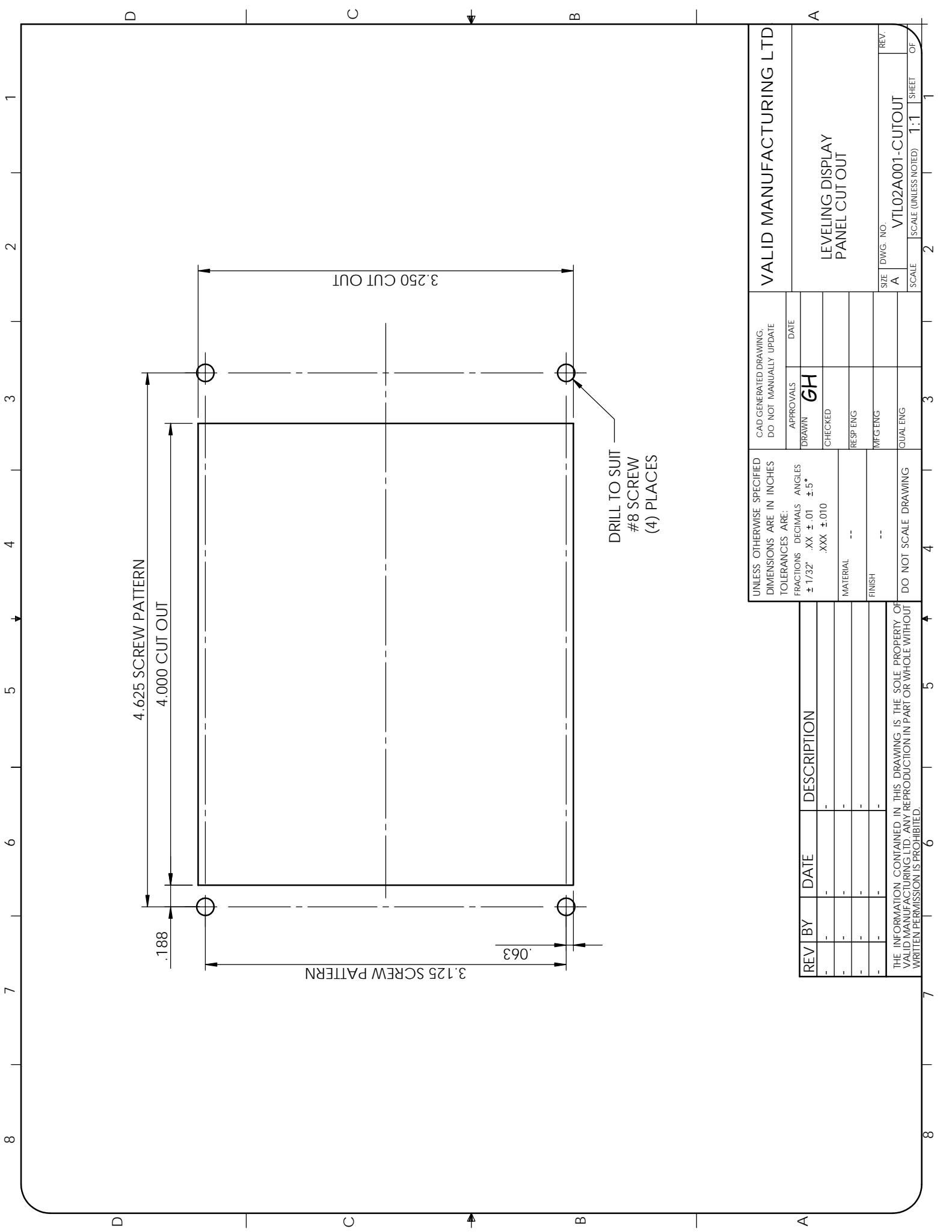

4.625 SCREW PATTERN

4.000 CUT OUT

.188

3.125 SCREW PATTERN

.063

3.250 CUT OUT

DRILL TO SUIT  
#8 SCREW  
(4) PLACES

UNLESS OTHERWISE SPECIFIED DIMENSIONS ARE IN INCHES TOLERANCES ARE:		CAD GENERATED DRAWING. DO NOT MANUALLY UPDATE		VALID MANUFACTURING LTD	
FRACTIONS	DECIMALS	ANGLES	APPROVALS	LEVELING DISPLAY PANEL CUT OUT	
$\pm 1/32"$	.XX $\pm .01$	$\pm 5^\circ$	DRAWN <b>GH</b>	DATE	REV.
.XXX $\pm .010$			CHECKED		A
MATERIAL	--		RESP ENG		VTLO2A001-CUTOUT
FINISH	--		MFG ENG		SCALE (UNLESS NOTED) 1:1
DO NOT SCALE DRAWING			QUAL ENG		SIZE A
					SCALE

REV	BY	DATE	DESCRIPTION
-	-	-	-
-	-	-	-
-	-	-	-
-	-	-	-

THE INFORMATION CONTAINED IN THIS DRAWING IS THE SOLE PROPERTY OF VALID MANUFACTURING LTD. ANY REPRODUCTION IN PART OR WHOLE WITHOUT WRITTEN PERMISSION IS PROHIBITED.



## ***Trueline Leveling System VTL01K004 Replacement Parts List***

The following VTL01K004 components can be ordered as replacement parts. The item's part number is listed beneath its name.



**Valve, air check ¼ NPT SMC**  
14CVS



**Valve, air, Norgren 2pos 3way solenoid 24VDC**  
D0045A1W2



**Valve, air, Norgren 2pos 3way piloted**  
K910026



**Leveling controller**  
VTL02A001



**Leveling sensor**  
VTL01A003



**12-pin termination cap for sensor to valve harness**  
VTL04A007



**Harness, sensor to valve, Prevest VIP**  
VTL04A006



**Harness, controller to dash**  
VTL04A001



**Harness, 30ft controller to sensor**  
VTL04A005-30



**Harness, 50ft controller to sensor**  
VTL04A005-50

## ***Service***

To order parts or request information on your Trueline Leveling System, contact your coach manufacturer or Valid Manufacturing Ltd. Valid Manufacturing can be contacted at:

Phone: 250-832-6477  
Fax: 250-832-7746  
[sales@validmanufacturing.com](mailto:sales@validmanufacturing.com)  
[www.validmanufacturing.com](http://www.validmanufacturing.com)