



PREVOST

OWNER'S MANUAL

H3-45 VIP



PREVOST®

OWNER'S MANUAL



PA1619 rev. 3
May 2021

PA1619

Featuring:

- Cooling system with electric fans.
- New electrical architecture

First edition: May 2018, starting from vehicle K-0295

REV	EFFECTIVE	DESCRIPTION	DATE
-	K-0295	First release	May 2018
1	K-0707	OBD19; New power steering reservoir; Slide-out pressure was 11psi, is 15 psi	Sept 2019
2	M-1110	New Prevost Driver Assist system	August 2020
3	N-1172	New HVAC control module	May 2021

	i
FOREWORD	
IMPORTANT INFORMATION	X
COMPLIANCE	XI
STATE OF CALIFORNIA PROPOSITION 65	XI
CRITICAL EMISSION-RELATED MAINTENANCE	XII
DATA LOGGING	XIII
EVENT DATA RECORDING DEVICES	XIII
ELECTRONIC LOGGING DEVICE (ELD)	XIII
TELEMATICS DEVICE	XIV
OWNERSHIP OR ADDRESS HAS CHANGED	XIV
QUESTIONS AND COMPLAINTS	XIV
REPORTING SAFETY DEFECTS	XV
UNITED STATES	XV
CANADA	XV
SECTION 1 - Safety Precautions	
SAFE OPERATING PRACTICES	2
DEFENSIVE DRIVING PRACTICES	2
OTHER PRECAUTIONS	3
SECTION 2 - Coach Exterior	
EXTERIOR VIEW	2
ENGINE COMPARTMENT COMPONENTS	4
ENGINE COMPARTMENT CURBSIDE DOOR	6
ENGINE COMPARTMENT DOOR	6
EXHAUST AFTERTREATMENT SYSTEM ACCESS HATCH	7
MAIN POWER COMPARTMENT	7
RADIATOR DOOR	8
SCR CONVERTER ACCESS HATCH	9
A/C CONDENSER COMPARTMENT	9
EVAPORATOR COMPARTMENT	10
FRONT ELECTRICAL AND SERVICE COMPARTMENT	10
BAGGAGE COMPARTMENTS	12
RECLINING BUMPER COMPARTMENT	12
FUEL AND DIESEL EXHAUST FLUID (DEF) FILLER NECK ACCESS	12
ENTRANCE DOOR	13
OUTDOOR OPERATION	13
INSIDE OPERATION	14
KEYLESS ENTRY SYSTEM	14
REAR-VIEW MIRRORS	14
SIDE CAMERA REAR VIEW SYSTEM	15
BACK-UP CAMERA	15
120-VOLT CONNECTORS	15
ENGINE BLOCK HEATER	15
TRAILER HITCH	16
TRAILER HITCH LOAD	16
SECTION 3 - Coach Interior	
DRIVER'S "DELIVERY" SEAT	2
DRIVER AND NAVIGATOR SEAT (ISRI)	2
PNEUMATIC ISRI SEAT	2
ELECTRICAL ISRI SEAT	2
DRIVER SEAT BELT	3
STEERING WHEEL ADJUSTMENT	4
DRIVER'S AREA SUNSHADES	4

ii - Table of contents

INSIDE MIRROR	4
ADJUSTABLE HVAC REGISTERS	4
WINDOWS	5
DRIVER'S POWER WINDOW	5
FIXED WINDOWS	5
AWNING WINDOWS	5
SLIDING WINDOWS	6
SECTION 4 - Controls and Instruments	
DRIVER'S AREA OVERVIEW	3
KEYS	4
REMOTE ENTRY TRANSMITTER	4
ENTRANCE DOOR KEY	4
EXTERIOR COMPARTMENT KEY	4
UTILITY COMPARTMENT KEY	4
FUEL FILLER DOOR KEY (OPTION)	5
IGNITION SWITCH	5
ACCESSORIES	5
OFF	5
ON	5
START	6
FOOT-OPERATED CONTROLS	6
BRAKE PEDAL	6
ACCELERATOR PEDAL	6
STEERING WHEEL ADJUSTMENT	7
STEERING COLUMN CONTROLS	8
MULTI-FUNCTION LEVER	8
STEERING WHEEL CONTROLS	9
HORNS	11
TRANSMISSION RETARDER	11
LATERAL CONTROL PANEL	12
TRANSMISSION CONTROL PAD	12
CONTROL SWITCHES	12
MIRROR CONTROLS	13
LEVEL LOW SYSTEM	14
PARKING BRAKE CONTROL VALVE	15
TAG AXLE CONTROL VALVE	15
TRAILER AIR SUPPLY CONTROL VALVE (OPTION)	15
UTILITY COMPARTMENT & 12V POWER OUTLET	15
ASHTRAY	16
CIGAR LIGHTER	16
SIDE CAMERA REAR VIEW MONITORS	16
REFERENCE LINES	16
BRIGHTNESS ADJUSTMENT	17
MONITOR STATE	17
DASHBOARD	19
CONTROL SWITCHES	20
HVAC CONTROL UNIT	24
AIR REGISTERS	25
INSTRUMENT PANEL	27
DRIVER INFORMATION LEVEL	28
ANALOG INDICATORS	29
TELLTALE LIGHTS	33
STOP, CHECK AND INFORMATION TELLTALE LIGHTS	37
DRIVER INFORMATION DISPLAY	37
PICTOGRAMS DISPLAYED ON THE DRIVER INFORMATION DISPLAY (DID)	40
ON BOARD DIAGNOSTIC TOOL RECEPTACLE	49

AUTOMATIC FIRE DETECTION AND SUPPRESSION SYSTEM (AFSS)	49
AUTOMATIC FIRE SUPPRESSION SYSTEM PANEL	49
CRUISE CONTROL	49
TURNING THE SYSTEM ON	50
SETTING A CRUISING SPEED	50
PREVOST DRIVER ASSIST™	52
ASSOCIATED HARDWARE/EQUIPMENT	52
PREVOST DRIVER ASSIST™ CONSISTS OF THE FOLLOWING SYSTEMS AND FEATURES	53
POTENTIALLY CHALLENGING SITUATIONS FOR THE PREVOST DRIVER ASSIST™ SYSTEM	55
LANE DEPARTURE WARNING LDW	55
FORWARD COLLISION MITIGATION FCM	58
ADAPTIVE CRUISE WITH BRAKING ACB	60
FOLLOWING DISTANCE ALERT (FDA)	63
FOLLOWING DISTANCE ALERT	64
IMPACT ALERT	64
BRAKE OVERUSE WARNING	65
WHAT TO EXPECT WHEN USING THE PREVOST DRIVER ASSIST™ SYSTEM	66
HOW YOUR ACTIONS IMPACT THE PREVOST DRIVER ASSIST™ SYSTEM	68
TIRE PRESSURE MONITORING SYSTEM (TPMS)	70
ON-SCREEN TPMS VERSION	70
SYSTEM MALFUNCTION	73
ALLISON TRANSMISSION	73
OPERATION	73
PUSHBUTTON SHIFT SELECTOR	73
PRIMARY AND SECONDARY SHIFT SCHEDULES	74
TRANSMISSION SERVICE INDICATOR	74
DESCRIPTION OF AVAILABLE RANGES	74
TOWING RECOMMENDATIONS	76
SECTION 5 - Other Features	
EXHAUST AFTERTREATMENT SYSTEM	3
FILTRATION AND REGENERATION UNIT	3
PASSIVE REGENERATION	3
ACTIVE REGENERATION	3
STATIONARY (PARKED) REGENERATION	3
DEF CLOGGING SEQUENCE – INSTRUMENT CLUSTER TELLTALE LIGHT	4
SELECTIVE CATALYTIC REDUCTION UNIT	5
DRIVER WARNING AND INDUCEMENT MEASURES	7
DRIVER INFORMATION DISPLAY (DID) MENUS	11
GAUGES	12
FUEL DATA	13
TIME/DISTANCE	14
VEHICLE MESSAGES	15
RESET TRIP DATA	15
DISPLAY SETTINGS	15
DIAGNOSTICS MENU	18
PRE-TRIP ASSISTANCE (OPTION)	19
DATA LOG	21
AFTERTREATMENT	22
PASSWORD	23
PREVOST LIAISON (OPTION)	23
INTELLIGENT SLEEP MODE (ISM)	25
TRANSMISSION RETARDER (OPTION)	25
ENGINE BRAKE	25
VOLVO ENGINE BRAKE (VEB)	26

iv - Table of contents

CRUISE CONTROL AND ENGINE BRAKE	26
ABS, TRACTION CONTROL SYSTEM (TCS) & ELECTRONIC STABILITY CONTROL (ESC)	27
ANTILOCK BRAKING SYSTEM (ABS)	27
TRACTION CONTROL SYSTEM (TCS)	27
ELECTRONIC STABILITY CONTROL (OPTION)	27
DRIVER CONTROLLED DIFFERENTIAL LOCK (DCDL)	28
OPERATION TIPS	28
LOCKING THE DCDL	29
UNLOCKING THE DCDL	29
RETRACTABLE TAG AXLE	29
KEYLESS ENTRY SYSTEM	29
KEYLESS OPERATING INSTRUCTIONS	30
PROGRAMMING AND MANAGING PERSONAL CODES	30
REMOTE ENTRY TRANSMITTER	31
PROGRAMMING TRANSMITTERS	32
SLIDE-OUT OPERATION	32
SAFETY PRECAUTIONS	32
FRONT AND REAR SLIDE-OUT OPERATION	32
SLIDE-OUT MANUAL OVERRIDE PROCEDURE	34
MOBILE FLOOR HAND CRANK PROCEDURE	37
SLIDE-OUT TROUBLESHOOTING	37
SLIDE-OUT TROUBLESHOOTING TABLE	39
SECTION 6 - Starting and Stopping Procedures	
STARTING THE ENGINE	2
STARTING FROM THE DRIVER'S SEAT	2
STARTING FROM THE ENGINE COMPARTMENT	3
COLD WEATHER STARTING	4
JUMP STARTING	4
ENGINE PROTECTION SYSTEM	6
AUTOMATIC ENGINE SHUTDOWN	6
IDLE SHUTDOWN TIMER	6
ENGINE BLOCK HEATER	6
ENGINE WARM-UP	7
ALLISON TRANSMISSION WARM-UP	7
STARTING THE VEHICLE AFTER A FIRE ALARM	7
SECTION 7 - Safety Features and Equipment	
EMERGENCY EXITS	2
ELECTRIC AWNING WINDOW	2
ELECTRIC SLIDING WINDOW	2
FIXED WINDOW	2
EMERGENCY EQUIPMENT	2
FIRE EXTINGUISHERS	2
FIRST-AID KIT	2
WARNING REFLECTORS H3 SERIES	3
JACK AND TOOLS H3 SERIES	3
SPARE PARTS KIT	3
AUTOMATIC FIRE SUPPRESSION SYSTEM (AFSS)	3
TIRE PRESSURE MONITORING SYSTEM	4
CHANGING WHEEL	7
EMERGENCY AIR-FILL VALVES	7
EMERGENCY AND PARKING BRAKES	8
VEHICLE JACKING POINTS	8
HYDRAULIC JACK	9
TOWING THE VEHICLE	9

DAYTIME RUNNING LIGHTS	9
FOG LIGHTS	9
CORNERING AND DOCKING LIGHTS	9
COMPARTMENT LIGHTING	9
MUD FLAPS AND SPLASH GUARDS	9
BACK-UP CAMERA	10
BACK-UP ALARM	10
BACK-UP ALARM CANCEL SWITCH	10
ESSENTIAL FUNCTIONS TO OPERATE THE VEHICLE (BASIC LIMP-HOME FUNCTIONS)	10
AVAILABLE FUNCTIONS	10
 SECTION 8 - Care and Maintenance	
CLEANING	3
SEAT UPHOLSTERY	3
PLASTIC AND VINYL	4
WINDOWS	4
STAINLESS STEEL	4
HIGH PRESSURE LAMINATE	4
RUBBER COMPONENTS	4
FLOOR CLEANING	4
EXTERIOR SURFACES	4
WINDSHIELD	5
FLUID LEVEL VERIFICATION	5
ENGINE OIL LEVEL	5
TRANSMISSION FLUID LEVEL	6
POWER STEERING FLUID LEVEL	7
DRIVE AXLE WHEEL BEARING OIL LEVEL	8
FRONT AND TAG AXLE WHEEL HUBS	8
COOLANT FLUID LEVEL	8
WINDSHIELD WASHER & HEADLIGHTS WASHER RESERVOIRS	8
OTHER VERIFICATIONS	8
ELECTRIC COOLING FANS	9
AIR TANK PURGE	9
FIRE EXTINGUISHERS	10
PRIMARY FUEL FILTER	10
DRIVER'S A/C COMPRESSOR BELT	11
CENTRAL A/C COMPRESSOR BELTS	11
ALTERNATOR DRIVE BELTS	11
BACK-UP CAMERA	11
ENGINE AIR FILTER RESTRICTION INDICATOR	12
MAIN POWER COMPARTMENT FAN AIR FILTER	12
A/C AND HEATING SYSTEM AIR FILTERS	12
HOSE INSPECTION	13
LUBRICATION	13
WHEELS AND TIRES VERIFICATIONS	13
WHEEL BEARINGS	14
SERVICE BRAKE TEST	14
PARKING BRAKE TEST	14
EXTERIOR LIGHTING VERIFICATION WITH TEST MODE	14
GENERAL RECOMMENDATIONS	17
WALK-AROUND INSPECTION (BEFORE EVERY TRIP)	21
APPROACHING THE VEHICLE	21
PREPARATION	21
STEP 1: RIGHT SIDE	21
STEP 2: ENGINE COMPARTMENT RIGHT SIDE AREA	22
STEP 3: ENGINE COMPARTMENT	22
STEP 4: REAR LEFT SIDE	22

vi - Table of contents

STEP 5: FRONT LEFT SIDE	22
STEP 6: FRONT	23
STEP 7: FRONT RIGHT SIDE	23
STEP 8: INSIDE THE VEHICLE	23
WITH ENGINE RUNNING	23
SECTION 9 - Technical Information	
DIMENSIONS AND WEIGHTS	3
CAPACITIES	6
TURNING RADIUS	6
FUEL TYPE	8
BIODIESEL FUEL	8
WHEELS AND TIRES	8
RECOMMENDED TIRE INFLATION PRESSURE AT MAXIMUM COLD LOAD	8
BELTS	9
VOLVO D13 ENGINE	9
ALLISON TRANSMISSION	10
GEAR RATIOS	10
PROPELLER SHAFT	10
BRAKES	10
BRAKE CHAMBER EFFECTIVE AREA	10
AIR SYSTEM	10
ANTILOCK BRAKING SYSTEM (ABS)	10
TROUBLESHOOTING AND TESTING	10
AUTOMATIC TRACTION CONTROL (ATC) – ELECTRONIC STABILITY CONTROL (ESC)	10
STEERING	11
ELECTRICAL SYSTEM	11
AXLES	11
FRONT AXLE - INDEPENDENT FRONT SUSPENSION (IFS)	11
DRIVE AXLE	11
TAG AXLE	11
SUSPENSION	11
INDEPENDENT FRONT SUSPENSION	12
DRIVE AXLE	12
TAG AXLE	12
ALIGNMENT SPECIFICATIONS	12
COOLING SYSTEM	13
FUEL SYSTEM	13
EXHAUST SYSTEM	13
HEATING AND AIR CONDITIONING	13
OIL SPECIFICATIONS	14
ENGINE	14
ALLISON TRANSMISSION	14
DIFFERENTIAL	14
POWER STEERING RESERVOIR	14
PLATES AND CERTIFICATION	14
SAFETY CERTIFICATION	15
DOT CERTIFICATION PLATE	15
EPA ENGINE LABEL	15
VEHICLE IDENTIFICATION NUMBER (VIN)	16
VIN DEFINITION	17
COACH FINAL RECORD	18
ABBREVIATIONS	
APPENDIX A - Service Literature	
SERVICE LITERATURE	2
NOTICE	2

DECLARATION OF THE MANUFACTURING DEFECTS TO THE GOVERNMENT OF THE UNITED STATES	2
DECLARATION OF THE MANUFACTURING DEFECTS TO THE CANADIAN GOVERNMENT	3
DECLARATION OF THE MANUFACTURING DEFECTS TO PREVOST	3
APPENDIX B - Multiplex Troubleshooting	
MULTIPLEX TROUBLESHOOTING GUIDE	2
APPENDIX C - Allison Transmission Other Features	
OIL LEVEL CHECK USING THE PUSHBUTTON SHIFT SELECTOR	2
CONTROL SYSTEM PROGNOSTICS	2
NORMAL PROGNOSTICS INDICATION AT ENGINE START	3
OIL LIFE MONITOR	3
FILTER LIFE MONITOR	4
TRANSMISSION HEALTH MONITOR	5
DIAGNOSTIC TROUBLESHOOTING CODES (DTC) — ALLISON 5TH GENERATION CONTROLS	7
DIAGNOSTIC TROUBLESHOOTING CODES (DTC) OVERVIEW	7
USING SHIFT SELECTOR FOR ACCESSING DIAGNOSTIC INFORMATION	7
DIAGNOSTIC CODE DISPLAY AND CLEARING PROCEDURE	8
EXITING DIAGNOSTIC MODE	8
DIAGNOSTIC TROUBLE CODE RESPONSE	9
DIAGNOSTIC TROUBLESHOOTING CODES (DTC) LIST - ALLISON 5TH GENERATION CONTROLS	10
APPENDIX D	
ON-SCREEN TPMS	2

FOREWORD

IMPORTANT INFORMATION	X
COMPLIANCE	XI
STATE OF CALIFORNIA PROPOSITION 65	XI
CRITICAL EMISSION-RELATED MAINTENANCE	XII
DATA LOGGING	XIII
EVENT DATA RECORDING DEVICES	XIII
ELECTRONIC LOGGING DEVICE (ELD)	XIII
TELEMATICS DEVICE	XIV
OWNERSHIP OR ADDRESS HAS CHANGED	XIV
QUESTIONS AND COMPLAINTS	XIV
REPORTING SAFETY DEFECTS	XV
UNITED STATES	XV
CANADA	XV

IMPORTANT INFORMATION

This manual has been prepared to thoroughly acquaint the driver and service technicians with the equipment and features in order to fully appreciate and safely enjoy this vehicle.

Prevost is committed to the continuous improvement quality, reliability, durability and safety. With innovative features, the vehicle was designed with passenger, driver safety and comfort in mind.

This manual contains information available at the time of publication. Standard and optional equipment are covered in this manual. Therefore, some of the optional equipment described may not apply to your vehicle. In doubt, refer to the technical documentation package provided.

Driver's controls and instruments incorporate advanced technology for enhanced driving ease and security. This manual describes the main features, instruments, controls, and servicing requirements for standard and optional equipment.

Read this manual carefully to take advantage of the advanced features and to ensure optimum safety and passenger comfort.

Keep the manual in the vehicle at all times. Make sure it is kept with the vehicle when ownership is transferred. Please notify the [Prevost Warranty Support Team](#) of any change of address or transfer of ownership. This will ensure fast and reliable service to all operators.

NOTE

Illustrations in this manual are used for reference only and may differ from the actual vehicle; however, key components addressed in the manual are represented as accurately as possible.

Danger, Warning, Caution and Note are used throughout this manual to emphasize important points when necessary:



DANGER

Directs the operator's attention to unsafe practices which could result in serious personal injury or death.



WARNING

Directs the operator's attention to unsafe practices which could result in serious personal injury or severe damage to the vehicle.



CAUTION

Directs the operator's attention to unsafe practices where personal injury is not likely but damage to vehicle components could occur.

NOTE

Indicates supplementary information essential to the proper operation of the vehicle.

The service life of the vehicle depends on the kind of attention it receives. Pay close attention to the warnings, cautions and notes. Read the various notices and instructions posted throughout the vehicle and attached to equipment.

Continuous improvement is a primary focus at Prevost, we reserve the right to make changes anytime, without notice, and without incurring any obligation.







Before reproducing or copying this manual, in whole or in part, written consent must be obtained from Prevost.

COMPLIANCE

STATE OF CALIFORNIA PROPOSITION 65

	<h2 style="margin: 0;">WARNING</h2>
<p>Breathing diesel engine exhaust exposes you to chemicals known to the State of California to cause cancer and birth defects or other reproductive harm.</p> <ul style="list-style-type: none"> - Always start and operate the engine in a well-ventilated area. - If in an enclosed area, vent the exhaust to the outside. - Do not modify or tamper with the exhaust system. - Do not idle the engine except as necessary. <p>For more information go to www.P65warnings.ca.gov/diesel</p>	

Proposition 65 Warning Decal on Diesel Engine Exhaust Health Hazard

<p style="text-align: right;">18755-1</p> <div style="border: 1px solid black; padding: 10px;"> <div style="background-color: orange; color: white; padding: 5px; text-align: center;">  WARNING </div> <p style="font-size: small;">Breathing diesel engine exhaust exposes you to chemicals known to the State of California to cause cancer and birth defects or other reproductive harm.</p> <ul style="list-style-type: none"> - Always start and operate the engine in a well-ventilated area. - If in an enclosed area, vent the exhaust to the outside. - Do not modify or tamper with the exhaust system. - Do not idle the engine except as necessary. <p style="font-size: x-small;">For more information go to www.P65warnings.ca.gov/diesel</p> <p style="text-align: right; font-size: x-small;">0691001</p> </div> <p>DECAL #0691001</p> <p>This warning decal is available through Prevost Parts.</p>	<table style="width: 100%; border-collapse: collapse;"> <tr> <td style="text-align: center; border-right: 1px dashed black; padding: 5px;"> <h3 style="margin: 0;">H3 SERIES</h3>  </td> <td style="text-align: center; padding: 5px;"> <h3 style="margin: 0;">X3 SERIES</h3>  </td> </tr> <tr> <td colspan="2" style="text-align: right; padding-top: 10px;">18755</td> </tr> </table> <p>Best location where to affix the decal on the vehicle.</p>	<h3 style="margin: 0;">H3 SERIES</h3> 	<h3 style="margin: 0;">X3 SERIES</h3> 	18755	
<h3 style="margin: 0;">H3 SERIES</h3> 	<h3 style="margin: 0;">X3 SERIES</h3> 				
18755					

CRITICAL EMISSION-RELATED MAINTENANCE

Source of parts and repair:

A repair shop or person of the owner's choosing must maintain, replace, or repair emission control devices and systems per manufacturer's recommendations.

Replacement of tires that are GHG certified:

The original equipment tires installed on this vehicle at the factory were certified to the U.S. EPA Greenhouse Gas (GHG) and National Highway Traffic Safety Administration (NHTSA) Fuel Efficiency regulations. Replacement of these tires should be with a tire of equal or lower rolling resistance levels (TRRL or Crr). Please consult your tire supplier(s) for appropriate replacement tires.

Maintaining a GHG certified tire:

In order to maintain the certified rolling resistance of the tires which optimize fuel economy, the maintenance procedures provide by the tire manufacturer must be followed.

DATA LOGGING

EVENT DATA RECORDING DEVICES

This PREVOST vehicle is equipped with a device generally referred to as an "event data recorder" or "EDR." Please note that while the term "event data recorder" is typically used throughout the motor vehicle industry, not every EDR is the same; i.e., they do not all record the same data elements.

The EDR on this PREVOST vehicle records vehicle speed, engine RPM, time and date, plus a variety of pedal and switch positions, both before and after an "event." Sudden vehicle deceleration or the occurrence of certain other vehicle operational characteristics will define (trigger) an "event."

For any questions about this vehicle EDR device, contact a PREVOST Service Center or a regional service manager.

ELECTRONIC LOGGING DEVICE (ELD)

This vehicle is equipped with a dedicated ELD interface connector located under the lower left part of the dashboard. This SAE J1939 9 PIN connector is compatible with most FMCSA approved ELD and will ensure that the ELD will not interfere with the vehicle communication, diagnostic and/or driving systems.

Please take note that **the OBD connector is only intended as a diagnostic equipment connection.** Installing an aftermarket plug-in device that uses the OBD port may cause interference and/or damage to the vehicle systems, potentially affecting safe operation.

Both connectors (OBD and ELD) are clearly identified under the dash by stickers. **The OBD port must remain unconnected at all times except during vehicle maintenance (using Prevost approved diagnostic equipment only).**

Connecting aftermarket equipment to the OBD connector may lead to:

- Incorrect emission monitoring and failure to meet the requirements of emission tests.
- Erratic behaviour of one or more of the vehicle safety devices/driving aids, increasing the risk of accidents.
- False code readings and inconsistency during vehicle diagnostic procedures, increasing vehicle down time.
- Unreliable ELD connection/recording and potential violations with the federal ELD regulations*.

* For more information regarding Federal ELD requirements, consult the [FMSCA](#)

xiv - Foreword

TELEMATICS DEVICE

Your vehicle is equipped with one or more recording devices (“Telematics Device”), associated with Prevo’s Connected Vehicle Services (the “Telematics Services”). These services, which are described in greater detail at www.prevostcar.com (the “Website”), allow you to manage vehicle maintenance and repair in a cost-effective manner by providing: proactive diagnostic and repair planning assistance with detailed analysis of diagnostic trouble codes; streamlined service procedures with parts-on-hand confirmation before a vehicle arrives for service; and live repair and customer communication. The service eliminates or reduces diagnostics time, enhances repair efficiency, expedites decision process, improves communications and maximizes uptime. To access the Telematics Services, you must enter into a Telematics Subscription Agreement with Prevo, via the sales agreement pertaining to your vehicle.

The Telematics Device collects stores and/or transmits information about your vehicle. Such information may include direction and rate of speed, fuel consumption, engine performance, gearing, rpm, altitude, geo-location (including a history of where the vehicle travels), safety information related to the use and operation of the vehicle, vehicle performance, diagnostic data and error codes. The Telematics Device has the capacity to store historical data about the use and performance of your vehicle. The Telematics Device has the ability to transmit information to a central communications system. The information contained in your Telematics Device may be periodically transmitted to or accessed by Prevo and others authorized by Prevo, along with your vehicle’s VIN number or other identifying information. Prevo does not collect any driver information. Prevo retains and uses this information to understand the operational use of your vehicle, to remotely tune your vehicle, and to help facilitate maintenance and vehicle improvements. To the extent allowed by law, Prevo reserves the right to access, use and control this information.

Declining to enter into a Telematics Subscription Agreement with Prevo, or canceling a Telematics Subscription Agreement, will not end the transmission of data from your Telematics Device or the collection of information by Prevo. Prevo may access Telematics Data, to the extent it is available, and use it in connection with providing services and vehicle improvements to you and your vehicle. Prevo will regularly purge from its systems all data collected from your Telematics Device, at time intervals determined by Prevo at its sole discretion.

OWNERSHIP OR ADDRESS HAS CHANGED

If your address has changed or you are the new owner, please help us update our records. Use the link below to access the Prevo Warranty Support web page.

<http://www.prevostcar.com/parts-and-services/warranty>

Click on the link ‘Change of address or ownership’, fill the form, save it and email the file at prevost.onlinewarranty@volvo.com.

QUESTIONS AND COMPLAINTS

Your satisfaction is our most important concern. If questions or complaints arise, first discuss the matter with the service manager at the Prevo facility involved. If you are not satisfied with the service manager’s response, contact the branch manager. If, for any reason, you need further assistance after dealing with the personnel at a Prevo facility, contact your regional service manager. The regional service manager has the responsibility and the authority to recommend action in most cases and (with the aid of relevant district service personnel) will make every effort to conduct a fair review of the situation.

REPORTING SAFETY DEFECTS

UNITED STATES

If you believe that your vehicle has a defect which could cause a crash, injury or death, you should immediately inform the National Highway Traffic Safety Administration (NHTSA), in addition to notifying Prevest.

If NHTSA receives similar complaints, it may open an investigation and if it finds that a safety defect exists in a group of vehicles, it may order a recall and remedy campaign. However, NHTSA cannot become involved in individual problems between you, your Prevest Service Center, or Prevest.

To contact NHTSA, either call the U.S. Government's Vehicle Safety Hotline toll-free at 1-888-327-4236 (TTY: 1-800-424-9153); go to <http://www.NHTSA.gov>; or write to: Administrator, National Highway Traffic Safety Administration, 400 Seventh Street, S.W., Washington, DC 20590. You can also obtain other information about motor vehicle safety from the Vehicle Safety Hotline.

CANADA

Canadian customers who wish to report a safety-related defect to Transport Canada — Defect Investigations and Recalls, may telephone the toll free hotline at 1-800-333-0510, or contact Transport Canada by mail at Transport Canada, ASFAD, Place de Ville Tower C, 330 Sparks Street, Ottawa ON K1A 0N5. For additional road safety information, please visit the Road Safety website at <http://www.tc.gc.ca/roadsafety/menu.htm>.

SECTION 1 - SAFETY PRECAUTIONS

SAFE OPERATING PRACTICES 2
DEFENSIVE DRIVING PRACTICES 2
OTHER PRECAUTIONS 3

1-2 Safety Precautions

SAFE OPERATING PRACTICES

To ensure safe and reliable operation, heed the following safety precautions.

- Operation and maintenance of the vehicle must be performed only by qualified personnel.
- Before driving, conduct a walk around inspection and check that all baggage compartment doors and equipment access doors are securely shut.
- Make sure good visibility is maintained at all times. Keep windshields clean and free of obstructions.
- Adjust the driver's seat so that all controls can be reached easily.
- Always wear your safety belt when driving.
- Check the instrument panel frequently. Do not operate the vehicle when dials or indicators do not indicate normal operating conditions.
- Always pay attention to pedestrians passing in front and behind the vehicle. Always yield to pedestrians at pedestrian walkways.
- Do not drive over obstacles on the road. Empty boxes, piles of leaves, and snowdrifts could conceal hidden dangers that could damage the vehicle suspension and underbody.
- When turning or changing lanes, signal your intention well in advance.
- When approaching to make a right turn, reduce the space between the vehicle and the curb to make sure another vehicle cannot pass on the right. Since the vehicle makes wide turns, allow enough space to make safe turns.
- Switch from high beams to low beams when meeting or following other vehicles within 500 feet (150 meters).
- Never leave the vehicle unattended with the engine running or with the key in the ignition. Turn off the engine, remove keys and apply the parking brake before leaving the vehicle.
- Shut-off the engine before refueling, adding oil, performing maintenance or servicing tasks, unless stated otherwise.
- Fuel is highly flammable and explosive. Do not smoke when refueling. Keep away from open flames or sparks.
- Do not run the engine or HVAC system with access doors left open. Close compartment doors before operating any equipment.
- Do not remove the surge tank filler cap or the cooling system pressure cap when the engine is hot. Let the engine cool down before removing filler caps.
- Do not attempt to push or pull-start the vehicle.
- The service life of the vehicle depends on the kind of maintenance it receives. Always record any problems and report them immediately to maintenance personnel.
- After each trip, perform a system diagnostic to check if error codes and anomalies were recorded in the vehicle electronic modules.
- Do not use the trailer hitch before reading the safety, technical and operational requirements..
- Do not use the trailer hitch before reading the safety, technical and operational requirements on page 14 of this manual.

DEFENSIVE DRIVING PRACTICES

- For city driving, allow a four to six second travel interval between your vehicle and the vehicle ahead. Increase this travel interval to six to eight seconds for highway driving. Increase time interval for driving at night or in foul weather.
- Be prepared to stop when approaching an intersection. The stopping distance of the vehicle increases with the weight and speed.
- Establish eye-to-eye contact with other drivers and with pedestrians. Use, high beam and low beam headlights, turn signals and horn as needed.
- On highway, don't stare at the road ahead. Keep your eyes moving. Check mirrors and dashboard instruments frequently.
- To keep the vehicle from drifting across lanes during highway driving, always look over the horizon on the road ahead.
- Adjust your speed to road conditions, traffic and visibility. Never exceed the posted speed limits.

- If another vehicle is following close behind, reduce your speed to let the vehicle pass.
- For additional information about safe operation and defensive driving practices, contact the local department of motor vehicles authority.

OTHER PRECAUTIONS



WARNING

CALIFORNIA PROPOSITION 65

Diesel engine exhaust and some of its constituents are known to the State of California to cause cancer, birth defects and other reproductive harm.

Battery posts, terminals and other related accessories contain lead and lead compounds, chemical known to the State of California to cause cancer and other reproductive harm.

Batteries also contain other chemicals known to the State of California to cause cancer.

Wash hands after handling.



DANGER

Make sure that electrical current or air pressure is removed before performing any work. A part may be energized even if the ignition switch is OFF. A part may be under pressure even if all tanks are empty. Before performing any work on the vehicle, refer to wiring diagrams and/or air schematics to thoroughly understand the system.

NOTE

When the ignition switch is set to the OFF position, the electrical components are not energized except for the MCM (Master Chassis Module), the battery equalizer, the preheater system and some electronic modules; which are energized during 15 minutes after the ignition has been set to the OFF position. Prior to working on one of these electrical components, set the battery master switch in the main power compartment to the OFF position. If the vehicle will not be operated for a long period (more than 2 weeks), it is recommended, in order to prevent the batteries from discharging, to trip the main circuit breakers located in the main power compartment to stop the small current drawn by the radio preset station memory, the MCM memory and the instrument cluster clock. Note that the radio station presets will be erased, same thing for the diagnostic codes history and the instrument cluster clock will have to be reset.



CAUTION

PRECAUTIONS ARE TO BE OBSERVED BEFORE WELDING TO MINIMIZE THE RISK OF MAJOR AND COSTLY DAMAGES CAUSED TO THE VEHICLE ELECTRONIC COMPONENTS!

1. Set the main electrical shut-off switch to "OFF" position.
2. Trip circuit breaker CB2 and CB6.
3. Disconnect electronic ground terminal from the ground junction block located in the battery compartment.
4. Make sure to clamp the welding ground return as close as possible to the welding point and make a good electric contact to the chassis.

Detailed instructions are provided in section 00-GENERAL of your vehicle maintenance manual.

SECTION 2 - COACH EXTERIOR

EXTERIOR VIEW	2
ENGINE COMPARTMENT COMPONENTS	4
ENGINE COMPARTMENT CURBSIDE DOOR	6
ENGINE COMPARTMENT DOOR	6
EXHAUST AFTERTREATMENT SYSTEM ACCESS HATCH	7
MAIN POWER COMPARTMENT	7
RADIATOR DOOR	8
SCR CONVERTER ACCESS HATCH	9
A/C CONDENSER COMPARTMENT	9
EVAPORATOR COMPARTMENT	10
FRONT ELECTRICAL AND SERVICE COMPARTMENT	10
BAGGAGE COMPARTMENTS	12
RECLINING BUMPER COMPARTMENT	12
FUEL AND DIESEL EXHAUST FLUID (DEF) FILLER NECK ACCESS	12
ENTRANCE DOOR	13
OUTDOOR OPERATION	13
INSIDE OPERATION	14
KEYLESS ENTRY SYSTEM	14
REAR-VIEW MIRRORS	14
SIDE CAMERA REAR VIEW SYSTEM	15
BACK-UP CAMERA	15
120-VOLT CONNECTORS	15
ENGINE BLOCK HEATER	15
TRAILER HITCH	16
TRAILER HITCH LOAD	16

2-2 Coach Exterior

EXTERIOR VIEW

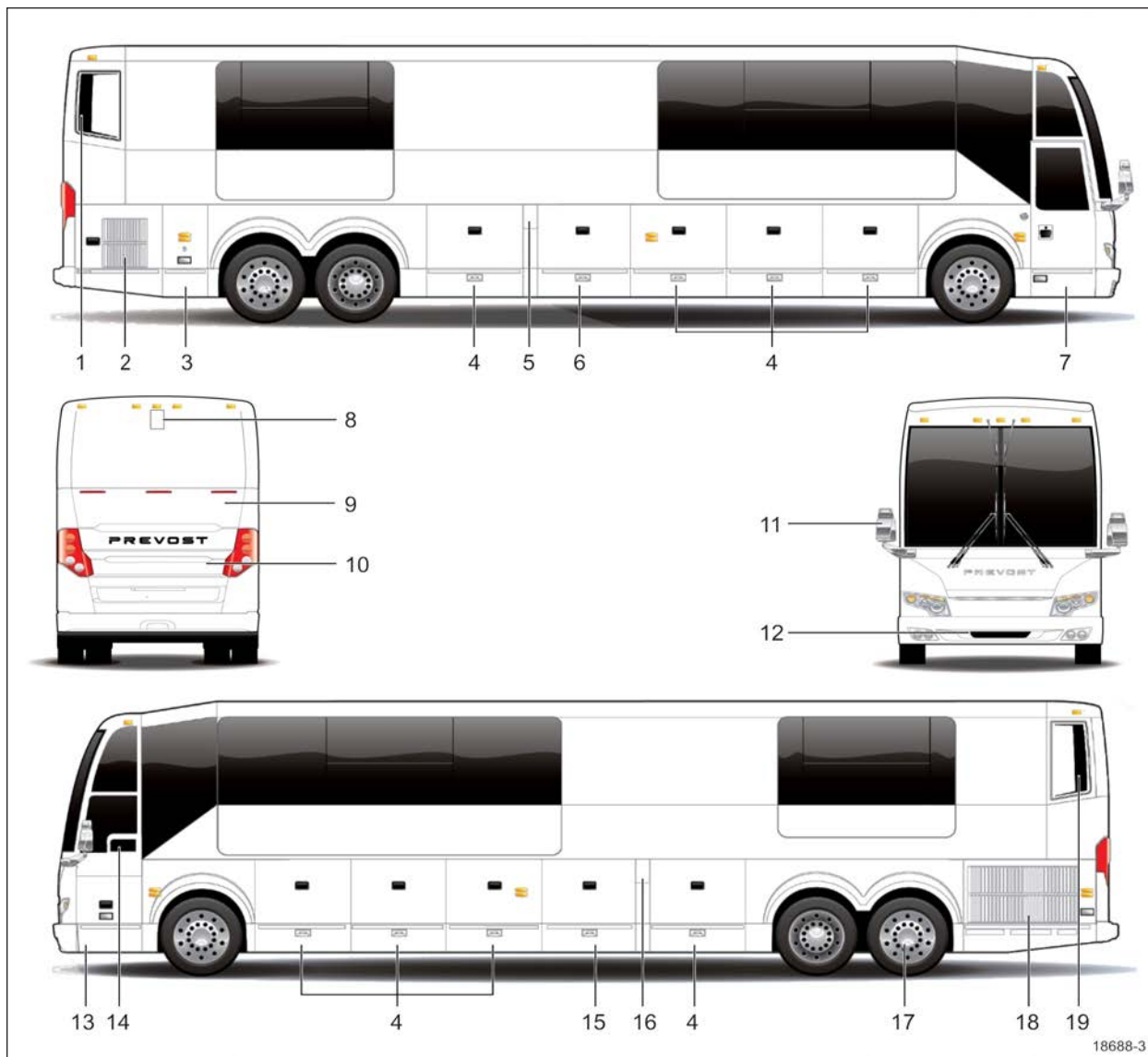

FIGURE 1: H3-45 VIP EXTERIOR VIEW

1. Engine air intake
2. Engine R.H. side access door
3. Main power compartment (battery compartment)
4. Baggage compartment
5. Fuel filler neck access door
6. A/C condenser or baggage compartment
7. Entrance door
8. Retractable backup camera (optional)
9. Diesel Particulate Filter (DPF) access door
10. Engine compartment rear door
11. Rear-view mirror
12. Reclining bumper compartment
13. Front electrical and service compartment
14. Driver's power window
15. Heating, ventilating and air conditioning compartment (HVAC) or baggage compartment
16. Fuel filler neck and diesel exhaust fluid (DEF) filler neck access door
17. Auxiliary axle (TAG)
18. Engine radiator door
19. SCR catalytic converter access door

ENGINE COMPARTMENT COMPONENTS

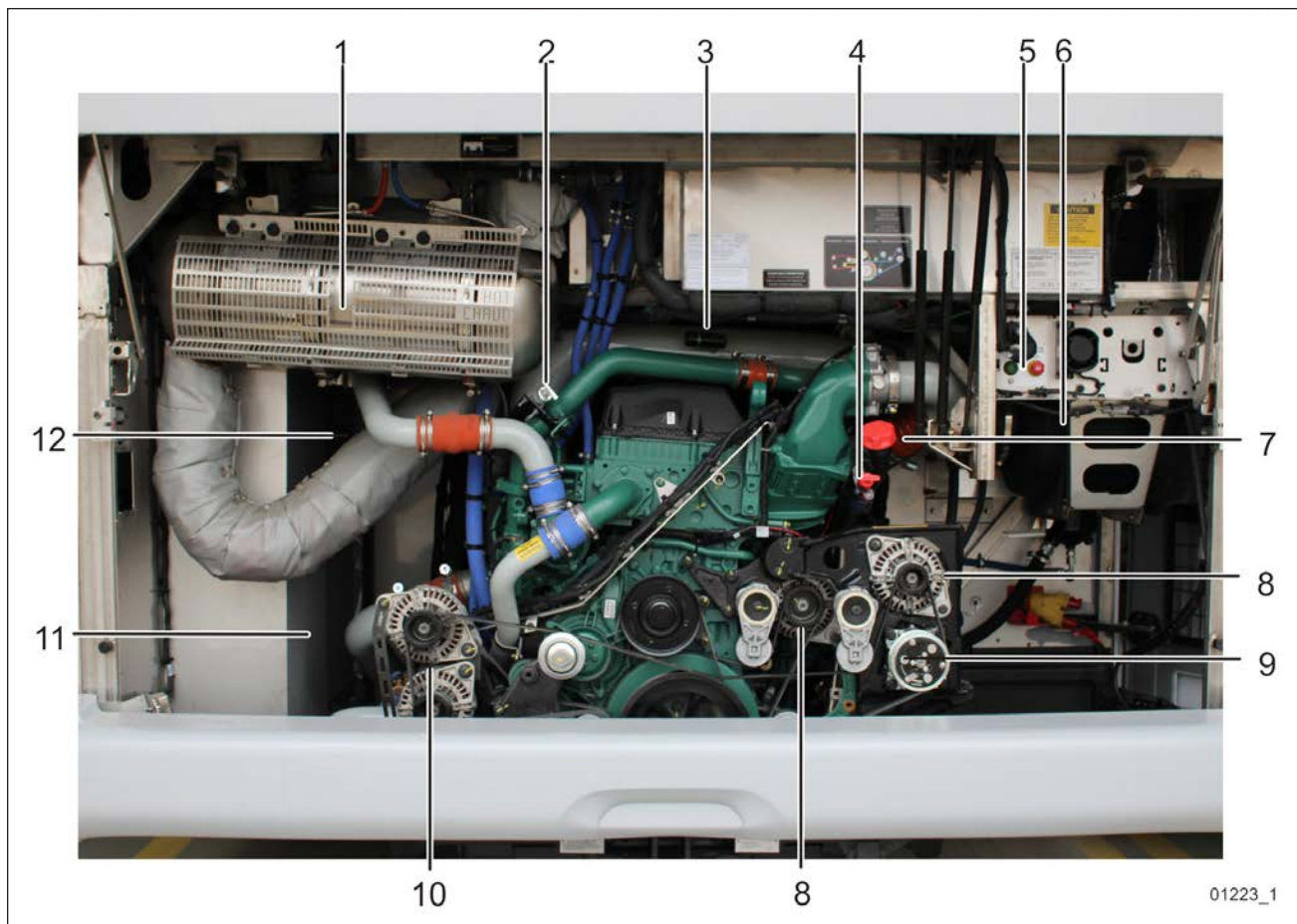
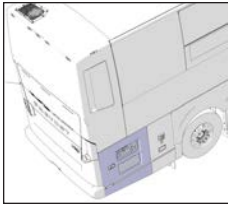

FIGURE 2: ENGINE COMPARTMENT FEATURING VOLVO D13 ENGINE

1. Diesel Oxidation Catalyst (DOC) & Diesel Particulate Filter (DPF) Assembly;
2. Transmission fluid dipstick (if equipped with Allison transmission);
3. Air filter restriction indicator;
4. Engine oil dipstick;
5. Rear start / stop panel;
6. Air filter;
7. Engine oil filler tube and cap;
8. Alternators, Curb side;
9. Small A/C compressor;
10. Alternators, Road side;
11. Radiator;
12. Charge air cooler (CAC).

2-6 Coach Exterior

ENGINE COMPARTMENT CURBSIDE DOOR



Lock this door using the exterior compartment key. To open, pull up the door handle to release the latch and then pull the door open.

The curbside door also has a safety catch to prevent it from closing inadvertently. Release the catch before attempting to close.

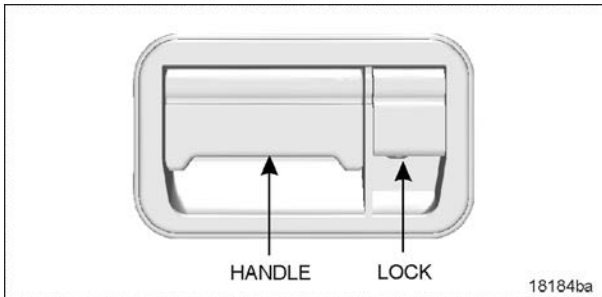

FIGURE 3: DOOR HANDLE

The engine compartment curbside door provides access to the following (if equipped):

- Engine compartment rear door release lever
- Davco Fuel Pro 382 filtration system
- Primary & secondary air system fill valve
- Power steering fluid tank
- Booster block terminals
- Wet air tank drain cock
- Engine air filter
- Battery charger 110-120 volts connector
- Engine block heater 110-120 volts connector



WARNING

Unless otherwise stated, do not run the engine when the engine compartment curbside door is open.

ENGINE COMPARTMENT DOOR

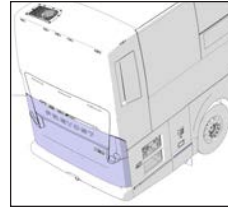

To open the engine door, first open the curbside door. Lift the latch release lever. Unlatch the door and pull it out and up.

The door should stay open by itself but it is recommended to always use the safety catch as shown. The lighting in the engine compartment turns on automatically when the door is open. When open or not closed properly, a pictogram appears on the instrument cluster DID. To close the door, lift it slightly and release the safety catch.

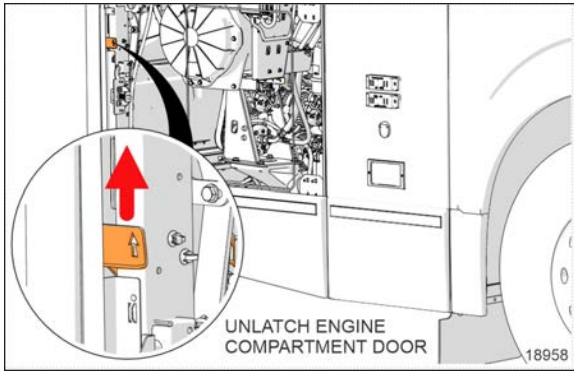

FIGURE 4: OPENING THE ENGINE COMPARTMENT DOOR

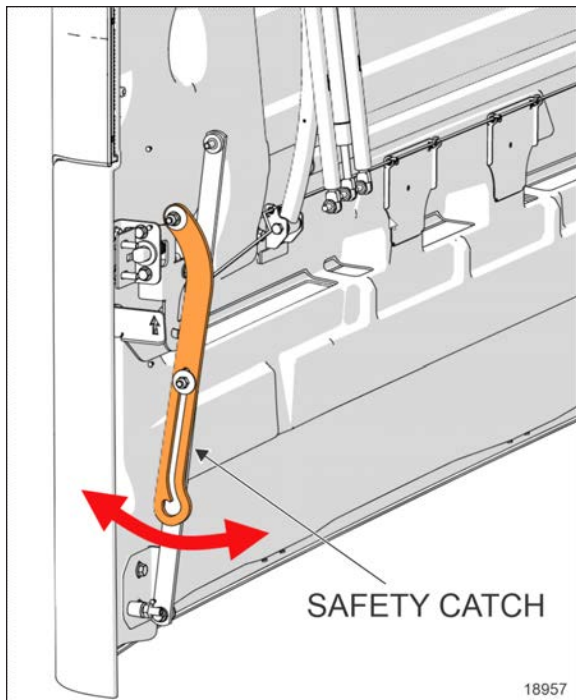

FIGURE 5: SAFETY CATCH

This door provides access to the following equipment:

- Engine
- Alternators
- Belts and belt tensioners
- A/C compressor
- Rear starter switch (see "[STARTING FROM THE ENGINE COMPARTMENT](#)" on page 3 in Section 6 Starting and Stopping Procedures)
- Engine certification plate
- Air filter restriction indicator
- Engine oil dipstick and filler cap

- Transmission oil dipstick
- Cooling fluid surge tank and recovery tank



WARNING

Unless otherwise stated, avoid running the engine when the engine compartment door is open.

EXHAUST AFTERTREATMENT SYSTEM ACCESS HATCH

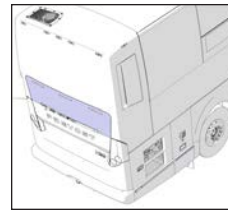

The engine compartment door must be opened before opening the DPF access hatch. To open, press the latch release lever. Using both hands, push the access hatch up until it locks in place.

To close the access hatch, press the latch release lever again and lower the hatch, holding it with both hands.

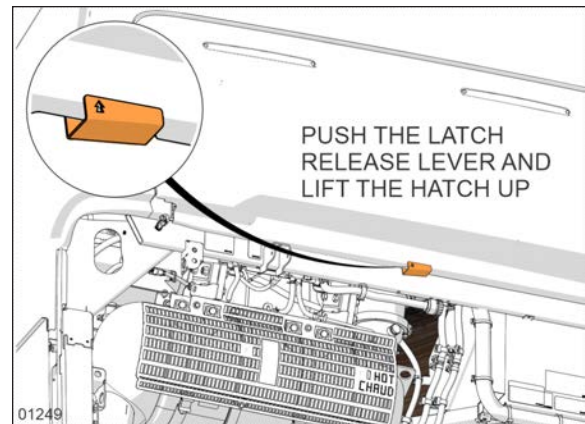
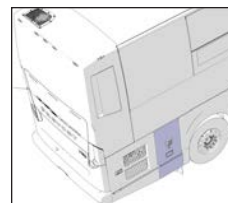

FIGURE 6: EXHAUST AFTERTREATMENT SYSTEM ACCESS HATCH

MAIN POWER COMPARTMENT



To open the main power compartment door, use the exterior compartment door key. The door will pop open.

The compartment light turns on automatically when the door is open and the ignition switch is in the ON position. A telltale light indicating that a

2-8 Coach Exterior

compartment door is open will illuminate on the dashboard.

This compartment is closed off from the engine compartment and is used to house the batteries and electrical components. The following items are located in the main power compartment:

- (4x) 12-volt batteries
- Main circuit breakers (12 & 24 volts)
- Battery charger (optional)
- Vanner battery equalizer
- Rear multiplex modules
- Transmission Electronic Control Module for Allison transmission or Volvo I-Shift
- Rear fuse box (VECR)
- Relays
- Electronic ground stud

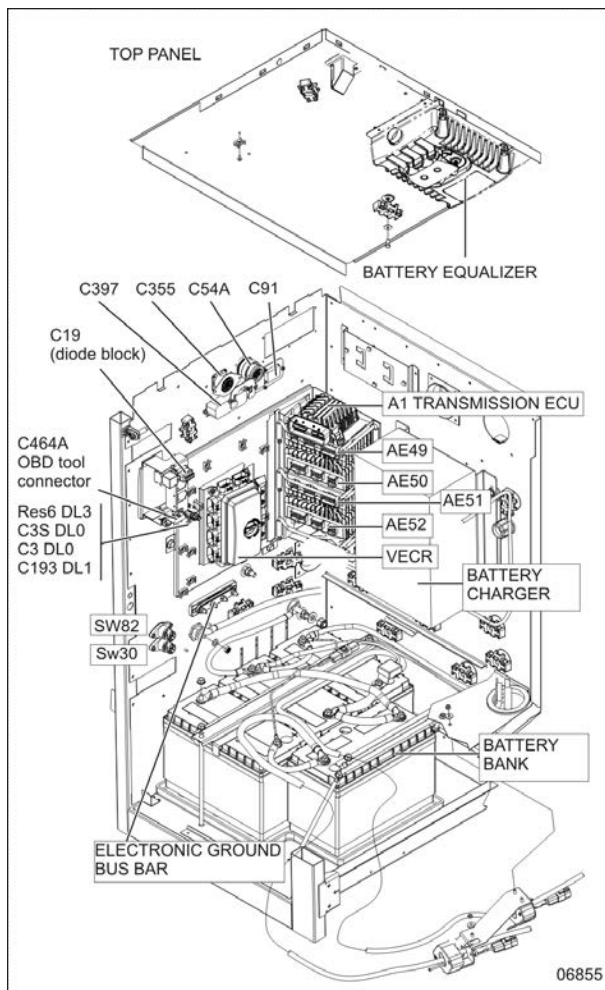

FIGURE 7: VIEW OF MAIN POWER COMPARTMENT (TYPICAL)

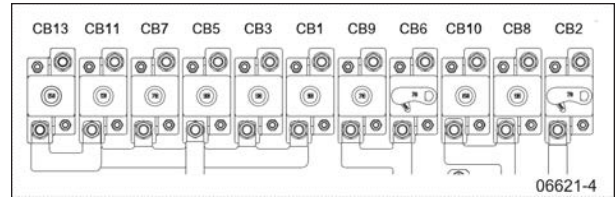
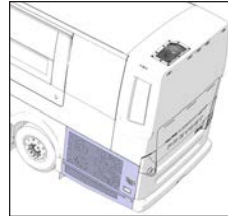

FIGURE 8: MAIN CIRCUIT BREAKERS 12 & 24 VOLTS (TYPICAL)

RADIATOR DOOR



Open the engine compartment rear door to access the engine radiator door release handle.

Open the engine radiator door by pulling on the latch release lever from inside the engine compartment left pillar.

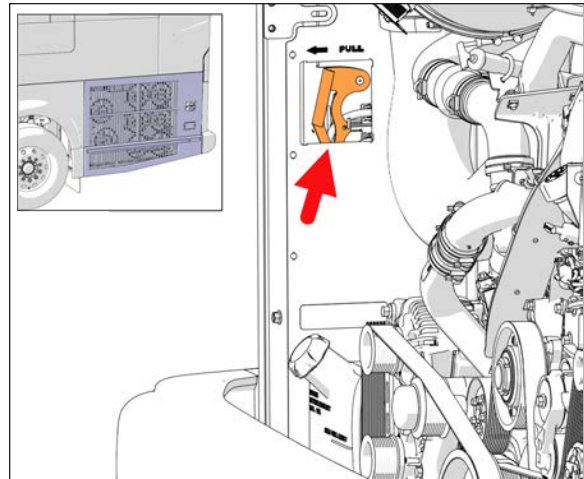

FIGURE 9: RADIATOR DOOR LATCH RELEASE LEVER LOCATION



WARNING

WHEN THE ENGINE IS RUNNING...

Cooling fans may activate at any moment.

Keep hands away from cooling fans or keep the radiator door closed

**WARNING**

Cooling fans may be running when the engine is shut down in the following conditions:

- If a High Exhaust Temperature condition exists (e.g. following regeneration). The CAC fans will keep running for a maximum of 15 minutes.
- During the electric Motor Test Sequence, the cooling fans will start running briefly.

SCR CONVERTER ACCESS HATCH

This hatch is located above the radiator door.

To gain access to the SCR catalytic converter:

1. Open the radiator door first;
2. Pull the catch connecting rod to unlock the access hatch;
3. Lift the hatch open;
4. Hold the door open by inserting the support rod free end into the receptacle.

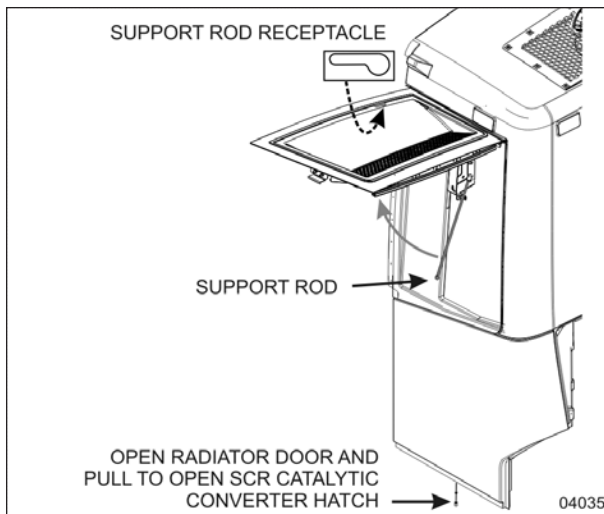

FIGURE 10: ACCESS TO THE SCR H3 SERIES

**WARNING**

After inserting the support rod into the receptacle, make sure the rod supports the door securely from falling down on to your head or body.

**WARNING**

External and internal temperatures remain hot long after the engine has been shut down. Allow the Exhaust Aftertreatment System to cool before handling. Wear protective clothing and gloves while servicing.

A/C CONDENSER COMPARTMENT

FIGURE 11: A/C CONDENSER COMPARTMENT

To open the condenser compartment door:

1. Open the fuel filler door first;
2. Move the latch bolt pin to the right as shown (step 1 on image);
3. Rotate the latch handle as shown (step 2);
4. Open the door on the right side when facing it.

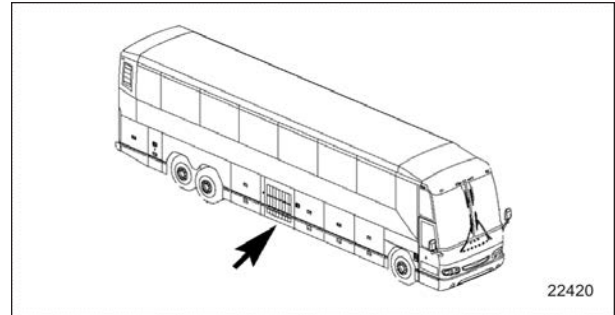
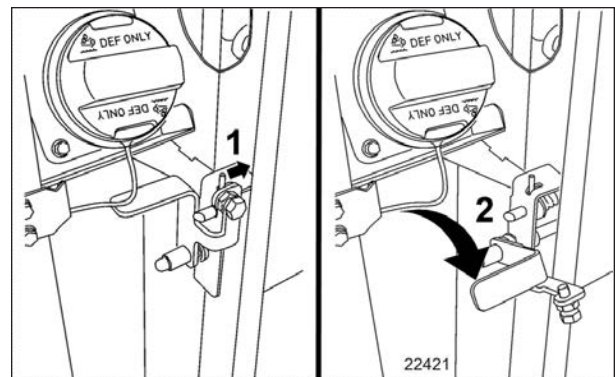

FIGURE 12: A/C CONDENSER COMPARTMENT DOOR OPENING

2-10 Coach Exterior

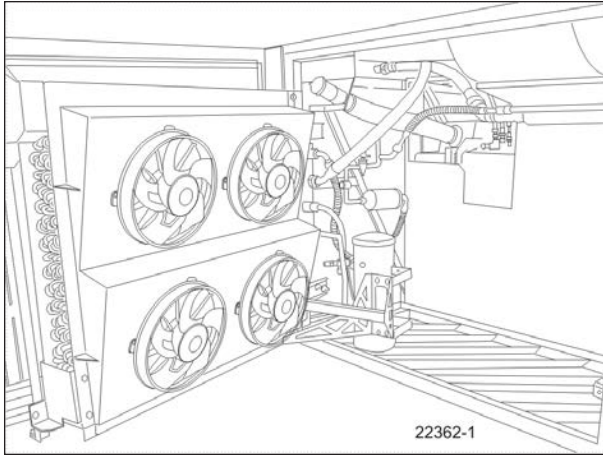

FIGURE 13: CONDENSER COMPARTMENT

EVAPORATOR COMPARTMENT

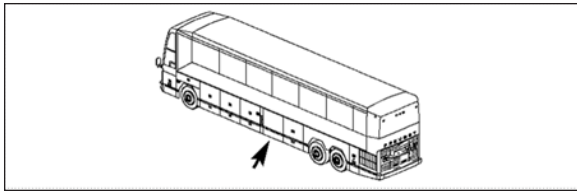

FIGURE 14: EVAPORATOR COMPARTMENT

To access the evaporator compartment, pull the release latch located on the left side wall of the rearmost baggage compartment.

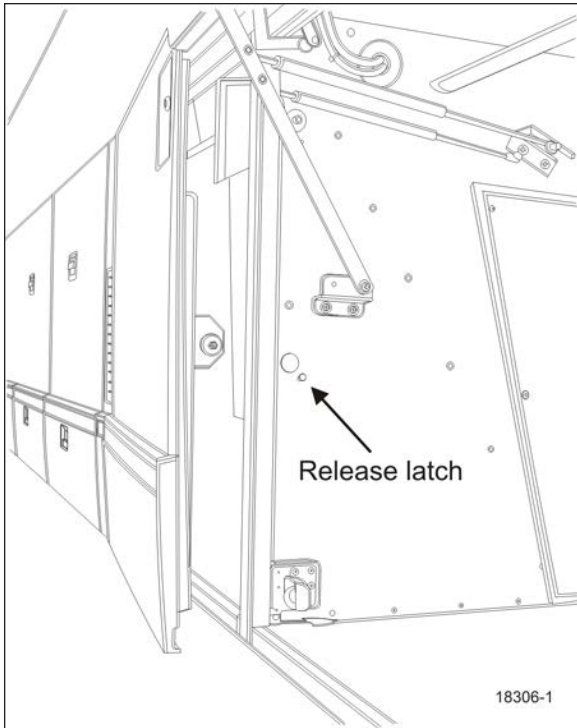

FIGURE 15: EVAPORATOR COMPARTMENT ACCESS

The evaporator compartment contains relays, diodes and a multiplex electronic module mounted on a panel located on the R.H. side wall when facing the compartment.

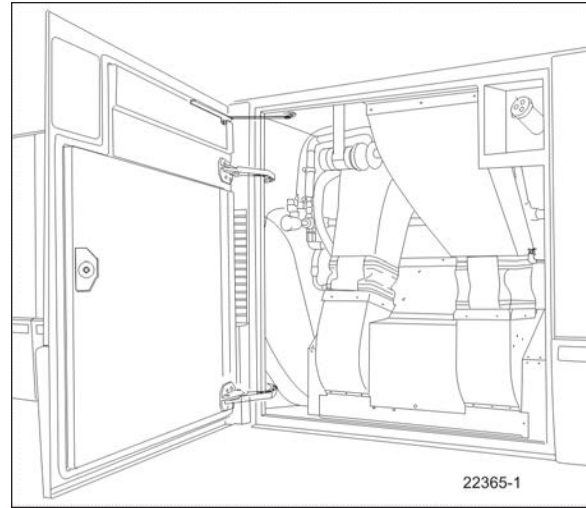

FIGURE 16: EVAPORATOR COMPARTMENT

NOTE

It is important to keep the evaporator compartment door closed while checking the HVAC system to prevent faulty readings.

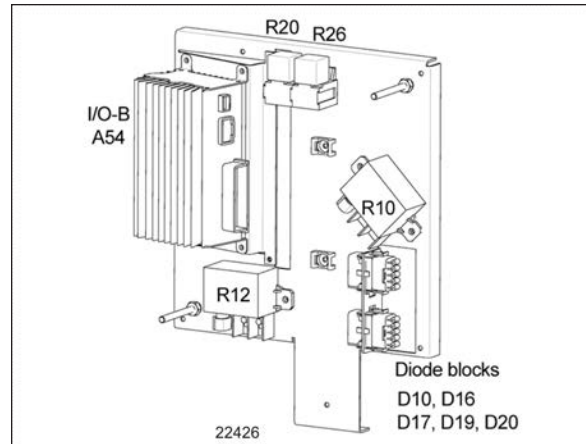
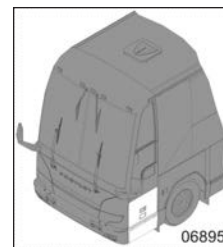

FIGURE 17: HVAC COMPONENTS PANEL

FRONT ELECTRICAL AND SERVICE COMPARTMENT



Unlock this compartment door using the exterior compartment key. The light in the front service compartment turns on automatically when the door is open.

The front electrical and service compartment provides access to the following:

- Front fuse box (VECF) & spare fuses
- ABS module
- VECU
- Front multiplex modules I/O-A, I/O-B
- Relays & resistors
- Kneeling audible alarm
- Emergency door opening unlock valve
- Windshield washer reservoir
- Headlights washer reservoir
- Reclining bumper opening handle
- Accessories air tank purge valve
- Accessories air tank fill valve
- MCM module
- Electronic ground stud
- Tire Pressure Monitoring System module
- Keyless module

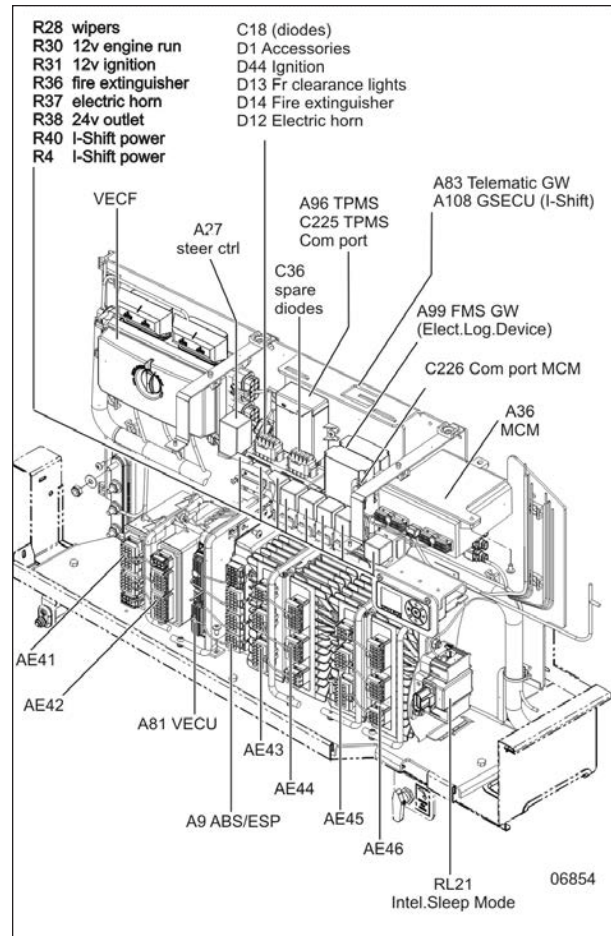

FIGURE 18: FRONT ELECTRICAL COMPARTMENT

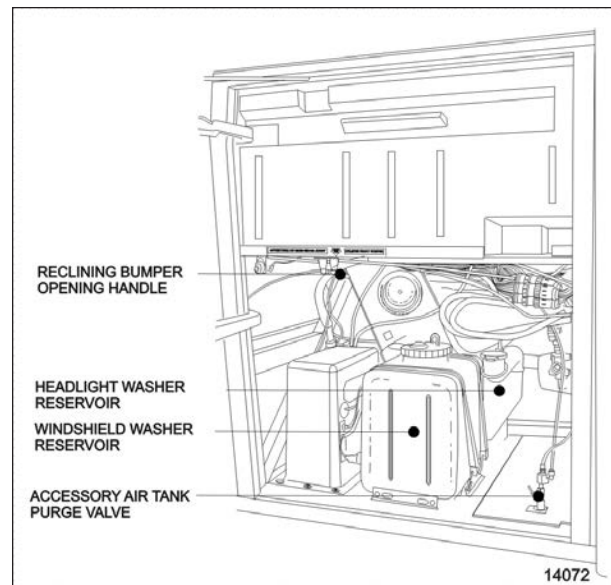

FIGURE 19: FRONT ELECTRICAL & SERVICE COMPARTMENT

2-12 Coach Exterior

BAGGAGE COMPARTMENTS

The baggage compartment doors can be locked and unlocked using the exterior compartment key. Lift up the cover to gain access to the lock. Pull up door handle to release the latch and then pull the door open. Pressurized cylinders assist the opening and closing of the baggage compartment doors and hold the doors open.

The lighting in the baggage compartments turns on automatically when the door is opened if the ignition key is set to ON or ACC.



WARNING

To avoid injury, keep hands clear of door edge and door frame when closing

NOTE

To prevent theft and vandalism, always lock all doors before leaving the vehicle unattended.

NOTE

The baggage compartment doors can also be locked and unlocked using:

- *The baggage compartments central locking system switch on the L.H. dashboard (refer to Controls and Instruments chapter).*
- *The keyless entry system.*
- *The remote entry transmitter (refer to Controls and Instruments chapter).*

NOTE

To prevent the door from closing in case of defective cylinders, lock the door in open position by pushing it further towards the body of the vehicle, until it locks in place.

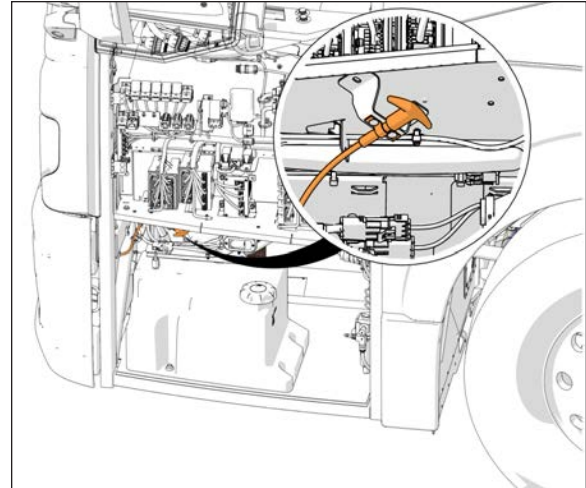

FIGURE 20: RECLINING BUMPER RELEASE HANDLE



WARNING

The compartment behind the bumper is not designed for miscellaneous storage. Never store loose objects in this compartment since they can interfere with the steering linkage mechanism.



WARNING

Although a powerful spring assists in reclining the bumper, it remains heavy and rests low when open. Caution should be used when reclining.

FUEL AND DIESEL EXHAUST FLUID (DEF) FILLER NECK ACCESS

These access doors must be opened with the exterior compartment key. To open, turn the key $\frac{1}{4}$ turn clockwise. Hold the door with your hand as you open the door. Open the street side filler neck access door to gain access to the DEF filler neck.

RECLINING BUMPER COMPARTMENT

The front bumper can be tilted downward to give access to the bumper compartment. Pull the release handle located inside the front service compartment to unlock. Tilt down the entire bumper assembly to access the compartment. Push the bumper back up firmly in place to lock in position.

Check that bumper is securely closed before driving.

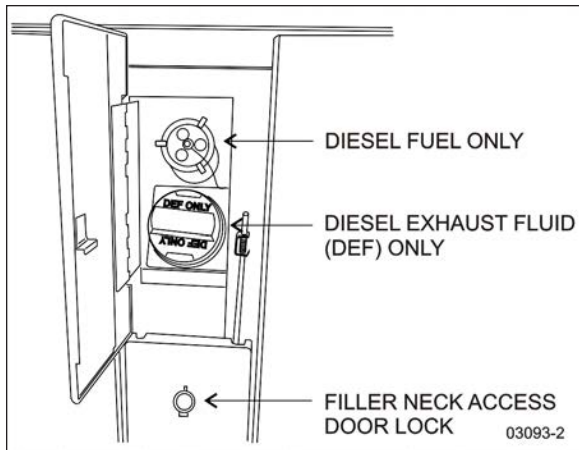

FIGURE 21: STREET SIDE FUEL AND DEF FILLER NECK ACCESS

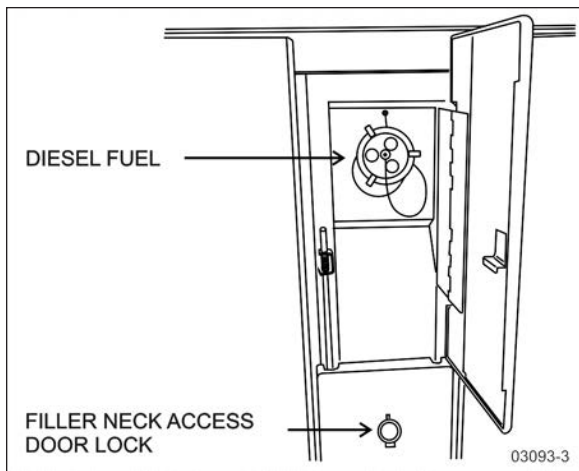

FIGURE 22: CURBSIDE FUEL FILLER NECK ACCESS

NOTE

Provided the vehicle is parked on level ground, an automatic nozzle will automatically shut off when tank is approximately 95% full.



CAUTION

Do not fill to more than 95% of the tank capacity. Do not "top off" the tank, doing so may result in fuel spillage when the fuel expands.



CAUTION

DEF – Do not overfill

If an automatic nozzle is used for filling diesel exhaust fluid (DEF), do not add further DEF after the nozzle has automatically shut off flow a first time.

If such nozzle is not available, use the DEF level gage on the instrument panel to control the quantity during filling.

Diesel exhaust fluid DEF will begin to crystallize and freeze at 12°F (-11°C) and expand by 7% when frozen. To allow expansion without damaging the DEF tank, do not fill the tank with more than 16 gallons (60 liters).

During vehicle operations, the SCR system is designed to provide heating for the DEF tank and supply lines. If DEF freezes when the vehicle is shut down, start up and normal operation of the vehicle will not be inhibited. The SCR heating system is designed to quickly return the DEF to liquid form and the operation of the vehicle will not be impacted.

ENTRANCE DOOR

OUTDOOR OPERATION

Lock or unlock the entrance door from outside the vehicle by either turning the key in the door lock (counterclockwise to lock, clockwise to unlock), by using the outside keyless entry pad or by using the remote entry transmitter. Open the door by pulling on the lever. Close by pushing the door shut.

2-14 Coach Exterior

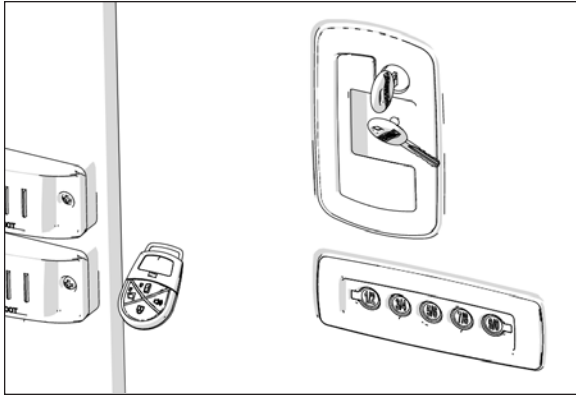

FIGURE 23: OUTSIDE LOCKING DEVICES

NOTE

The stepwell lights and entrance overhead light turn on as the door opens.

INSIDE OPERATION

There are two ways of unlocking the entrance door from the inside. The first consists in actuating the rocker switch on the R.H. dashboard panel. This operation will also operate the baggage compartment locking devices.

It is also possible to unlock the entrance door by sliding its lock lever to the left.

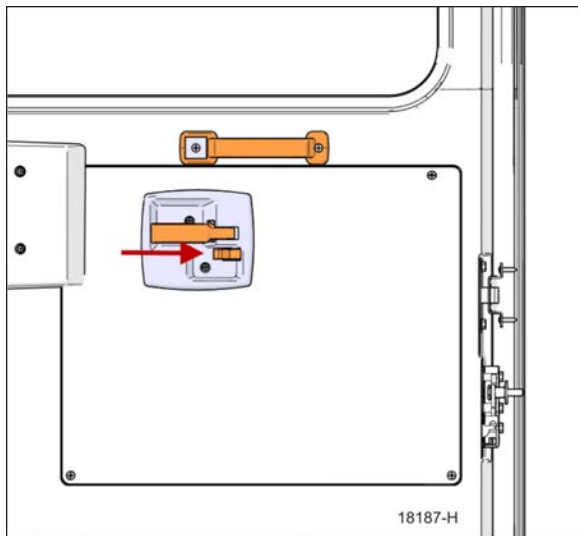

FIGURE 24: INSIDE LOCKING DEVICES

NOTE

If the alarm system is armed, unlocking the entrance door from the inside by sliding its lock knob will not disarm the alarm system. The alarm will sound.

NOTE

For complete information regarding the Keyless Entry System & Anti-theft Alarm System, refer to the document included in your vehicle's "publication box".

KEYLESS ENTRY SYSTEM

This system, located below the entrance door handle, is used to lock or unlock the entrance door, the baggage compartment and the service compartment. A default 4-digit access code is permanently preprogrammed in the module by the manufacturer. A 6-digit authority code will also be supplied to the owner and will be used to store up to 40 new personal access codes (4-digit).

NOTE

Refer to "Other Features" chapter for complete keyless system operating instructions.

REAR-VIEW MIRRORS

The vehicle is equipped with flat-type and convex-type rear-view mirrors. Convex mirrors give a wide-angle view. Objects viewed in convex-type rear-view mirrors appear smaller and are actually closer than they appear.

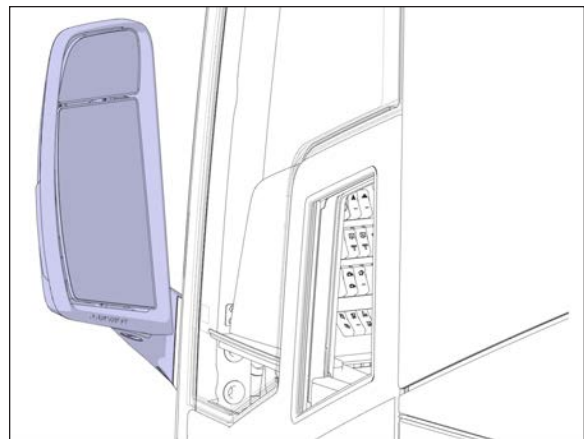

FIGURE 25: EXTERIOR REAR-VIEW MIRROR

To provide good visibility in cold weather, the mirrors can be equipped with heating elements. The elements are activated by a rocker switch located on the dashboard. Refer to "Controls & Instruments" chapter. Thermostats are used to prevent continuous operation of the heating elements.

**CAUTION**

Do not attach stick-on type convex mirror accessories to the heated mirror glass. This could impede uniform heat distribution on the mirror surface and could break the mirror glass.

As an option, the mirrors may be equipped with LED turning signal lights to give an additional signal light when turning or changing lane for extra safety or for other drivers to see your signal when driving too close, in rain, fog or when in blind spot.

The mirrors are adjusted using the controls located on the lateral control panel. Refer to "Controls & Instruments" chapter.

Adjust the side-view mirrors until the side of the vehicle is visible. Adjust the flat-type mirror until the road behind is in full view.

SIDE CAMERA REAR VIEW SYSTEM

The vehicle may be equipped with optional video camera mirror system. To provide good visibility in cold weather, the camera lens shield is equipped with heating elements. The heating elements are activated by a rocker switch located on the dashboard. Refer to "Controls & Instruments" chapter.

**CAUTION**

To avoid damage to the heating system, the heating elements shall not be permanently activated.

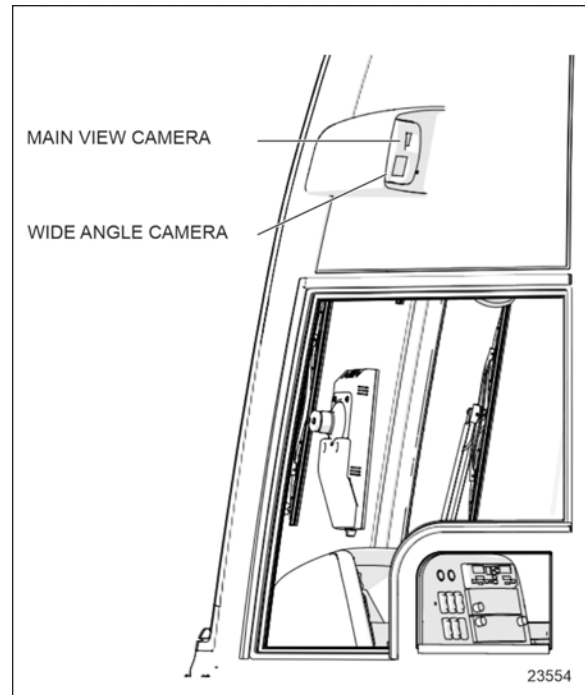

FIGURE 26: L.H. SIDE CAMERA

BACK-UP CAMERA

An optional back-up camera is available which provides the driver with visual assistance when backing-up. The back-up camera is mounted in a housing with a retractable cover. For additional information, refer to Controls and Instruments and Care and maintenance chapters.

NOTE

A switch located in the rear electric compartment is used to retract the back-up camera cover for cleaning or maintenance.

**CAUTION**

Never try to rotate by hand the retractable cover. Damage may occur.

120-VOLT CONNECTORS**ENGINE BLOCK HEATER**

This connector is used with a 120 volts supply and is connected to the optional engine block heater. Refer to Starting and Stopping Procedures chapter.

2-16 Coach Exterior

TRAILER HITCH

Your vehicle may be equipped with a factory-installed trailer hitch which has been designed to meet the following rating:

Maximum gross trailer weight:

20,000 lbs. (9072 kg)

Maximum tongue weight at 6 1/2 inches (165 mm) or less from coupling receiver:

1,500 lbs. (680 kg)

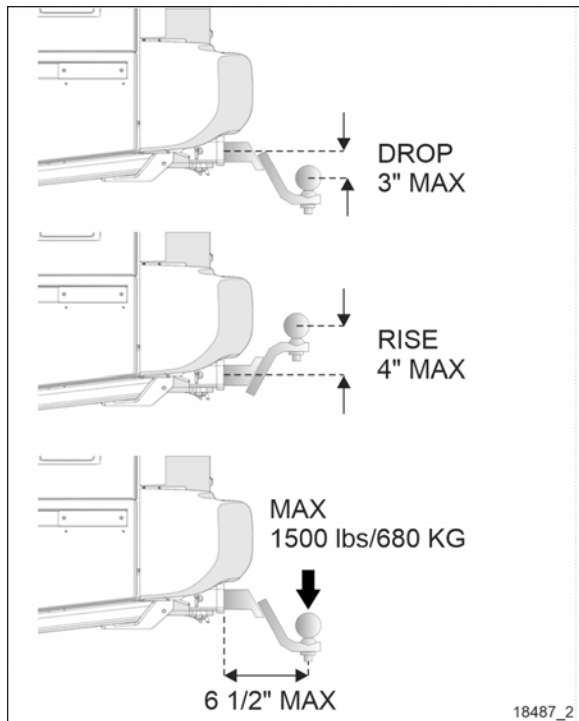

FIGURE 27: TRAILER HITCH

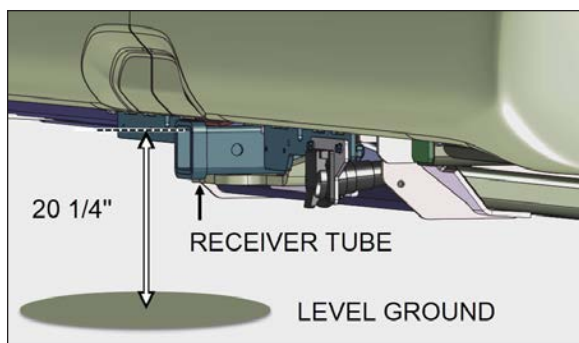

FIGURE 28: TRAILER HITCH



DANGER

The draw bar and the ball used for towing the trailer should be rated for 20,000 lbs. capacity or more.



WARNING

Pulling a trailer weighing more than the recommended *maximum gross weight* may cause engine and transmission overheating, and a possible hitch failure.

NOTE

Pulling a trailer over long distances is considered as a "severe operating condition" for the vehicle. The engine will require more frequent servicing.

TRAILER HITCH LOAD

The minimum requirement for a trailer weighing up to 20,000 lbs. when coupled to a 20,000 lbs. Prevost Trailer Hitch is as per the following:

1. Trailer must comply with **Federal Motor Carrier Safety Regulations 393.52** regarding trailer braking capability.
2. The trailer coupling attachments must meet the following minimum static test load requirements. Use the indicated Gross Trailer Weight Rating (GTWR) of your trailer and multiply by the indicated value below.
 - Longitudinal tension and compression: (1.5 x GTWR)
 - Transverse thrust: (0.5 x GTWR)
 - Vertical tension and compression: (0.5 x GTWR)

Loads indicated must be applied without incurring loss of attachments or distortion or failure which could affect the safe towing of trailer.

3. The ball and trailer coupling must meet the following minimum test load requirements without incurring failure. Use the indicated Gross Weight Rating (GTWR) of your trailer and multiply by the indicated value below.
 - Longitudinal tension and compression: (GTWR x 3)
 - Transverse thrust: (GTWR x 1)
 - Vertical tension and compression: (GTWR x 1.3)

In this case, failure is identified as the point at which the coupling or ball will accept no additional

test load without separation of the ball from the coupling ball socket, or the occurrence of a metal fracture of either coupling ball or coupling assembly, which results in separation of the ball from the coupling ball socket.

4. Two lengths of safety chain shall be used. The strength rating (minimum breaking force) of each individual chain and its connecting means shall be equal to, or exceed the trailer's Gross Weight Rating (GTWR).
5. Towing vehicle must be equipped with engine or transmission retarder. The engine or the transmission retarder on the vehicle must be functional at all time (to be inspected frequently).

SECTION 3 - COACH INTERIOR

DRIVER'S "DELIVERY" SEAT	2
DRIVER AND NAVIGATOR SEAT (ISRI)	2
PNEUMATIC ISRI SEAT	2
ELECTRICAL ISRI SEAT	2
DRIVER SEAT BELT	3
STEERING WHEEL ADJUSTMENT	4
DRIVER'S AREA SUNSHADES	4
INSIDE MIRROR	4
ADJUSTABLE HVAC REGISTERS	4
WINDOWS	5
DRIVER'S POWER WINDOW	5
FIXED WINDOWS	5
AWNING WINDOWS	5
SLIDING WINDOWS	6

3-2 Coach Interior

DRIVER'S "DELIVERY" SEAT

The driver's "delivery" seat is standard and legal only for driving the vehicle on its initial delivery. It is a conventional van seat equipped with tracks for fore and aft adjustments.



FIGURE 1: DRIVER'S DELIVERY SEAT

DRIVER AND NAVIGATOR SEAT (ISRI)

Two distinct ISRI model driver's and navigator's seats may be supplied with your vehicle: both with a sophisticated air suspension system, one being pneumatically operated, while the other is electrically operated. Both seats may be equipped with lumbar supports, heated cushions and adjustable armrests. Seats can be adjusted to the desired driving position by following the instructions listed below:

PNEUMATIC ISRI SEAT

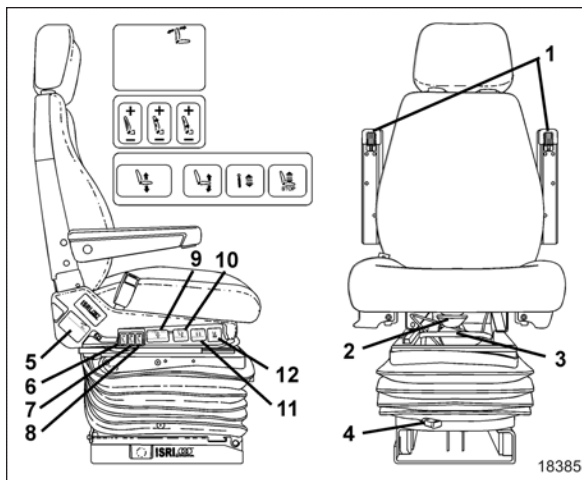

FIGURE 2: PNEUMATIC DRIVER'S SEAT

(1) Armrest

Rotate control knob to select desired arm-resting angle. When not in use, raise armrest parallel with backrest.

(2) Seat Cushion

Provides optimum comfort and support for any driver size. Adjustable to 50 mm (2 inch) length.

(3) Fore-and-aft

Pull handle up and slide seat forwards or backwards to adjust distance between seat and dashboard.

(4) Isolator

Reduces horizontal vibration, ensuring smooth ride.

(5) Backrest

Lift lever to select proper angle of backrest.

(6) Air Side Bolster

Offers desired side support to avoid body side-way.

(7) (8) Air Lumbar

Provides back support with upper and lower settings, ensuring comfort during lengthy sitting.

(9) Air Height Adjustment

Moves seat up or down independently of other seat settings. 100 mm (4 inch) total travel.

(10) Adjustable Seat Recline

Allows easy adjustment of four-setting inclination.

(11) Adjustable Shock Absorber

Choose stiff or soft ride infinitely.

(12) Quick Air Release

Exhausts all air from suspension, allowing for easy entry/exit. Returns seat to previous position.

ELECTRICAL ISRI SEAT

Adjust electric seats as follows:

Tilt (rear) (1)

Pull switch up to raise rear section of seat. Push switch down to lower rear section of seat.

Fore-and-aft/Up-Down (2)

Push switch towards dashboard to move seat forwards or back to move seat backwards. Pull switch up to raise seat or push switch down to lower seat

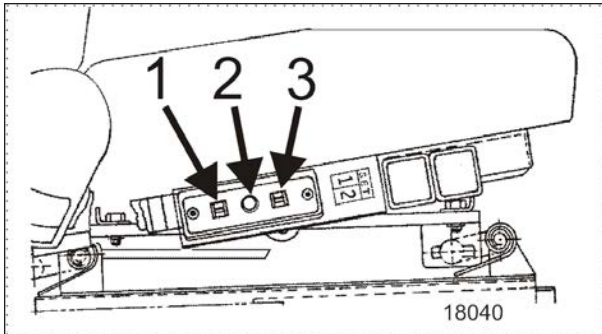

FIGURE 3: SEAT CONTROLS

Tilt (front) (3)

Pull switch up to raise front section of seat. Push switch down to lower front section of seat.

DRIVER SEAT BELT

The driver's seat is equipped with a retractable safety belt as required by State, Provincial and Federal regulations.

**WARNING**

A snug fit with the lap belt positioned low on the hips is necessary to maximize driver safety. The belt should not be worn twisted. Avoid pinching belt and/or belt hardware in seat mechanism. Do not wear belt over rigid or breakable objects, such as eyeglasses, pens or keys as these may cause injuries.

**CAUTION**

Never bleach or dry clean safety belt.

To fasten, pull seat belt out of the retractor and insert the latch plate into the buckle until it clicks. No special adjustment is required since the reel device is self-adjusting. If seat belt operation becomes defective, report to a Prevoist Car service center immediately.

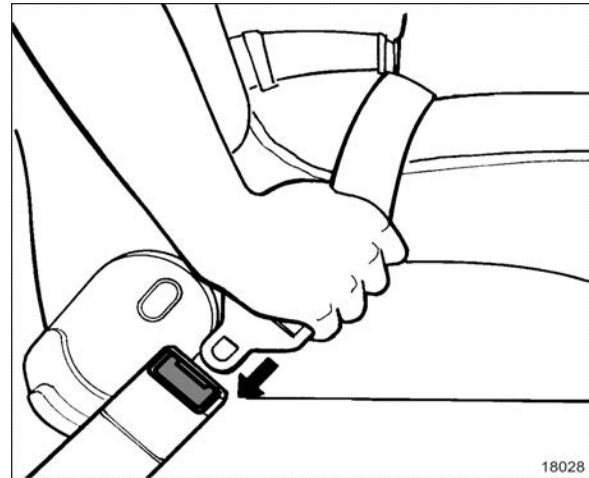

FIGURE 4: TO FASTEN SEATBELT

To unfasten belt, press the red button in center of buckle and allow belt to retract. If the belt does not fully retract, pull it out and check for kinks or twists. Make sure that it remains untwisted as it retracts.

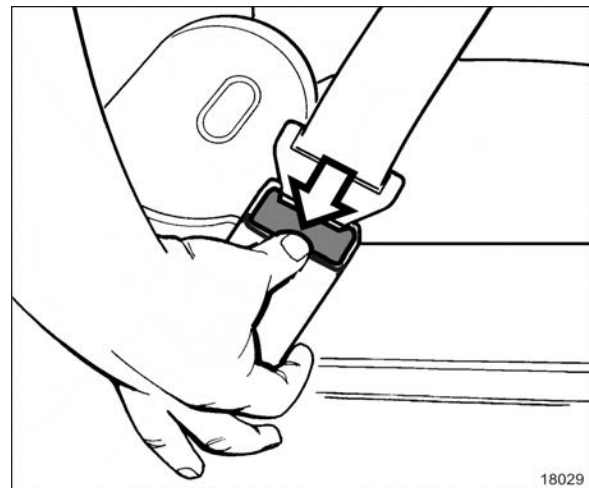

FIGURE 5: TO UNFASTEN SEATBELT

**WARNING**

Most State and Provincial laws require that safety belts be worn when they are supplied with the seat.

NOTE

The safety belt must be pulled out slowly and continuously, otherwise it will lock the reel before the latch plate reaches the buckle. If this happens, allow the belt to retract completely and repeat the procedure correctly.

3-4 Coach Interior

STEERING WHEEL ADJUSTMENT

Push on the valve button located in the foot-operated control housing to unlock the steering wheel for tilt and telescopic adjustment (refer to ["FOOT-OPERATED CONTROLS" on page 6](#) in Controls and Instruments chapter).

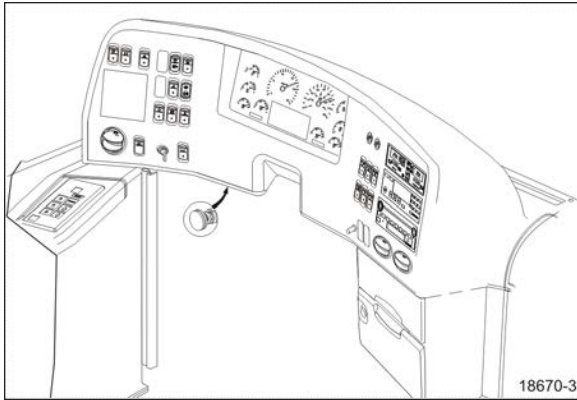

FIGURE 6: TILT AND TELESCOPIC ADJUSTMENT



DANGER

Do not adjust the steering wheel while driving. Loss of control could result. Park the vehicle safely and apply parking brakes before adjusting the steering wheel.

DRIVER'S AREA SUNSHADES

This vehicle is provided with a sunshade on the driver's left side window. To operate, pull down the sunshade by its knob to the appropriate position and release. It will remain in position. To raise, pull up the sunshade by its knob.

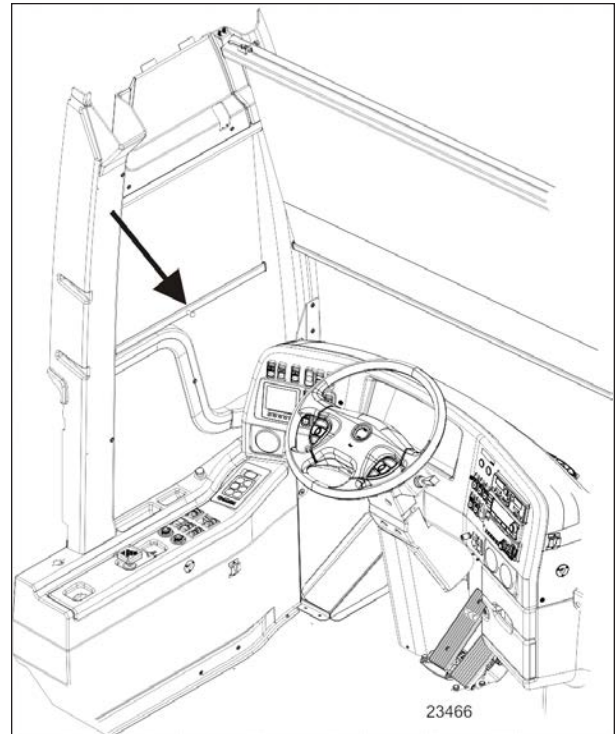

FIGURE 7: DRIVER'S WINDOW SUNSHADE

Two electrically-operated sunshades are installed behind the windshields. Two rocker switches on the dashboard operate each shade individually. Refer to "Controls and Instruments" chapter for more information.



CAUTION

The electric shades should only be operated electrically. Pulling down manually may damage the mechanism.

INSIDE MIRROR

One (optional) mirror is located in the driver's area. The central mirror allows the driver to see in the central cabin aisle.

ADJUSTABLE HVAC REGISTERS

The HVAC system has adjustable registers to control air flow around the driver.

- Three are located on the dashboard, two on the R.H. side and one on the left (refer to Controls and Instruments chapter).
- Two more registers are located near the steering wheel column, under the

dashboard. These registers are not adjustable but may be electrically open or closed by means of the HVAC control panel.

- Three auxiliary unit registers are located behind the driver (with small HVAC system only).

Use the HVAC control panel to set air temperature (refer to "[HVAC CONTROL UNIT](#)" on [page 1](#) in Controls & Instruments chapter).

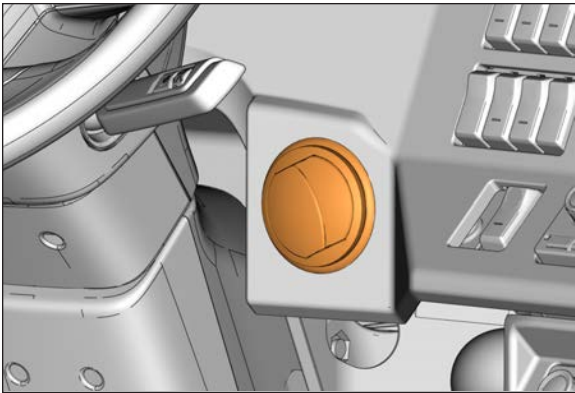

FIGURE 8: DASHBOARD AIR REGISTER

WINDOWS

The vehicle is equipped with single pane or double pane (thermos) windows. There is either one or two power windows and a possible combination of three types of side windows, all of them flush-mounted to the structure: fixed, awning and sliding windows. Following is a description and operating instructions for these types of windows:

DRIVER'S POWER WINDOW

The driver has a power window on the left side of the vehicle. The windows are controlled by a rocker switch located on the driver's control panel. Refer to "Controls and Instruments".

FIXED WINDOWS

These windows are glued to the structure and form an integral part of the body of the vehicle, helping reduce vibration and noise. Fixed windows cannot be opened.

AWNING WINDOWS

To open or close an electrically-operated awning window, use the rocker switch located on the wall, next to the window. After closing the window, maintain the rocker switch depressed to latch the window.



CAUTION

Avoid holding the rocker switch button depressed after the window has reached its full opened position or after the window has been latched.



CAUTION

Never try to open or close the awning window by pulling or pushing directly on the window; this could damage the opening mechanism gearbox.

A telltale light on the dashboard illuminates when an awning window is opened. Refer to Controls and instruments chapter for more information.

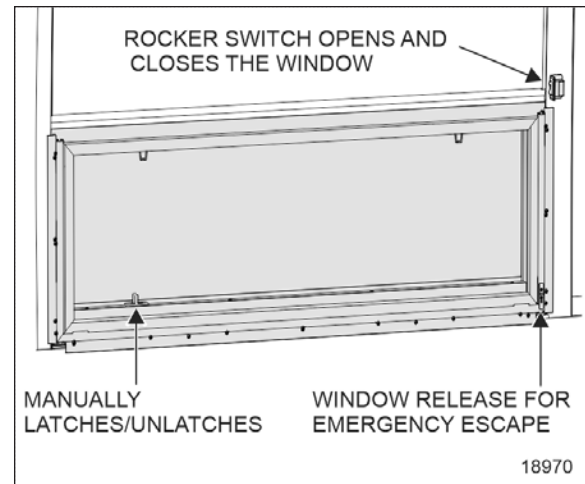

FIGURE 9: ELECTRIC AWNING WINDOW

NOTE

The awning window electrical circuit is equipped with a thermistor protecting the components from overheating. If the awning window is opened and closed repeatedly, causing overheating of the components, the thermal protection will interrupt the operation of the window for a short while to permit cooling down of the components. This feature also prevents personal injuries and damages to the components if something obstructs the window movement.

3-6 Coach Interior

SLIDING WINDOWS

To open or close an electrically-operated sliding window, use the rocker switch button located on the wall, next to the window.



CAUTION

Never try to open or close the sliding window by pulling or pushing directly on the window; this could damage the opening mechanism gearbox.

NOTE

If the sliding window electrical circuit is inoperative, the power sliding window can be manually closed by removing the lateral plastic trim located on the R. H. side of the window to access the drive belt. Manually move the drive belt to close the window.

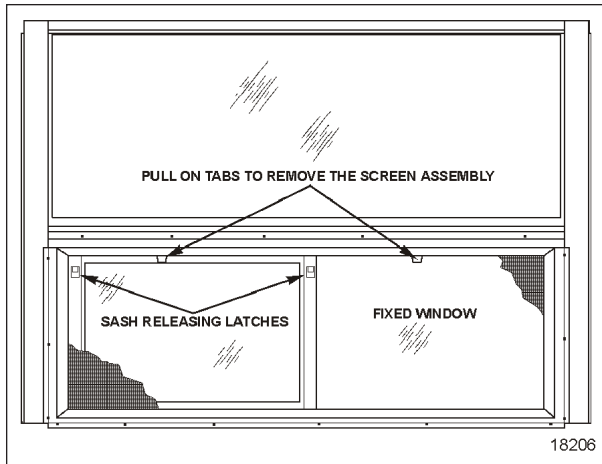

FIGURE 10: SLIDING WINDOW

NOTE

The sliding window electrical circuit is equipped with a thermistor protecting the components from overheating. If the sliding window is opened and closed repeatedly, causing overheating of the components, the thermal protection will interrupt the operation of the window for a short while to permit cooling down of the components. This feature also prevents personal injuries and damages to the components if something obstructs the window movement.

SECTION 4 - CONTROLS AND INSTRUMENTS

DRIVER'S AREA OVERVIEW	3
KEYS	4
REMOTE ENTRY TRANSMITTER	4
ENTRANCE DOOR KEY	4
EXTERIOR COMPARTMENT KEY	4
UTILITY COMPARTMENT KEY	4
FUEL FILLER DOOR KEY (OPTION)	5
IGNITION SWITCH	5
ACCESSORIES	5
OFF	5
ON	5
START	6
FOOT-OPERATED CONTROLS	6
BRAKE PEDAL	6
ACCELERATOR PEDAL	6
STEERING WHEEL ADJUSTMENT	7
STEERING COLUMN CONTROLS	8
MULTI-FUNCTION LEVER	8
STEERING WHEEL CONTROLS	9
HORNS	11
TRANSMISSION RETARDER	11
LATERAL CONTROL PANEL	12
TRANSMISSION CONTROL PAD	12
CONTROL SWITCHES	12
MIRROR CONTROLS	13
LEVEL LOW SYSTEM	14
PARKING BRAKE CONTROL VALVE	15
TAG AXLE CONTROL VALVE	15
TRAILER AIR SUPPLY CONTROL VALVE (OPTION)	15
UTILITY COMPARTMENT & 12V POWER OUTLET	15
ASHTRAY	16
CIGAR LIGHTER	16
SIDE CAMERA REAR VIEW MONITORS	16
REFERENCE LINES	16
BRIGHTNESS ADJUSTMENT	17
MONITOR STATE	17

4-2 Controls and Instruments

DASHBOARD	19
CONTROL SWITCHES	20
HVAC CONTROL UNIT	24
AIR REGISTERS	25
INSTRUMENT PANEL	27
DRIVER INFORMATION LEVEL	28
ANALOG INDICATORS	29
TELLTALE LIGHTS	33
STOP, CHECK AND INFORMATION TELLTALE LIGHTS	37
DRIVER INFORMATION DISPLAY	37
PICTOGRAMS DISPLAYED ON THE DRIVER INFORMATION DISPLAY (DID)	40
ON BOARD DIAGNOSTIC TOOL RECEPTACLE	49
AUTOMATIC FIRE DETECTION AND SUPPRESSION SYSTEM (AFSS)	49
AUTOMATIC FIRE SUPPRESSION SYSTEM PANEL	49
CRUISE CONTROL	49
TURNING THE SYSTEM ON	50
SETTING A CRUISING SPEED	50
PREVOST DRIVER ASSIST™	52
ASSOCIATED HARDWARE/EQUIPMENT	52
PREVOST DRIVER ASSIST™ CONSISTS OF THE FOLLOWING SYSTEMS AND FEATURES	53
POTENTIALLY CHALLENGING SITUATIONS FOR THE PREVOST DRIVER ASSIST™ SYSTEM	55
LANE DEPARTURE WARNING LDW	55
FORWARD COLLISION MITIGATION FCM	58
ADAPTIVE CRUISE WITH BRAKING ACB	60
FOLLOWING DISTANCE ALERT (FDA)	63
FOLLOWING DISTANCE ALERT	64
IMPACT ALERT	64
BRAKE OVERUSE WARNING	65
WHAT TO EXPECT WHEN USING THE PREVOST DRIVER ASSIST™ SYSTEM	66
HOW YOUR ACTIONS IMPACT THE PREVOST DRIVER ASSIST™ SYSTEM	68
TIRE PRESSURE MONITORING SYSTEM (TPMS)	70
ON-SCREEN TPMS VERSION	70
SYSTEM MALFUNCTION	73
ALLISON TRANSMISSION	73
OPERATION	73
PUSHBUTTON SHIFT SELECTOR	73
PRIMARY AND SECONDARY SHIFT SCHEDULES	74
TRANSMISSION SERVICE INDICATOR	74
DESCRIPTION OF AVAILABLE RANGES	74
TOWING RECOMMENDATIONS	76

DRIVER'S AREA OVERVIEW

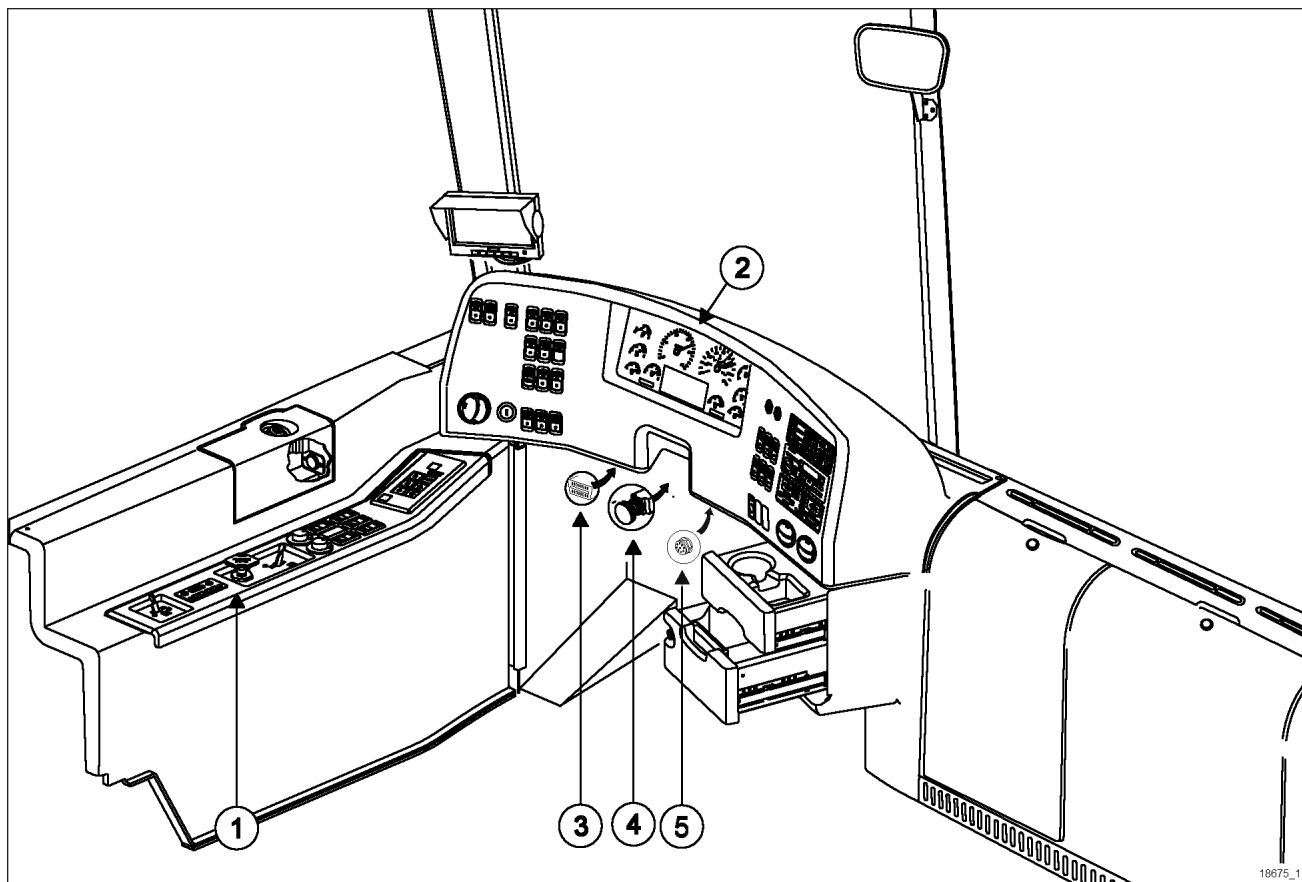

FIGURE 1: DRIVER'S AREA

1. Lateral control panel
2. Dashboard
3. Diagnostic tool receptacle (OBD)
4. Foot-operated steering wheel adjustment knob
5. Electronic logging Device Connection (ELD- for commercially operated vehicles only)

4-4 Controls and Instruments

KEYS

Four different keys and a set of remote entry transmitters are provided with the vehicle.

REMOTE ENTRY TRANSMITTER

Hand held transmitters (key FOB) can be used to control the keyless door lock system.



To lock the entrance door and the baggage compartment doors simultaneously and arm the intrusion protection and anti-theft system:

- Press LOCK (top) button on the transmitter once.

NOTE

The lock function will not function when the ignition is in the ON position or the entry door is open.

NOTE

The intrusion protection and anti-theft system will be set after a 10 seconds delay.

To unlock the entrance door:

- Press UNLOCK DOOR (bottom) button on the transmitter. This will unlock the door and disarm the anti-theft system.

To unlock the baggage compartment doors:

- Press UNLOCK BAGGAGE (right) button. This will not disarm the alarm.

To set off the personal security alarm (Panic mode):

- Press and hold the red (left) PANIC button for two seconds. The horn will sound and the marker lights will flash for 30 seconds.

To deactivate the personal security alarm:

- Press any FOB button again or unlock the entrance door using the keypad.

ENTRANCE DOOR KEY

Use the entrance door key to lock or unlock the door from the outside. It is also possible to lock or unlock the entrance door using the exterior compartment door lock, the entrance door unlocking switch or using the keyless entry system.

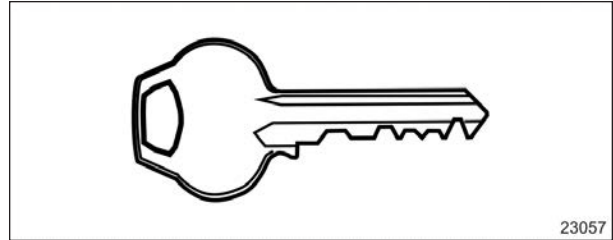

EXTERIOR COMPARTMENT KEY

Use this key to lock or unlock the baggage compartments doors, the electrical and service compartment doors and the fuel filler access doors.

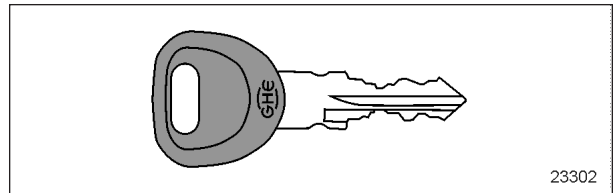

NOTE

It is also possible to lock/unlock the baggage compartment doors from the inside by means of the baggage compartment-locking system switch located on the lateral control panel.

UTILITY COMPARTMENT KEY

This key locks or unlocks the utility compartments and the utility drawers on and around the dashboard.

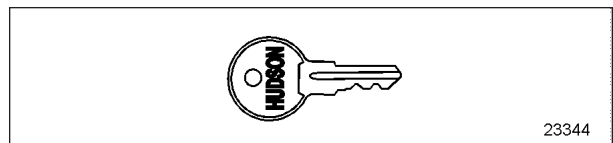

FUEL FILLER DOOR KEY (OPTION)

Use this key to lock or unlock the fuel filler door.

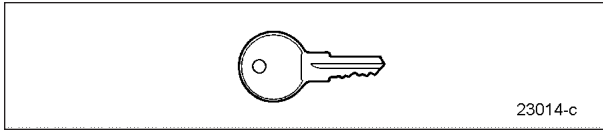

IGNITION SWITCH

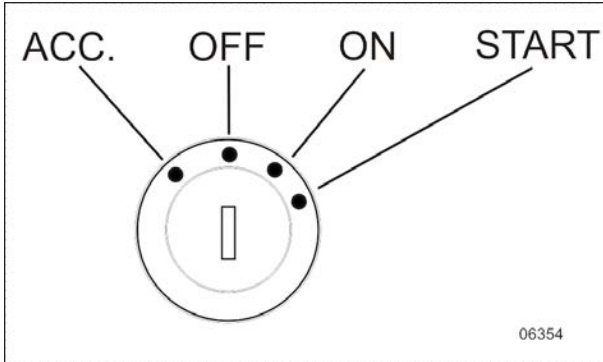

FIGURE 2: IGNITION SWITCH KEY POSITIONS

The ignition switch is located on the lower left side of the dashboard. With the battery master switch activated, turn the ignition key counterclockwise to the ACC position to activate the electrical circuits.

To start the engine, turn the key clockwise to the START position, and then release it. The key will set to ON position.

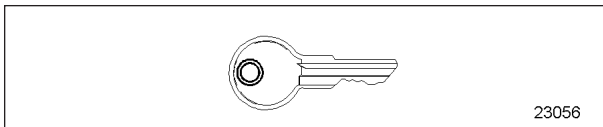

FIGURE 3: IGNITION KEY



CAUTION

When the vehicle is parked overnight or for an extended period of time, the battery master switch (ignition switch) should be set to the OFF position.

NOTE

When the battery master switch (ignition switch) is set to the OFF position, all electrical supply from the batteries is cut off, with the exception of battery equalizer check module, ECM ignition and power supply, Allison TCM or I-Shift transmission ECU, auxiliary coolant heater timer, coolant heater and water recirculating pump, power-verter, fire alarm and entrance door.

The ignition switch doubles as the battery master switch. Any position other than OFF activates the electrical circuits.

The ignition switch is located on the lower left side of the dashboard. It has four positions:

ACCESSORIES

To operate the accessories only, turn the ignition key counterclockwise to the ACC position.

The electrical circuits are activated when the switch is in this position. The features enabled when the switch is in the ACC position are all those linked directly to the battery such as the radio or entertainment system, exterior and interior lighting.

OFF

In the OFF position, ignition cannot take place. The key can be removed in this position.

The electrical circuits are not activated when the switch is in this position with the exception of the circuits of the accessories connected directly to the batteries and the “wake-up” systems which remains active for about 15 minutes after the ignition is set to the OFF position. Maintain the switch in this position when parked overnight or for an extended period.

ON

To place ignition switch to the ON position, turn the key clockwise to the first position.

The electrical circuits activated are the same than the ACC position, plus the transmission, engine and accessories, ABS system, wipers, level low system, dashboard cluster gauges and buzzers, air horn and air dryer heater are activated when

4-6 Controls and Instruments

the key is in this position. Do not leave the key in this position unless the engine is running.

START

Turn the key clockwise to the second position and release as soon as the engine starts. The key will return to the ON position. If the engine did not start, return the ignition key to the OFF position before trying to restart the engine.

The ignition switch is equipped with a starter protection which inhibits turning the key to the START position if the key has not previously been turned to the OFF position.



CAUTION

To avoid overheating the starter, do not engage the starter for more than 15 seconds at a time. Allow the starter to cool before trying to restart the engine.



DANGER

Do not use ether or other combustible starting aid fluid on any engine equipped with an intake air preheater. If the engine is equipped with a preheater, introduction of ether or similar starting aids could cause a fire or explosion resulting in severe property damage, serious personal injury or death.

FOOT-OPERATED CONTROLS

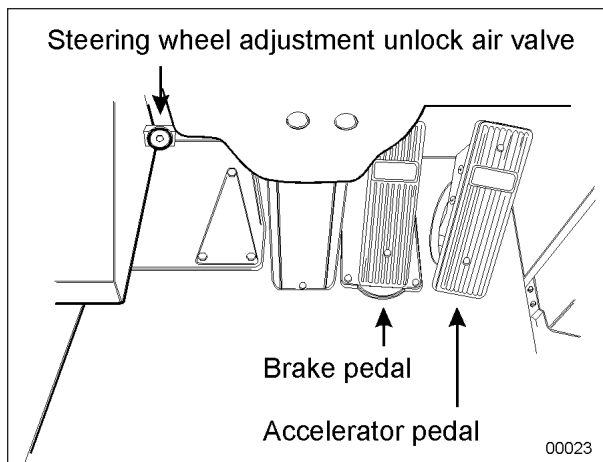

FIGURE 4: FOOT OPERATED CONTROLS

BRAKE PEDAL

The coach is equipped with a dual braking system. The front brakes operate from a different air source than the drive and tag axle brakes.

The dual braking system becomes a modulated emergency system if a pressure drop occurs in the primary brake system (rear brakes).

Service brakes are applied by depressing the brake pedal. Braking increases with the amount of pressure applied to the foot pedal. Refer to ["ANTILOCK BRAKING SYSTEM \(ABS\)" on page 27](#) in Section 5 Other Features. When the brake pedal is depressed, the brake lights turn on automatically.

For safe and effective braking, the air system pressure should reach at least 95 psi in both the primary and secondary circuits.

A warning light and an audible alert will sound when the air pressure in either the primary or secondary circuit drops below 85 psi. If this occurs, stop the coach; determine the cause of the pressure loss before proceeding. The brake pedal can be used in conjunction with the transmission retarder. Refer to ["TRANSMISSION RETARDER" on page 11](#) in this section.



DANGER

Immediately report any brake system problem to your company or directly to the nearest Prevost or Prevost-approved service center.

Do not "fan" or "pump" the brake pedal. This practice does not increase brake system effectiveness but rather reduces system air pressure thereby causing reduced braking effectiveness.



CAUTION

"Riding" the brake by resting one's foot on the brake pedal when not braking can cause abnormally high brake temperature, can damage and cause premature wear of brake components and reduce brake effectiveness.

ACCELERATOR PEDAL

Controls engine RPM as needed.

 **CAUTION**

Do not let the engine operate above 2,450 rpm.

STEERING WHEEL ADJUSTMENT

Push on the valve button with the left foot to unlock the steering wheel for tilt and telescopic adjustment.

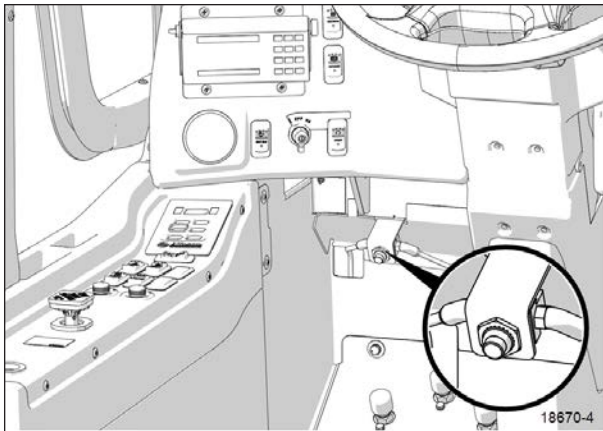

FIGURE 5: TILT AND TELESCOPIC ADJUSTMENT

 **WARNING**

Do not adjust the steering wheel while the vehicle is moving. Loss of control could result. Park the vehicle safely and apply parking brake before adjusting.

4-8 Controls and Instruments

STEERING COLUMN CONTROLS

Many of the most frequently used controls are conveniently placed on the steering column or the steering wheel, just like a passenger car. The multi-function lever is located on the left side of the steering wheel while the optional transmission retarder lever is located on the right side of the steering wheel. Switches for the electric horn and the air horn are located directly on the steering wheel.

MULTI-FUNCTION LEVER

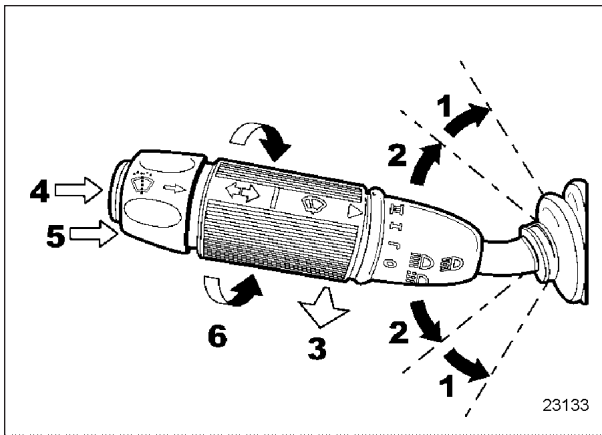

FIGURE 6: MULTI-FUNCTION LEVER

The multi-function lever is used to operate the following:

(1) Turn Signal

Move the lever all the way up until it locks in position to signal a right turn. Move the lever all the way down until it locks in position to signal a left turn. The lever automatically returns to the horizontal OFF position once the turn is completed.

(2) Lane Change Signal

Move the lever part way to the catch position and hold until the lane change maneuver is completed. The lever will spring back into the OFF position once released.

(3) Headlight Beam Toggle Switch

Toggle between high and low beams by pulling the lever up towards you. To flash the headlights, pull the lever up halfway. The lever will spring back into normal position once released.

(4) Courtesy Blinkers

Clearance and parking lights can be flashed by pressing the button located on the lever tip.

(5) Windshield Washer Control

Push the external ring at the end of the lever towards the steering column to activate the windshield washers. The wipers come On and continue wiping for a few seconds after the ring is released.

If equipped with the Video Camera Mirror System, activation of the windshield washers produces a jet of compressed air to clean the camera lens protectors.



WARNING

Before using the windshield washers in cold weather, heat the windshield with the defroster to prevent icing and reduced visibility.



CAUTION

To avoid damaging the pump mechanism, do not use the windshield washer when the fluid level is very low or empty.

(6) Windshield Wipers

Turn the lever counterclockwise to activate the windshield wipers. The first position activates the wipers intermittently. The second position is the slow speed and the third position is for high speed wiping.



CAUTION

To avoid scratching the windshield, do not operate the wipers when the windshield is dry. To avoid damaging the wiper motor, free wiper blades that may be frozen to the windshield before operating the wipers.

STEERING WHEEL CONTROLS

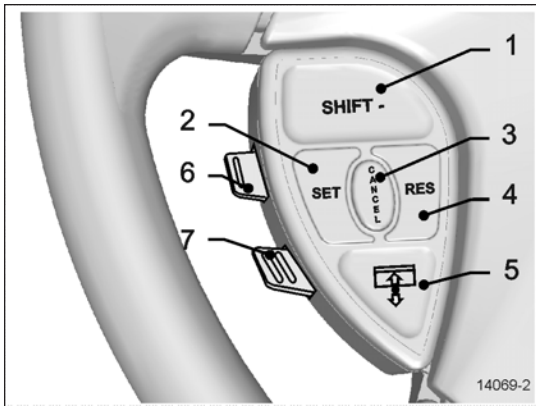

FIGURE 7: LEFT STEERING WHEEL CONTROLS

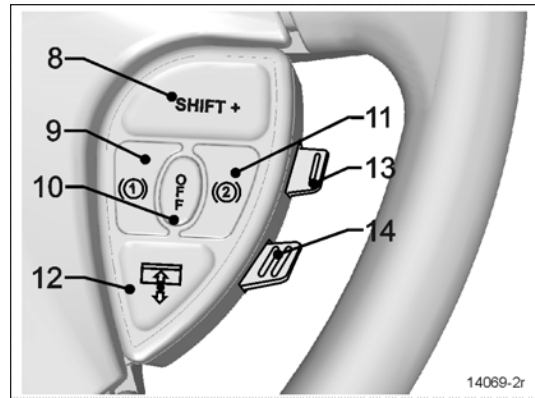

FIGURE 8: RIGHT STEERING WHEEL CONTROLS

THE STEERING WHEEL CONTROLS INCLUDE THE FOLLOWING FUNCTIONS:

1, 8 Shift Down, Shift Up (I-Shift Transmission Only)

Use these buttons to shift down or shift up manually the transmission range as would do the “-” & “+” keys on the I-Shift gear selector keypad.

2, 3, 4 Set, Cancel, Resume (Cruise Control)

For cruise control operating instructions, refer to ["CRUISE CONTROL" on page 49](#) in this section.

5, 12 Left Sunshade

Press and hold the button to lower the left sunshade. Press twice rapidly and hold the button to raise the left or right sunshade.

	<p>CAUTION</p>
<p>Do not attempt to raise or lower these shades manually. Damage to the electric motor or roller mechanism could result.</p>	

6 Escape/Enter (Driver Information Display)

Enter: Lift this button briefly.

Escape: Press briefly on this button.

7 Up/Down (Driver Information Display)

Use this button to scroll up or down through the menus.

9 Retarder / Engine Brake Low (1)

If the vehicle is equipped with a transmission retarder, press this button to enable the transmission retarder. Afterwards, operate the transmission retarder with the hand lever mounted on the steering wheel or the brake pedal. For more information about the operation of this system, refer to “transmission retarder” heading in this chapter.

On vehicles equipped with an engine brake, the engine brake provides two levels of braking power. Press this button for low engine braking power (about 50 % of full braking power). Refer to ["VOLVO ENGINE BRAKE \(VEB\)" on page 26](#) in Section 5 Other Features for more information about the engine brake operation and AUTO (A) mode.

4-10 Controls and Instruments

10 Retarder / Engine Brake Off

Press this button to cancel operation of the transmission retarder.

On vehicles equipped with engine brake, this button is a momentary switch that will cancel the Engine Brake LOW ① or Engine Brake HIGH ② mode and switch the engine brake to AUTO ③ mode. On vehicles so equipped, an engine brake switch located in the dashboard can be used to cancel completely (OFF mode) the engine brake.

NOTE

Engine brake is safe to use in any road conditions including adverse conditions.

11 Retarder / Engine Brake High ②

If your vehicle is equipped with a transmission retarder, this button has the same effect as the retarder/engine brake LOW ① button.

On vehicles equipped with engine brake, pressing this button will permit full application of the engine brake (100 % of braking power). Refer to "[VOLVO ENGINE BRAKE \(VEB\)](#)" on page 26 in Section 5 Other Features for more information concerning the engine brake operation and AUTO ③ mode.

12 Right Sunshade

Press and hold the button to lower the right sunshade. Press twice rapidly and hold the button to raise the left or right sunshade.



CAUTION

Do not attempt to raise or lower these shades manually. Damage to the electric motor or roller mechanism could result.

13 Volume (Dashboard Radio)

Use this button to increase or decrease the dashboard radio (driver's radio) volume.

14 Seek (Dashboard Radio)

Use this button to seek up or down for a radio station.

HORNS

The electric horn (city horn) and air horn (highway horn) are operated from the steering wheel center pad. Use the Horn Selector switch located on the lateral control panel to select the appropriate horn type.

NOTE

When the vehicle is stationary, the electric horn will sound to inform the driver that a fire is detected in the engine compartment.

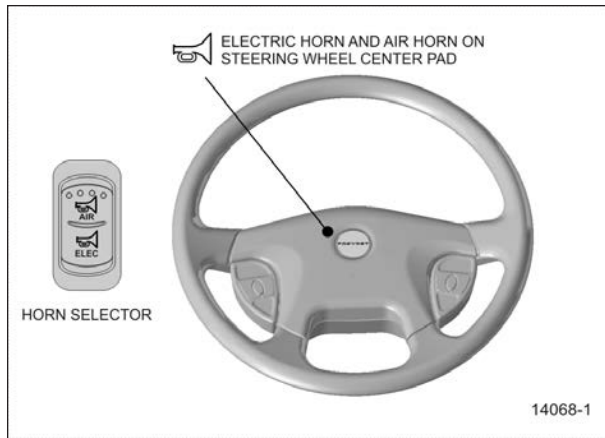

FIGURE 9: STEERING WHEEL

TRANSMISSION RETARDER

The transmission retarder is available only with the Allison transmission.

The retarder can be operated using a hand lever mounted on the steering wheel column or using the service brake pedal.

To use the transmission retarder, it must be activated first by pressing one of the two Retarder/Engine Brake buttons on the steering wheel.

Operating The Retarder Using The Hand Lever

With the retarder enabled and the accelerator pedal released, move the output retarder lever clockwise from the first to the sixth position. The braking effect occurs as soon as the accelerator pedal is released. The braking level for each position is as follows:

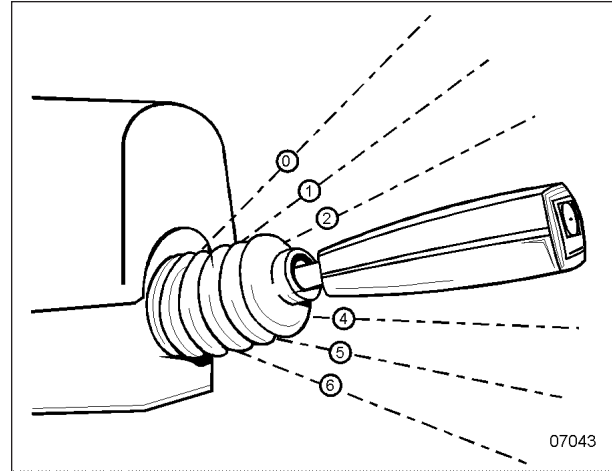

FIGURE 10: RETARDER HAND LEVER

Position	Braking level (up to)
(0) Initial	Varies with brake pedal position. No effect upon release of the accelerator pedal.
(1)	16%
(2)	33%
(3)	49%
(4)	71%
(5)	89%
(6)	100%

NOTE

The output retarder lever is located on the right side of the steering column.

Operating The Retarder Using The Brake Pedal

With the retarder enabled, the accelerator pedal released and the output retarder lever in the initial position (0), depressing the brake pedal will engage both the service brake and the transmission retarder. This is referred to as retarder-brake blending. The further the pedal is depressed, the more total braking power is provided. Refer to ["TRANSMISSION RETARDER \(option\)" on page 25](#) for further information about the transmission retarder.

NOTE

If the wheels start to lock up on slippery roads, the output retarder will automatically deactivate until the wheels start to turn.

4-12 Controls and Instruments

LATERAL CONTROL PANEL

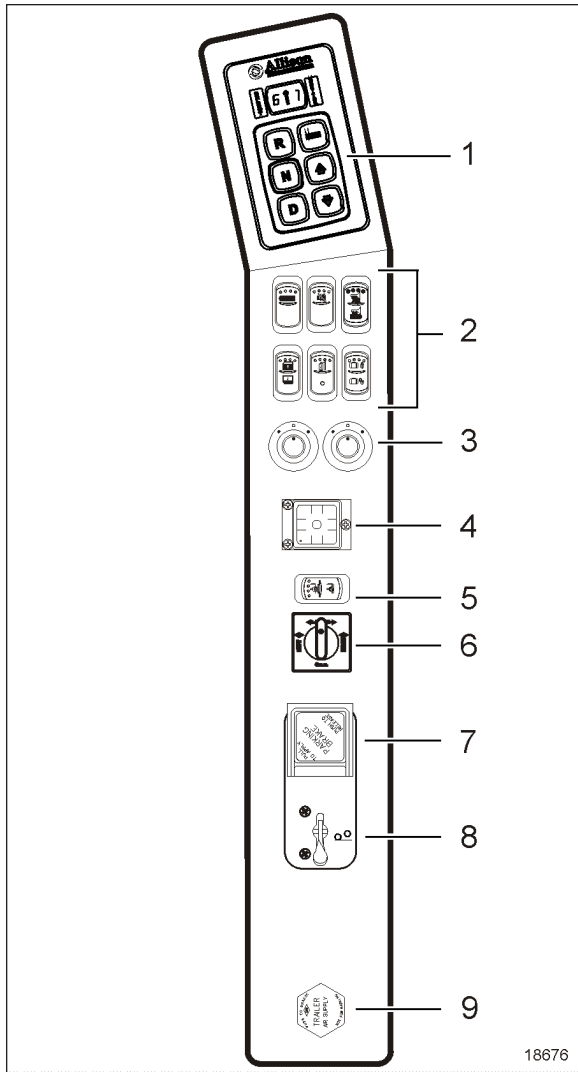

FIGURE 11: LATERAL CONTROL PANEL (TYPICAL)

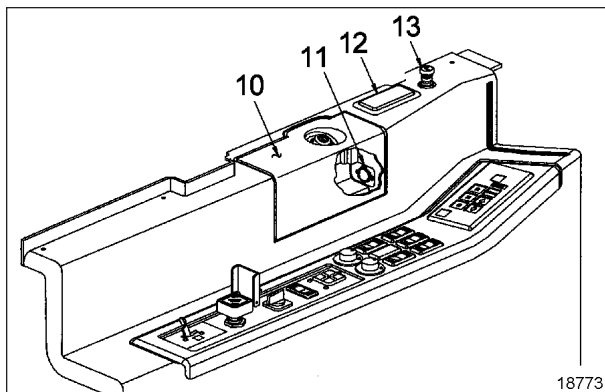

FIGURE 12: UTILITY COMPARTMENT, ASHTRAY & LIGHTER

1. Transmission control pad
2. Control switches
3. Mirror controls

4. Level Indicator
5. Height Control Switch
6. Level Low Selector Switch
7. Parking Brakes Control Valve
8. Tag Axle Control Valve
9. Trailer Air Supply Control Valve (Optional)
10. Utility Compartment
11. 12V DC Power Outlet
12. Ashtray (optional)
13. Cigar Lighter (optional)

TRANSMISSION CONTROL PAD

The Allison transmission control pad is located on the lateral control panel. Refer to ["ALLISON TRANSMISSION" on page 73](#) in this chapter for operating instructions and more information.

CONTROL SWITCHES

Cruise Control Switch

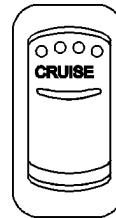

Depress the cruise rocker switch to activate the cruise control. This turns the system on. A led on the switch shows that you can now set the vehicle at a desired cruising speed.

For operation of the cruise control, refer to ["CRUISE CONTROL" on page 49](#) or ["ADAPTIVE CRUISE with BRAKING acb" on page 60](#) in this section.

Back-up Alarm Cancel



Press down this switch to cancel the Back-Up Alarm.

NOTE

After use, return to normal operation.

Horn Selector

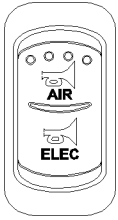

Use this switch the toggle between the air horn and the electric horn when pressing the steering wheel center pad.

Power Window Switch

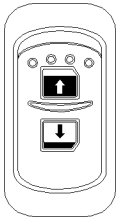

Use this rocker switch to open or close the driver's power window.



CAUTION

Close power window when parked or leaving the coach unattended.

Outside Rear View Mirror / Video Camera Mirror System Heat (Optional)

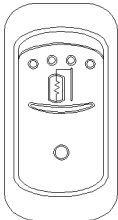

Press this rocker switch to clear fog, frost or thin ice from outside mirrors or the video camera mirror system lens protector.



CAUTION

To avoid damage to the heating system, the heating elements shall not be permanently activated.

Baggage Compartments Locking System

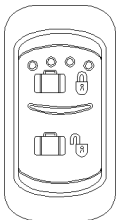

This system enables locking all baggage compartment doors by pressing the switch forward. To unlock, press the switch rearward.

NOTE

Service compartment doors are not linked to the baggage compartment-locking system.

NOTE

Baggage compartment doors must be unlocked using the key first, they can then be unlocked or locked using the baggage compartment-locking system.

MIRROR CONTROLS

Turn the pointer knob counterclockwise for flat mirror adjustment and clockwise for convex mirror adjustment, then use the pointer knob as a joystick to adjust the selected mirror's viewing angle. Adjust the right outside mirror similarly but by using the right side control.

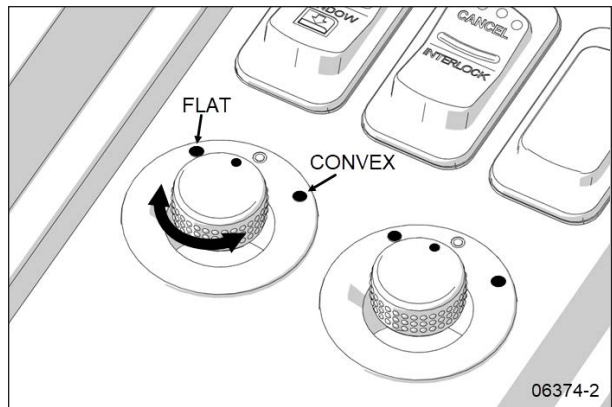

FIGURE 13: MIRROR CONTROLS

NOTE

If the mirror assemblies on your vehicle do not include convex mirrors, only one mirror control knob will be installed for both mirrors. To operate, turn pointer counterclockwise for L.H. mirror adjustment and clockwise for R.H. mirror adjustment, then use the joystick control to adjust the selected mirror's viewing angle.

4-14 Controls and Instruments

LEVEL LOW SYSTEM

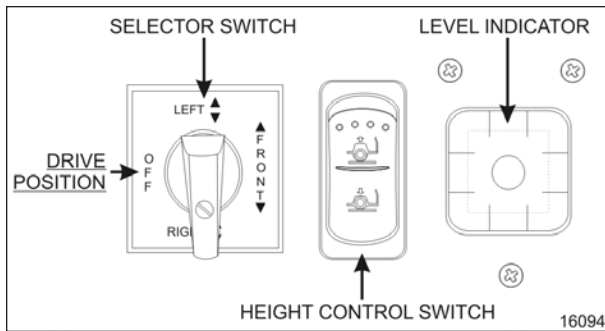

FIGURE 14: LEVEL LOW SYSTEM CONTROLS

When driving, the conventional air leveling system of the vehicle controls the height at three points: the front, the left rear and the right rear. Your vehicle is equipped with a suspension system that consists of air springs (pressurized air bellows) located near each wheel. The amount of air in each air spring (and thus the vehicle height) is controlled by automatic leveling valves that operate between the chassis and the axles of the vehicle.

The three leveling valves are located as follows: one at the front which controls the amount of air in both front air springs, one at the left rear which controls the left rear corner of the vehicle and one at the right rear which controls the right rear corner of the vehicle.

During normal driving, these valves work automatically to maintain the chassis at the proper level above the axles, indifferent of road conditions or vehicle weight.

NOTE

Prevost vehicles are designed to operate within specific weight load/ranges for each axle (GAW) and for total vehicle weight (GVW). If the coach is heavier than the design limits, Level Low System (LLS) components damage and problems can occur..

When parked, and ONLY when parked, the level of the vehicle can be manually adjusted within the range of travel of the air springs. Thus, if the vehicle is parked on uneven ground, the manual override leveling system can be used to level the chassis of the vehicle.

With the engine running, turn the selector switch located on L.H. side control panel to the area of the vehicle requiring leveling, then press the

rocker switch accordingly (up or down) to inflate or deflate the selected set of air springs.

The front position raises or lowers the front only and does not tilt the vehicle to its sides. Each rear position raises or lowers its respective side, therefore, the rear positions can be used to tilt the vehicle to one side or the other, or they can be used to raise or lower the rear of the vehicle. When leveling, it is often necessary to run the engine in order to get an adequate air supply.

NOTE

For maximum ease of ingress and egress as well as for maximum leveling range, lower the vehicle completely before leveling.

NOTE

It is always better to first level the rear of the vehicle (right to left) before raising or lowering the front. After adjusting the rear, watch the level indicator as you adjust the front. If the level indicator shows that the vehicle is starting to tilt to either side, stop adjusting the front as one of the air springs has come to the end of its travel range.

After manual leveling, turn OFF the engine. The vehicle will stay in the leveled position (the air is "locked" in the air springs) as long as there are no air leaks. The vehicle will hold this position for several days. When engine is restarted, with the level selector switch in the OFF position and air pressure is adequate, the vehicle will automatically level itself for driving conditions.



DANGER

Do not drive the vehicle with the level low selector switch in any position other than OFF, as this may render the vehicle unsafe and uncontrollable.

If this is the case, the Level Low warning telltale light in the dashboard will flash, reminding you that the selector is not in the OFF position.

NOTE

If, for any reason, you wish to start the engine without moving the vehicle (to warm up the engine for instance) while keeping the vehicle in the manually leveled position, place selector switch in any position except OFF. When ignition switch is turned to the OFF position, reset the selector switch to the OFF position.

PARKING BRAKE CONTROL VALVE

Spring-loaded parking brakes are applied by lifting the safety cover (if present) and pulling up the control valve knob. Push down to release brakes. Refer to ["EMERGENCY AND PARKING BRAKES" on page 8](#) in Section 7 Safety Features and Equipment.

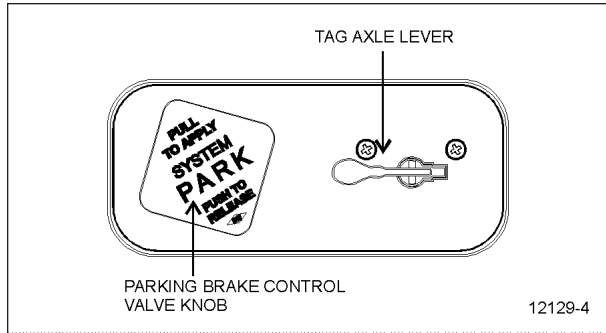

FIGURE 15: PARKING BRAKE CONTROL VALVE

TAG AXLE CONTROL VALVE

Lift the tag axle by pushing the lever forward. Pulling the lever rearward will lower and load the tag axle. Refer to ["RETRACTABLE TAG AXLE" on page 29](#) in Section 5 Other Features for additional information.

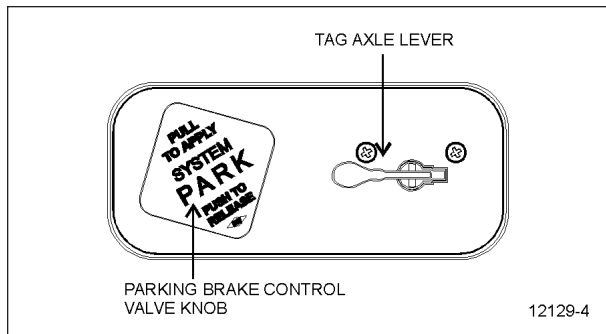

FIGURE 16: TAG AXLE CONTROL VALVE



CAUTION

Do not drive vehicle with tag axle raised when speed is exceeding 12 mph (20 km/h).

TRAILER AIR SUPPLY CONTROL VALVE (OPTION)



The trailer air braking system is supplied by pushing this control valve.

UTILITY COMPARTMENT & 12V POWER OUTLET

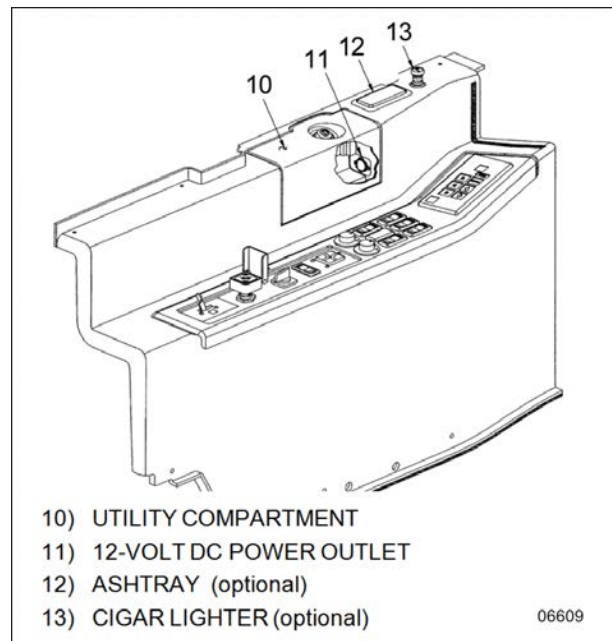

FIGURE 17: LATERAL CONTROL PANEL

To open the compartment, push down on the lock button and swing the cover open towards the inside of the coach.

A 12-volt DC power outlet is located inside the pocket.

This socket can be used to power small 12-volt DC appliances such as a cellular phone or a vacuum cleaner. The maximum power consumption allowed for appliances plugged in this socket is 130 watts. Make sure appliances are equipped with suitable plugs that will not damage the socket.

4-16 Controls and Instruments

ASHTRAY

To open the ashtray, push slightly on the cover's side. The ashtray can be removed for cleaning by pulling it out.



WARNING

To prevent a fire, never put paper or plastic wrappers in the ashtray. Empty ashtray often.

CIGAR LIGHTER

Push lighter in to activate. When ready to use, it will spring out automatically. Replace lighter in non-activated position. The cigar lighter socket can be used to power 12-volt appliances (eg. flashlight, vacuum cleaner). The maximum power consumption allowed for appliances plugged in this socket is 130 watts. Make sure the appliances are equipped with suitable plugs that will not damage the socket.

NOTE

The cigar lighter can still be used after the ignition key has been removed.

SIDE CAMERA REAR VIEW MONITORS

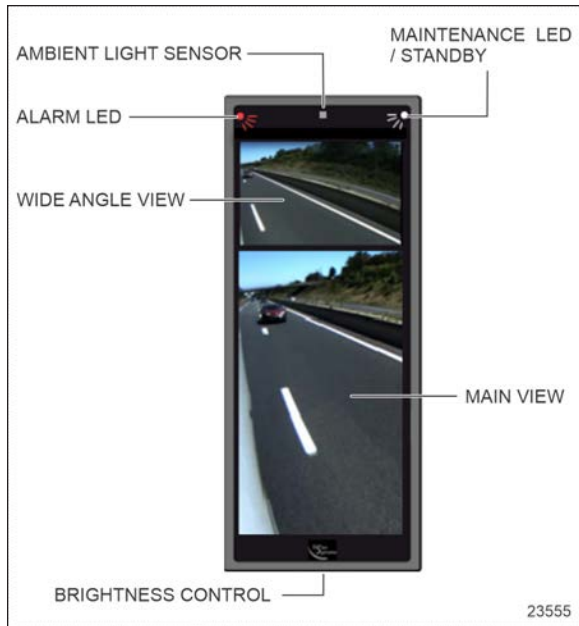

FIGURE 18: MONITOR



CAUTION

Do not cover the cooling vents on the back of the monitor.

REFERENCE LINES

Upon activation of the turn signals, three reference lines appear on the main view of the corresponding monitor (see image below). When in reverse, two reference lines (yellow & red) are displayed on both monitor.

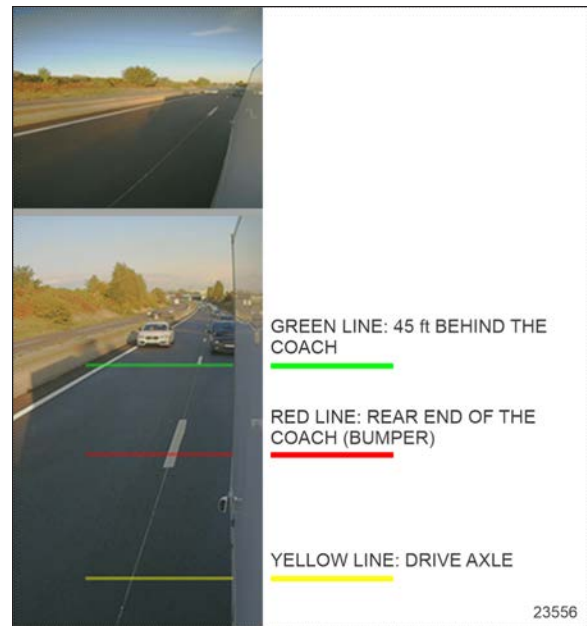

FIGURE 19: REFERENCE LINES IN MONITOR

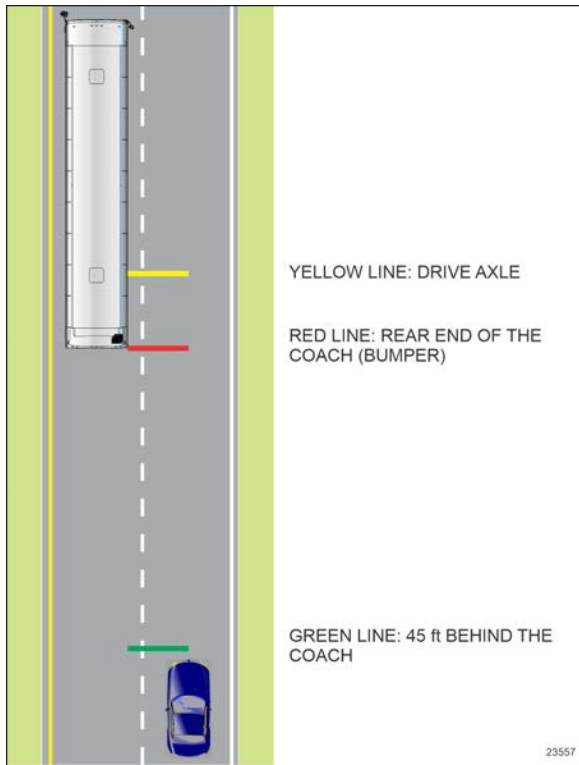

FIGURE 20: REFERENCE LINES

BRIGHTNESS ADJUSTMENT

Each monitor switches automatically and independently between night mode and day mode depending on the actual ambient light. However, the driver can adjust the brightness with the brightness control at the bottom of the monitor. This manual adjustment will change the brightness of both monitor at the same time.

MONITOR STATE

<p>SYSTEM BOOT</p>	<p>NORMAL OPERATION</p>
<p>SLEEP MODE</p> <p>blinking</p>	<p>MINOR ISSUE</p> <p>blinking</p>

4-18 Controls and Instruments

<p>WIDE ANGLE VIEW NOT AVAILABLE</p> <p>blinking</p> 	<p>MAIN VIEW NOT AVAILABLE</p> <p>steady</p> 
<p>MAJOR ISSUE</p> <p>blinking</p> 	<p>NOT POWERED</p> 

DASHBOARD

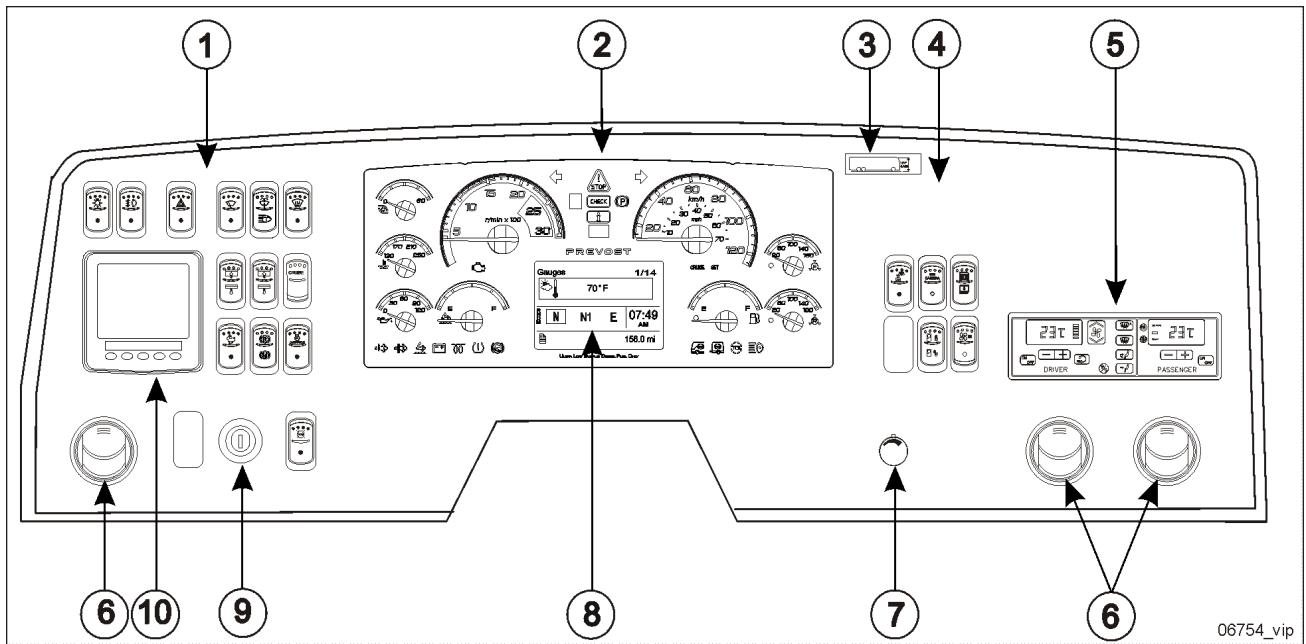

06754_vip

FIGURE 21: DASHBOARD

1. L.H. dashboard panel
2. Instrument cluster
3. Vehicle clearance information
4. R.H. dashboard panel
5. HVAC control unit
6. Air registers
7. Brightness control
8. Driver information display (DID)
9. Ignition switch
10. On-Screen tire pressure monitoring system display

4-20 Controls and Instruments

CONTROL SWITCHES

High quality switches are used to control many of the features of the vehicle. Many switches have an embedded indicator LED to inform the driver at a glance which features are active.

On some switches, the indicator LED will turn off after a short while when the engine is running. This is normal and is designed to reduce glare when driving. The functions still operate even if the LED is off. If the switches are still on when the engine is turned off, the LEDs will illuminate to warn the driver to turn them off. Switches are described in the order they appear, from left to right, top to bottom.

L.H. DASHBOARD PANEL

The L.H. dashboard panel includes controls for the operation of the coach; it also includes the ignition switch and an adjustable air register.

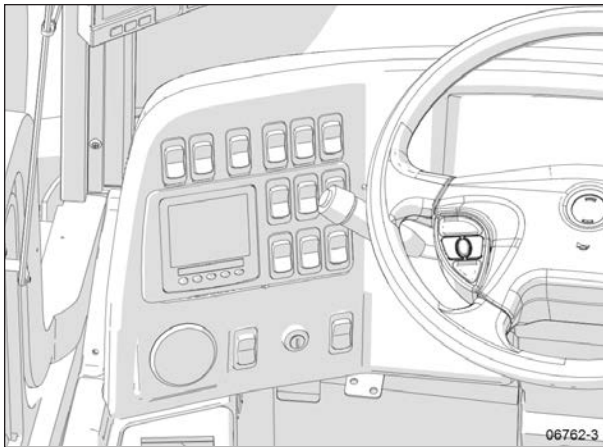

FIGURE 22: L.H. DASHBOARD PANEL

Headlights And Exterior Lighting

OFF position – Daytime running lights only (with engine running).

Press this rocker switch to turn on the following lights:

First position – Front parking lights, taillights, clearance lights, marker lights, license plate light.

Second position (push down fully) – the headlights, the controls and instrument lights and all lights from the first position.

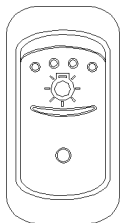

NOTE

Daytime running lights will be automatically canceled when the exterior lighting switch is fully depressed (second position).

Fog Lights (Optional)

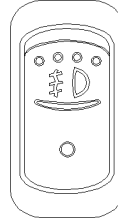

Optional halogen fog lights provide better visibility in fog and precipitation. They improve close range visibility and provide added safety.

NOTE

Some states and provinces restrict the use of fog lights. Verify local state or provincial regulations before using.

Hazard Warning Flashers

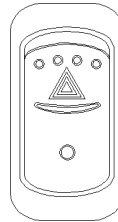

Press the rocker switch to make all turn signal lights flash at once. The dashboard telltale lights will flash when the hazard warning flashers are ON.

Once the hazard warning flashers are activated, the ignition switch can be turned to the OFF position. The hazard warning flashers will stay activated and will prevent the vehicle systems to fall in "sleep mode".

Upper Windshield Wipers (Optional)

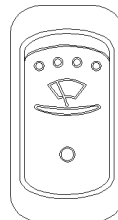

Press the rocker switch to the first position to activate the upper wipers intermittently.

Press to the second position for continuous operation of the upper wipers.



CAUTION

To avoid damaging the wiper blades or scratching the windshield, do not operate the wipers when the windshield is dry. Also, loosen frozen wipers before operating.

NOTE

Lower windshield wipers are activated using the multi-function lever. Refer to "[STEERING COLUMN CONTROLS](#)" on page 8 in this section.

Upper Windshield Washer (Optional) & Headlights Washer

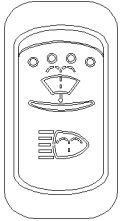

Press this rocker switch upwards to spray the upper windshields with washer fluid. Windshield wipers will automatically come on and stop a few seconds after releasing the switch.

Momentarily press this rocker switch downwards to spray the headlights washer fluid. Each pressing of this switch produces 2 successive jets.

CAUTION

Do not operate the washer mechanism while the washer fluid reservoirs are empty. This may damage the washer fluid pumps.

NOTE

Lower windshield wipers are activated using the multi-function lever. Refer to "[STEERING COLUMN CONTROLS](#)" on page 8 in this section.

Headlights Washer



Momentarily press this rocker switch downwards to spray the headlights washer fluid. Each pressing of this switch produces two successive jets.

CAUTION

Do not operate the washer mechanism while the washer fluid reservoirs are empty. This may damage the washer fluid pumps.

Windshield Upper Section Defrosting (Option)

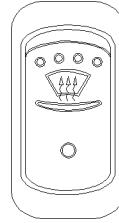

The coach may be equipped with an optional defrosting system in the upper windshield section. Press the rocker switch to activate the blower in order to clear fog, frost or thin ice from either side of the upper windshield.

The upper windshield defrosting is automatically activated when:

1. The outside temperature is lower than 39°F (4°C);
2. The engine temperature is higher than 86°F (30°C);
3. The driver's side HVAC control unit is turned on and the fan speed is higher than zero.

After automatic activation of the upper windshield defrosting, the upper defroster unit can be turned off by cycling this switch to the ON position and then to the OFF position.

Traction Control System Mud/Snow Mode

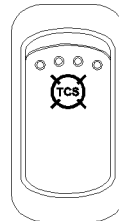

On certain road conditions, it may be useful to retard the intervention of the traction control system TCS during vehicle acceleration. The Mud/Snow function allows greater engine power and more wheel spin during TCS operation. This function may be helpful to set the vehicle in motion on iced roads, for example.

Press the Mod/Snow switch to turn on this function. The TCS icon blinks slowly in the DID when the TCS Mud/Snow mode is active. Always remember to turn the Mud/Snow feature off when driving on a firm road surface.

A new ignition cycle or a second pressing of the Mud/Snow switch will turn this function off.

4-22 Controls and Instruments

Wheelchair Lift

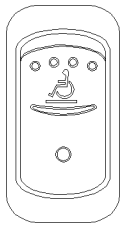

Supply electrical power to the wheelchair lift system by pressing down on the rocker switch. Refer to Other Features for instructions on operating the wheelchair lift.

Fast Idle

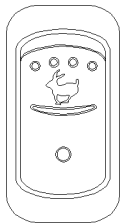

For extended idling periods, run the engine at fast idle. Press down this rocker switch to engage fast idle. This increases the engine speed to approximately 1,000 rpm. Return to normal idle before driving or when stopping the engine.



CAUTION

If the parking brake is released and/or the transmission is engaged with the engine running at fast idle, the engine will return to normal idle and remain there as long as the parking brake is not applied and/or transmission is not placed in neutral (n).

The engine will return to fast idle once the parking brake is applied or neutral (n) selected.



CAUTION

Return the engine to normal idle before shutting the engine off.

Engine Brake (Optional)

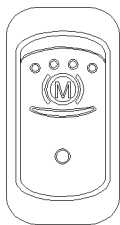

The vehicle's engine brake is by default set to automatic (AUTO **A** mode). On vehicles equipped with this switch, it is possible to disable the engine brake (OFF mode).

From OFF or AUTO mode, the driver can switch directly to Engine Brake LOW **1** or Engine Brake HIGH **2** mode by using the buttons on the steering wheel. Refer to ["TRANSMISSION RETARDER \(option\)" on page 25](#) & ["ENGINE BRAKE" on page 25](#) in Section 5 Other Features.

The switch will have to be pressed again to return to AUTO **A** mode (cycling the ignition will have the same effect).

Engine Brake / Transmission Retarder

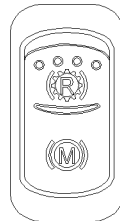

Use this switch to select between the transmission retarder or the engine brake when using the vehicle speed retarding device switches on the steering wheel. Neither system can be in function at the same time. This rocker switch is present on the dashboard, only if the vehicle is equipped with both systems. Refer to ["TRANSMISSION RETARDER" on page 11](#) in this section. Refer also to ["TRANSMISSION RETARDER \(option\)" on page 25](#) & ["ENGINE BRAKE" on page 25](#) in Section 5 Other Features.

Engine Stop Override (With Automatic Fire Detection And Suppression System)



Press the Engine Stop Override switch on the dashboard or the Delay Engine Stop switch on the AFSS protection panel to delay the engine shutdown and extinguisher discharge by an additional 15 seconds.



CAUTION

Use this function if you are not prepared to bring the vehicle to a safe stop (i.e. on a railroad track, in intersection).

This switch is functional only if the vehicle is equipped with the Automatic Fire Detection and Suppression System.

Driver Controlled Differential Lock (Dcdl) (Optional)



Press this rocker switch to lock or unlock differential action. Refer to "[DRIVER CONTROLLED DIFFERENTIAL LOCK \(DCDL\)](#)" on [page 28](#) in Section 5 Other Features for the complete operating instructions.



CAUTION

- Engage DCDL only under poor road surface conditions.
- DCDL will not engage and will disengage in speed higher than 5 mph.
- Do not lock DCDL when one or more wheels are slipping, spinning or losing traction. You can damage the drive axle.
- Using the rocker switch, unlock DCDL when the need for improved traction has passed otherwise it will re-engage automatically as speed gets below 5 mph. Over a prolonged period, this situation will increase tire wear and stress to the vehicle.
- Do not engage during downhill operation.

R.H. DASHBOARD PANEL

The HVAC control module as well as the cluster dimmer switch, miscellaneous control switches and air vents, are located in the R.H. dashboard panel.

Vehicle clearance information may also be affixed in this location.

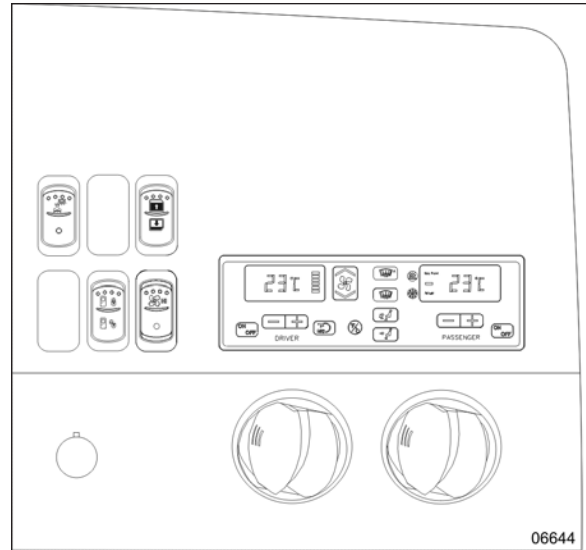
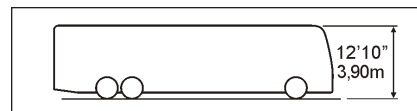

FIGURE 23: R.H. DASHBOARD PANEL

Vehicle Clearance Information



Safe vehicle clearance height is 12'10" (3.90 m).



CAUTION

Vehicle clearance is higher when the ventilation hatch is open (if installed) , Hi-Buoy is selected or if additional equipment is installed on the roof.

Driver's Area Lighting

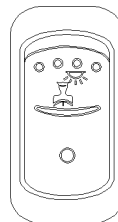

Press this rocker switch to turn on the driver's overhead light as needed.

NOTE

The entrance overhead light and the stepwell lights turn on with the entrance door opening and turn off with door closing. If the entrance door is left opened, these lights will be turned off automatically if the battery voltage drops below 24.0 volts.

4-24 Controls and Instruments

Back-up Camera



Press down this switch to turn ON the Back-up Camera monitor when the transmission is not in reverse gear.

Entrance Door Power Window

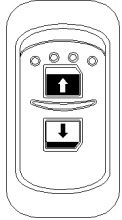

Use the rocker switch to open or close the power window in the entrance door. The switch for the driver's power window is on the Lateral control panel.

Entrance Door Lock / Unlock



Use this rocker switch located on the dashboard's R.H. side panel for locking or unlocking the entrance door from the driver's seat.

Cabin Fan Speed Override Switch



Press the upper part of the switch to force HI fan speed for cabin ventilation. Press on the lower part to force LO fan speed. (only available on models equipped with central HVAC system)

Used to override the automatic fan speed set by the HVAC control module. Speed setting is reset by turning ignition to OFF.

Brightness Control

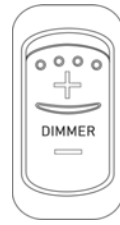

Adjusts the brightness of the dashboard instruments and switches.

HVAC CONTROL UNIT

The driver HVAC unit turns on automatically at engine start and uses the settings that were kept in memory before turning off of the system. The A/C compressor starts automatically when the two following conditions are satisfied:

1. The outside temperature is above 32 °F (0 °C).
2. The passenger's area temperature has reached 7 °F (4 °C) under the set point.

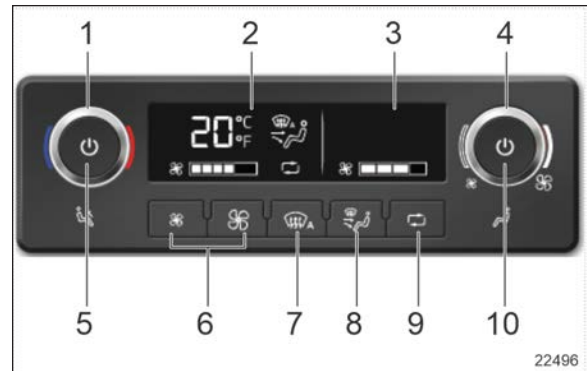

FIGURE 24: DRIVER HVAC SYSTEM CONTROL UNIT WITH AUXILIARY AIR

In addition to the driver area controls, the driver HVAC system also includes an auxiliary unit to provide additional cool air behind the driver and for the navigator seating area. Temperature is set by the driver section of the control unit. See ["Navigator air registers" on page 26](#)

1) Driver temperature set point adjustment

Increases or decreases the temperature set point for the driver area.

2) Driver section display

Displays the temperature set point, the fan speed, the air selection and recirculate air status for the driver

area.

3) Auxiliary air display

4) Auxiliary air fan speed control

Increases or decreases the fan speed.

5) Driver HVAC power button

Turns on/off the driver HVAC unit.

6) Fan speed

Increases or decreases the fan speed.

7) Auto-defrost

Upon pressing this button, the dashboard damper sends air only to the lower windshield. The fan is turned on to maximum speed, the fresh air damper opens completely (recirculate off) and the driver set point is increased to 4 °F (2 °C) over the passenger section set point.

8) Air selection

Changes the air outlets used.

9) Recirculate

Switches between outside air and recirculated air for the driver and passenger area. This feature is automatically canceled when the windshield defrost is activated.

10) Auxiliary air power button

Turns on/off the auxiliary air fan.

Temperature Unit Selection °F / °C

To switch the temperature units, press simultaneously both fan speed buttons for 3 seconds.

Driver Section Temperature Setting In Case Of Temperature Sender Failure

On the driver section of the control unit only, asking for a temperature set point above 82 °F (28 °C) will keep the coolant valve open .

In case of interior temperature sender unit failure, the coolant valve will remain open.

NOTE

To operate the air conditioning system when stationary, run the engine at fast idle. When the system is running, keep windows and door closed.

To prevent battery run-down, the central A/C and heating systems will not operate if the charging system is not working properly.

Upon starting, if the outside temperature is above 32 °F (0 °C) and then drops below 32 °F (0 °C), the compressor will keep running up to a temperature of 15 °F (-9 °C) to prevent fogging.



WARNING

Warm temperatures may cause drowsiness and affect alertness while driving. Keep the temperature comfortable but not too high.

AIR REGISTERS

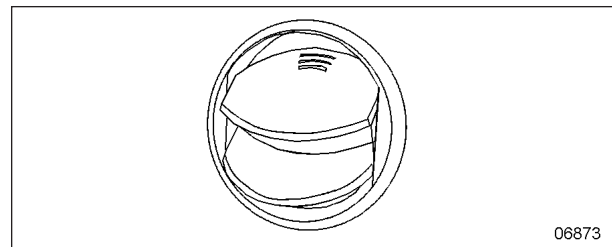

06873

FIGURE 25: AIR REGISTER

Adjustable air registers feed air to the driver's area. Three are located in the dashboard and one near the door . Use the HVAC control panel to set air temperature and fan speed.

Three additional auxiliary unit registers are also located behind the driver (with driver's HVAC systems only).

4-26 Controls and Instruments

Navigator's Area Controls

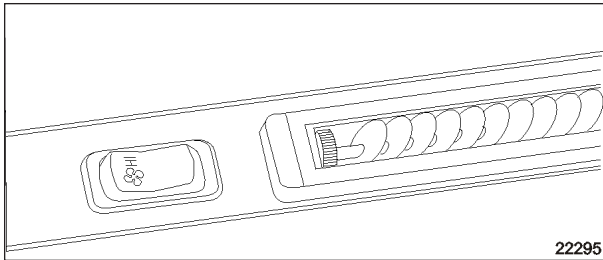

FIGURE 26: NAVIGATOR'S AIR REGISTER & FAN SPEED SELECTOR

For the navigator, two adjustable registers and a fan speed selector switch are located near the entrance door, at bottom of first lateral window.

Upon turning on of the HVAC control unit, right and left windshield defogging/defrosting fan speed is set according to the driver section settings. The navigator can afterwards, use this switch to increase or decrease the right windshield defogging/defrosting fan speed as needed.

Navigator Air Registers

On driver's HVAC system, these registers are part of the auxiliary unit. Use the auxiliary unit fan speed switch on the R.H. portion of the control unit (AUX. FAN) to regulate the fan speed. Doing so will also reduce air from the three registers located behind the driver.

On vehicles equipped with the high capacity central HVAC system, these registers are supplied in air by the passenger's (cabin) unit.

INSTRUMENT PANEL

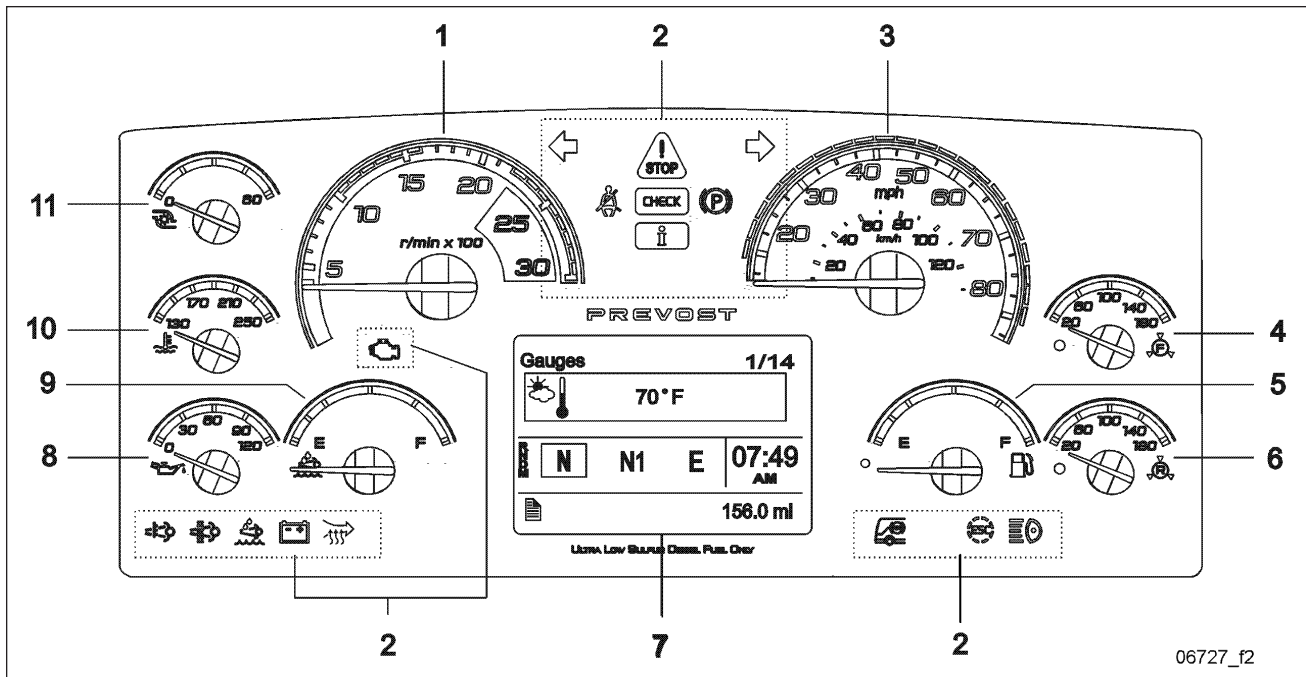

1. Tachometer
2. Telltale lights
3. Speedometer
4. Front brake air pressure (secondary)
5. Fuel level
6. Rear brake air pressure (primary)
7. Driver Information Display (DID)
8. Oil pressure indicator
9. DEF (Diesel Exhaust Fluid) level indicator
10. Engine coolant temperature
11. Turbo boost pressure

4-28 Controls and Instruments

DRIVER INFORMATION LEVEL

The instrument cluster includes the analog instruments. It also presents two devices to communicate information to the driver, the telltale lights and the Driver Information Display (DID).

Indications and warnings are presented according to three levels of attention required:

FIRST LEVEL - TELLTALE LIGHTS

Telltale lights are temporary and exceptional; they present information critical to safety or vehicle integrity.

SECOND LEVEL - POP-UP MESSAGES

Pop-up messages appear in the Driver Information Display DID without the driver's intervention and acknowledgment. Pop-up messages present supplemental information to the driver.

THIRD LEVEL- STATUS LINE

The status line monitors certain systems and gives feedback to the driver concerning current actions and functions.

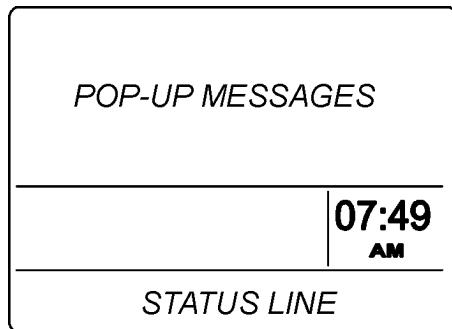

06742b

ANALOG INDICATORS

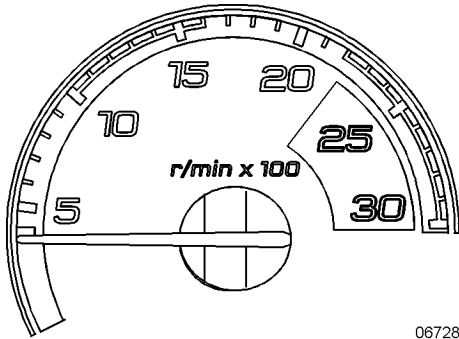

06728

Tachometer (Rpm X 100)

Indicates the operating speed of the engine in hundreds of revolutions per minute. Use the green range for normal driving (1000 to 1600 RPM).

The tachometer serves as a guide for gear shifting and helps to prevent engine over-speeding when driving downhill with the engine brake operating.



CAUTION

Never allow the engine to go into the red range. This could lead to severe engine damage.

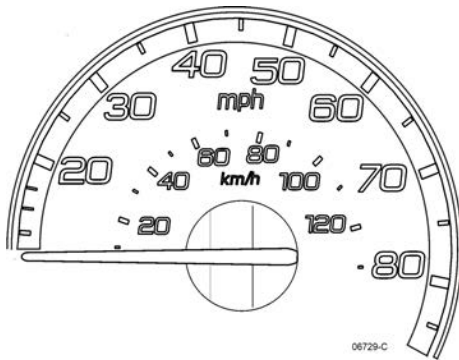

06729-C

Speedometer (MPH, Km/h)

Indicates the vehicle speed in miles per hour (mph) and kilometers per hour (km/h) .

The LEDs above the instrument work in conjunction with the Adaptive Cruise With Braking (ACB) system. Refer to Adaptive Cruise With Braking” paragraph for further details.

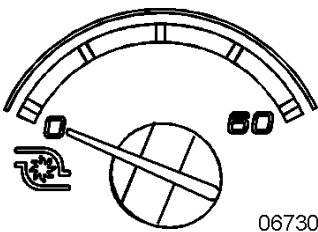

06730

Turbo Boost Pressure (psi)

Indicates the turbo boost pressure in psi. This pressure should be the same at a given engine temperature, speed, and load. An unusual reading could indicate an engine failure.

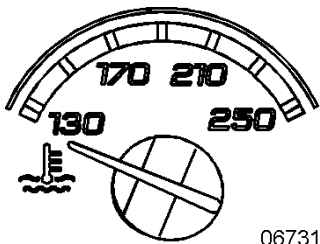

Engine Coolant Temperature (°F)

Indicates the operating temperature of the engine coolant in °F. The normal reading should be between 170°F and 222°F (80°C to 106°C).

The temperature limit is dependent on the electronic program for the engine model. When coolant temperature is excessive, the STOP telltale light turns on, an audible alarm sounds and a pop-up message appears on the DID. The engine protection system will automatically derate and stop the engine in 30 seconds. Stop at the first safe place where the problem can be checked.

If the temperature remains below or exceeds the normal temperature range, the cooling system should be checked for problems.



STOP telltale light

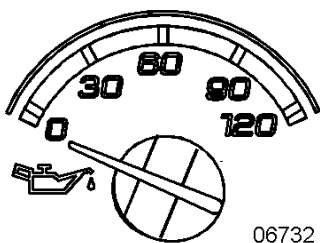

Engine Oil Pressure (psi)

Indicates the engine oil pressure in psi. When the oil pressure is too low, the STOP telltale light turns on, an audible alarm sounds and a message appears on the DID. The engine protection system will automatically derate and stop the engine in 30 seconds. Bring the vehicle to a safe stop where the problem can be checked.



STOP telltale light



OIL PRESSURE Pictogram



CAUTION

Failure to take necessary action when the STOP telltale light is on can ultimately result in automatic engine derate and shutdown.



Front Brake Air Pressure Gage (Secondary System)

Indicates the front brake air system pressure in psi. The normal operating pressure is from 122 to 140 psi.

The low air pressure indicator LED on the gage and the STOP telltale light illuminate when the front brake air system (secondary) pressure drops below 85 psi. An audible alarm will sound.



STOP telltale light



WARNING

The driver is responsible for monitoring the pressure as part of a regular sweep of the instruments.

If the pressure drops in the secondary system but remains normal in the primary system, the front axle service brakes will not function but the drive and tag axle service brakes will operate normally, although if there is a leak in any pneumatic system (Sec/Pri/Park/Acc), the primary system might eventually lose its air pressure as well, depending on the nature and size of the leak. In the event of any air pressure loss in any system, the driver should pull to the side of the road as soon as can be safely done and investigate the situation.

Do not drive the coach when the brake air pressure is low.

4-32 Controls and Instruments



Rear Brake Air Pressure Gage (Primary System)

Indicates the rear brake air system pressure in psi. The normal operating pressure is from 122 to 140 psi.

The low air pressure indicator LED on the gage and the STOP telltale light illuminate when the rear brake air system pressure drops below 85 psi. An audible alarm will sound.



STOP telltale light



WARNING

The driver is responsible for monitoring the pressure as part of a regular sweep of the instruments.

In the event of a pressure loss in the primary brake system, the drive and tag axle service brakes will not function normally. It is critical to bring the coach to a safe stop as quickly as possible.

If there is sufficient pressure in the secondary brake system, modulated spring brake pressure (using the park brake chambers) will be used to apply the drive axle brakes, proportional to the braking pressure on the front axle. It must be noted this is an emergency and a significant amount of secondary air pressure is lost with each apply/release cycle. The spring brake modulation will only function two or three times, depending on the amount of secondary air pressure that was on hand when the primary brake pressure was lost.

Once the secondary air pressure drops below 60 psig, the park spring brakes are fully applied and cannot be released until pressure is restored.

Do not drive the coach when the brake air pressure is low.

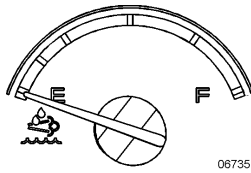

DEF Level

Indicates the amount of DEF (Diesel Exhaust Fluid) remaining in the DEF tank. The DEF tank is considered as being full when it contains 16 gallons (60 liters) of DEF. DEF consumption will be approximately 2% of the diesel fuel consumed.



CAUTION

DEF – Do not overfill

If an automatic nozzle is used for filling diesel exhaust fluid (DEF), do not add further DEF after the nozzle has automatically shut off flow a first time. If such nozzle is not available, use the DEF level gage on the instrument panel to control the quantity during filling.

Diesel exhaust fluid DEF will begin to crystallize and freeze at 12°F (-11°C) and expand by 7% when frozen. To allow expansion without damaging the DEF tank, do not fill the tank with more than 16 gallons (60 liters).

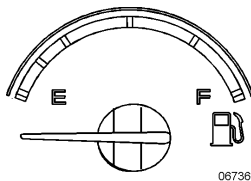

Fuel Level

Indicates the amount of fuel remaining in the fuel tank. At the beginning of the red area, there is approximately 48 gallons (182 liters) left in the tank.

NOTE

A pop-up message will appear in the DID informing that there is only 26 gallons (98 liters) left in the fuel tank.

TELLTALE LIGHTS

The telltale lights illuminate for 5 seconds at the start of every ignition cycle as a light bulb check.

A telltale test can be initiated by the DID Diagnostic Menu, under Cluster Selftest. See [DIAGNOSTICS MENU](#)



Stop

Indicates that a serious problem has been detected. Immediately park the coach in a safe place and stop the engine. This telltale light may be accompanied with a message in the DID and a diagnostic troubleshooting code will be stored to ease identification of the problem.



WARNING

Failure to take necessary action when the STOP telltale light is on can ultimately result in automatic engine derate and shutdown.

4-34 Controls and Instruments



Check

Indicates that a problem has been detected and must be checked at the next stop. This telltale light may be accompanied with a message in the DID and a diagnostic troubleshooting code will be stored to ease identification of the problem.



Forward Vehicle Detected – Adaptive Cruise With Braking

When the ACB is engaged with a cruise speed set and the forward vehicle is in range, the FORWARD VEHICLE DETECTED telltale light illuminates, indicating the ACB system is actively tracking the forward vehicle.

GREEN: The vehicle ahead of you is detected by the radar.

FLASHING RED: Impact alert. The vehicle ahead of you is too close. The driver must take immediate evasive action by applying more braking power and/or steering clear of the vehicle ahead to avoid a potential collision.

RED: System malfunctions. The Adaptive Cruise with Braking is not available.



Information

This telltale light illuminates when there is a new information message or an abnormal status is detected by the electronic control unit. A pictogram, text or both are shown in the DID in addition to the INFO telltale light. Make sure the indicated fault is checked at the next stop.



Turn Signal Indicators

Flashes when the right or left turn signals are activated. Signal right and left turns by operating the multi-function lever. See ["MULTI-FUNCTION LEVER" on page 8](#) in this section.

NOTE

The turn signals are automatically activated when the vehicle is backing up.



Parking Brake Or Emergency Brake Applied

Illuminates when the emergency/parking brake is applied. The control valve is located on the L.H. control panel. An audible alert will sound if ignition is turned to Off and the parking brake is not engaged.



Driver's Seat Belt Reminder Light And Warning Buzzer

When equipped with a seat belt buckle switch, warns the driver to fasten his/her seat belt.



Aftertreatment System Malfunction (Malfunction Indicator Lamp)

Indicates a failure of an emission control device. May illuminate at the same time as the CHECK amber warning light. The lamp will go out after 3 completed ignition on-ride-ignition off cycles. Vehicle can be driven to end of the shift. Call for service.

CRUISE

Cruise Control

Indicates that the cruise control is enabled.

SET **Cruise Control Set Speed**
Indicates that a cruising speed is set and stored in the memory.

 **High Exhaust System Temperature (HEST)**
Illuminates to notify the driver of potentially hazardous exhaust gas temperature at the exhaust system diffuser.



WARNING

During regeneration, exhaust temperature may reach up to 1200°F (650°C) at the particulate filter. When parking the vehicle, if this telltale light is illuminating, make sure that the exhaust system diffuser is away from people or any flammable materials, vapors or structures.



DPF Regeneration Request
Illuminates to notify the driver that a manual stationary regeneration will be required soon. Refer to ["STATIONARY \(PARKED\) REGENERATION" on page 3](#) in Section 5 Other Features.



Def Tank Low Level Indicator
Illuminates when there is less than 2.6 gallons (10 liters) of DEF left in the tank.



CAUTION

If the vehicle is kept in operation with an empty DEF tank, engine derate will eventually occur, limiting the speed to 5 mph.



Charging System Warning Light
Indicates a malfunction of the charging system or a low battery voltage condition.

NOTE

To identify if an alternator is defective (1=lower alternator, 2=upper alternator), perform a system diagnostic using the Driver Information Display DIAGNOSTICS menu. Select VIEW ACTIVE FAULTS and then ELECTRICAL SYSTEM. Scroll through the active faults. The electrical system active faults will appear. A diagnostic message indicating "alternator 1" or "alternator 2" with failure mode "open circuit" will come in sight.



Intake Air Preheater On – Wait Before Starting
Illuminates when the intake air preheater element is in function. Wait until this telltale light has turned off before starting the engine. For more information, refer to ["COLD WEATHER STARTING" on page 4](#) in Section 6 Starting and Stopping Procedures.



Hill Start Assist
Indicates a malfunction of the Hill Start Assist function. This function might not be available.

4-36 Controls and Instruments



Antilock Brake System (ABS)

Illuminates when the ABS is not available or when the ABS is malfunctioning. Since the ABS system does not operate at less than 4 mph (7 km/h), the indicator will remain illuminated until the coach reaches that speed. Refer to ["ANTILOCK BRAKING SYSTEM \(ABS\)" on page 27](#) in Section 5 Other Features.



Trailer Antilock Brake System (ABS)

Illuminates when the trailer ABS is not available or when the trailer ABS is malfunctioning.



Esc - Electronic Stability Control

At vehicle ignition, the ESC telltale lamp illuminates for approximately 3 seconds and then turns off. If it remains on steadily (not flashing) after ignition, or if it illuminates steadily while you are driving, the ESC system may not be fully functional or their operation may be completely disabled. If this happens, your vehicle will still have normal service braking and can still be driven, but without the benefits of the ESC system.

Flashes quickly when ESC intervenes to reduce risk of loss of control.



High Beam

Illuminates when the high beams are selected.

High and low beams are selected with the multi-function lever. Refer to ["MULTI-FUNCTION LEVER" on page 8](#) in this section.

STOP, CHECK AND INFORMATION TELLTALE LIGHTS

STOP, CHECK and INFORMATION telltale lights illuminate automatically to draw the attention of the driver and their associated messages are displayed in the DID. More than one message (see “Acknowledging Messages” below) can be active at the same time. A displayed message can be replaced by a new message provided the new message has a higher priority. Only fault codes that have a direct impact on vehicle operation are displayed. All fault codes are stored in the appropriate ECU for access by service technicians.

Stop Telltale Light

In the event of a serious fault, the red STOP telltale light comes on and an audible alarm will sound if the engine is running. An illuminated stop message light indicates a serious problem has been detected, and the driver must respond immediately to the problem.



When illuminating, this telltale light means the vehicle must be safely pulled off the road and stopped. In some instances, the engine must be switched off immediately.

WARNING

Failure to stop and take necessary action when the STOP telltale light is on can result in an automatic engine derate and shutdown.

In some cases preventive action may be taken by the engine ECU to protect the engine. For further details, refer to [“ENGINE PROTECTION SYSTEM” on page 6](#) in Starting and Stopping Procedures.

Check Telltale Light

This telltale light means that a fault or an abnormal operating condition has been detected. The vehicle must be checked at the next stop.



If the CHECK telltale light illuminates, an associated message is displayed in the DID. Always pay attention to the associated messages (see “Acknowledging Messages” below).

Information Telltale Light

The INFO indicator light comes on when there is a new information message or an abnormal status is detected by the electronic control unit. A pictogram or text or both are shown in the DID in addition to the INFO telltale light (see “Acknowledging Messages” below).



Acknowledging Messages

A fault message associated to a STOP, CHECK or INFORMATION telltale light must be acknowledged by pressing the ESCAPE or ENTER button after which the display returns to the same status that existed before the fault occurred. All messages can be acknowledged. Acknowledgement of pop-up messages and warnings stops the audible warning.

Acknowledged but inactive messages are displayed again when the ignition key is turned to the START position or they can be read in the DID menu. Refer to Other Features for more information on the DID menus.

DRIVER INFORMATION DISPLAY

The DID (Driver Information Display) is located in the center of the instrument cluster. It displays digital gages, main menus and submenus that provide necessary and important information to the driver. The information available to the driver depends on vehicle configuration, and whether the vehicle is in operation or parked. For the list of the available menus and submenus, refer to [“DRIVER INFORMATION DISPLAY \(DID\) MENUS” on page 11](#) in Section 5 Other Features.

4-38 Controls and Instruments

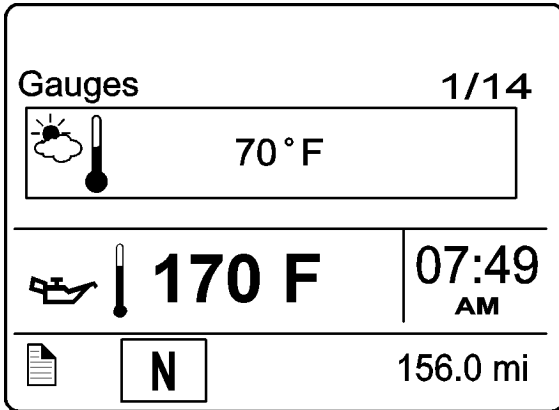

06746

The outside air temperature, fuel flow and the odometer (Allison transmission) or the current gear position (transmission I-Shift) are part of the default display. You can replace the default display by your selection of favorite gages using the Driver Information Display submenu Favorite Display Setting. Refer to ["DRIVER INFORMATION DISPLAY \(DID\) MENUS"](#) on [page 11](#) in Section 5 Other Features for more information.

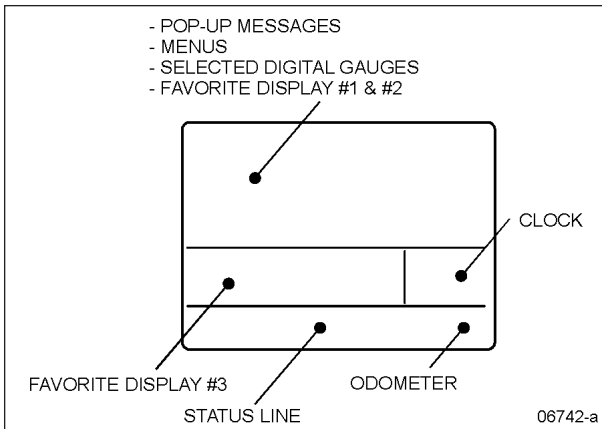

06742-a

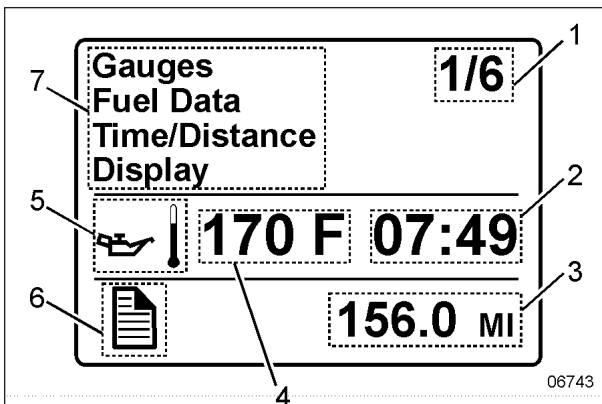

06743

1. Indicates first of six available menus (varies by menu)
2. Clock
3. Odometer
4. Value or data (in this example, the engine oil temperature)
5. Pictogram relevant to the displayed value or data
6. Status bar active pictogram
7. Messages or available menus

Selecting A Menu

Menus are placed in a cascade arrangement. Use the steering wheel controls buttons to scroll through them.

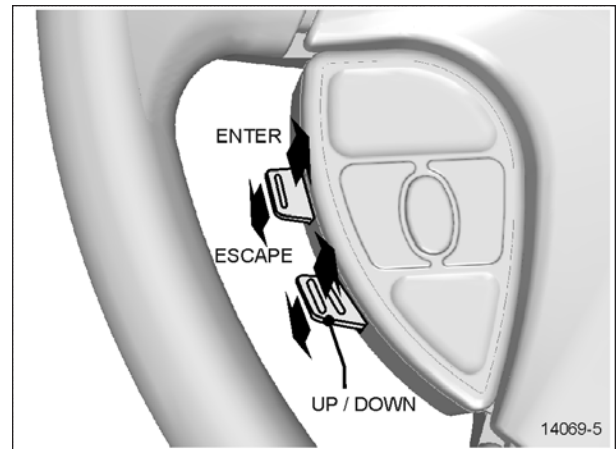

To select a menu:

1. Press the ENTER or ESCAPE button to display the list of available menus.
2. Use the UP/DOWN button to scroll up or down through the menus.
3. Use the ENTER button to open a menu.
4. Use the ESCAPE button to return to the previous menu or display or to cancel a setting or operation.

To Change Settings

To change a setting, like the clock:

1. Use the UP/DOWN button to increase or decrease the numerical value of the selected

range.

2. Use the ENTER button to confirm your choice and to move to the next field.
3. Press the ESCAPE button to return to the previous field or to cancel a setting or operation.

- Push the lever away from you = ENTER
- Pull the lever towards you = ESCAPE

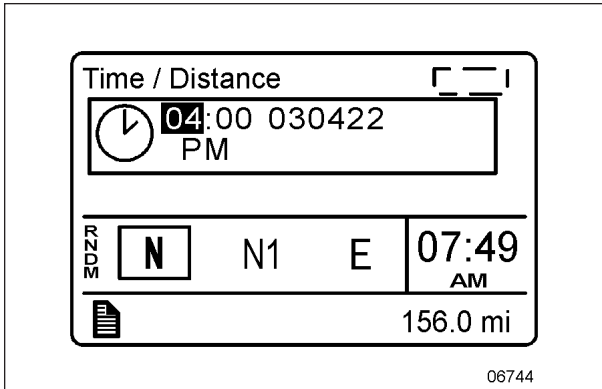

Scrolling Through The Menus Without Using The Steering Wheel Buttons

In case of failure of the steering wheel buttons, it is still possible to gain access to the menus or acknowledge the pop-up messages to return to the default display.

This alternate mode is possible only if the steering wheel buttons are faulty.

To enable the alternate mode:

1. Apply the parking brake;
2. Depress and hold the service brake pedal.

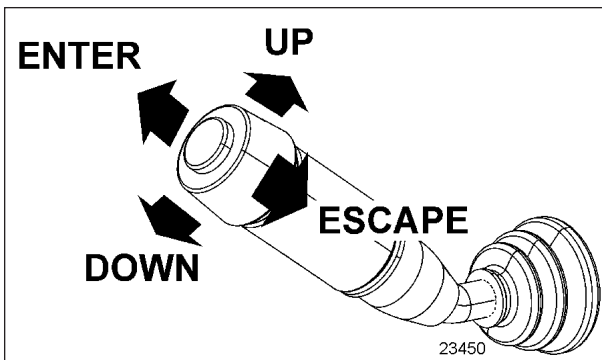

FIGURE 27: MULTI-FUNCTION LEVER

In alternate mode, use the multi-function lever as follows:

- Move the lever up = UP
- Move the lever down = DOWN

4-40 Controls and Instruments

PICTOGRAMS DISPLAYED ON THE DRIVER INFORMATION DISPLAY (DID)

NOTE

In certain situations, the pictogram displayed represents a system or a function of the vehicle. A particular pictogram may be displayed with different messages. In that situation, it is very important to pay attention to the message displayed with the pictogram.

DRIVER INFORMATION DISPLAY “GAUGES” MENU PICTOGRAMS

“GAUGES” MENU PICTOGRAMS







PICTOGRAM	DESCRIPTION
	Engine oil temperature
	Outside Air Temperature
	A/C Compressor Pressure This pictogram is displayed with A/C compressor suction pressure value (Low Side) and discharge pressure value (High Side).
	Accessories Air Pressure Normal pressure should be between 122 and 140 psi.
	Voltmeter This pictogram is displayed with both the 12-volt and 24-volt electrical system current voltage value. When the engine is running, the 24-volt electrical system voltage value should be between 26,5 and 28,0 volts.
	Transmission Oil Temperature
	Battery State of Charge This pictogram is displayed with the state of charge (%) of the 12-volt and 24-volt battery banks.



POP-UP MESSAGES

Acknowledge messages by pressing the escape (ESC) button on the steering wheel. Acknowledgement of pop-up messages and warnings stops the audible warning.

Pop-up Pictograms

PICTOGRAM	DESCRIPTION
	High Engine Oil Temperature
	Engine Coolant Temperature
CHECK ENGINE COOLANT LEVEL AT NEXT STOP	Low engine coolant level Warns the driver that the engine coolant level has reached the recovery tank low level switch. Add coolant whenever possible.
ENGINE COOLANT LEVEL CRITICALLY LOW	Critically low coolant level Warns the driver that the engine coolant level has reached the surge tank low level switch. Stop and add coolant.
	Engine Oil Pressure
	Engine Temperature Too Low for Volvo Engine Brake (VEB) Operation
	High Transmission Oil Temperature This pictogram indicates that the transmission oil temperature is too high. Turn the transmission retarder off to allow the oil to cool down.
	Allison Transmission– Oil or Filter Replacement Required This pictogram may be displayed with many different messages. Pay attention to the displayed message which can advise that the transmission oil or filter change is necessary. Refer to Appendix C for more information on the Allison transmission prognostic features (oil life monitor, filter life monitor, transmission health monitor).
	Trailer Braking System Low Air Pressure / Trailer Parking Brake This pictogram appears when the trailer emergency/parking brake is unexpectedly applied as when the vehicle is moving and a parking brake air line rupture happens.
	Low Brake Air Pressure The message associated to this pictogram is “Low System Brake Air”. Warns the driver that the brake air system pressure of the primary or/and secondary system has decreased below 85 psig. Do not drive the coach when the brake air pressure is low.

Pop-up Pictograms



TCS traction control system and electronic stability control

At vehicle ignition, the TCS icon appears for approximately 2 seconds and then disappears.

If it remains on steadily (not flashing) after ignition, or if it is on steadily while you are driving, the TCS system may not be fully functional or the operation may be completely disabled. If this happens, your vehicle will still have normal service braking and it still can be driven, although without the benefits of the TCS system.

Flashes slowly when TCS Mud/Snow mode is turned on using the Mud/Snow switch.

Flashes quickly when TCS intervenes to reduce risk of loss of control.



A/C System Pressure High

This pictogram indicates that the A/C system pressure is too high. If the A/C pressure is too high, the compressor clutch is disengaged, but the fan remains activated.

NOTE

When outside temperature is high, it is possible and normal for that pictogram to appear.



A/C System Pressure Low

This pictogram indicates that the A/C system pressure is too low. If the A/C pressure is too low, the compressor clutch disengages and the fan stops.

NOTE

When outside temperature is low, it is possible and normal for that pictogram to appear.

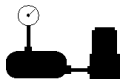

Compressor/air dryer fault

This pictogram indicates that a risk of water in the pneumatic system has been detected due to a compressor or air dryer related problems. Possible causes are:

- Compressor is used at an unusual (high) rate.
- A fault with the air system has been detected.

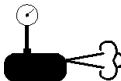

Air leakage

This pictogram indicates that an air leak has been detected in the pneumatic system.

Pop-up Pictograms



Battery Voltage Warning

This pictogram indicates that the battery voltage is too high, too low or the 12 volt / 24-volt battery arrangement is not equalized.

The value LOW or HIGH is displayed at the right of the pictogram to indicate if the voltage is too low or too high.

NOTE

This pictogram will illuminate for a few seconds after the engine is started because of the voltage drop when the starter is engaged.

NOTE

This pictogram may appear as a reminder to connect the battery charger if the ignition switch is left in the "ON" position for twenty minutes with the engine not running and parking brake set.

NOTE

To identify the battery problem (too high, too low or not equalized voltage), using the DID menus, perform a system diagnostic by selecting DIAGNOSTIC, VIEW ACTIVE FAULTS, ELECTRICAL SYSTEM and see the fault messages.

NOTE

To prevent discharge of the batteries when the engine is not running, some functions are automatically switched off if the battery voltage drops below 24.0 volts for more than 30 seconds. Set the ignition key to the OFF position and then turn the ignition key to the ON position to reactivate the functions for a period of 30 seconds before they switch off again.

NOTE

If the battery equalizer indicator illuminates, make sure that the battery equalizer circuit breakers are reset before requesting breakdown assistance. Wait 15 minutes after setting breakers to allow batteries to equalize. The breakers are located in the main power compartment.



Engine Door Ajar

This pictogram indicates that the engine compartment door is ajar.



Emergency window open

This pictogram indicates that an emergency window is open or unlocked.



Baggage Compartment Door Ajar

This pictogram indicates that one or more baggage bay doors are ajar.

4-44 Controls and Instruments

Pop-up Pictograms



Low Windshield Washer or Headlights Washer Fluid Level

Illuminates when the windshield washer or the headlight washer fluid level is low. The washer fluid containers are located inside the front service compartment.



WARNING

Do not drive without sufficient washer fluid.



Differential lock (option)

This pictogram indicates that the differential action is locked.



Freezing conditions

This pictogram appears when the temperature is in the range between 0°C and 2°C (32°F et 35°F), when the road is most slippery.



Fuel level

This pictogram appears when approximately 26 US gallons (98 liters) of fuel remains in the tank. Refuel as soon as possible.



Automatic traction control

This pictogram appears when the automatic traction control system intervenes to prevent excess wheel spin during acceleration.



Parking brake applied



DPF regeneration



High exhaust gas temperature

This pictogram appears to notify the driver of potentially hazardous exhaust gas temperature at the DPF outlet.



WARNING

During regeneration, exhaust temperature may reach up to 1200°F (650°C) at the particulate filter. When parking the vehicle, if this pictogram is displayed, make sure that the DPF outlet diffuser is away from people or any flammable materials, vapors or structures.



Fuel Economy

This pictogram is displayed with fuel consumption value of the vehicle. Proper units for the displayed value are written under the pictogram: liters/100 km, km/liter, mpg, and liters/hour.



Percentage of Trip Made Using Regenerated Electricity

This pictogram is displayed with the percentage of trip done with electricity produced with engine negative torque (braking, deceleration).

Pop-up Pictograms



Leg Fuel Consumption

This pictogram is displayed with the value for the fuel consumption for the current leg.



Trip Data

Function of the DID's "Time/Distance" menu. Refer to ["DRIVER INFORMATION DISPLAY \(DID\) MENUS" on page 11](#) in *Section 5 Other Features*.



Estimated Time of Arrival

Function of the DID's "Time/Distance" menu. Refer to ["DRIVER INFORMATION DISPLAY \(DID\) MENUS" on page 11](#) in *Section 5 Other Features*.



Fuel Filter/Water Separator

Indicates that draining of the fuel filter/water separator is required. See ["PRIMARY FUEL FILTER" on page 10](#) in *Section 8 Care And Maintenance*.



Raised tag axle

This pictogram appears if the vehicle speed exceeds 12 mph (20 km/h) while the tag axle is raised.



Cooling fans low voltage

This pictogram indicates that battery voltage is too low for proper fan operation.



Low buoy & Kneeling

This pictogram appears if the vehicle speed exceeds 12 mph (20 km/h) while the front suspension of the vehicle or the entire vehicle suspension is lowered.

Pop-up Pictograms



Fire in engine compartment

This pictogram appears if a fire is detected in the engine compartment while the vehicle is on the road. An audible alarm informs the driver when a fire is detected. In case of fire detection when parked (parking brake applied, engine running or not), the electric horn is activated to alert the driver. Refer to ["AUTOMATIC FIRE SUPPRESSION SYSTEM \(AFSS\)" on page 3](#) in Section 7 Safety Features and Equipment.



WARNING

In case of a fire, stop the vehicle immediately, stop the engine and evacuate the vehicle.

NOTE

It is possible to cancel an alarm while on the road. To do so, stop the vehicle and perform this ignition switch (key) sequence.

From the ON position, turn to OFF, return to ON and START the vehicle within two seconds.

To stop the electric horn alarm when parked, cycle the ignition between the ON and OFF position twice within 3 seconds.

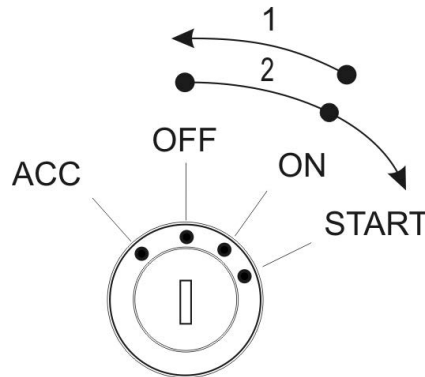

06354-6











NOTE

To stop the electric horn alarm when parked, cycle the ignition between the on and off position twice within 3 seconds.

For the location of the extinguisher, refer to ["FIRE EXTINGUISHERS " on page 2](#) in Section 7 Safety Features And Equipment.

STATUS BAR PICTOGRAMS

These pictograms will appear in the status line of the DID.

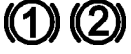
Status Bar Pictograms	
PICTOGRAM	DESCRIPTION
	Message Active
	Alarm Clock Activated
	Raised Tag Axle
	Kneeling/Front Suspension Hi-Buoy Active This pictogram appears if the vehicle speed exceeds 12 mph (20 km/h) while the front suspension of the vehicle (kneeling – solid ON pictogram) or the entire vehicle suspension is lowered (low buoy – blinking pictogram).
	Baggage Compartments Locked Confirms that all the baggage compartment doors are locked.
	Baggage Compartments Unlocked Indicates that at least one baggage compartment door is unlocked.
	Adaptive Cruise with Braking (ACB) Not Available Indicates that the Adaptive Cruise with Braking system is disabled.
	Engine Brake Engine brake is disabled (OFF mode).
	Engine Brake - Auto Mode Indicates that the engine brake is in the AUTO mode. When using this mode, the engine brake is activated when pressing on the brake pedal. The engine brake is by default set to AUTO mode when the vehicle ignition switch is cycled from OFF to ON position.
	Low Brake Air Pressure Warns the driver that the brake air system pressure of the primary or/and secondary system has decreased below 85 psig. Do not drive the coach when the brake air pressure is low.
	Engine Brake – Engine Brake Low (1) And Engine Brake High (2) Confirms which engine braking power is selected with the steering wheel control buttons.

Status Bar Pictograms



Allison Transmission Retarder

Confirms that the Allison transmission retarder is off.



Allison Transmission Retarder – Braking Level 0, 1, 2, 3, 4, 5, 6

Confirms the retarder hand lever position. Each position corresponds to a given braking level. Refer to [TRANSMISSION RETARDER](#) in this section.

TEST

Vehicle Test

Confirms that one of the vehicle test modes is active. For further information about the available test modes, refer to [DIAGNOSTICS MENU](#) in *Section 5 Other Features*.

ON BOARD DIAGNOSTIC TOOL RECEPTACLE

To ease troubleshooting, you can connect a diagnostic tool through the OBD receptacle to access recorded data. The OBD receptacle is located under the dashboard, on the left side.

AUTOMATIC FIRE DETECTION AND SUPPRESSION SYSTEM (AFSS)

The vehicle is equipped with an Automatic Fire detection and Suppression System (AFSS).

AUTOMATIC FIRE SUPPRESSION SYSTEM PANEL

The panel displays the current system status. The protection panel contains “SYSTEM OK”, fire “ALARM” and “TROUBLE” lamps, the audio alarm, the “TEST/RESET” switch, and the “ALARM SILENCE” switch.

The “SYSTEM OK” lamp indicates power is on the system and that there is no trouble conditions present. The “TROUBLE” lamp blinks if there is a fault in the detection circuitry and illuminates solid if there is a fault in the extinguishing circuitry. When the “TROUBLE” lamp is on, the “SYSTEM OK” lamp will be off and the audible alarm will sound intermittently. The “SYSTEM OK” lamp will flash when the system is low on battery power. Depressing the “TEST/RESET” switch tests the protection panel lamps and audio alarm. The “ALARM SILENCE” switch will disable the audio alarm.

When a fire detector automatically detects a fire, the fire “ALARM” lamp and audio alarm activate. When the Manual Activation Switch is activated, the fire “ALARM” lamp blinks and the audio alarm activates. The lamp will blink until power is cycled to the system.

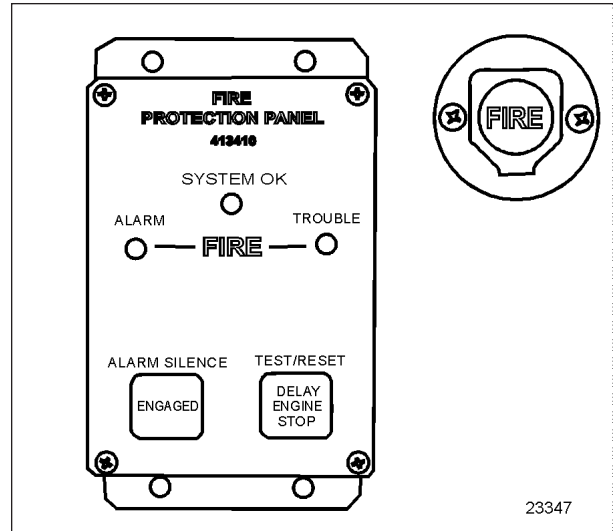

FIGURE 28: AFSS PANEL & MANUAL ACTIVATION SWITCH

Manual Activation Switch

The manual activation switch allows immediate system activation (extinguisher discharge and engine shutdown) by the driver at any time. Activation of the switch is accomplished by twisting and pulling the tamper seal to remove, lifting the cover and pressing the red “FIRE” button for more than half a second. After the manual activation switch has been activated, the protection panel will blink the fire “ALARM” indicator until power has been cycled to the system.

Refer to [“AUTOMATIC FIRE SUPPRESSION SYSTEM \(AFSS\)” on page 3](#) in *Section 7 Safety Features and Equipment* for more information.

CRUISE CONTROL

The cruise control allows you to cruise the vehicle at a desired speed over 30 mph (50 km/h) without having to use the accelerator pedal.

4-50 Controls and Instruments

TURNING THE SYSTEM ON

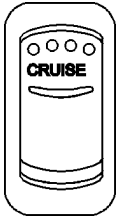

To operate the cruise control, press the CRUISE rocker switch located on the lateral control panel to the ON position. This turns the system on. The dashboard telltale turns on; you can now set the vehicle at a desired cruising speed. To turn off the system, press the rocker switch to the OFF position.

NOTE

The cruise switch and RESUME button do not operate at speeds below 30 mph (50 km/h).

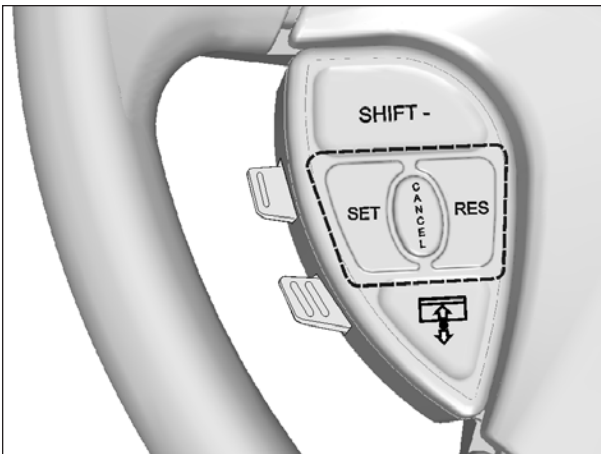

FIGURE 29: CRUISE CONTROL BUTTONS

SETTING A CRUISING SPEED

Accelerate the vehicle to the desired cruising speed using the accelerator pedal. Press and release the SET button then remove foot from the accelerator pedal. This will set the vehicle cruise speed and store it in memory. The set speed will appear in the driver information display.

Increasing Set Speed

The vehicle cruise speed setting can be increased by one of the following methods.

1. Accelerate using the accelerator pedal until the desired cruising speed is reached. Press and release the SET button.

or

2. Press and hold the RES (RESUME) button until the desired cruising speed is reached. When the RES button is released, the new cruising speed will be stored in the cruise control memory.

or

3. When driving with cruise control, each time the RES button is momentarily depressed, the cruising set speed is raised by 1 mph (2 km/h).

NOTE

When driving with cruise control, the vehicle can still be accelerated by depressing the accelerator pedal in the usual manner. Once the accelerator pedal is released, the vehicle will return to the previously set cruising speed.

Decreasing Set Speed

The vehicle cruise speed setting can be decreased by one of the following methods.

1. Press and hold the SET button until the desired cruising speed is reached. When the SET button is released, the new cruising speed will be stored in the cruise control memory.

or

2. Each brief pressing of the SET button will decrease set cruising speed by 1 mph (2 km/h).

or

3. Slightly apply the service brake and when desired cruise speed is reached, press and release the SET button.

Canceling The Set Speed

You can cancel the set cruising speed by:

1. Pressing momentarily the CANCEL button;
2. Depressing the brake pedal.

Automatic Cruise Control Cancellation

The set speed is automatically canceled in any of the following situations:

- The windshield wipers are operating in low or high speed;
- The actual vehicle speed falls below 30 mph (50 km/h).

Resuming Set Speed

If the set speed is canceled by pressing the CANCEL button or depressing the brake pedal, pressing the RES (RESUME) button will restore the speed set prior to cancellation, providing that your speed is above 30 mph (50 km/h).

NOTE

When driving downhill with the cruise control on and set, the engine brake or the transmission retarder engage automatically (if previously activated) when the selected cruise speed is exceeded by approximately:

- 4 mph (7 km/h) with the engine brake activated;
- 0.6 mph (1 km/h) with the transmission retarder activated.

The engine brake or the transmission retarder is then disengaged when speed has returned near to selected cruise speed.

The engine brake will provide low braking power or high braking power depending on which of the two steering wheel engine brake control buttons is activated;

① = Engine Brake Low

② = Engine Brake High

The transmission retarder maximum braking level is determined by the retarder hand lever position on the steering wheel.

NOTE

To avoid sudden vehicle hesitation, slightly depress the accelerator pedal before disengaging the cruise control.

NOTE

When the CRUISE rocker switch is released, the cruise control is completely shut off and the cruise speed setting is erased from the cruise control memory.

NOTE

If the engine was stopped and the CRUISE rocker switch was in the ON position, the rocker switch must be reset by turning it OFF then ON again in order for the cruise control to be reactivated.



WARNING

Do not use the cruise control when driving speed must be constantly adjusted, such as in heavy traffic or on icy, snow-covered or slippery roads, or on gravel roads.



WARNING

Do not put the transmission in the neutral (N) position while driving with cruise control. This may cause the engine to over-speed and result in a loss of driving control.

4-52 Controls and Instruments

PREVOST DRIVER ASSIST™

Prevost Driver Assist™ provides what is commonly known in the automotive industry as Advanced Driver Assistance Systems (ADAS). ADAS are meant to assist but not replace the driver. ADAS must be monitored at all times.



WARNING

Even with Prevost Driver Assist™ system, the driver must remain alert, react appropriately and in a timely manner, and use good driving practices. Ultimate responsibility for the safe operation of the vehicle remains with the driver at all times.

Be certain that you have read all safety warnings found in **Bendix Wingman Fusion Operator's Manual BW2681** available on Prevost Technical Publications site or your Technical Publications USB key.

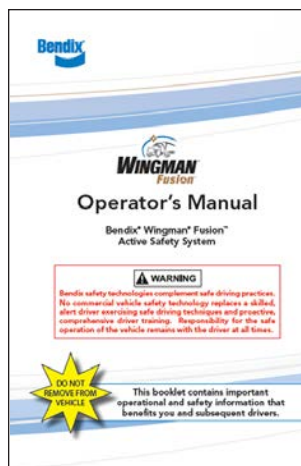

ASSOCIATED HARDWARE/EQUIPMENT

- FLR-21 radar sensor (ACB)
- Head-up display (HUD)
- Lane Departure Warning System (LDW) enable/disable switch
- FLC-20 windshield forward-looking camera (LDW)
- Bendix ESP EC-80 Controller
- Instrument panel DID (telltale and warning popups)

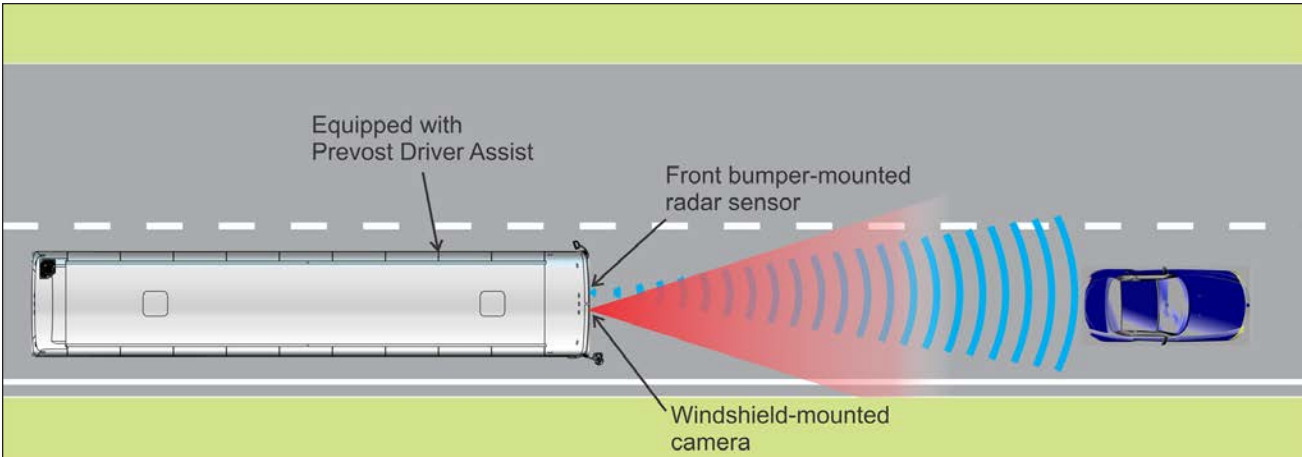

FIGURE 30: PREVOST DRIVER ASSIST™ SYSTEM USES A CAMERA AND RADAR SENSOR

PREVOST DRIVER ASSIST™ CONSISTS OF THE FOLLOWING SYSTEMS AND FEATURES

DRIVING CONTROL ASSISTANCE	
Adaptive Cruise with Braking ACB	Assists with acceleration and/or braking to maintain a prescribed distance between your vehicle and the vehicle ahead in your lane of travel. <ul style="list-style-type: none"> • FDA Following Distance Alert • IA Impact Alert
COLLISION WARNINGS	
Lane Departure Warning LDW	Alerts the driver as the vehicle unintentionally approaches or crosses lane markers.
Head-Up Display HUD	Projects a visual forward collision warning into the driver's forward line of sight.
COLLISION INTERVENTION	
Forward Collision Mitigation FCM	Detects potential collision with stationary or moving vehicles in the lane ahead while the vehicle is traveling forward, provides forward collision warning and automatically applies the brakes to lessen the severity of an impact. <ul style="list-style-type: none"> • SVB Stationary vehicle braking

4-54 Controls and Instruments

FEATURES	ACTIVE EVEN IF ACB IS OFF OR CRUISE SPEED NOT SET
FDA Following Distance Alert (warnings only)	Yes If speed above 36 mph (58 km/h)
IA Impact Alert (warnings only)	Yes If speed above 15 mph (24 km/h)
LDW Lane Departure Warning	Yes If speed above 36 mph (58 km/h)
FCM Forward Collision Mitigation (including SVB Stationary Vehicle Braking) (warnings & braking)	Yes If speed above 15 mph (24 km/h)



WARNING

The PrevoSt Driver Assist™ system reacts **ONLY** to vehicles that are **stationary or moving in the same direction as your vehicle**.

The PrevoSt Driver Assist™ system **DOES NOT** respond to side-to-side moving traffic, or oncoming traffic. The system will not slow your vehicle or provide an alert as you approach vehicles in these circumstances.

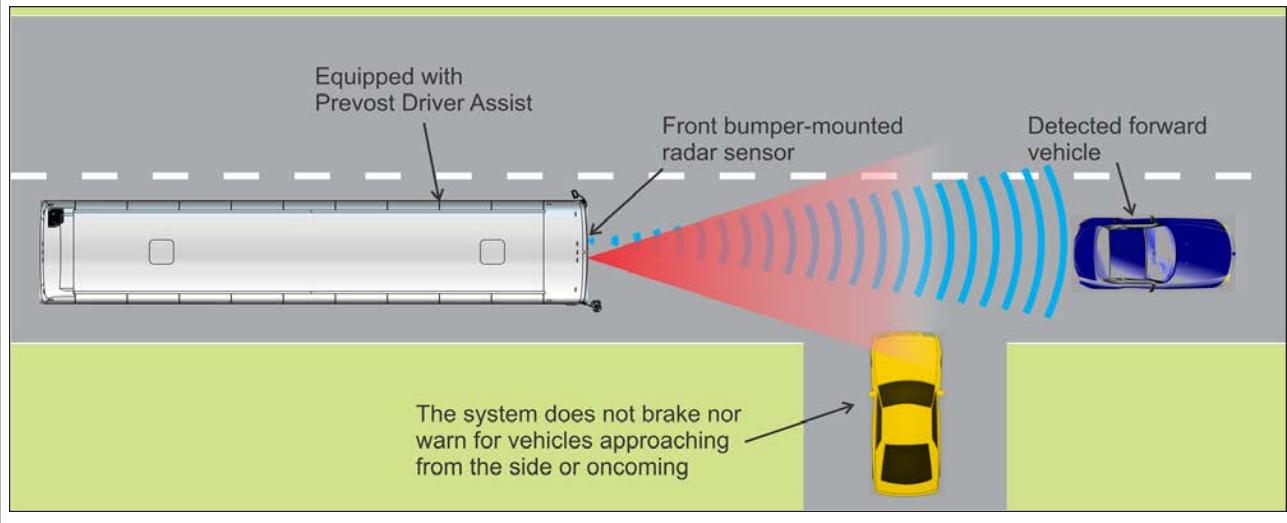

POTENTIALLY CHALLENGING SITUATIONS FOR THE PREVOST DRIVER ASSIST™ SYSTEM

The following examples illustrate situations that may issue an alert or braking in a manner not consistent with your expectations. The Prevost Driver Assist™ system may unexpectedly issue warnings, apply braking, or not respond.

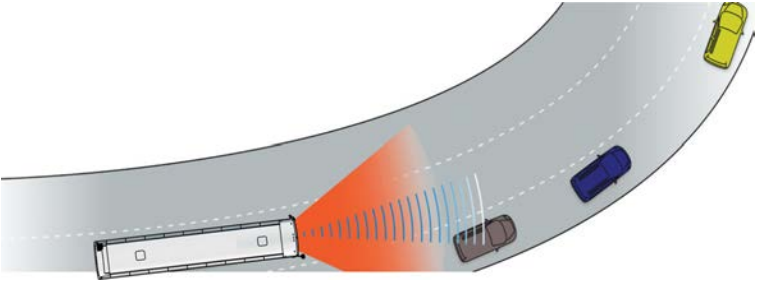
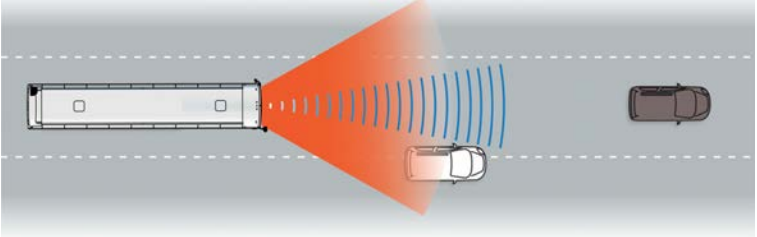
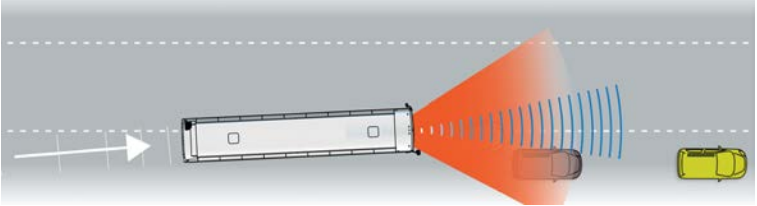
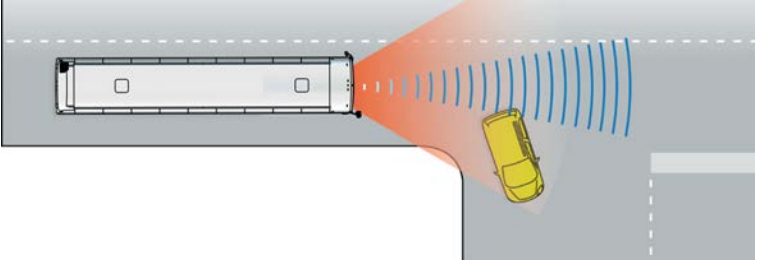
CHALLENGING SITUATION EXAMPLES	
	<p>Driving through a curve or an exit ramp</p>
	<p>Other vehicles partially inside your lane of travel</p>
	<p>Lane changes</p>
	<p>Turning vehicles</p>

LANE DEPARTURE WARNING LDW

Using the FLC-20 windshield forward-looking camera, the Lane Departure Warning system (LDW) monitors the vehicle position in its lane and alerts the driver as the vehicle unintentionally approaches or crosses lane

4-56 Controls and Instruments

markers thru audible and visual warnings. **The driver should immediately correct the vehicle tracking and maintain position in the lane.**

When changing lanes, the driver must use the turn signals.

LDW Activation

The Lane Departure Warning system is active whenever the vehicle is traveling above 36 mph (58 km/h). LDW is active no matter if the ACB is OFF or speed not set.

Temporarily Disabling The Lane Departure Warning (LDW)



To avoid erroneous LDW warnings in areas such as the work zone where the road markings present might cause false alerts, LDW system can be disabled by the driver using the enable/disable switch. LDW system will reactivate automatically after a delay of 15 minutes or a transition from OFF to ON of the ignition key or upon pressing of the enable/disable switch a second time.



FIGURE 31: LDW ENABLE/DISABLE SWITCH

LDW Status Line Pictograms Description





The following pictograms appear in the DID status line to confirm that the system is active and currently tracking the driving lane.

PICTOGRAM	DESCRIPTION
	Actively tracking lane markings on both sides of current lane
	Currently tracking lane marking on the left side only
	Currently tracking lane marking on the right side only







The following pictogram appears in the DID status line to warn that the system IS NOT currently tracking the driving lane.

PICTOGRAM	DESCRIPTION
	LDW system initializing during the start-up or tracking not available
none	If none of the LDW status pictograms appear on the DID status line and the driver has not pressed the LDW enable/disable switch, this indicates that the system using the FLC-20 forward-looking camera has detected a DTC (diagnostic troubleshooting code) and the system should be serviced at the earliest opportunity.

LDW Popup Messages Definition

POPUP MESSAGE	DESCRIPTION/AUDIBLE ALARM
 <p data-bbox="375 695 638 764">Lane departure Warning System Enabled</p>	LDW system enabled – the LDW system is currently tracking the driving lane.
 <p data-bbox="399 915 638 984">Lane Departure Warning System Disabled</p>	LDW system disabled – the LDW system IS NOT currently tracking the driving lane.
 <p data-bbox="391 1146 646 1283">Right Side Lane Departure Imminent</p>	The vehicle is about to cross the right lane marker. audible warning: TOK – TOK
 <p data-bbox="386 1434 641 1570">Left Side Lane Departure Imminent</p>	The vehicle is about to cross the left lane marker. audible warning: TOK – TOK
 <p data-bbox="386 1696 602 1766">Malfunction Forward Imager</p>	Indicates a malfunction of the forward-looking camera. The LDW system tracking might be disabled or not reliable. The driver can acknowledge and turn off this popup message using Esc (escape) button on the steering wheel.

4-58 Controls and Instruments

 <p>Malfunction Check camera for obstructions</p>	<p>Indicates a malfunction of the LDW system camera. The LDW system tracking might be disabled or not reliable.</p> <p>Stop the vehicle and check if something is obstructing the camera.</p> <p>The driver can acknowledge and turn off this popup message using Esc (escape) button on the steering wheel.</p>
 <p>Malfunction Brake Switch</p>	<p>Indicates a malfunction of the LDW system brake switch. The LDW system tracking might be disabled or not reliable.</p> <p>The driver can acknowledge and turn off this popup message using Esc (escape) button on the steering wheel.</p>
 <p>Malfunction Turn Signal</p>	<p>Indicates a malfunction of the directional turn signals. The driver can acknowledge and turn off this popup message using Esc (escape) button on the steering wheel.</p>
 <p>Input switch stuck low</p>	<p>Indicates a malfunction of the LDW system input switch.</p> <p>The driver can acknowledge and turn off this popup message using Esc (escape) button on the steering wheel.</p>
 <p>Network Error</p>	<p>Indicates a loss of communication on the vehicle data network. The LDW system tracking might be disabled or not reliable.</p> <p>The driver can acknowledge and turn off this popup message using Esc (escape) button on the steering wheel.</p>
 <p>Unknown Vehicle Speed</p>	<p>Indicates the current vehicle speed is unknown. The LDW system tracking might be disabled or not reliable.</p> <p>The driver can acknowledge and turn off this popup message using Esc (escape) button on the steering wheel.</p>
 <p>Lane Departure Warning System Malfunction</p>	<p>Indicates a malfunction of the LDW system. The LDW system tracking is not available.</p>

FORWARD COLLISION MITIGATION FCM

The Forward Collision Mitigation system (FCM) detects potential collisions while the vehicle is traveling forward, provides warnings to the driver and when needed, automatically applies up to 66% of the braking power to lessen the severity of an impact.

The FCM system is ready to intervene whenever the vehicle is traveling at speed above 15 mph (24 km/h). It operates independently of the vehicle ACB and will intervene even if the cruise control is turned off or there is no cruise set speed.

The FCM system is enhanced with the use of the FLC-20 windshield forward-looking camera. This camera increases the performance of the collision mitigation system by visually detecting a forward object as a vehicle and confirming with the ACB radar sensor its position within the lane of travel. With this increased object recognition capability, the system is able to detect stationary vehicles.

If the forward vehicle is stationary, the FCM system will apply up to 66% of the braking power. The maximum speed reduction is about 25 mph / 40 km/h. Note that this feature will not bring the vehicle to a complete stop.

Stationary Vehicle Braking SVB

SVB typically available above 15 mph (24 km/h). As part of the collision mitigation system, when a large, stationary, metallic object in a vehicle's lane of travel is definitively identified as a vehicle (thru FLC-20 camera), the driver is notified up to 3.5 seconds before impact. If the driver does not take action to address the potential impact that caused the alert, the FCM system can automatically engage the brakes to assist the driver in reducing the severity or potentially avoiding a collision with that stationary vehicle.

If the system cannot definitively identify the stationary object as a vehicle — for example, if the vehicle is not a licensed motorized vehicle, or certain types of trailers — the driver will get up to 3.0 seconds of alert to address the situation ahead, but no automatic braking will be applied. SVB is most useful when approaching a line of stopped traffic or a stalled vehicle that is not immediately recognized by the driver.

The SVB is ready to alert the driver whenever the vehicle is moving above 15 mph (24 km/h). The driver should be especially careful when approaching certain types of vehicles or objects. The system radar sensor may not be able to detect vehicles with limited metal surfaces (such as recreational vehicles, horse-drawn buggies, motorcycles, logging trailers, etc.). NOTE: Entering a curve may reduce the alert time.



CAUTION

Pedestrians, Animals, Non-metallic, or Limited-metallic Objects

The Prevost Driver Assist™ system **will not** warn or react to pedestrians, animals, and non-metallic objects. The system may not warn or react to limited-metallic objects (such as recreational vehicles, horse-drawn buggies, motorcycles, logging trailers, etc.).

Head-Up Display HUD

The FCM system is enhanced with a Head-Up Display (HUD) LED warning. The HUD project an intensive red light that is reflected in the windscreen to warn the driver when the FCM detects potential collision.

HUD Diagnostic: At startup, the HUD warning LED shall be diagnosed for failures such as open circuit, short to battery and short to ground. This shall be performed by activating the LED for a short time.

4-60 Controls and Instruments

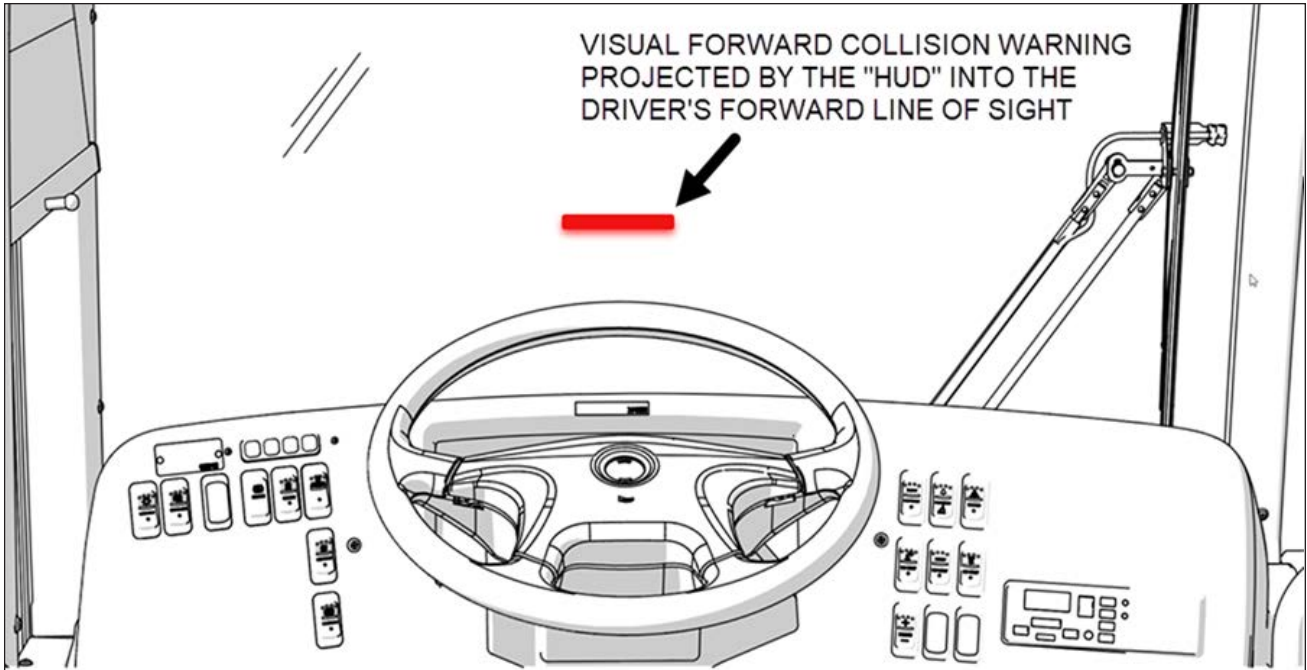

FIGURE 32: HEAD-UP DISPLAY PROJECTED VISUAL WARNING

ADAPTIVE CRUISE WITH BRAKING ACB

Adaptive Cruise with Braking (ACB) is a cruise control that not only maintains the set speed, but will also intervene, as needed, to help the driver maintain a set following distance behind a detected forward vehicle by reducing speed as necessary. As soon as the forward vehicle is at a safe distance, the coach will resume to the cruise set speed.

NOTE

The following paragraphs briefly sum up the information concerning the operation and function of the ACB. Before driving the vehicle, be certain that you have read and that you fully understand each step of the driving and handling information found in Bendix Wingman Fusion Operator's Manual BW2681. The driver should fully understand all the audible alerts and visual indicators that the system provides. Bendix Wingman Fusion Operator's Manual BW2681 (available on Prevest web site and included on the Technical Publications USB key).



WARNING

Even with ACB, the driver must remain alert, react appropriately and in a timely manner, and use good driving practices. Ultimate responsibility for the safe operation of the vehicle remains with the driver at all times.

Be certain that you have read all safety warnings found in Bendix Wingman Fusion Operator's Manual BW2681.

The driver will benefit all the audible and visual warnings that the system provides whether or not ACB is turned on. In addition to the audible and visual warnings, when the ACB is turned on and a **cruise speed is set**, the driver benefits from active interventions like engine throttle reduction, engine brake application and service brake application **to help maintain a set following distance**.

**WARNING**

Adaptive Cruise with Braking must be used only in the same conditions that are normally recommended for ordinary cruise control. Refer to “Regular Cruise Control” paragraph.

TURNING OFF THE ACB SYSTEM

You can turn off the ACB system, simply by applying service brakes, setting the CRUISE rocker switch to the OFF position or pressing the cruise control CANCEL button on the steering wheel.

NOTE

Whenever the service brakes are applied by intervention of the ACB or by the driver, normal cruise will automatically be canceled. The driver must resume or set the cruise mode in order for the vehicle to throttle up.

TURNING THE ACB SYSTEM ON

Activation of the Adaptive Cruise with Braking is similar to the regular cruise control activation. Press the CRUISE rocker switch to the ON position, accelerate the vehicle to the desired cruising speed and then, press the SET button. ACB is now engaged with the set following distance and driver warning features. Whenever the cruise control is engaged, the ACB is also engaged. You cannot engage the cruise control alone, without engaging the ACB features.

MAINTAINING A SET FOLLOWING DISTANCE

Using a radar sensor mounted to the front bumper, the ACB system measures the distance between the coach and the forward vehicle and intervenes to help maintain a safe set following distance behind the vehicle. This feature engages automatically once the driver turns on and sets cruise speed.

Following distance refers to the time gap, measured in seconds, between the coach and the vehicle ahead. The actual physical distance between the coach and the vehicle ahead will vary based on your set cruise speed; although the set time gap remains the same for all set cruise speeds. Prevost’s default set time gap is 1.7 seconds.

With cruise control engaged and a cruise speed set, you are maintaining a set following distance behind the vehicle in front of you (The system DOES NOT respond to side-to-side moving traffic or oncoming traffic.).

If the vehicle in front of the coach slows down below your cruise control set speed, the system will progressively intervene as follows, in this order:

1. Reduce the engine throttle;
2. Apply the engine brake;
3. Apply about 30% of the service brakes available braking power in an attempt to maintain the set following distance.

The driver must apply additional braking power when required, to avoid collision or to maintain a safe distance from the vehicle ahead.

NOTE

If the ACB is actively decelerating or braking the coach in an attempt to maintain the set following distance at the moment when the driver cancels the ACB system, the ACB system will continue deceleration or braking intervention until a safe following distance is established, then will cancel.

Even though the cruise control doesn’t operate at speeds below 30 mph (50 km/h), the ACB system will continue deceleration or braking intervention in an attempt to maintain the set following distance if the coach speed reduces to less than 30 mph (50 km/h).

4-62 Controls and Instruments

If the vehicle ahead slows below your cruise control's set speed, but then accelerates away, and the ACB system did not need to use the service brakes as it managed the intervention, the coach will automatically accelerate back to the original cruise control set speed, and again maintain a set following distance behind the forward vehicle.

NOTE

The maximum radar range is approximately 500 feet (150 meters). Rain, snow, fog, ice and other severe weather conditions may affect the performance of the ACB system and shorten radar range.



As part of your pre-trip vehicle inspection, check to see that there is no mud, snow, ice build-up or other obstruction in front of the radar sensor. You should inspect the radar sensor mounting and remove any obstruction that may impair the sensor functioning.

DRIVER WARNINGS

Before using the ACB, the driver should fully understand all the audible and visual warnings that the system provides. Any audible warning (beeping or tone) means that your vehicle is too close from the vehicle ahead.

DASHBOARD TELLTALE

When ACB is turned on and a cruise speed is set, if the forward vehicle is detected (in range) by the radar, the FORWARD VEHICLE DETECTED telltale light will illuminate. This is an indication to the driver that the forward vehicle is being tracked, that the ACB is actively managing the distance between the coach and the vehicle ahead and that the ACB system may automatically intervene to maintain the set following distance. There are three types of warnings with this telltale light.

FORWARD VEHICLE DETECTED telltale light	COLOR	DESCRIPTION
	green	The forward vehicle is detected (in range)
	red flashing	Impact alert. The forward vehicle is too close to follow safely or a metallic stationary object such as a stopped or stalled vehicle in your lane of travel is detected. The driver must intervene to avoid a collision.
	red solid	ACB system malfunction. The ACB system and the alert functions are not available.

SPEEDOMETER LED

With the cruise control engaged and a cruise speed set, a green LED illuminates above the cruise control set speed on the speedometer.

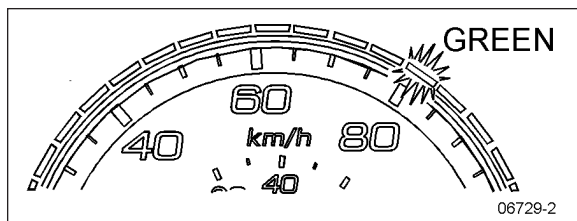

FIGURE 33: THE CRUISE SET SPEED IS 80 KM/H

With a cruise speed set, the vehicle ahead slows moderately. The system will display to the driver the approximate speed of the vehicle ahead with yellow LEDs above the speedometer.

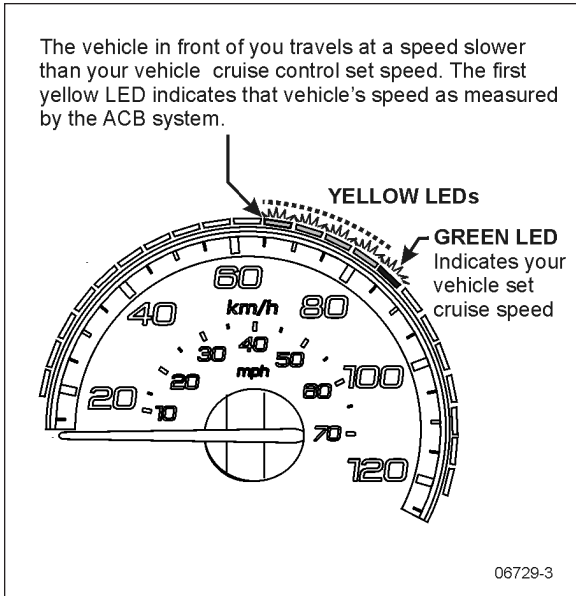

FIGURE 34: EXAMPLE OF THE SPEEDOMETER LED DISPLAY WHEN THE FORWARD VEHICLE IS SLOWER WHILE THE COACH TRAVELS WITH THE ACB CRUISE CONTROL ON AND SET

FOLLOWING DISTANCE ALERT (FDA)

Following Distance Alert is always active whenever the coach is moving to a speed greater than 36 mph (58 km/h), whether or not ACB is turned on.

Following Distance Alert provides both audible and visual warnings whenever the distance between the coach and the forward vehicle is less than the set distance and getting closer. Once the audible warning is given, the driver must increase the distance between the coach and the vehicle ahead until the audible warning stops or maneuver clear of the forward vehicle.



WARNING

Active interventions of ACB to maintain safe following distance (throttle reduction, engine brake application, service brakes application) are only operational when the ACB is engaged with a cruise speed set.

IMPACT ALERT (IA)

Impact Alerts are always operational when the vehicle is moving above 15 mph (24 km/h) whether or not ACB is turned on.

The Impact Alert warning is the most severe warning issued by the ACB system. This alert indicates that the driver must take immediate evasive action by applying more braking power and/or steering clear of the vehicle ahead to potentially avoid or lessen the severity of a collision. **Collision Mitigation Braking CMB** applies vehicle braking to help avoid or lessen the severity of a collision with a forward vehicle.

The Impact Alert is also applicable to stationary metallic objects such as stopped or stalled vehicles. This alert provides a warning given up to 3.0 seconds before a potential collision with a stationary metallic object in the coach's lane of travel. The driver can either slow down or maneuver in an attempt to avoid the object.

The Impact Alert will only warn and will not actively decelerate or brake the coach when approaching stationary objects.

4-64 Controls and Instruments



WARNING

Active interventions of ACB to maintain safe following distance (throttle reduction, engine brake/retarder application, service brakes application) are only operational when the ACB is engaged with a cruise speed set.

BRAKE OVERUSE WARNING





ACB provides a warning when the system is intervening and using the service brakes excessively. Overuse of the foundation brakes can lead to the brakes overheating and a potential loss of braking performance from brake fade. For example, the use of ACB on downhill runs may cause this alert to be activated. It is recommended that ACB be disengaged on downhill grades. The driver should use appropriate gearing and brake techniques, and not rely on ACB, on downhill grades.

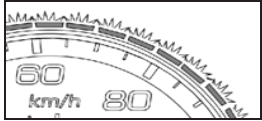
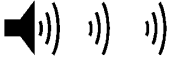

If the driver does not respond to the Brake Overuse Warning after a brief delay, the ACB will switch off.

FOLLOWING DISTANCE ALERT

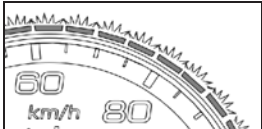
CONDITION	The Following Distance Alert feature is only available when the coach speed is greater than 36 mph (58 km/h), whether or not ACB is engaged.	
	The forward vehicle is slowing down and the distance between your vehicle the coach and the forward vehicle is less than the set distance.	
ACTIONS BY ACB SYSTEM	<p>“Distance Alert” pop-up message appears on the DID</p> <p>The speedometer LEDs illuminate in red</p> <p>If the vehicles remain too close from each other for more than 15 seconds, an audible warning will sound (beeping)</p>	  

IMPACT ALERT

SITUATION	ACB system detects a risk of collision with a forward-moving vehicle or a stationary metallic object in your lane of travel.	
ACTIONS BY ACB SYSTEM	<p>On the dashboard, the Forward Vehicle Detected telltale flashes in red</p> <p>“Impact Alert” pop-up message appears on the DID</p> <p>The speedometer LEDs flash in red</p> <p>An audible warning will sound (continuous modulating tone)</p>	   

BRAKE OVERUSE WARNING	
SITUATION	ACB system is using the service brakes excessively to maintain the set following distance (for example, the use of ACB on long, steep downhill runs). Excessive application of the service brakes can cause the brakes to overheat resulting in increasing stopping distances.
ACTIONS BY ACB SYSTEM	<p>After a brief delay, the ACB system will stop functioning and be disabled.</p> <p>On the dashboard, the Forward Vehicle Detected telltale illuminates in red</p> <div style="text-align: right;"></div> <p>“ACB/Cruise Temporarily Disabled Brake Overuse” pop-up message appears on the DID</p> <div style="text-align: right; border: 1px solid black; padding: 5px; width: fit-content; margin: 0 auto;"> <p style="text-align: center;">ACB / Cruise Temporarily Disabled Brake Overuse</p> </div> <p>“ACB Not Available” pictogram appears on the DID status line</p> <div style="text-align: right;"></div>

SELF-DIAGNOSTIC AT START-UP

Initiate the self-diagnostic as follows:

- The engine must be running since at least 15 seconds with the parking brake applied.
- Trip the CRUISE rocker switch located on the lateral control panel from OFF to ON position.

The following sequence will begin:

1. Pop-up message “Impact Alert” will show in the DID;
2. The speedometer LEDs will flash in red;
3. FORWARD VEHICLE DETECTED telltale will flash in red;
4. The Impact Alert audible alarm will sound.

At the end of the self-diagnostic sequence, pop-up message « ACB SELF-CHECK OK » will show on the DID if the system functions properly or « ACB SELF-CHECK NOT OK » if a fault condition is detected.

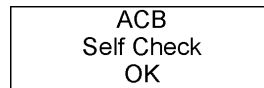
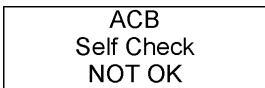

SYSTEM MALFUNCTION

In case of system malfunction, visual warnings will illuminate in the instrument cluster or the driver information display to warn the driver that the ACB is disabled. In that situation, the Impact Alert and Distance Alert functions are not available.

If the ACB is not available, the FORWARD VEHICLE DETECTED telltale light will illuminate in red and will stay on and “ACB NOT AVAILABLE” pictogram will appear on the DID status line.



FORWARD VEHICLE DETECTED telltale light



ACB NOT AVAILABLE pictogram

4-66 Controls and Instruments

For proper functioning of the system, the radar must be perfectly aligned and not blocked. If a radar fault condition is detected, one of the following pop-up messages will show in the DID.

ACB RADAR MISALIGNMENT

ACB RADAR FAULT

ACB RADAR DATA LINK FAILURE

ACB RADAR BLOCKED

WHAT TO EXPECT WHEN USING THE PREVOST DRIVER ASSIST™ SYSTEM

PART 1 All driving scenarios (cruise control is either ON or OFF)		
What to Expect		
Situation	Typical system indication/alerts	Typical system actions/cautions
Stationary objects/vehicles ahead in your lane of travel		
A stationary (non-vehicle) object is present ahead in the lane in which the truck is traveling.	none	The driver must immediately act to potentially avoid, or lessen the severity of, a collision.
A stationary motor vehicle is detected ahead in your lane. <i>Factors that can potentially affect the system's ability to identify a vehicle include: if the vehicle is not a licensed motorized vehicle; or certain types of trailers.</i>	If the vehicle is traveling above 10 mph / 16 km/h, a stationary vehicle alert may be issued up to three-and-a-half (3.5) seconds prior to impact.	The driver must immediately act to potentially avoid, or lessen the severity of, a collision. If a collision is likely to occur, Prevost Driver Assist™ system can provide a warning and/or apply the vehicle service brakes.
Moving objects/vehicles ahead in your lane of travel		
Your vehicle comes up fast behind a slower-moving detected forward vehicle.	The Following Distance Alert (FDA) will sound and a visual message typically appears on the DID. Depending on how close your vehicle approaches, the system may initiate an Impact Alert (IA) warning.	None. You must respond as needed.
The detected forward vehicle slows rapidly.	The Following Distance Alert (FDA), or Impact Alert (IA) warning (continuous tone) will sound and a visual message typically appears on the DID.	None. You must respond as needed. If a collision is likely to occur, the collision mitigation feature will apply your vehicle's brakes.
A pedestrian, deer, or dog runs in front of your vehicle, or any organic or non-metallic object is in front of your vehicle.	None	None. You must respond as needed.

Controls and Instruments 4-67

Another vehicle crosses the road perpendicular to your path of travel – such as intersections.	None	None. You must respond as needed.
A collision mitigation braking event has begun and you, as the driver, steers into an adjacent lane to avoid the forward vehicle.	None	Prevost Driver Assist™ system will continue to apply the brakes if it detects another vehicle ahead in the new traffic lane posing a threat.
Lane Departure Warning System Active (LDW pictogram being displayed)		
Your vehicle signals a lane change and crosses a lane marking.	None	None
Traveling below 36 mph (58 km/h), your vehicle crosses a lane marker (without the corresponding turn signal activated).	None	None. You must respond as needed.
Traveling above 36 mph (58 km/h), your vehicle departs your lane of travel without the corresponding turn signal activated.		None. You must respond as needed. (use the turn signal when changing lanes and/or keep your vehicle within the lane markings).
PART 2 ACB cruise control is ON and speed is SET		
What to Expect		
Situation	Typical system indication/alerts	Typical system actions/cautions
Interactions with vehicles ahead in your lane of travel		
With no detected forward vehicle.	None	Your vehicle maintains the set speed.
With a detected forward vehicle.	The cruise control ON indicator is illuminated and the detected forward vehicle telltale is illuminated.	The Adaptive Cruise with Braking feature will maintain the set speed and following distance.
The detected forward vehicle slows moderately.	The Following Distance Alert (FDA) will sound and a visual message typically appears on the DID.	You must respond as needed. If the system intervenes, the vehicle throttle will be reduced; the engine retarder engaged; and the service brakes applied, in that order to maintain the set following distance. <i>NOTE: When the ACB applies the service brakes, cruise control will automatically pause, and will cancel if vehicle speed falls below the minimum set speed or the driver manually depresses the brake pedal.</i>

4-68 Controls and Instruments

The detected forward vehicle slows rapidly.	The Impact Alert (IA) warning will sound and a visual message typically appears on the DID. The Following Distance Alert may also be heard.	You must respond as needed. If the system intervenes, the vehicle throttle will be reduced; the engine retarder engaged; and the foundation brakes applied, in that order to maintain the set following distance. <i>NOTE: When the ACB applies the foundation brakes, cruise control will automatically pause, and will cancel if vehicle speed falls below the minimum set speed or the driver manually depresses the brake pedal.</i>
A detected forward vehicle cuts in front of your vehicle and speeds away.	Following Distance Alerts (FDAs) may be given to you, depending on the exact system configuration that has been set for the vehicle, and how close the vehicle cuts in front.	Vehicle maintains set speed.
Downhill Grades		
Going down a grade with a detected forward vehicle.	DO NOT USE cruise control on downhill grades.	DO NOT USE cruise control on downhill grades. Brake overuse may occur.
Cruise control should NOT be used on downhill grades.		



WARNING

The section preceding shows examples of situations and typical Prevest Driver Assist™ system responses. However, the chart does not attempt to cover all possible situations.

Due to the inherent limitations of radar and camera technology, the enhanced Collision Mitigation Technology – on rare occasions – may not detect moving vehicles or stationary vehicles in your vehicle's lane of travel. Alerts, warnings, or brake interventions may not occur.

Due to the inherent limitations of radar and camera technology, the enhanced Collision Mitigation Technology – on rare occasions – may react to moving vehicles not in your vehicle's lane of travel. Alerts, warnings, or brake interventions may occur.

HOW YOUR ACTIONS IMPACT THE PREVOST DRIVER ASSIST™ SYSTEM

Your Action	Reactions of the Prevest Driver Assist™ system
If you, the driver, do this:	Expect the Prevest Driver Assist™ system to do this:
Step on the brake (during a collision mitigation event).	As the driver, you are always in control and are able to apply full braking power.
Step aggressively on the accelerator (during a collision mitigation event).	As the driver, you are always in control. Your actions override any Prevest Driver Assist™ system actions. NOTE: If cruise control is engaged, it will be overridden until the accelerator is released; then cruise control will resume the original set speed automatically.

Your Action	Reactions of the PrevoSt Driver Assist™ system
If you, the driver, do this:	Expect the PrevoSt Driver Assist™ system to do this:
Step on the brake (when in cruise).	Cruise control will be canceled.
Step on the accelerator (when in cruise).	Cruise control will be overridden until the accelerator is released; then cruise control will resume the original set speed automatically.
Switch ON the cruise control.	Nothing. The Active Cruise with Braking (braking to maintain a set following distance) feature will not engage until the driver sets the cruise control speed.
Switch OFF the cruise control.	The Active Cruise with Braking feature will turn off; the collision mitigation feature remains active and ready to intervene. You, the driver, will continue to hear all alerts as needed.
Set the cruise control speed.	The Active Cruise with Braking feature is automatically activated, and your vehicle maintains set speed and following distance behind the vehicle ahead in your lane of travel.
Cover or block the radar or camera.	<p>The PrevoSt Driver Assist™ system performance will be diminished, or disabled, when either the radar or the camera becomes blocked. An alert will be issued to alert the driver to indicate this condition.</p> <p>Radar:</p> <p>Radar blocked will be indicated through an alert and will disable the radar-based functions as follows:</p> <ul style="list-style-type: none"> - Loss of stationary vehicle braking SVB; - Loss of forward-moving vehicle braking; - Loss of ACB. The camera based function LDW will remain. <p>Camera:</p> <p>Camera blocked will be indicated through an alert and will disable all camera-based functions as follows:</p> <ul style="list-style-type: none"> - Loss of stationary vehicle braking SVB; - Reduced braking performance on moving vehicle (speed reduction 15 mph / 24 km/h maximum); - Loss of LDW. <p>The radar-based function ACB will remain.</p>
Use normal cruise control “+/-” switch.	Vehicle speed increased (+) or reduced (-) to achieve the new set speed while actively maintaining the following distance with the vehicle ahead, if one is present within 500 feet / 152 meters.

4-70 Controls and Instruments

TIRE PRESSURE MONITORING SYSTEM (TPMS)

The following information applies to the On-Screen TPMS version.

ON-SCREEN TPMS VERSION

This system is a sensing device designed to identify and display tire operating data and activate an alert or warning when pressure or temperature irregularities are detected.

NOTE

It is the responsibility of the driver to react promptly and with discretion to alerts and warnings. Abnormal tire inflation pressures should be corrected at the earliest opportunity.

Instrument Cluster Alarms And Warnings

Visual and audible warnings turn on to indicate either a low tire pressure or high tire temperature through two different warning conditions:

1- LOW TIRE PRESSURE WARNING



CHECK on + audible warning

Indicates a low tire pressure. Refer to the dedicated display to determine whether the warning condition is critical or not.

2- HIGH TIRE TEMPERATURE WARNING



CHECK on + audible warning

A high temperature warning will trigger if a tire temperature rises above 194°F (90°C). **You should stop the vehicle as soon as possible and check your tires.**

Dedicated Display

The TPMS display knows where the sensors are located. It receives the raw temperature and pressure readings from the TPMS receiver, it reads several signals from the vehicle and does the calculation required to generate the various screens.

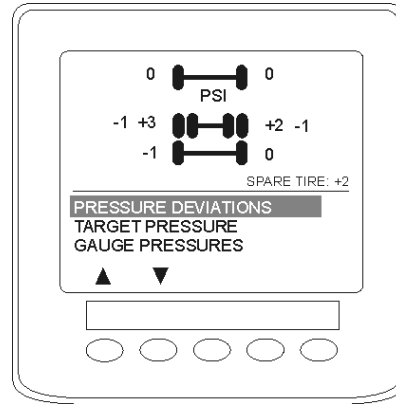

FIGURE 35: ON-SCREEN TPMS DEDICATED DISPLAY

When no readings have been received for a tire location or when the received data correspond to a parameter range defined as unavailable, then the reading is considered as not available and appears as two dash lines “_ _”.

The TPMS display is initially configured to define how many axles and running tires are present on the vehicle. For current Prevost vehicle models, there are two axles / tire configurations. These configurations are:

CONFIGURATION 1: Axle 1 (Front) Two tires, Axle 2 (Drive) 4 tires, Axle 3 (Tag) 2 tires.

CONFIGURATION 2: Axle 1 (Front) Two tires, Axle 2 (Drive) 2 tires (super Singles), Axle 3 (Tag) 2 tires.

The TPMS display is also configured with several other parameters, including threshold levels for the alarms.

The TPMS display turns OFF when the ignition key is switched OFF.

Operation

The system will monitor all vehicle tires (6 or 8) plus the spare tire when a spare is supplied.

NOTE

Some vehicle models do not come with a spare tire.

There are two configurations of vehicle tires to be supported. One configuration (the most common) consists of 8 tires total: two tires on the front axle, 4 tires on the drive axle and 2 tires on tag axle. All screen figures shown in this document relates to this vehicle configuration. The second tire

configuration consist of 6 tires total: 2 tires on the front axle, 2 tires on the drive axle (super single tires) and 2 tires on the tag axle. The vehicle tire configuration is selected with a parameter (Refer to ["TIRE PRESSURE MONITORING SYSTEM" on page 4](#) in *Section 7 Safety Features and Equipment* for more information). When the display is configured for 6 tires, the drive axle tires appears as one large tire on both side instead of twin tires as illustrated in this document and there is one reading appearing on each side instead of two as illustrated in this document.

Start-up

When the ignition switch is turned to ON, the following screen appears on the TPMS Display. Dash lines are displayed meaning that no pressure data have been received by the display.

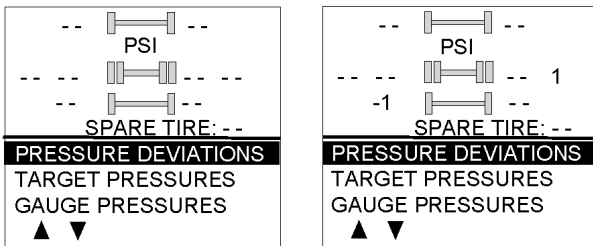

23455

As illustrated, the pressure readings will appear replacing the dash lines as the TPMS display starts to receive pressure data from the TPMS receiver. It can take 1 minute to get all pressure readings updated since the sensors transmit at a one-minute interval. The user can flip through the menus.

Pre-Trip Check

When one of the preconditions defined to start the pre-trip check is met, the TPM display enters into a pre-trip check routine and the screen shown below appears. The preconditions to initiate the pre-trip are: Park brake removed Or No activity on the display menu keys for a defined time (Key pressed timeout). After a pre-trip, the display is in a "drive" mode with bottom menu replaced by the alarm status. The display remains in this mode until one of the following occurs: A menu key is touched while the park brake is applied, or the park brake does a transition from released to park brake applied.

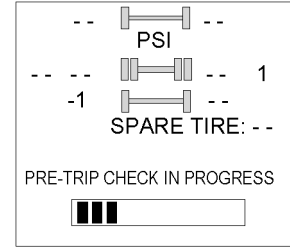

23456

During the pre-trip check, the pressure readings for the different wheels become all available.

The pre-trip check ends, either when: the pressure readings have been received for all running wheels or the pre-trip check maximum time has elapsed. It was selected to provide sufficient time for all wheel sensors to wake-up and send a first reading.

The pre-trip check is aborted and the bottom menu reappears if the park brake was active and the user press one of the menu keys.

Upon completion of the pre-trip check, the TPMS display will come up with one of the following screens:

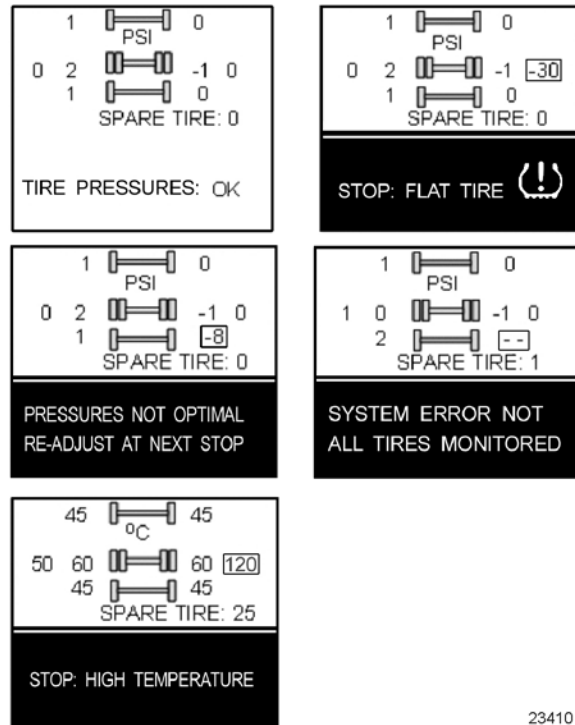

23410

A rectangle around each pressure and temperature reading of the tires that have an issue is blinking to draw the attention to the defective tires.

4-72 Controls and Instruments

In the case of multiple errors at the same time, the highest priority error is displayed at the bottom. “Flat Tire” has the highest priority followed by “High Temperature”, “Not all tires monitored” and “Tire pressure not Optimal”.

To get the driver’s attention to the alarms, the bottom section of the screen where the alarm message appears will blink to reverse contrast. Pressing any key will acknowledge the alarms that are considered as non-critical and stop the blinking of these alarms message for the remaining of the trip. The non-critical alarms are: “Pressure not optimal” and “Not all tires monitored”. The “flat tires” and “high temperature” alarms are critical and will keep blinking even when a key is pressed. If a different alarm occurs, blinking will start again. The blinking rectangle around the pressure/temperature readings is not impacted by the acknowledgement and keeps blinking until the error condition disappears.

The spare tire does not contribute to alarms and so never blinks.

On the road, the TPMS display shows one of the 5 previous screens.

In the event of a temperature alarm, the display switches automatically to temperature readings.

The driver can also press any of the menu keys to momentary switch the display to temperature readings. In this case, the temperature reading appears for 15 seconds and the display returns to pressure.

The switching to temperature by pressing a key does not take place if there is an acknowledgeable alarm active, since in this case pressing the key does acknowledge the alarm.

The switching to temperature does not take place either if there is an alarm of Temperature or Flat Tire.

The switching to temperature works when the bottom message indicates either: Tire Pressure OK, Pressure Not Optimal non flashing or not all tires monitored non flashing. When the switch is done to temperature readings, the bottom portion of the screen is not affected and still shows the status message.

NOTE
<i>High temperature is not likely to occur during the pre-trip.</i>

The pressure and temperature readings are continuously updated with the displayed readings of the wheel having issues blinking. The bottom line message is automatically updated to the highest priority alarm prevailing.

On the occurrence of an alarm, a beep will sound. The alarm beep could be turned OFF in the alarm settings menu.

Spare Tire

The spare tire is monitored but it is not taken into account when setting the bottom alarm messages. This is to prevent unnecessary alarms that would otherwise occur, if for example, the spare tire is removed from a vehicle.

The user will have the possibility to check the pressure of the spare tire by accessing the TPMS display menu. For vehicles that have no spare tires, the title “spare tire” will still appear on the screens but the pressure will remain with two dash lines at all time.

Post Trip Operation

When parking the vehicle (park brake applied), the TPMS display keep the drive mode display active. The driver can press any keys to get the bottom lines showing the status information replaced with the menus.

The pressure readings are still displayed and updated as new readings are received and the readings are blinking if not within the optimum pressure range.

From this point the user can scroll through the menus to get more detailed information and inflate or deflate the tires to bring them back to their optimum target pressures. Scrolling through these menus is also available prior to departure.

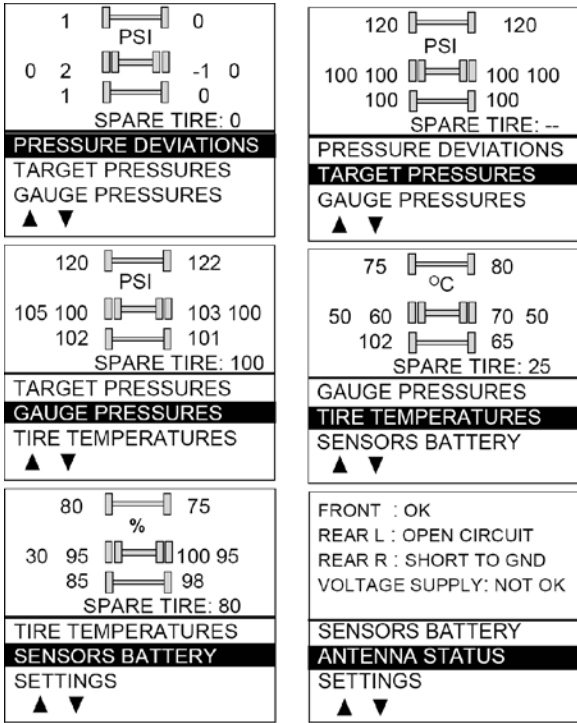

23411

The display remains in this mode with the menus appearing at the bottom until the pre-trip check sequence starts again.

Scrolling down below the Battery life menu will show the Settings menu. Highlighting the Settings and pressing OK allows entering the settings menu. Refer to ["Setting The On-Screen TPMS" on page 5](#) in Section 7 Safety Features and Equipment for more information.

Highlighting the Exit menu and pressing OK exits the settings and come back to the pressure display mode.

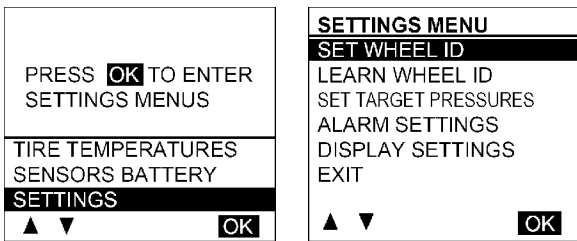

23411-2

SYSTEM MALFUNCTION

In case of system malfunction, the following warning pop-up message will show on the DID to warn the driver that the TPMS might be disabled or unreliable. Refer to Appendix D TPMS Troubleshooting Guide for further details.

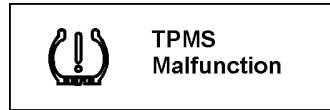

ALLISON TRANSMISSION

The transmission is fully automatic: Proper ranges should be automatically selected according to driving speeds to improve vehicle performance and control. The speed ratio of the power converter changes automatically as vehicle speed increases and direct-drive goes in and out as necessary. The speed ratio is modulated by vehicle speed and accelerator pedal position. You will find the complete transmission operation instructions and driving tips in the [Allison 5th Generation Bus Series Operator's Manual](#) available on the Prevost Technical Publication web site.

OPERATION

When a button is depressed on the transmission control pad, the corresponding letter or number is displayed indicating the transmission is ready to operate in the selected range. If the transmission control module (TCM) detects a serious problem in the transmission, the CHECK telltale lights on the dashboard.

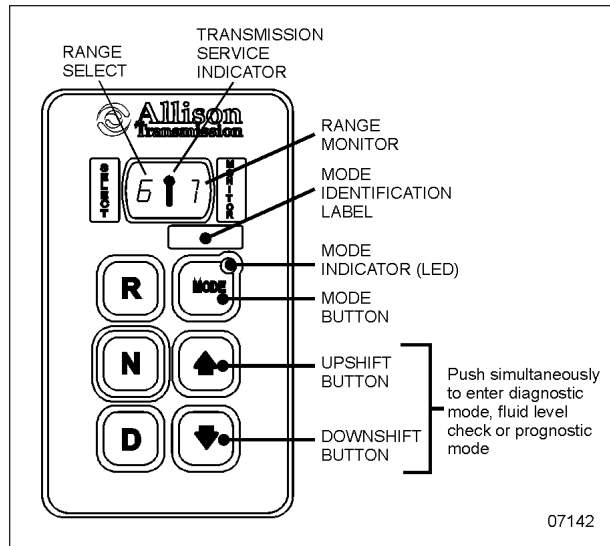

FIGURE 36: ALLISON PUSHBUTTON SHIFT SELECTOR

PUSHBUTTON SHIFT SELECTOR

The pushbutton shift selector has the following elements:

4-74 Controls and Instruments

R: Press to select Reverse gear.

NOTE

The forward limit speed to activate the reverse gear is 5 mph.

N: Press to select Neutral.

D: Press to select Drive. The highest forward range available will appear in the digital display window under SELECT. The transmission will start out in the lowest available forward range, displayed under MONITOR, and advance automatically to the highest range.

↑ ↓ : Press respectively the **↑** (Upshift) or **↓** (Downshift) arrow button when in DRIVE to request the next higher or lower range. One press changes gears by one range. If the button is held down, the selection will scroll up or down until the button is released or until the highest or lowest possible range is selected. Protection mechanisms inhibit selecting ranges that are not appropriate for the current speed or which may damage driveline components.

MODE: Pressing the MODE button allows the driver to activate the secondary shift schedule that has been programed into the TCM unit.

PRIMARY AND SECONDARY SHIFT SCHEDULES

The primary shift schedule is the default mode at starting of the engine and is typically specified to accommodate normal vehicle operation. The transmission controller automatically selects between ECONOMY and PERFORMANCE shift strategy, based on the vehicle actual load and the grade on which the vehicle is operating. This is called Load Based Shift Scheduling (LBSS). This can produce improved overall vehicle fuel economy while still enabling high productivity when the vehicle is loaded.

In the secondary shift schedule, only the ECONOMY shift strategy is available. No switching is done between shift strategies. The secondary shift mode is available only if selected by the driver, using the MODE button. When the secondary mode is activated, "MODE" illuminates on the display.

NOTE

When the diagnostic display mode has been entered, the MODE button is used to view and toggle through diagnostic code information. Refer to appendix C for more details about diagnostic code display procedure and fluid level check using the pushbutton shift selector.

TRANSMISSION SERVICE INDICATOR

↑: This indicator will be illuminated upon the detection of a service issue relating to clutch, filter or fluid life. The appearance of the indicator (lit steadily, flashing, etc.) varies for each of the conditions monitored by the system. Refer to appendix C for more details about diagnostic code display procedure, fluid level check or prognostic features (Oil Life Monitor, Filter Life Monitor and Transmission Health Monitor) using the pushbutton shift selector.

Illuminated at startup for a bulb check, this indicator will then be turned off if no service conditions exist.

DESCRIPTION OF AVAILABLE RANGES

R (Reverse)

Press the «R» button to select reverse. Completely stop the vehicle and let the engine return idle before shifting from forward range «D» to reverse «R» or from reverse to forward range. The reverse warning signal will be activated when this range is selected.

N (Neutral)

Use this position to start the engine. Select «N» (Neutral) when checking vehicle accessories and for extended periods of engine idle operation; parking brake must then be applied. The pushbutton shift selector automatically select «N» (Neutral) when the ignition switch is turned On.

NOTE

The automatic transmission does not have a park «P» position. Select «N» (Neutral) and apply parking brake when the vehicle is left unattended. An audible alert will sound if the engine is stopped and the parking brake is not applied.



WARNING

Before leaving driver's seat, always put the transmission in NEUTRAL and apply parking brake.



WARNING

The vehicle service brakes or park brake must be applied whenever NEUTRAL is selected to prevent unexpected vehicle movement.



CAUTION

Diesel engines should not be idled for extended periods at "slow" idle. For extended idling, engine should run at "fast" idle.



CAUTION

Do not allow your vehicle to "coast" in neutral «N». This practice can result in transmission damage. Also, no engine braking is available in neutral.

D (Drive)

Use this position for all normal driving conditions. After touching this pad, the vehicle will start in first or second range and will automatically upshift to a higher range as output speed increases. As the vehicle slows down, output speed decreases, the transmission automatically downshifts to the correct range. If a locked brake or a slick surface condition should occur, the TCM (Transmission Control Module) will command converter operation (disconnect lockup) and inhibit downshift for a period of time or until normal wheel speed has been restored.

NOTE

IMPORTANT: Brake pedal must be applied when selecting «D» (Drive) otherwise the transmission will stay in «N» (Neutral).

NOTE

The transmission should normally be allowed to shift by itself, but manual shifting can be done as described below.

1 (First Range)

Select this range when pulling through mud and snow, when speed control is needed for driving up or down steep grades or when maneuvering in tight spaces. This range also provides maximum driving torque and engine braking power or retarder braking effect. In the lower ranges (1, 2, 3 and 4), the transmission will not upshift above the highest gear selected unless engine overspeed is detected.

2 (Second Range)

Select this range when operating in heavy and congested traffic. The transmission will start in first and automatically upshift to second. When slowing, the transmission will automatically downshift to first range. Low ranges provide progressively greater engine and retarder braking power (the lower the range, the greater the engine and retarder braking effect).

3, 4 (Third And Fourth Ranges)

Select these ranges when driving on moderate grades or when load and traffic conditions limit speed.



WARNING

Service brake should not be used to control the speed of the vehicle on long, steep descents. Instead, lower transmission ranges should be used in conjunction with the output retarder. Refer to "[TRANSMISSION RETARDER \(option\)](#)" [on page 25](#) in Section 5 Other Features for details regarding both systems. This procedure keeps service brake cool and ready for emergency stopping.



CAUTION

When descending in lower ranges, care must be taken that engine speed does not exceed 2,450 rpm.

4-76 Controls and Instruments

TOWING RECOMMENDATIONS



CAUTION

When towing the vehicle, the transmission output shaft must not be allowed to spin or turn. If the vehicle is towed with the drive wheels still in contact with the road surface, the vehicle axle shafts or driveline must be removed or disconnected. Do not attempt to push or pull-start the vehicle.

Failure to disconnect the driveshaft, remove the drive axle shafts or lift the drive wheels off the ground before towing will cause serious damage to transmission.

Non-compliance with the above requirements will void warranty.



CAUTION

Make sure axle shafts or driveshaft are installed correctly after towing. Tighten axle shaft and driveshaft nuts to the correct torque settings. Do not invert shafts.

SECTION 5 - OTHER FEATURES

EXHAUST AFTERTREATMENT SYSTEM	3
FILTRATION AND REGENERATION UNIT	3
PASSIVE REGENERATION	3
ACTIVE REGENERATION	3
STATIONARY (PARKED) REGENERATION	3
DEF CLOGGING SEQUENCE – INSTRUMENT CLUSTER TELLTALE LIGHT	4
SELECTIVE CATALYTIC REDUCTION UNIT	5
DRIVER WARNING AND INDUCEMENT MEASURES	7
DRIVER INFORMATION DISPLAY (DID) MENUS	11
GAUGES	12
FUEL DATA	13
TIME/DISTANCE	14
VEHICLE MESSAGES	15
RESET TRIP DATA	15
DISPLAY SETTINGS	15
DIAGNOSTICS MENU	18
PRE-TRIP ASSISTANCE (OPTION)	19
DATA LOG	21
AFTERTREATMENT	22
PASSWORD	23
PREVOST LIAISON (OPTION)	23
INTELLIGENT SLEEP MODE (ISM)	25
TRANSMISSION RETARDER (OPTION)	25
ENGINE BRAKE	25
VOLVO ENGINE BRAKE (VEB)	26
CRUISE CONTROL AND ENGINE BRAKE	26
ABS, TRACTION CONTROL SYSTEM (TCS) & ELECTRONIC STABILITY CONTROL (ESC)	27
ANTILOCK BRAKING SYSTEM (ABS)	27
TRACTION CONTROL SYSTEM (TCS)	27
ELECTRONIC STABILITY CONTROL (OPTION)	27
DRIVER CONTROLLED DIFFERENTIAL LOCK (DCDL)	28
OPERATION TIPS	28
LOCKING THE DCDL	29
UNLOCKING THE DCDL	29
RETRACTABLE TAG AXLE	29
KEYLESS ENTRY SYSTEM	29
KEYLESS OPERATING INSTRUCTIONS	30
PROGRAMMING AND MANAGING PERSONAL CODES	30

5-2 Other Features

REMOTE ENTRY TRANSMITTER	31
PROGRAMMING TRANSMITTERS	32
SLIDE-OUT OPERATION	32
SAFETY PRECAUTIONS	32
FRONT AND REAR SLIDE-OUT OPERATION	32
SLIDE-OUT MANUAL OVERRIDE PROCEDURE	34
MOBILE FLOOR HAND CRANK PROCEDURE	37
SLIDE-OUT TROUBLESHOOTING	37
SLIDE-OUT TROUBLESHOOTING TABLE	39

EXHAUST AFTERTREATMENT SYSTEM

The exhaust aftertreatment system consists of two units, the filtration and regeneration unit and the selective catalytic reduction SCR unit.

FILTRATION AND REGENERATION UNIT

The main purpose of the filtration and regeneration unit is to capture and oxidize (regenerate) the particulate matter (soot) in the engine exhaust gas. The exhaust gas first enters the Diesel Oxidation Catalyst (DOC) and then flow through the Diesel Particulate Filter (DPF); together they capture and regenerate the soot on a regular or passive basis. Through constant monitoring of the exhaust gas temperature and the system back pressure, the engine control module is able to manage regeneration.

PASSIVE REGENERATION

Passive regeneration is the process by which the particulate matter is oxidized due to the heat generated by the engine internal combustion process. During normal highway operation, exhaust temperatures alone are usually high enough to oxidize accumulating soot. In low ambient temperatures, however, or in some stop-and-go applications, the system needs a little help to regenerate, or clean itself. This process is called “active” regeneration.

ACTIVE REGENERATION

Active regeneration is necessary when the engine internal combustion process alone does not generate enough heat. A dosing system injects a mist of diesel fuel into the exhaust system to increase and maintain the aftertreatment system temperature. Exhaust temperature must be above 572°F (300°C) to initiate the oxidation catalyst, which in turn oxidizes the injected diesel fuel molecules to achieve up to 1200°F (650°C) exhaust temperature at the particulate filter. This process of active regeneration takes place during the normal operation cycle of the vehicle without charges in performance or control for the operator. EPA2010 compliant and later Volvo engines produce less soot, so less active or stationary regeneration will be required.







STATIONARY (PARKED) REGENERATION

In a small number of specific engine duty cycles, engine control module may not be capable of completing an active regeneration. In these situations, the operator will be notified that a stationary or parked regeneration may be required. A DPF telltale light will illuminate indicating the need for user interaction. The lamp gives the operator a grace period to allow this process to take place at a time when most convenient for the operator. This process requires the vehicle to be parked while a driver or maintenance technician initiates the regeneration process using the DID menus. Once initiated, the stationary regeneration process will be complete in about 45 minutes.

The driver will be notified of the need for a stationary regeneration (parked) by illumination of the DPF Regeneration telltale light.

5-4 Other Features

DEF CLOGGING SEQUENCE – INSTRUMENT CLUSTER TELLTALE LIGHT

LEVEL 1	 solid	<p>REGENERATION NEEDED</p> <p>Diesel particulate filter is becoming full</p> <p>The DPF Regeneration telltale light illuminates to notify the driver that a stationary regeneration (parked) will be required soon. When this lamp is lit, initiate stationary regeneration process at an appropriate time of day.</p> <p>THERE IS NO URGENCY AT THIS LEVEL.</p>
LEVEL 2	 flashing	<p>REGENERATION REQUIRED</p> <p>Diesel particulate filter full</p> <p>If no DPF regeneration occurs after the initial DPF Regeneration telltale light illumination, the lamp will begin blinking and a stationary regeneration should be initiated as soon as possible in order to prevent from entering into Level 3.</p>
LEVEL 3	 flashing + 	<p>ATD SERVICE REQUIRED</p> <p>ENGINE DERATE ACTIVE</p> <p>Diesel particulate filter overfull</p> <p>If the flashing DPF Regeneration telltale light is still ignored, the CHECK telltale light will illuminate. In that situation, engine performance is limited. Perform a parked regeneration IMMEDIATELY to avoid further derate and prevent from entering into Level 4.</p>
LEVEL 4	 flashing +  + 	<p>ATD SERVICE REQUIRED</p> <p>ENGINE SHUTDOWN ACTIVE</p> <p>A serious engine problem has occurred. The DPF may be over its maximum capacity.</p> <p>If a stationary regeneration is still not initiated, a standard Engine Protection Shutdown sequence will occur. All of the following dashboard lamps will be present:</p> <ul style="list-style-type: none"> • Blinking DPF Regeneration telltale light; • Solid CHECK telltale light; • Solid STOP telltale light. <p>Once engine derate and/or shutdown sequence is completed, a stationary regeneration must occur to continue vehicle operation. If the driver continues to operate the vehicle without regeneration, additional measures will be taken to protect the engine and ATD from damage, up to and including engine shutdown. Parked regeneration might no longer be possible.</p> <hr/> <p>If engine protection has been initiated and forces the engine to shutdown, you can immediately RE-START the engine and perform the necessary steps in order to initiate a stationary regeneration.</p> <p style="text-align: center;"><u>Find and solve the cause of the shutdown</u></p>

Initiating A Stationary (Parked) Regeneration

NOTE

At starting of the engine, if a stationary regeneration is required, the engine coolant temperature must reach 140°F (60°C) before any stationary regeneration may be initiated and completed. Permit the engine to idle for a short while or drive the vehicle until engine temperature increases sufficiently.



WARNING

Do not initiate a stationary regeneration in a closed area like a garage. Stationary regenerations must be undertaken outdoors only.



WARNING

During stationary regeneration, exhaust temperature may reach up to 1200°F (650°C) at the particulate filter. Before initiating stationary regeneration, make sure that the DPF outlet diffuser is clear of objects and that no one is working near the DPF outlet diffuser.



WARNING

Hot surfaces. Keep yourself clear of all hot Aftertreatment Device components, particularly during and after active or stationary regeneration. Hot surfaces can cause serious burns.

NOTE

STATIONARY REGENERATION

This process requires the vehicle to be parked while the driver or a maintenance technician initiates the regeneration process.

The DPF Regeneration telltale light illuminates to notify the driver of the need and urgency of a manual stationary regeneration.



DPF REGENERATION telltale light

If stationary regeneration is not performed, this telltale light will blink, indicating that a stationary regeneration is required immediately. If stationary regeneration is still not performed, “engine power derate and shutdown” sequence may occur as per level 1 to level 4 sequence.

To initiate a stationary regeneration:

- Park the vehicle in a clear area, vehicle speed must be 0 mph (0 km/h);
- Engine must be on normal idle and fully warmed up (coolant temperature above 140°F/60°C);
- Apply parking brakes and set the transmission to neutral (N).
- Press the DID ENTER button and then get to the DID Aftertreatment menu. Select sub-menu Request Parked REGEN and press ENTER button to confirm and initiate regeneration.

The regeneration will begin. Turn off the air conditioning to reduce engine load. The engine idling speed will increase to 1600 rpm. Once the regeneration is completed, the engine speed will return to normal idle.

Voluntary Interruption Of A Stationary Regeneration

It is possible to interrupt a stationary regeneration at all time. To do so, get to the DID’s Aftertreatment menu, select Cancel REGEN and press ENTER button to confirm. You can stop regeneration simply by releasing the parking brake. Use this procedure in order to move the vehicle in a safe area only.

If regeneration is interrupted, it is very important to reinitiate the regeneration as soon as possible.



CAUTION

If an active regeneration is stopped repeatedly, the vehicle may need to be taken to a service facility. The service facility will use a service tool to manually initiate the regeneration. Moreover, the interruption of active regeneration should not be considered as a normal practice. Some components of the aftertreatment system might be damaged in the long term.

SELECTIVE CATALYTIC REDUCTION UNIT

Selective Catalytic Reduction (SCR) is a technology that uses Diesel Exhaust Fluid (DEF) and a catalytic converter to reduce nitrogen oxides (NOx) emissions.

SCR is an exhaust aftertreatment system that injects small amount of DEF into the exhaust gas between the DPF and the selective reduction catalytic converter. DEF turns to ammonia and

5-6 Other Features

carbon dioxide when heated. The exhaust stream then passes over a catalyst, the ammonia reacts with the NOx to form nitrogen and water vapor.

The basic elements of the SCR system consist of a 15.9 gallons (60 liters) DEF tank complete with pump, lines and heating system, a dosing injector, a catalytic converter and the control and monitoring system.

Diesel Exhaust Fluid (DEF)

When handling DEF solution, keep electrical connectors properly connected or well capped, otherwise there is a risk that the DEF will cause oxidation that cannot be removed. Water or compressed air will not help, since DEF quickly oxidizes certain metals. If a disconnected connector comes into contact with the DEF solution, it must be replaced immediately to prevent the DEF solution from creeping further into the copper wiring, which takes place at a speed of about 2.4 in (60 mm) per hour.



CAUTION

Diesel Exhaust Fluid (DEF) is a nontoxic aqueous solution of urea (32.5%) and ultra-pure water (67.5%). Urea is a compound of nitrogen that turns to ammonia when heated. The fluid is non flammable, and is not dangerous when handled as recommended. However, it is highly corrosive to certain metals, especially copper and brass.

When detaching hoses and components, do not spill DEF on disconnected or unsealed connectors. If DEF is spilled on a disconnected or unsealed connector, the connector must be removed immediately and replaced.

Things to know about spilt diesel exhaust fluid (DEF):

- If urea solution comes into contact with the skin, rinse with plenty of water and remove contaminated clothing.
- If urea solution comes into contact with the eyes rinse for several minutes and call for medical help if necessary.
- If inhaled breathe fresh air and call for medical help if necessary.
- Do not allow the DEF solution to come into contact with other chemicals.
- The DEF solution is not flammable. If the DEF solution is exposed to high temperatures, it breaks down into ammonia and carbon dioxide.
- The DEF solution is highly corrosive to certain metals, including copper and aluminum.
- If the DEF solution is spilled onto the vehicle, wipe off the excess and rinse with water. Spilled DEF solution can form concentrated white crystals on the vehicle. Rinse off these crystals with water.



CAUTION

DEF freezing and expansion

DEF will begin to crystallize and freeze at 12°F (-11°C). DEF expands by approximately 7% when frozen. During freezing weather, do not store a DEF container on the coach unless it is designed to allow for expansion.

Make sure the DEF container is not completely full. DEF expansion may split an inappropriate container, causing a spill and corrosion as a result.



WARNING

DEF spilt onto hot components will quickly vaporize. Turn your face away!

Diesel Exhaust Fluid Consumption

DEF consumption is related to fuel consumption. In order to meet EPA requirements, DEF tanks are sized so one refill will be necessary every two refill of the fuel tank.

DRIVER WARNING AND INDUCEMENT MEASURES

Auxiliary Emission Control Device (EACD) defines as any element of design which senses temperature, vehicle speed, engine RPM, transmission gear, manifold vacuum, or any other parameter for the purpose of activating, modulating, delaying, or deactivating the operation of any part of the emission control system.









Disconnection of the following EACD produces immediate activation of the Malfunction Indicator Lamp MIL and **25% engine derate** after three (3) hours of a continuous open circuit condition.









- Intake throttle position sensor
- Ambient air temperature sensor
- Vehicle speed
- Engine oil pressure sensor
- Exhaust back pressure sensor
- Camshaft speed sensor
- EGR delta pressure
- Fuel rail pressure
- Engine timing sensor
- Engine coolant temperature
- EGR temperature sensor

Exhaust Aftertreatment System (EATS) components must not be removed, altered or modified in any way. In order to protect the emission control system from tampering, inducement measures will occur if the following states are detected:









- Disconnection of DEF tank level sensor
- Blocked DEF line or dosing valve
- Disconnection of DEF dosing valve
- Disconnection of DEF pump
- Disconnection of SCR wiring harness
- Disconnection of NOx sensor
- Disconnected exhaust temperature sensor
- Disconnected DEF temperature sensor
- Disconnected DEF quality sensor

5-8 Other Features

DEF TANK LEVEL - DRIVER WARNINGS AND INDUCEMENTS				
Conditions / Triggers		DEF Tank LOW LEVEL Indicator, DID Message and audible warning		Inducement
1	<p>Normal</p> <p>DEF tank level sensor reads between 100% and 12%</p>	None		None
2	<p>Low DEF tank warning</p> <p>DEF tank level sensor reads between 12% and 0.1%</p> 	 solid	<p>DEF TANK LEVEL LOW</p> <p>REFILL DEF SOON TO PREVENT ENGINE DERATE</p> <p>🔊 3 beeps</p>	Warning message
3	<p>DEF tank near empty</p> <p>DEF tank level sensor reads less than 0.1%</p> 	 blinking	<p>DEF TANK EMPTY</p> <p>REFILL DEF TO AVOID 5 MPH LIMIT</p> <p>ENGINE IN DERATE</p> <p>🔊 3 beeps</p>	Engine torque reduction of 25%
4	<p>DEF tank empty and one (1) hour of operation in engine derate mode</p> 	 blinking	<p>DEF TANK EMPTY</p> <p>REFILL DEF TO AVOID 5 MPH LIMIT</p> <p>ENGINE IN DERATE</p> <p>🔊 3 beeps</p>	Engine torque reduction of 40%
5	<p>DEF tank empty and either</p> <ol style="list-style-type: none"> Diesel fuel refueling done with a fuel level sensor reading increase of 15%, or more Vehicle stationary (speed=0) for 20 minutes with engine off or at idle 	 blinking	<p>REFILL DEF TANK</p> <p>VEHICLE SPEED LIMITED TO 5 MPH (8 KM/H)</p> <p>🔊 constant tone</p>	<p>Vehicle road speed limited (RSL) to 5 mph (8 km/h)</p> <p>Note: The vehicle has to be stationary before 5 mph (8 km/h) road speed limit becomes active</p>

DEF QUALITY - DRIVER WARNING AND INDUCEMENT				
Conditions / Triggers		Amber Warning Light & DID Message And Audible Warning		Inducement
1	Good DEF quality	None		None
2	Poor DEF quality detected	 solid	POOR DEF QUALITY DETECTED SERVICE DEF SYSTEM AT NEXT STOP  3 cycles of 2 beeps	Warning message Engine will derate 25% in < 60 mins
3	Poor DEF quality detected and one (1) hour of operation with active diagnostic troubleshooting code	 solid	POOR DEF QUALITY DETECTED ENGINE IN DERATE 5 MPH (8KM/H) LIMIT IN < XXX MINS  3 cycles of 2 beeps	Engine derated 25% Engine will derate 40% in <240 mins
4	Poor DEF quality detected and four (4) hours of operation with active diagnostic troubleshooting code	 solid	SERVICE DEF 5 MPH (8KM/H) LIMIT NEXT 20MIN VEHICLE STOP  3 cycles of 2 beeps	Engine derated 40% 5 mph (8 km/h) limit after next 20 min vehicle stop
5	Poor DEF quality detected Diesel fuel refueling done with a fuel level sensor increase of 15% or more or Vehicle stationary (speed=0) for 20 minutes with engine off or at idle or Key cycle trigger	 solid	SERVICE DEF VEHICLE SPEED LIMITED TO 5 MPH (8 KM/H)  continuous cycle of 2 beeps	Service DEF Vehicle road speed limited (RSL) to 5 mph (8 km/h) Note: The vehicle has to be stationary before 5 mph (8 km/h) road speed limit becomes active

5-10 Other Features

SCR SYSTEM TAMPERING - DRIVER WARNING AND INDUCEMENT				
Conditions / Triggers		Amber Warning Light, DID Message And Audible Warning		Inducement
1	Normal No diagnostic troubleshooting code active	None		None
2	SCR system tampering diagnostic troubleshooting code confirmed	 solid	SCR SYSTEM FAULT ENGINE WILL DERATE IN < XXX MINS  constant tone	Warning message
3	Reached one (1) hour of operation with active SCR system tampering diagnostic troubleshooting code confirmed	 solid	SCR SYSTEM FAULT ENGINE IN DERATE 5 MPH (8KM/H) LIMIT IN < XXX MINS  constant tone	Engine torque reduction of 25%
4	Reached four (4) hours of operation with active SCR system tampering diagnostic troubleshooting code confirmed	 solid	SCR SYSTEM FAULT REPAIR NEEDED 5 MPH (8KM/H) LIMIT NEXT VEHICLE STOP  constant tone	Engine torque reduction of 40%
5	Diesel fuel refueling done with a fuel level sensor increase of 15% or more	 solid	SCR SYSTEM FAULT VEHICLE SPEED LIMITED TO 5 MPH (8 KM/H)  constant tone	Vehicle road speed limited (RSL) to 5 mph (8 km/h)

DRIVER INFORMATION DISPLAY (DID) MENUS

There are Driving and Non-Driving menus. Several sub-menus are password-protected while the vehicle is parked. The Non-Driving menu is accessible only when the vehicle is parked.

DRIVING MODE MENUS	NON-DRIVING / STATIONARY MODE MENUS
<u>GAUGES</u> <ol style="list-style-type: none"> 1. Current Gear Position (I-Shift) 2. Outside Temperature 3. Engine Oil Temperature 4. Transmission Fluid Temperature 5. Prevost Liaison Compass 6. Accessories Air Pressure 7. Battery Voltage 8. A/C Compressor Pressure 9. Allison Transmission Oil Life 10. Battery State Of Charge 11. Electric Cooling Fan Status 	<u>DISPLAY SETTINGS</u> <ol style="list-style-type: none"> 1. Language 2. Units 3. Time/Date 4. Favorite Display Setting 5. Display Light 6. Change Password
<u>FUEL DATA</u> <ol style="list-style-type: none"> 1. Fuel Flow 2. Fuel Flow / ECO % 3. Trip Fuel Used 4. Distance to Empty 	<u>DIAGNOSTICS MENU</u> <ol style="list-style-type: none"> 1. View Active Faults 2. View Inactive Faults 3. Cluster Self-Test 4. Part Number 5. Reset Inactive Faults 6. Vehicle Tests
<u>TIME/DISTANCE</u> <ol style="list-style-type: none"> 1. Time and Date 2. Alarm Clock 3. Trip Odometer 1 and 2 4. Average Trip Speed 5. Estimated Time of Arrival (ETA) 	<u>PRE-TRIP ASSISTANCE (OPTION)</u> <ol style="list-style-type: none"> 1. Exterior Light Inspection 2. Air Leakage Monitor
<u>VEHICLE MESSAGES</u>	<u>DATA LOG</u> <ol style="list-style-type: none"> 1. Vehicle ID 2. Total Data 3. Trip Data 4. Reset Trip Data
<u>RESET TRIP DATA</u>	<u>AFTERTREATMENT</u> <ol style="list-style-type: none"> 1. Request Parked REGEN 2. ATS Status 3. Cancel REGEN
	<u>PASSWORD</u> <ol style="list-style-type: none"> 1. Enter Password
	<u>PREVOST LIAISON (OPTION)</u> <ol style="list-style-type: none"> 1. Read Message 2. Send Message 3. Other Info

5-12 Other Features

GAUGES

There are several gauges in this menu. The gauges are used to view current status of important functions in the vehicle.

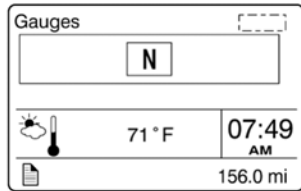

1. Current Gear Position (I-Shift transmission only)

Indicates the current gear position selected on the I-Shift transmission.

D= drive

N= neutral

R= reverse

M= manual

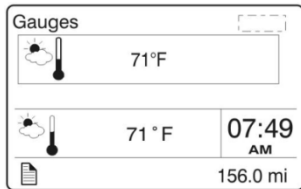

2. Outside Temperature

Selecting this gauge will display the engine oil temperature.

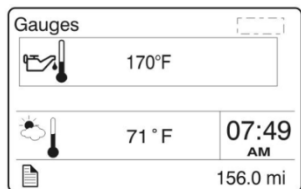

3. Engine Oil Temperature

Selecting this gauge will display the engine oil temperature.

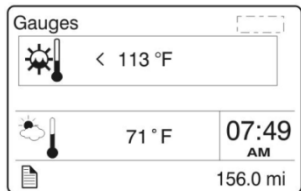

4. Transmission Fluid Temperature

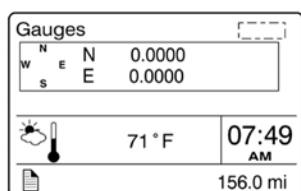

5. Prevost Liaison Compass

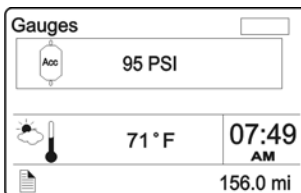

6. Accessories Air Pressure

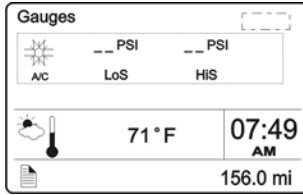

7. A/C Compressor Pressure

Displays the A/C compressor suction pressure value (LoS=low side) and discharge pressure value (HiS=high side).

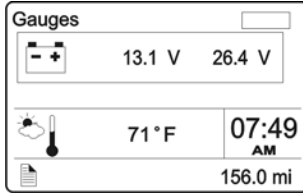

8. Battery Voltage

Displays current 12-volts and 24-volts systems voltage.

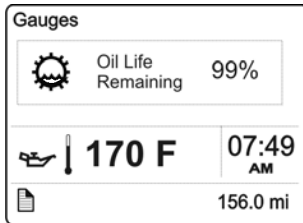

9. Allison Transmission Oil Life

Displays the percentage of the calculated remaining life of the transmission oil. New oil is displayed as 99%. Refer to Appendix C for more details.

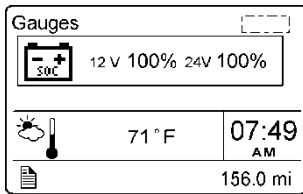

10. Battery State Of Charge

Displays the state of charge of the 12-volt and 24-volt systems, expressed in percentage.

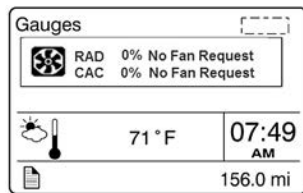

11. Electric Cooling Fan Status

Displays the speed and the state of both Charge Air Cooler and radiator cooling fans, expressed in percentage from 0 to 100%.

FUEL DATA

The Fuel Data menu provides information on the fuel consumption of the vehicle in various situations. For example, how much fuel has been used, how much fuel is remaining before refueling the vehicle.

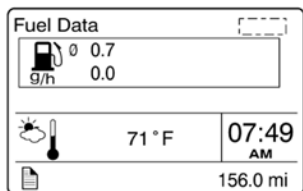

1. Fuel Flow (gph)

The lower numerical value (0.0) indicates the instantaneous fuel consumption. In this menu, you can reset the upper numerical value which is the average fuel consumption (0.7). To reset, hold ENTER button for 1 second.

5-14 Other Features

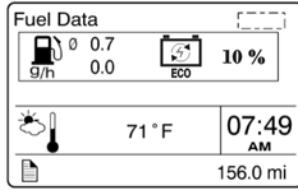

2. Fuel Flow/ ECO%

The lower numerical value (0.0) indicates the instantaneous fuel consumption. In this menu, you can reset the upper numerical value which is the average fuel consumption (0.7). To reset, hold ENTER button for 1 second.

This menu also displays the percentage of trip made on regenerated electricity (10%).

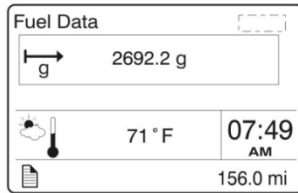

3. Trip Fuel Used

Indicates the total fuel consumption (gallons/liters) since the last reset.

Note: You should use Reset function before each new trip.

You can reset the fuel consumption value in this menu. To reset, hold ENTER button for 1 second.

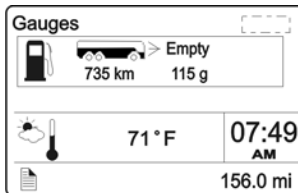

4. Distance to Empty

The left numerical value indicates the distance that can be traveled with the quantity of fuel that remains in the tank as indicated by the right numerical value.

TIME/DISTANCE

The time and date can be set in the Time/Distance menu. The alarm clock can also be set from this menu. Following the alarm clock menu is the Trip Odometer 1 and 2 selection, which allows the operator to see the distance traveled since the last reset. Average trip speed is also shown. By specifying the distance to your destination, the vehicle can calculate the estimated time of arrival (ETA).

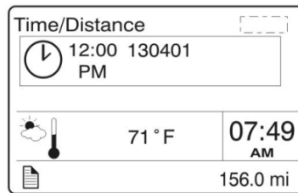

1. Time And Date

Adjust time and date with this menu. The instrument cluster has its own internal battery, so the date and date setting is keep in memory even if the vehicle's battery is disconnected.

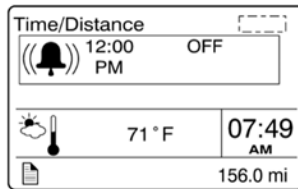

2. Alarm Clock

Use this function to program and activate an alarm on the instrument cluster clock. When the alarm clock goes off, a warning signal is sounded. The alarm shuts off after 60 seconds or if the ESCAPE button is depressed.

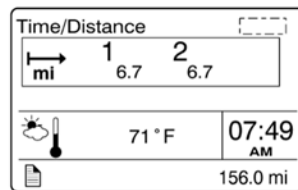

3. Trip Odometer 1 and 2

Allows the operator to see the distance traveled since the last reset. You can reset the trip odometer 1 or 2 in this menu. To reset, depress ENTER button, use UP/DOWN button to select between odometer 1 or 2 and then hold ENTER button for 1 second.

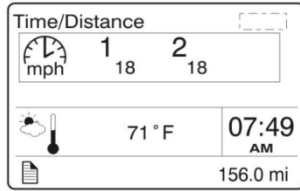

4. Average Trip Speed

This function displays the average speed for the current travel. The average trip speed is calculated as the distance traveled divided by the time the engine has been running (since the last reset). Two average trip speeds can be measured, corresponding to leg 1 and leg 2. Use Reset function before each new travel to start new measurements.

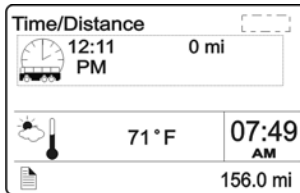

5. Estimated Time of Arrival (ETA)

This function will display the estimated time of arrival if the distance to be traveled is entered first, in this menu. To set distance to be traveled, press ENTER and enter the distance left to drive in mile or km using ENTER and UP/DOWN buttons.

VEHICLE MESSAGES

Use this function to consult the vehicle active messages that were previously displayed as pop-up messages and then acknowledged. When consulting a message, the corresponding STOP, CHECK or INFORMATION warning light will illuminate. Scroll through the messages using the up/down button. Press ESC button to return to main menu.

RESET TRIP DATA

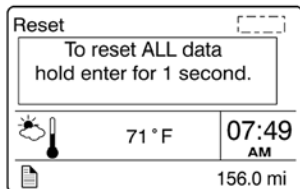

When the Reset Trip Data menu is open, pressing and holding down the Enter ↵ button for 1 second resets the functions listed below. This function will permit to the system to calculate new value from the point of resetting.

- Fuel flow
- Trip Fuel Used
- Average Trip Speed

DISPLAY SETTINGS

The Display Settings menu is used to change languages and units. The password, time and date can also be changed. The backlight and contrast of the display screen can be adjusted.

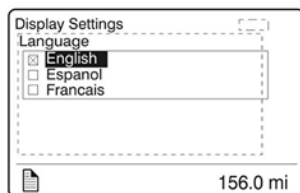

1. Language

5-16 Other Features

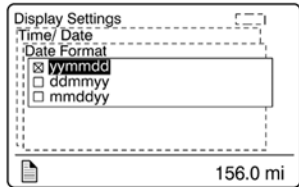
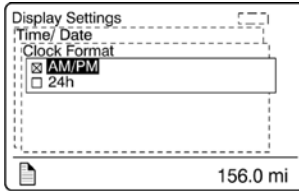
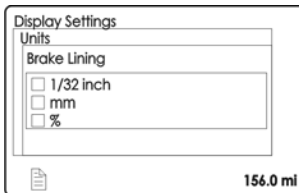
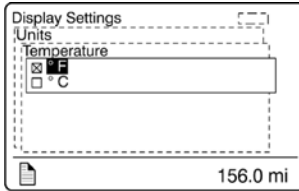
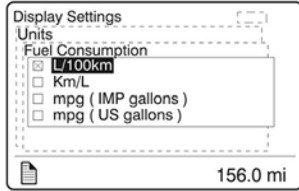
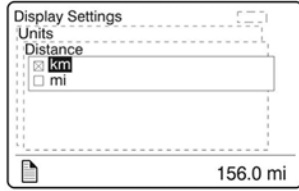

2. Units

Use this function to select desired unit formats for:

- Distance (miles or km);
- Fuel consumption (km/l, l/100km, mpg US or IMP);
- Temperature (°C or °F).
- Brake lining remaining (Brake calipers equipped with pad wear indicators): 1/32 inch, mm, %.

3. Time/Date

Select the time and date format using this function.

- am, pm, 24h
- yymmdd, ddmmyy, mmddyy



4. Favorite Display Setting

Use this menu to select your favorite display gauges 1, 2 and 3 and replace the default gauges.

On vehicles provided with the I-Shift transmission, Favorite Display Gauge 3 cannot be edited as it is kept for display of the transmission status.

Example: You wish to display the engine oil temperature at the Gauge 1 position.

1. Use UP/DOWN button until Gauge 1 position is selected.
2. Press ENTER button to confirm.

Use UP/DOWN button to scroll through the available gauges. When the engine oil temperature gauge is displayed, press ENTER button to confirm (repeat steps 1-3 to change Gauge 2 and Gauge 3 if needed).

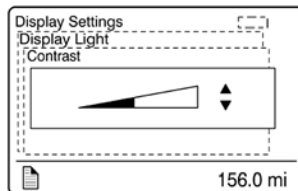

5. Display Light

The Display Light menu has three sub-menus:

- Contrast

Adjust the contrast with the UP/DOWN button and press ENTER button to confirm.

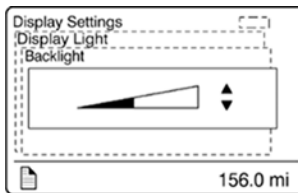

- Backlight

In this menu, the display lighting can be adjusted relative to other instrument lighting with the UP/DOWN button.

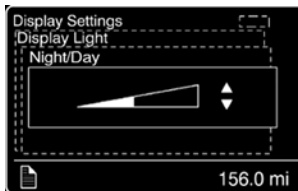

- Night/Day

Use the Night/Day menu to choose a dark background with light text and images or a light background with dark text and images. Press ENTER button to toggle between Night and Day.

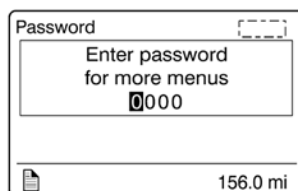

6. Change Password

Use this menu to change the current password. This menu is only accessible if the correct password is entered. The default password is 0000.

1. Mark which password is to be changed with the display UP/DOWN button.
2. Confirm with ENTER button.
3. Set the first digit with the UP/DOWN button.
4. Step to the next digit using ENTER button.
5. Step backwards with ESC button.

5-18 Other Features

DIAGNOSTICS MENU

The Diagnostics menu enables fault tracing on the control units in the vehicle to check for faults. Instrument tests are available to check the telltales, gauges, display and speaker. The part number of a control unit can be identified in the part number menu.

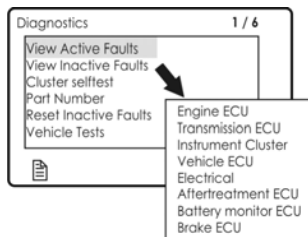

1. View Active Faults

A list of the control units on the vehicle is displayed. Use this function to check for active faults on specific control units.

2. View Inactive Faults

Use this function to check for inactive faults on specific control units.

3. Cluster Selftest

Use this menu to check proper functioning of the following components:

- Telltale lights
- Analog gauges
- Display
- Speakers

The following table describes the available tests. To cancel a test, press the ESC button).

Telltale lights test	Telltales illuminate for approximately five seconds. Press the Esc button to cancel the test.
Analog gauges	The indicators move forwards and backwards between the end positions. They do not show any particular value. This is just a check to confirm that the indicators move, and to make sure the operators are working. Press the Esc button to cancel the test.
Display test	The entire display lights up until the Esc button is pressed.
Speaker Test	A sound is emitted through the speakers. Press the Esc button to cancel the test.

4. Part Number

A list of the control units on the vehicle with their part numbers is displayed in the Part Number menu.

5. Reset Inactive Faults

Use this menu to delete an inactive fault for a particular control unit. Note: it is not possible to delete inactive faults of the Engine ECU.

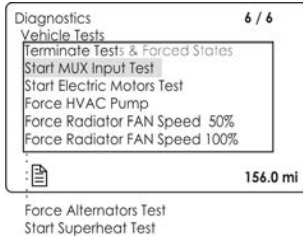

6. Vehicle Tests

Use this menu to perform tests on several components and systems:

- Dashboard switches (Mux Input Test)
- Electric motors, valve and pump contactors (Electric Motors Test)

In case of overheating of the engine due to a malfunction of the radiator fan you can force activation of the fan using ACTIVATE RADIATOR FAN SPEED 50% or 100%.

The DID status line will show TEST to confirm that one of the test modes is active. To cancel an active test, turn the ignition switch to the OFF position or press ESCAPE button, select Terminate Tests & Forced States submenu and then press ENTER button twice. "TEST" will disappear from the DID status line.

For further information concerning these functions, refer to Maintenance Manual section 06: Electrical, under "Available Test Modes" and "Limp-home Modes".

PRE-TRIP ASSISTANCE (OPTION)

The Pre-Trip Assistance helps the driver in completing the pre-trip inspection of the vehicle. This feature is not a substitute for a complete pre-trip inspection. If any system of the vehicle does not pass inspection, the error must be corrected before operating the vehicle. The available pre-trip tests include the Exterior Light Inspection check, and the Air Leakage check.

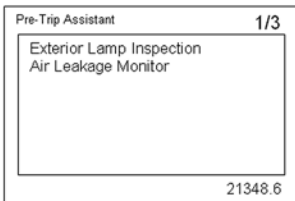

1. Exterior Light Inspection

The Exterior Light Inspection function turns on all the exterior lights simultaneously. This allows the operator to start the test, exit the vehicle and do a visual check that all exterior lights function properly. Press ESCAPE button to end the test and turn off all the exterior lights.

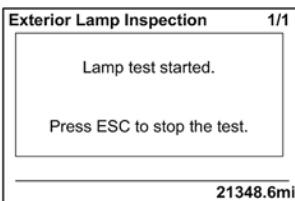
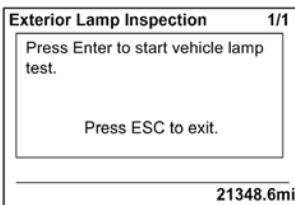

5-20 Other Features

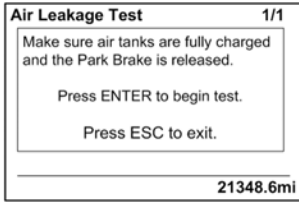

2. Air leakage Monitor

The Air Leakage check allows the driver to accurately measure the amount of air pressure drop in the front and rear brake air systems. After selecting this test from the DID, you are prompted to apply the service brake for 60 seconds. After applying and holding the service brake for 60 seconds, the DID will display the amount of pressure drop in the brake system.

Before starting the test through the DID, complete the following:

- A. Chock the wheels to prevent the vehicle from rolling.
- B. Start the engine and check that the brake systems air pressure is greater than 100 psi.
- C. Turn engine off.
- D. Release the parking and service brakes and allow the system to settle (air gauge needle stops moving).
- E. Press the ENTER button to start the test.
- F. If the air tanks pressure is too low to perform the test (pressure must be greater than 100 psi), the following messages will appear.
- G. You must press and hold brake pedal for 60 seconds, as instructed.

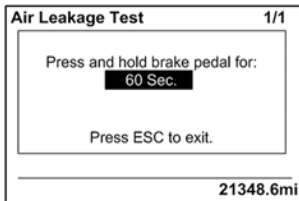
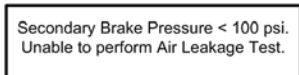
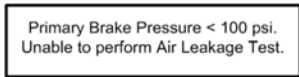

Pressure Leak Test Results			
Tank	Before	After	Drop
F	127	127	0
R	129	129	0

(1)VEC 2044.6mi

- H. Once the brake pressure test is completed the pressure leak test results are displayed.

DATA LOG

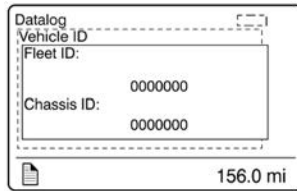

1. Vehicle ID

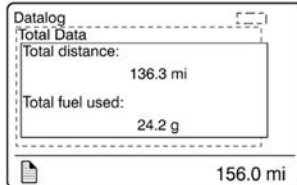

2. Total Data

Total Data menu indicates the accumulated engine values that have been logged during the lifetime of the engine ECU.

Available information:

- Total distance traveled
- Total fuel used
- Total engine hours
- Total idle time
- Total PTO hours
- Total engine revolutions

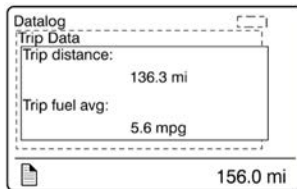

3. Trip Data

This menu displays the trip information listed below. This function must be reset before each measurement (before each new trip or leg) using the Reset Trip Data menu.

Available information for the trip or leg is:

- Trip distance (miles or km)
- Trip fuel average (mpg, liter/100km; km/liter)
- Trip fuel used (gallons or liters)
- Trip duration on cruise control (hours)
- Trip duration with engine rpm greater than economy rpm (hours)
- Trip duration while engine rpm is greater than the desire maximum rpm RPM Limit set in Fleet Limits sub-menu (hours)
- Trip fuel used with engine rpm greater than the economy rpm (gallons/liters)
- Trip average speed (mph, km/h)
- Trip duration with speed greater than the maximum desired speed as set in Fleet Limits sub-menu (hours)
- Trip engine hours
- Trip duration on engine idle (hours)
- Trip fuel used while in engine idle (gallons, liters)

5-22 Other Features

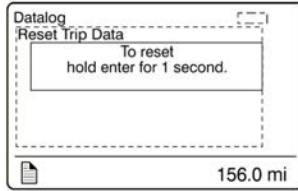

4. Reset Trip Data

This menu can only be accessed if the correct password has been entered.

Use this function to reset measurements of the Trip Data menu before each new trip or leg.

AFTERTREATMENT

This menu permits to the driver to initiate a stationary regeneration, to check the status of the aftertreatment system and to interrupt regeneration.

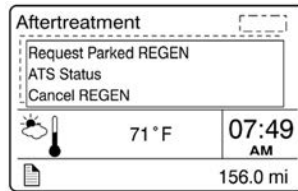

1. Request Parked REGEN

Use this function to initiate a stationary (parked) regeneration.

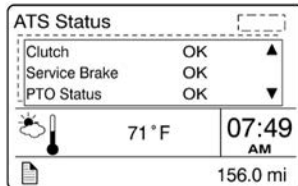

2. ATS Status

The Aftertreatment status sub-menus provide information about the conditions required for performing regeneration. The status can be OK (regeneration allowed), CHECK (regeneration not allowed) or N/A (not applicable). When ATS Status is selected, the following displays (images at left) will show.

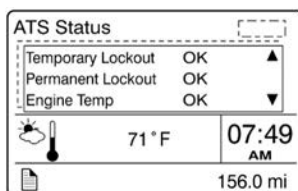
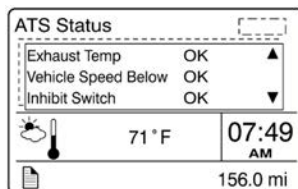
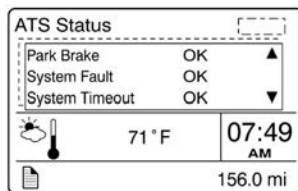
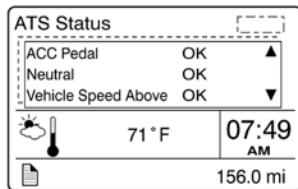

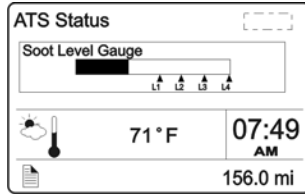

Soot Level Gauge

From the ATS Status sub-menu, you can view the soot level for the Aftertreatment system. When the soot level is high, regeneration is necessary. L1, L2, L3 and L4 under the scale correspond to Level 1 up to Level 4 (see ["DEF_CLOGGING_SEQUENCE_-_INSTRUMENT_CLUSTER_TELLTALE_LIGHT" on page 4](#)).



3. Cancel REGEN

From the Aftertreatment main menu, you can cancel a REGEN cycle.

PASSWORD

Certain functions are password-protected. These passwords give the user access to all password-protected functions. The default password is 0000.

1. Password

The following menus are password-protected and marked with a key symbol in the menus:

- Change Password
- Fleet ID
- Reset Trip Data
- Fault Diagnostics
- Inactive Faults

PREVOST LIAISON (OPTION)

The Prevost Liaison system provides cellular communication between the driver and the fleet operator. The driver can send and receive short text messages, which are visible through the Driver Information Display.

5-24 Other Features

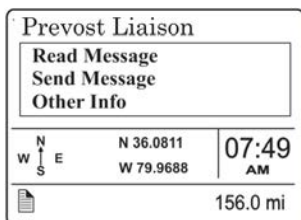

The following menus are available:

1. **Read Message**

- Quick Response (only available if there is a message available)

2. **Send Message**

- Driver & Equipment
- Dispatch Messages
- Free Text

3. **Other Info**

- Comm Liaison Info
- Mailbox Info
- GPS Info
- INI Info
- Configuration Info

INTELLIGENT SLEEP MODE (ISM)

The ISM is a battery-saving mode designed to protect the battery State Of Charge (SOC). The ISM will automatically change the vehicle electrical system from normal functional state to sleep mode if the battery SOC falls below 65%.

Once the vehicle has entered into sleep mode, the only actions needed to put the vehicle back into its normal functional state are:

- To cycle the ignition key from OFF to ON;
or
- To open the entrance door;
or
- To turn on the hazard lights.

The ISM forces the vehicle to go into sleep mode if all the following conditions are met:

1. The engine is not running;
2. The parking brake is applied;
3. The ignition switch is at the ON, ACC positions or at the OFF position but the 15 minutes “wake up” period after engine shutdown is not expired;
4. The battery state of charge of 12V or 24V system falls below 65%.

The red ALTERNATOR telltale will turn on 30 seconds before activation of the sleep mode.



TRANSMISSION RETARDER (OPTION)

The transmission retarder helps to reduce the speed of a vehicle. It improves vehicle control, increases driving safety and permits more economical operation. The retarder provides slowing power when it is most needed, such as when descending mountain roads, in stop-and-go traffic and on crowded freeways.

The transmission retarder is a vehicle-slowng device, not a vehicle-stopping device. It is not a substitute for the service braking system. The service brake must be used to bring the vehicle to a complete stop.

NOTE

Extended use will raise the temperature of the transmission fluid.

The retarder helps reduce speed on grades without using the vehicle's conventional service braking system. This virtually eliminates brake overheating and reduces the risk of a runaway vehicle. A retarder greatly increases the service life of brake pads and discs, resulting in reduced brake maintenance costs.

The retarder is provided with control buttons on the steering wheel and a lever on the steering column (refer to ["TRANSMISSION RETARDER" on page 11](#) in Section 4 Controls and instruments).



WARNING

Do not use the retarder during inclement weather or slippery road conditions.

NOTE

The stoplights automatically illuminate when the vehicle is slowing down after application of the transmission retarder.

NOTE

For vehicles equipped with the Antilock Braking System (ABS), as the wheels start to lock up on slippery roads, the output retarder automatically deactivates until the wheels roll freely.

ENGINE BRAKE



WARNING

A vehicle speed retarding device (such as engine brake) is not intended to replace the service brake systems on your vehicle nor intended to bring your vehicle to a stop. A vehicle speed retarding device is only intended to reduce the speed of your vehicle under certain conditions.

Several types of engine brake can be installed or are standard on certain engines. All are used to reduce wear on the vehicle brake linings.

5-26 Other Features



WARNING

When descending significant grades, use the service brake as little as possible. If the engine does not slow the vehicle to a safe speed, apply service brake and shift to a lower range. Let the engine (and engine brake) slow the vehicle. Keep brakes cool and ready for emergency stopping.

VOLVO ENGINE BRAKE (VEB)

On vehicles equipped with the Volvo Engine Brake (VEB), the engine brake mode is by default, set to the AUTO mode (A) at vehicle start-up.

When running in AUTO (A) mode, the engine brake is gradually applied to 100% of the braking power when the driver pushes the brake pedal. Since AUTO (A) mode will not reduce vehicle momentum unless the brakes are applied, it will have no impact on fuel consumption.

The driver can also choose two other modes using the steering wheel switches; Engine brake LOW (1) and engine brake HIGH (2).

When set to the engine brake LOW (1) mode, 50% of the engine brake power will be applied when the driver releases the accelerator pedal. Using engine brake HIGH (2) will apply 100% of the braking power.

It must be noted that since engine brake LOW (1) and engine brake HIGH (2) will reduce vehicle speed upon release of the throttle pedal, they may negatively impact fuel consumption if used for extended periods of time.

On vehicles equipped with an engine brake switch, it is possible to deactivate the engine brake (OFF mode). To do so, the driver must press the engine brake switch located on the left side of the dashboard.

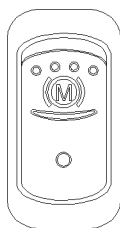

Engine Brake Switch

NOTE

When using engine brake LOW (1) or HIGH (2) mode, pressing the steering switch OFF button will switch back to the default AUTO (A) mode.



DRIVER PEDALS	ENGINE BRAKE MODE	ENGINE BRAKE FORCE
ANY POSITION	(OFF)	0%
ACCELERATOR PEDAL RELEASED 	(A)	0%
BRAKE PEDAL PUSHED 	(A)	100%
ACCELERATOR PEDAL RELEASED 	(1)	50%
	(2)	100%

FIGURE 1: ENGINE BRAKE FORCE APPLIED ACCORDING TO SELECTED MODE AND DRIVER PEDAL POSITION

NOTE

Engine brake is safe to use in any road conditions including adverse conditions.

CRUISE CONTROL AND ENGINE BRAKE

When cruise control is enabled by the driver, the engine brake mode is forced to AUTO (A) mode

and the engine brake will progressively engage up to 100% if the selected cruise speed is exceeded by approximately 2 km/h (1.25 mph). Manually switching to engine brake LOW ① or HIGH ② using the steering wheel switches will deactivate the cruise control.

CRUISE CONTROL & SPEED	ENGINE BRAKE MODE	ENGINE BRAKE FORCE
<div style="border: 1px solid black; padding: 5px; text-align: center; font-weight: bold; font-size: 2em;">CRUISE</div> <p style="text-align: center;">+ CRUISE SPEED SET + 2 Km/h</p>	(OFF)	0%
	(A)	UP TO 100%
	①	N/A
	②	N/A

FIGURE 2: ENGINE BRAKE FORCE APPLIED WITH CRUISE CONTROL

NOTE

On vehicles equipped with the Allison transmission, if cruise control is enabled, the current engine brake mode is saved in the vehicle computer (MCM) memory and the engine brake mode is set to Auto mode (A). When the cruise control is disabled, the engine brake mode changes back to the mode saved in the MCM memory.

ABS, TRACTION CONTROL SYSTEM (TCS) & ELECTRONIC STABILITY CONTROL (ESC)

ANTILOCK BRAKING SYSTEM (ABS)

The purpose of the Antilock Braking System (ABS) is to maintain vehicle stability and control during braking and to minimize the stopping distance in any road condition.

On slippery roads and more generally in emergency situations, over-braking frequently induces wheel locking. Wheel locking greatly increases breaking distance on any road surface. Locked wheels also impede directional control

and cause severe tire abrasion. An antilock braking system provides maximum braking performance while maintaining adequate control on slippery roads.

The basis of ABS is constant monitoring of wheel parameters during braking. Sensors on each wheel of the front, drive and tag axles constantly measure wheel speed during braking. This information is transmitted to a six-channel electronic processor which senses when any wheel is about to lock. Modulating valves quickly adjust brake pressure (up to 5 times every second) to prevent wheel lock. Each wheel is therefore controlled according to the available grip.

In this way, the vehicle is brought to a stop in the shortest possible time while remaining stable and under the driver's control.

WARNING

Vehicles following ABS-equipped vehicles may not be able to brake as fast on slippery roads.

TRACTION CONTROL SYSTEM (TCS)

TCS controls wheel spin during vehicle acceleration to improve traction.

- The TCS system will intervene automatically and apply braking pressure to a spinning wheel transferring engine power to the other drive wheel that have better traction. This feature is active only at speeds below 25 mph (40 km/h).
- If all of the drive wheels begin to spin, the TCS system will reduce engine throttle to improve traction at all of the drive wheels.

If drive wheels begin to lose traction during acceleration, TCS will engage automatically to assist the driver in accelerating the vehicle. The TCS icon in the DID will flash rapidly to let you know whenever TCS is actively functioning.

ELECTRONIC STABILITY CONTROL (OPTION)

The Electronic Stability Control (ESC) is a feature for ABS-equipped vehicles that reduces the risk of rollovers and loss of control. The ESC system features include the RSP Roll Stability Program and Yaw Control.

5-28 Other Features

The RSP system counteracts the tendency of a vehicle to tip over while changing direction (typically, while turning).

To reduce the risk of rollover, the RSP system detects potential rollover conditions and slows the vehicle both by reducing engine throttle (and hence, engine torque) and by applying service brakes as needed at the appropriate wheels.



WARNING

During an RSP system intervention, the vehicle automatically decelerates. The RSP system can slow the vehicle with or without you applying the brake pedal, and even when you are applying the throttle.

During an RSP system intervention, you can always use your service brake pedal to increase the braking pressure that will be applied. However, if you were to apply less braking pressure than needed or even if you release the brake pedal entirely during an intervention, the RSP system will continue to apply the necessary amount of braking pressure automatically to the appropriate wheels to mitigate a potential rollover.

Yaw Control is a feature that reduces the risk of loss of control. If a vehicle's tires start to slide during a turn, Yaw Control counteracts the tendency of that vehicle to spin (or yaw), thereby reducing the risk of loss of control. Many factors, including road conditions, load distribution and driving behavior, can contribute to the development of a spin.



WARNING

In the case where a vehicle equipped with the ESC system pulls a trailer, the latter must be equipped with ABS.



WARNING

Even with ESC-equipped vehicles, the driver remains responsible for ensuring vehicle stability during operation.

NOTE

For further details, consult "Bendix ABS Operator's Manual"

DRIVER CONTROLLED DIFFERENTIAL LOCK (DCDL)

By actuating the dashboard switch, the driver can lock or unlock differential action.

The purpose of the DCDL is to provide maximum vehicle traction and control on unfavorable road surface conditions. When the DCDL is actuated, a clutch collar completely locks the differential case, gearing, and axle shafts together. This feature maximizes traction to both wheels. The lock position will also protect against spinout damage to the differential. The DCDL should not be actuated when favorable road conditions exist. DCDL is an optional feature.

OPERATION TIPS

1. The DCDL can be locked or unlocked if the vehicle is standing still or moving at a constant low speed when the wheels are not spinning, slipping, or losing traction.
2. When the DCDL is locked, operate the vehicle at low speeds. DCDL will not engage and will disengage in speed higher than 5 MPH (8 km/h).
3. When the DCDL is locked, the vehicle's turning radius will increase. This condition is called "understeer." The driver must use caution, good judgment and drive at low speeds when operating the vehicle with the DCDL locked.
4. Always unlock the DCDL as soon as the need for maximum traction has passed and the vehicle is traveling on a good road.
5. Do not lock the DCDL when the wheels are slipping or losing traction, or damage to the axle can result.
6. Do not lock the DCDL when the vehicle is traveling down steep grades, or potential loss of vehicle stability could occur.

LOCKING THE DCDL

When encountering poor road conditions where maximum traction is needed, follow the recommended procedures:

1. Without the wheels spinning, slipping or losing traction, flip the DCDL control switch to the "LOCK" position while maintaining a constant vehicle speed.
2. Let up momentarily on the accelerator to relieve torque on the gearing, allowing the DCDL to lock.
3. When the DCDL is fully locked, the vehicle will have an "understeer" condition when making turns. Proceed cautiously over poor road conditions.

UNLOCKING THE DCDL

When the vehicle can safely operate and driving conditions have improved, disengage the DCDL following the recommended procedures:

1. Flip the control switch to the "UNLOCK" position, when the vehicle is stopped or when traveling at low speed while the wheels are not spinning, slipping or losing traction.
2. Let up momentarily on the accelerator to relieve torque on the gearing, allowing the DCDL to unlock.
3. Resume driving at normal speed using good driving judgment.

RETRACTABLE TAG AXLE

Tag axle is controlled by a valve located on the lateral control panel. The valve can be switched to either the wheels up or wheels down position. The axle will be automatically raised or lowered by air pressure according to the valve position. Refer to ["TAG AXLE CONTROL VALVE" on page 15](#) in Section 4, Controls and Instruments.

The tag axle service brakes operate only when the tag axle is in the wheels down position. Never lower the tag axle while the coach is moving. A pictogram appears in the Driver Information Display if the vehicle speed exceeds 12 mph (20 km/h) with tag axle raised. The tag axle can be raised in tight maneuvering areas like in a parking

lot or to make it easier to turn a short corner. The tag axle shortens the wheelbase and allows tighter turning. Raising the tag axle transfers extra weight and additional traction to the drive wheels providing improved control on slippery roads.



CAUTION

Do not use tag axle in raised position for an extended period. Raising tag axle increases load on the drive axle, suspension and tires.

Do not drive vehicle with tag axle raised when speed is exceeding 12 mph (20 km/h).

In order to prevent damage to the suspension, always raise the tag axle before lifting the coach.

KEYLESS ENTRY SYSTEM

This system, located below the entrance door handle, is used to lock or unlock the entrance door, the baggage compartment and the service compartment. Unlocking the entrance door using the keyless system will also disarm the intrusion protection and the anti-theft system.

At the time of purchase, the new owner will be given a default four (4) digit access code to unlock the vehicle and a permanently programmed six (6) digit authority code that will allow him to program up to 40 alternate four (4) digit personal access codes (see "programming and managing personal codes" instructions below).

Do not push the keyless buttons with a key, pencil or any other hard or sharp object as the buttons could be damaged. Although each button is provided with two digits separated by a vertical line, there is only one contact per button. Press in the center of the button.

NOTE

Pressing a system key will illuminate the keyboard, unlocking the entrance door will also illuminate the vehicle step lights. Both illumination will go off after a 30 seconds period of inactivity.

5-30 Other Features

KEYLESS OPERATING INSTRUCTIONS

Entering a valid access code enables secure operation. After entering the access code, the keypad is enabled for 5 seconds and a fifth button press initiate an action.

NOTE

A double beep after entering an access code indicates a correct code and readiness for an action command.

To Unlock The Entrance Door And Disarm The Anti-theft System:

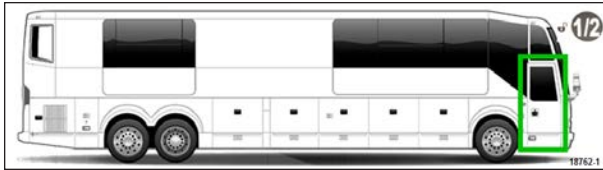

- Enter your personal code or the default access code followed within 5 seconds by the 1/2 key.

To Unlock The Baggage And Service Compartment Doors:

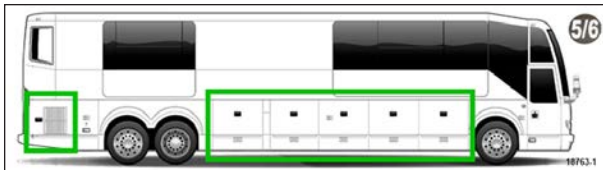

- Enter your personal code or the default access code followed within 5 seconds by the 5/6 key.

To Unlock All Doors Simultaneously:

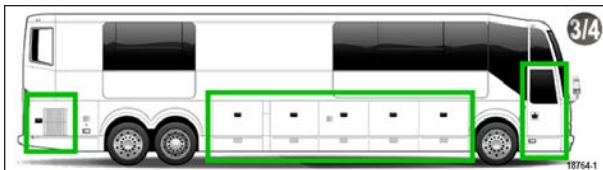

- Enter your personal code or the default access code followed within 5 seconds by the 3/4 key.

To Lock The Doors And Activate The Anti-theft System:

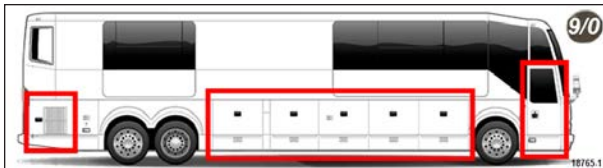

- Press the 9/0 key for 2 seconds (no access code required).

NOTE

The lock function will not function when the ignition is in the ON position or the entry door is open.

NOTE

After repeated attempts to enter codes (20 button presses without enabling), the keypad will enter in an inactive mode that disables buttons for 60 seconds. The lock indicator will flash amber and red during this state.

If a partial validation code is entered or no action button is pressed within 5 seconds, the keypad will revert back to disabled condition and the access code will have to be entered again.

PROGRAMMING AND MANAGING PERSONAL CODES

It is possible to program up to 40 four (4) digit personal access codes to unlock the entrance door and compartments. These codes do not replace the default code that is factory supplied with the vehicle.

When programming codes, do not choose codes that present the numbers in sequential order, studies show that people who idly press the buttons usually press a sequential pattern. Also, do not select a code that uses the same button four times, thieves can easily figure out these types of codes.

To Add A New Personal Code:

- Choose and memorize a four (4) digit personal code.
- Press and hold the 5/6 key for five seconds (keypad will start to beep and flash).
- Enter the vehicle factory six (6) digit authority code.
- Press the 1/2 key (a short beep will be heard, validating the action).

NOTE

- If the 40 codes memory is already full, a long beep will be heard.
 - At any time, press the 9/0 key to exit programming mode.

- Enter the chosen personal code (three confirmation beeps will be heard).
- Re-enter the code to confirm the entry (four confirmation beeps will be heard).

Press the 1/2 key and repeat the last two steps to enter additional codes.

To Delete A Personal Code:

- Press and hold the 5/6 key for five seconds (keypad will start to beep and flash).
- Enter the vehicle factory six (6) digit authority code.
- Press the 3/4 key (a short beep will be heard, validating the action).

NOTE

- If the 40 codes memory is already empty, a long beep will be heard.
 - At any time, press the 9/0 key to exit programming mode.

- Enter the code to be deleted (three confirmation beeps will be heard).
- Re-enter the code to confirm the deletion (four confirmation beeps will be heard).

Repeat the process to delete additional codes.

To Delete All Stored Personal Codes:

- Press and hold the 5/6 key for five seconds (keypad will start to beep and flash).
- Enter the vehicle six (6) digit authority code.
- Press the 3/4 key (a short beep will be heard, validating the action).

NOTE

-If the 40 codes memory is already empty, a long beep will be heard.
 -At any time, press the 9/0 key to exit the programming mode.

- Press the 1/2 and the 9/0 keys simultaneously (a confirmation double beeps will be heard).
- Re-enter the authority code to confirm the deletion (four confirmation beeps will be heard, a two second beep indicates an incorrect authority code).

REMOTE ENTRY TRANSMITTER

Hand held transmitters (key FOB) can be used to control the keyless door lock system.



To Lock Doors And Arm The Intrusion Protection And Anti-theft System Simultaneously:

- Press LOCK (top) button on the transmitter once..

NOTE

The lock function will not function when the ignition is in the ON position or the entry door is open.

NOTE

The intrusion protection and anti-theft system will be set after a 10 seconds delay.

To Unlock The Entrance Door:

- Press UNLOCK DOOR (bottom) button on the transmitter. This will unlock the door and disarm the anti-theft system.

To Unlock The Baggage Compartment Doors:

- Press UNLOCK BAGGAGE (right) button. This will not disarm the alarm.

5-32 Other Features

To Set Off The Personal Security Alarm (Panic Mode):

- Press and hold the red (left) PANIC button for two seconds. The horn will sound and the marker lights will flash for 30 seconds.

To Deactivate The Personal Security Alarm:

- Press any FOB button again or unlock the entrance door using the keypad.

PROGRAMMING TRANSMITTERS

Up to 20 transmitters can be used with the keyless entry system. To add or replace transmitters, the system must be first put into learn mode using the vehicle keypad.

To program transmitters perform the following steps:

- Hold the 5/6 button of the keypad for 5 seconds (keypad will start to beep and flash).
- Enter the vehicle factory six (6) digit authority code.
- Hold button 7/8 for 5 seconds, a double beep will play, confirming that the system is now in learn mode.
- Press the lock button on each transmitter to be programmed for 5 seconds with a two seconds pause between each transmitter.
- Press the 9/0 button twice to exit learn mode (the keypad will beep twice and stop flashing).

NOTE

If more than 20 transmitters are programmed, additional transmitters will over-write the first ones.

SLIDE-OUT OPERATION

H3-45 VIP vehicles can accommodate up to 4 slide-out units. Slide-out units located in the front right (front curb side) position have a mobile floor system creating a flush floor at room extension.

Due to the high current demand and safety requirements of the slide-out system, room operation is on a "first in first served" basis, meaning only one slide-out unit may be operated at a time.

SAFETY PRECAUTIONS

Before operating both slide-out units, proceed to the following verifications:

- Make sure that the area outside of the slide-out is clear and that there are no persons or objects within 3 feet of the slide-out outside wall. *Serious personal injury or damage to the vehicle components may occur.*
- Make sure that the area inside the motor home where the room retracts (30" for the front and 24" for the rear slide-out) is free of people or obstacles. *Serious personal injury or damage to the vehicle components may occur.*
- For slide-out units with flush floor option, make sure there are no objects or persons on the floor during operation.
- In temperatures below freezing point, make sure that the entire sliding surface outside the slide-out is free of snow, ice or sleet. *Failure to clear all ice or snow may seriously damage the inflatable seal.*
- The parking brake must be applied.
- The transmission must be in the "NEUTRAL" position.
- Open a window to avoid slide-out movement restriction.
- Level the vehicle.

FRONT AND REAR SLIDE-OUT OPERATION

Before extending or retracting the slide-out, please make sure all the following conditions are met:

1. Make sure the air pressure is 110 psi minimum on the auxiliary air pressure gauge.
2. Make sure the parking brake is applied and that transmission is in the "NEUTRAL" position.
3. Turn the ignition key to the "ON" position, start the engine and set the RPM to fast idle.

CAUTION

Before extending or retracting the slide-out, always open a window to avoid movement restriction and to prevent the motor from stopping in overcurrent because of a vacuum or pressure build up inside the vehicle.

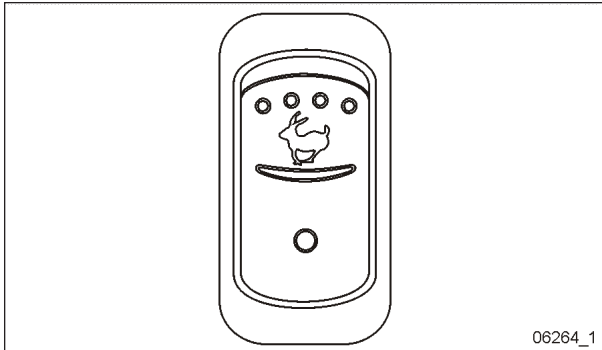

06264_1

FIGURE 3: FAST IDLE BUTTON

Slide-out Extending Operation

With the ignition switch to the "ON" position and the engine running, press and hold down the rocker switch on the control pad to the "OUT" position. The green indicator light "ROOM IN OPERATION" will come on to indicate that the slide-out operation cycle is activated. The following actions will be done in sequence:

- Deflation of the inflatable seal
- Movement of the slide-out to its full "OUT" position
- Optional flush floor rises, slight retract of the room to secure and reduce gaps in flooring.

Then releasing the rocker switch will permit the following actions:

- Re-inflation of the seal

When the rocker switch is released, the green indicator light goes out. Note that for safety reasons, releasing the rocker switch will stop the slide-out movement instantly. At any time, releasing the rocker switch from the "OUT" position and pressing it to the "IN" position will reverse the operation.

CAUTION

The inflatable seals can be re-inflated only when the slide-out is in its full "OUT" or full "IN" position. Do not leave the slide-out in any position other than the full extended or closed position as water infiltration may occur. The indicator light on the control pad must be OFF.

NOTE

A green blinking light on the control pad indicates an error condition or missing operation condition on the corresponding slide-out. Refer to "[SLIDE-OUT TROUBLESHOOTING](#)" on page 37 if that situation occurs.

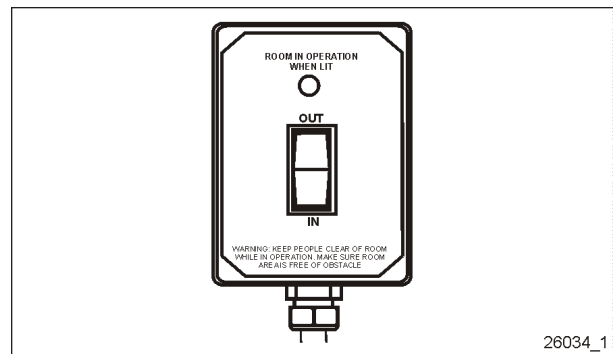

26034_1

FIGURE 4: SLIDE-OUT CONTROL PAD

Slide-out Retracting Operation

With the ignition switch to the "ON" position and the engine running, press and hold down the rocker switch to the "IN" position to retract the slide-out. Note that the green indicator light "ROOM IN OPERATION" will come on. When the movement of the slide-out to its full "IN" position is completed, the rocker switch can be released to allow the re-inflation of the seal. The green indicator light goes out as the rocker switch is released. At any time during the slide-out movement, releasing the rocker switch will stop the operation instantly.

CAUTION

The inflatable seals can be re-inflated only when the slide-out is in its full "OUT" or full "IN" position. Do not leave the slide-out in any position other than the full extended or closed position as water infiltration may occur.

5-34 Other Features

SLIDE-OUT MANUAL OVERRIDE PROCEDURE



CAUTION

Never use an impact power tool to manually operate the slide-out. Doing so would damage the various mechanical components of the slide-out.

Do not over extend or over retract the slide-outs. Always refer to the slide-out decal for correct direction of rotation (clockwise or counter clockwise).

In case of power retracting system failure, it is possible to use the manual override procedure to retract or extend the slide-out.

The manual override procedure consist in rotating the slide-out motor shaft extension using a cordless power drill with a 3/8" hexagonal bit.

However, it is very important to follow all the instructions very carefully to assure that the inflatable seal or the retraction mechanisms are not damaged.



CAUTION

Manually extending the optional front right Prevost slide-out with flush floor should be attempted with extra care as a last resort.

Serious damage to the mechanical components may result.

This particular slide-out configuration uses two electronically synchronized motors for room extension. As a result, manually extending the room is not recommended.

Refer to the procedures and guidelines in the maintenance manual.

However the floor lifting portion of the mechanism can be hand operated. Refer to particular instructions below.

Preliminary Conditions For Manual Override Procedure

Before using the slide-out manual override procedure, make sure that the problem cannot be solved by one of the following simple checks:

- Make sure that none of the breakers are tripped (the breakers are located inside the VEC on the slide-out control panel and the

main slide-out breaker is located in the engine R.H. side access compartment).

- Make sure the parking brake is applied and that transmission is in the "NEUTRAL" position.
- Make sure the voltage is high enough by running the engine at fast idle or having the battery charger connected.



CAUTION

Before extending or retracting the slide-out, always open a window to avoid movement restriction and to prevent the motor from stopping in over current because of a vacuum or pressure build up inside the vehicle.

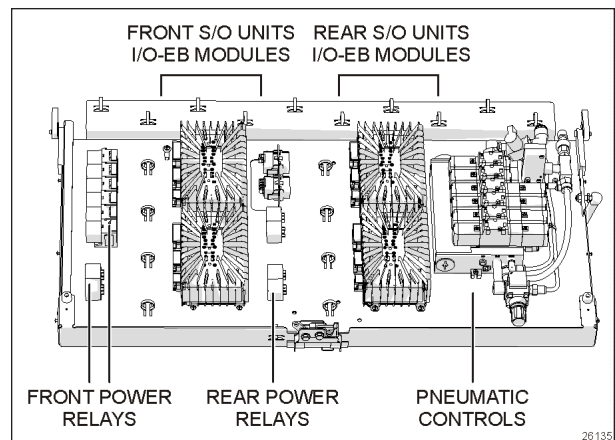

FIGURE 5: SLIDE-OUT CONTROL PANEL

Manual Retracting Procedure – Front And Rear Slide-out

1. Turn the ignition switch to the "OFF" position, and remove the ignition key for more safety.
2. Deflate the inflatable seal by using the relieving shut-off valve located on the slide-out control panel. Turn the handle clockwise to deflate the seal. Make sure the pressure indicator reading is "0 psi".



CAUTION

The pressure in the inflatable seal must be completely relieved to prevent any damage to the seal.

NOTE

When air pressure is relieved using the shut-off valve, the normal extending and retracting operation cycle is disabled, for that reason the slide-out cannot be moved using the control pad.

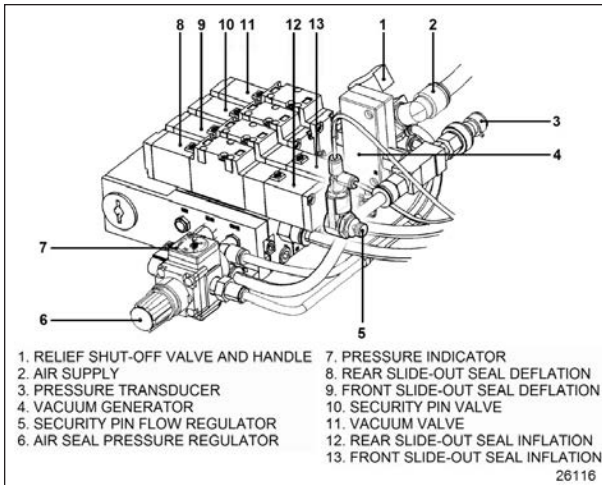

FIGURE 6: PNEUMATIC CONTROL PANEL

NOTE

Refer to the slide-out decal for correct direction of rotation (clockwise or counter clockwise).

3. To move the slide-out, use a cordless power drill with a 3/8" hexagonal bit on the shaft extension of the slide-out motor.
4. Rotate the slide-out motor shaft extension with the power drill until the slide-out comes to its closed position.
5. Once the slide-out room is lined up to its closed position, remove the tool from the motor.

NOTE

The front slide-out motor is located inside the 2nd baggage compartment while the rear slide-out motor is accessible from inside the vehicle, under the bed structure.

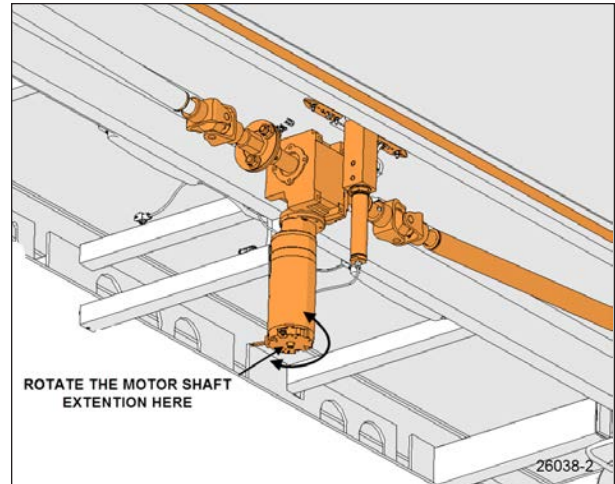

FIGURE 7: SLIDE-OUT MOTOR MANUAL ACTIVATION



CAUTION

Slow down on the closing speed as the slide-out approaches its closed position. As soon as the "in limit" stoppers come in contact with their bearing surface, stop immediately the power drill rotating movement. Not doing so could overload the drive mechanism and cause damage to the reduction gearbox.

6. Finally, the inflatable seal can be re-inflated by turning the shut-off valve handle counterclockwise. Check the pressure gage on the inflatable seal regulator to see if the pressure is increasing to around 15 psi. Needle should point between the green indicator pegs.

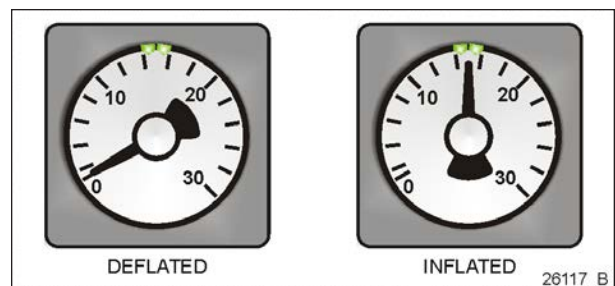

FIGURE 8: INFLATABLE SEAL PRESSURE GAGE

NOTE

The slide-out control system inhibits transmission range selection to prevent the vehicle from moving if the slide-out is not in its full "IN" position.

5-36 Other Features

Manual Extending Procedure – Front And Rear Slide-out

1. Apply parking brake to disengage the security pin from the receptacle.
2. Turn the ignition switch to the "OFF" position, and remove the ignition key for more safety.
3. Deflate the inflatable seal by using the relieving shut-off valve located in the slide-out control panel. Turn the handle clockwise to deflate the seal. Make sure the pressure indicator reading is "0 psi".



CAUTION

The pressure in the inflatable seal must be completely relieved to prevent any damage to the seal.

NOTE

When air pressure is relieved using the shut-off valve, the normal extending and retracting operation cycle is disabled, for that reason the slide-out cannot be moved with the control pad.

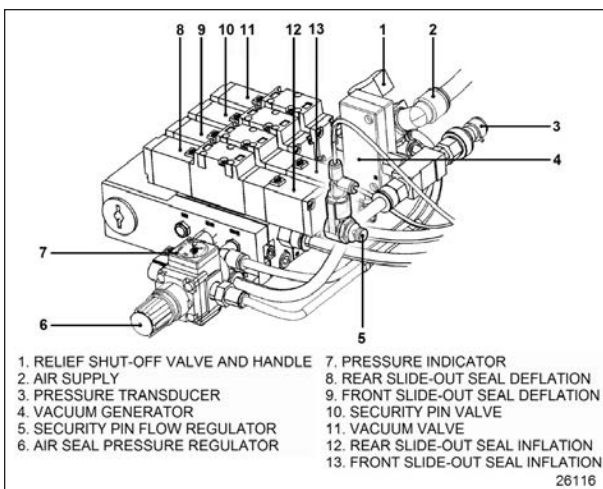

FIGURE 9: PNEUMATIC CONTROL PANEL

NOTE

Refer to the slide-out decal for correct direction of rotation (clockwise or counter clockwise).

4. To move the slide-out, use a cordless power drill with a 3/8" hexagonal bit on the shaft extension of the slide-out motor.

5. Rotate the slide-out motor shaft extension with the power drill until the slide-out comes to its opened position.
6. Once the slide-out is lined up to its opened position, remove the tool from the motor.

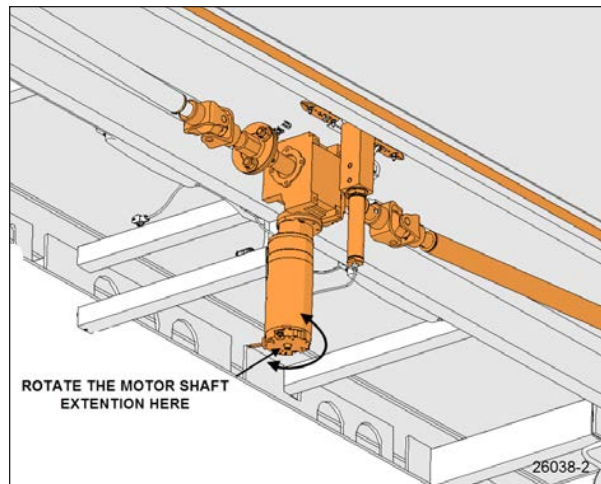

FIGURE 10: SLIDE-OUT MOTOR MANUAL ACTIVATION

NOTE

The front slide-out motor is located inside the 2nd baggage compartment while the rear slide-out motor is accessible from inside the vehicle, under the bed structure..



CAUTION

Slow down on the closing speed as the slide-out approaches its extended position. As soon as the "out limit" stoppers come in contact with their bearing surface, stop immediately the power drill rotating movement. Not doing so could overload the drive mechanism and cause damage to the reduction gearbox.

7. Finally, the inflatable seal can be re-inflated by turning the shut-off valve handle counterclockwise. Check the pressure gage on the inflatable seal regulator to see if the pressure is increasing to around 15 psi. Needle should point between the green indicator pegs.

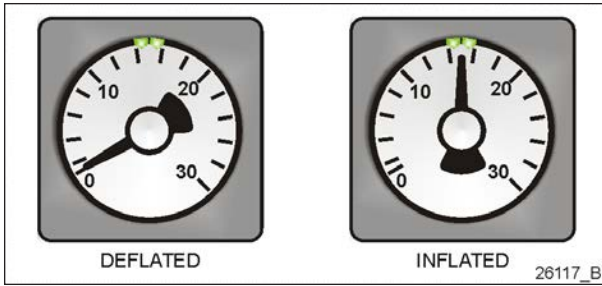

FIGURE 11: INFLATABLE SEAL PRESSURE GAGE

NOTE

The slide-out control system inhibits transmission range selection to prevent the vehicle from moving if the slide-out is not in its full "IN" position.

MOBILE FLOOR HAND CRANK PROCEDURE

The floor lifting mechanism of the front right (curb side) slide-out room can be manually operated in the event of a power failure. You will need a 6mm (1/4") Allen key to operate the actuator.

CAUTION

Do not use an electric drill or other similar tool to operate the linear actuator. Permanent damage to the unit may result.

As a safety measure, unplug the unit before attempting to hand crank the unit.

NOTE

If the actuator is operated as a hand crank, it must only be operated by hand, otherwise there is a potential risk of overloading and hereby damaging the actuator.

Hand Crank Torque: 6-8 Nm.

Hand Crank Max Speed: 65 rpm

The actuator is located under the floor in the second right luggage compartment.

After removing the cover (4 screws), locate the hand crank hex socket on the actuator (arrow below).

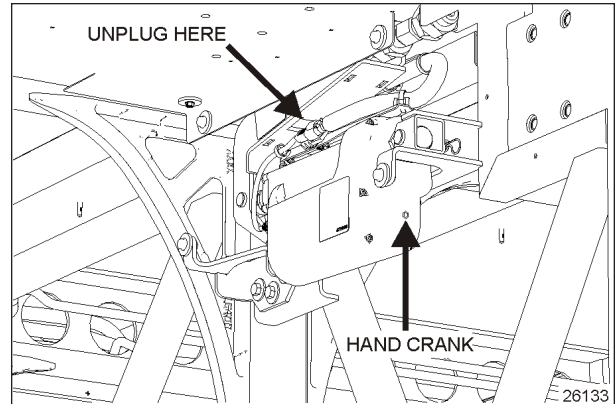

FIGURE 12: MOBILE FLOOR HAND CRANK HEX SOCKET LOCATION

The cover over the Allen Key socket must be unscrewed before the 6mm Allen Key can be inserted to operate the hand crank.

CAUTION

Make sure there are no objects or persons on or around the floor while hand cranking. Slowly operate the actuator at the indicated speed and torque.

SLIDE-OUT TROUBLESHOOTING

Error Condition Or Missing Operation Condition

When an error condition or a missing operation condition is present on a slide-out, the green indicator light on the corresponding control pad starts blinking upon releasing of the IN/OUT rocker switch.

Turning the ignition OFF and ON again, will stop the blinking and reset the fault. If the error condition or a missing operation condition is still present, the blinking will start again the next time that the slide-out is operated.

To initiate fault diagnostic, use the DID right after operating the slide-out without cycling the ignition switch.

NOTE

The DID is the main tool for troubleshooting a multiplex vehicle. It is essential to have it in working condition.

5-38 Other Features

Fault Diagnostic

To get detailed information about the error condition or the missing operation condition, request a diagnostic using the dashboard Driver's Info Display (DID). Check if there are active errors in the slide-out electrical system. With the DIAGNOSTICS menu, highlight VIEW ACTIVE FAULTS and then highlight ELECTRICAL SYSTEM to request a diagnostic of the electrical system from the MCM.

Press the enter key. If applicable, the DID shows the device ID, the fault messages or fault codes recorded. When more than one fault is recorded, an arrow pointing down appears on the right of the display. Use the down arrow to see all the fault messages.

Once the problem is corrected, the DID will still show the fault as being active. Leave VIEW ACTIVE FAULTS up to the main menu. Then return to DIAGNOSTICS, VIEW ACTIVE FAULTS, and then ELECTRICAL SYSTEM. The DID should not display any faults.

SLIDE-OUT TROUBLESHOOTING TABLE

PROBLEM	CAUSE	CORRECTIVE ACTION
The slide-out functions normally but the control pad green indicator light blinks.	<p>Something is defective and may eventually create an issue if not repaired. The problem may be:</p> <p>A. Faulty limit sensor causing the slide-out to stop in overcurrent;</p> <p>B. CAN network problem causing the transmission inhibit safety to be non-operational;</p> <p>C. Vacuum pressure transducer disconnected or damaged (vacuum is applied for a fixed time of 7 seconds);</p> <p>D. Seal inflating valve solenoid open circuit (the seal is not re-inflated and water can penetrate in the vehicle);</p> <p>E. Security pin valve solenoid open circuit (the security pin is not extended while vehicle is riding).</p>	Using the Driver Information Display (DID), request a diagnostic of the electrical system.
FLUSH FLOOR S/O ONLY Problem: The slide-out stops extending/retracting and the green indicator light flashes rapidly 3 times then one long flash (cycle repeats).	At least one of the mobile floor position switches is defective and the system requires operator's input to resume normal operation. The floor might also be out of level.	Depress the handheld control in the desired direction 3 times rapidly and hold it the fourth time until the slide out has reached the desired position.
FLUSH FLOOR S/O ONLY Problem: Slide out does not extend/retract.	The slide out stopped moving due to an obstruction.	Clear the path of the S/O and /or mechanism and resume operation.
FLUSH FLOOR S/O ONLY Problem: The slide-out does not extend/retract.	At least one of the motors is defective.	Refer to manual override procedure.
FLUSH FLOOR S/O ONLY Problem: Motor stopping temporarily during extend/retract sequence.	The slide out motors goes out of synchronization.	Make sure that load is distributed evenly across the slide out. Check for wear/obstructions in the slide out mechanism.

5-40 Other Features

PROBLEM	CAUSE	CORRECTIVE ACTION
The slide-out does not extend.	The parking brake is not seen by the controller as being applied;	Make sure the parking brake is applied. Confirm parking brake application with the parking brake light on the telltale panel.
	Not enough air pressure in the accessory air tank to permit proper operation of the vacuum generator;	Run the engine at fast idle a few minutes to increase air pressure in the accessory air tank and try again.
	Faulty vacuum generator, connection to the vacuum generator open, seal deflating valve solenoid open circuit;	Turn the relieving shut-off valve handle clockwise to deflate the inflatable seal, disconnect the pressure transducer. Do not forget to reconnect the pressure transducer and to close the relieving shut-off valve. Failure to do so could damage the seal and lead to water infiltration;
	I/O-B module output defective, regulated 5- volt supply to sensors shorted to ground, "out limit" sensor shorted to ground, connection to the motor negative relay solenoid open circuit;	Operate the slide-out with the manual override procedures.
The slide-out does not retract.	Not enough air pressure in the accessory air tank to permit proper operation of the vacuum generator;	Run the engine at fast idle a few minutes to increase air pressure in the accessory air tank and try again.
	Faulty vacuum generator, connection to the vacuum generator open, seal deflating valve solenoid open circuit;	Turn the relieving shut-off valve handle clockwise to deflate the inflatable seal, disconnect the pressure transducer. CAUTION, do not forget to reconnect the pressure transducer and to close the relieving shut-off valve. Failure to do so could damage the seal and lead to water infiltration;
	I/O-B module output defective, "in limit" sensor shorted to ground, connection to the motor positive relay solenoid open circuit;	Operate the slide-out with the manual override procedures.
When extending, the slide-out stops after having extended by 1 inch.	The security pin valve solenoid circuit is shorted to (+) 24-volt and the pin remains engaged;	Disconnect air supply from the safety pin cylinder;
Transmission DRIVE range or REVERSE cannot be selected (the slide-out telltale light is illuminating).	Slide- out not in full "in" position;	Retract slide-out.
	Faulty "in limit" sensor. The slide-out is retracted but the controller doesn't not see it as retracted.	Confirm that all slide-outs are retracted. On the slide-out control panel, disconnect the 5 pins green connector on the I/O- B module to disable the transmission inhibit. CAUTION, this is a temporary measure, the vehicle must be serviced as soon as possible.

PROBLEM	CAUSE	CORRECTIVE ACTION
Slide-out does not retract or extend when depressing the control switch.	Electrical motor failure;	Replace motor.
	Speed reduction gearbox failure;	Inspect gearbox components, particularly: bronze wheel or first reduction stage output shaft. Replace damaged components.
	Security pin still engaged in receptacle;	Disengage pin and check if air cylinder is damaged.
Slide-out is not straight once retracted or during retracting or extending operation.	Broken rack tooth;	Replace rack.
	Faulty rack attachment;	Tighten mounting bolts, apply proper torque and use "Loctite Threadlocker" (replace rack if necessary).
	Faulty shaft key at speed reduction gearbox or jaw coupling;	Replace key or component having a damaged keyway.
	Shaft breaking;	Replace shaft.
	Flange bearing attachment loose.	Reposition shaft and tighten flange bearing mounting bolts.
Slide-out moves out slightly when vehicle is traveling.	Lower "in limit" stoppers are not leaning against the structure at the moment when the "in limit" sensor detects the magnet;	Adjust the sensor position in order to have contact of the stoppers against the structure at the time when the system stops the slide-out retraction.
Slide-out moves when vehicle is moving.	Inflatable seal not inflated	Adjust the sensor position in order to have contact of the stoppers against the structure at the time when the system stops the slide-out retraction.
Slide-out moves when vehicle is moving.	Inflatable seal not inflated	Check seal condition and seal air supply system.
Slide-out retracts or extends with difficulty.	Foreign matter accumulated in the linear bearing;	Inspect the linear bearing end seals to see if they are in good condition. If not, replace the end seals and clean the inside of linear bearing.
Slide-out oscillates vertically when retracting or extending.	Linear bearing balls hardened due to a too heavy load;	If balls clearance is excessive, replace linear bearing.
	Linear bearing mounting bolts loose;	Tighten mounting bolts.
Slide-out vibrating or noisy when extending or retracting.	Worn-out anti-friction coating on wiper seal around slide-out;	Replace wiper seal.
	Lower acetal plastic block rubbing against rail;	Remove lower acetal plastic block and machine down 1mm (0.039").
Slide-out does not retract up to its full "in" position.	Interference between the exterior extrusion and the vehicle upper horizontal member above the slide-out;	Check for outer wiper seal lip straightness on the slide-out roof.

5-42 Other Features

PROBLEM	CAUSE	CORRECTIVE ACTION
Bottom of slide-out not flush with vehicle body.	Broken or misadjusted lower "in limit" stopper;	Replace or adjust lower "in limit" stopper.
	Lower "in limit" stoppers are not leaning against the structure at the moment when the "in limit" sensor detects the magnet;	Adjust the sensor position in order to have contact of the stoppers against the structure when slide-out is stopped.
Top of slide-out not flush with vehicle body.	Broken or misadjusted leveling or retaining screw;	Check and replace screw.
	Faulty upper "in limit" stopper;	Replace upper "in limit" stopper.
Lower edge of slide-out not parallel with vehicle body opening.	Faulty leveling and retaining screw (4 screws on each side).	Inspect screws, replace and adjust slide-out level.
Water tightness problem.	Inflatable seal and/or wiper seal damaged or unstuck;	Check both seals condition.
	Insufficient air pressure in the seal;	Check the pressure regulator, the relieving shut-off valve and the seal valve condition.
	No air pressure in the slide-out pneumatic system;	Check the slide-out air pressure inlet valve condition and the accessory air tank pressure.
	Sealant missing;	Check the exterior extrusion screws, the windows and the exterior panels sealant condition
	Wiper seal draining hole clogged;	Unclog draining hole.
	Faulty water recovery pan;	Check the recovery pan.
	Faulty internal gutter;	Check internal gutter.
Knocking sound at end of travel when extending slide-out.	Inner stoppers not adjusted properly;	Readjust the inner stoppers.
Knocking sound when parking brake is released.	Security pin retracts too rapidly;	Adjust security pin air flow regulator.
Inflatable seal damaged or removed, or wiper seal unstuck from the structure.	Slide-out has been retracted or extended with the manual procedure with the inflatable seal not deflated;	Always deflate the seal when manually retracting or extending the slide-out.
	Pressure transducer malfunction;	Check the pressure transducer condition, replace if necessary.
	Seal valve malfunction;	Check the seal valve condition.
	Excessive load in the slide-out;	Reduce load or distribute load evenly in order to respect the deflection criterion and slide-out load capacity.
	Slide-out not centered in the structure opening;	Readjust the slide-out height and center horizontally in opening.

PROBLEM	CAUSE	CORRECTIVE ACTION
Friction at end of travel when in full OUT position or at beginning of retraction.	Interference between upper structure key and upper inner stopper;	Readjust the upper inner stopper.

SECTION 6 - STARTING AND STOPPING PROCEDURES

STARTING THE ENGINE	2
STARTING FROM THE DRIVER'S SEAT	2
STARTING FROM THE ENGINE COMPARTMENT	3
COLD WEATHER STARTING	4
JUMP STARTING	4
ENGINE PROTECTION SYSTEM	6
AUTOMATIC ENGINE SHUTDOWN	6
IDLE SHUTDOWN TIMER	6
ENGINE BLOCK HEATER	6
ENGINE WARM-UP	7
ALLISON TRANSMISSION WARM-UP	7
STARTING THE VEHICLE AFTER A FIRE ALARM	7

6-2 Starting and Stopping Procedures

STARTING THE ENGINE

In normal circumstances, the engine should be started from the driver's seat. However, a rear-start panel in the engine compartment allows starting the engine from that location, typically for maintenance operations. See ["STARTING FROM THE ENGINE COMPARTMENT" on the facing page](#)

STARTING FROM THE DRIVER'S SEAT

- Make sure the engine STOP interlock button located in the engine compartment is reset (twist and pull) to enable starting from the front and that the battery master switch (master cut-out) located on the rear electrical panel is set to the ON position;

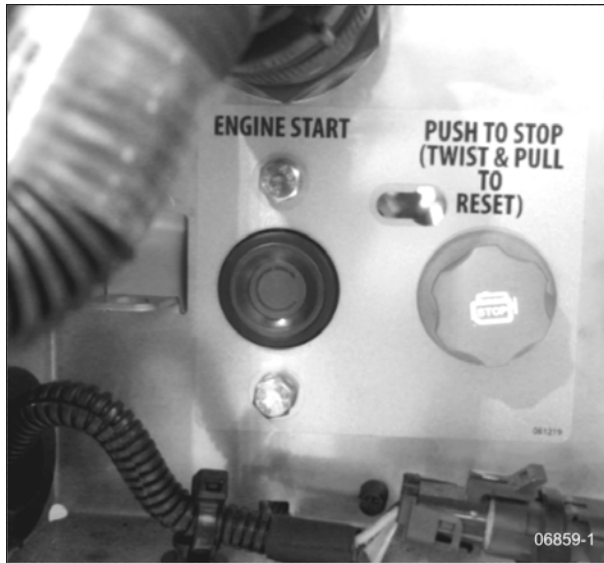

FIGURE 1: TYPICAL ENGINE STOP/IGNITION INTERLOCK BUTTON

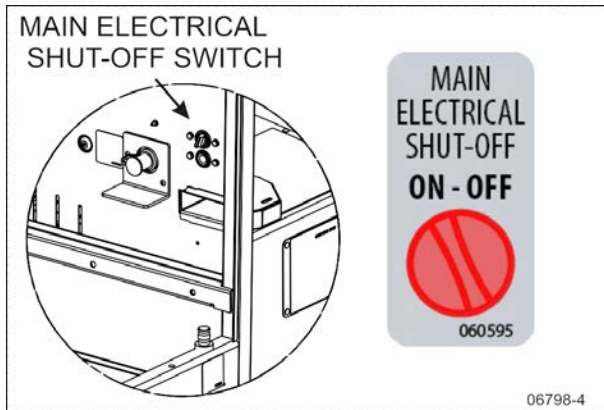

FIGURE 2: MAIN ELECTRICAL SHUT-OFF SWITCH

- Apply the spring-loaded parking brake by pulling the parking brake control button all the way up;
- Place transmission in neutral;
- Turn ignition key to START position (refer to ["IGNITION SWITCH" on page 5](#) in Controls and Instruments chapter), release the key after the engine starts;

NOTE

When the ignition is turned to ON, the M32QR ABS Pressure Modulator Valve solenoids are briefly energized. This can be audibly detected by a rapid cycling of the PMVs. If the air system is fully charged and the service brake pedal is depressed when ignition is turned to ON, the modulator valves create a sharp audible "chuff" of air pressure.

- Brake pedal must be applied when selecting Drive (D) otherwise the transmission will stay in neutral (N);



CAUTION

Do not engage starter for more than 15 seconds at a time. If engine does not start within 15 seconds, release ignition key and let starter cool for one minute before attempting to restart.



CAUTION

Do not press the accelerator pedal before starting. This could result in an electronic control unit fault and degrade the fuel system control.



CAUTION

Special precautions are necessary with turbocharged engines to avoid possible turbine damage. After starting, run the engine at normal idle for two minutes to allow lubricating oil to reach the turbocharger. Then run the engine at fast idle. Let oil pressure reach normal operating range before driving.

NOTE

If engine does not start, return key to OFF position before attempting to restart.

NOTE

If the accelerator pedal is depressed before starting, release and wait 30 seconds before attempting to restart.



WARNING

Do not use ether or other combustible starting aid fluid on any engine equipped with an intake air preheater. If the engine is equipped with a preheater, introduction of ether or similar starting aids could cause a fire or explosion resulting in severe property damage, serious personal injury or death.

Stopping The Engine

1. Apply parking brake and place transmission in neutral (N);
2. Allow engine to idle for at least two minutes before shutting down the engine. This ensures that the turbine speed drops and allows time for the engine exhaust gas temperature to drop to about 300°F (150°C);
3. Shut off all electrical loads;
4. Turn the ignition key to the OFF position.



CAUTION

Do not shut off the engine when running above normal idle.



CAUTION

Set the main electrical shut-off switch to the OFF position after parking and when left unattended for an extended period of time.

STARTING FROM THE ENGINE COMPARTMENT

Push buttons to start and stop the engine from inside the engine compartment are located on the R.H. side of engine compartment.



DANGER

Apply parking brake and place transmission in neutral (N) before starting engine from inside the engine compartment.

1. Set the main electrical shut-off switch and ignition to the ON position.
2. Press the rear start button to start engine from engine compartment.

When servicing the engine, push the engine stop/ignition interlock button to prevent the engine from being started from the dashboard ignition key or the rear start push button.

Once servicing is done, twist and pull the button to allow normal engine start.



CAUTION

Refer to cautions in ["STARTING FROM THE DRIVER'S SEAT" on page 1](#) in this chapter

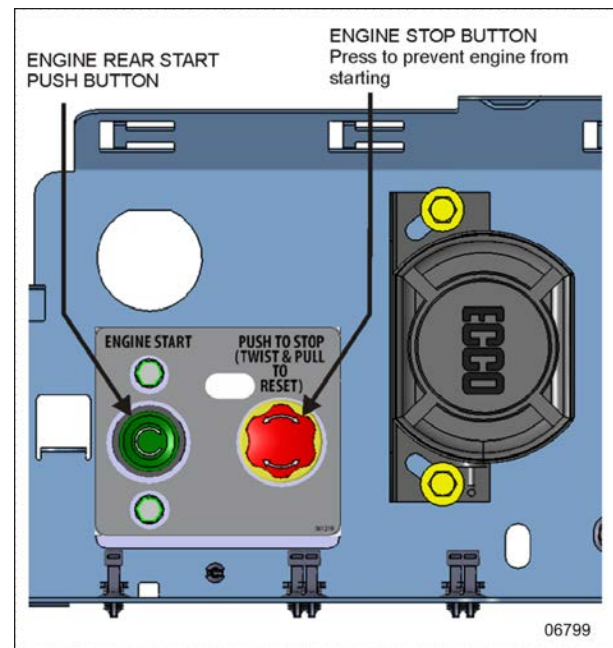

FIGURE 3: REAR START PANEL



DANGER

Do not wear loose clothing when working near engine. Stand clear of rotating components.

6-4 Starting and Stopping Procedures



DANGER

Rotating shafts can be dangerous. They can snag cloth, skin, hair and hands, causing serious injury or death. Do not work on a shaft or other rotating parts of the vehicles (with or without guard) when the engine is running.

Stopping The Engine

Press the red engine STOP/ignition interlock button while the engine is running to stop the engine from the engine compartment.

COLD WEATHER STARTING

When starting a cold engine, the intake air will be warmed up with the intake air preheater. Turn the ignition switch to the ON position. The intake air preheater will not engage at coolant temperature above 54°F (12°C). If the coolant temperature is below 54°F (12°C), the intake air preheater will engage and will light the preheater telltale between 0 and 50 seconds, depending on the engine coolant temperature. Wait before the preheater telltale has turned off before starting the engine.



Intake Air Preheater Telltale

If necessary, once the engine has started, the preheater will re-engage (post heating) for the same length of time as the preheat time.



WARNING

Volvo D13 Engine

This engine is equipped with an intake air preheater. Never use ether or other combustible starting aid fluid. Introduction of ether or similar starting aids could cause a fire or explosion resulting in severe property damage, serious personal injury or death.



WARNING

Do not use ether or other combustible starting aid fluid on any engine equipped with an intake air preheater. If the engine is equipped with a preheater, introduction of ether or similar starting aids could cause a fire or explosion resulting in severe property damage, serious personal injury or death.

Engines not equipped with an intake air preheater may, depending on coolant temperature, take longer to start. If this should happen, DO NOT release the ignition key until the engine has started (while still observing the 15 second maximum cranking time).

JUMP STARTING

In order to avoid damage to solid-state electrical components, it is important that jumper (booster) cables are used correctly and only in emergencies. To jump start, use another 24 volt DC, negative grounded, power source. Use only jumper cables rated at 500 cranking amperes.



DANGER

Injury, explosion, battery acid damage or charging system overload may result if these jump starting procedures are not precisely followed.



WARNING

Wear eye protection and remove rings, metal jewelry and watches with metal bands.



DANGER

The battery could rupture or explode if jump started when the run-down battery fluid is frozen or if the battery fluid level is low. Check condition of run-down battery before attempting to jump start.



DANGER

The gases given off by batteries while jump starting are explosive. Do not smoke near batteries.

Starting and Stopping Procedures 6-5

CAUTION

Do not let the two vehicles touch. Keep a walk-through distance between the two vehicles. Make sure positive (red) and negative (black) jumper cable clamps do not touch.

CAUTION

Never connect the jumper cable to the negative terminal post of the run-down battery.

CAUTION

Do not jump start if a maintenance-free battery has a yellow test indicator. Have the battery replaced.

WARNING

Before attempting to jump start, make sure the parking brake is applied and the transmission is in neutral (N). Turn off all lights, heaters and other electrical accessories.

CAUTION

Choose a booster vehicle which produces comparable amperage as your vehicle.

CAUTION

Off-board battery charger with a start boost facility must not be used to jump start the vehicle. This could damage the electrical system.

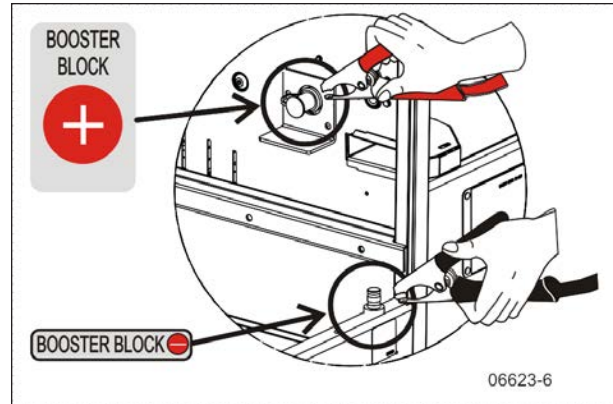

FIGURE 4: BOOSTER BLOCK TERMINALS LOCATION (H3 SERIES)

To jump start, proceed as follows:

1. Remove the protective cap from the booster block terminal located in the R.H. side engine compartment;
2. If the good battery is in another vehicle, that donor vehicle's engine must be shut off before connecting. Shut off all electrical equipment on both vehicles.
3. Connect one end of the red jumper cable to the positive (+) post of the donor vehicle battery (or booster power source).
4. Connect the other end of the red jumper cable to the positive (+) terminal on the booster block;
5. Connect one end of the black jumper cable to the negative (-) post on the donor vehicle battery (or booster power source);
6. Connect the other end of the black jumper cable to the negative (-) terminal on the booster block;
7. Start the engine of the donor vehicle and increase the engine rpm speed slightly and maintain at that level for approximately 5 minutes to recharge dead batteries and then, shut the engine off;
8. Start the vehicle with the dead battery;
9. Disconnect the jumper cables in reverse order given in steps 2 through 5;
10. Install protective cap on the booster block terminal.

6-6 Starting and Stopping Procedures

NOTE

Jumper cables must be rated at 500 cranking amperes. If jumper cable length is 20 feet (6 m) or less, use 2/0 (AWG) gauge wires. If cable length is between 20 and 30 feet (6 to 9 m), use 3/0 (AWG) gauge wires.

ENGINE PROTECTION SYSTEM

The engine protection will automatically derate or stop the engine when certain engine conditions reach a critical stage.

In the event of a serious fault, the red STOP telltale light comes on and an audible alarm will sound if the engine is running.



An illuminated STOP telltale light indicates a serious problem has been detected, and the driver must respond immediately to the problem. The vehicle must be safely pulled off the road and stopped. In some instances, the engine must be switched off immediately.

AUTOMATIC ENGINE SHUTDOWN

Prior to an actual automatic shutdown, the engine will automatically derate, go to idle, and then stop as the vehicle speed gets below 2 mph (3 km/h).

The engine shutdown protection will automatically derate and stop the engine when one or more of the conditions listed below reaches a critical point:

- High engine coolant temperature
- High engine oil temperature
- Low engine oil pressure
- High crankcase pressure

After the automatic engine shutdown sequence, the engine may be restarted. To do so, turn the ignition switch to the OFF position for 7 seconds and then turn it back to ON. However, it will only operate for 30 seconds unless the problem is resolved.

Use this function sparingly and in order to move the vehicle to a safe parking place only. Excessive use may result in severe engine damage.



WARNING

Failure to take necessary action when the STOP telltale light is on can ultimately result in automatic engine derate and shutdown.

IDLE SHUTDOWN TIMER

The idle shutdown timer (optional) is programmed to shut down the engine after a specific engine idling time. The idling time cannot be changed by the driver but can be changed with the use of a laptop computer and Premium Tech Tool. In this case, the engine idling time can be set from 30 seconds up to 1 hour.

The engine will shut down at the set time under the following conditions:

- Vehicle speed is 0;
- Engine is running at normal idle speed;
- Engine coolant temperature above 120°F (49°C);
- Temperature inside vehicle is between 59°F (15°C) and 81°F (27°C);
- Parking brake applied;
- Transmission into neutral (N);
- Wheelchair lift system not in use;

Pressing the fuel pedal will prevent engine shutdown and restart countdown.

ENGINE BLOCK HEATER

The vehicle may be equipped with an engine immersion-type electric block heater to assist cold weather starting. A connector is on the rear pillar of the curbside engine compartment door frame. Using an extension cord, connect to a 110 - 120 VAC outlet.



CAUTION

Connect only to a 120 VAC power source. Use only grounded (three prongs) extension cords with a minimum rated capacity of 15 A. Disconnect the extension cord before starting. Before driving, make sure the extension cord is disconnected.

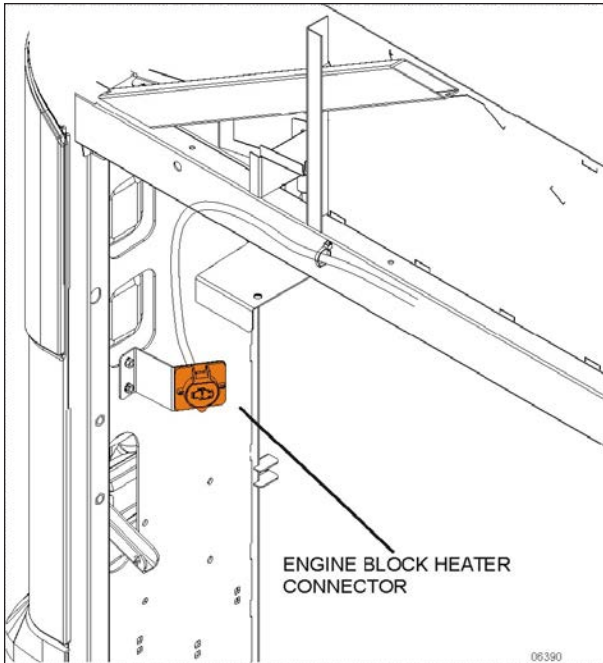

FIGURE 5: ENGINE BLOCK HEATER CONNECTOR (TYPICAL)

ENGINE WARM-UP

After starting the engine, keep the parking brake applied and let the engine run at normal idle for two minutes to allow lubricating oil to reach the turbocharger. Increase engine speed to fast idle, using the fast idle switch located on the dashboard for five minutes, without loading the engine. Monitor the gauges and indicator lights to make sure all conditions are normal. If an abnormal condition is observed, stop the engine immediately and have the condition corrected.

NOTE

The engine will reach normal operating temperature shortly after driving. Avoid driving at full throttle until engine coolant temperature reaches 140°F (60°C).



DANGER

Never let the engine run in an enclosed, non-ventilated area. Engine exhaust fumes contain dangerous gases which can be fatal if inhaled. Before warming up the engine, open the door (s) or move the vehicle outside.

ALLISON TRANSMISSION WARM-UP

With an automatic transmission, when the temperature falls below -20°F (-29°C), the CHECK telltale light illuminates after the engine is started, and a reminder tone will sound. In this case, the transmission will be locked in neutral (N) until the transmission temperature rises above -20°F (-29°C) and the CHECK telltale light goes out. The transmission will only operate in first or reverse gears until it reaches normal operating temperature.

STARTING THE VEHICLE AFTER A FIRE ALARM

The vehicle may be started after a fire alarm without resetting the system. Refer to *Section 7 SAFETY FEATURES AND EQUIPMENT* under ["Starting The Vehicle After A Fire Alarm" on page 1](#) for the complete procedure.

SECTION 7 - SAFETY FEATURES AND EQUIPMENT

EMERGENCY EXITS	2
ELECTRIC AWNING WINDOW	2
ELECTRIC SLIDING WINDOW	2
FIXED WINDOW	2
EMERGENCY EQUIPMENT	2
FIRE EXTINGUISHERS	2
FIRST-AID KIT	2
WARNING REFLECTORS H3 SERIES	3
JACK AND TOOLS H3 SERIES	3
SPARE PARTS KIT	3
AUTOMATIC FIRE SUPPRESSION SYSTEM (AFSS)	3
TIRE PRESSURE MONITORING SYSTEM	4
CHANGING WHEEL	7
EMERGENCY AIR-FILL VALVES	7
EMERGENCY AND PARKING BRAKES	8
VEHICLE JACKING POINTS	8
HYDRAULIC JACK	9
TOWING THE VEHICLE	9
DAYTIME RUNNING LIGHTS	9
FOG LIGHTS	9
CORNERING AND DOCKING LIGHTS	9
COMPARTMENT LIGHTING	9
MUD FLAPS AND SPLASH GUARDS	9
BACK-UP CAMERA	10
BACK-UP ALARM	10
BACK-UP ALARM CANCEL SWITCH	10
ESSENTIAL FUNCTIONS TO OPERATE THE VEHICLE (BASIC LIMP-HOME FUNCTIONS)	10
AVAILABLE FUNCTIONS	10

7-2 Safety Features and Equipment

EMERGENCY EXITS

Locate and learn how to use all possible emergency exits. It is good practice to inform all guests or passengers of the location of exits and how to use them in case of an emergency.

ELECTRIC AWNING WINDOW

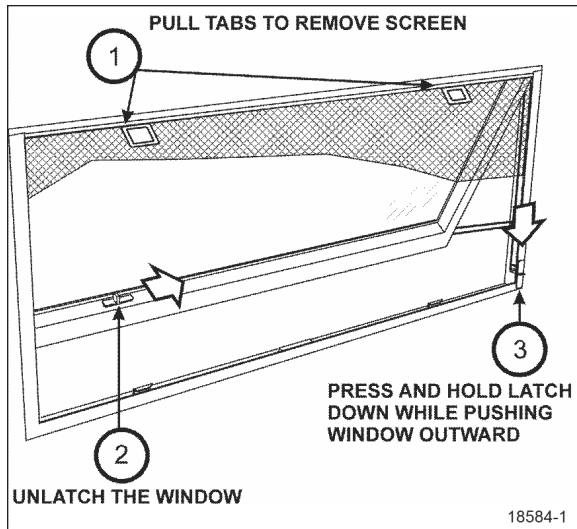

FIGURE 1: ELECTRIC AWNING WINDOW

ELECTRIC SLIDING WINDOW

Electric (power) sliding windows can be used as emergency exits.

- Remove the screen assembly,
- Pull down on both red release latches simultaneously and rotate the sash inwards approximately 10 degrees.
- Lift the sash up and out to disengage the bottom of the sash from the window frame.

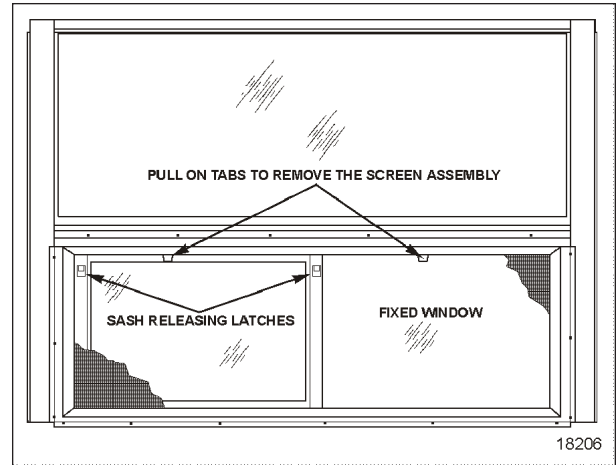

FIGURE 2: ELECTRIC SLIDING WINDOW

FIXED WINDOW

Fixed windows are fastened or glued to the structure of the vehicle; they do not open and are very hard to break. In case of emergency, do not attempt to open them, instead find and use the entrance door or the nearest awning or sliding window.

EMERGENCY EQUIPMENT

The vehicle is equipped with numerous safety features and equipment. Verify the equipment regularly and keep on hand and in good condition at all times. Following is the enumeration and description of safety equipment found on board.

FIRE EXTINGUISHERS

Two chemical fire extinguishers are provided with the vehicle. Placement may vary depending on options and models. Take a moment to locate them in your vehicle. Instructions for use are found on the extinguishers. Make sure you know how to operate fire extinguishers in case of an emergency.

FIRST-AID KIT

The optional first aid kit is usually stored near the driver's seat. A white cross over red background decal identifies the first aid kit.

WARNING REFLECTORS H3 SERIES

A box containing three triangular reflectors is provided to warn other drivers on the road in case of a breakdown. The box is located with the jack and tools kit in the first curbside baggage compartment. The reflectors provide visible warning of an emergency. The three reflectors should be placed as indicated on the box cover. These reflectors comply with FMVSS 125 (Federal Motor Vehicle Safety Standards).

JACK AND TOOLS H3 SERIES

A kit for jacking up the vehicle and changing wheels is stored in the first curbside baggage compartment. The kit includes:

1. 12-ton bottle jack
2. Wheel nut wrench and lever
3. Box containing three triangular reflectors

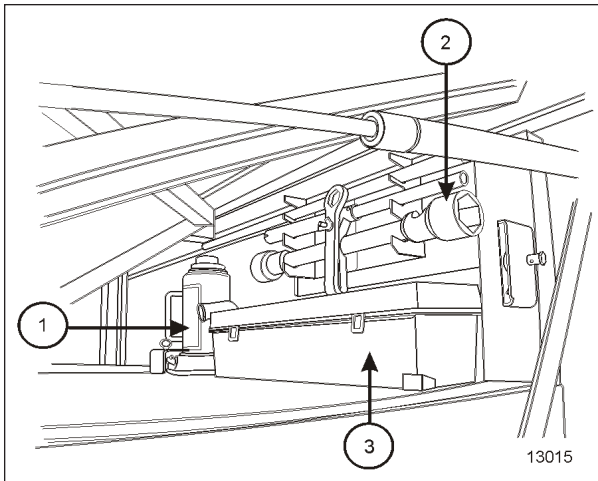

FIGURE 3: FIRST BAGGAGE COMPARTMENT H3 SERIES

SPARE PARTS KIT

The vehicle may be equipped with a spare parts kit (optional). The kit contains parts such as bulbs, circuit breakers, belts, etc. The spare parts kit is stored in the first baggage compartment.

AUTOMATIC FIRE SUPPRESSION SYSTEM (AFSS)

The vehicle may be equipped with the optional Automatic Fire Detection and Suppression System (AFSS).

System Operation

When a fire is detected inside the engine compartment, the system sends a fire alarm signal to the **Protection Panel** located in the driver's area near the lateral control panel. The **Protection Panel** immediately turns on the fire "ALARM" lamp and sounds the audio alarm. After a 15-second time delay the engine is automatically shut down. The fire extinguisher is discharged simultaneously with engine shutdown.

NOTE

The Protection Panel continuously monitors system integrity and displays the information via the "SYSTEM OK" and fire "TROUBLE" indicators.

NOTE

The Manual Activation Switch is used when immediate discharge of the fire extinguisher and engine shutdown is desired.

Operational Sequence (Fire)

1. A fire detector or linear thermal detector detects a fire in the engine compartment and sends a signal to the **Protection Panel** in the driver's area.
2. The fire "ALARM" lamp on the **Protection Panel** will illuminate solid red and an audible alarm will sound.
3. The operator shall bring the vehicle to a safe stop.
4. The system automatically shuts down the vehicle engine and discharges the extinguisher into the engine compartment 15 seconds after the fire alarm starts unless advanced or delayed by the operator.
 - If the operator presses the **Manual Activation Switch**, all delays will terminate and the engine shutdown and extinguisher

7-4 Safety Features and Equipment

discharge will occur immediately.

- If the operator presses and releases the **Delay Engine Stop** switch once, the engine shutdown and extinguisher discharge will be delayed by an additional 15 seconds.



WARNING

The engine will stop 15 seconds after the fire alarm starts. The operator must be prepared to bring the vehicle to a safe stop as soon as the alarm sounds. Steering may become difficult after engine shutdown. If more time is required, the "DELAY ENGINE STOP" switch may be pressed and released for an additional 15 second delay.



WARNING

The extinguisher discharge may cause an obscuring cloud behind and near the vehicle.

5. The red fire "ALARM" lamp and audible alarm will stay on. The yellow fire "TROUBLE" lamp will also be on indicating a discharged extinguisher.
6. The system must be reset and the fire extinguisher removed and replaced in accordance with the System Reset portion of the Kidde Dual Spectrum Operation & Maintenance Manual.

Starting The Vehicle After A Fire Alarm

The vehicle may be started after a fire alarm without resetting the system. Refer to ignition switch sequence below. This will not reset the system; rather it will instruct the vehicle's multiplex system to ignore vehicle interface outputs from the Protection Panel. This feature is intended to be used only in emergencies that require the vehicle to be restarted and moved a short distance prior to system reset. It should not be performed if the cause of the fire has not been clearly identified and corrected.

To start the vehicle, perform this ignition switch (key) sequence.

- From the **ON** position,
- Turn to **OFF**, return to **ON** and **START** vehicle within 2 seconds.

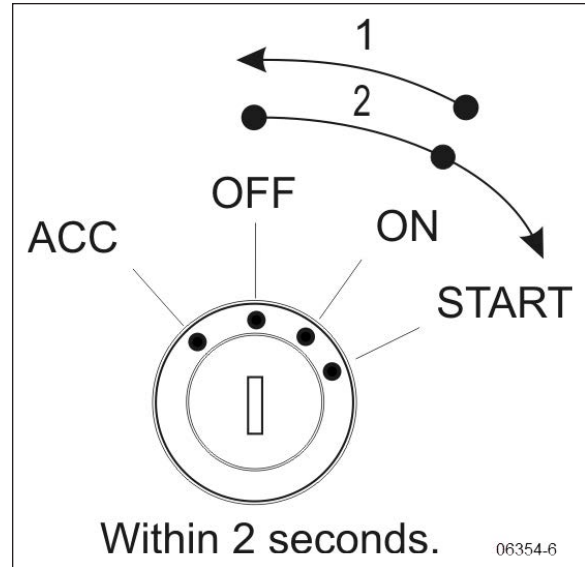

TIRE PRESSURE MONITORING SYSTEM

The vehicle may be equipped with an optional Tire Pressure Monitoring System (TPMS).

Description

System includes the following elements:

- Special tire valves;
- RF sensor inside each tire, fixed to the valve. Sensors provide continuous tire pressure and temperature reading. The normal sensor battery lifespan is 5 years. The remaining lifespan is displayed as a percentage in the TPMS display;
- 3 antennas to receive the sensors RF signal (one in the front spare tire compartment, one above the L.H. side rear wheels and one above the R.H. side rear wheels);
- A TPMS receiver connected to the antennas and located in the front electrical compartment, above the CECM;
- A TPMS display built in the L.H. dashboard panel (with On-Screen TPMS version);
- A "Tire Pressure Warning" indicator.

NOTE

It is recommended to check the remaining battery lifespan when changing the tires in order to replace the sensors at the same time if they are due for replacement before the next change.

The telltale panel indicator illuminates for 3 seconds when the ignition switch is turned ON to check the display operation and the communication between the display and the vehicle multiplex system. This confirms the communication between the TPMS display and CECM.

Setting The On-Screen TPMS

- Set Wheel ID

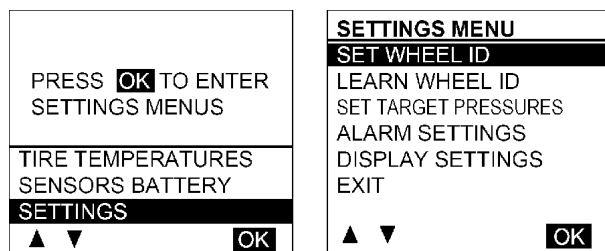

23411-2

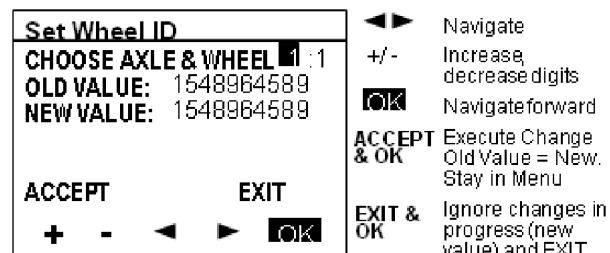

23461

- Learn Wheel ID

This menu allows learning new wheel sensors ID. The user can learn only one wheel, several wheels or all wheels of the vehicle. The sequence automatically jumps to the next wheel such that a user can initiate all wheels without having to come back to the display between each wheel.

The display uses a pressure change as the criteria to recognize which wheel sensor the operator wants to get assigned to a given location. The amount of pressure change required is established at 2 PSI.

A pressure change of about 3 PSI is needed to wake up a sensor and then an extra amount of pressure change of 2 PSI is needed to trigger the display. The operator has to create a pressure change by at least 6 PSI and then wait for the display to recognize the pressure change. The wait time corresponds to the sensor sampling rate.

When entering the menu, the axle 1, wheel 1 is selected by default as a starting point for the learning. The user can select another axle with

+/- , move the cursor to the wheel number with the right arrow and select another wheel with the +/- or move the cursor down to the start learning button.

After the start learning button is selected, the display stores the first transmission it gets from each sensor ID into the “initial pressure” for that sensor ID. Then it compares each subsequent pressure received for that sensor ID with the initial one and when the comparison shows a delta pressure exceeding the defined level required, this sensor ID is assigned to the selected tire location.

Once a wheel ID has been assigned, the display increments the number of wheels done and it moves to the next axle/wheel in the sequence, waiting for another sensor to come up with a pressure change. Within one learning session, the display remembers which sensor has been assigned and it will not assign it twice.

The sequence increments the display of the next wheel on the same axle, counting wheels from left to right, and then moves to the next axle, counting axles from front to rear.

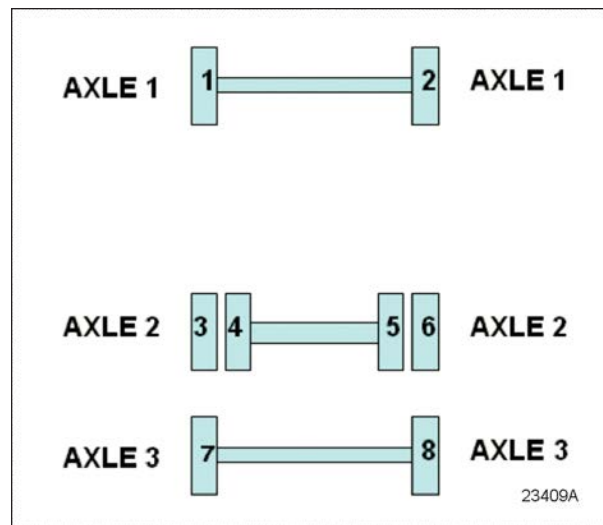

23409A

It activates the next wheel parameter each time a wheel is done. This setting is integrated with the vehicle electronic, activating an audible signal on the vehicle, thus providing feedback to the user that he can move on to the next wheel.

The spare tire can be done by selecting the axle/wheel “spare” which is internally encoded to 15:1.

7-6 Safety Features and Equipment

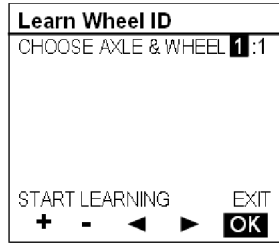

23461-1

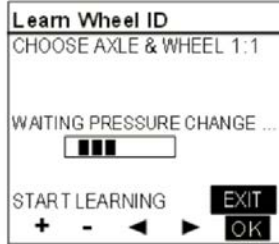
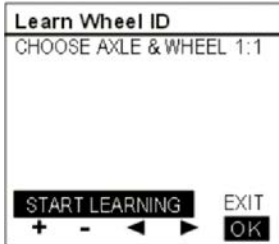

23461-2

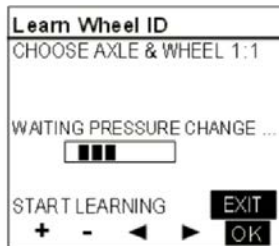
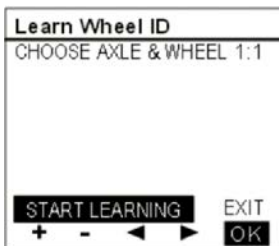

23461-2

- Set Target Pressures

This menu allows the end user to fine-tune the target pressure setting, taking account for the specific operating conditions (cold weather operation or unloaded operation). The end user can readjust the target pressure within +30% and -20% of the factory set target pressure but not outside this range.

The factory set target pressure is always kept in permanent memory into the TPMS display and cannot be edited by the end user.

When the user sets a new target value, the selection can't be made outside the valid range.



23461-4

- Alarm Settings

When selecting the Alarm Settings Menu, a submenu containing Pressure Alarm and Temperature Alarm appears.

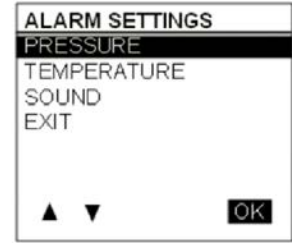

23461-5

When selecting Pressure, the following pressure alarm screen appears. A similar screen is displayed for temperature settings. The cursor can be moved to highlight the data beside “new value” and the “accept / exit” option. +/- allows increasing or decreasing the “new value” data. Pressure alarm changes are made by steps of 1 PSI, in the range from 5 to 20 PSI. Temperature alarm is done by steps of 5°F (2°C) in the range from 150 °F to 180 °F (64 °C to 82 °C). Pressing OK with “accept” highlighted applies changes and exits to the previous menu, while pressing OK while the “exit” option is highlighted exits without changes.

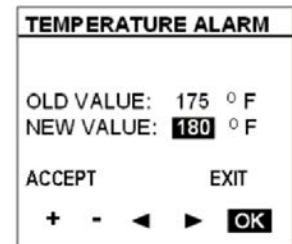

23461-6

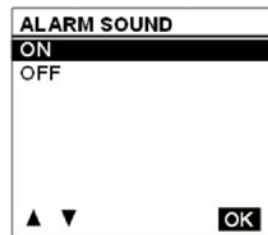

23461-7

- Display Settings



23461-8

- Units & Language

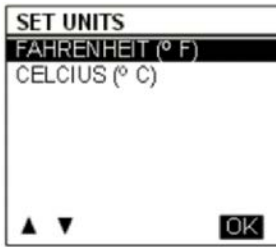

23461-9

- Backlight Intensity

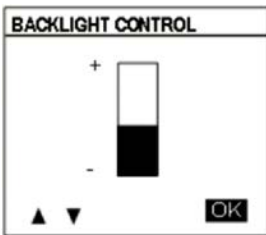

23461-10

- Key Sound

Turns ON/OFF the sound of keys each time they are pressed.

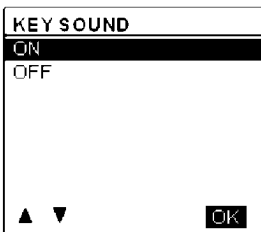

23461-11

- Tire / Axle Configuration

Pressing the up / down arrows allows to select the option of 2 or 4 tires, which are the choices for the drive axle on the vehicle.



23461-12

Refer to TPMS Troubleshooting Guide in Appendix D.

CHANGING WHEEL

In case of a flat tire, turn ON the hazard flashers and bring the vehicle to a stop on the side of the road. Apply the parking brake. Make sure the vehicle is parked safely away from traffic. Set up the triangular reflectors in accordance with applicable highway regulations.

We suggest that you do not attempt to change a wheel. First, the wheel and tire are very heavy and usually there is no space available to put the removed flat. Second, the wheel nuts, especially those on inner dual, can become very tight after being on for only a short time. Often a heavy air wrench is required to get these nuts loose. We suggest you get help via CB radio or cellular phone. There are tire service trucks all over the country that can bring a wheel and make the change safely.

EMERGENCY AIR-FILL VALVES

The vehicle is equipped with two air system emergency fill valves to supplement the air system when air pressure is low and the engine cannot be operated. One valve is located inside the front service compartment. The other valve is located inside the engine compartment.

Both air system emergency fill valves are fitted with standard tire valve stems. The air systems can be filled using any standard external air supply line. The fill valve located in the engine compartment supplies air for all systems (brakes, suspension and accessories). The fill valve located in the front service compartment supplies air for accessories only.



CAUTION

Air filled through the two emergency fill valves will pass through the standard air filtering-drying system. Do not fill air at any other location. Do not exceed 120 psi (827 kPa).

7-8 Safety Features and Equipment

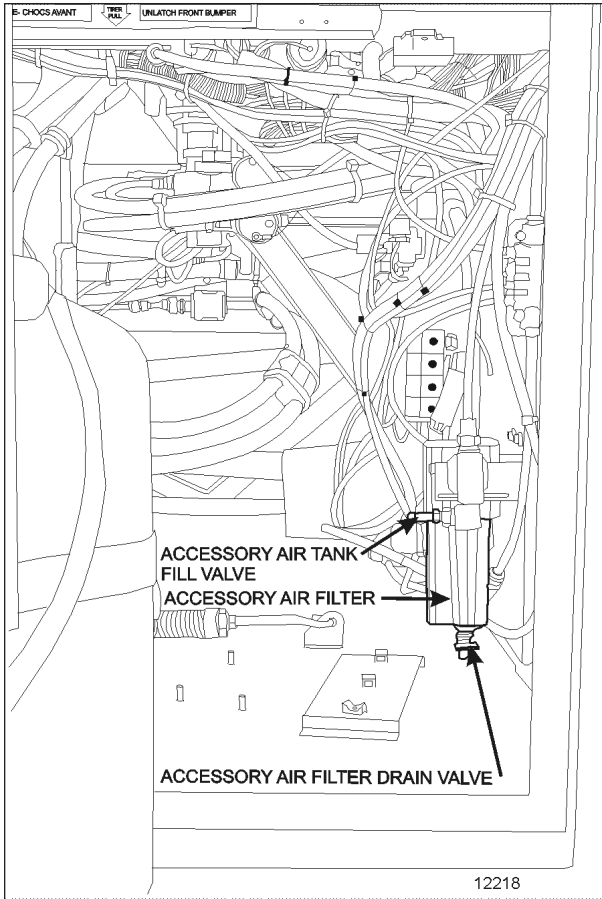

FIGURE 4: FRONT SERVICE COMPARTMENT

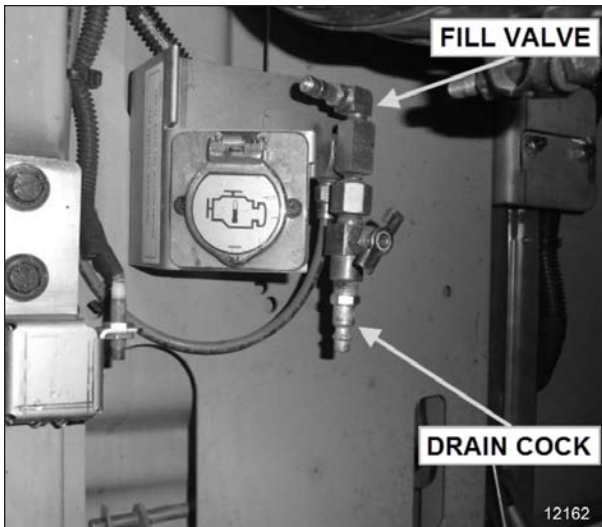

FIGURE 5: FILL FITTING IN ENGINE COMPARTMENT

EMERGENCY AND PARKING BRAKES

During normal operation, if air pressure in any brake circuit drops below 60 psi (414 kPa),

spring-loaded emergency brake will be immediately applied at full capacity to the drive axle wheels to stop the vehicle.

Spring-loaded parking brake is applied by pulling up the control valve knob located on the L.H. lateral console.

Parking brake is not designed to be used as a service brake. For normal driving conditions, the control valve knob must remain depressed.



WARNING

Always apply the parking brake before leaving the driver's seat.

NOTE

Only use the parking brake to supplement the service brake to stop the vehicle in emergency conditions. The stopping distance will be considerably longer than when using normal service brake.

NOTE

Before releasing the parking brake by pushing down the control valve knob, check the pressure gauges to make sure that the brake system air pressure is greater than or equal to 95 psi (655 kPa).

NOTE

The alarm will sound if the ignition switch has been turned to OFF without applying the parking brake. The same beep will sound if pressure is still applied to the service brake pedal.

NOTE

The stop lights automatically turn on when the parking brake is applied and the engine is running.

VEHICLE JACKING POINTS

For detailed instructions, refer to Maintenance information [MI18-18](#), available on the technical publications USB key and website.

HYDRAULIC JACK

To raise: turn release valve clockwise. Insert handle in socket and raise vehicle by pumping.

To lower: remove handle and turn the release valve slowly counterclockwise.

Always keep ram and extension screw retracted when jack is not in use.

Service: Check oil level when jack fails to raise to full height. Lower ram completely with release valve open and jack in upright position, remove filler plug and refill to level of filler hole with hydraulic jack oil. Never use brake fluid.



DANGER

Jack is intended for lifting only. Do not get under the vehicle or load for any reason unless it is properly supported with safety stands and securely blocked.



DANGER

Do not overload jack above rated capacity. Prevent "side loading", make sure load is centered on ram. Do not push or tilt load off jack.

TOWING THE VEHICLE

For detailed instructions, refer to Maintenance information [MI18-18](#), available on the technical publications USB key and website.

DAYTIME RUNNING LIGHTS

The daytime running lights system provides added safety by making the front of the vehicle more visible to other drivers during the day.

The daytime running lights system turns the headlights on when:

- Engine is running;
- Parking brake is released;
- The exterior lighting switch is set to the OFF position or pressed to the first position.



WARNING

At night, do not drive using the daytime running lights. When in use, the tail and rear marker lights are not turned on.

For night driving, turn the headlights lighting rocker switch to the second position.

FOG LIGHTS

Optional halogen fog lights are available. They provide better visibility in fog and precipitation. They improve visibility immediately in front of the vehicle. They also provide added safety.

NOTE

Some states or provinces may restrict the use of fog lights. Verify local state or provincial regulations before using.

CORNERING AND DOCKING LIGHTS

The vehicle may be equipped with up to four halogen cornering lights. Two lights are installed at the front of the vehicle, on each side as standard equipment. Two optional lights may be installed on each side at the rear of the vehicle. When activated, the front lights illuminate at the same time as the turn signal flashers to increase lateral visibility while turning. The rear lights illuminate when the reverse (R) range is selected to increase visibility while backing-up the vehicle. All four lights will illuminate when the docking position is selected using the rocker switch. Refer to chapter: "Controls and Instruments".

COMPARTMENT LIGHTING

Baggage compartments and the service compartments lights are automatically turned on when the corresponding compartment door is opened. A pictogram will appear on the status bar of the Driver Information Display (DID) when the baggage compartment door is open.

MUD FLAPS AND SPLASH GUARDS

Mud flaps are installed behind each front wheel and the tag axles. Mud flaps minimize dirt on the lower panels of the vehicle and prevent stones

7-10 Safety Features and Equipment

and debris from being thrown at vehicles traveling behind the vehicle.

Splash guards may be installed behind each dual wheel of the drive axle to prevent stone projectiles from being thrown at the tag axle wheels.

BACK-UP CAMERA

An optional back-up camera is available which provides the driver with visual assistance when backing-up. The monitor is mounted on the left side pillar. It switches on automatically when the transmission is in the reverse (R) range.

BACK-UP ALARM

The back-up alarm alerts pedestrians and other drivers when the vehicle is being backed-up. Take extra precautions whenever backing-up. If necessary, use a guide to provide directions when backing-up. The back-up alarm is automatically activated when the transmission is put into reverse gear (R).

BACK-UP ALARM CANCEL SWITCH

A rocker switch located on the lateral control panel allows the driver to cancel the back-up alarm system (as for example: at night on a camping site).

NOTE

After use, return to normal operation.

ESSENTIAL FUNCTIONS TO OPERATE THE VEHICLE (BASIC LIMP-HOME FUNCTIONS)

Even with a defective CECM (Chassis Electronic Control Module) or a CAN network problem, essential base functions are maintained to rear start the vehicle from the engine compartment and drive in a secure manner.

AVAILABLE FUNCTIONS

- Startup: Turn on the ignition in the driver's area and rear start the vehicle from the engine compartment,

- Headlights: Low beams only,
- Stoplights: 2 upper stoplights + high-mounted stoplight are functional,
- Opening the door: Functions normally,
- Closing the door: Manually pull on the door and it will lock automatically,
- Windshield wipers: Wipers functions at 1st speed only
- Directional signals: Rear and front only,
- Windshields washer fluid: Lower windshield washer
- HVAC: Functional with set point fixed at 70°F (22°C), evaporator and condenser fixed at speed 1, defroster fixed at speed 4.



CAUTION

The following directives must be followed.

- Never connect a battery charger when the ignition is at the ON position on a vehicle with a defective CAN or certain functions will start up by themselves,
- Disconnect the charger before starting the vehicle, if not the default functions will not activate,
- If the default mode does not activate, try to turn the ignition OFF while ensuring that no charger is connected and then restart the vehicle.

SECTION 8 - CARE AND MAINTENANCE

CLEANING	3
SEAT UPHOLSTERY	3
PLASTIC AND VINYL	4
WINDOWS	4
STAINLESS STEEL	4
HIGH PRESSURE LAMINATE	4
RUBBER COMPONENTS	4
FLOOR CLEANING	4
EXTERIOR SURFACES	4
WINDSHIELD	5
FLUID LEVEL VERIFICATION	5
ENGINE OIL LEVEL	5
TRANSMISSION FLUID LEVEL	6
POWER STEERING FLUID LEVEL	7
DRIVE AXLE WHEEL BEARING OIL LEVEL	8
FRONT AND TAG AXLE WHEEL HUBS	8
COOLANT FLUID LEVEL	8
WINDSHIELD WASHER & HEADLIGHTS WASHER RESERVOIRS	8
OTHER VERIFICATIONS	8
ELECTRIC COOLING FANS	9
AIR TANK PURGE	9
FIRE EXTINGUISHERS	10
PRIMARY FUEL FILTER	10
DRIVER'S A/C COMPRESSOR BELT	11
CENTRAL A/C COMPRESSOR BELTS	11
ALTERNATOR DRIVE BELTS	11
BACK-UP CAMERA	11
ENGINE AIR FILTER RESTRICTION INDICATOR	12
MAIN POWER COMPARTMENT FAN AIR FILTER	12
A/C AND HEATING SYSTEM AIR FILTERS	12
HOSE INSPECTION	13
LUBRICATION	13
WHEELS AND TIRES VERIFICATIONS	13
WHEEL BEARINGS	14
SERVICE BRAKE TEST	14
PARKING BRAKE TEST	14
EXTERIOR LIGHTING VERIFICATION WITH TEST MODE	14
GENERAL RECOMMENDATIONS	17

8-2 Care and Maintenance

WALK-AROUND INSPECTION (BEFORE EVERY TRIP)	21
APPROACHING THE VEHICLE	21
PREPARATION	21
STEP 1: RIGHT SIDE	21
STEP 2: ENGINE COMPARTMENT RIGHT SIDE AREA	22
STEP 3: ENGINE COMPARTMENT	22
STEP 4: REAR LEFT SIDE	22
STEP 5: FRONT LEFT SIDE	22
STEP 6: FRONT	23
STEP 7: FRONT RIGHT SIDE	23
STEP 8: INSIDE THE VEHICLE	23
WITH ENGINE RUNNING	23

CLEANING

The cleaning information provided in this section is regarded as recommended cleaning practices. Cleaning results may vary depending on the condition of the stain. Always clean stains promptly for best results.

NOTE

Use only approved cleaning products such as Prevost A.P.C., all-purpose cleaner (Prevost # 683664). Never use stain protection products on new fabrics. To prevent permanent staining of fabrics, clean stains soon after they occur. Incorrect treatment of stains can worsen them. Get help from a cleaning specialist to remove stubborn stains.



CAUTION

Custom fabrics and materials may require different cleaning and maintenance practices. Consult your supplier.

SEAT UPHOLSTERY

Firmly beat the fabric with a blunt object, such as a wooden paddle, to release dust and dirt. Vacuum the seat fabric in the direction of the stitching using an upholstery nozzle.

NOTE

The abrasive nature of dirt and grit will reduce upholstery life expectancy. Vacuum regularly.

Removal Of Stains And Marks

Depending on the nature of the stain, apply one of the two methods explained below to remove stains and marks on wool plush.

Method One:

Apply a nonflammable solvent to stained area with a clean, white absorbent rag;

Clean stain by starting at the outer edges of the stain and working in toward the center;

Blot affected area frequently with a clean, dry absorbent cloth to prevent stain rings caused by excess solvent.



WARNING

Use solvents in a well-ventilated area. Open all windows and doors.

Method Two:

Wet the stain with a solution of household detergent and lukewarm water. Do not soak the stain;

Rub the stain with a damp cloth;

Rinse cloth after each application.



CAUTION

Do not use soap, soap powder, ammonia, soda, bleach or cleaning products containing any of these compounds.

Beverage Stains

Remove beverage stains by following method one. If stain persists, repeat method one using methylated spirits instead of solvent.

Alcoholic Beverage Stains

Remove alcoholic beverage stains by wetting the stain with water, then cleaning following method two.

Burns

Scrape burnt area using a knife or razor blade then clean following method two. Consult an upholstery specialist when dealing with extensive burns.

Cosmetic Stains

Remove stains left by cosmetics by following method one then, method two.

Ink Stains

Remove ink stains following method two. If stain persists, apply a warm oxalic acid solution. Rinse with water.

Blood, Urine Or Vomit Stains

Remove such stains by following method two.

Copying Ink - Ball-Point Pen Ink

Treat with methylated spirits, blotting frequently to avoid spreading stain, followed by method two.

8-4 Care and Maintenance

Marking Ink (Felt-tip Pens)

Treat with Methyl Ethyl Ketone (MEK) followed by method two.

Oil, Grease And Paint

Remove excess using a knife. Treat with method one followed by method two. If stain persists, repeat procedure.

Rust Stains

Remove rust stains by following method two. Apply a warm oxalic acid solution to stained area. Rinse with water.

Tar

Soften tar with mineral spirits, then treat using method one followed by method two.

Chewing Gum

Soften gum with cyclohexane. Carefully scrape off stains using a sharp knife or razor blade.

PLASTIC AND VINYL

Clean plastic and vinyl trim using a clean damp cloth or sponge. For vinyl trim marks, use a lukewarm all-purpose cleaner or a mild saddle soap. Remove water spots and soap traces using a clean damp cloth or sponge. Dry with a clean soft cloth.

Remove grease, tar or oil stains with a clean cloth or sponge and an all-purpose or solvent-type vinyl cleaner.

Apply a colorless vinyl or leather protective product to maintain the luster and pliability of the plastic or vinyl surface.

WINDOWS

Clean the inside of the windows with a solution of one part vinegar to ten parts water.

STAINLESS STEEL

Use a stainless steel cleaner and follow the manufacturer's instructions. Stainless steel cleaning solution may be ordered from Prevest quoting part number 680356.

HIGH PRESSURE LAMINATE

Remove stains on laminated surfaces (Formica) with a household detergent, methylated spirits or mineral spirits. Clean with a mild liquid abrasive and water solution if stain persists.

RUBBER COMPONENTS

Use only pure water or glycerin to clean stains on rubber components.



CAUTION

Never use solvents on rubber components.

FLOOR CLEANING

To keep its original appearance, wash the floor regularly. Clean vinyl floors with a quality nonionic detergent cleaner or a household all-purpose cleaner. Follow the manufacturer's recommendations for cleaning.

Remove any excess detergent solution using a wet/dry vacuum or mop. Rinse floor with a solution of one part Clorox to ten parts warm water.

Polish dry floor using a high-speed buffer and a smooth red 3-M polishing pad.

Mop floor periodically with a solution of 5 percent Clorox in warm water.

NOTE

For custom or special floor covering materials, consult the manufacturer or your converter for information on how to clean and maintain these types of floors.



CAUTION

Using a water hose to clean the floor is prohibited since it could cause electrical shorts or damage the electrical system.

EXTERIOR SURFACES

Frequent washing and waxing of the vehicle exterior will help protect the finish and luster. The paint finish is attacked by the abrasive effects of airborne particles and corrosive pollutants.

Before washing the exterior of the vehicle, close the fresh air dampers using the “REC” button located on HVAC control panel and on the air intake duct in the evaporator compartment. Install keyhole protectors to prevent water from penetrating. Rinse vehicle with water to remove all loose dirt. Wash vehicle using quality brand car wash soap. Follow manufacturer's recommendations for cleaning. Rinse well with water.

The vehicle exterior should be cleaned, waxed and buffed when water droplets no longer form on the painted surfaces.



CAUTION

Hot water can damage paint. Keep water cool or lukewarm.



CAUTION

Make sure cleaning solutions are not harmful to painted surfaces. Read the manufacturer's instructions before using.



CAUTION

Do not spray water jet directly into fresh air inlet dampers.



CAUTION

Do not aim high pressure water jet at radiator or condenser doors. This could damage the fins.

To prevent corrosion, remove caked-on dirt and road salt from the vehicle underbody using a high pressure water jet. Clean wheel housings, bumpers, muffler, tailpipe and brackets.

Carry out corrosion prevention cleaning at least twice a year. Spray underneath of the vehicle and let soak before cleaning. Let engine and exhaust system cool down before cleaning.

Tar Or Oil

Remove tar or oil as soon as possible with an approved automotive tar and oil remover or turpentine. Thoroughly clean area with car wash soap and water. Let dry, then wax.

Insects

Remove insect stains as soon as possible with lukewarm soap and water or insect remover.

Tree Sap

Remove tree sap or bird droppings with lukewarm soap and water. Do not allow to harden.

WINDSHIELD

To prevent windshield wiper streaking, keep silicone sprays away from windshield. Remove road film and wax build-up from windows with lukewarm soap and water or with an alcohol-based cleaning agent. If a chamois is used to dry and polish glass, use it exclusively for that purpose.

Wiper Blades

To avoid tearing frozen wiper blades, loosen them before removing. Remove and clean wiper blades periodically with an alcohol-based cleaning solution. Clean wiper blades using a sponge or soft cloth.

FLUID LEVEL VERIFICATION

Periodic inspection of oil and fluids levels is the most economical and easiest way to help your vehicle perform at its best. Rigorous oil level inspection and replacement will greatly help minimize expensive and unscheduled repairs.

ENGINE OIL LEVEL



WARNING

Check the engine oil level with vehicle parked on a level surface and with the parking brake engaged.

Check engine oil level when engine is still warm. Shut off engine and wait at least 10 minutes for oil to drain into oil pan before checking. Check engine oil level daily or before each trip. Add oil as required. Do not overfill. Remove dipstick, wipe clean and fully reinsert to ensure an accurate reading. Remove dipstick and check engine oil level.

Do not let the oil level fall below the marking on the dipstick. **Do not** overfill so the level is above the upper marking on the dipstick. Add oil through the oil filler pipe as required in order to maintain level within the safe range.

8-6 Care and Maintenance

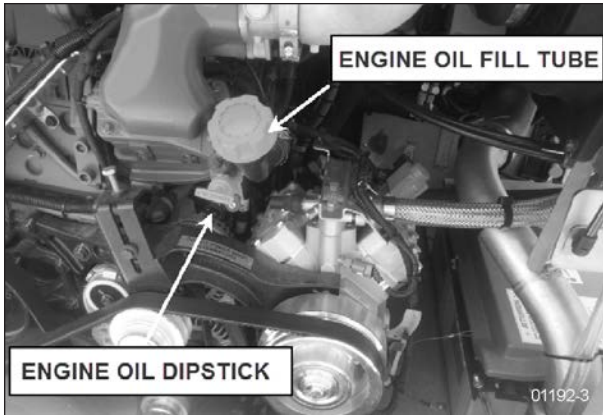

FIGURE 1: ENGINE OIL DIPSTICK - VOLVO D13 ENGINE

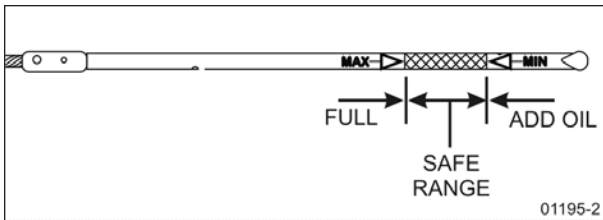



FIGURE 2: VOLVO D13 ENGINE OIL LEVEL DIPSTICK

TRANSMISSION FLUID LEVEL

 **DANGER**

To prevent personal injury, do not service transmission wearing loose clothing. Stand clear of the engine and rotating components while checking the oil level.

 **CAUTION**

Do not mix fluid types or brands because of possible incompatibility.

 **CAUTION**

Use clean fluid and containers when filling transmission. Never use containers that have contained water or antifreeze (Glycol).

Allison Automatic Transmission Fluid Level

The transmission fluid level can be checked with the dipstick or with the use of the shift selector display. For more information on how to use the shift selector display to check the transmission oil level, refer to "[OIL LEVEL CHECK USING THE PUSHBUTTON SHIFT SELECTOR](#)" on page 2 in Appendix B.

The transmission fluid level dipstick is accessible through the engine compartment rear door and is located on the left side of the engine.

To check the transmission fluid level, a "cold check" and a "hot check" must be performed. A cold check must be made when the transmission fluid is between 60°F and 120°F (16°C and 50°C).

NOTE

Perform the cold check first to verify the transmission fluid level before performing the hot check.

To prevent dirt and foreign matter from entering the transmission, clean the end of the oil fill tube before removing dipstick. To remove dipstick, unscrew filler cap approximately three turns and pull out dipstick.

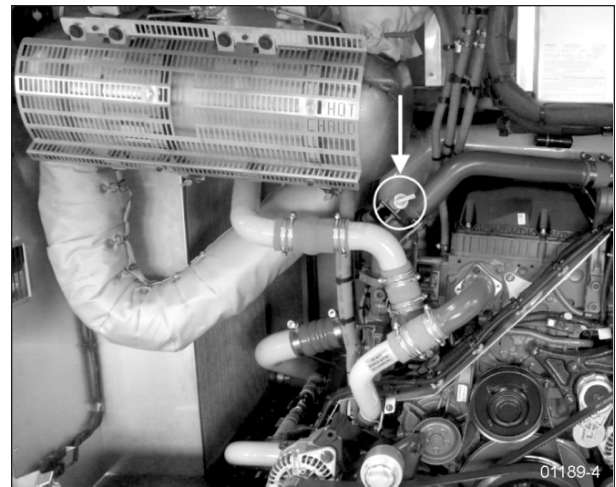

FIGURE 3: TRANSMISSION FLUID DIPSTICK (H3 SERIES)

• Cold Check

Run the engine until the transmission fluid temperature is between 60°F and 120°F (16°C and 50°C). With the engine idling, make sure the parking brake is applied and the transmission is in neutral (N). Shift transmission from forward (D) to reverse (R) and back into neutral (N) to fill clutch cavities with fluid. Remove and wipe the dipstick with a clean cloth. Check fluid level. If the fluid level is within the COLD RUN band, the fluid level is correct and a hot check can be performed. If the fluid level is on or below the lower line of the COLD RUN band, add fluid until the level lies within the COLD RUN band. If the

fluid level is above the COLD RUN band, drain fluid until the level is within the band.

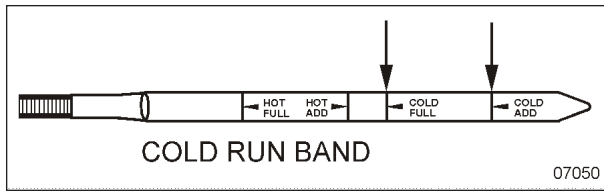

FIGURE 4: TRANSMISSION FLUID LEVEL DIPSTICK (TYPICAL)



CAUTION

The fluid level rises as fluid temperature rises. Do not add fluid above the "cold run" band before the transmission reaches 180°F to 220°F (82°C to 104°C).

• **Hot Check**

Make sure the transmission fluid temperature is between 160°F and 200°F (71°C and 93°C) before performing the hot check. With the engine idling between 500 and 800 RPM and the parking brake applied, shift transmission into neutral (N). Remove and clean dipstick, then check fluid level. If the fluid level is on or under the lower HOT RUN line, add just enough fluid to bring up the level to the middle of the HOT RUN band.

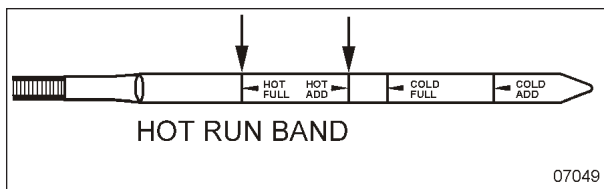

FIGURE 5: TRANSMISSION FLUID LEVEL DIPSTICK (TYPICAL)

Replace dipstick and tighten the filler tube cap until the rubber seal is correctly seated.



CAUTION

Do not overfill transmission fluid reservoir. Severe damage may result.

POWER STEERING FLUID LEVEL

The power steering fluid tank is fixed on the main power compartment wall, accessible by the R.H. compressor door.

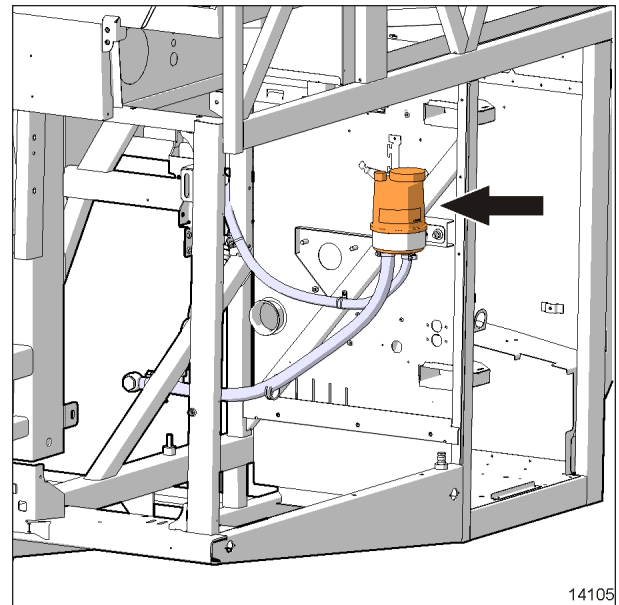

FIGURE 6: POWER STEERING RESERVOIR

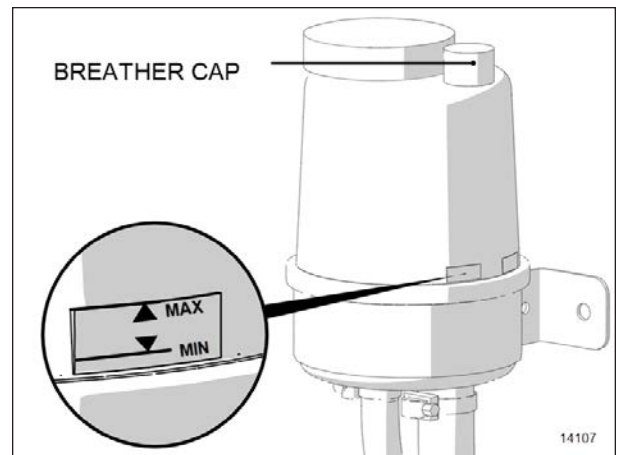

FIGURE 7: POWERSTEERING FLUID TANK

Check fluid level as follows:

1. Stop engine;
2. Open compartment door;
3. Thoroughly clean the reservoir and its immediate vicinity to protect the fluid from being soiled by impurities;
4. Check fluid level through the clear bowl and compare with the MIN & MAX marking affixed on the bowl;
5. Remove the breather cap and top up level to "MAX" mark;
6. Reinstall the breather cap.

8-8 Care and Maintenance

DRIVE AXLE WHEEL BEARING OIL LEVEL

Drive axle wheel bearings are lubricated by the differential oil. Maintain differential oil at correct level to ensure adequate lubrication of drive axle wheel bearings at all times.

FRONT AND TAG AXLE WHEEL HUBS

The unitized hub bearings used on the NDS range of axles are non-serviceable items. Bearings are pre-adjusted, lubricated and have seals fitted as part of the manufacturing process. The bearings are greased for life and there is no need or facility for re-lubrication.

COOLANT FLUID LEVEL

Coolant level is correct when coolant reaches the middle of the surge tank sight glass when cold (ambient temperature). Fill the tank as necessary with the same 50/50 water-antifreeze mixture normally used. Do not mix two different types of coolant. Refer to the Maintenance Manual for proper coolant type specifications or see the label affixed near the coolant surge tank on the vehicle.



CAUTION

On Volvo D13 engine, use only Extended Life Coolant (ELC). Do not add supplemental coolant additives (SCA) to extended life coolant. Do not use a coolant filter containing Supplemental Coolant Additives (SCA).

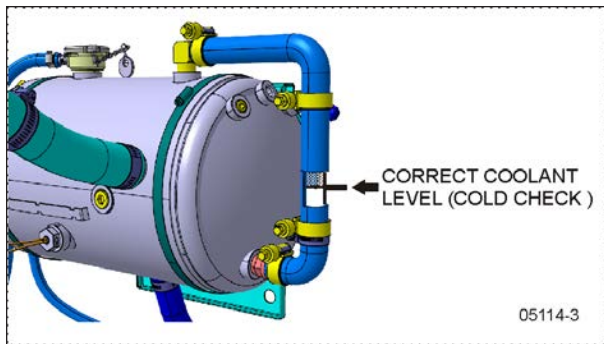

FIGURE 8: SURGE TANK IN ENGINE COMPARTMENT



WARNING

Hot engine coolant is under high pressure. Allow engine to cool down before adding coolant.

WINDSHIELD WASHER & HEADLIGHTS WASHER RESERVOIRS

The windshield washer reservoir and headlights washer reservoir are located in the front service compartment door. The windshield washer reservoir has a capacity of 5.3 US gallons (20 liters) while the headlights washer reservoir has a capacity of 2.6 US gallons (10 liters). Check fluid level regularly.

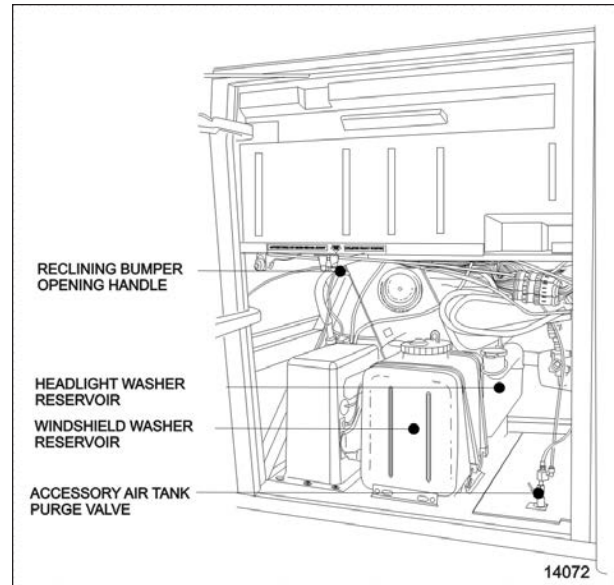

FIGURE 9: WINDSHIELD WASHER FLUID RESERVOIR

The windshield spray jets are located on the windshield wipers and are angled to spray towards the center of the windshield.

Adjust the headlights washer nozzles according to the instructions found in section 23 of the maintenance manual. You may use water or windshield washer fluid as well.



CAUTION

During cold weather days, use windshield washer fluid suitable for freezing temperature.

OTHER VERIFICATIONS

It is good practice to regularly inspect the vehicle for signs of component wear and to perform safety and maintenance routines.

ELECTRIC COOLING FANS

Inspect fan blades regularly, check for dirt or grime accumulations on the blade that could cause vibrations, clean as necessary using water and regular strength degreaser:

Check for cracks and signs of abrasion on the blades that could indicate contact with debris or obstruction during operation;

Check the bottom of the shroud cover and remove debris that could have accumulated. In sub-zero winter area, also check for snow and ice accumulation that could block the fan blades rotation;

Open the fan shroud as necessary (remove top and bottom hex screws) to facilitate cleaning and debris removal;



FIGURE 10: FAN SHROUD TOP & BOTTOM HOLD-DOWN SCREWS

NOTE

Electric cooling fan motors are sealed and certified IP6K9K and IP68. They can therefore be safely power/pressure washed.

AIR TANK PURGE

The vehicle is equipped with many air tanks. Purge the accessory air tank before each trip. The accessory air tank drain cock is accessible from the front service compartment.

The wet, primary, secondary and optional air tanks must be purged at every oil change or at least every 12,500 miles (20 000 km). They are equipped with a drain cock underneath the tank. Drain tanks by turning cocks counterclockwise.

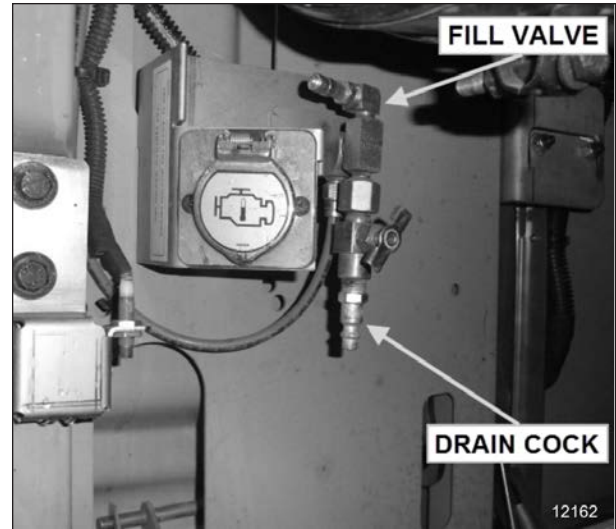

8-10 Care and Maintenance

FIGURE 11: ENGINE COMPARTMENT FILL VALVES

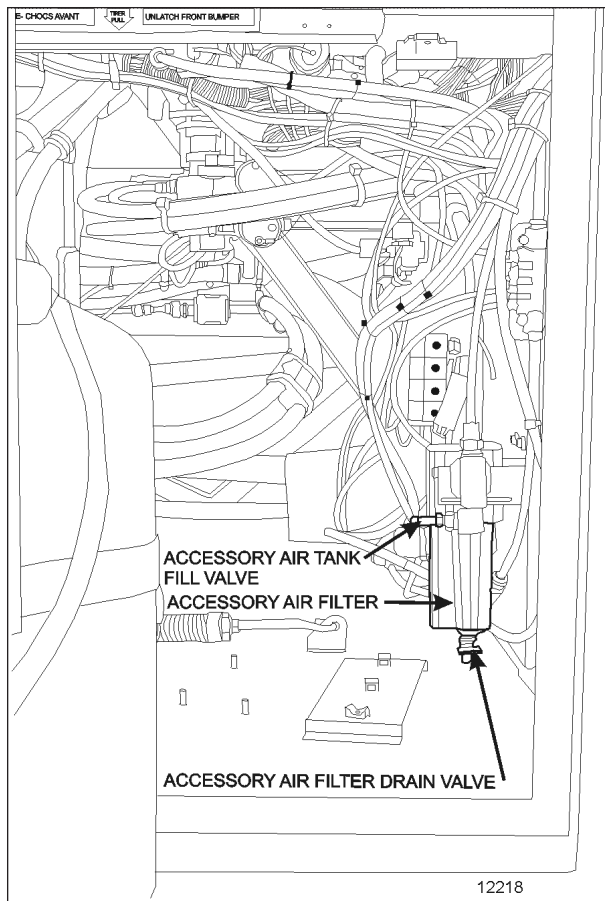

FIGURE 12: FRONT SERVICE COMPARTMENT

FIRE EXTINGUISHERS

Inspect fire extinguishers monthly to ensure operation in emergency situations.

On extinguishers with a pressure gauge, the needle should be in the green or NORMAL range. Refill or replace extinguisher if pressure is below normal;

Check that seal on handle is intact;

Check that hose nozzle is in good condition and the nozzle is free of obstructions;

Keep fire extinguishers clean.

PRIMARY FUEL FILTER

A primary fuel filter is installed on the engine. This filter may consist of a filter cartridge with a drain valve at the bottom, or a filter cartridge, a water separation bowl and may have a fuel heater built in. It is used to prevent water from entering the

fuel system. The primary fuel filter should be drained periodically or when the telltale light on the dashboard illuminates if equipped with this system. To drain water, loosen the drain valve below the separator. Close the drain valve when finished.

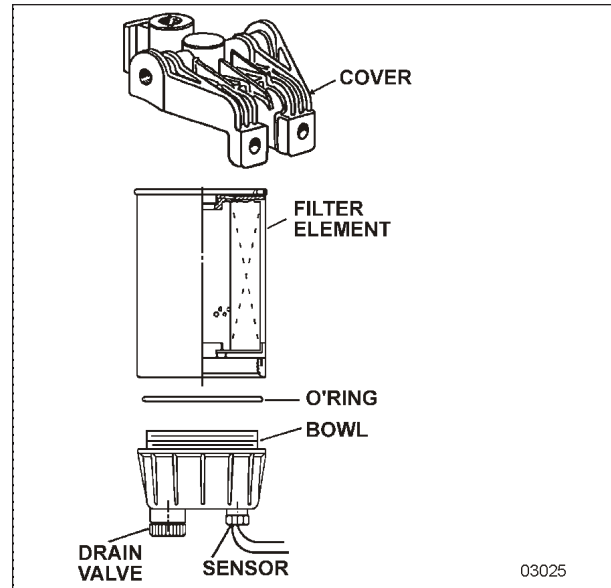

FIGURE 13: FUEL FILTER/WATER SEPARATOR

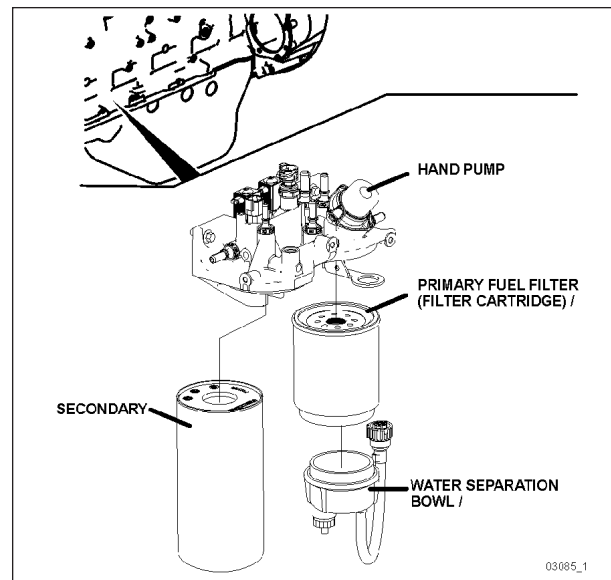

FIGURE 14: FUEL FILTERS WITH VOLVO D13 ENGINE

The optional Fuel Pro 382 diesel fuel filter system consists of a permanently mounted fuel processor, a replaceable filter element, a filter element cover and collar and a fluid filter base assembly. This system is installed between the fuel tank and the fuel pump and replaces the primary fuel filter. The filter serves as a water separator as well as a fuel filter. To drain water,

loosen the drain valve below the separator one quarter turn. Close the drain valve when finished.

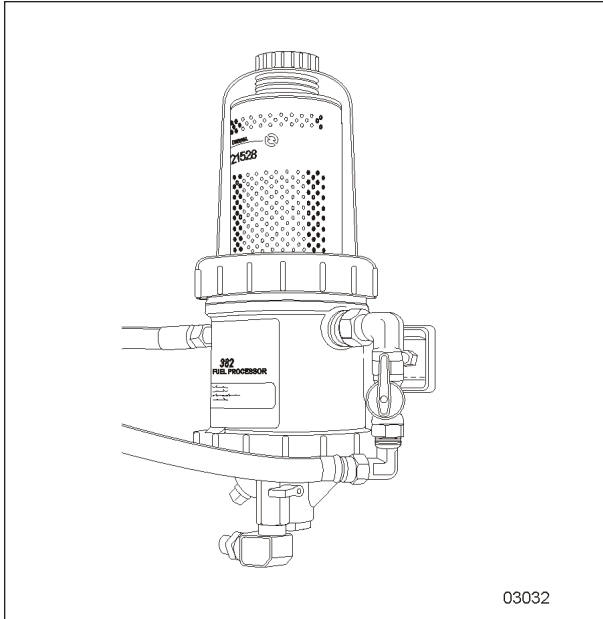

FIGURE 15: DAVCO FUEL PRO 382 INSTALLATION

DRIVER'S A/C COMPRESSOR BELT

For vehicles equipped with driver's A/C, the air conditioning compressor is driven by a multi-V-belt.

Belt tension is achieved by an automatic belt tensioner. No adjustment is required.

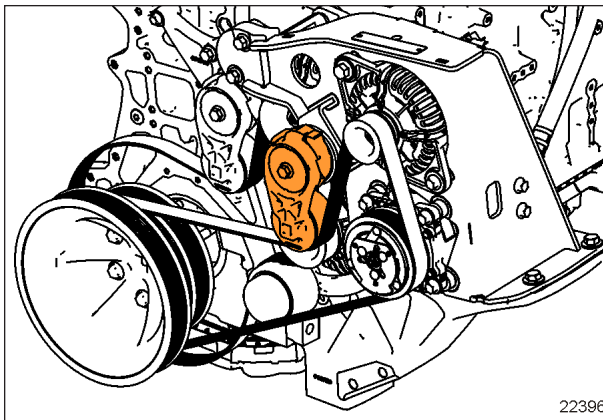

FIGURE 16: BELT TENSIONER

- Do not treat belts with any compounds. Keep belts dry.
- Periodically inspect belt and pulleys for wear or damage;

CENTRAL A/C COMPRESSOR BELTS

The air conditioning compressor is driven by two V-belts.

FIGURE 17:

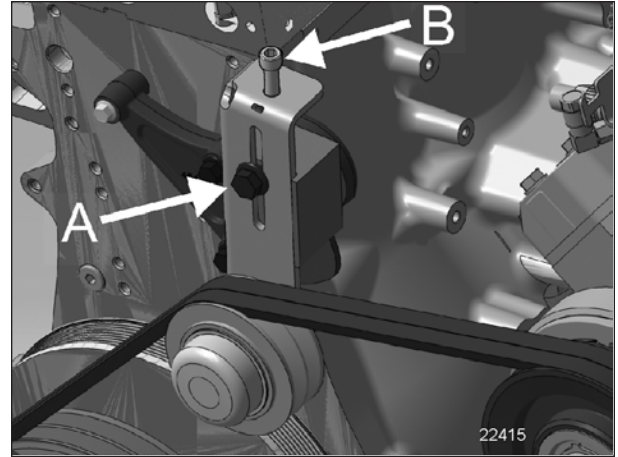

FIGURE 18: BELT TENSIONER

Belt tensioning is applied through the tensioner adjustment screw B. Loosen lock bolt A prior adjustment. Tighten lock bolt A to 43 lbf-ft once completed.

Belt tension should be within the following values:

- New belts: 90-100 lbs.
- Used belts: 75-85 lbs.

Check belt tension using a belt strand tension gauge.

- Once adjustment completed, allow the engine to run for about ten minutes. Check belt tension and adjust if needed.
- Do not treat belts with any compounds. Keep belts dry.
- Periodically inspect belt and pulleys for wear or damage;

FIGURE 19:

ALTERNATOR DRIVE BELTS

Automatic belt tensioners keep the correct tension so these belts do not require adjustment.

BACK-UP CAMERA

The back up camera is located on the rear cap. To clean the camera's protective glass,

8-12 Care and Maintenance

spray with soapy water. Wipe with a clean damp rag or wiper blade.



WARNING

To avoid injury, do not clean camera with transmission in reverse (R). Shut off engine and apply parking brake before cleaning.



CAUTION

To prevent scratches to the camera protective glass, do not wipe with dry rag. Use a clean damp rag.

ENGINE AIR FILTER RESTRICTION INDICATOR

An air filter restriction indicator is used to monitor the vacuum level between the air filter and the turbocharger inlet. A red marker is displayed when the air filter is clogged. Replace the air filter when a red marker is displayed or after a maximum of two years. Reset by pressing on the indicator's extremity.

The air filter restriction indicator is located on the engine air intake duct.

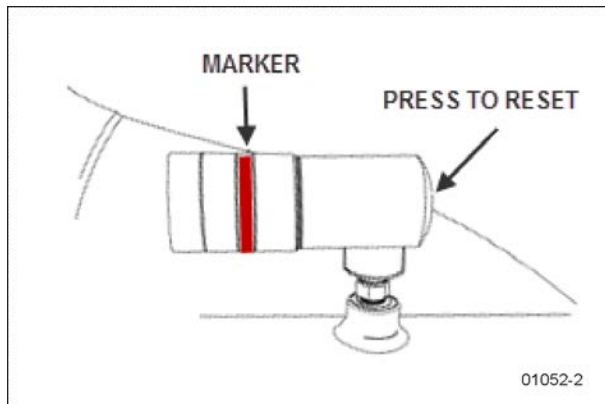

FIGURE 20: AIR FILTER RESTRICTION INDICATOR

MAIN POWER COMPARTMENT FAN AIR FILTER

For maximum service life of the electrical components, air filter should be inspected and cleaned as required in maintenance schedule to ensure proper ventilation and cooling of the main power compartment. Clean filter with an air jet in the opposite direction of normal air flow. Replace filter when necessary.



CAUTION

Be sure not to reverse filter upon installation.

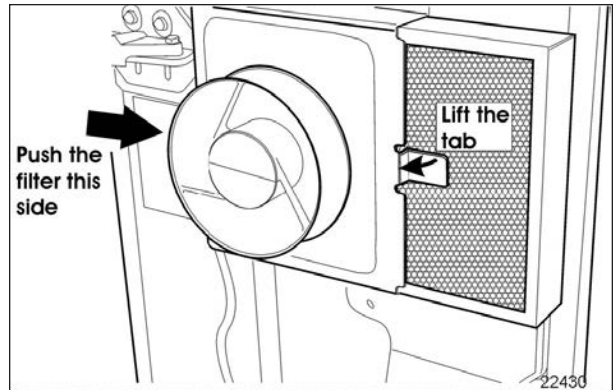

FIGURE 21:
MAIN POWER COMPARTMENT FAN AIR FILTER

A/C AND HEATING SYSTEM AIR FILTERS

For maximum air conditioning and heating system efficiency, air filters should be inspected and cleaned as required in maintenance schedule to ensure proper ventilation of the evaporator and heating radiator cores.

To clean filters, remove lint using a nylon brush, back flush with water, then dry with air.



CAUTION

Do not use high pressure water jet to avoid damaging filter.



CAUTION

Be sure not to reverse filter upon installation.

Driver's Area Air Filter

The driver HVAC system's air filter is located behind the dashboard R.H. side and it can be removed for cleaning or replacement. To gain access to the A/C filter, unscrew the grill located at the top step of the entrance door steps, remove the plastic cover holding the filter and slide out the air filter.

NOTE

If the windshield is continuously fogged, check that the driver's air filter is not clogged

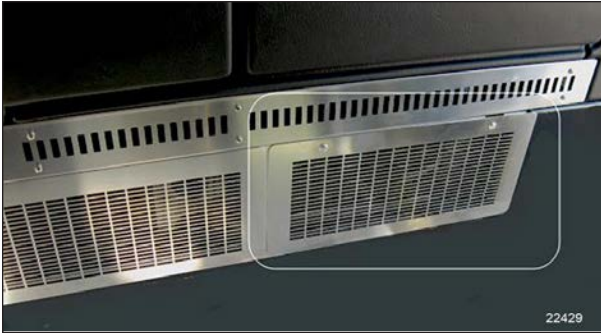

FIGURE 22: DRIVER'S AREA AIR FILTER GRILL REMOVAL

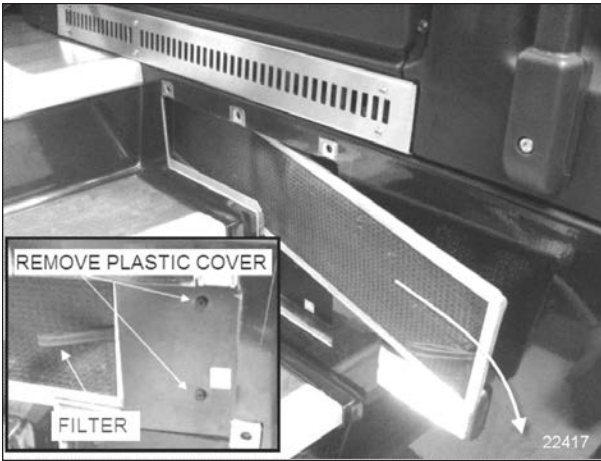



FIGURE 23: REMOVING DRIVER'S SECTION AIR FILTER

HOSE INSPECTION

Inspect hoses for leaks regularly to ensure efficient, economical and safe operation of the engine and related equipment. Carefully inspect all fittings, clamps and ties. To prevent chafing, make sure hoses are not touching shafts, couplings, heated surfaces, sharp edges or other parts. Since hose clamps and ties can vibrate loose or fail over time, frequently inspect and tighten or replace as necessary.

Correct leaking hoses immediately. Failure to correct leaks can cause severe damage to the equipment, as well as increase operating costs due to lost fluids. Treat fuel and oil leaks as an immediate fire hazard.

	<p>WARNING</p>
<p>Personal injury and property damage may result from fire caused by leaking flammable fluids.</p>	

Hose Service Life

Hoses have a limited service life. Thoroughly inspect hoses annually. Look for surface damage or indications of twisted, worn, crimped, cracked or leaking lines. Replace damaged hoses immediately.

Hoses should be replaced during major overhaul or after a maximum of seven service years. Be certain replacement hoses are matching the original equipment manufacturer's specifications.

LUBRICATION

Grease all lubrication points during scheduled maintenance. For heavy loads or extended use, lubricate more often. Refer to the Maintenance Manual, section 24 for information on lubrication.

WHEELS AND TIRES VERIFICATIONS

Check for loose wheel nuts. Inspect all types of rims for cracks. Cracks can appear in many places but typically radiate out from where a load is applied. Both aluminum alloy and steel wheel nuts should be tightened to 450 to 500 foot-pounds (610 to 680 N.m.) torque.

Keep the tires inflated to the recommended inflation pressure to prolong tire life and for safety.

<p>NOTE</p>
<p><i>For VIP vehicles, the cold tire inflation pressures are found on the DOT certification plate located under the L.H. console or behind the driver's seat.</i></p>

	<p>WARNING</p>
<p>Do not exceed maximum inflation pressure. Incorrect tire pressure increases tire wear and could lead to loss of driving control because of reduced road handling. Check tire pressure regularly.</p>	

	<p>WARNING</p>
<p>If replacement tires are different from those specified on the certification plate, pressure must be adjusted following manufacturer recommendations.</p>	

8-14 Care and Maintenance

- Vehicles equipped with TPMS

On vehicles equipped with the Beru Tire Pressure Monitoring System (TPMS), it is better to use the TPMS display as the primary reference to judge when tire pressure needs adjustment.

The TPMS presents pressure readings of each tire as a +/- deviation from the wanted target.

If a tire reads within +/- 3 PSI no adjustment is needed.

If a tire reads -4 PSI and below, re-inflate by the marked amount.

If a tire reads +4 PSI and above, deflate by the marked amount.

Relying on the TPMS system is better than relying on a hand gage since the TPMS is temperature compensated and remain accurate no matter if the tires are cold or hot.

Tires take up to 3 hours to get down to ambient temperature after a ride. A common mistake consists of checking pressure while the tires have not fully cooled down which leads into under-inflated tires. Relying on the TPMS eliminate this mistake.

Running tires at optimal pressure reduce tire wear, improve safety and fuel economy.

WHEEL BEARINGS

Check wheel bearing cover for overheating (especially after using the service brakes) during fuel stops by touching the wheel bearing cover.

SERVICE BRAKE TEST

Check for correct pressure build-up. Stop engine and check pressure gauge. Pressure loss should not exceed 3 psi/min (21 kPa/min) with engine stopped and without brake pedal applied. Air loss should not exceed 7 psi/min (48 kPa/min) with engine stopped and brake pedal fully applied.

A convenient way to proceed to the service brake test is with the use of the DID menu "Air Leakage Monitor". For more information, refer to "[DRIVER INFORMATION DISPLAY](#)" on page 1 in Section 5 Other features.

PARKING BRAKE TEST

Release parking/emergency brake. Pump service brake pedal until air pressure drops to 65 psi (448 kPa). Make sure the warning buzzer operates and that the emergency brakes apply (the control valve knob lifts up). Allow air pressure to reach 95 psi (655 kPa) before releasing parking brake.

Driving the vehicle while the parking brake is applied should not be possible.

EXTERIOR LIGHTING VERIFICATION WITH TEST MODE

This useful function allows quick verification of the vehicle exterior lights.

Activating The Test Mode:

When the vehicle is stationary (parking brake applied), pull up the multi-function lever 3 times within 3 seconds to activate the test mode. This test can be done when the engine is not running providing that the battery charge is sufficient (above 24.0 volts).

This test can be done when the engine is not running providing that the battery charge is sufficient (above 24.0 volts).

The telltale panel alarm emits a sound each second to remind that the test mode is in progress.

NOTE

Lighting test mode can also be initiated and stopped using the DID menu "Exterior Lamp Inspection". For more information, refer to "[DRIVER INFORMATION DISPLAY](#)" on page 1 in Section 5 Other Features.

Stopping The Test Mode:

To stop the test mode, pull up the multi-function lever once or turn the ignition OFF or remove the parking brake.

NOTE

The test mode is useful to check the operation of the multiplex outputs and the exterior lights. It doesn't test the functionality of the commands related to the exterior lighting. For a complete testing, the directional signal commands, the headlights commands and the brake pedal have to be checked before. Once these commands tested, activate the test mode to check the exterior lighting.

Using The Test Mode:

First, test the functionality of the commands related to the exterior lighting:

- Activate the right directional signal and check that the corresponding cluster telltale light illuminates.
- Activate the left directional signal and check that the corresponding cluster telltale light illuminates.
- Activate the hazard warning flashers and check that the corresponding cluster telltale lights illuminate.
- Press the headlights rocker switch in first position and confirm that the instrument panel illuminates.
- Press the headlights rocker switch in second position and confirm that the headlights illuminate.
- Turn on the high beams and check that the corresponding cluster telltale light illuminates.
- Press on the brake pedal and check that the STOP telltale light illuminates

Once these commands tested, activate the test mode to check the exterior lighting.

Go to the front of the vehicle and check the lights:

- Left and right directional signals.
- Identification lights and clearance lights.
- Low beams.
- High beams.

Left side and right side of the vehicle:

- Directional signals.
- Marker lights.

Rear of the vehicle:

- Directional signals.
- Identification lights and clearance lights.
- Stoplights and tail lights.
- Back-up light.
- Center High mounted Stop Light (CHSL)

8-16 Care and Maintenance

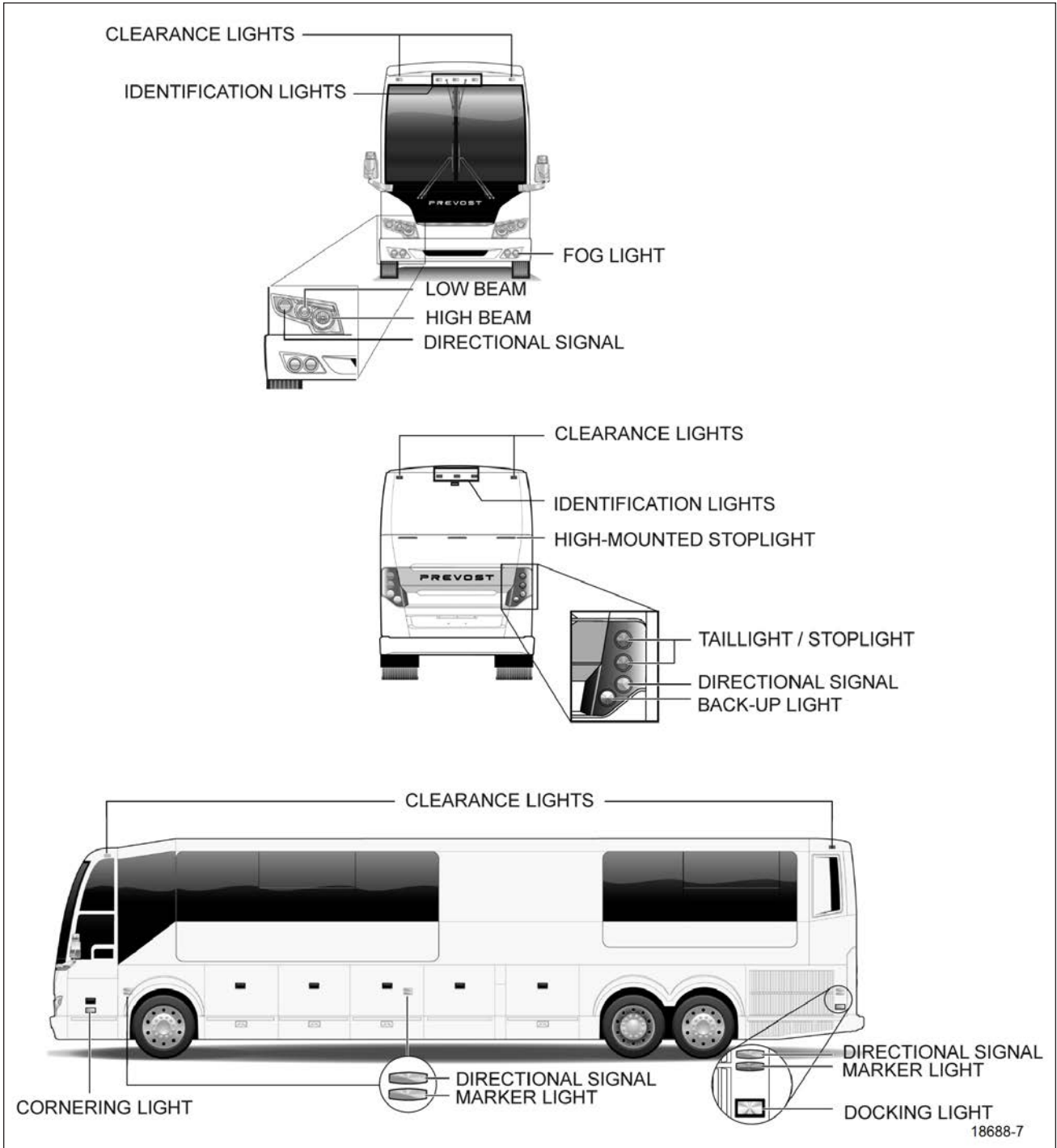

FIGURE 24: EXTERIOR LIGHTING (H3-VIP)

GENERAL RECOMMENDATIONS

- Understand the basic principles of vehicle operation;
- Always maintain the vehicle in good running condition;
- Do not drive with low fuel. If the fuel tank runs dry, the engine will not start until the air is bled from the fuel system. Refer to "Maintenance Manual" for more information;
- Allow engine to run for at least two minutes at normal idle before shutting off;
- Engine should be at idle when shifting from neutral (N) to forward (D) or from neutral (N) to reverse (R);



CAUTION

Fast idle should always be turned off before releasing the parking brake and putting the coach in gear. Driveline damage can result if the fast idle switch is always left on.

- The automatic transmission does not have a park (P) position. Place transmission in neutral (N) position and apply parking brake when the vehicle is stopped. A warning buzzer will sound if the engine is stopped and the parking brake has not been applied when foot pressure is removed from the brake pedal;
- Always follow the procedures described in this manual;
- Unless stated otherwise, shut off the engine before performing all servicing, lubrication and maintenance tasks;
- Do not attempt to push or pull-start the coach;
- The vehicle may be damaged if towed with the axle shafts or driveshaft connected;
- Chemical fire extinguishers are provided with the vehicle. Placement may vary depending on options and models. Take a moment to locate them in your vehicle.
- In case of fire, immediately evacuate all occupants. Occupant safety is the first priority. Do not attempt to extinguish the fire if there is immediate danger or risk for personal injury;
- When driving on ice and snow, accelerate and decelerate gradually;



WARNING

Report all problems affecting passenger or driver safety to a Prevost service center. Have problems corrected immediately.

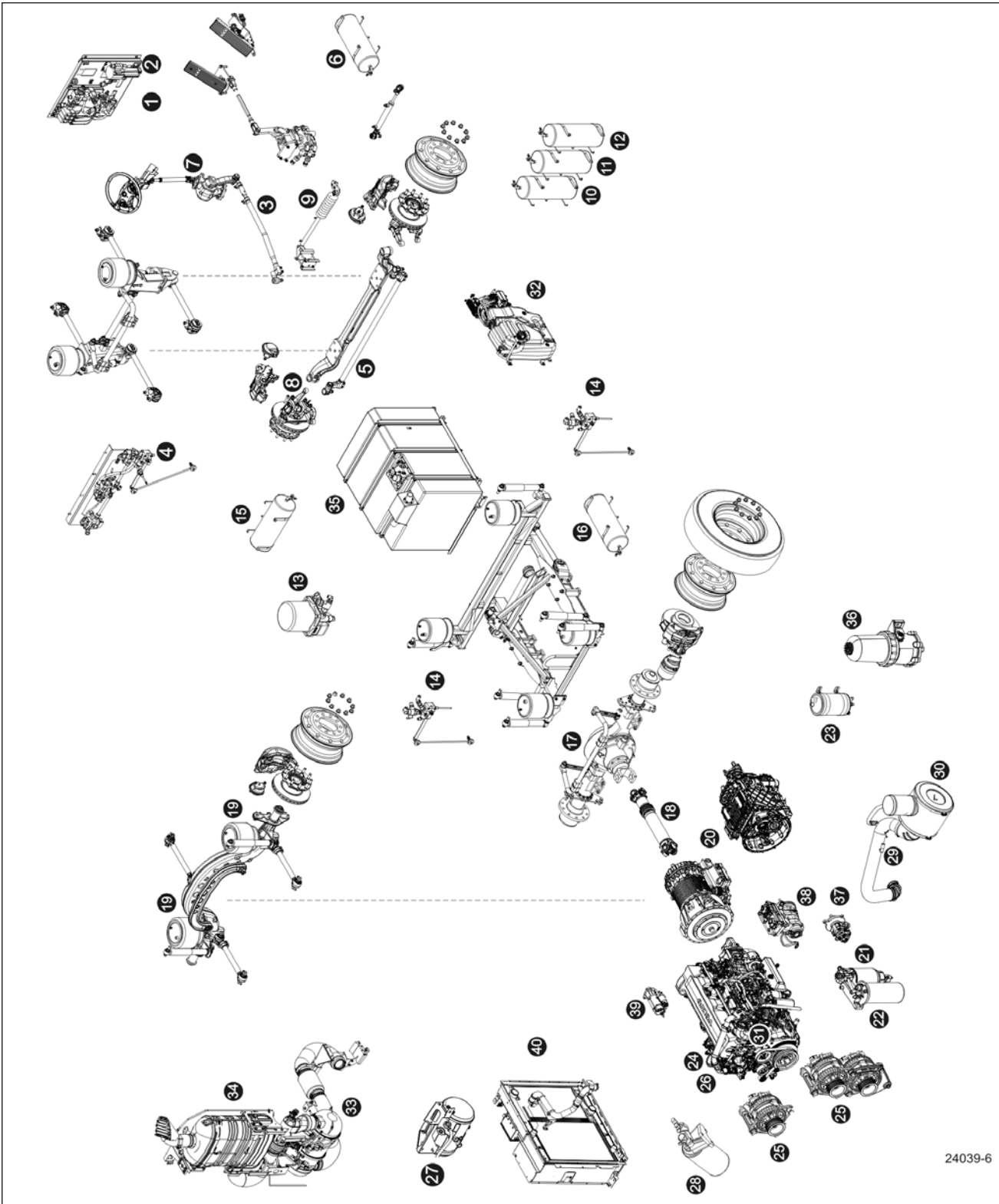

24039-6

FIGURE 25: H3 SERIES COMPONENTS IDENTIFICATION (MAY DIFFER SLIGHTLY FROM ACTUAL VEHICLE)

8-20 Care and Maintenance

- | | | | |
|----|---|----|---|
| 1 | Accessories air tank drain cock | 21 | Primary fuel filter |
| 2 | Accessories air filter | 22 | Secondary fuel filter |
| 3 | Steering drag link | 23 | Power steering fluid tank |
| 4 | Height control valve (front) | 24 | Engine oil filter |
| 5 | Steering tie rod | 25 | Alternators |
| 6 | Accessories air tank | 26 | Allison transmission oil dipstick |
| 7 | Steering column U-joints | 27 | Engine coolant surge tank |
| 8 | Steering knuckle pins | 28 | Coolant filter & conditioner |
| 9 | Steering damper cylinder | 29 | Engine air filter restriction indicator |
| 10 | Emergency / parking brake overrule tank | 30 | Engine air filter |
| 11 | Secondary air tank | 31 | Engine oil dipstick and filler tube |
| 12 | Kneeling air tank | 32 | DEF tank |
| 13 | Air dryer | 33 | Diesel particulate filter |
| 14 | Height control valve (rear) | 34 | SCR catalytic converter |
| 15 | Wet air tank | 35 | Diesel fuel tank |
| 16 | Primary air tank | 36 | Davco Fuel Pro 382 fuel filter |
| 17 | Differential | 37 | Power steering pump |
| 18 | Propeller shaft | 38 | Air compressor |
| 19 | Tag axle lever pivot | 39 | Starter |
| 20 | Transmission | 40 | Cooling Assembly (Radiator & CAC) |

WALK-AROUND INSPECTION (BEFORE EVERY TRIP)

It is good practice to make a visual inspection of key areas on the vehicle every day (or before every trip for private coaches) and to correct any problem found.

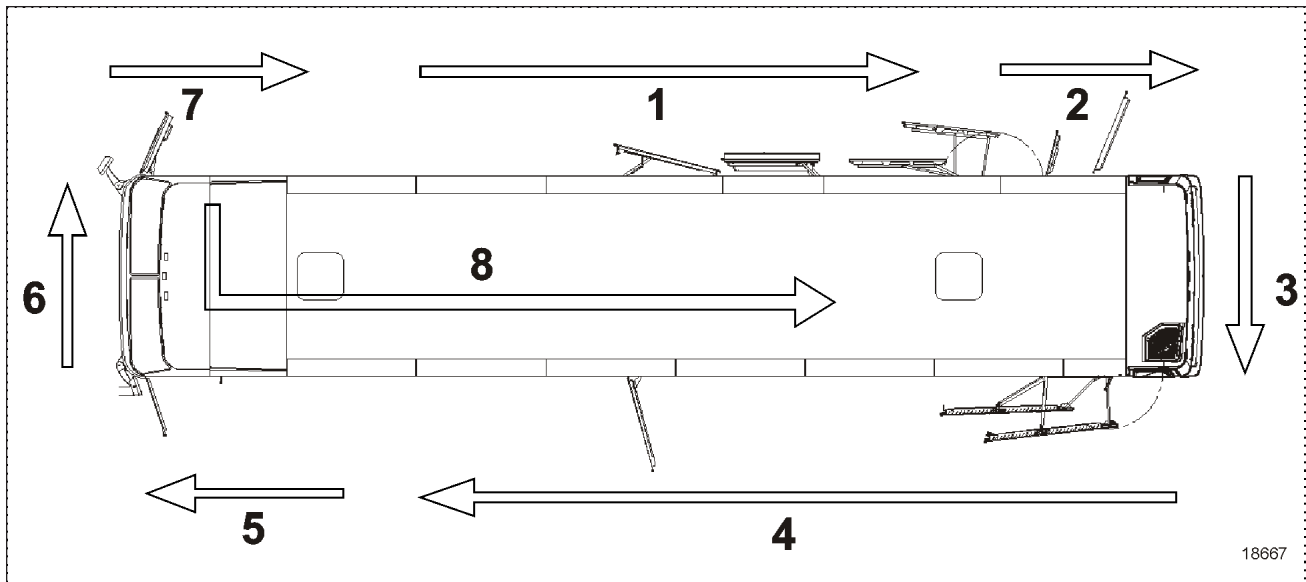

FIGURE 26: H3 SERIES WALK-AROUND INSPECTION

NOTE

Inspect the coach in a circular manner as shown in the illustration.

APPROACHING THE VEHICLE

- Check under the coach for oil, fuel or coolant leaks or other signs of damage.
- Check exterior body surfaces for signs of damage.

PREPARATION

- Drain accumulated water from accessories air tanks.
- Close air tank drain valves.
- Start the engine and let the air pressure build up to normal. Stop engine.
- Switch on hazard warning flashers.
- Make sure parking brakes are applied.

STEP 1: RIGHT SIDE

- Check that baggage and service compartment doors are properly latched and locked.
- Check condition of wheels and rims. Especially look for cracks, missing nuts, bent or broken studs.

8-22 Care and Maintenance

- Check condition of tires: properly inflated, no serious cuts, bulges, tread wear or any signs of misalignment; valve stems not touching wheels or rims; valve caps in place and no objects stuck between the wheels.

STEP 2: ENGINE COMPARTMENT RIGHT SIDE AREA

- Drain wet air tank by opening drain cock. Close drain cock when completed.
- Check engine and surrounding areas for coolant, oil and fuel leaks.
- Check primary fuel filter/water separator and drain if necessary. Close drain valve after draining.
- Check power steering reservoir fluid level, add if necessary.
- Check wiring harness for signs of damage.

STEP 3: ENGINE COMPARTMENT

- Check engine and surrounding areas for coolant, oil and fuel leaks.
- Check wiring harness for signs of damage.
- Check for loose, worn or broken belts.
- Check belts tension adjustment.
- Check engine crankcase oil level, add if necessary.
- Check Allison transmission fluid level (can also be checked from push-button shift selector), add if necessary.
- Check coolant surge tank fluid level, add if necessary.
- Check air cleaner restriction indicator, replace air cleaner when red signal locks in full view.
- Check stop light, tail light, directional signal light and back-up light assembly, they should be clean.

STEP 4: REAR LEFT SIDE

- Check condition of wheels and rims. Especially look for cracks, missing nuts, bent or broken studs.
- Check condition of tires: properly inflated, no serious cuts, bulges, tread wear or any signs of misalignment; valve stems not touching wheels or rims; valve caps in place and no objects stuck between the wheels.
- Check that baggage and service compartment doors are properly latched and locked.
- Check optional auxiliary coolant heater for fuel leaks.

STEP 5: FRONT LEFT SIDE

- Check condition of wheel rim. Especially look for cracks, missing nuts, bent or broken studs.
- Check condition of tire: properly inflated, no serious cuts, bulges, tread wear or any signs of misalignment; valve stem not touching wheel or rim; valve cap in place.
- Check windshield washer reservoir fluid level and add as necessary.
- If equipped, check headlights washer reservoir fluid level and add as necessary
- Drain accessory air tank by opening drain cock. Close drain cock when completed.

STEP 6: FRONT

- Check windshield for damage and clean if dirty.
- Check windshield wiper arms for proper spring tension.
- Check wiper blades for any damage, “dead” rubber and attachment to arm.
- Check clearance and identification lights, they should be clean.
- Check high and low beams, they should be clean. If equipped, check fog lights.
- Check left and right directional signals, they should be clean.
- Check to see that there is no mud, snow, ice build-up or other obstruction in front of the ACB radar sensor if applicable.

STEP 7: FRONT RIGHT SIDE

- Check condition of wheel rim. Especially look for cracks, missing nuts, bent or broken studs.
- Check condition of tire: properly inflated, no serious cuts, bulges, tread wear or any signs of misalignment; valve stem not touching wheel or rim; valve cap in place.

STEP 8: INSIDE THE VEHICLE

- Check for proper operation of the entrance door.
- Check steps; clean them if there is any substance that makes them slippery, which makes coach entry/exit hazardous.
- Adjust and clean mirrors for adequate rear view vision.
- Verify proper operation of windshield wiper/ washer.
- Check for fire extinguishers to make sure they are ready for operation.

WITH ENGINE RUNNING

- Start engine and check for proper operation of all gauges. Perform a telltale light test (see [DIAGNOSTICS MENU](#) under Cluster Selftest in Section 5 Other Features) . Indicator lights and buzzers should all be OFF before driving.
- Using the message center display, perform a system diagnostic to check if error codes and anomalies were recorded in the vehicle electronic modules.
- Check for proper operation of electric and air horns and back-up alarm.
- Check automatic transmission oil level, using the pushbutton shift selector (see "[OIL LEVEL CHECK USING THE PUSHBUTTON SHIFT SELECTOR](#)" on page 2 in Appendix C).
- Check that there is enough fuel in the tank.
- Perform a parking brake test. Check both primary and secondary pressure gauges. Refer to “Other Verifications” in this section.
- Perform the exterior lighting verification using the test mode. Refer to "[OTHER VERIFICATIONS](#)" on page 8 in this section.
- Walk around the vehicle and listen for air leaks.
- Check for leaks and listen for unusual sounds coming from the turbocharger.

SECTION 9 - TECHNICAL INFORMATION

DIMENSIONS AND WEIGHTS	3
CAPACITIES	6
TURNING RADIUS	6
FUEL TYPE	8
BIODIESEL FUEL	8
WHEELS AND TIRES	8
RECOMMENDED TIRE INFLATION PRESSURE AT MAXIMUM COLD LOAD	8
BELTS	9
VOLVO D13 ENGINE	9
ALLISON TRANSMISSION	10
GEAR RATIOS	10
PROPELLER SHAFT	10
BRAKES	10
BRAKE CHAMBER EFFECTIVE AREA	10
AIR SYSTEM	10
ANTILOCK BRAKING SYSTEM (ABS)	10
TROUBLESHOOTING AND TESTING	10
AUTOMATIC TRACTION CONTROL (ATC) – ELECTRONIC STABILITY CONTROL (ESC)	10
STEERING	11
ELECTRICAL SYSTEM	11
AXLES	11
FRONT AXLE - INDEPENDENT FRONT SUSPENSION (IFS)	11
DRIVE AXLE	11
TAG AXLE	11
SUSPENSION	11
INDEPENDENT FRONT SUSPENSION	12
DRIVE AXLE	12
TAG AXLE	12
ALIGNMENT SPECIFICATIONS	12
COOLING SYSTEM	13
FUEL SYSTEM	13
EXHAUST SYSTEM	13
HEATING AND AIR CONDITIONING	13
OIL SPECIFICATIONS	14
ENGINE	14
ALLISON TRANSMISSION	14
DIFFERENTIAL	14
POWER STEERING RESERVOIR	14

9-2 Technical Information

PLATES AND CERTIFICATION	14
SAFETY CERTIFICATION	15
DOT CERTIFICATION PLATE	15
EPA ENGINE LABEL	15
VEHICLE IDENTIFICATION NUMBER (VIN)	16
VIN DEFINITION	17
COACH FINAL RECORD	18

DIMENSIONS AND WEIGHTS

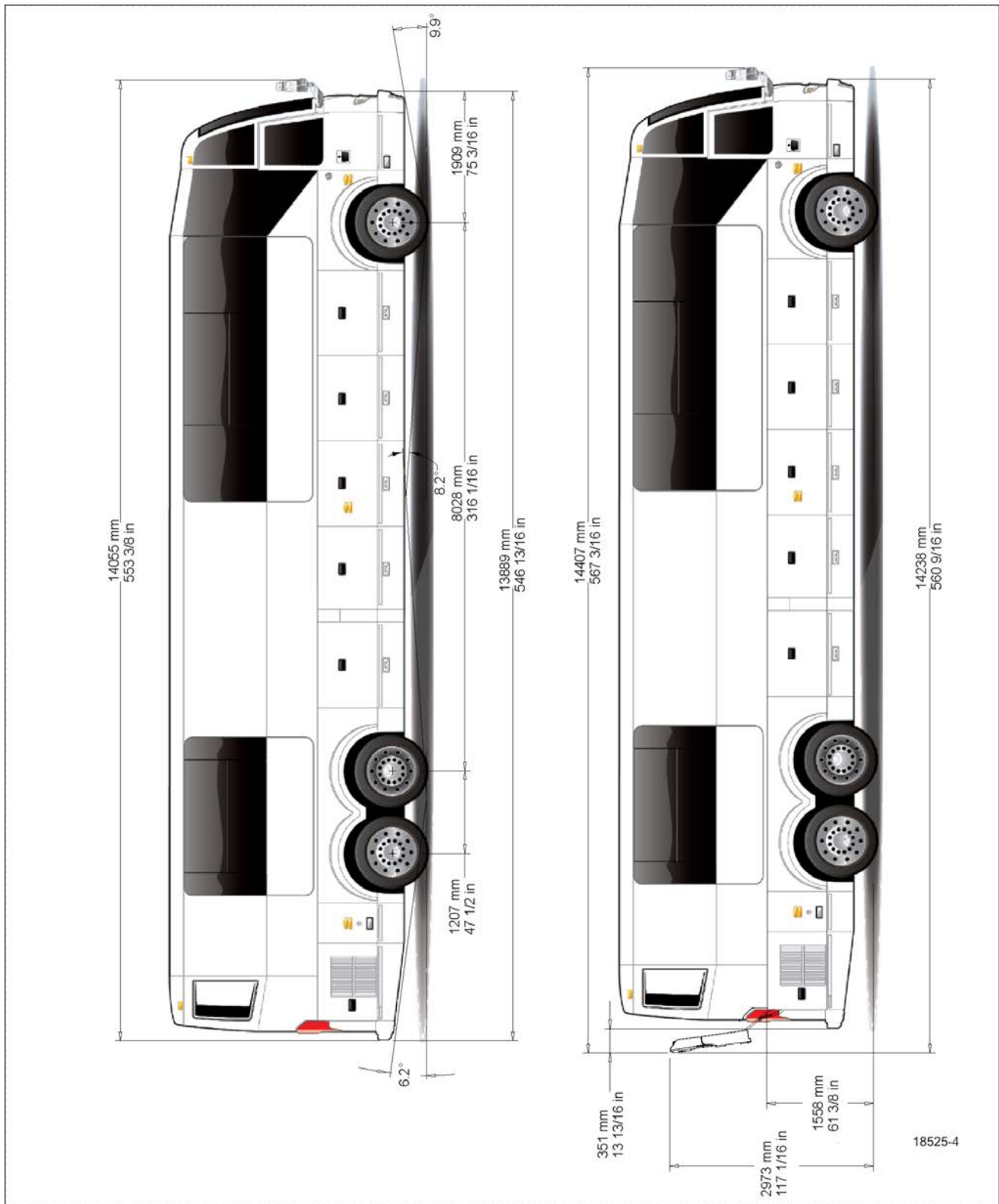

FIGURE 1: H3-45 VIP OVERALL DIMENSIONS

9-4 Technical Information

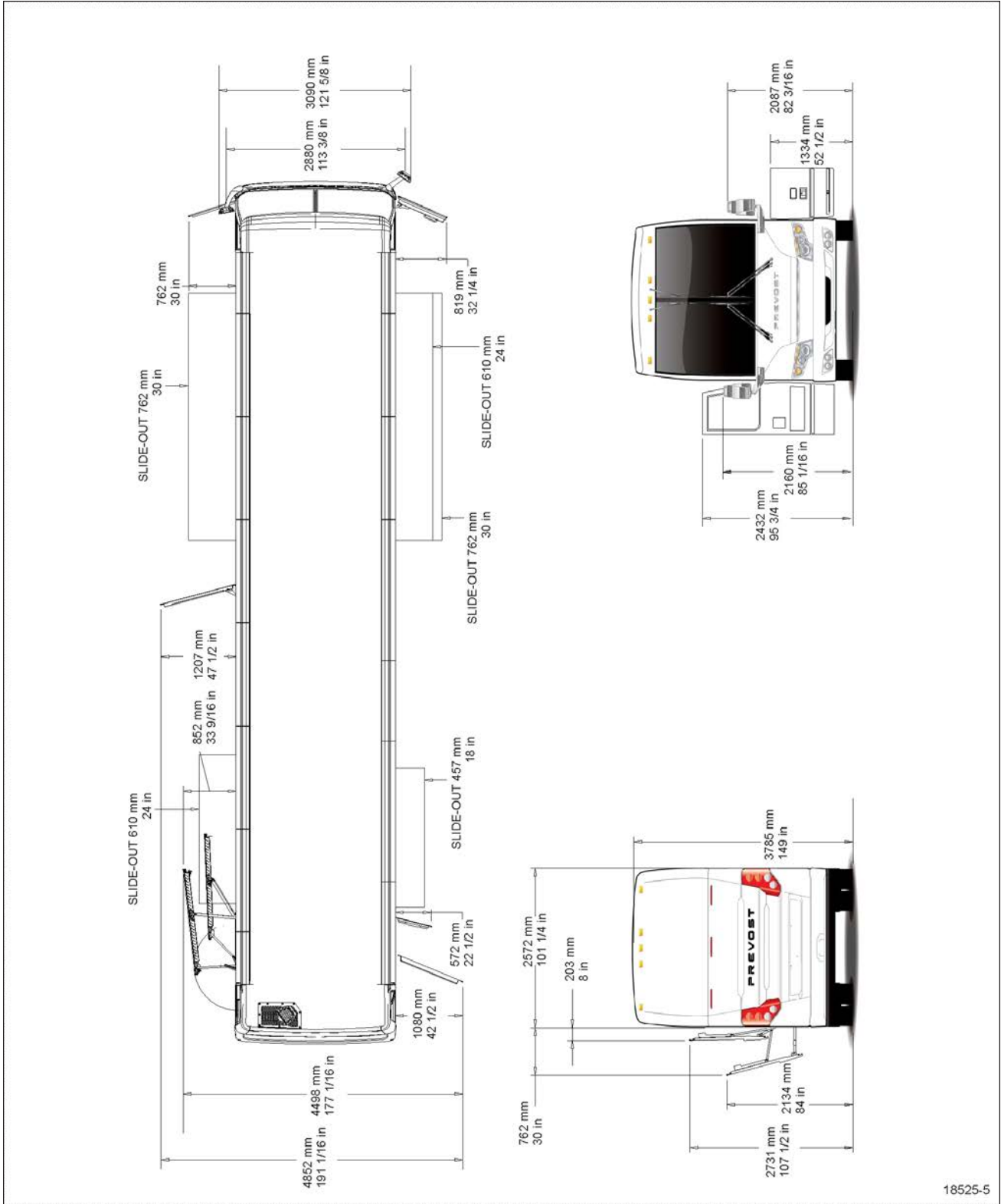

FIGURE 2: H3-45 VIP OVERALL DIMENSIONS

18525-5

DIMENSIONS AND WEIGHTS	H3-45 VIP
Overall length (including bumpers)	45' (13,7 m)
Overall width	102" (2 591 mm)
Overall height	149" (3 785 mm)
Wheelbase (center of front axle to center of drive axle)	313.4" (7 960 mm)
Floor height from ground	63" (1600 mm)
Ground clearance	11" (280 mm)
Step height from ground	14" (356 mm)
Step height (other steps)	7" (178 mm)
Headroom	83" (2 260 mm)
Entrance door opening width	28" (711 mm)
Front overhang	75" (1 905 mm)
Rear overhang	108" (2 743 mm)
Front track	86.3" (2 192 mm)
Drive track	74.3" (1 887 mm)
Rear track (Tag axle)	83.8" (2 128 mm)
Curb weight (before conversion,	
Gross Vehicle Weight Rating (G.V.W.R.)	55 000 lb (25 174 kg)
Front axle Gross Axle Weight Rating (G.A.W.R.)	19 000 lb (8 618 kg)
Drive axle (G.A.W.R.)	22 500 lb (10 206 kg)
Tag axle (G.A.W.R.)	14 000 lb (6 350 kg)

NOTE

Curb weight is given as an indication only and is subject to vary from coach to coach, mostly due to optional equipment

The actual Gross Vehicle Weight Rating (G.V.W.R.) and the Gross Axle Weight Rating (G.A.W.R.) for front, drive and tag axles are listed on a certification plate located on the L.H. control panel in driver's section.

9-6 Technical Information

CAPACITIES

CAPACITIES	H3-45 VIP
Volvo D13 Engine oil (refill volume with filter change)	40 US quarts (38 liters)
Fuel tank (legal capacity equal to 95% of volume)	222 US gal (840 liters)
Diesel Exhaust fluid tank (DEF)	16 US gal (60 liters)
Cooling system	27.5 US gal 104 liters
Allison Automatic Transmission (does not include external circuit)	10.03 U.S. gal (38 l) initial 6 US gal (23 liters) refill 6.9 US gal (26 liters) refill with retarder
Differential oil	20 US qts (19 liters)
Power steering reservoir	4 US qts (3,8 liters)
A/C compressor oil	2.8 US quarts (2.6 liters) high capacity system 420 ml (14.2 oz) small A/C system (initial filling with new empty system)
Windshield washer reservoir	5.3 US gal (20 liters)
Refrigerant	24 lb (11 kg) high capacity system 8.5 lb (3.9 kg) (small A/C system with Aux air)

TURNING RADIUS

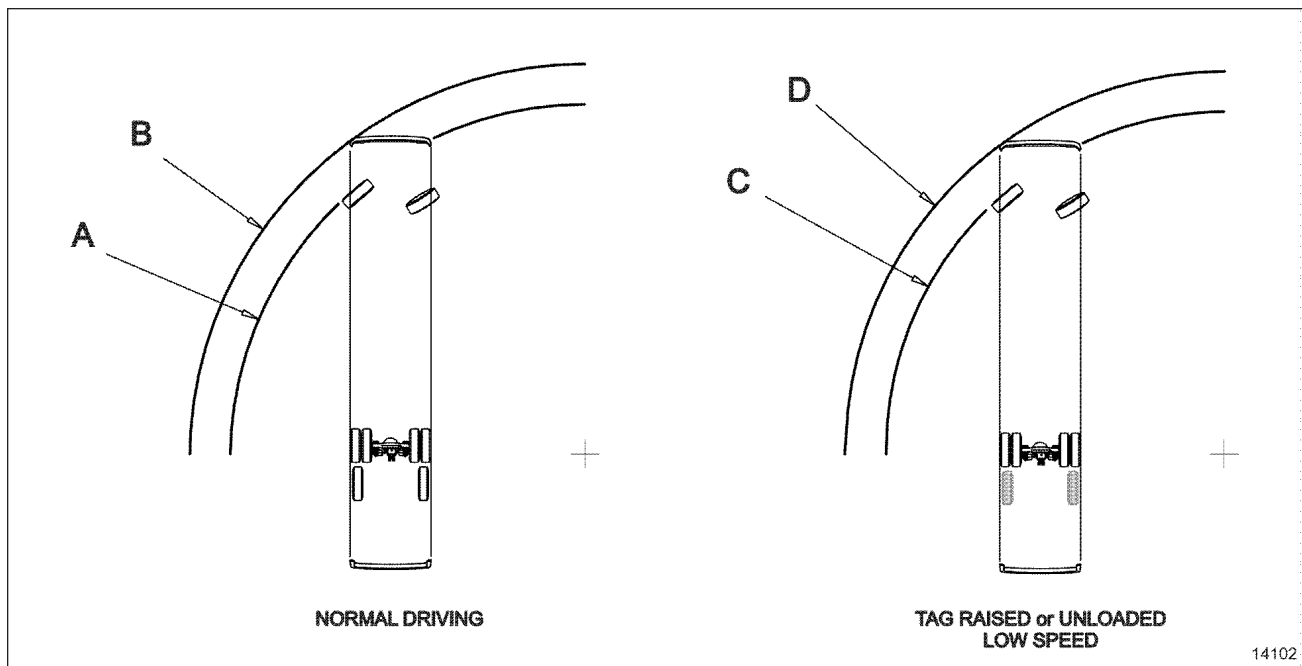

FIGURE 3: TURNING RADIUS DIAGRAM

14102

Table below shows the turning radius values. The values are presented in by model and front axle type. Values A and B are for normal driving. Values C and D show values for low speed maneuvering where the tag axle is raised or unloaded .





CAUTION

Do not drive vehicle with tag axle raised at speeds exceeding 12 mph (20 km/h). For additional details, refer to "[TAG AXLE CONTROL VALVE](#)" on page 15 in Section 4 Controls and Instruments and "[RETRACTABLE TAG AXLE](#)" on page 29 in Section 5 Other Features.

NOTE

Supplied values are theoretical. Factors such as ground surface, vehicle speed and road conditions may significantly affect the turning radius.

Turning Radius 1, 2	H3-45, H3-45 VIP with Front Independent Suspension
A (Curb to Curb)	11.34m (37'3")
B (Wall to Wall)	12.64m (41'6")
C (Curb to Curb) 	10.84m (35'7")
D (Wall to Wall) 	12.13m (39'10")

¹Curb to Curb value corresponds to the outer tire's track on the ground.

²Wall to Wall value includes the vehicle's body overhang.

9-8 Technical Information

FUEL TYPE

Your Prevost vehicle is powered by a diesel engine designed to operate only with Ultra Low Sulfur Diesel (ULSD) fuel, which can contain no more than 15 ppm sulfur.



WARNING

ULSD fuel is necessary to avoid fouling the engine's Exhaust Aftertreatment System. Use of fuel other than ULSD will reduce the efficiency and durability of the engine.

BIODIESEL FUEL

Biodiesel with up to a maximum of 5% biofuel (B5) may be used and will not affect the manufacturer's mechanical warranty as to engine and emissions system related components. The biofuel used in the various blends must conform to ASTM D6751; therefore B1 to B5 blends conforming to ASTM D975. Also, any engine performance problem related to the use of biodiesel fuel would not be recognized nor considered as Volvo or Prevost's responsibility.

However, Volvo engines are certified to comply with U.S. EPA and California emissions standards based upon the use of test fuels with specifications established by these regulatory agencies.

Alternative fuels, including biodiesel, that are not substantially similar to the required test fuels may adversely affect engine emissions compliance. As a result, Volvo does not warrant the engine will conform to applicable Federal or California emissions limits when operated on biodiesel or other alternative fuels that are not substantially similar to specified test fuels used for certification.

Additional maintenance is required and is covered in Section 03: FUEL SYSTEM of the maintenance manual.

WHEELS AND TIRES

WHEELS DIMENSION

Alcoa aluminum wheels (front & tag axles): 10½" X 22½"

Alcoa super single wheels (drive axle): 14" X 22½"

TIRE DIMENSIONS

Front & tag axles: 365/70 R22.5 load range L tires on both axles

Drive axle: 315/80 R22.5 load range L tires

Drive axle: super single 455/55 R22.5 load range L tire

RECOMMENDED TIRE INFLATION PRESSURE AT MAXIMUM COLD LOAD

The recommended tire inflation pressures are given in the applicable documents supplied with the vehicle. In addition, cold tire inflation pressures are listed on the Department of Transport (DOT) certification plate, affixed on the wall behind the driver's seat.

For special tire selection, a "Prevost coach special specification" chart is supplied with the vehicle and is affixed next to the DOT certification plate.

Vehicles equipped with TPMS: The TPMS target pressures are factory set to equal the prevailing tire pressure at delivery time. When tire pressures are increased to account for higher vehicle weight, the TPMS set point needs to be increased accordingly.

NOTE

Before being converted, Bus Shells vehicles are not at their maximum weight and tire pressures are adjusted at a lower level value than the maximum allowed appearing on the DOT plate. Tire pressure must be readjusted once converted.



CAUTION

These tire pressures are established in accordance with the maximum allowable load on each axle. A lower pressure is recommended if the axle load is less than the above specifications. Weigh vehicle fully loaded and pressurize according to tire manufacturer's recommendations. For non-standard tire and wheel specifications, see Prevost tire pressure tabulation in "Coach Final Record" or special specification chart affixed next to the DOT certification plate.



WARNING

Special tire selection may lower maximum allowable speed limit, even below posted speed limit. For maximum safety, check with tire manufacturer.

BELTS

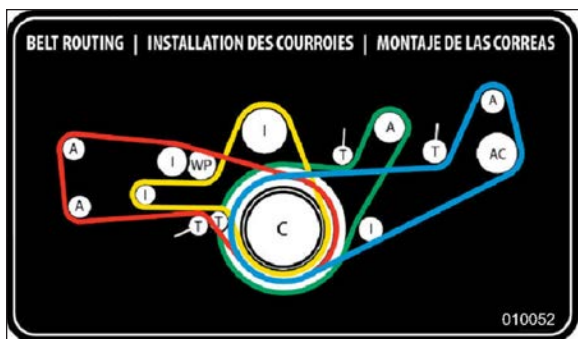
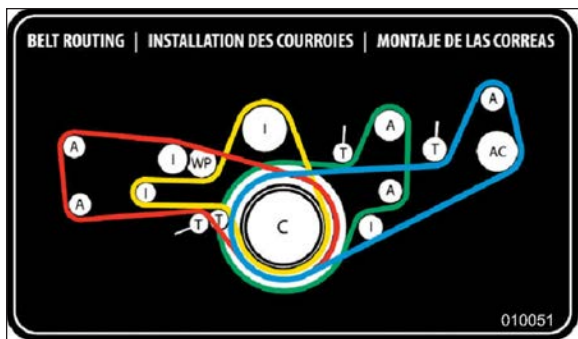
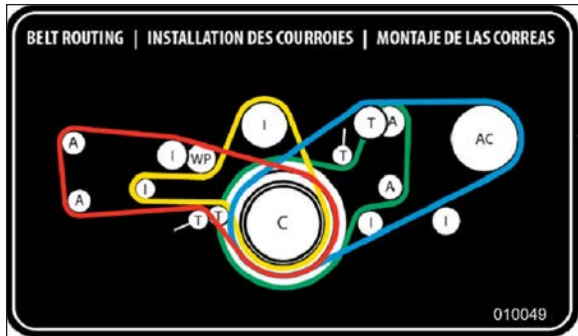

A: Alternator I: Idler T: Tensioner
 C: Crank WP: Water pump AC: A/C compressor

Belt application	Type	Qty
A/C compressor - high capacity HVAC system	V Belt BX71	2

Belt application	Type	Qty
A/C compressor - high capacity HVAC system with four alternators	5VX950	2
A/C compressor - high capacity HVAC system with Volta alternator	5VX940 + 5VX740	1+1
A/C compressor - small HVAC system with Volta alternators	AX-32	2
Alternator - twin Bosch, curb side	Multi-V-8 Rib 8PK1575	1
Alternator - emergency belt on upper alternator, curb side	Multi-V-8 Rib 8PK1512	1
Alternator - twin Bosch, street side	Multi-V-10 Rib 10PK1892	1
Alternator - supplemental Bosch above A/C compressor, curb side	Multi-V-8 Rib 8PK1512	
Alternator - Volta on small HVAC system	5VX950	2
Drive belt from crankshaft pulley to intermediary drive of auxiliary alternator & compressor - small HVAC system:	Multi-V-8 Rib 8PK1840	2
Coolant pump	Multi-V-10 Rib 10PK1512	1

NOTE

Belts specifications and configurations may vary. For proper belt selection, always consult your vehicle "Coach Final Record".

VOLVO D13 ENGINE

Type: 4-stroke / inline six cylinders
Displacement: 12.8 l, SOHC, 4-valve /cylinder
Power: 500 HP
Torque: 1851 lbf·ft (2509 Nm)
Cruise speed range: 1400-1800 rpm
Full dress, dry weight: 2582 lb / 1174 kg

9-10 Technical Information

ALLISON TRANSMISSION

Allison World MH4000 electronically controlled six speed automatic transmission (MH4000R with the optional output retarder).

GEAR RATIOS

1 st	3.51
2 nd	1.91
3 rd	1.43
4 th	1.00
5 th	0.74
6 th	0.64
Reverse:	4.80
Converter:	1.90

PROPELLER SHAFT

Dana Spicer SPL250 type tubular shafts, provided with heavy-duty universal joints.

BRAKES

The features of the braking system include a dual system where the front and rear circuits are completely independent from each other. The brakes are air operated disc type brakes. The emergency/parking brakes are located on the drive axle. To ensure a constant running clearance between pads and disc, the brakes are equipped with a non-wearing, automatic adjuster mechanism.

BRAKE CHAMBER EFFECTIVE AREA

Front axle: 24 in²

Drive axle: 24/24 in² (service /emergency)

Tag axle: 16 in²

AIR SYSTEM

Compressed air is provided by a twin cylinder, 31.8 cfm Wabco, gear-driven, water-cooled and engine oil lubricated air compressor.

ANTILOCK BRAKING SYSTEM (ABS)

The antilock braking system has one Electronic Control Unit (ECU) controlling a 6- sensor/5- modulator (6s/5m) system. A wheel slip sensor is mounted at each wheel.

The Electronic Control Module (ECM) is maintenance free. Its operating voltage is 24 ± 6 volts DC. The thermal operating range for the ECM is from -40 to 167°F (-40 to 75°C).

The solenoid control valves are maintenance free. Their operating voltage is 24 (+4.8, -2.4) volts DC. The rated current draw is 1.65 amps. The thermal operating range of the solenoid control valves is from -40 to 176°F (-40 to 80°C).

TROUBLESHOOTING AND TESTING

For detailed information, troubleshooting and testing refer to Bendix booklet "Bendix Service Data EC80 ESP Controller (SD-13-4986)" found on the Technical Publications USB flash drive and web site or use menu "Diagnostics" of the DID (see ["DRIVER INFORMATION DISPLAY \(DID\) MENUS "](#) on page 11 in Section 5 Other Features).

AUTOMATIC TRACTION CONTROL (ATC) – ELECTRONIC STABILITY CONTROL (ESC)

In addition to the ABS function, vehicle is equipped with a Traction Control System (TCS) feature. This feature is provided by the Bendix ESP EC-80 controller. Bendix refers to this feature as Automatic Traction Control (ATC). Bendix ATC can improve vehicle traction during acceleration, and lateral stability while accelerating through curves. ATC utilizes Engine Torque Limiting (ETL) where the ECU communicates with the engine's controller and/or Differential Braking (DB) where individual wheel brake applications are used to improve vehicle traction.

The ESP EC-80 model controller also provides an ABS-based Electronic Stability Control (ESC) feature. Bendix refers to it as ESC Electronic Stability Control.

The Bendix ESC system is an ABS-based stability system that enhances vehicle stability by

both reducing engine throttle and by applying vehicle braking based on actual vehicle dynamics

Refer to Maintenance Manual, Section 12: Brake and Air System for more information on this system.



CAUTION

Even with ESC-equipped vehicles, the driver remains responsible for ensuring vehicle stability during operation.



DANGER

ESC may reduce the vehicle speed automatically.

ESC can make the vehicle decelerate automatically. ESC can slow the vehicle with or without the operator applying the brake, and even when the throttle is being applied

STEERING

ZF 8098 integral hydraulic assisted steering gear

- Hydraulic pump gear driven from engine .
- ZF Servocomtronic variable ratio and variable assistance in function of vehicle speed available.
- Hydraulic reservoir and dipstick accessible from engine compartment.
- System pressure: 2320 psi (160 bars).
- Steering wheel diameter 18". Tilt steering wheel and telescopic steering column; pneumatically locked with foot-operated switch for adjustment.
- Number of turns: 5¾.
- Outside turning radius: see Dimensions and Weight table.

ELECTRICAL SYSTEM

- 24-volt, negative ground;
- 12-volt exterior lighting;
- Various arrangements of 24V- 150A and 12V-200A , self-regulated, belt-driven, air-cooled Bosch alternators;

- Four 12 Volts, group 31 AGM type batteries connected in series/parallel. Each one has a reserve capacity of 200 minutes and a cold cranking capacity of 800 amps.
- 100 amp battery equalizer.

AXLES

FRONT AXLE - INDEPENDENT FRONT SUSPENSION (IFS)

- Prevost independent front suspension with calibrated air springs for improved comfort
- 19 000 lbs capacity (loading limit could be less depending on the wheel and tire selection)
- Wide apart double V -arm design mounted on ball joints with torque link
- Double sealed taper roller bearings bell crank and idler steering arm
- Unitized wheel bearing (maintenance-free bearing)
- Factory pre-adjusted caster

DRIVE AXLE

- Meritor model RC23-165 full banjo type dual tire drive
- Meritor RC23-165 with Allison transmission ratio: 3.91 (standard), 3.58 & 4.10 (optional)
- Oil lubricated wheel bearings on Meritor RC23-165
- Factory pre-adjusted caster

TAG AXLE

- Prevost hollow square beam
- FAG Unitized wheel bearings (maintenance free)
- Tag axle may be lifted to provide better traction in snow, mud and reduce the turning radius and tire scrub at low cornering speed

SUSPENSION

Goodyear rolling lobe type air springs (bellows) are used throughout.

9-12 Technical Information

INDEPENDENT FRONT SUSPENSION

- 2 Bellows (14") for a GAWR of 19 000 lbs;
- 2 Shock absorbers;
- 2 Upper V-arms;
- 2 Lower V-arms;
- 2 Torque rods;
- 2 Steering Levers;
- 1 Height control valve;
- 1 ³/₄ sway bar;

DRIVE AXLE

- 4 Bellows;
- 4 Shock absorbers;
- 3 Radius rods;
- 1 Panhard rod;
- 2 Height control valves;
- 1 Anti-roll bar;

TAG AXLE

- 2 Bellows;
- 2 Shock absorbers;
- 3 Radius rods;
- 1 Panhard rod;

ALIGNMENT SPECIFICATIONS

Use static wheel alignment systems which work with angle measurements only, such as Josam or Hunter systems. Static alignment specifications are listed in the following tables:

DRIVE AXLE - MERITOR			
	Minimum value	Nominal value	Maximum value
Thrust angle	±0.11°		
Total toe	0.18° toe-in	0°	0.18° toe-out

TAG AXLE			
	Minimum value	Nominal value	Maximum value
Thrust angle*	-0.02°	0	0.02°
Total toe	0.08° toe-in	0°	0.02° toe-out
(*) Use the drive axle as reference			

INDEPENDENT FRONT SUSPENSION CONVERTED VEHICLE			
	Minimum value	Nominal value	Maximum value
Right camber	-0.20°	0.0°	0.20°
Left camber	-0.20°	0.0°	0.20°
Right caster	2.55°	2.8°	3.05°
Left caster	2.55°	2.8°	3.05°
Total toe	0.04°	0.06°	0.08°

INDEPENDENT FRONT SUSPENSION NON-CONVERTED VEHICLE			
	Minimum value	Nominal value	Maximum value
Right camber	0.20°	0.30°	0.50°
Left camber	0.20°	0.30°	0.50°
Right caster	2.55°	2.8°	3.05°
Left caster	2.55°	2.8°	3.05°
Total toe	0.02°	0.04°	0.06°

COOLING SYSTEM

- Extra capacity, Aluminum radiator and aluminum charge air cooler arranged side by side.
- Eight 24V speed controlled by ECU electrical cooling fans.
- Radiator fans: pusher type, 6 high power 24 Volts electrical fans, 12 inches diameter.
- CAC fans: pusher type, 2 high power 24 Volts electrical fans, 12 inches diameter.
- Rubber insulated from the body.
- Expansion & recovery tanks above radiator and remote mounted.
- System pressure 15 psi.
- Coolant: -Volvo engine: ELC (Extended life coolant), color red, with No-SCA filter.
- Thermostat: 82 / 92 °C (180 / 198 °F) – (cracking / fully open).
- Full system capacity 27.5 US gal (104 l).
- Coolant filter without Supplemental Coolant Additive (SCA).

FUEL SYSTEM

- Anti-spill device.
- Two safety filler caps providing filling access on both sides of the vehicle.
- Pressure relief valve.
- Electric fuel gauge.
- Low level signal at 26 US gallons (98.4 liters).
- Primary filter 25 microns (standard).
- Primary fuel filter with electrical water indicator (Volvo D13).
- Fuel Pro 382 filter available as an optional primary filter.
- Secondary filter 3 to 5 microns.
- Shut-off valve on fuel supply line.

EXHAUST SYSTEM

One all stainless steel exhaust & aftertreatment system including:

- Catalytic converter to reduce NOx.
- Aftertreatment system made of a DPF (Diesel Particulate Filter), DOC (Diesel Oxidation Catalyst) and SCR system. Noise & vibration damped, this ATD is mounted to the vehicle structure and is accessible through an exterior access door.
- Tail pipe diffuser and rain deviation device.
- Exhaust pipe with flexible section.
- Exhaust to rear rooftop left hand corner.
- Diesel exhaust fluid (DEF) tank (60 liters) and injection system.

HEATING AND AIR CONDITIONING

Two air conditioning systems are available: the large capacity (central HVAC system) or the small capacity A/C (small HVAC system). Vehicles equipped with the large capacity HVAC system benefit from a combination heating and cooling system that provides adequate capacity of conditioned and filtered air for all climatic conditions. Fresh air is drawn into the system from the left (driver's) side of the vehicle. Return air is taken from the middle of the vehicle. The driver's heater and defogger are controlled separately from the central unit. An air mixture selector enables air to be drawn into the system from outside the vehicle or recirculated. Driver's air provides cooling for the driver's area only, maximizing available baggage space for other uses. The small capacity HVAC system enables cooling the driver's area only.

CENTRAL HVAC SYSTEM	
Air conditioning capacity	9 tons
Refrigerant type	134A
Heating capacity	150 000 Btu/h
Air flow	2 600 cfm (73,6 m ³ /min)

SMALL HVAC SYSTEM	
Air conditioning capacity	2 tons
Refrigerant type	134A
Air flow	450 cfm (12,7 m ³ /min)

9-14 Technical Information

SMALL HVAC SYSTEM

Refrigerant nominal charge	6 lbs
----------------------------	-------

COMPRESSOR (central HVAC system)

Number of cylinders	4
Operating speed	500 to 3500 rpm
Oil capacity	2.8 US quarts (2.6 liters)
Approved oil	Bitzer BSE55 (POE)

COMPRESSOR (small HVAC system)

Number of cylinders	7
Operating speed	700 to 6000 rpm
Oil capacity	6 US oz (0.18 liters)
Approved oil	SP-20 (PAG)

NOTE

The above oils are suitable for use with reciprocating compressors using refrigerant R134a and with evaporator temperatures above 40°F (-40°C).

OIL SPECIFICATIONS

Oil specifications for the vehicle's systems.

ENGINE

Volvo D13M

We recommend using SAE 10W-30 "Volvo Premium Motor Oil VDS-4.5" or other Volvo approved VDS-4.5 oils.

Volvo VDS-4.5 oils exceed API service category CK-4 oils.

Volvo D13N (OBD20)

Recommended: SAE Viscosity Grade 5W-30 meeting Volvo specification VDS-5 or API FA-4.

Minimum requirement: Volvo specification VDS-4.5 or API CK-4 oils

ALLISON TRANSMISSION

Allison Transmission recommends the following fluids:

- Castrol TranSynd™ or TES668 or TES-295 specification equivalent fluid;
- TES-389 specification equivalent fluid.

DIFFERENTIAL

Multigrade gear oil meeting MIL-PRF-2105E: 85W-140 is recommended for use in the Meritor drive axle. This lubricant performs well over a broad temperature range, providing good gear and bearing protection in a variety of climates. If temperature drops below 10°F (-12°C), 80W-90 should be used, and below -15°F (-26°C), 75W-90 should be used. In extreme conditions or for better performance, full synthetic gear oil should be used.

POWER STEERING RESERVOIR

Use Automatic Transmission Fluid (ATF) Dexron-III (F, G or H) or Dexron-IV for this system.

PLATES AND CERTIFICATION

The main components of the vehicle such as engine, transmission, axles and chassis are identified by different serial numbers. It may be necessary to locate these numbers for warranty purposes.

The engine data plate is located on the rocker cover. The engine serial and model number and a list of the optional engine equipment are written on this plate. Refer to this information when ordering replacement parts. Also the engine data plate certifies that the engine conforms to federal and any state exhaust emissions regulations.

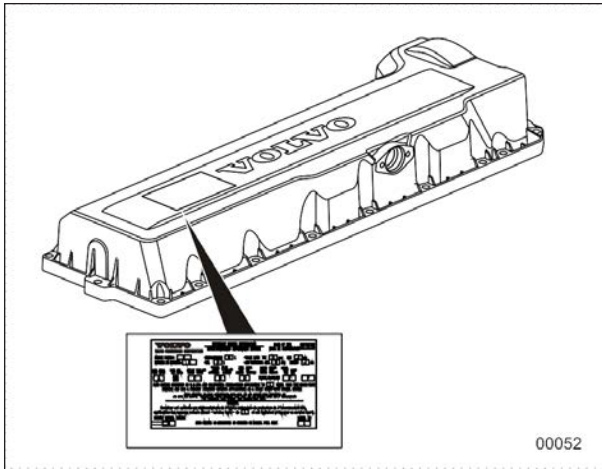

FIGURE 4: VOLVO D13 ENGINE DATA PLATE

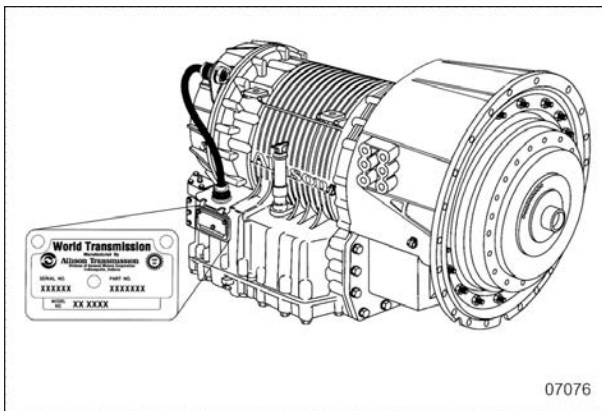

FIGURE 5: ALLISON TRANSMISSION

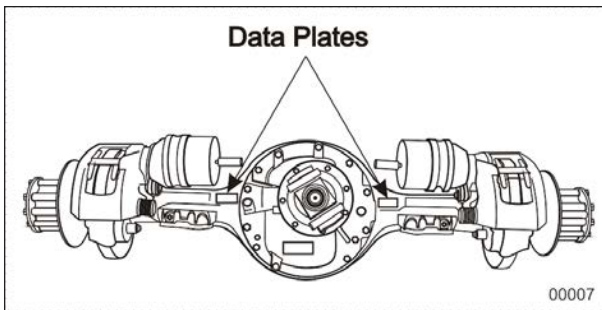

FIGURE 6: MERITOR DRIVE AXLE

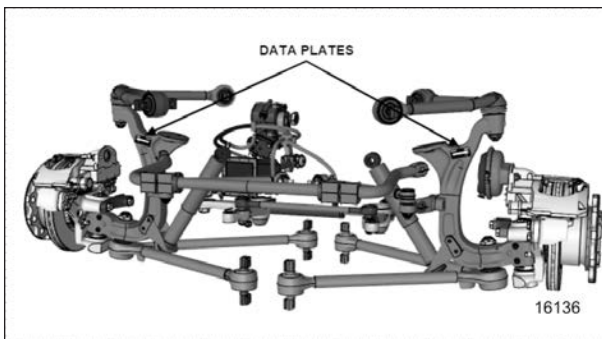

FIGURE 7: INDEPENDENT FRONT SUSPENSION

SAFETY CERTIFICATION

Vehicle components meet specifications and standards as follows:

- Material and parts conform to ASTM and/or SAE standards in effect at the time of manufacture.
- All factory-installed interior materials meet FMVSS 302 for fire resistance.
- Certified according to Provincial, State and Federal Safety standards (Canadian and US) BMCSS, FMVSS and CMVSS.
- Other applicable certification labels are affixed to the component.

DOT CERTIFICATION PLATE

This certifies that vehicles manufactured by Prevost comply with all Federal Motor Vehicle Safety Standards at the time of manufacture. Information such as the date of manufacture, model year, gross vehicle weight rating, tire types and inflation pressure is also etched on this plate.

The DOT certification plate is affixed behind the driver's seat.

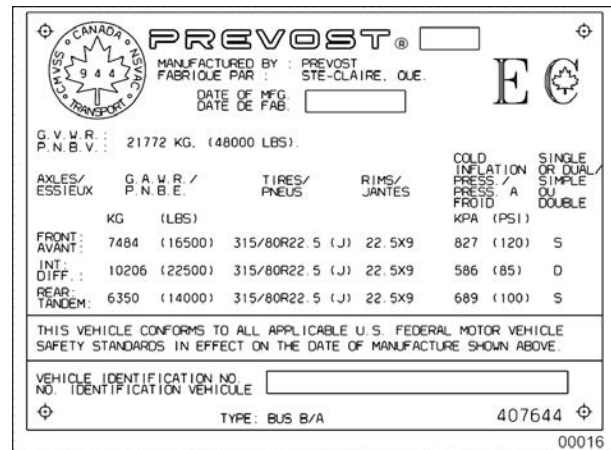

FIGURE 8: DOT CERTIFICATION PLATE

EPA ENGINE LABEL

The emissions certification label affixed in the engine compartment certifies that the engine conforms to federal and any state exhaust emissions regulations.

9-16 Technical Information

PREVOST	VEHICLE EMISSION CONTROL INFORMATION PREVOST, A DIVISION OF VOLVO GROUP CANADA INC.
VEHICLE FAMILY IDENTIFICATION: γ VPT2VOCVF00 VIN: $XXXXXXXXXXXXXXXXXX$ REGULATORY SUB-CATEGORY: Compression-ignition Heavy HDV vocational DATE OF MANUFACTURE: $mm/yyyy$ VEHICLE EMISSION CONTROL SYSTEM: $xxxx$	
THIS VEHICLE COMPLIES WITH CALIFORNIA AND U.S. EPA REGULATIONS FOR $yyyy$ MODEL YEAR VEHICLES.	
010 303 00064	

FIGURE 9: EPA CERTIFICATION LABEL

VEHICLE IDENTIFICATION NUMBER (VIN)

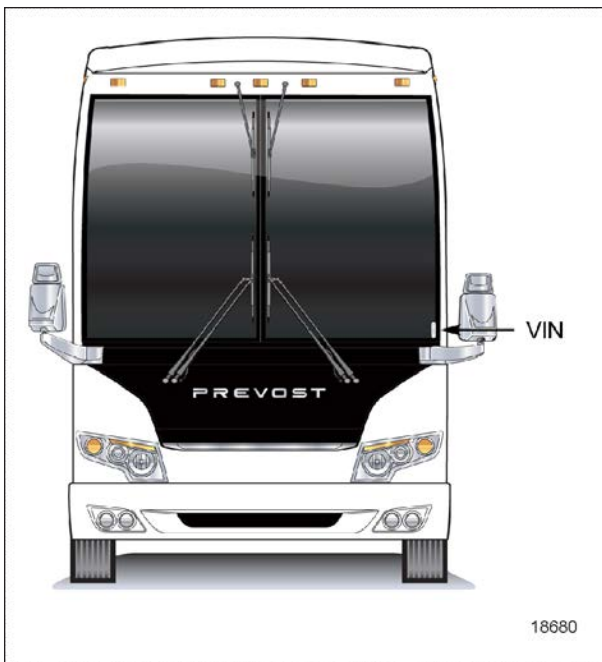

FIGURE 10: VEHICLE IDENTIFICATION NUMBER (H3 SERIES)

The Vehicle Identification Number is stamped on the DOT certification plate and also on a plate located on the windshield frame pillar (driver's side). The VIN is visible from the outside of the vehicle. Make sure the correct vehicle identification number is given when ordering replacement parts. Using the VIN when ordering parts will facilitate processing.

NOTE

Record the VIN in the vehicle documentation and keep with company records. The VIN will normally be used for vehicle registration, service reference needs and for obtaining vehicle insurance coverage.

VIN DEFINITION

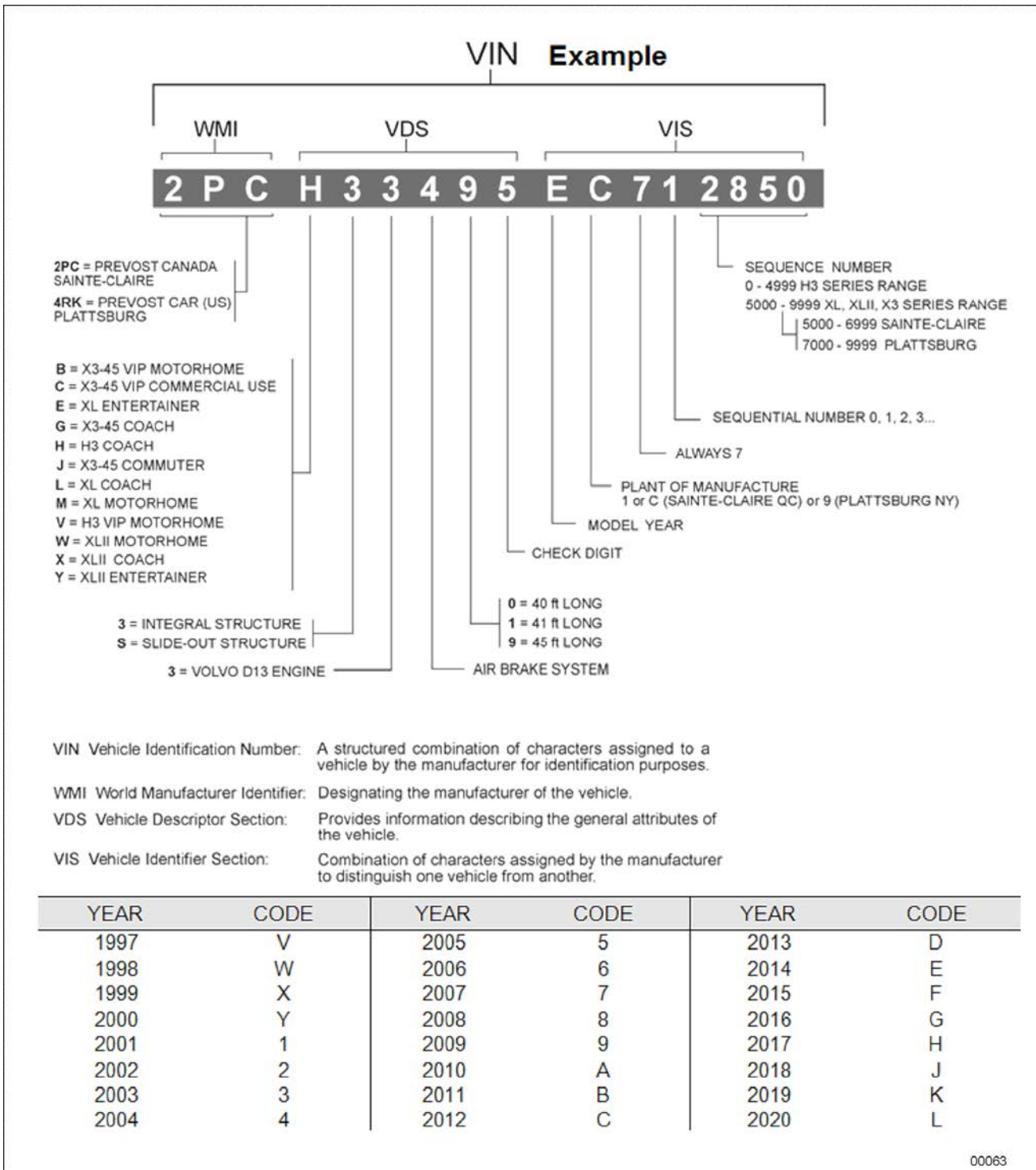

COACH FINAL RECORD

The Coach Final Record is a record of all data pertaining to the assembly of the vehicle. This record is shipped to the new customer via a courier company. Retain this record in the company records office for reference and safe-keeping.

ABBREVIATIONS

ABS	Antilock Brake System
A/C	Air Conditioning
ACB	Adaptive Cruise With Braking
ACM	Aftertreatment Control Module
AFSS	Automatic Fire Suppression System
APC	Automatic Passenger Counter
ATC	Automatic Traction Control (Bendix)
CECM	Chassis Electronic Control Module
DCDL	Driver Controlled Differential Lock
DDR	Diagnostic Data Reader
DEF	Diesel Exhaust Fluid
DID	Driver Information Display
D-MIC	Driver Microphone
DPF	Diesel Particulate Filter
DTC	Diagnostic Troubleshooting Code
ECM	Electronic Control Module
ECU	Electronic Control Unit
EECU	Engine Electronic Control Unit
EGR	Exhaust Gas Recirculation
ELD	Electronic Logging Device
ESC	Electronic Stability Control
ESC	Escape
ESP	Electronic Stability Program (Bendix)
E+	Eco-Roll
FDA	Following Distance Alert
GAW	Gross Axle Weight
GECU	Gear Selector Electronic Control Unit
G-MIC	Guide Microphone
GVW	Gross Vehicle Weight
HVAC	Heating, Ventilation And Air Conditioning
IA	Impact Alert
IFS	Independent Front Suspension
LED	Light Emitting Diode
LLS	Level Low System
MCM	Master Chassis Module
MPH	Miles Per Hour
PPT	Premium Tech Tool
PRIME	Power Recovery By Intelligent Management Of Energy
PTO	Power Take Off
SCR	Selective Catalytic Reduction
TCM	Transmission Control Module
TCS	Traction Control System
TECU	Transmission Electronic Control Unit
TPMS	Tire Pressure Monitoring System

2 - Abbreviations

TWS	Threshold Warning System
ULSD	Ultra Low Sulfur Diesel
VCADS	Volvo Computer Assisted Diagnostic System
VEB	Volvo Engine Brake
VECF	Vehicle Electrical Center Front
VECR	Vehicle Electrical Center Rear
VECU	Vehicle Electronic Control Unit
VSS	Video And Sound Selector
WCL	Wheelchair Lift

APPENDIX A - SERVICE LITTERATURE

SERVICE LITERATURE	2
NOTICE	2
DECLARATION OF THE MANUFACTURING DEFECTS TO THE GOVERNMENT OF THE UNITED STATES	2
DECLARATION OF THE MANUFACTURING DEFECTS TO THE CANADIAN GOVERNMENT	3
DECLARATION OF THE MANUFACTURING DEFECTS TO PREVOST	3

A-2 Service Literature

SERVICE LITERATURE

Visit our web site at www.prevostcar.com for on-line product information and technical publications!

Additional copies of the following service literature are available on request and at low cost. These can be helpful to mechanics and drivers alike.

- Maintenance Manual
- Owner's Manual
- Parts Manual
- Service Center Directory

To order, call Prevost Parts toll free 1-800-463-8876 or write to:

PREVOST PARTS

2955-A Watt Street
Sainte-Foy, (Quebec)
Canada G1X 3W1

prevostparts.commandes@volvo.com (Canada)

function.prevostparts.orders@volvo.com (USA)

Specify the complete vehicle serial number (VIN). Allow 30 days for delivery

NOTICE

DECLARATION OF THE MANUFACTURING DEFECTS TO THE GOVERNMENT OF THE UNITED STATES

If you believe that your vehicle has defect which could cause a crash or could cause injury or death, you should immediately inform the National Highway Traffic Safety Administration (NHTSA) in addition to notifying Prevost.

If NHTSA receives similar complaints, it may open an investigation, and if it finds that a safety defect exists in a group of vehicles, it may order a recall and remedy campaign.

However, NHTSA cannot become involved in individual problems between you, your dealer, or Prevost.

To contact NHTSA you may either call the Auto Safety Hotline toll-free at 1-800-424-9393 (or 366-0123 in Washington, D.C. area) or write to:

NHTSA

U.S. Department of Transportation
Washington, D.C. 20590

You can also obtain other information about motor vehicle safety from the Hotline.

DECLARATION OF THE MANUFACTURING DEFECTS TO THE CANADIAN GOVERNMENT

If you live in Canada, and if you believe that your vehicle has a safety defect, you should immediately inform Transport Canada and Prevest. You may write to:

**Transport Canada
Box 8880
Ottawa, Ontario, K1G 3J2**

DECLARATION OF THE MANUFACTURING DEFECTS TO PREVOST

In addition to NHTSA (or Transport Canada) notification, please contact Prevest at 1-418-831-2046. Or write to:

**Prevest
After-sales service department
850 ch. Olivier,
Lévis (Quebec)
Canada, G7A 2N1**

APPENDIX B - MULTIPLEX TROUBLESHOOTING

MULTIPLEX TROUBLESHOOTING GUIDE 2

B-2 Multiplex Troubleshooting

MULTIPLEX TROUBLESHOOTING GUIDE

Problem / Symptom	Probable Causes	Actions
Vehicle does not Start from the dashboard	<p>The Engine Stop pushbutton located on the rear start panel is depressed</p> <p>Main electrical shut- off switch is in the OFF position</p>	<ol style="list-style-type: none"> 1. Twist and pull the Engine Stop pushbutton to place it in normal operating position, check that the main electrical shut-off switch is in the ON position and retry cranking from the ignition switch 2. Start the vehicle from the engine compartment using the rear start button
Vehicle does not Start from the dashboard <i>and</i> from the rear	<p>DL0 (BBUS MUX) network problem (Multiplex)</p> <p>Module AE52 not powered or is defective</p> <p>Engine ECM does not receive the ignition signal</p> <p>Engine ECM is not powered</p>	<ol style="list-style-type: none"> 1. Verify that module AE52 is powered: <ol style="list-style-type: none"> a. Check the DIAGNOSTICS menu of Driver Information Display (DID). Select VIEW ACTIVE FAULTS and ELECTRICAL. The message “No Response ModA52, Active”, indicates a power problem on the module or a DL0 (BBUS MUX) network problem. b. Check / reset circuit breaker CB5 c. Check / replace fuse F65 d. Probe gray connector on module to see if it is powered. 2. Verify that the engine ECM is powered and gets the ignition signal <ol style="list-style-type: none"> a. Check / reset circuit breaker CB8 Check / replace fuse F74 b. Check / reset circuit breaker CB2 Check / replace fuse F78

Problem / Symptom	Probable Causes	Actions
<p>None of the Multiplexed functions are operating, including the basic limp-home functions (door opening, flashers, wipers in speed 1)</p> <p>“FLIP REAR BREAKER TO INITIATE I/O MODULES PROGRAMMING” pop-up message appears in the DID</p> <p>Note: The sunshades are still functioning since these are not multiplexed</p>	<p>The program version in the MCM is different than the program in the I/O modules and the MCM is forcing all I/O modules to stay inactive</p>	<ol style="list-style-type: none"> Engage the auto-programming of the I/O modules: Turn the ignition key to the ON position, trip and reset circuit breaker CB6. The DID indicates "MUX AUTOPROGRAMMING I/O MODULE PLEASE WAIT" until the reprogramming is complete.
<p>Many of the non-essential secondary functions are not functioning (interior lighting, driver's area lighting, wiper speed 2 and intermittent).</p> <p>Marker lights and clearance lights are turned ON when setting ignition to the ON position.</p>	<p>The MCM module does not receive 24 V power.</p> <p>The DL0 (BBUS MUX) network is not working. It could be caused by a short on the network, an open circuit, a problem with the MCM or the MCM being disconnected from the network.</p>	<ol style="list-style-type: none"> Check / reset circuit breaker CB6. Check / replace fuse F1 Operate in limp-home mode by starting the vehicle from the engine compartment (REAR START). All functions essential to drive are available <p>To close and lock the door, pull the door manually up to its closed position and it will lock by itself. The door opening button is still functioning</p>
<p>No temperature control in the passenger area</p> <p>Passenger temperature display indicates two dashes "--"</p>	<p>Problem with the temperature sensor located in the evaporator compartment air intake or the sensor wiring</p>	<p>Instruct the driver to manually control the temperature by playing with the passenger set point. Set above 22°C (72°F) to heat and below 22° C (72°F) to cool</p>

B-4 Multiplex Troubleshooting

Problem / Symptom	Probable Causes	Actions
<p>Entrance door does not open nor close using the control buttons</p> <p>Defroster fan not functioning</p> <p>Windshield wipers not functioning in speed 1 or intermittent</p>	<p>Module AE47 is not powered or is faulty</p>	<ol style="list-style-type: none"> 1. Check the DIAGNOSTICS menu of Driver Information Display (DID). Select VIEW ACTIVE FAULTS and ELECTRICAL. The message “No Response ModA47, Active” indicates a power problem on the module. (A DL0 (BBUS MUX) network problem would show the same message but doesn't produce these symptoms). 2. Check / reset circuit breaker CB1 3. Check / replace fuse F45 4. Probe gray connector on module to see if it is powered. 5. Use the air release valves near the entrance door and in the front service compartment to lock / unlock the door
<p>Windshield wipers not functioning in speed 1 or intermittent</p>	<p>No power on R27</p>	<p>Check CB48 (VECF)</p>
<p>HVAC condenser fans not functioning in speed 1</p>	<p>Circuit breaker CB7 tripped</p>	<p>Check / reset circuit breaker CB7</p>
<p>HVAC condenser fans not functioning in speed 2</p>	<p>Circuit breaker CB7 tripped</p>	<p>Check / reset circuit breaker CB7</p> <p>Check / replace fuse F135</p>
<p>Windshield washer not functioning</p> <p>Windshield upper section de-icing system not functioning</p>	<p>Module AE44 is not powered or is faulty</p>	<ol style="list-style-type: none"> 1. Check the DIAGNOSTICS menu of Driver Information Display (DID). Select VIEW ACTIVE FAULTS and ELECTRICAL. The message “No Response ModA44, Active” indicates a power problem on the module. (A DL0 (BBUS MUX) network problem would show the same message but doesn't produce these symptoms). 2. Check / reset circuit breaker CB1 3. Check / replace fuse F44 4. Probe gray connector on module to see if it is powered.

Multiplex Troubleshooting B-5

Problem / Symptom	Probable Causes	Actions
Defroster fan is functioning but no heat or cooling available in the driver area.	Module AE47 is not powered or is faulty	<ol style="list-style-type: none"> 1. Check the DIAGNOSTICS menu of Driver Information Display (DID). Select VIEW ACTIVE FAULTS and ELECTRICAL. The message “No Response ModA47, Active” indicates a power problem on the module. (A DLO (BBUS MUX) network problem would show the same message but doesn't produce these symptoms). 2. Check / reset circuit breaker CB1 3. Check / replace fuse F45 4. Probe gray connector on module to see if it is powered.
<p>Low beam headlamps and front flasher on left side not functioning</p> <p>Electric horn not functioning</p>	Module AE46 is not powered or is faulty	<ol style="list-style-type: none"> 1. Check the DIAGNOSTICS menu of Driver Information Display (DID). Select VIEW ACTIVE FAULTS and ELECTRICAL. The message “No Response ModA46, Active” indicates a power problem on the module. (A DLO (BBUS MUX) network problem would show the same message but doesn't produce these symptoms). 2. Check / reset circuit breaker CB10 3. Check / replace fuse F19 4. Probe gray connector on module to see if it is powered.
Low beam headlamps and flasher on right side not functioning	Module AE48 is not powered or is faulty	<ol style="list-style-type: none"> 1. Check the DIAGNOSTICS menu of Driver Information Display (DID). Select VIEW ACTIVE FAULTS and ELECTRICAL. The message “No Response ModA48, Active” indicates a power problem on the module. (A DLO (BBUS MUX) network problem would show the same message but doesn't produce these symptoms). 2. Check / reset circuit breaker CB10 3. Check / replace fuse F21 4. Probe gray connector on module to see if it is powered.

B-6 Multiplex Troubleshooting

Problem / Symptom	Probable Causes	Actions
<p>Rear flashers not functioning</p> <p>Stoplights and center stoplights not functioning</p>	<p>Module AE51 is not powered or is faulty</p>	<ol style="list-style-type: none"> 1. Check the DIAGNOSTICS menu of Driver Information Display (DID). Select VIEW ACTIVE FAULTS and ELECTRICAL. The message “No Response ModA51, Active” indicates a power problem on the module. (A DL0 (BBUS MUX) network problem would show the same message but doesn't produce this symptom). 2. Check / reset circuit breaker CB8 3. Check / replace fuse F107 4. Probe gray connector on module to see if it is powered.
<p>Engine is overheating and radiator fans do not engage</p>	<p>Module AE52 or AE49 is not powered or is faulty</p>	<ol style="list-style-type: none"> 1. Check the DIAGNOSTICS menu of Driver Information Display (DID). Select VIEW ACTIVE FAULTS and ELECTRICAL. The message “No Response ModA52/ ModA49, Active” indicates a power problem on the module. (A DL0 (BBUS MUX) network problem would show the same message but doesn't produce this symptom). 2. Check circuit breaker CB5 3. Check / replace fuse F133, F134 4. CB201-CB208
<p>The A/C compressor clutch does not engage</p>	<p>Module AE54 (or AE52) is not powered or is faulty</p>	<ol style="list-style-type: none"> 1. Check the DIAGNOSTICS menu of Driver Information Display (DID). Select VIEW ACTIVE FAULTS and ELECTRICAL. The message “No Response ModA54, Active” indicates a power problem on the module. (A DL0 (BBUS MUX) network problem would show the same message but doesn't produce this symptom). 2. Check / reset circuit breaker CB5 3. Check / replace fuse F135 4. Probe gray connector on module to see if it is powered.

Multiplex Troubleshooting B-7

Problem / Symptom	Probable Causes	Actions
Evaporator fan not functioning	<p>Circuit breaker CB3 tripped</p> <p>Module AE54 is not powered or is faulty</p>	<ol style="list-style-type: none"> 1. Check circuit breaker CB3 2. Check relay R12 3. Check the DIAGNOSTICS menu of Driver Information Display (DID). Select VIEW ACTIVE FAULTS and ELECTRICAL. The message "No Response ModA54, Active" indicates a power problem on the module. (A DLO (BBUS MUX) network problem would show the same message but doesn't produce this symptom). 4. Check / reset circuit breaker CB5 5. Check / replace fuse F135 6. Probe gray connector on module to see if it is powered.
HVAC condenser fans not functioning in speed 1	Module AE54 is not powered or is faulty	<ol style="list-style-type: none"> 1. Check the DIAGNOSTICS menu of Driver Information Display (DID). Select VIEW ACTIVE FAULTS and ELECTRICAL. The message "No Response ModA54, Active" indicates a power problem on the module. (A DLO (BBUS MUX) network problem would show the same message but doesn't produce this symptom). 2. Check / reset circuit breaker CB5 3. Check / replace fuse F135 4. Check / replace fuse F141-F144 5. Probe gray connector on module to see if it is powered.
Sound system not functioning	Circuit breaker CB11 tripped	<ol style="list-style-type: none"> 1. Check CB11 2. Check / replace fuse F148, F200
Fire alarm telltale light and audible alarm always ON and there is no fire or high temperature in the engine compartment	Short-circuited fire sensor or defective sensor	Prior to start the vehicle, cycle the ignition key to the ON position, OFF position and then ON position again and then start the vehicle. This will deactivate the fire alarm function. This has to be repeated each time the vehicle is restarted.

B-8 Multiplex Troubleshooting

Problem / Symptom	Probable Causes	Actions
The vehicle is parked and the electrical horn is activated to indicate a fire in the engine compartment but there is no fire	Short-circuited fire sensor or defective sensor	Cycle the ignition key between the ON and OFF position twice within 3 seconds. This will deactivate the fire alarm function. This has to be repeated each time the vehicle is parked
A single light, a group of LED lights or another function of the vehicle is not functioning	The multiplex outputs are protected in current by an internal "soft fuse". When an output is shorted, it turns OFF and stays OFF until the "soft fuse" is reset	turn the ignition key to the OFF position and turn to the ON position again. This resets all "soft fuses"
No backlighting in the instrument cluster	Circuit breaker CB10 is tripped or fuse F10/F29 blown	<p>Check circuit breaker CB2, CB10</p> <p>Check / replace fuse F10, F29</p> <p>Check / replace relay R22, R23</p>
The radiator/CAC electric fans do not function and the engine is overheating		<p>You can manually engage the radiator/CAC fans half-speed (50%) or full speed (100%).</p> <ol style="list-style-type: none"> 1. On the Driver Information Display, select DIAGNOSTICS menu. Select VEHICLE TESTS submenu and then FORCE RADIATOR FAN SPEED 50% or FORCE RADIATOR FAN SPEED 100%. 2. The DID status line will show TEST to confirm the forced activation of the radiator fans. To cancel, turn the ignition switch to the OFF position or press ESCAPE button, select TERMINATE TESTS & FORCED STATES submenu and then press ENTER button twice. TEST will disappear from the DID status line.

APPENDIX C - ALLISON TRANSMISSION OTHER FEATURES

OIL LEVEL CHECK USING THE PUSHBUTTON SHIFT SELECTOR	2
CONTROL SYSTEM PROGNOSTICS	2
NORMAL PROGNOSTICS INDICATION AT ENGINE START	3
OIL LIFE MONITOR	3
FILTER LIFE MONITOR	4
TRANSMISSION HEALTH MONITOR	5
DIAGNOSTIC TROUBLESHOOTING CODES (DTC) — ALLISON 5TH GENERATION CONTROLS	7
DIAGNOSTIC TROUBLESHOOTING CODES (DTC) OVERVIEW	7
USING SHIFT SELECTOR FOR ACCESSING DIAGNOSTIC INFORMATION	7
DIAGNOSTIC CODE DISPLAY AND CLEARING PROCEDURE	8
EXITING DIAGNOSTIC MODE	8
DIAGNOSTIC TROUBLE CODE RESPONSE	9
DIAGNOSTIC TROUBLESHOOTING CODES (DTC) LIST - ALLISON 5TH GENERATION CONTROLS	10

C-2 Allison Transmission Other Features

OIL LEVEL CHECK USING THE PUSHBUTTON SHIFT SELECTOR

The oil level sensor (OLS) is standard in your transmission. With the OLS and Allison 5th generation shift selector, you can get a more accurate electronic fluid level check than with a dipstick.

Oil level codes are obtained as follows:

1. Park vehicle on a level surface, select «N» (neutral) on the pushbutton shift selector and apply parking brake.
2. Wait for at least 2 minutes to allow the oil to settle;
3. Press simultaneously the ▲ (Upshift) and ▼ (Downshift) arrow buttons once.
4. Oil level codes are displayed once the following parameters are met:
 - The vehicle has been stationary for approximately 2 minutes to allow the oil to settle;
 - Engine at idle;
 - Oil at normal operating temperature, between 104°F (40°C) and 220°F (104°C);
 - Transmission in «N» (Neutral);
 - Transmission output shaft stopped;
 - Oil level sensor present and working.

5. *Correct fluid level* is displayed as shown.



TRANS OIL
LEVEL OK

6. *Low fluid level* is displayed as shown. The number indicates the number of quarts of fluid the transmission requires.



OIL LOW
2 QTS

7. *High fluid level* condition with the number of quarts in excess is displayed as shown.



OIL LEVEL
3QT HI

NOTE

Confirm a low fluid level condition by making a manual fluid level check.

8. To exit the Oil Level Display Mode, press any range button «R», «N» or «D» at any time.

NOTE

Note that the quantities LO 4 and HI 3 are the largest values displayed and that the actual variation in oil level may exceed these numbers.

If the fluid level check cannot be completed, an Invalid for Display fault is reported. Refer to table below to review the codes and conditions.

CODE	CAUSE OF FAULT CODE
SETTLING OK	Settling time too short
ENG RPM TOO LOW	Engine speed (rpm) too low
ENG RPM TOO HIGH	Engine speed (rpm) too high
MUST BE IN NEU	N (Neutral) must be selected
OIL TEMP TOO LOW	Sump fluid temperature too low
OIL TEMP TOO HIGH	Sump fluid temperature too high
VEH SPD TOO HI	Output shaft speed
SENSOR FAILED	Sensor failure

CONTROL SYSTEM PROGNOSTICS

The transmission control system includes the provision for the user to monitor various transmission operating parameters. Transmission operating parameters monitored by the prognostics feature are:

- Oil Life Monitor
- Filter Life Monitor
- Transmission Health Monitor

NOTE

*The prognostics package requires the use of **TranSynd™** or an Allison approved **TES295**, **TES668** or **TES389** licensed fluid in the transmission and **Allison High Capacity filters**.*



*If any other fluids or filters are used, Prognostic mode must be **disabled**.*

Prognostic information will not be accurate with any other fluids or filters and could result in missed maintenance activities resulting in transmission damage.



*Refer to **TES295**, **TES668** or **TES389 Approved Fluids list**, found under the **Service/Fluids** heading on the home page of the Allison Transmission web site.*

www.allisontransmission.com

When a specified threshold is detected for any of the serviceable conditions, the TRANSMISSION SERVICE indicator  is illuminated to alert the operator. Failure to attend to the service condition and reset the TRANSMISSION SERVICE indicator within a defined operating period will result in illumination of the CHECK light with associated message in the DID, indicating the increased probability that the service condition will develop into a more serious condition.

To access the Prognostic Mode functions, simultaneously press the  (Upshift) and  (Downshift) arrow buttons repeatedly. See the at the end of this section.

NORMAL PROGNOSTICS INDICATION AT ENGINE START

- A system bulb check illuminates the TRANSMISSION SERVICE indicator  approximately 0.5 seconds.
- If Prognostics features are enabled, the TRANSMISSION SERVICE indicator  illuminates again for 3 seconds after the bulb check. If Prognostics features are disabled, the TRANSMISSION SERVICE indicator  does not illuminate again after the bulb check.

OIL LIFE MONITOR

The display message denotes the calculated remaining life of the transmission fluid. This value is based on the established life for the required baseline fluid, and then is continuously adjusted for cumulative effects of such operating parameters as operating time, retarder operation, output shaft revolutions and shift frequency.

Display

The display is a two-digit number, denoting percentage of the fluid life which remains. New fluid is displayed as 99%.

The TRANSMISSION SERVICE indicator  will be illuminated, denoting a required change of transmission fluid, when the remaining fluid life reaches approximately 1 %. The indicator will be lit steadily upon each initialization of the TCM, and will remain on steady for approximately 2 minutes after the first selection of "D" (drive) range each time, until service is performed and the indicator is reset.

Failure to perform maintenance and reset the TRANSMISSION SERVICE indicator within a defined period will result in the illumination of the CHECK light with associated message in the DID and diagnostic code P0897 Transmission Fluid Deteriorated.

Reset

The TRANSMISSION SERVICE indicator can be reset by a message over the SAE J1939 communication interface, with the Allison DOC™ for PC diagnostic program, or by depressing and holding the MODE button for ten (10) seconds while the Oil Life Monitor function is displayed. It may also be reset by selecting N-D-N-D-N-R-N on the shift selector, pausing briefly (less than 3 seconds) between each selector movement, with the ignition ON and the engine not running. The TRANSMISSION SERVICE indicator illuminates briefly following a reset to acknowledge the reset was successful.

Setting Fluid Type For Prognostics

The fluid type can be programmed if the specific calibration allows it. The operator can do the following:

With the engine off and the ignition on, perform the following sequence on the selector, N-R-N-D-N-R-N-D-N-R-N-D-N.

C-4 Allison Transmission Other Features

The TRANSMISSION SERVICE indicator flashes if TES389 is the current setting and illuminates solidly if TES295/TES668 is the current setting. To change the transmission fluid type, wait 5 seconds after entering transmission fluid type mode and perform the following sequences to select the proper transmission type:

N-R-N to select TES295/TES668

N-D-N to select TES389

The selector exits 30 seconds after entering transmission fluid type mode or the ignition may be turned off to exit earlier. Only one transmission fluid type selection may be made after entering transmission fluid type mode. All other attempts will be ignored. Transmission fluid type mode needs to be entered again if the wrong type of fluid is selected.



CAUTION

Verify prognostic fluid type setting matches transmission fluid type. Oil Life Monitor notifications will be inaccurate when mismatched. This could result in transmission damage from running a TES389 fluid too long or cause shortened TES295/TES668 fluid changes to occur.



CAUTION

Required calendar-based oil & filter change intervals (based on months) still apply because Oil Life Monitor function cannot measure time while ignition power is OFF.

If the Oil Life Monitor function has not indicated the need for a fluid change before 60 months have passed when using TES295/TES668 fluid type or before 24 months have passed when using TES389 fluid type, it will be necessary to change the fluid and filters per calendar requirements and reset the system.

FILTER LIFE MONITOR

This feature provides an alert when the transmission's fluid filters need to be replaced. It helps extend filter change intervals to reduce routine maintenance downtime while providing maximum protection for the transmission.

The filter life indicator pressure switch signals the transmission control module when fluid exiting

the main filter drops below a predetermined pressure.

Both the main and lube filters must be changed when the TRANSMISSION SERVICE indicator  shows the main filter should be changed.



Filter Change Notification

The TRANSMISSION SERVICE indicator  will flash for 2 minutes after the first selection of "D" (drive) range. Once the Filter Monitor mode has been accessed via the shift selector, the "OIL FILTER OK" or "REPLACE FILTERS" message is displayed in the selector display window. An acceptable filter life status is displayed as "OIL FILTER OK". An unacceptable filter life status is displayed as "REPLACE FILTERS".

Once the programmed threshold for maximum filter pressure drop has been observed and verified, the diagnostic code P088A Transmission Filter Maintenance Alert will be recorded to indicate that the filter has reached the end of its designed life. At the next initialization of the TCM, the TRANSMISSION SERVICE indicator  will flash for 2 minutes after the first selection of "D" (drive) range. Thereafter, the indicator will illuminate and flash upon each TCM initialization, continuing to flash for 2 minutes after the first selection of a drive range each time, until service is performed and the indicator is reset.

Failure to perform maintenance and reset the monitor after a calibration-defined number of warnings will result in the illumination of the CHECK light with associated message in the DID and diagnostic code P088B will be recorded to indicate a highly deteriorated filter.

Read And Reset Filter Life Monitor From Selector

To enter the filter life monitor, press simultaneously the  (Upshift) and  (Downshift) arrows three times. An acceptable filter life status is displayed as "OIL FILTER OK". An unacceptable filter life status is displayed as "REPLACE FILTERS".

The feature will reset automatically when the main fluid filter has been changed and the pressure drop across the filter no longer exceeds the threshold value. A manual reset can be performed by depressing and holding the MODE button for ten (10) seconds while the Filter Life Monitor function is displayed. It may also be reset by selecting N-R-N-R-N-D-N on the shift selector,

pausing briefly (less than 3 seconds) between each selector movement, with the ignition ON and the engine not running. The TRANSMISSION SERVICE indicator  illuminates briefly following a reset to acknowledge the reset was successful.

TRANSMISSION HEALTH MONITOR

This prognostic feature determines clutch life status of the transmission's clutches and alerts you when clutch maintenance is required. The clutch life status is determined by monitoring changes and the calculated running clearance of the transmission clutches.

Clutch Maintenance Notification

The transmission health monitor feature determines when clutch maintenance is needed. If any of the clutches (except lockup) reaches a remaining life of approximately 10% or if any of the clutch running clearances exceeds a maximum value, then the TRANSMISSION SERVICE indicator is steadily illuminated from just after ignition on until ignition is turned off. Thereafter, the indicator will be lit upon each initialization of the TCM, and will remain on steady during all vehicle operation until service is performed and the indicator is reset. If the transmission health monitor mode has been accessed via the shift selector, a "TRANS HEALTH OK" or "TRANS HEALTH LO" is displayed. An acceptable clutch life status is displayed as "TRANS HEALTH OK". An unacceptable clutch life status is displayed as "TRANS HEALTH LO".

C-6 Allison Transmission Other Features

Read And Reset Transmission Health Monitor From Selector

To enter the transmission health monitor, press simultaneously the ▲ (Upshift) and ▼ (Downshift) arrows four times. An acceptable clutch life status is displayed as “TRANS HEALTH OK”. An unacceptable clutch life status is displayed as “TRANS HEALTH LO”.

The feature will reset automatically upon elimination of the clutch clearance condition which initiated it. The indicator can also be manually reset using the Allison DOC™ for PC diagnostics program if necessary.

▲(Upshift) & ▼ (Downshift) arrow buttons pressed simultaneously *	Description	Message	
1 st press	Allison transmission oil level check		
2 nd press	Oil Life Monitor	" O "	" M "
	Oil life remaining will range from 99% down to 00%	Some number from 9 to 0	Some number from 9 to 0
3 rd press	Filter Life Monitor	" F "	" M "
	Present life of filter is acceptable Present life of filter is unacceptable	OIL FILTER OK REPLACE FILTERS	
4 th press	Transmission Health Monitor	" T "	" M "
	An acceptable clutch life status is displayed as “TRANS HEALTH OK” An unacceptable clutch life status is displayed as “TRANS HEALTH LO”	TRANS HEALTH OK TRANS HEALTH LO	
5 th press	Display of diagnostic codes		

* With the engine off and ignition on.

DIAGNOSTIC TROUBLESHOOTING CODES (DTC) — ALLISON 5TH GENERATION CONTROLS

Diagnostic features are provided with the transmission control system to assist in troubleshooting of malfunctions and/or the monitoring of specific operating parameters.

DIAGNOSTIC TROUBLESHOOTING CODES (DTC) OVERVIEW

When a control system malfunction is detected, a series of Diagnostic Trouble Codes (DTCs) are used to identify and clarify the nature of the malfunction. These DTCs are each named by a 5 character alphanumeric string that refers to a diagnostic algorithm running pass/fail tests to help identify a malfunction in the transmission or vehicle operation. Most DTCs have some kind of diagnostic response that the operator notices, such as an illuminated CHECK light, selector display change, lock in range, or inhibit shifts condition.

DTCs are logged in the Transmission Control Module (TCM) memory by severity and by their active/inactive status with the most severe and active codes listed first. A maximum of five DTCs (numbered d1- d5) from most recent to oldest may be read from the shift selector. As DTCs are added, the oldest inactive DTC (historic) is dropped from the list. If all DTCs are active, the DTC with the lowest priority is dropped from the list.

An active code is any code that is current in the TCM decision-making process and has failed the DTC test(s) associated with that specific diagnostic algorithm. Historical codes, which are by definition inactive, are codes that are no longer failing their algorithm but are retained in the TCM in order to help the technician analyze possible causes and provide them direction if the vehicle is brought in before they are cleared from the queue.

DTCs can be cleared manually by the operator or they clear automatically from last (d5) to first (d1) in the queue after a number of engine starts, without becoming active again.

USING SHIFT SELECTOR FOR ACCESSING DIAGNOSTIC INFORMATION

DTCs can be displayed on the display portion of the shift selector. A DTC is either active or historic. An active DTC is a DTC that is current in the TCM decision-making process. Historic DTCs are retained in the TCM memory and do not necessarily affect the TCM decision-making process.

Display Sequence

Up to five DTCs may be displayed one at a time from the selector once the diagnostic display mode has been initiated by the operator. Each DTC is 5 characters in length. The DTC status active or inactive is shown below the DTC.



Shows active DTC P0730

The operator presses the MODE button to read the next OTC in the queue (if any) or requests to exit diagnostics mode. The diagnostic mode times out and returns the selector to normal operating mode after approximately 10 minutes of operator inactivity.

C-8 Allison Transmission Other Features

DIAGNOSTIC CODE DISPLAY AND CLEARING PROCEDURE

Diagnostic codes can be read and cleared by two methods:

- Using an Allison DOC™ diagnostic tool. For specific instructions on how to use an Allison DOC™ diagnostic tool, refer to the User Guide.
- Using the pushbutton shift selector.

To begin the diagnostic process:

1. Bring the vehicle to a stop at a safe location.
2. Apply the parking brake.

To display stored codes:

1. Simultaneously press the ▲ (Upshift) and ▼ (Downshift) arrow buttons five times (Prognostics enabled) to access the Diagnostic Display Mode. With Prognostics disabled, press the ▲ (Upshift) and ▼ (Downshift) arrow buttons twice.
2. Press the MODE button to read the next code in the queue, if any.

To clear all active stored codes:

While in Diagnostic Mode, clear all active codes by pressing and holding the MODE button for approximately three seconds until the MODE message flashes. Release the MODE button. The MODE message should not remain illuminated if the active DTC shown in the display has cleared.

While in Diagnostic Mode, press and hold the MODE button for 10 seconds to clear both active codes and inactive codes. The MODE message flashes a second time indicating all codes are cleared from the queue.

EXITING DIAGNOSTIC MODE

Exit the diagnostic mode by one of the following methods:

1. Press simultaneously the ▲ (Upshift) and ▼ (Downshift) arrow buttons at the same time on the push button shift selector.
2. Press any range button «D», «N» or «R» on the push button shift selector.
3. After approximately 10 minutes of inactivity at the push button shift selector, the diagnostic mode automatically exits and returns to normal operating mode.
4. Turn off power to the TCM (shut off the engine using the ignition key).

NOTE
<i>Be sure to record all codes displayed before they are cleared. This is essential for troubleshooting.</i>

NOTE
<i>If clearing a code while locked in a «D» (Drive) or «R» (Reverse) position (fail-to-range), the transmission will still be in «D» (Drive) or «R» (Reverse) when the clearing procedure is completed. «N» (Neutral) must be manually selected.</i>

DIAGNOSTIC TROUBLE CODE RESPONSE

The electronic control system is programmed to inform the operator of a problem with the transmission system via the CHECK light and shift selector display while it automatically takes action to protect the operator, vehicle, and transmission. When the Transmission Control Module (TCM) flags a Diagnostic Trouble Code (DTC) as active, the TCM may take a combination of diagnostic responses as listed in the table below.

RESPONSE CATEGORY	ACTIONS TAKEN
DNS - Do Not Shift	Release lock up (LU) clutch and inhibit lock up operation. Inhibit shifts from the current attained range. Turn on the CHECK light. Display the current attained range in the MONITOR window of the shift selector. Blank the SELECT window of the shift selector. Ignore any range selection inputs from the shift selector.
SOL OFF - Solenoid OFF	All solenoids are commanded off, resulting in hydraulic default operation of the transmission – PCS1 & PCS2 are on hydraulically when off electrically.
RPR - Return to Previous Range	When the speed sensor ratio or PS1 tests do not pass, the TCM commands the same range as commanded before the shift.
NNC - Neutral No Clutches	When certain speed sensor ratio or PS1 tests do not pass, the TCM commands a neutral condition with no clutches applied.
DNA - Do Not Adapt	The TCM stops adaptive shift control while the code is active.

C-10 Allison Transmission Other Features

DIAGNOSTIC TROUBLESHOOTING CODES (DTC) LIST - ALLISON 5TH GENERATION CONTROLS

DTC	Description	CHECK Light	Inhibited Operation Description
C1312	Retarder Request Sensor Failed Low	No	May inhibit retarder operation if not using J1939 datalink
C1313	Retarder Request Sensor Failed High	No	May inhibit retarder operation if not using J1939 datalink
P0122	Pedal Position Sensor Circuit Low Voltage	No	Use default throttle values. Freezes shift adapts.
P0123	Pedal Position Sensor Circuit High Voltage	No	Use default throttle values. Freezes shift adapts.
P0218	Transmission Fluid Over Temperature	Yes	Use default sump temp
P0562	System Voltage Low	No	Inhibit TCC Operation, DNA
P0602	TCM Not Programmed	Yes	Lock in Neutral
P0604	Control module random access memory (RAM)	Yes	Lock in Neutral
P0614	Torque Control Data Mismatch ECM/TCM	Yes	Allows operation only in reverse and second range.
P0634	TCM Internal Temperature Too High	Yes	SOL OFF (hydraulic default)
P0642	Sensor Reference Voltage "A" Circuit Low	Yes	Default sensor data used
P0643	Sensor Reference Voltage "A" Circuit High	Yes	Default sensor data used
P0657	Actuator Supply Circuit Voltage 1 Open (HSD 1)	Yes	SOL OFF, DNA, Inhibit TCC operation, Inhibit main modulation
P0658	Actuator Supply Voltage 1 (HSD1) Low	Yes	DNS, SOL OFF (hydraulic default)
P0659	Actuator Supply Voltage 1 (HSD1) High	Yes	DNS, SOL OFF (hydraulic default)

Allison Transmission Other Features C-11

DTC	Description	CHECK Light	Inhibited Operation Description
P0703	Brake Switch Circuit Malfunction	No	No Neutral to Drive shifts for refuse packer. TCM inhibits retarder operation if a TPS code is also active.
P0708	Transmission Range Sensor Circuit High Input	Yes	Ignore defective strip selector inputs
P070C	Transmission Fluid Level Sensor Circuit – Low Input	No	None
P070D	Transmission Fluid Level Sensor Circuit – High Input	No	None
P0712	Transmission Fluid Temperature Sensor Circuit Low Input	Yes	Use default sump temp
P0713	Transmission Fluid Temperature Sensor Circuit High Input	Yes	Use default sump temp
P0715	Turbine Shaft Speed Sensor Circuit	Yes	DNS, Lock in current range
P0716	Turbine Shaft Speed Sensor Circuit Performance	Yes	DNS, Lock in current range
P0717	Turbine Shaft Speed Sensor Circuit No Signal	Yes	DNS, Lock in current range
P071A	RELS Input Failed On	Yes	Inhibit RELS operation
P071D	General Purpose Input Fault	Yes	None
P0720	Output Shaft Speed Sensor Circuit	Yes	DNS, Lock in current range
P0721	Output Shaft Speed Sensor Circuit Performance	Yes	DNS, Lock in current range
P0722	Output Speed Sensor Circuit No Signal	Yes	DNS, Lock in current range
P0725	Engine Speed Sensor Circuit	No	Default to turbine speed
P0726	Engine Speed Sensor Circuit Performance	No	Default to turbine speed
P0727	Engine Speed Sensor Circuit No Signal	No	Default to turbine speed
P0729	Incorrect 6 th Gear Ratio	Yes	DNS, Attempt 5 th , then 3 rd
P0731	Incorrect 1 st Gear ratio	Yes	DNS, Attempt 2 nd , then 5 th

C-12 Allison Transmission Other Features

DTC	Description	CHECK Light	Inhibited Operation Description
P0732	Incorrect 2 nd Gear ratio	Yes	DNS, Attempt 3 rd , then 5 th
P0733	Incorrect 3 rd Gear ratio	Yes	DNS, Attempt 4 th , then 6 th
P0734	Incorrect 4 th Gear ratio	Yes	DNS, Attempt 5 th , then 3 rd
P0735	Incorrect 5 th Gear ratio	Yes	DNS, Attempt 6 th , then 3 rd , then 2 nd
P0736	Incorrect Reverse Gear ratio	Yes	DNS, Lock in Neutral
P0741	Torque Converter Clutch System Stuck Off	Yes	None
P0752	Shift Solenoid 1 Valve Performance-Stuck On	Yes	DNS
P0776	Pressure Control Solenoid (PCS) 2 Stuck Off	Yes	DNS, RPR
P0777	Pressure Control Solenoid 2 Stuck On	Yes	DNS, RPR
P0796	Pressure Control Solenoid 3 Stuck Off	Yes	DNS, RPR
P0797	Pressure Control Solenoid 3 Stuck On	Yes	DNS, RPR
P0842	Transmission Fluid Pressure Switch 1 Circuit Low	Yes	DNS, Lock in current range
P0843	Transmission Fluid Pressure Switch 1 Circuit High	Yes	DNS, Lock in current range
P0847	Transmission Fluid Pressure Switch 2 Circuit Low	Yes	None
P0848	Transmission Fluid Pressure Switch 2 Circuit High	Yes	None
P088A	Transmission Fluid Filter Maintenance Alert	No	None
P088B	Transmission Fluid Filter Maintenance Required	No	None
P0880	TCM Power Input Signal	No	None
P0881	TCM Power Input Signal Performance	No	None
P0882	TCM Power Input Signal Low	Yes	DNS, SOL OFF (hydraulic default)
P0883	TCM Power Input Signal High	No	None
P0894	Unexpected Mechanical Gear Disengagement	Yes	DNS, Lock in first
P0897	Transmission Fluid Deteriorated	No	None
P0960	Main Pressure Modulator Solenoid Control Circuit Open	Yes	None
P0962	Main Pressure Modulator Solenoid Control Circuit Low	Yes	DNS, SOL OFF (hydraulic default)

Allison Transmission Other Features C-13

DTC	Description	CHECK Light	Inhibited Operation Description
P0963	Main Pressure Modulator Solenoid Control Circuit High	Yes	None
P0964	Pressure Control Solenoid 2 (PCS2) Control Circuit Open	Yes	DNS, SOL OFF (hydraulic default)
P0966	Pressure Control Solenoid 2 (PCS2) Control Circuit Low	Yes	DNS, SOL OFF (hydraulic default)
P0967	Pressure Control Solenoid 2 (PCS2) Control Circuit High	Yes	DNS, SOL OFF (hydraulic default)
P0968	Pressure Control Solenoid 3 (PCS3) Control Circuit Open	Yes	DNS, SOL OFF (hydraulic default)
P0970	Pressure Control Solenoid 3 (PCS3) Control Circuit Low	Yes	DNS, SOL OFF (hydraulic default)
P0971	Pressure Control Solenoid 3 (PCS3) Control Circuit High	Yes	DNS, SOL OFF (hydraulic default)
P0973	Shift Solenoid 1 (SS1) Control Circuit Low	Yes	DNS, SOL OFF (hydraulic default)
P0974	Shift Solenoid 1 (SS1) Control Circuit High	Yes	DNS, SOL OFF (hydraulic default)
P0976	Shift Solenoid 2 (SS2) Control Circuit Low	Yes	7- speed: Allow 2 through 6, N, R Inhibit TCC operation
P0977	Shift Solenoid 2 (SS2) Control Circuit High	Yes	7- speed: Allow 2 through 6, N, R
P097A	Shift Solenoid 1 (SS1) Control Circuit Open	Yes	Lock in range
P097B	Shift Solenoid 2 (SS2) Control Circuit Open	Yes	7- speed: Allow 2 through 6, N, R
P0989	Retarder Pressure Sensor Circuit Low	No	None
P0990	Retarder Pressure Sensor Circuit High	No	None
P1739	Incorrect Low Gear Ratio	Yes	Command 2 nd and allow shifts 2 through 6, N, R
P1790	Gear Shift Module 1 Calibrated Invalid	Yes	Shift selector language or units incorrect
P1791	Gear Shift Module 2 Calibrated Invalid	Yes	Shift selector language or units incorrect
P1891	Throttle Position Sensor PWM Signal Low	No	Use default throttle values

C-14 Allison Transmission Other Features

DTC	Description	CHECK Light	Inhibited Operation Description
P1892	Throttle Position Sensor PWM Signal High	No	Use default throttle values
P2184	Engine Coolant Temperature Sensor 2 Circuit Low Input	No	Use default engine coolant values
P2185	Engine Coolant Temperature Sensor 2 Circuit High Input	No	Use default engine coolant values
P2637	Torque Management Feedback Signal (A)	Yes	Inhibit SEM
P2641	Torque Management Feedback Signal (B)	Yes	Inhibit LRTP
P2669	Actuator Supply Circuit Voltage 2 Open (HSD2)	Yes	SOL OFF, Inhibit TCC operation, Inhibit Main modulation, ONA
P2670	Actuator Supply Voltage 2 (HSD2) Low	Yes	DNS, SOL OFF (hydraulic default)
P2671	Actuator Supply Voltage 2 (HSD2) High	Yes	DNS, SOL OFF (hydraulic default)
P2684	Actuator Supply Circuit Voltage 3 Open (HSD3)	Yes	SOL OFF, Inhibit TCC operation, Inhibit Main modulation, ONA
P2685	Actuator Supply Voltage 3 (HSD3) Low	Yes	DNS, SOL OFF (hydraulic default)
P2686	Actuator Supply Voltage 3 (HSD3) High	Yes	DNS, SOL OFF (hydraulic default)
P2714	Pressure Control Solenoid 4 (PCS4) Stuck Off	Yes	DNS, RPR
P2715	Pressure Control Solenoid 4 (PCS4) Stuck On	Yes	DNS, SOL OFF (hydraulic default)
P2718	Pressure Control Solenoid 4 (PCS4) Control Circuit Open	Yes	DNS, SOL OFF (hydraulic default)
P2720	Pressure Control Solenoid 4 (PCS4) Control Circuit Low	Yes	DNS, SOL OFF (hydraulic default)
P2721	Pressure Control Solenoid 4 (PCS4) Control Circuit High	Yes	DNS, SOL OFF (hydraulic default)
P2723	Pressure Control Solenoid 1 (PCS1) Stuck Off	Yes	DNS, RPR
P2724	Pressure Control Solenoid 1 (PCS1) Stuck On	Yes	DNS, RPR
P2727	Pressure Control Solenoid 1 (PCS1) Control Circuit Open	Yes	DNS, SOL OFF (hydraulic default)
P2729	Pressure Control Solenoid 1 (PCS1) Control Circuit Low	Yes	DNS, SOL OFF (hydraulic default)

Allison Transmission Other Features C-15

DTC	Description	CHECK Light	Inhibited Operation Description
P2730	Pressure Control Solenoid 1 (PCS1) Control Circuit High	Yes	DNS, SOL OFF (hydraulic default)
P2736	Pressure Control Solenoid 5 (PCS5) Control Circuit Open	Yes	Inhibit retarder operation
P2738	Pressure Control Solenoid 5 (PCS5) Control Circuit Low	Yes	Allow 2 through 6, N, R. Inhibit retarder and TCC operation
P2739	Pressure Control Solenoid 5 (PCS5) Control Circuit High	Yes	Inhibit retarder operation
P273F	Retarder Oil Temperature Sensor Over Temperature Condition	No	None
P2742	Retarder Oil Temperature Sensor Circuit – Low	No	Use default retarder temp values
P2743	Retarder Oil Temperature Sensor Circuit – High	No	Use default retarder temp values
P2761	TCC PCS Control Circuit Open	Yes	Inhibit TCC operation
P2763	TCC PCS Control Circuit High	Yes	Inhibit TCC operation
P2764	TCC PCS Control Circuit Low	Yes	7- speed: Allow 2 through 6, N, R. Inhibit TCC operation
P2789	Transmission Clutch Life Expired (Clutch Adaptive Learning at Limit)	No	None
P2793	Gear Shift Direction Circuit	Yes	Ignores PWM input from shift selector
P2808	Pressure Control Solenoid 6 (PCS6) Stuck Off	Yes	DNS, RPR
P2809	Pressure Control Solenoid 6 (PCS6) Stuck On	Yes	DNS, RPR
P2812	Pressure Control Solenoid 6 (PCS6) Control Circuit Open	Yes	DNS, SOL OFF (hydraulic default)
P2814	Pressure Control Solenoid 6 (PCS6) Control Circuit Low	Yes	DNS, SOL OFF (hydraulic default)
P2815	Pressure Control Solenoid 6 (PCS6) Control Circuit High	Yes	DNS, SOL OFF (hydraulic default)
U0073	CAN Communication Bus 1 Off	No	Use default values
U0074	CAN Communication Bus 2 Off	No	Use default values
U0100	Lost Communications with ECM A	Yes	Use default values

C-16 Allison Transmission Other Features

DTC	Description	CHECK Light	Inhibited Operation Description
U0103	Lost Communication with Gear Shift Module (Shift Selector) 1	Yes	Maintain range selected, observe gear shift direction circuit
U0291	Lost Communication with Gear Shift Module (Shift Selector) 2	Yes	Maintain range selected, observe gear shift direction circuit
U0304	Incompatible Gear Shift Module 1 (Shift Selector)	Yes	Ignore shift selector inputs
U0333	Incompatible Gear Shift Module 2 (Shift Selector)	Yes	Ignore shift selector inputs
U0404	Invalid Data Received From Gear Shift Module (Shift Selector) 1	Yes	Maintain range selected, observe gear shift direction circuit
U0592	Invalid Data Received From Gear Shift Module (Shift Selector) 2	Yes	Maintain range selected, observe gear shift direction circuit

APPENDIX D

ON-SCREEN TPMS 2

D-2 TPMS Troubleshooting Guide

ON-SCREEN TPMS

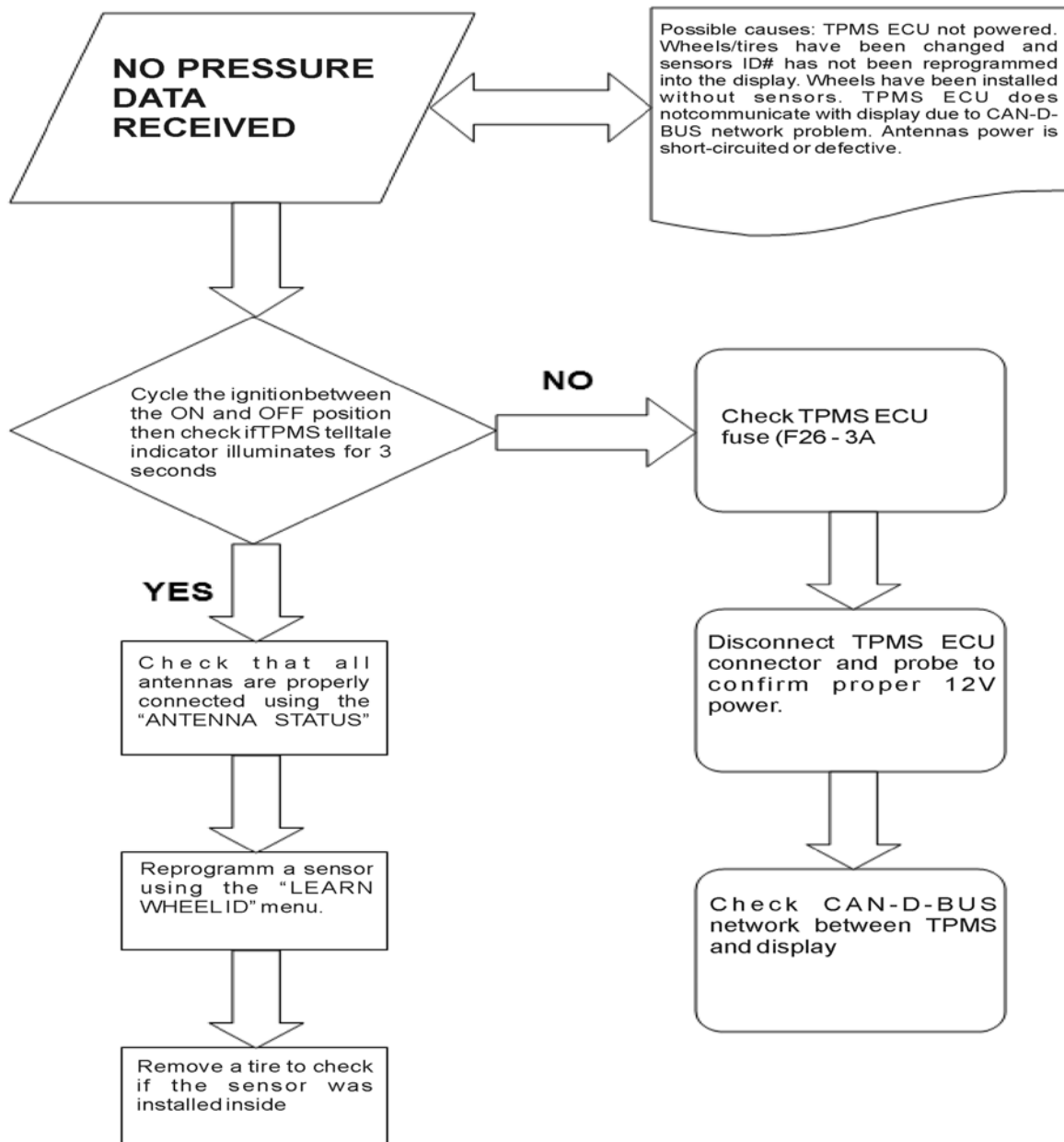

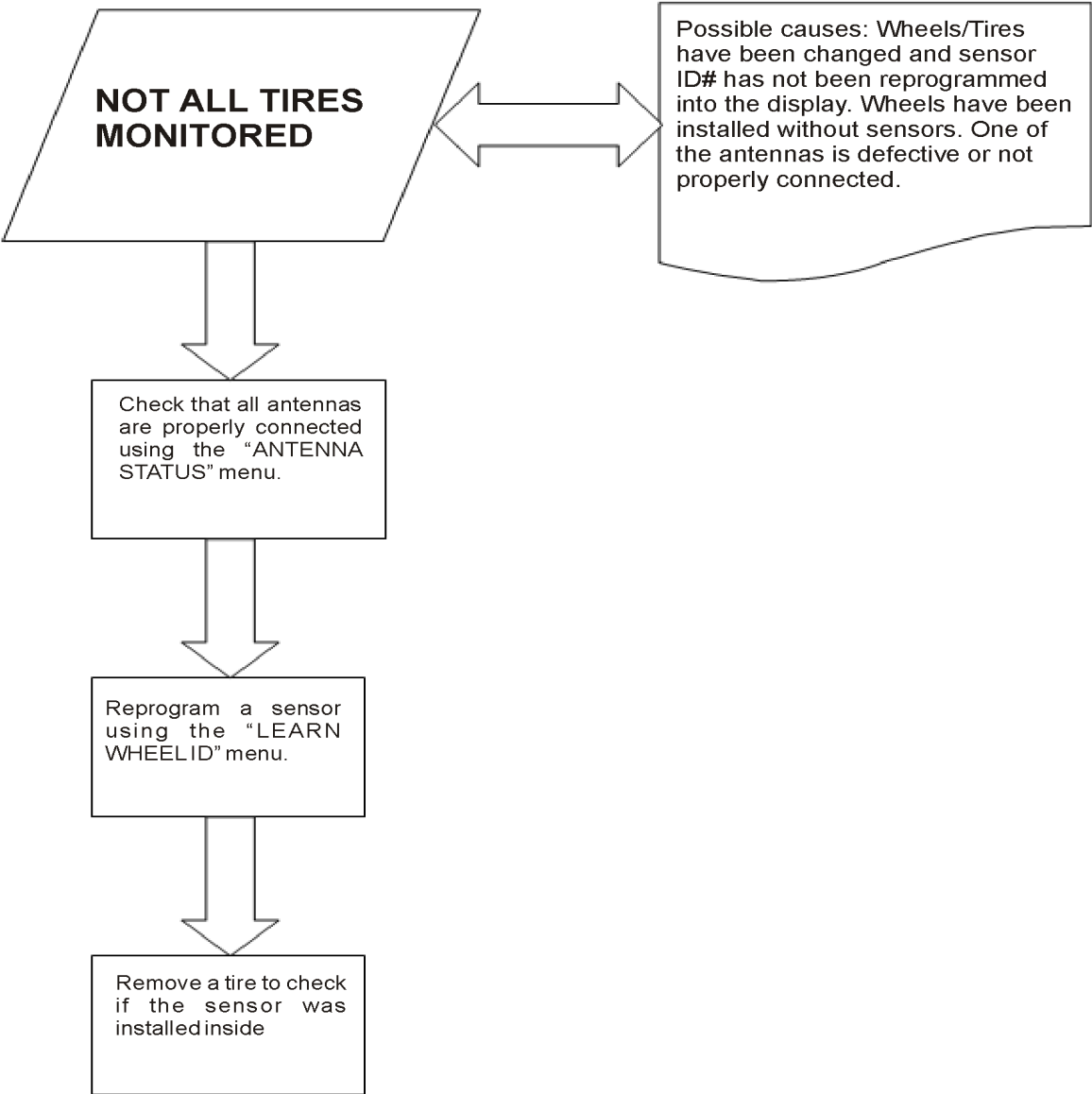

D-4 TPMS Troubleshooting Guide
