



EG4 Destination Controller

Installation and Operating Manual

(Software version V2.34.0)



Revision History

Revision	Date	Notes
541955-13	19/04/2023	Updates of: EG4 Variants, Specification, Appendix E: Parameter Settings in HELEN Software (TCP1, TCP2, UDP1, UDP2)
541955-14	26/05/2023	<p>Updates of: Software version V2.12.0 to V2.15.0, Status and Information (Configured Equipment Status), System Configuration (Digital I/O), Connected Equipment, Driver Display Control (5) USB Power, Date and Time Settings, Appendix B: Serial Ports (IVNUPLOAD), Appendix C: Config.ini file, Appendix E: Parameter Settings in HELEN Software (PU added)</p> <p>Update of: Software version V2.15.0 to V2.15.2</p> <p>Updates of: Software version V2.15.2 to V2.17.2, System Configuration (Network), Appendix C: Config.ini file</p>
541955-15	08/11/2023	<p>Updates of: ISO 9001 & ISO 14001 logos, EG4 variants (EG4.STD.0000.000 (Obsolete))</p> <p>Software version V2.17.2 to V2.24.0, Network Status, Hardware Fitted, Digital I/O, Power Save, Connected Equipment, Address Mappings, Audio Settings, Network, Reboot Device, Appendix B: Serial Ports, Appendix C: Config.ini file, Appendix E: Parameter Settings in HELEN Software</p> <p>Software version V2.24.0 to V2.26.0, Appendix C: Config.ini file</p>
541955-16	18/03/2024	<p>Updates of: EG4 Variants, Appendix C: Config.ini file</p> <p>Software version V2.26.0 to V2.34.0, Start HTC Driver Menu, Status and Information, Driver Display Control, Display, Passcodes and Permissions, Start USB Disaster Recovery, Appendix D: Virtual HTC Terminal, Appendix E: HTC Terminal Mode</p>



Please note that this document is subject to continual updating: please ensure you are using the latest edition.

This edition: **18 March 2024**



© COPYRIGHT HANOVER DISPLAYS LTD 2024

The copyright of this document is vested in Hanover Displays Ltd and the document is issued in confidence for the purpose only for which it is supplied. It must not be reproduced in whole or in part or used for tendering or manufacturing purposes except under an agreement or with the consent in writing of Hanover Displays Ltd and then only on the condition that this notice is included in any such reproduction. All trademarks are recognised.

CONTENTS

GLOSSARY	7
1. Introduction	8
1.1 General	8
1.2 Scope of this manual	8
1.3 Brief history of Hanover destination controllers	9
1.4 System overview	9
1.5 Identification	10
1.5.1 Product label (Pre July 2022)	11
1.5.2 Product label (Post July 2022)	12
1.5.3 EG4 Variants	13
1.6 Destination controller overview	16
1.6.1 Front view	16
1.6.2 Rear view – M12 version	16
1.7 Technical information	17
1.7.1 Specification	17
2. Installation	20
2.1 Fitting the destination controller	20
2.2 System wiring	21
2.2.1 Power and communication	21
2.2.2 Adaptor cable	22
2.2.2.1 CX330K – For replacing a DERIC+ destination controller	22
2.2.2.2 CX330N – For replacing an ERIC++ destination controller	22
3. Operation	23
3.1 Getting started	23
3.1.1 Boot screens on power-up	23
3.2 Loading / Updating a destination list on the EG4	23
3.2.1 Updating the destination list via “Wireless Data Manager” software	23
3.2.2 Updating the destination list using an USB flash memory drive	24
i. Preparing the USB flash memory drive	24
ii. Loading the destination list to the USB flash memory drive	24
iii. Loading the destination list to the EG4	25
3.3 Selecting the data to be shown on the destination displays	26
3.3.1 Destination code	26
3.3.1.1 Setting destination using destination code entry	27
3.3.1.2 Setting destination using the browse list	28
3.3.2 Route code	29
3.3.3 Information/Message code	31
3.3.4 Round Trip	33
3.4 Sign Self Test	36
3.5 Start HTC Driver Menu	37
3.6 Status and Information	37
3.6.1 Configured Equipment Status	38

3.6.2	Connected Equipment Status	39
3.6.3	Digital I/O	39
3.6.4	Network Status	40
3.6.5	System Information	40
3.6.6	Hardware Fitted	41
3.6.7	Runtime Statistics	41
3.7	Settings to access other functions of the EG4	41
3.7.1	System Configuration	42
3.7.1.1	Controller Profile	43
3.7.1.2	Digital I/O	44
1)	Emergency message	46
2)	Blanking the destination display (battery guard)	47
3)	Displaying 'Bus stopping'	47
4)	Information message	48
5)	Displaying 'Bus reversing'	48
6)	Audio announcement	49
i.	Preparing the audio file(s)	49
ii.	Preparing the USB flash memory drive	49
iii.	Loading the audio file(s) to the USB flash memory drive	50
iv.	Loading the audio file(s) to the EG4	50
7)	Power Save	50
3.7.1.3	Serial Ports	50
1)	Port Mapping	51
3.7.1.4	CAN Ports	53
3.7.1.5	Connected Equipment ⁷	53
1)	Address Mappings	54
3.7.1.6	Audio Settings	55
3.7.1.7	Network ²⁰	57
3.7.1.8	Driver Display Control	61
1)	Common	61
2)	Destination ³¹	62
3)	Messages	63
4)	HTC Hot Key	63
5)	USB Power	63
3.7.2	Console Management	63
3.7.2.1	Language	64
3.7.2.2	Display ³⁴	65
1)	Adding a personalised splash screen	67
3.7.2.3	Date and Time Settings	68
3.7.2.4	Passcodes and Permissions ⁴⁰	69
3.7.2.5	Start USB Disaster Recovery	70
3.7.2.6	Factory Default Settings	71
3.7.2.7	Reboot Device	72
4.	Firmware	73
4.1	Overview	73

4.2	EG4's firmware version	73
4.3	Firmware Update	74
4.3.1	Via "Wireless Data Manager" software	74
4.3.2	Via an USB flash memory drive	75
4.3.2.1	Prior to firmware version V0.11.2	75
i.	Preparing the USB flash memory drive	75
ii.	Loading the firmware to the USB flash memory drive	75
iii.	Loading the firmware to the EG4	75
4.3.2.2	From firmware version V0.11.2 up to and including V0.12.0	76
i.	Preparing the USB flash memory drive	76
ii.	Loading the firmware to the USB flash memory drive	76
iii.	Loading the firmware to the EG4	76
4.3.2.3	From firmware version V0.13.0 onwards	77
i.	Preparing the USB flash memory drive	77
ii.	Loading the firmware to the USB flash memory drive	77
iii.	Loading the firmware to the EG4	77
5.	Troubleshooting	78
5.1	Overview	78
5.1.1	No display or backlight on destination controller	78
5.1.2	No communication or required information not displayed on destination displays	78
5.1.3	List will not load into EG4 destination controller	79
5.1.4	EG4 loads list correctly but shows 'Bad Destination or Bad Route'	79
5.2	Hanover Technical Support	79
6.	Queries, FAQs and other information	80
6.1	Overview	80
6.2	Queries/FAQs	80
Appendix A: Function of connectors on rear of EG4 destination controller		82
Appendix A-1:	SK1 18-way mini fit connector	82
Appendix A-1-1:	SK1 COMMS OPTIONS: 18-way mini fit connector	83
Appendix A-2:	SK2 14-way mini fit connector	84
Appendix A-2-1:	SK2 COMMS OPTIONS: 14-way mini fit connector	85
Appendix A-2-2:	Wiring variation for additional communication protocols	86
Appendix A-3:	SK3 Audio 10-way mini fit connector	88
Appendix A-4:	M12 ETHERNET	88
Appendix B: Serial Ports		89
Appendix C: Config.ini file		91
Appendix C-1:	Overview	91
Appendix C-2:	Updating the Config.ini file on the EG4	105
i.	Preparing the USB flash memory drive	105
ii.	Loading the Config.ini file to the USB flash memory drive	105
iii.	Loading the Config.ini file to the EG4	105
Appendix D : Virtual HTC Terminal		106
Appendix D-1:	Access to Virtual HTC Terminal	106

Appendix E: HTC Terminal Mode	108
Appendix E-1: Access to HTC Terminal Mode	108
Appendix E-2: Simulation Menu	110
Appendix E-3: Volumes Menu	111
Appendix E-4: System Tests	112
Appendix E-5: Settings Menu	113
Appendix F: Parameter Settings in HELEN Software	114

GLOSSARY

Explanations relate to the use of the terms in this manual and other Hanover publications; the word or phrase may have other meanings elsewhere.

browse - move up / down a list of options in order to find the desired item

controller - on-bus device used by a driver to populate destination displays with text and graphics which have been prepared using Helen software

cycle - in the context of "cycling the power": a reference to the action of turning a piece of equipment off (cutting the power to it) and then on again

database - information uploaded to a destination controller from a standard PC using HELEN sign-editing software. Includes destination / route number information, advertising and other service information (e.g. emergency announcements, school bus messages etc.)

DERIC - **D**iminished **E**lectronic **R**oute **I**ndicator **C**ontroller

(destination) code - the number used to identify a particular destination from a list. Each code must be unique within the list and can contain up to 10 alphanumeric characters. It is the code to be entered on the driver's destination controller

(destination) list - an electronic list of information for one or more routes / destinations specified by the HELEN software and deployed via a destination controller on a destination display

display - sign

ERIC - **E**lectronic **R**oute **I**ndicator **C**ontroller

HELEN - **H**anover **E**xtended **L**ist **E**ditor for **D**estination **N** Displays - a software tool used to create and edit text, graphics and destination lists on a pc as they will appear on a Hanover destination display

IBIS - communications standard - mostly used on buses with German equipment

I/P - Input

LED - light-emitting diode: most Hanover destination displays use LED technology

Mini fit (connector) - two-piece pin and socket interconnection where cylindrical spring-metal pins fit into cylindrical spring-metal sockets. The pins and sockets are held in a rectangular matrix in a nylon shell.

multi-drop - connection of several devices to a single communication or power line (in 'daisy chain' configuration)

O/P - Output

RS485 - the main electrical communications standard used for communications between destination displays and destination controller

RTC - **R**eal **T**ime **C**lock

RX - reception channel of serial port

sign - equipment used to present text and graphics for viewing by passengers, usually located on the front, side or rear of, or inside a bus

Super-X - display control language for determining the way text is presented on a destination display

TX - transmit channel of serial port

UTC - Coordinated Universal Time: the primary time standard by which the world regulates clocks and time. It is one of several closely related successors to Greenwich Mean Time (GMT). For most purposes, UTC is synonymous with GMT.

1. Introduction

1.1 General

The best understanding of Hanover's EG4 destination controller will be gained by reading the complete manual - but this is not always practicable for the user. The document has therefore been written in a modular fashion in order to allow users to refer only to those parts of it they need: topics should thus appear relatively self-contained. However, there are several useful cross-references, both to other points within this manual, to other Hanover manuals and to external documents as appropriate. Accordingly, when consulting this document using a pdf reader, it is helpful to have the 'Back' (or 'Previous') and 'Next' (or 'Skip' / 'Forward') buttons enabled to obtain maximum benefit from the intra-document cross-references. For example, in Adobe Reader, press F8 to view the toolbar if it is not already visible. Right-click on a blank section of the toolbar and, in the 'Page Navigation' menu, please ensure that 'Previous View' and 'Next View' are ticked.

Reference is made to the LED destination displays and to the HELEN software used with the EG4: detailed manuals are available for these from Hanover.

Destination displays for buses and coaches are normally used on the front, side and rear of the vehicle. This practice is so widespread that Hanover often uses 'front, side and rear' to describe equipment used in those positions. However, it is important to stress that any destination display can be used anywhere on a vehicle, subject to the relevant electrical / communications connections being made.

Information about the location of the destination controller is provided in section [2.1 Fitting the destination controller](#).

1.2 Scope of this manual

This manual covers the installation and operation of the Hanover EG4 destination controller. It also has troubleshooting and FAQs sections which address the more common problems and queries.

Manual covers	
Section 1	Introduction to the manual (also contains technical information for the destination controller) and the EG4
Section 2	Installation
Section 3	Operation
Section 4	Firmware
Section 5	Troubleshooting
Section 6	FAQs which address the more common problems and queries
Manual does not cover	
The destination or in-bus destination displays themselves:	
<ul style="list-style-type: none"> • The installation and service of the destination displays: for more details, please refer to the LED destination display - installation and service manual (ref. 540156) • Technical specification for individual destination displays: this is provided separately for each variant 	
The use of the HELEN sign-editing software for composing messages for the destination displays: for more details, please refer to the HELEN sign-editing software - operating manual (ref. 540125)	

Hanover produces many bespoke and custom systems - for example, with special wiring adaptations or software features. The EG4 destination controller will work well as part of a networked system (including with third-party hardware) but users are advised to consult their system-specific documentation and / or consult Hanover (please refer to section [5.2 Hanover Technical Support](#)) where necessary.

1.3 Brief history of Hanover destination controllers

Year	History
1989	The first ERIC (E lectronic R oute I ndicator C ontroller) had an extensive keypad and four serial ports.
1991	The original and black front DERIC (D iminished E lectronic R oute I ndicator C ontroller) was introduced with 128k flash memory, later expanded to 1MB.
1999	The grey front DERIC+ was introduced. As a more versatile destination controller, it boasted faster loading and could also be used as a data loader. The DERIC+ deployed a standardised communication plug-in and allowed firmware updates directly via a serial port instead of having to change an EEPROM.
2003	Similar in many respects to the DERIC+, the ERIC+ introduced a graphic display to destination controllers and could be supplied with a 4MB memory.
2005	The ERIC++ had the same features as the ERIC+ but contained a different and faster processor.
2011	The DG3 (DERIC Generation 3) was introduced, bringing a larger (more pixels) graphic display and USB connectivity. It worked across a wider voltage range (9-36V) than the DERIC (24-36V). A pushbutton was added to the front panel and it was generally easier to use. The DG3 cannot be used as a data loader however, although the USB facility renders the loss of this feature largely irrelevant.
2014	The arrival of the EG3 (ERIC Generation 3) heralded USB connectivity for the ERIC destination controllers' family, has up to four secondary communications ports and a still faster processor. It also has Ethernet connectivity.
2020	The EG4 (ERIC Generation 4) was introduced. It is an advanced user terminal incorporating a touchscreen graphical user interface, a built-in 10W audio output (that can be connected to on-board speakers) and an additional line level audio output (that can be connected to an on-board amplifier), combined with a variety of serial interfaces and radio options specifically designed for use in the public transportation industry.

1.4 System overview

The EG4 is a powerful unit that controls how the information is presented on destination and in-bus displays located on buses and coaches. The EG4 destination controller is a touchscreen graphical user interface with configuration settings hidden behind a user-programmable lock code. The EG4 can be used to show route / destination details and other information, all programmed using the HELEN sign-editing software. It can also be connected to (work with) other items of on-board equipment (subject to protocols).



Figure 1 - diagram showing typical destination controller / displays configuration. Each unit is powered individually.

A database of information for all destination displays within a system is created on a standard Windows PC, using HELEN software. The database is then uploaded to the destination controller either via USB or remotely. Each destination display has a processor with an address switch that is associated with the configuration for that destination display set within HELEN. This allows it to receive the appropriate information via the EG4 which is connected to the destination display by a RS485 multi-drop communications network or by Ethernet.

Note that any EG4 configuration parameters set in HELEN that are loaded into the destination controller will be overwritten by any manual changes to those parameters made later directly via the destination controller itself. Further list downloads will overwrite such manual changes if the configuration option is selected when exporting the list from HELEN.

Note also that any manual alterations that conflict directly with HELEN-programmed parameters should be avoided as the results are unpredictable.

Full technical details are provided in section [3 Operation](#).

1.5 Identification

The destination controller's identification can be determined from the silver label on the casing of the destination controller.

In addition to identifying the model, it may be necessary to determine the software version installed, especially for technical support queries. To ascertain the version in use, go to 'Product Release' in [3.6.5 System Information](#).

1.5.1 Product label (Pre July 2022)



Figure 2a – silver label (pre July 2022) on casing of destination controller

Features	Meaning	Description
Product no.	Product number	Identifies the specific model and is explained in section 1.5.3 Model variants .
Position	-	Indicates where the destination controller is likely to be fitted on the vehicle.
Type	-	Installation type.
Our order no.	Our order number	Number used for internal use by Hanover.
Your O/N	Your Order Number	Number used to identify the order for this destination controller.
Your Part no.	Your Part number	Specific to each destination controller.
S/N	Serial Number	Specific to each destination controller.
End User	-	Is generally the ultimate operator of the vehicle.
Builder	-	References the name/customer to which the product is shipped.
Job reference	-	For the use of builder or end user.
Manufactured	-	Date when the finished destination controller is available for shipment after all checks, tests and approvals are complete.
Made in the UK	-	Shows the country of manufacture of the destination controller.
Exx-yyR-zznnnn	United Nations Standard Type Approval (EMark) number	xx = country code. yy = regulation number. zz = regulation revision number. nnnn = approval certificate number.

1.5.2 Product label (Post July 2022)

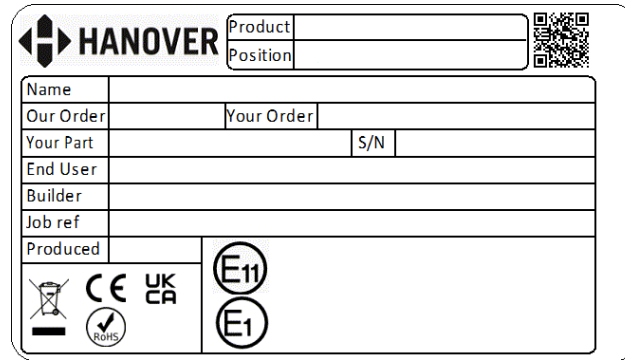









		Product		
		Position		
Name				
Our Order		Your Order		
Your Part		S/N		
End User				
Builder				
Job ref				
Produced				
  		 		

Figure 2b – silver label (post July 2022) on casing of destination controller

Features	Meaning	Description
Product	Product number	Identifies the specific model and is explained in section 1.5.3 Model variants .
Position	-	Indicates where the product is likely to be fitted on the vehicle.
QR Code	-	Serial number of product.
Name	-	Name of product e.g. size, colour etc.
Our Order	Our order number	Number used for internal use by Hanover.
Your Order	Your Order Number	Number used to identify the order for this product.
Your Part	Your Part number	Specific to each product.
S/N	Serial Number	Specific to each product.
End User	-	Is generally the ultimate operator of the vehicle.
Builder	-	References the name/customer to which the product is shipped.
Job ref	Job Reference	For the use of builder or end user.
Produced	-	Date when the finished product is available for shipment after all checks, tests and approvals are complete.
  	-	WEEE (Waste Electrical and Electronic Equipment) logo = Dispose of appropriately. Do not dispose of with ordinary refuse – on all products. CE = conforms; can be sold in EU. RoHS = product contains no hazardous substances. UKCA = same as CE but for Great Britain.

Features	Meaning	Description
Exx-yyRaa-bb-nnnn-zz	The United Nations Economic Commission for Europe (UNECE) for automotive industry Regulation approvals mark	xx = country code of certifying body. yy = regulation number. aa/bb = revision of regulation nnnn = approval certificate number. zz = approval revision number (if any).
	UNECE Reg 10	Exx- 10R aa-bb-nnnn-zz Conforms to the Electromagnetic Compatibility requirements of the vehicles and electronic sub-assemblies (ESAs) used in automotive industry.
	UNECE Reg 118	Exx- 118R aa-bb-nnnn-zz Conforms to the requirements of the Burning Behaviour of Materials used in the interior construction of certain categories of motor vehicles.

1.5.3 EG4 Variants

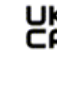
The EG4 destination controller has a product number of **EG4.AAA.BCDE.FGG** where:

- **EG4** is constant.
- **AAA** can be:
 - STD: Standard
 - AVL: Audio & GNSS
 - FUL: Full Build
 - IPT: ITxPT
- **B** can be:
 - 0: No Ethernet
 - 1: M12
 - 2: RJ45
- **C** can be:
 - 0: Fixed RS485
 - 1: Fixed J1708
- **D** is IF1. Configurable - see serial interface table below.

- **E** is IF2. Configurable - see serial interface table below.

	Serial interface
0	None
1	RS232
2	Not used
3	RS485 or RS422
4	Isolated RS485
5	IBIS Slave
6	J1708
7	IBIS Master

- **F** can be:
 - 0: Not fitted
 - 1: GSM Modem
 - 2: GSM Modem (North America only)
- **GG** can be:
 - 00: Standard
 - 01: Power Save

The table below shows the list of available EG4 variants.

EG4 Variants	RS485 (Sign)	RS232 (Fixed)	RS485 (Fixed)	J1708 (Fixed)	Comms I/F1	Comms I/F2	Digital Input	Digital Output	Ethernet	CAN	Odometer	10W Audio Amplifier	Ambient Noise Input	Line Out	GPS	Wifi	4G	Power Save **	Notes
EG4.STD.0000.000 (Obsolete)	✓	✓ x1	✓ x1	-	-	-	✓ x3	-	-	-	-	-	-	-	-	-	-	-	Previously EG4.001/EG4.011
EG4.STD.1000.000	✓	✓ x1	✓ x1	-	-	-	✓ x3	✓ x2	✓ 2xM12	✓	✓	-	-	-	-	-	-	-	Previously EG4.003/EG4.007
EG4.STD.1057.000	✓	✓ x1	✓ x1	-	IBIS-S	IBIS-M	✓ x3	✓ x3	✓ 2xM12	✓	✓	-	-	-	-	-	-	-	-
EG4.STD.2000.000	✓	✓ x1	✓ x1	-	-	-	✓ x3	✓ x3	✓ 2xRJ45	✓	✓	-	-	-	-	-	-	-	-
EG4.AVL.1000.000	✓	✓ x1	✓ x1	-	-	-	✓ x3	✓ x2	✓ 2xM12	✓	✓	✓	✓	✓	✓	-	-	-	-
EG4.AVL.1057.000	✓	✓ x1	✓ x1	-	IBIS-S	IBIS-M	✓ x3	✓ x2	✓ 2xM12	✓	✓	✓	✓	✓	✓	-	-	-	-
EG4.AVL.2000.000	✓	✓ x1	✓ x1	-	-	-	✓ x3	✓ x2	✓ 2xRJ45	✓	✓	✓	✓	✓	✓	-	-	-	-
EG4.FUL.1000.100	✓	✓ x1	✓ x1	-	-	-	✓ x3	✓ x2	✓ 2xM12	✓	✓	✓	✓	✓	✓	✓	✓*	-	Previously EG4.009
EG4.FUL1000.101	✓	✓ x1	✓ x1	-	-	-	✓ x2	✓ x2	✓ 2xM12	✓	✓	✓	✓	✓	✓	✓	✓	✓	-
EG4.FUL.2000.100	✓	✓ x1	✓ x1	-	-	-	✓ x3	✓ x2	✓ 2xRJ45	✓	✓	✓	✓	✓	✓	✓	✓*	-	-
EG4.IPT.1035.000	✓	✓ x1	✓ x1	-	RS485	IBIS-S	✓ x2	✓ x2	✓ 2xM12	✓	✓	-	-	-	-	-	-	✓	Previously EG4.005

* Modem not suitable for North America use.

** Power save feature uses one of the available digital inputs, therefore one digital input will be used up for Power Save.

1.6 Destination controller overview

1.6.1 Front view

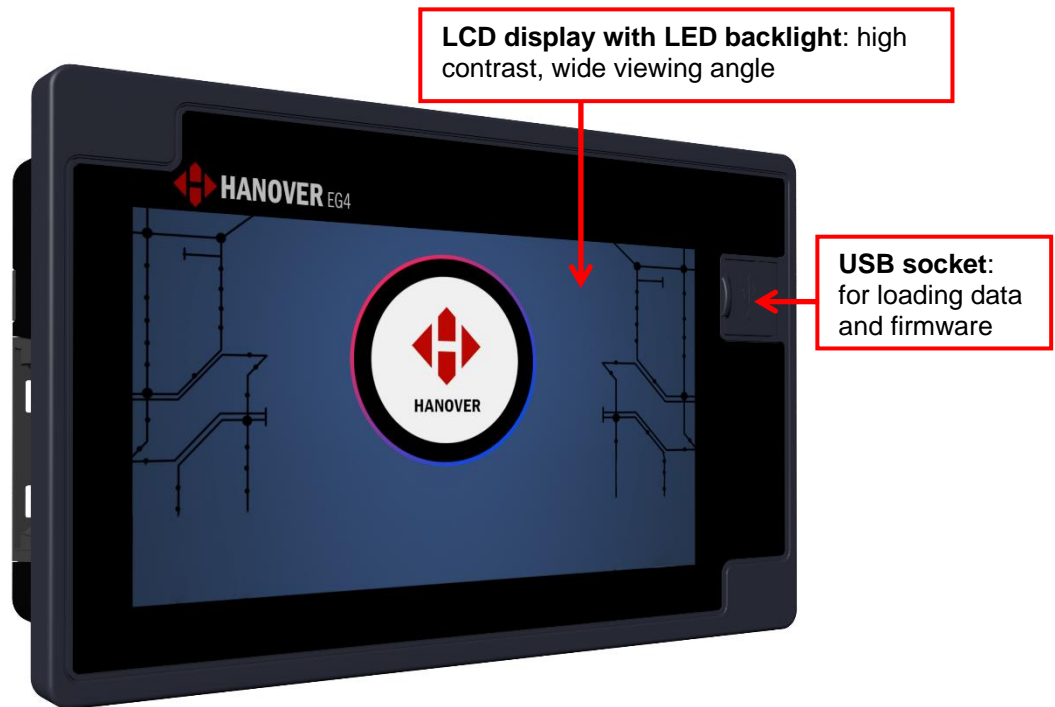

Figure 3 - diagram showing the front side of the destination controller

For more information about the other specifications of the EG4, please refer to [1.7.1 Specification](#).

1.6.2 Rear view – M12 version

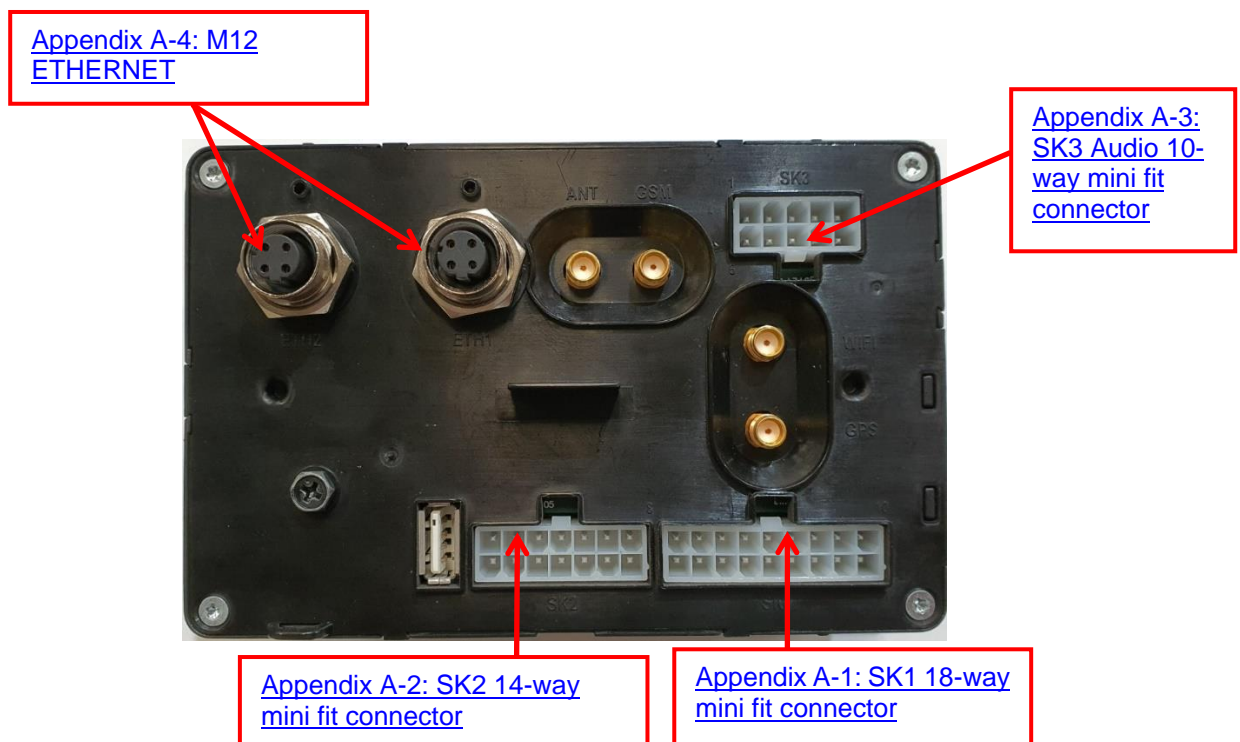

Figure 4 - diagram showing the rear side of the destination controller (M12)

1.7 Technical information

1.7.1 Specification

Mechanical data	Values / Description
Rear case dimensions	W138mm x H90mm x D50mm
Front bezel dimensions	W160mm x H100mm x D9.5mm
Case construction	Moulded ABS plastic
Mounting type	Cam actuated from under removable bezel
Weight	0.55kg fully loaded, 0.37kg base unit

Display data	Values / Description
Display size	5" diagonal (W109.65mm x H61.63mm)
Display format	854x480 (RGB) 5" IPS TFT LCD display with LED backlight
Touch screen	5-point (gesture enabled) touch controller, PCT (Projected Capacitive Touch)
Ambient light sensor	Automatic screen brightness control (0-1000 Lux)

Data Storage	Values / Description
Processor	Dual core ARM CPU @ 1GHz
User storage	4GB eMMC for OS and user media
DRAM	1GB DDR3L
USB	1x USB 2.0 port (Type A) on front panel
Real time clock (optional)	Supported by CR1225 Lithium primary cell

Communications, Input/Output	Values / Description
Sign communications	1x RS485 (standard communications with Hanover signs)
Secondary communications	Fixed ports: 1x RS232 (3-wire interface), 2x RS485 Plug-in interface sites: RS485 (standard/iso)/RS232/IBIS (master/slave)/ISO CAN options
CAN interface	Non-isolated CAN
GNSS (optional)	Constellations: GLONASS, GPS, GALILEO, BeiDou Hold-up for Ephemeris data (~4h) SAW filter for LTE co-existence Phantom power pass-through for antenna port with overcurrent protection
Digital inputs	3 x isolated 32Vdc (maximum) inputs – 3V threshold
Odometer inputs (optional)	1 x isolated 3-wire input, 2KHz 3V3 to 32V
Digital outputs (optional)	2 x isolated 2-wire pass-through outputs (50mA capable)

Network interfaces	Values / Description
Ethernet (optional)	2x Ethernet 10/100Mbps – M12/RJ45
WI-FI (optional)	Dual band 2.4GHz and 5GHz 802.11a, 802.11b, 802.11g, 802.11n Transmit power: 18dBm Receive sensitivity: -97dBm Security features: WPA/WPA2 personal, WPA/WPA2 enterprise security, WPS (in-host)
GSM (optional)	LTE radio module specific to deployed region Dual antennas, primary TX/RX and diversity RX only port Nano-SIM

Audio	Values / Description
Audio amplifier (optional)	1x 10W RMS output into 4 Ohm load @ 10.5V (undervoltage limit)
Line outputs (optional)	1x line output @ 2Vpp into 600R load
Audio compensation mic inputs (optional)	1x dedicated ambient noise compensation mic 1x speaker can be used as a compensation microphone
Piezo sounder (optional)	Piezo sounder for structured tones

Electrical data	Values / Description
Operating voltage	12Vdc or 24Vdc nominal (8-32Vdc) (36V overvoltage rated)
Typical operating power (with options)	6 watts (0.25A with 24V input)
Fuse rating	3A

Operational data	Values / Description
Operating conditions	-20°C to 60°C / 95% non-condensing humidity
Storage temperature	-40°C to 80°C

2. Installation

2.1 Fitting the destination controller

Standard positions for the destination controller are:

- on the dash, to the right or left-hand side
- in the destination display pod
- above or below the driver's window.

Care must be taken to ensure enough space is provided at the rear of the destination controller unit for the power and communication cables.

It is important to mount the controller in a suitable position for the driver for best access and visibility.

Position	Advantages	Disadvantages
Above or below the driver's window or above the windscreen in the destination display pod	This area usually has sufficient space to accommodate the destination controller and the cabling. It also allows easy access for maintenance.	Awkward for drivers to operate and difficult for them to view.
Left or right on the dash	Good visibility and access. Wiring and servicing are normally straightforward.	Difficult to find sufficient depth of space on modern vehicles.
Below the pod above the driver's head	Good visibility and access. Wiring and servicing are normally straightforward.	Possible water damage if window is opened.



The controller is not waterproof. Do not position the unit where it is likely to come into contact with water / moisture - for example, under an opening window.

Water ingress is not covered by the product warranty.



Warning: Drivers should never attempt to operate the controller whilst driving.



Do not use acetone-based cleaners on the EG4 as this may cause discolouration to the casework.

The EG4 destination controller should be fitted by:

- first removing the front bezel using the slots (2 on each side) on the rear of the screen.



Figure 5 - diagrams showing the front bezel removed using the slots

- and then either place the destination controller into the cut-out and tighten the cam screws. The cams will then attach to the panel and lock the EG4 in place.



Do not overtighten the cams.

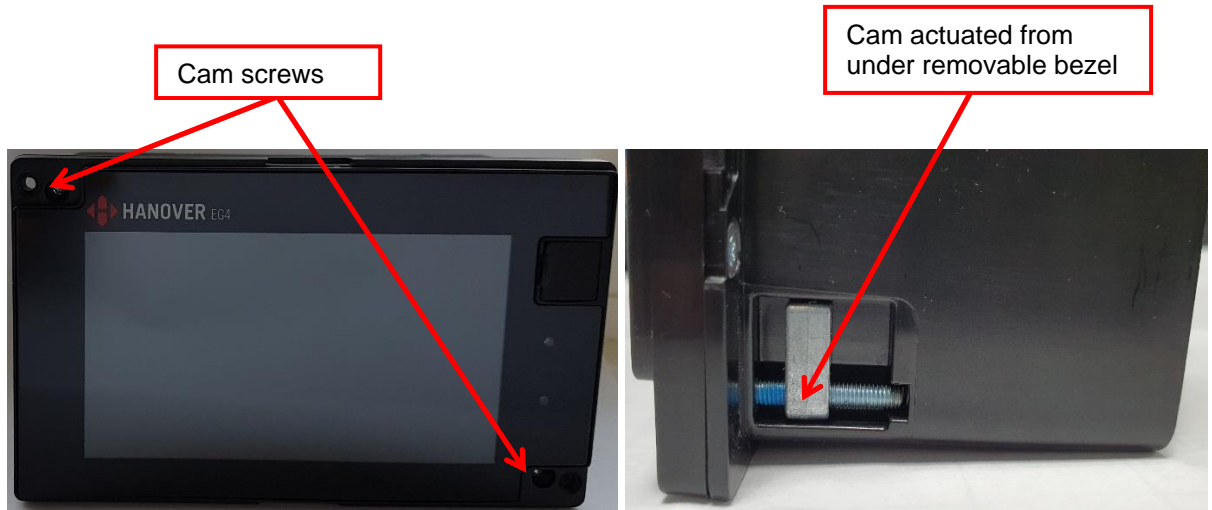

Figure 6 - diagrams showing the 2 cam screws and cam (one on each side)

- or use the 2 fixing holes (using M3 screws) to directly mount into the panel.



Figure 7 - diagram showing the 2 fixing holes

2.2 System wiring

The destination controller should be connected after the master switch but before the ignition switch such that the vehicle engine need not be running for the destination controller to work. However, should the user only need it to be operative whilst the engine is running, the EG4 can be inserted after the ignition switch.

2.2.1 Power and communication

Power and communication connections to the EG4 destination controller are by means of an 18-way mini fit connector found on the rear of the destination controller. If a DERIC+ or an ERIC++ was fitted before and was to be replaced by an EG4, an adaptor cable CX330K or CX330N can be used. The standard length of the spiral cable wrap is 200mm. However, it can be customised according to the customer's needs.

Please refer to section [2.2.2.1 CX330K – For replacing a DERIC+ destination controller](#) when replacing a DERIC+ or to section [2.2.2.2 CX330N – For replacing an ERIC++ destination controller](#) when replacing an ERIC++.

2.2.2 Adaptor cable

2.2.2.1 CX330K – For replacing a DERIC+ destination controller

The CX330K adaptor cable allows the EG4 to replace a DERIC+ destination controller in an existing installation.

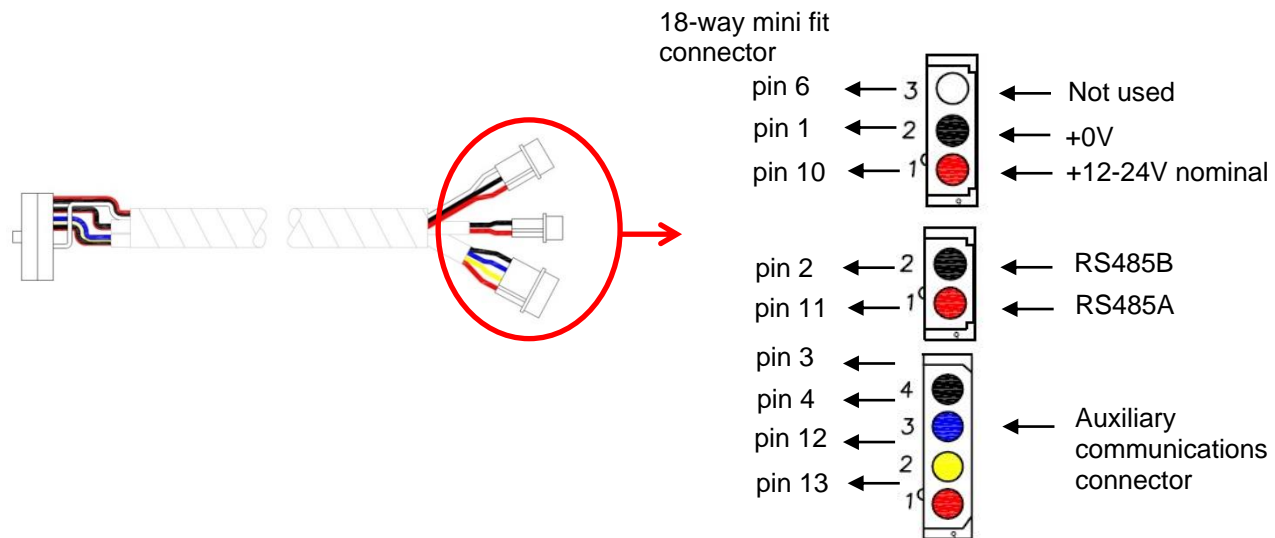

Figure 8 - CX330K cable & pinouts

The four-pin connector allows third-party equipment to be connected through mini fit pins 3, 4, 12 and 13. The connections vary according to the secondary communications protocol deployed. For more details, refer to [Appendix A-1: SK1 18-way mini fit connector](#).

2.2.2.2 CX330N – For replacing an ERIC++ destination controller

The CX330N adaptor cable allows the EG4 to replace an ERIC++ destination controller in an existing installation.

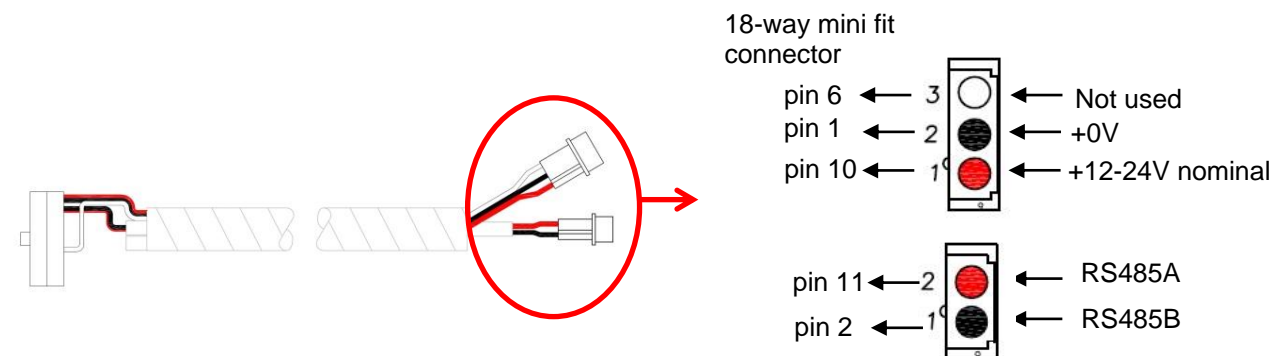

Figure 9 - CX330N cable & pinouts

For more details about the 18-way mini fit connector, please refer to section [Appendix A-1: SK1 18-way mini fit connector](#).

3. Operation

3.1 Getting started

3.1.1 Boot screens on power-up

Whenever the EG4 is powered up or restarted, the HANOVER logo will be displayed on the screen.



Figure 10 – boot screen of EG4 destination controller

Note: when no activity is detected, the destination controller will go in power saving mode and eventually, the screen may blank. The display inactivity timeout and display off timeout can be set via the “Settings” feature. Refer to [3.7.2.2 Display](#).

3.2 Loading / Updating a destination list on the EG4

A destination list can be updated on the EG4 in the two following ways:

- Either [3.2.1 Updating the destination list via “Wireless Data Manager” software](#)
- or [3.2.2 Updating the destination list using an USB flash memory drive](#)

3.2.1 Updating the destination list via “Wireless Data Manager” software

It is possible to update a destination list on the EG4 via the “Wireless Data Manager” software. For more details about “Wireless Data Manager” software, refer to Wireless Data Manager – Commissioning and Operation Guide (ref. 540934).

The destination controller should be configured by loading a Config.ini file using an USB flash memory drive. For more details about the parameters of the Config.ini file, refer to [Appendix C-1: Parameters of Config.ini file](#).

To update the Config.ini file on the EG4, refer to [Appendix C-2: Updating the Config.ini file on the EG4](#).

3.2.2 Updating the destination list using an USB flash memory drive

The EG4 uses a USB flash memory drive to load/update a destination list via its USB port. The USB flash memory drive must be formatted to use the FAT32 file system.



USB flash memory drives sometimes fail: try another stick before assuming the problem lies elsewhere.

i. Preparing the USB flash memory drive

Prepare the USB flash memory drive as follows:

Step	Description
1	Insert the USB flash memory drive into the PC. It appears as USB DRIVE (D:) . Note: The name and drive letter are variable and in this case, the drive letter allocated to the USB flash memory drive by the PC is 'D:'.
2	Create the following location on the USB: <p style="text-align: center;">/hanover/db</p>

ii. Loading the destination list to the USB flash memory drive

Load the destination list to the USB flash memory drive using HELEN software as follows:

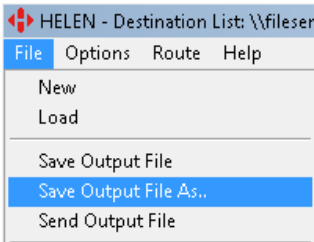
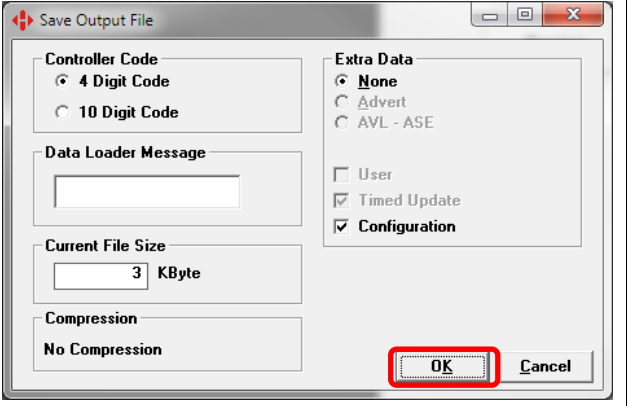
Step	Description	Figure
1	In the main HELEN window, click File → Save Output File As.. as shown.	
2	Verify that the options selected are correct and then click "OK".	

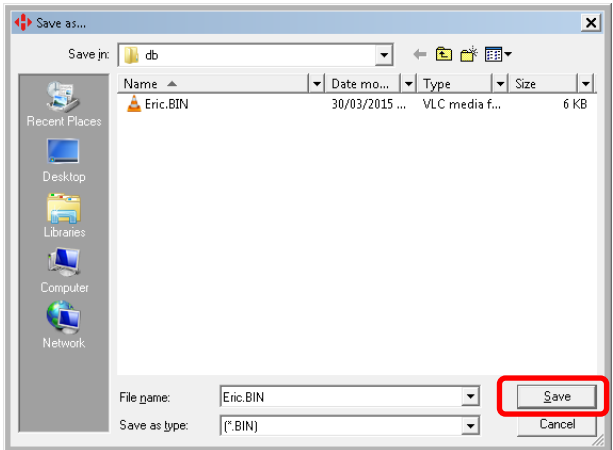
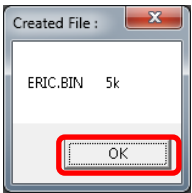
Step	Description	Figure
3	<p>The 'Save As...' window will appear as shown (it may be necessary to browse to the USB folder → Hanover folder → DB folder). Ensure the text in the 'File name:' box is Eric (or Eric.BIN) and that the 'Save as type:' box has [*.BIN] in it.</p> <p>Click "Save".</p> <p>Note that subsequent downloads will already have a file called Eric.BIN shown in this window: it will be overwritten.</p>	
4	<p>The database has been saved to the USB flash memory drive inside the DB folder. Click "OK".</p>	
5	<p>'Safely remove' the USB flash memory drive from the PC. To do so, look for "Safely remove Hardware" icon on the taskbar. Right-click the icon and select the hardware you want to remove.</p>	

iii. Loading the destination list to the EG4

Transfer the destination list from the USB flash memory drive to the EG4 as follows:

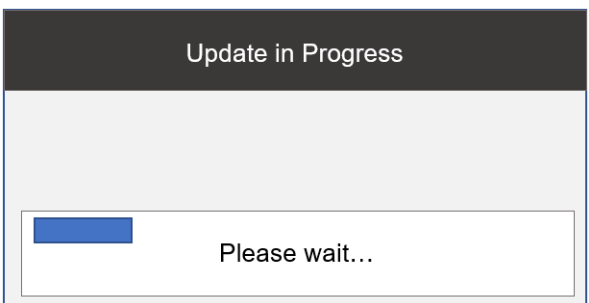
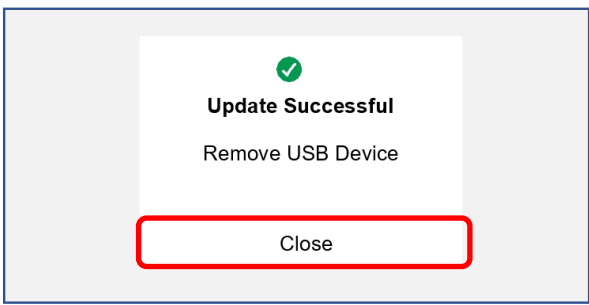
Step	Description	Figure
1	<p>Insert the USB flash memory drive into the USB port on the front of the destination controller.</p>	
2	<p>The EG4 will automatically find the database – the destination controller will transfer and save the database.</p>	
3	<p>When update is complete, the destination controller will display "Update Successful" and "Remove USB Device".</p> <p>Tap "Close" and the USB flash memory drive can be removed.</p> <p>The destination list has been updated on the EG4.</p>	

3.3 Selecting the data to be shown on the destination displays

The destination controller uses the database loaded from HELEN to populate the vehicle's destination displays. Route/destination information and other data can be stored in the database.

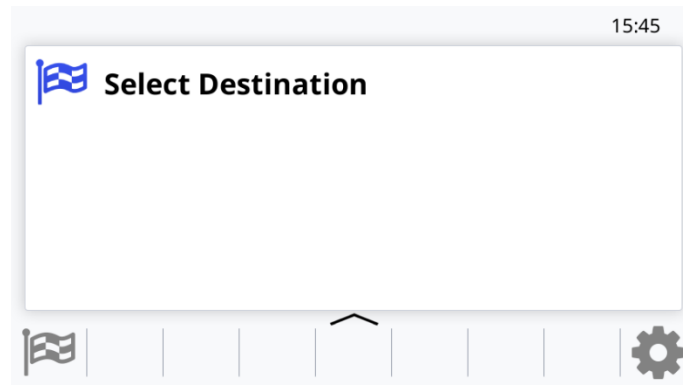

You can access this data on the EG4 by tapping the  icon at the bottom of the screen when the destination controller is in normal operational mode.

This will allow you to enter a destination code or cycle through the various destination/route browse options as shown:

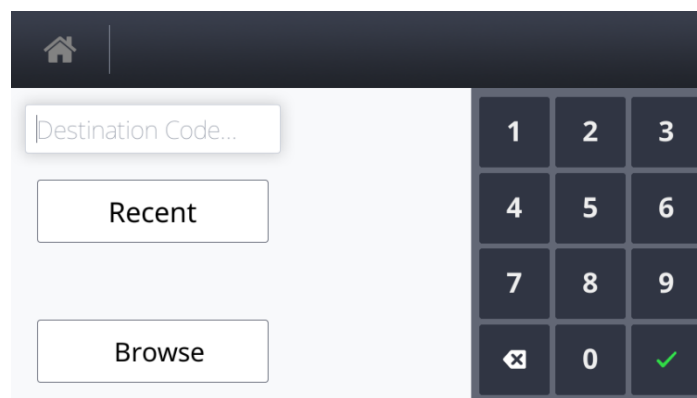

In normal operational mode, the default display of the EG4 is to show the current selected destination/route code.



3.3.1 Destination code

The destination code¹ determines the data shown on the destination and in-bus destination displays (if connected) and is used in a standard configuration. The text is usually in the form of a place name and/or route number whilst the code itself is a four to ten-digit number. By default, the destination controller will be in 'Idle' state.

In the example below, the destination controller is set to show destination code 0001. You wish to change from destination code 0001 (NOT IN SERVICE) to destination code 1010 (destination: 383 Glebe).

¹ This can be set via HELEN by adding the appropriate parameter. Refer to [Appendix F](#).

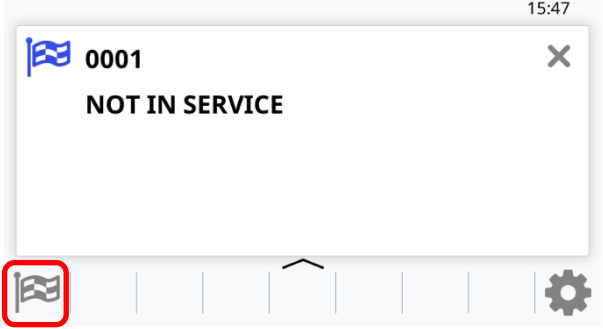
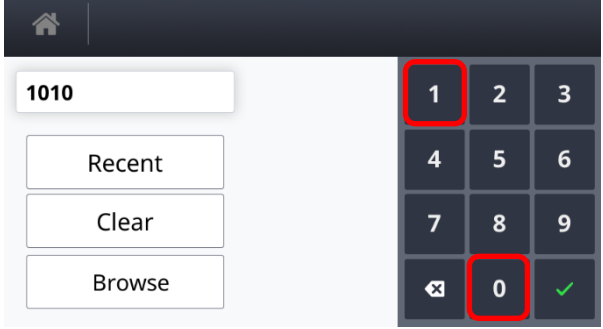
3.3.1.1 Setting destination using destination code entry

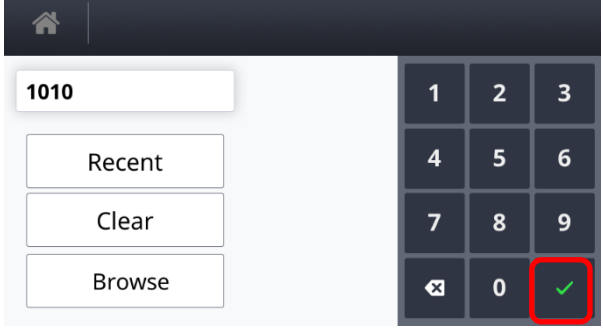
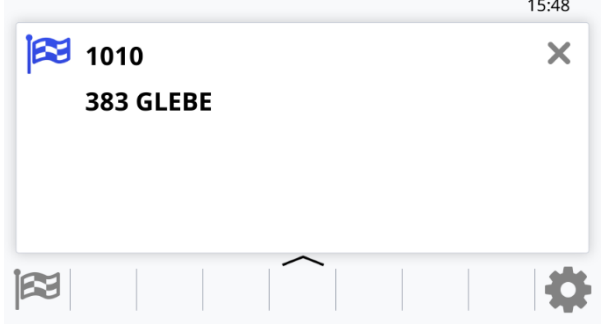
Step	Description	Figure
1	Using the touchscreen, tap the  icon. Note: the screen may be in 'sleep mode'. Simply touch the screen to 'wake it up'.	
2	Enter 1010 using the keypad.	
3	Tap  .	
4	The destination "383 GLEBE" will be displayed on the controller, the front and side destination signs and the route number "383" on the rear destination sign of the vehicle.	

Note: The destination highlighted is the currently selected destination.

3.3.1.2 Setting destination using the browse list

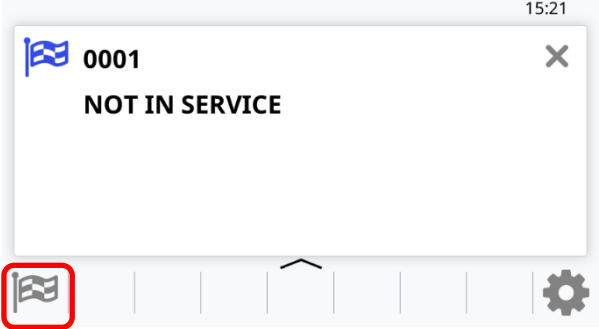
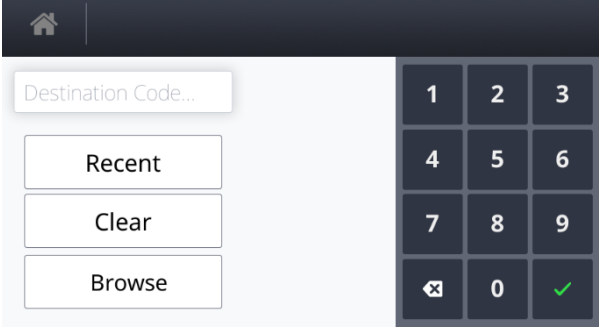
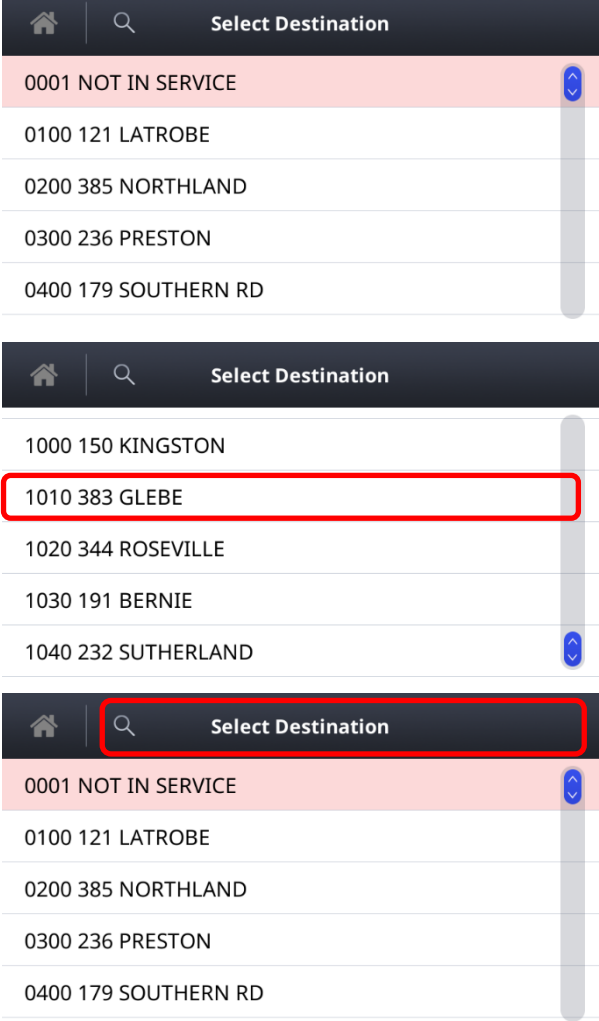
Step	Description	Figure
1	Using the touchscreen, tap the  icon. Note: the screen may be in 'sleep mode'. Simply touch the screen to 'wake it up'.	
2	Tap "Browse".	
3	The destination list will be displayed. Either: Slide from the bottom to the top of the screen to scroll through the list Then, tap "1010 383 GLEBE" from the list. Or: Tap "Select Destination".	

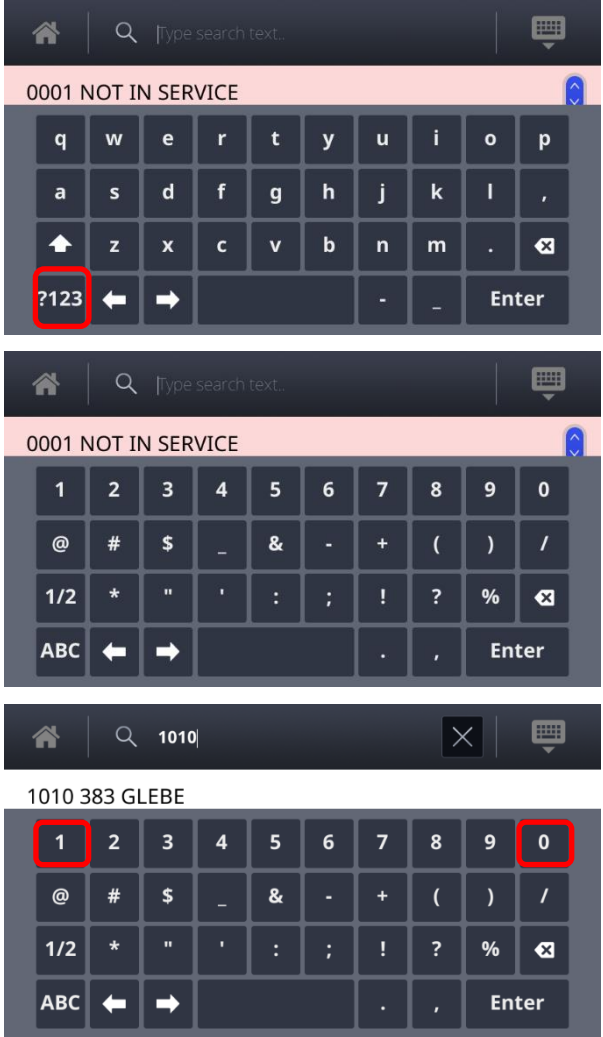
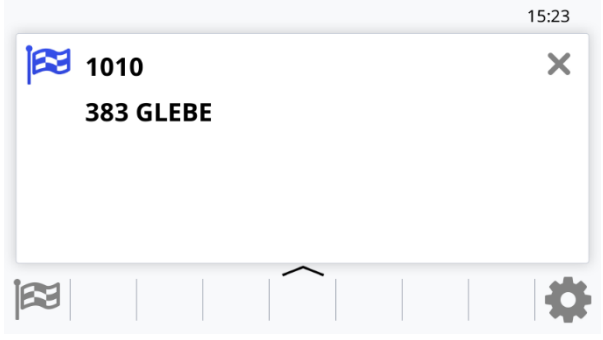
Step	Description	Figure
	<p>The following keyboard will be displayed. Tap “?123”.</p> <p>The following keyboard will be displayed.</p> <p>Enter 1010. “1010 383 GLEBE” will be displayed.</p> <p>Note: Tapping on the ‘keyboard icon’ will hide the keyboard from the display. Tap “1010 383 GLEBE”.</p>	
4	<p>The destination “383 GLEBE” will be displayed on the controller, the front and side destination signs and the route number “383” on the rear destination sign of the vehicle.</p>	

Note: The destination highlighted is the currently selected destination.

3.3.2 Route code

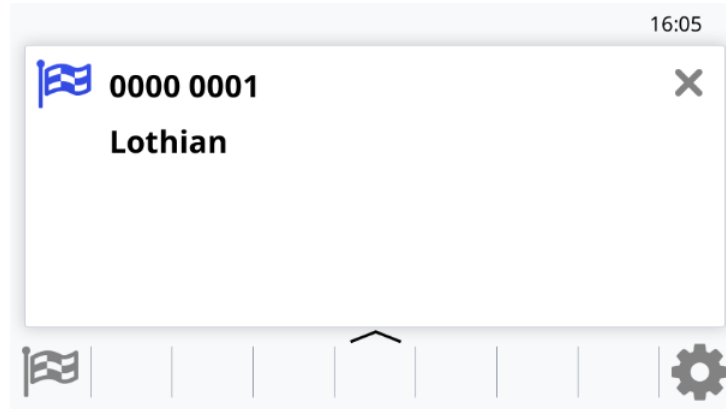

Where several destinations for a particular route are managed together, the 'Route Browse'² function can be used (refer to the HELEN sign-editing software - Operating manual (ref. 540125)). The route code (ideally the same number as the route number - but not necessarily) is then used to group these destinations together. Route code³ is also used for entering a route number with a destination. By default, the destination controller will be in 'Idle' state.

Below is an example of a route displayed on the destination controller:



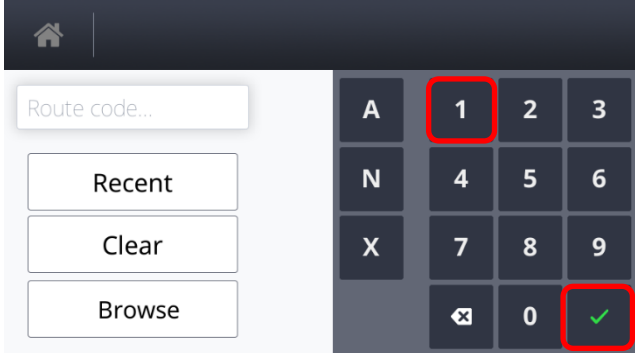

In the example below, the destination controller is set to show route code 0. Suppose the choice was made to change from route code 0 (destination 1: Lothian) to route code 1 (destination 1: 1 Clermiston).

The procedure would be as follows:

Step	Description	Figure
1	Using the touchscreen, tap the  icon. Note: the screen may be in 'sleep mode'. Simply touch the screen to 'wake it up'.	
2	Either: For the route code, enter 1 using the keypad. Tap  .	

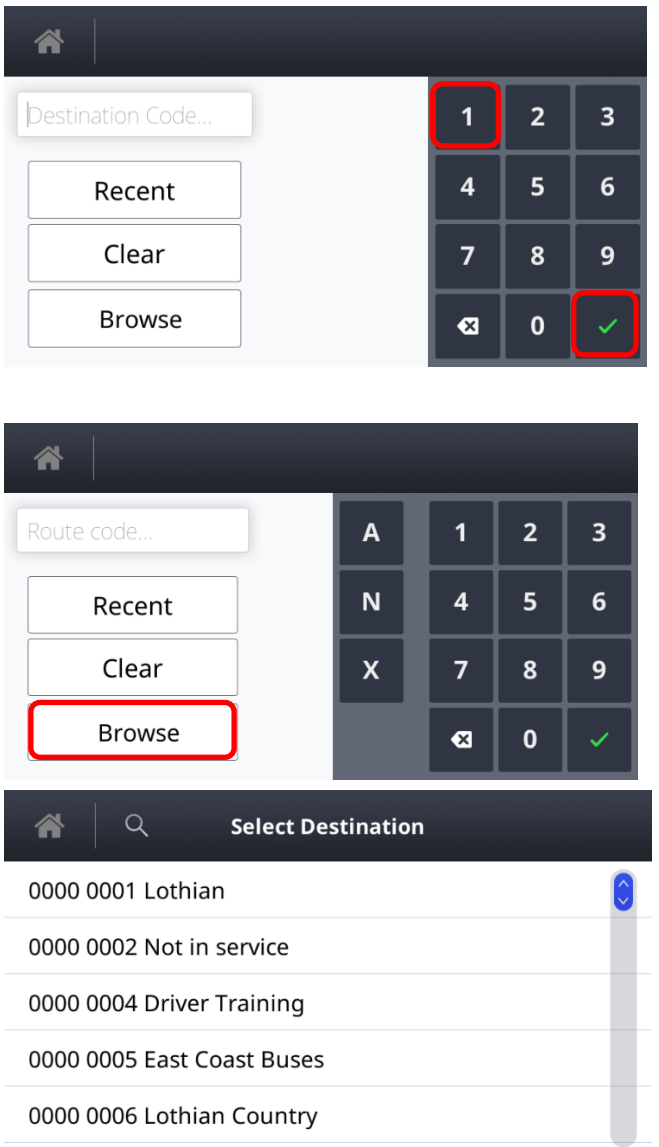
²³ This can be set via HELEN by adding the appropriate parameter. Refer to [Appendix F](#).

Step	Description	Figure
	<p>Then, for the destination code, enter 1 using the keypad. Tap ✓.</p> <p>Or: Tap “Browse”.</p> <p>The destination list will be displayed as shown.</p> <p>Slide from the bottom to the top of the screen to scroll through the list.</p> <p>Then, tap “0001 0001 1 Clermiston”.</p>	
3	<p>The route code 1 (destination 1: 1 Clermiston) will be displayed on the controller.</p>	







3.3.3 Information/Message code

The information/message code refers to a general passenger information message which is periodically shown on the destination displays, for example, 'Merry Xmas!' or 'No evening service today'. Each message has its own information code number.

The information/message code is set up using HELEN software (for more details, please refer to HELEN software sign-editing software – operating manual (ref. 540125)) and stored in the database deployed by the destination controller for use by the user/driver.

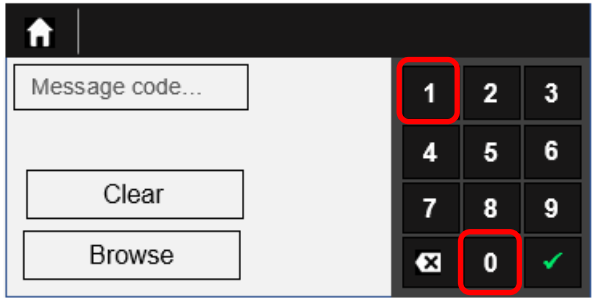
A destination list containing an information/message code will have the  icon displayed on the EG4.

In the example below, the destination controller is set to show destination code 0001 (destination 115 Ae Village). You wish to also show the info message “Bus Full” which is info code 10.

Step	Description	Figure
1	Using the touchscreen, tap the  icon. Note: the screen may be in ‘sleep mode’. Simply touch the screen to ‘wake it up’.	
2	Enter 10 using the keypad.	
3	Tap  .	
4	The destination “115 Ae Village” will be displayed on the controller, the front and side destination displays and the route number “115” on the rear destination display of the vehicle.	

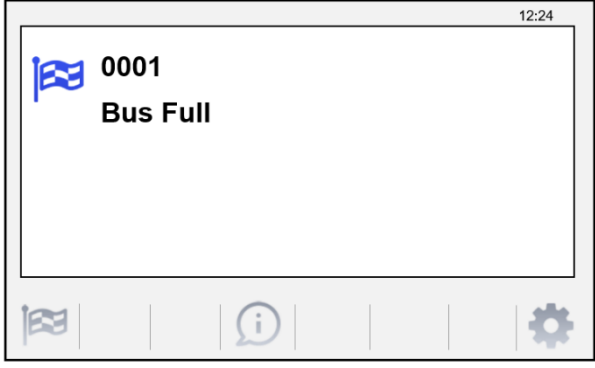
Step	Description	Figure
	The programmed driver's message and destination display content of the information message "Bus Full" will be displayed in between the destination message on the controller and the destination display(s).	

3.3.4 Round Trip

The round trip is accessible using the  icon on the front screen of the destination controller (icon will be visible only if the feature "Round trip" is enabled (refer to [3.7.1.7 Driver Display Control – 2\) Destination](#))).

The procedure would be as follows:

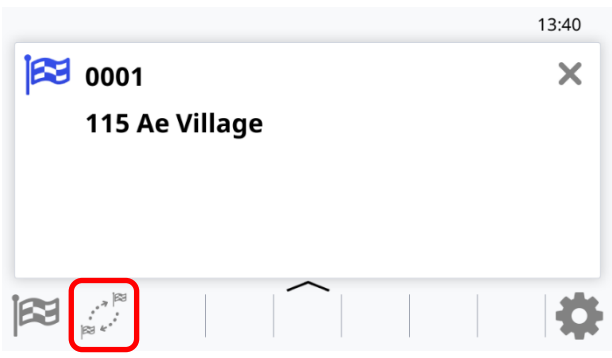
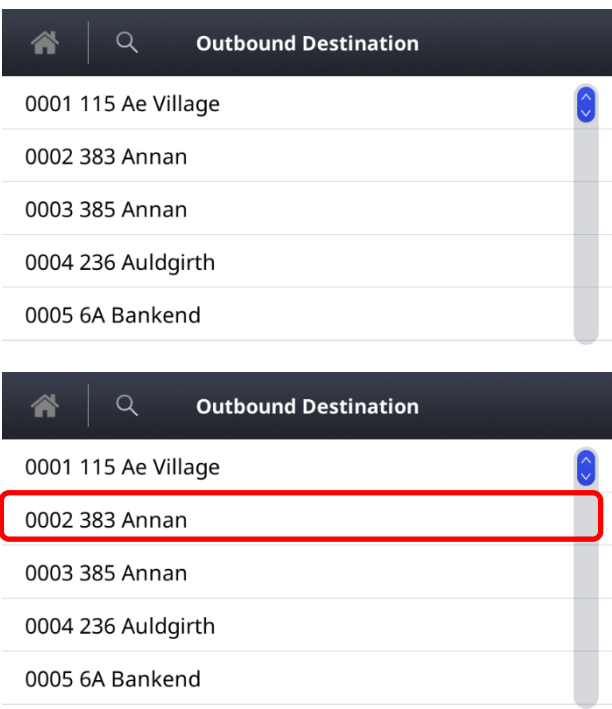
Step	Description	Figure
1	Using the touchscreen, tap the  icon. Note: the screen may be in 'sleep mode'. Simply touch the screen to 'wake it up'.	
2	The destination list will be displayed. Either: Slide from the bottom to the top of the screen to scroll through the list. Then, tap the outbound destination from the list. For example: 0002 383 Annan.	

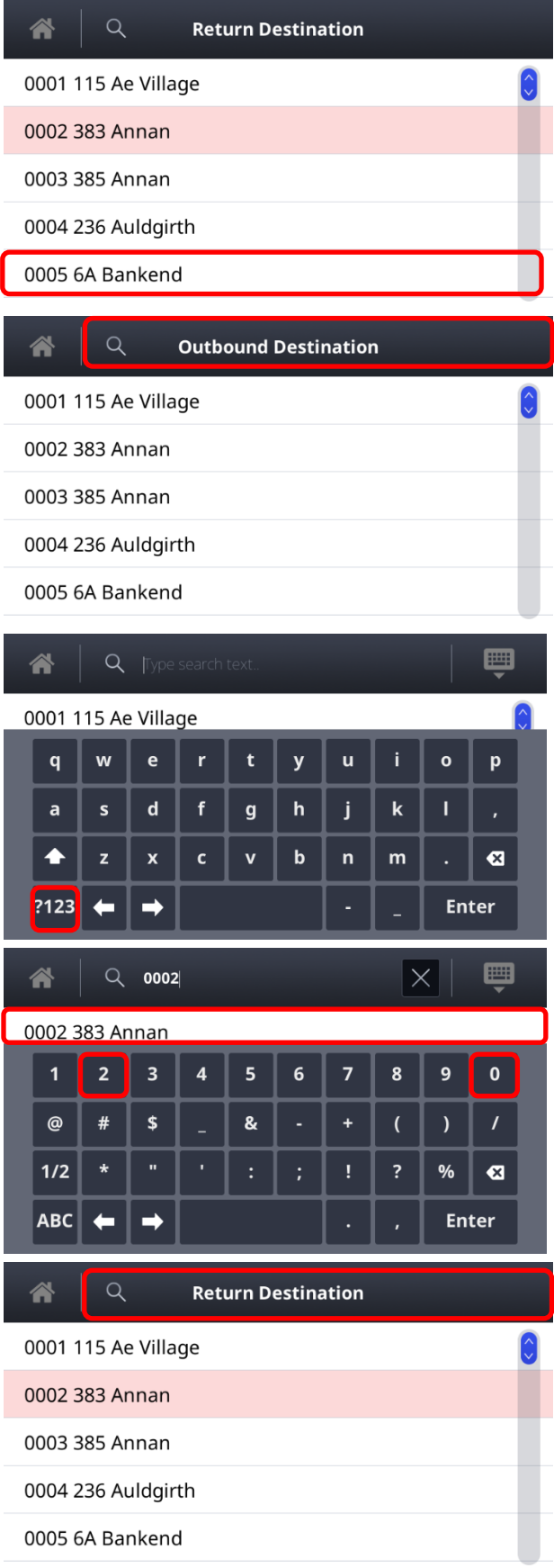
Step	Description	Figure
	<p>Slide from the bottom to the top of the screen to scroll through the list.</p> <p>Then, tap the return destination from the list. For example: 0005 6A Bankend.</p> <p>Or:</p> <p>Tap “Outbound Destination”.</p> <p>The following keyboard will be displayed. Tap “?123”.</p> <p>The following keyboard will be displayed. Enter 0002. “0002 383 Annan” will be displayed. Tap “0002 383 Annan” as the outbound destination.</p> <p>Tap “Return Destination”.</p>	 <p>The figure consists of four screenshots illustrating the steps:</p> <ol style="list-style-type: none"> Return Destination: A list of destinations is shown. The entry "0005 6A Bankend" is highlighted with a red box. Outbound Destination: The screen shows a search bar and a list of destinations. A keyboard is displayed with the "?123" key highlighted in red. Outbound Destination (Number Entry): The search bar contains "0002". The keyboard shows the number "2" highlighted in red. The list below shows "0002 383 Annan" highlighted with a red box. Return Destination: The screen shows the "Return Destination" header and a list of destinations. The entry "0002 383 Annan" is highlighted with a red box.

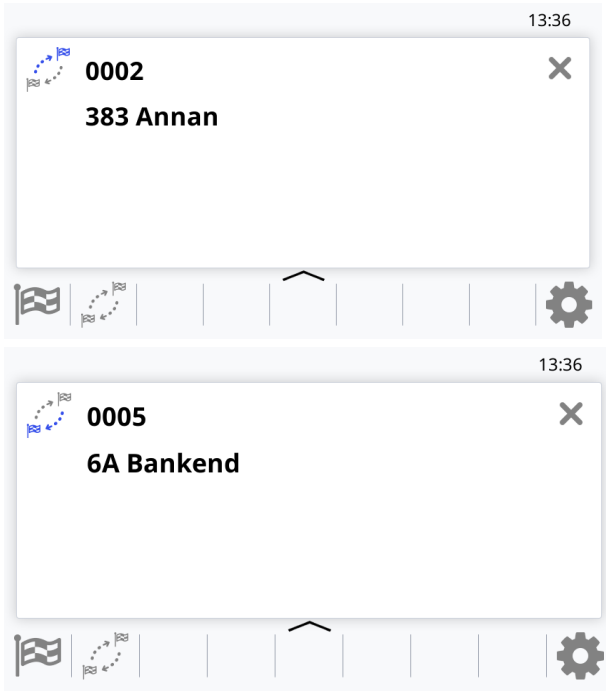
Step	Description	Figure
	<p>The following keyboard will be displayed. Tap “?123”.</p> <p>The following keyboard will be displayed. Enter 0005. “0005 6A Bankend” will be displayed. Tap “0005 6A Bankend” as the return destination.</p>	
3	<p>The outbound destination will be displayed as shown.</p> <p>Tap the screen and the return destination will be displayed as shown.</p> <p>Note: To stop the round trip feature, tap the cross (x) and the controller will revert to the initial screen.</p>	

Note: The destination highlighted is the currently selected destination.

3.4 Sign Self Test

The sign self test function tests all the destination displays connected to the EG4 destination controller and can be used to help determine the source of a problem i.e. hardware, address settings or programming.

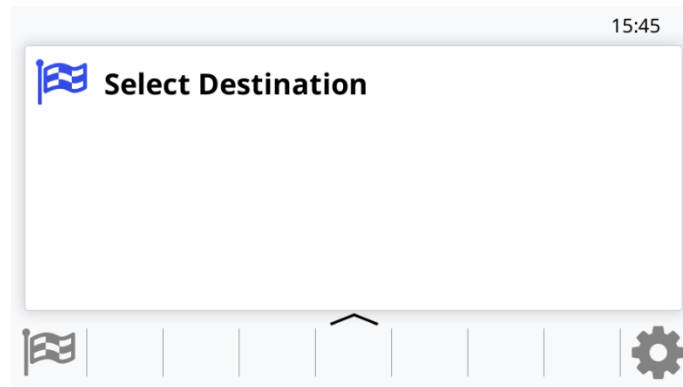

This function is accessed using the settings button () on the front panel of the destination controller.

It is shown as **Sign Self Test**:

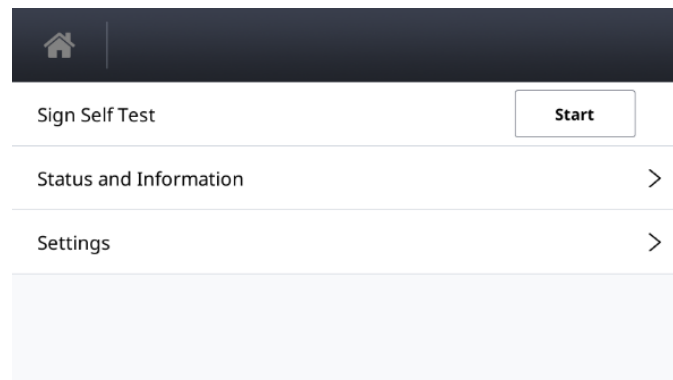

Selecting “Start” will start the sign test function.

The following message will then be displayed:

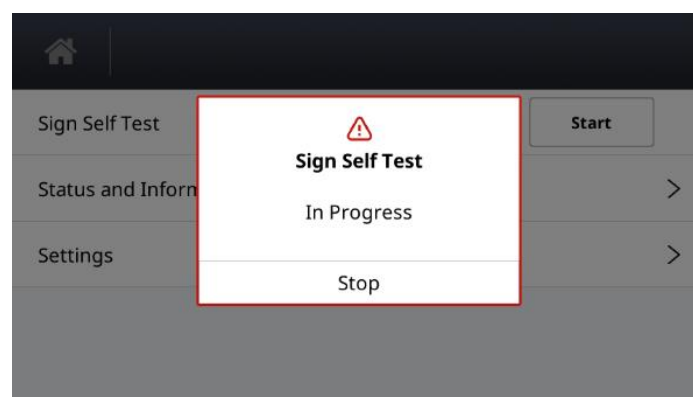

Selecting “Stop” will stop the sign test function.

During sign self test, the destination controller sends a message to all the connected destination displays for them to show a repeating test pattern. This test pattern verifies that the destination displays and controller are communicating with each other and that for LED destination displays, the individual LEDs are working correctly.

LED destination displays will show a scrolling message followed by an alternating test pattern (the content of the scrolling message is described below). There will be some variation in what is scrolled across the destination display, depending on firmware, display size etc., but the key areas will be the same.

Failure of this test sequence to appear indicates that power and / or communications are not present and / or cables may have been incorrectly connected.

Display test character string definition

LED destination displays will show scrolling text similar to that set out below, followed by a series of horizontal and vertical line test patterns:

Example: **OLED v1.39.00 X2.2 #0 160x24 C=3D10 P=10 /100 CRC=AE98**

OLED v1.39.00	= the destination display's base software type and version
X2.2	= application software version (Super X)
#0	= destination display address, set by the physical switch on the processor
160x24	= the destination display resolution (horizontal x vertical)
C=3D10	= destination display configuration (for Hanover internal use)
P= 10/100	= brightness parameters of the sign where the left value is the current brightness, and the right value is the maximum configured (max 100)
CRC=AE98	= firmware checksum (for Hanover internal use)

3.5 Start HTC Driver Menu

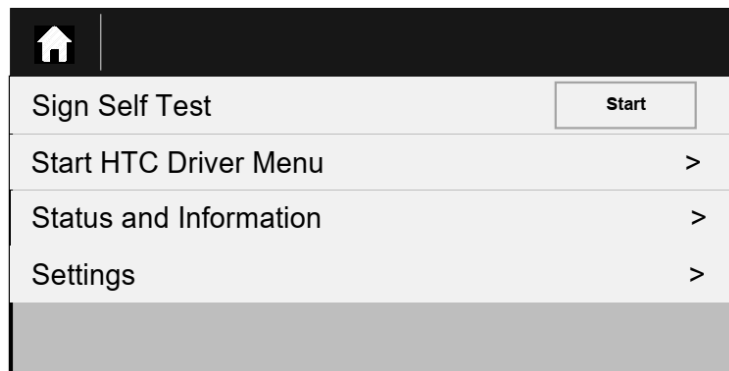

When enabled (via Hanover Central), 'Start HTC Driver Menu' will become visible on the home screen. This allows the driver to select the options to be made available:

- Simulation Menu. For more details, refer to [Appendix E-2: Simulation Menu](#).
- Volumes Menu. For more details, refer to [Appendix E-3: Volumes Menu](#).
- System Tests Menu. For more details, refer to [Appendix E-4: System Tests](#).
- Settings Menu. For more details, refer to [Appendix E-5: Settings Menu](#).

3.6 Status and Information

This function provides the profile ID of the destination controller, the status of the destination displays, network and all digital inputs/outputs connected to the destination controller.

It is shown as **Status and Information**:

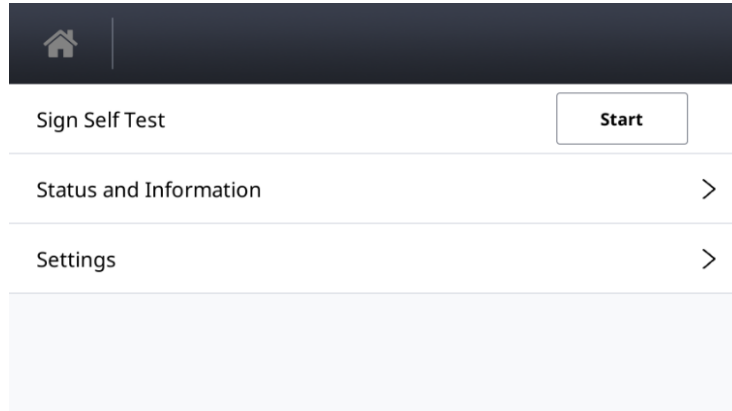

Selecting “Status and Information” will display the following:

Feature	Values
Database ID – name set in profile of destination controller config in HELEN (optional)	-
Controller Profile	Refer to 3.7.1.1 Controller Profile
Database Load Status – This is whether the database has been loaded successfully. Note: ‘OK’ shows it was loaded.	OK
Product Release	2.34.0
Configured Equipment Status – This is a list of devices which are configured in the destination list profile.	Refer to 3.6.1 Configured Equipment Status
Connected Equipment Status – This is what is physically connected to the destination controller.	Refer to 3.6.2 Connected Equipment Status
Digital I/O	Refer to 3.6.3 Digital I/O
Network Status	Refer to 3.6.4 Network Status
System Information	Refer to 3.6.5 System Information
Hardware Fitted	Refer to 3.6.6 Hardware Fitted
Runtime Statistics	Refer to 3.6.7 Runtime Statistics
Reboot Device – This will be displayed only if ‘Allow driver reboot’ is enabled in 3.7.2.4 Passcodes and Permissions .	Refer to 3.7.2.7 Reboot Device

3.6.1 Configured Equipment Status

This function shows the list of equipment that is configured within the profile along with the configured sign address.

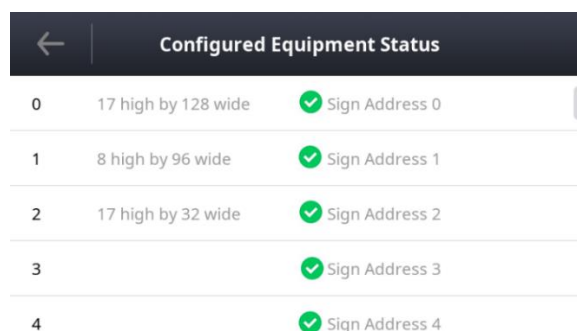

It is shown (for example):





3.6.2 Connected Equipment Status

This function shows the list of equipment such as on-board computers or destination displays connected to the system.

The status of the equipment will be as follows:

-  : connected equipment OK
-  : warning; equipment is currently not in use
-  : error related to connected equipment

It is shown (for example):

← Connected Equipment Status		
OBC1		>
SIGN1		>

3.6.3 Digital I/O

This function shows all the digital inputs and outputs of the destination controller.

Parameter	Description
Digital Input 0	Shows the use of digital input 0 and whether it is active or inactive. For more details, refer to 3.7.1.2 Digital I/O
Digital Input 1	Shows the use of digital input 1 and whether it is active or inactive. For more details, refer to 3.7.1.2 Digital I/O
Digital Input 2	Shows the use of digital input 2 and whether it is active or inactive. For more details, refer to 3.7.1.2 Digital I/O
Digital Output 0	Shows the use of digital output 0 and whether it is active or inactive. For more details, refer to 3.7.1.2 Digital I/O
Digital Output 1	Shows the use of digital output 1 and whether it is active or inactive. For more details, refer to 3.7.1.2 Digital I/O

3.6.4 Network Status

This function shows the status of the network connected to the system.

Parameter		Description
Ethernet (eth0) Ethernet (eth1)	IPv4 Address	Static IPv4 Address. The manually entered IP address the unit will use as its own address. Acceptable values of the format X.X.X.X where X can range from 0- 255
	Subnet Mask	Static subnet mask. The subnet mask associated with the unit for attempting to connect to the FTP server. Acceptable values of the format X.X.X.X where X can range from 0- 255
	Gateway	Static default gateway Acceptable values of the format X.X.X.X where X can range from 0- 255
	Data Traffic	The number of bytes transmitted and received on the port
	MAC Address	The MAC address of the Ethernet port
Vehicle ID		The unit ID assigned by the user to the unit that is used – to access the Wireless Data Manager back office server
FTP Server Address		The IP address (or URL) of the FTP server that the unit will attempt to connect to. Acceptable values of the format X.X.X.X where X can range from 0-255. Domain name can be specified for DNS lookup

Parameter	Description
FTP Server User Name	The username required to log into the FTP server

3.6.5 System Information

Feature
Product ID – This refers to the software variant. It would be EG4 for EG4 standard releases
Product Release – This is the software version number. For example: 1.10.0
Build Type – This is whether it is a release build or a development build of the software
Build Date – This is the date the software version was created
Machine name – This refers to the hardware. It would be hdl-eg4 for EG4
OS release – This is the name of the operating system on the EG4 (also includes version information)
OS version – This is the version number of the operating system on the EG4
Detailed Package Information – This provides version numbers of individual Hanover firmware modules loaded. This information may be requested by Hanover.
Board Serial Number - This is the serial number applied to the EG4 unit by Hanover at build time.

3.6.6 Hardware Fitted

The EG4 destination controller will display a list of all possible hardware options that can be supplied with the EG4. It will also indicate whether the hardware is fitted or not via a checkbox next to the hardware name. Below is a list of all the hardware options.

Feature	Values	
Hardware Fitted	<ul style="list-style-type: none"> • ambient_light_1 • can0 • dig_in0 • dig_in1 • dig_in2 • dig_out0 • dig_out1 • eth0 • eth1 • gps1 • ibis_master_1 • ibis_master_2 • ibis_slave_1 • ibis_slave_2 • j1708_2 • j1708_5 	<ul style="list-style-type: none"> • j1708_6 • lineout1 • mdm1 • odo1 • rs232_1 • rs232_2 • rs232_3 • rs485_1 • rs485_2 • rs485_3 • rs485_4 • rtc1 • rtc2 • speaker3 • wlan0 • wwan0

3.6.7 Runtime Statistics

Feature
RAM usage – This is how much RAM is available and how much is currently being used on the unit
Storage – This is how much space is available for storing data such as the destination database
Up time – This is how long the unit has been on for
CPU Loading – This is how much the CPU is being hammered

3.7 Settings to access other functions of the EG4

This function provides the information, configuration and language of the system.

It is shown as **Settings**:

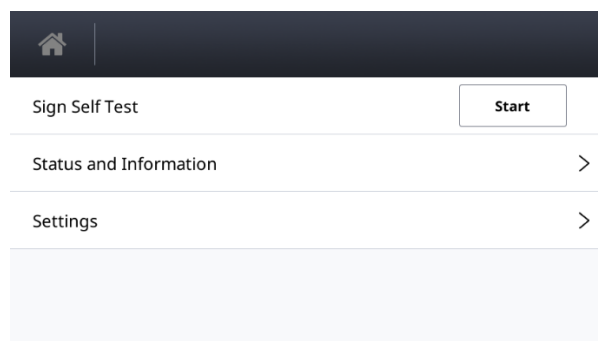

Selecting “Settings” will request a 4-digit passcode.

It is shown as **Passcode**:

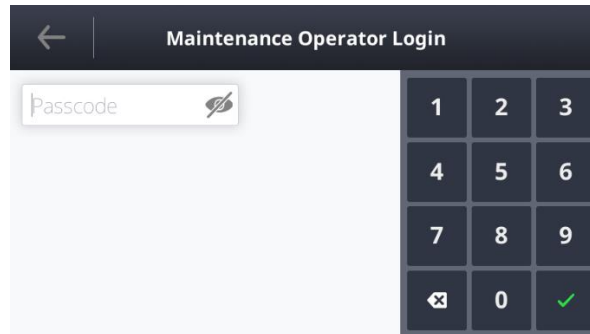

The 4-digit passcode is 9876 by default or if a factory reset is performed. However, if an EG4 is loaded with a list from HELEN, the passcode may be set to 0101 as HELEN has by default a passcode of 0101.

The passcode can be made visible by selecting the eye symbol ().

Once the 4-digit passcode is entered followed by the ✓ (green tick), the EG4 destination controller will show the following menu options:

- [3.7.1 System Configuration](#)
- [3.7.2 Console Management](#)

3.7.1 System Configuration

It is shown as **System Configuration**:

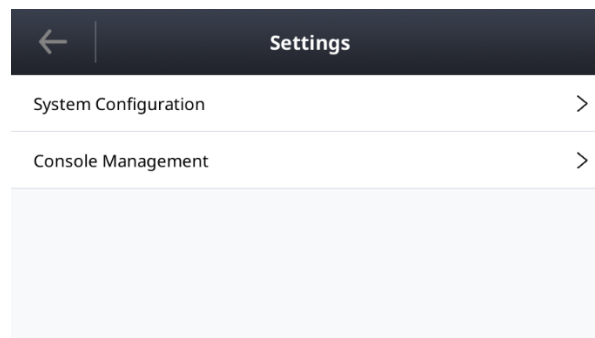

Selecting “System Configuration” will display the following options:

- [3.7.1.1 Controller Profile](#)
- [3.7.1.2 Digital I/O](#)
- [3.7.1.3 Serial Ports](#)
- [3.7.1.4 CAN Ports](#)
- [3.7.1.5 Connected Equipment](#)
- [3.7.1.6 Audio Settings](#)
- [3.7.1.7 Network](#)
- [3.7.1.8 Driver Display Control](#)

3.7.1.1 Controller Profile

HELEN provides a method for setting configuration parameters of the destination controller in order to make additional features available. Different settings can be applied to these features with different combinations saved as particular profiles. Up to 16 profiles can be configured. It allows a different profile to be set for each of several different 'sets' of vehicle destination displays - using just one database.

For more details, please refer to HELEN sign-editing software - Operating manual (ref. 540125).

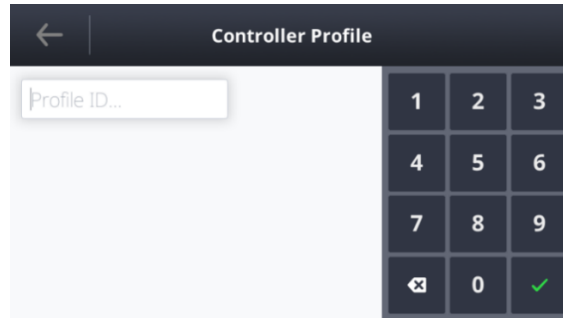

To set the profile of the EG4 destination controller, enter the profile ID using the keyboard followed by the ✓ (green tick).

3.7.1.2 Digital I/O

Feature		Values
Digital Input 0 Digital Input 1 Digital Input 2 Note: See below for more details about the three external inputs*.	Use	<ul style="list-style-type: none"> • Undefined (Default) • Bus Stopping • Bus Reversing • Emergency Message • Priority Info Message • VOX Destination • Battery Guard • Power Save⁴ • Destination ID • Destination Announcement^{5a} • Information Announcement^{5b} • Stop Announcement⁶ • Info Message • Door Switch • Assistance Request
	Activation type	<ul style="list-style-type: none"> • Latched • Unlatched (Default) • Toggle
	Active sense	<ul style="list-style-type: none"> • Low • High (Default)
	Reset type ^{6a}	<ul style="list-style-type: none"> • Undefined (Default) • No Override – Reboot only • Manual Override • Remote Override • Manual or Remote Override
Digital Output 0 Digital Output 1	Use	<ul style="list-style-type: none"> • Undefined (Default) • Bus Stopping • Bus Reversing • Audio Amp • Function 0 • Function 1
	Active mode	<ul style="list-style-type: none"> • Normal (Default) • Inverted

*Three external inputs can be accommodated using the I0, I1 and I2 settings which are connected directly into the 18-way mini fit connector.

Note: Please ensure that pair of pins 6 and 14, pair of pins 7 and 16 and pair of pins 5 and 15 of the 18-way mini fit connector correspond to the correct external input (I0, I1 or I2) in HELEN software:

- Pair of pins 6 and 14 (digital input 0 of EG4) correspond to external input I0 in HELEN software
- Pair of pins 7 and 16 (digital input 1 of EG4) correspond to external input I1 in HELEN software
- Pair of pins 5 and 15 (digital input 2 of EG4) correspond to external input I2 in HELEN software

⁴ For more details on the power save, refer to [7\) Power Save](#).

^{5a} ^{5b} ⁶ For more details on the announcement, refer to [6\) Audio announcement](#) and [3.7.1.6 Audio Settings](#).

^{6a} 'Reset type' will be displayed when 'Emergency Message' is selected for use as digital input.

The available I0, I1 and I2 values (in HELEN software) and their uses are described in the following table:

I0, I1 or I2 Values	Use for	Refer to
1	Emergency message (latched)	Emergency message
1A		
1B		
1C		
2	Emergency message (latched (inverted))	
3	Emergency message (unlatched) or Bus reversing	Emergency message or Displaying 'Bus reversing'
4	Emergency message (unlatched (inverted))	Emergency message
5	Blanking (battery guard)	Blanking the destination display (battery guard)
6	Blanking (battery guard) (inverted)	
7	Bus stopping	Displaying 'Bus stopping'
8	Bus stopping (inverted)	
9	Emergency message (toggle)	Emergency message
10	Emergency message (toggle (inverted))	
IN	Information message	Information message
INI	Information message (inverted)	
BR	Bus reversing	Displaying 'Bus reversing'
BRI	Bus reversing (inverted)	
AUD	Audio announcement	Audio announcement
PST	Power Save	Power Save

1) Emergency message

In the example below, destination code 0001 (destination 10A City Center) and the emergency message will be displayed on the EG4.

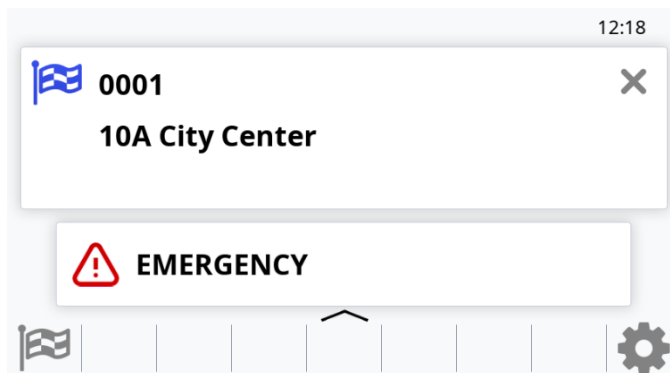

Setting I0, I1 and I2 to the values 1, 1A, 1B, 1C, 2, 3, 4, 9 and 10 are all for emergency messages. When the input is activated, the message (for example, "Emergency - Call Police") associated with a particular destination code is shown on the destination displays. By default, this is 9999, or (0000 9999 for route browse). This code can be changed by adding the parameter EC = nnnn to the database configuration, where nnnn is the preferred emergency destination code. This is done in HELEN via the Extensions box on the Advanced tab of a particular profile in 'Controller Config'.

By not setting a driver's message for this emergency destination, the driver's destination controller screen will not change from the previous destination when the input is activated, although the destination displays will. The user may decide that this is preferable if, for example, the driver is being threatened or is under attack.

Note: Value 3 is being mainly used for bus reversing. However, the bus reversing function can now be set using the values BR or BRI (refer to [Displaying 'Bus reversing'](#)).

I0, I1 or I2 Value	Meaning	Description
1	latched	When the input is activated (volts on input), the emergency destination will remain, even if the input is deactivated. The destination must be manually reset.
1A	latched	Emergency message can be cancelled by a manual destination change.
1B	latched	Emergency message can be cancelled by a remote destination change.
1C	latched	Emergency message can be cancelled by both manual and remote destination change.
2	latched (inverted)	As above but input sensing is inverted (volts = inactive; no volts = active).
3	unlatched	Once the input is activated (volts on input), the emergency destination will remain for only as long as the input remains active.
4	unlatched (inverted)	As above but input sensing is inverted (volts = inactive; no volts = active).
9	toggle	Activating the input momentarily will set the emergency destination: activating it again will cancel it.
10	Toggle (inverted)	As above but input sensing is inverted (volts = inactive; no volts = active).

2) Blanking the destination display (battery guard)

Setting I0, I1 and I2 to the values 5 and 6 are for blanking the destination display (designed to save battery life). When the input is activated, the destination controller works as normal. When deactivated, the destination displays will be blanked after a time delay set by configuration parameter BT = n where n is in minutes (default n = 0).

Another parameter BL, meaning Blanking Level expressed as a percentage (0 (by default) means maximum brightness, 1 means minimum brightness and 2-99 means actual maximum brightness) sets the brightness of exterior LED displays during the BT-defined time delay period.

I0, I1 or I2 Value	Meaning	Description
5	blanking	When inactive (no volts), destination displays will be blanked after period BT.
6	blanking (inverted)	As above but input sensing is inverted (volts = inactive; no volts = active).

Blanking the destination display in this way should not be confused with the 'Blank code' facility, which is a destination code set within HELEN that defines what is shown on an otherwise blank destination display - for example, if a non-existent code is selected or the destination controller is set to an idle state. For more details, please refer to the HELEN sign-editing software - operating manual (ref. 540125). However, the destination defined by that code will also be shown during the BT-defined delay described above.

3) Displaying 'Bus stopping'

In the example below, destination code 0001 (destination 10A City Center) and the bus stopping message will be displayed on the EG4.

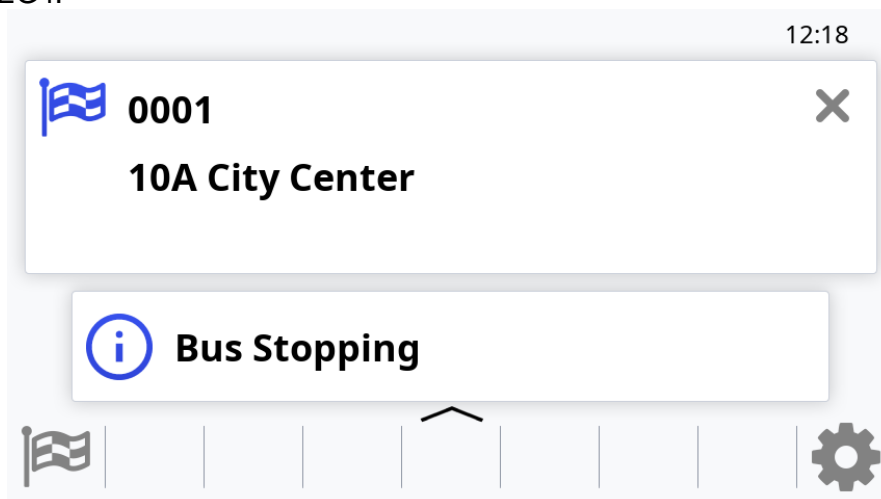

Setting I0, I1 and I2 to the values 7 and 8 are to set up 'Bus stopping' on a destination display. On activation, in-bus destination displays will automatically show 'Bus stopping', overriding the previous message.

Alternatively, the 'bus stopping' message can be programmed for in-bus destination displays under a destination code containing the two characters 'BS' - for example: BS01 (or BS00000001) or 0000 BS01 for route browse.

In both cases, the parameter LN = n must be used to indicate the number allocated to the in-bus destination display, where n is any of the values provided in destination display options.

I0, I1 or I2 Value	Meaning	Description
7	bus stopping	Whilst the input is active (volts on input), the in-bus destination display will show the programmed message.
8	bus stopping (inverted)	As above but input sensing is inverted (volts = inactive; no volts = active).

4) Information message

Values IN and INI are for information messages. An information message is selected on activation of the external input, having been set up within the HELEN database in a similar way to a destination message.

The message is enabled by adding the parameter IC = nn, where nn = 01 - 99. This is done in HELEN via the Extensions box on the Advanced tab of a particular profile in 'Controller Config.' (nn corresponds with the message number in the HELEN database).

I0, I1 or I2 Value	Meaning	Description
IN	information	Whilst the input is active (volts on input) the information message will be selected.
INI	information (inverted)	As above but input sensing is inverted (volts = inactive; no volts = active).

5) Displaying 'Bus reversing'

Values BR and BRI are for 'Bus reversing'. The bus reversing message is programmed under a destination code whose most significant two characters are 'BR' - for example: BR01 (or BR00000001) or 0000 BR01 for route browse.

The destination code should only contain a message for the destination displays which are to show it, i.e. if the front destination display is not to change, no message content should be entered for the front destination display for this destination.

I0, I1 or I2 Value	Meaning	Description
BR	bus reversing	Whilst the input is active (volts on input), the destination displays will show the programmed message.
BRI	bus reversing (inverted)	As above, but input sensing is inverted (no volts = active).

Note: The bus reversing message can also be set using a destination code of 9999 (please refer to [Emergency message](#)).

6) Audio announcement

In the example below, destination code 0001 (destination 115 Ae Village) is displayed on the EG4 and the appropriate audio announcement (available file format in mp3) will be played on the speakers.

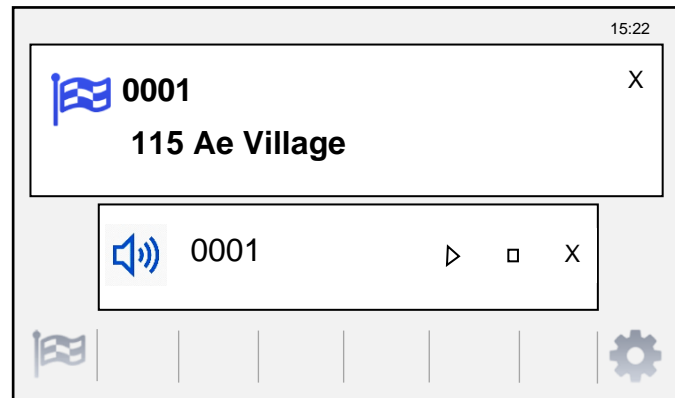

i. Preparing the audio file(s)

All audio files must be in the following format(s) and parameters:

- MP3 file format
- Between 96kbps and 144kbps
- Destination code

If requiring to make audio announcements based on the destination code that has been selected then, the audio files will need to be named as the destination code. For example: destination 0001 will require an audio file to be named 0001.mp3.

- Information code

If requiring to make audio announcements based on the information message code that has been selected then, the audio files will need to be named as the information code number. For example: information message 25 will require an audio file to be named 25.mp3.

The EG4 uses a USB flash memory drive to load/update audio file(s) via its USB port. The USB flash memory drive must be formatted to use the FAT32 file system.

ii. Preparing the USB flash memory drive

Prepare the USB flash memory drive as follows:

Step	Description
1	Insert the USB flash memory drive into the PC. It appears as USB DRIVE (D:) . Note: The name and drive letter are variable and in this case, the drive letter allocated to the USB flash memory drive by the PC is 'D:'.
2	Create the following location on the USB: <p style="text-align: center;">/hanover/media</p>

iii. Loading the audio file(s) to the USB flash memory drive

Load the audio file(s) to the USB flash memory drive as follows:

Step	Description
1	Save the audio file(s) on the USB in the location created in above step 2.
2	'Safely remove' the USB flash memory drive from the PC. To do so, look for "Safely remove Hardware" icon on the taskbar. Right-click the icon and select the hardware you want to remove.

iv. Loading the audio file(s) to the EG4

Transfer the audio file(s) from the USB flash memory drive to the EG4 as follows:

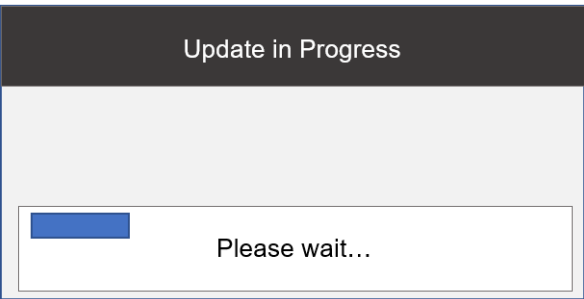
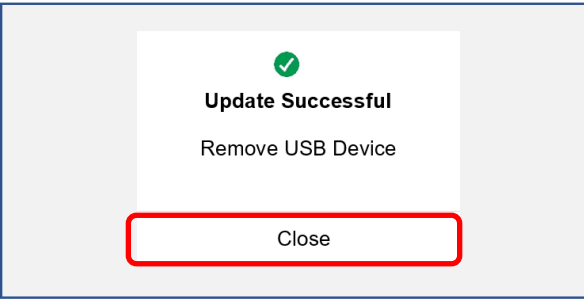
Step	Description	Figure
1	Insert the USB flash memory drive into the port in the front of the destination controller.	
2	The EG4 will automatically find the audio file(s) – the destination controller will transfer and save the database.	
3	When update is complete, the destination controller will display "Update Successful" and "Remove USB Device". Tap "Close" and the USB flash memory drive can be removed. The audio file(s) have been updated on the EG4.	

7) Power Save

Note: EG4 unit should be fitted with wake-logic hardware.

Digital input 2 should be configured as I2=PS/PSI to indicate the vehicle ignition state.

'Power Save' should be triggered whenever the vehicle ignition is OFF.

3.7.1.3 Serial Ports

This setting allows a different comms protocol to be set for each port for use with the destination display.

An example of 'Serial Ports' screen is as shown:

Serial Ports	
Port 1	-STOPPING-SIGN,DASH,HANCLIS,ROUTE,SIGN >
Port 2	None >
Port 3	None >
Port 4	None >
Port 5	None >

Note: A Hanover protocol can be assigned to an Ethernet port via the port options of the destination controller.

The list of protocols available on the EG4 destination controller is provided in [Appendix B: Serial Ports](#).

Note: Destination controllers are not necessarily supplied with every possible protocol enabled.

For more details about any protocol, please contact [Hanover Technical Support](#).

1) Port Mapping

It is possible to map a port to another port on the EG4. This allows the user to physically connect a serial device to the EG4 on a particular port and have the protocol attached on another port. The main reason for this is to ensure backwards compatibility with the ERIC++ and EG3 destination controllers.

The EG4 has an additional fixed RS485 or J1708 port on port 2. On an ERIC++ or EG3, this would be an option on port 4 or 5. It is therefore possible to use the standard port 2 physically to connect to the port and in the software to map to port 4 or 5. This will therefore allow the user to maintain the same destination list on the EG4 and ERIC++/EG3 destination controllers.

Setting Up the Port Mapping via HELEN Software

In the HELEN advanced parameter text box, enter the following parameter:

MP_x=y

where: x = the physical port the serial connection is wired to

y = the port the protocol is set to

For example: MP₂=4 means the protocol is set to port 4 but is physically wired into the EG4 on port 2.

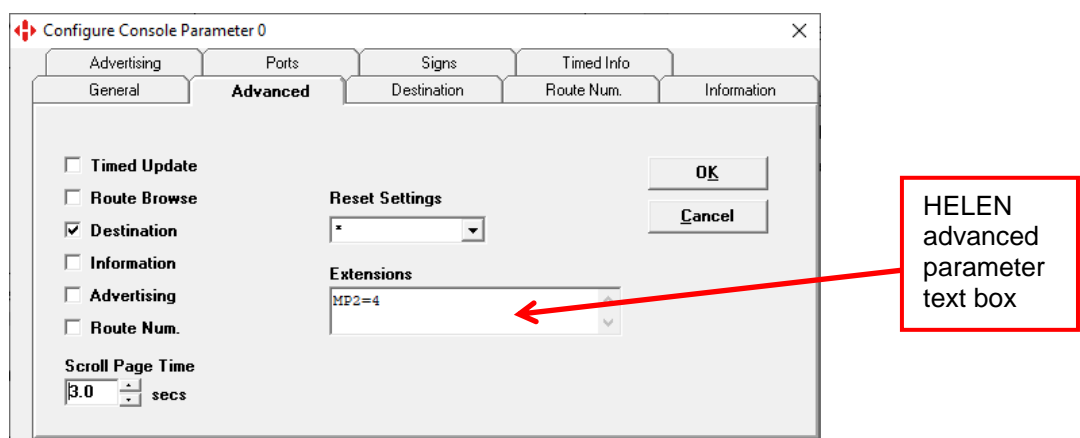

Viewing the Port Mapping on the EG4

To view the port mapping assigned directly to the EG4, the procedure will be as follows:

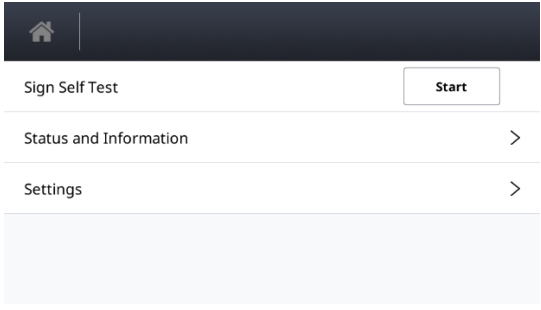
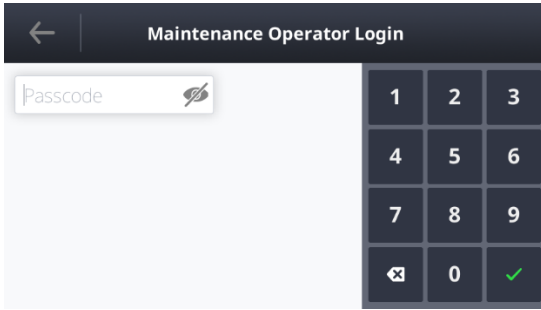
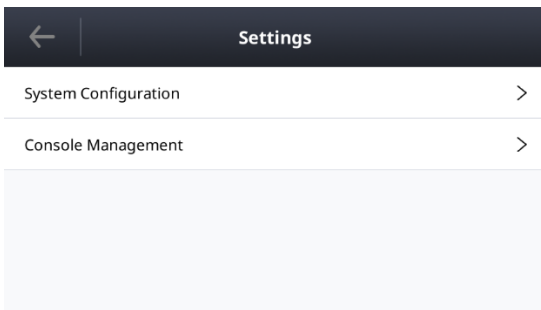
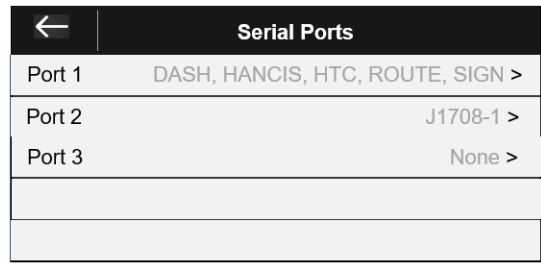
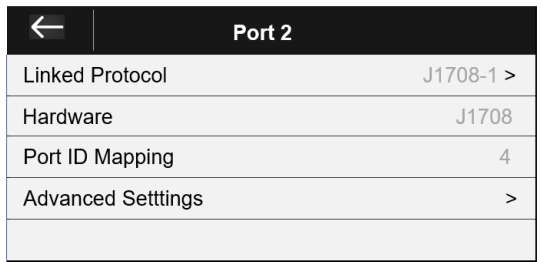
Step	Description	Figure								
1	Select 'Settings'.	 <p>The screenshot shows a dark header with a home icon. Below it, there are three menu items: 'Sign Self Test' with a 'Start' button, 'Status and Information' with a right arrow, and 'Settings' with a right arrow.</p>								
2	Enter the 4-digit passcode followed by the ✓ (green tick).	 <p>The screenshot shows a dark header with a back arrow and the text 'Maintenance Operator Login'. Below the header is a 'Passcode' input field with a clear icon. To the right is a numeric keypad with buttons for digits 1-9, 0, and a green checkmark.</p>								
3	Select 'System Configuration' followed by 'Serial Ports'.	 <p>The screenshot shows a dark header with a back arrow and the text 'Settings'. Below the header are two menu items: 'System Configuration' with a right arrow and 'Console Management' with a right arrow.</p>								
4	Select the physical port that is connected (not the port to which the protocol is assigned). In our example: as MP2=4 was set up in HELEN, so Port 2 will be selected.	 <p>The screenshot shows a dark header with a back arrow and the text 'Serial Ports'. Below the header is a list of three ports:</p> <table border="1"> <tr> <td>Port 1</td> <td>DASH, HANCIS, HTC, ROUTE, SIGN ></td> </tr> <tr> <td>Port 2</td> <td>J1708-1 ></td> </tr> <tr> <td>Port 3</td> <td>None ></td> </tr> </table>	Port 1	DASH, HANCIS, HTC, ROUTE, SIGN >	Port 2	J1708-1 >	Port 3	None >		
Port 1	DASH, HANCIS, HTC, ROUTE, SIGN >									
Port 2	J1708-1 >									
Port 3	None >									
5	The 'Port ID Mapping' shows the port that is mapped. <ul style="list-style-type: none"> Port 4 is the port the protocol is set to Port 2 is the physical port the serial connection is wired to 	 <p>The screenshot shows a dark header with a back arrow and the text 'Port 2'. Below the header is a list of configuration items:</p> <table border="1"> <tr> <td>Linked Protocol</td> <td>J1708-1 ></td> </tr> <tr> <td>Hardware</td> <td>J1708</td> </tr> <tr> <td>Port ID Mapping</td> <td>4</td> </tr> <tr> <td>Advanced Settings</td> <td>></td> </tr> </table>	Linked Protocol	J1708-1 >	Hardware	J1708	Port ID Mapping	4	Advanced Settings	>
Linked Protocol	J1708-1 >									
Hardware	J1708									
Port ID Mapping	4									
Advanced Settings	>									

3.7.1.4 CAN Ports

Feature	Values
Linked Protocol – Specifies what protocols to connect to the CAN. It monitors the battery state of charge for display on signs and UI.	STATE-OF-CHARGE
KBit Rate – Communication speed in kilo-bits per second.	10, 20, 50, 125, 250, 500, 800, 1000
Loop back – Indicates whether the CAN should loop-back the communications to the sender. Usually only enabled to test the correct operation of the CAN.	<ul style="list-style-type: none"> • Disabled (Default) • Enabled
Listen Only – Specifies that the CAN device should only receive data and never send. Due to the possible safety and standard implications, only disable this under the advice of Hanover Technical Support .	<ul style="list-style-type: none"> • Disabled • Enabled (Default)

3.7.1.5 Connected Equipment⁷

Feature	Values
Communications – This will allow the user to set the current configuration as valid when the destination display configuration of the bus is changed and verified by the destination display test confirming the destination controller has communications to all destination displays connected. Useful for e.g. if the user has removed a destination display from the vehicle and he does not want the destination controller to continually report an error for missing destination display.	[x] where x is the number of destination displays currently configured on the vehicle
Sign Brightness – This will allow the user to set the destination display brightness level of all the destination displays connected to the system	0 to 100% (100% by default)
Blanking Level ⁸ – Brightness limit of destination displays during BT-defined period following which, destination displays go blank - please refer to Blanking the destination display (battery guard)	0 to 100 (100 by default)
Blanking Timeout ⁹ (minutes) – Blanking timer in minutes (used with battery guard feature - please refer to section Blanking the destination display (battery guard))	0 to 100 (0 by default)
Address Mappings – This will allow to map a destination display address (HCP address) to a database destination display index	Refer to 1) Address Mappings
State of Charge Destinations – This is a list of destinations which are used when displaying the different states during the charging of electric vehicles (SoC).	Display of keyboard to add new destination id
Continue Updates on Inactive – Destination display data will continue to be sent to the destination displays even when the EG4 stops receiving communication from the destination displays.	<ul style="list-style-type: none"> • Disabled (Default) • Enabled

Feature	Values
Virtual HTC Terminal – This will allow to access the menus of the virtual HTC. It should only be enabled if the virtual HTC component has been enabled.	<ul style="list-style-type: none"> • Disabled (Default) • Enabled
Virtual HTC Port Number – This identifies the end point connection that the EG4 components use to communicate with the virtual HTC component. It is advisable to not modify this value unless instructed by Hanover Technical Support .	Keyboard display to enter port number
Firmware update baud rate – The communications baud rate used for updating sign firmware from the EG4 over serial communications channel.	2400, 4800, 9600, 19200, 38400, 57600 (Default), 115200

1) Address Mappings

Feature		Values
Address 0	Mapping	NOT_USED
Address 1		DESTINATION_SIGN (Default)
Address 2		ADVERT_SIGN
Address 3		HANVOX
Address 4		ONBOARD_COMPUTER
Address 5		ROUTE_NUMBER_SIGN
Address 6		DASH_SIGN
Address 7		BUS_STOPPING_SIGN
Address 8		NEXT_STOP_SIGN
Address 9		
Address 10	Accept Info Messages	<ul style="list-style-type: none"> • Reject • Accept (Default)
Address 11	Extra Configuration	Keyboard display
Address 12		
Address 13		
Address 14		

⁷ Setting a value of 0 for a Sign Settings' feature will disable this feature.

⁸⁹ This can be set via HELEN by adding the appropriate parameter. Refer to [Appendix F](#).

3.7.1.6 Audio Settings

- Destination

Feature			Description
Audio Output 0 Audio Output 1	Use	Destination	Announcement ¹⁰ This will allow the user to select how the audio announcement would be played. The options available are: <ul style="list-style-type: none"> • Automatic • Triggered (Default)
			Repeat Message This will allow the user to select the repeat of the message. The options available are: <ul style="list-style-type: none"> • Disabled (Default) • Enabled
			Repeat Period ¹¹ (s) This will allow the user to set the repeat of the message during a defined period. 1 – 60
			Audio Interrupt ¹² This will allow the audio file to be interrupted as soon as the trigger is no longer active. The options available are: <ul style="list-style-type: none"> • Disabled (Default) • Enabled
	Volume	Setting ¹³	This will allow the user to set the volume of the audio announcement and to play an audio test. 0 to 100%.
	Playback Start Delay ¹⁴ (ms)		This is the amount of time between the trigger being active and the audio file playing. 0 – 5000

¹⁰ ¹¹ ¹² ¹³ ¹⁴ This can be set via HELEN by adding the appropriate parameter. Refer to [Appendix F](#).

- Information

Feature			Description
Audio Output 0 Audio Output 1	Use	Information	Announcement ¹⁵ This will allow the user to select how the audio announcement would be played. The options available are: <ul style="list-style-type: none"> Automatic Triggered (Default)
			Repeat Message This will allow the user to select the repeat of the message. The options available are: <ul style="list-style-type: none"> Disabled (Default) Enabled
			Repeat Period ¹⁶ (s) This will allow the user to set the repeat of the message during a defined period. 1 – 60
			Audio Interrupt ¹⁷ This will allow the audio file to be interrupted as soon as the trigger is no longer active. The options available are: <ul style="list-style-type: none"> Disabled (Default) Enabled
	Volume	Setting ¹⁸	This will allow the user to set the volume of the audio announcement and to play an audio test. 0 to 100%.
	Playback Start Delay ¹⁹ (ms)		This is the amount of time between the trigger being active and the audio file playing. 0 – 5000

^{15 16 17 18 19} This can be set via HELEN by adding the appropriate parameter. Refer to [Appendix F](#).

3.7.1.7 Network²⁰

Feature		Description	
Connections	Add new network connection...	Linked Protocol	This provides a list of all available communication protocols which can be sent over a network connection.
		IP Address	This is the IP address of the external device which the Eg4 is connecting to.
		Port Number	This is the port number that the EG4 can communicate with the external device
		Transport	This is the protocol setting for the new connection. The options available are: <ul style="list-style-type: none"> • UDP (Default) • TCP
		Mode	This is where to select between the EG4 operating in server or client mode: <ul style="list-style-type: none"> • Server (Default) – This is set when the EG4 is the server and external devices are initiating the connection to the EG4 • Client – This is set when the EG4 is the client and the EG4 is initiating the connection to a server
Network Interfaces	<ul style="list-style-type: none"> • Ethernet (eth0) • Ethernet (eth1) 	Interface	This will enable or disable the Ethernet interface. The options available are: <ul style="list-style-type: none"> • Disabled • Enabled (Default)
		Mode	This configures the Ethernet port to be either DHCP (the unit will attempt to connect to a DHCP server to obtain an IP address for the unit), a Static IP address or a SERVER. The options available are: <ul style="list-style-type: none"> • DHCP (Default) • STATIC • SERVER
		IP Address	Note: This is only valid when Mode is set to “STATIC” or “SERVER”. Static IPv4 Address. The manually entered IP address the unit will use as its own address. Acceptable values of the format X.X.X.X where X can range from 0- 255.
		Subnet Mask	Note: This is only valid when Mode is set to “STATIC” or “SERVER”. Static subnet mask. The subnet mask associated with the unit for attempting to connect to the FTP server. Acceptable values of the format X.X.X.X where X can range from 0- 255.

²⁰ All network parameters can be set in the Config.ini file. Refer to [Appendix C](#).

Feature		Description
Network Interfaces	<ul style="list-style-type: none"> Ethernet (eth0) Ethernet (eth1) 	Gateway Note: This is only valid when Mode is set to “STATIC” or “SERVER”. Static default gateway Acceptable values of the format X.X.X.X where X can range from 0- 255. When an EG4 is required to access the internet, a gateway IP address may be required to be specified.
		Lease Start Note: This is only valid when Mode is set to “SERVER”. This is where the Start IP address is entered.
		Lease End Note: This is only valid when Mode is set to “SERVER”. This is where the End IP address is entered.
		DNS Servers If FTP_Server_IP is given in the form of a URL and needs to be resolved by DNS, the DNS Server Address must be configured (unless this address is to be provided by DHCP). Acceptable values of the format X.X.X.X where X can range from 0-255. Note: This is only required when the destination controller is using a fixed IP address.
	Wireless (wlan0)	Interface This will enable or disable the Wireless interface. The options available are: <ul style="list-style-type: none"> Disabled (Default) Enabled
		Wi-Fi Access Points This is where a network ssid can be entered for e.g my_wifi. Then, the following parameters will be displayed: <ul style="list-style-type: none"> Passphrase Hidden network (No or Yes) Priority Forget network
		Mode This configures the Wireless port to be either DHCP (the unit will attempt to connect to a DHCP server to obtain an IP address for the unit) or a Static IP address. The options available are: <ul style="list-style-type: none"> DHCP (Default) Static
		IP Address Note: This is only valid when Mode is set to “Static”. Static IPv4 Address. The manually entered IP address the unit will use as its own address. Acceptable values of the format X.X.X.X where X can range from 0- 255
		Subnet Mask Note: This is only valid when Mode is set to “Static”. Static subnet mask. The subnet mask associated with the unit for attempting to connect to the FTP server. Acceptable values of the format X.X.X.X where X can range from 0- 255.

Feature		Description	
Network Interfaces	Wireless (wlan0)	Gateway	<p>Note: This is only valid when Mode is set to “Static”. Static default gateway Acceptable values of the format X.X.X.X where X can range from 0- 255. When an EG4 is required to access the internet, a gateway IP address may be required to be specified.</p>
		DNS Servers	<p>If FTP_Server_IP is given in the form of a URL and needs to be resolved by DNS, the DNS Server Address must be configured (unless this address is to be provided by DHCP). Acceptable values of the format X.X.X.X where X can range from 0-255.</p> <p>Note: This is only required when the destination controller is using a fixed IP address.</p>
	GSM Modem (wwan0)	Interface	<p>This will enable or disable the GSM Modem interface. The options available are:</p> <ul style="list-style-type: none"> • Disabled (Default) • Enabled
		Access Point Name (APN)	Access point name required by some service providers.
		User name	Username used when the service provider requires authentication.
		Password	Password used when the service provider requires authentication.
	SIM PIN	Mobile SIM card PIN required when a lock code is applied to the SIM card.	
Wireless Data Manager Client	Vehicle ID		The unit ID assigned by the user to the unit that is used
	Server Address		<p>The IP address (or URL) of the FTP server that the unit will attempt to connect to.</p> <p>Acceptable values of the format X.X.X.X where X can range from 0-255.</p> <p>Domain name can be specified for DNS lookup.</p>
	Username		The username required to log into the FTP server
	Password		The password required to log into the FTP server
	FTP Mode		To select between ACTIVE or PASSIVE mode.
	Manifest Folder		<p>This is the directory into which the unit will first look when it logs onto the FTP server. The unit will look for its manifest files in this folder. The manifest files tell the unit where on the server to look for data files (such as the database or a firmware file).</p> <p>By default, this location is /vehicle/.</p>

Feature		Description
Wireless Data Manager Client	Payload Folder	<p>This directory will be added at the beginning of the default payload directory that the unit will connect to and download the data file. If empty, then this will operate as default and no directory changes will be made</p> <p>By default, this location is /payloads/.</p>
	Log Folder	<p>This is the sub-directory into which the unit will place any log files. The log files are the mechanism by which the unit communicates its update progress back to the remote downloading application.</p> <p>By default, this location is /log/.</p>
	Payload Types Allowed	<p>This is a list of all the possible payloads which the EG4 will accept from the Hanover Wireless Data Manager software. The options available are:</p> <ul style="list-style-type: none"> • DB_FILE – This is the Hanover destination list • FONT_FILE – This is the fonts file • CONSOLE_FIRMWARE_FILE – This is the firmware file of the EG4 • CONSOLE_CONFIG_FILE – This is the network configuration file
	Download Interval	<p>This is the amount of time in seconds that the unit should leave between attempting to connect to the FTP server – value must be numerical.</p>
	IP Address Mandatory	<p>This allows the unit to only attempt to connect to the Wireless Data Manager back office server if it has an IP address.</p> <p>The options available are:</p> <ul style="list-style-type: none"> • Disabled (Default) • Enabled
	Controlled Destination IDs	<p>This allows the user to enter specific route/destination codes which must be set for the unit to download any files from Hanover Wireless Data Manager.</p>
	Time of Day Enabled	<p>This allows Wireless Data Manager to connect to the back-office server at a specified time of day.</p> <p>The options available are:</p> <ul style="list-style-type: none"> • Disabled (Default) • Enabled
	Time of Day Start/End	00:00 – 00:00

3.7.1.8 Driver Display Control

1) Common

Feature	Values
Change Priority - This is a way of specifying the way the driver-entered destinations can override remote commands and vice-versa.	<ul style="list-style-type: none"> • Change by driver only²¹ (Default) – This will only allow the EG4 to be controlled via manual entry. • Driver overrides any remote²² – This will allow the driver to override any destinations/routes/info codes set via a remote device. • Remote overrides the driver²³ – This will allow the remote device to always override any destinations/route/info codes set manually. • Remote priority with temporary local override²⁴ – This will allow a manually entered destination/route/info code to be temporarily overridden. If the remote device sets a new code then this will override the manual entry. • Remote priority / Inhibit idle²⁵ – Remote overrides the driver and the remote is not able to set the EG4 to idle. • Remote / Inhibit idle / Temp²⁶ – Remote priority with temporary local override and the remote is not able to set the EG4 to idle.
Startup Action	<ul style="list-style-type: none"> • All cleared²⁷ – The EG4 will always boot up in Idle mode. • Last value is restored²⁸ (Default) – The EG4 will always boot up and display the last set destination/route/info code. • Last value set by driver is restored²⁹ – The EG4 will always boot up and display the last manually set destination/route/info code. When the remote management mode is configured to “remote overrides the driver entry”, it is still possible to set the “Startup action” to remember what the driver has entered. But it will actually only allow the driver to enter a destination if the remote has cleared the destination to the idle state. • Last value set by remote is restored³⁰ – The EG4 will always boot up and display the last remotely set destination/route/info code.

^{21 22 23 24 25 26 27 28 29 30} This can be set via HELEN by adding the appropriate parameter. Refer to [Appendix F](#).

2) Destination³¹

Feature	Values
Control of Destinations Display – This allows the operator to give permission for the bus driver to set the destination code	<ul style="list-style-type: none"> • Deny • Allow (Default)
Selection Style – This is how the user can enter the destinations	<ul style="list-style-type: none"> • Enter by Number (Default) • Browse from List
Operation on Time-out – This allows to select what happens when the EG4 times out while selecting an option	<ul style="list-style-type: none"> • Use defaults (Default) • Reject setting • Use last value
Destination Completion Time-out (mS) – <ul style="list-style-type: none"> • This shows how long the destination controller will wait for a corresponding destination code after receiving a route code. If no corresponding destination code is received, then the destination controller will try to match the route code against the current destination code. If this does not form a valid route/destination, then the route code is rejected. • This shows how long the destination controller will wait for a corresponding route code after receiving a destination code. If no corresponding route code is received, then the destination controller will try to match the destination code against the current route code. If this does not form a valid route/destination, then the destination code is rejected. 	0 to 10000 (250 by default)
Default Route for Remotes - This is the default route code	Display of keyboard to edit default route code
Default Destination for Remotes – This is the default destination code	Display of keyboard to edit default destination code
Round trip ³² – This allows to enter an outbound and return destination.	<ul style="list-style-type: none"> • Disable (Default) • Enable
Destination Freeze - This will 'freeze' the currently active destination on external signs. This allows the testing/commissioning of internal signs and announcements. The user selects the required destination to freeze on the external sign (e.g. Not in Service) then selects the Freeze icon. The User Interface indicates the destination is frozen and the user is free to change the destination without the external sign being updated. Clearing the destination will also clear the freeze.	<ul style="list-style-type: none"> • Disable (Default) • Enable

³¹ Setting a value of 0 for a Destination's feature will disable this feature.

³² This can be set via HELEN by adding the appropriate parameter. Refer to [Appendix F.](#)

3) Messages

Feature	Values
Control of Messages Display	<ul style="list-style-type: none"> Deny Allow (Default)
Clear on Destination Change - Enabling this option will clear any currently active information messages whenever the destination is changed.	<ul style="list-style-type: none"> Disable (Default) Enable
Info without Destination - Enabling this option allows information messages to be displayed without the requirement of a destination being currently active.	<ul style="list-style-type: none"> Not Allowed (Default) Allowed Allowed with Blank Code
Multiple Messages	<ul style="list-style-type: none"> Deny (Default) Allow

4) HTC Hot Key

Feature	Values
HTC Hot Key Select Enable – When enabled and an HTC is present, it makes the HTC icon on the home screen visible. The icon allows the driver to send key operations directly to the HTC to perform whatever action has been assigned.	<ul style="list-style-type: none"> Disabled (Default) Enabled
HTC Hot Key Icon – Selects which icon to display to make it more driver-friendly. The result is still the same: send a ‘hot key’ to the HTC to perform an action.	<ul style="list-style-type: none"> Default (Default) Audio Announcement

5) USB Power

Feature	Values
Always Powered – The power to the USB socket will always be powered and will not be affected by the Enable Duration. Note: If a USB is plugged in during bootup, the USB power will remain on until the USB is removed regardless of the USB power setting.	<ul style="list-style-type: none"> Disabled Enabled (Default)
Enable Duration (minutes) – The time that the USB device will remain powered after the user has pressed the “Start” button.	1-5 (2 by default)

3.7.2 Console Management

It is shown as **Console Management**:

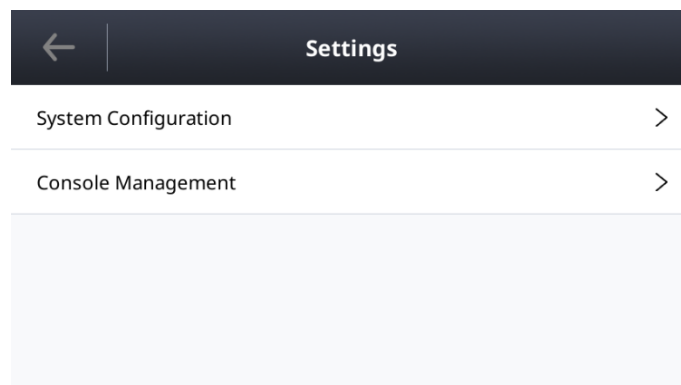

Selecting “Console Management” will display the following options:

- [3.7.2.1 Language](#)
- [3.7.2.2 Display](#)
- [3.7.2.3 Date and Time Settings](#)
- [3.7.2.4 Passcodes and Permissions](#)
- [3.7.2.5 Start USB Disaster Recovery](#)
- [3.7.2.6 Factory Default Settings](#)
- [3.7.2.7 Reboot Device](#)

3.7.2.1 Language

It is shown as **Language**:

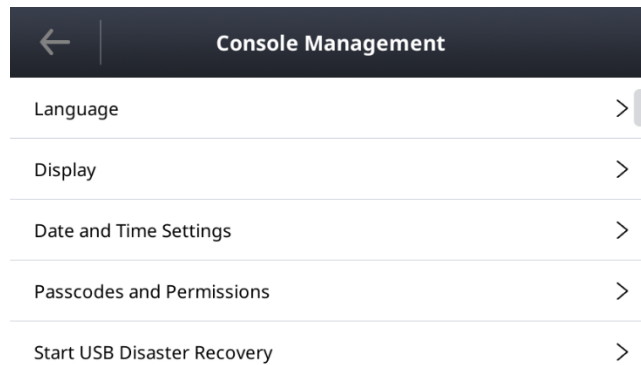

Selecting “Language” will allow to choose the language to be displayed on the controller as shown:















Feature	Values
Language	English
	Français (French)
	Deutsche (Dutch)
	Español (Spanish)
	Português (Portuguese)
	Svenska (Swedish)
	Nederlands (Dutch)
	Traditional Chinese
	Simplified Chinese

3.7.2.2 Display³⁴

Feature	Values
Display Brightness ³⁵ – This option is for adjusting the brightness of the EG4 display	Scroll bar to select from none to full (none by default)
Theme ³⁶ - This option allows for the user to select between the different available EG4 display themes	<ul style="list-style-type: none"> • Light (Default) • Dark • Automatic
Auto Theme Thresholds – This is the brightness level at which the unit will switch to light or dark mode	0 to 100 % (0% by default)
Display Inactivity Timeout ³⁷ (seconds) – Setting the timeout in seconds of the EG4 display when no activity is detected	0 to 120 (15 by default)
Inactivity Brightness Adjust ³⁸ – When the EG4 does not detect activity, it will reduce the display brightness	0 to 100% (0% by default)
Display Off Timeout ³⁹ (seconds) – This is the amount of time in minutes that the display will turn off when no activity is detected	0 to 120 (30 by default)
Brightness Limits - Manual override	0 to 100 % (5% - 80% by default)
Backlight Mode – Select between automatic EG4 display brightness control or manual	<ul style="list-style-type: none"> • Manual • Auto (Default)
Show Custom Splash Screen – This will allow the user to insert a personalised logo. For more details, refer to 1) Adding a personalised splash screen .	<ul style="list-style-type: none"> • Disabled • Enabled (Default)

³⁴ Setting a value of 0 for a Display's feature will disable this feature.

^{35 36 37 38 39} This can be set via HELEN by adding the appropriate parameter. Refer to [Appendix F](#).

Feature	Values
Edit Home Screen Icons – Allows the position of icons to be edited.	Available icons displayed: <ul style="list-style-type: none">  : destination  : round trip  : route number entry  : information message  : set departure time  : faults / warnings  : enter service ID  : HTC hot key entry / Audio announcement  : settings  : driver log out  : destination Up  : destination Down  : toggle state of charge  : home

1) Adding a personalised splash screen

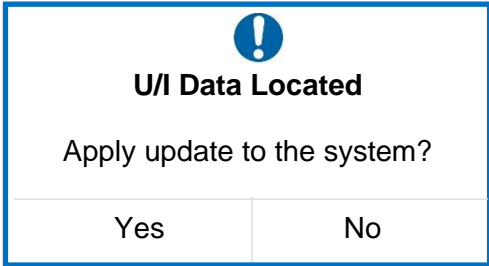
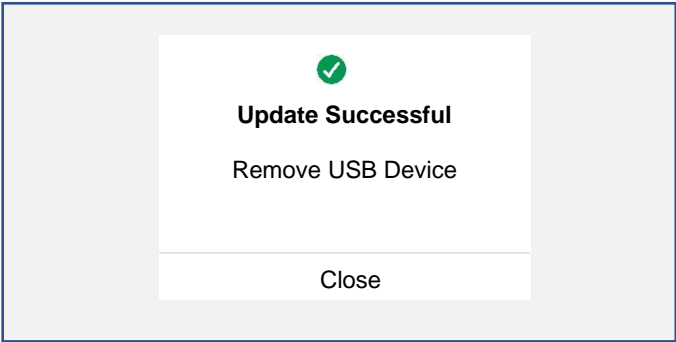

The splash screen will only appear at bootup after the Hanover logo and progress bar are displayed.

Step	Description
1	Save the splash screen file named “splash.png” on a standard Windows PC. Note: the maximum resolution of the splash screen file should not be more than 854x480.
2	Insert the USB flash memory drive (formatted to FAT32) into the PC. It appears as USB DRIVE (D:) . Note: The name and drive letter are variable and in this case, the drive letter allocated to the USB flash memory drive by the PC is 'D:'.
3	Locate the “splash.png” file and copy it onto the USB drive (which has a folder structure Hanover\eg4\ui).
4	‘Safely remove’ the USB flash memory drive from the PC. To do so, look for “Safely remove Hardware” icon on the taskbar. Right-click the icon and select the hardware you want to remove.
5	Insert the USB flash memory drive into the USB port on the front panel.
6	The following will be displayed on the screen: <div style="text-align: center; border: 1px solid blue; padding: 10px; margin: 10px auto; width: fit-content;">  </div> Select “Yes” to apply the update.
7	When the update is complete, the following will be displayed on the screen: <div style="text-align: center; border: 1px solid blue; padding: 10px; margin: 10px auto; width: fit-content;">  </div> Select “Close” and the USB flash memory drive can be removed.
8	The splash screen has been updated on the EG4. The EG4 can then be rebooted.

3.7.2.3 Date and Time Settings

This feature allows to set the time and date to be displayed on the destination controller.

It is shown as **Date and Time Settings**:

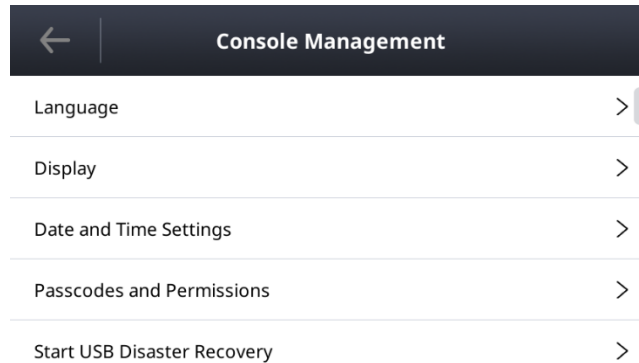

Selecting “Date and Time Settings” will display the following:

Feature	Values	
Automatic Date and Time – Enables the date/time to be updated automatically from either an internal GPS or, if connected to a network, a network time server.	<ul style="list-style-type: none"> • Disable • Enable (Default) 	
Set Time – This option is for setting the time on the destination controller	Slide to select hour and minute	
Set Date – This option is for setting the date on the destination controller	Slide to select date, month and year	
Time Zone – This option is for setting the time zone for the destination controller	Africa	Cairo
	America	<ul style="list-style-type: none"> • Anchorage • Caracas • Chicago • Denver • Los_Angeles • New_York • Sao_Paulo
	Asia	<ul style="list-style-type: none"> • Bangkok • Dhaka • Dubai • Hong_Kong • Karachi • Tokyo
	Australia	<ul style="list-style-type: none"> • Adelaide • Brisbane • Darwin • Sydney

Feature	Values	
	Europe	<ul style="list-style-type: none"> • London • Moscow • Paris
	Pacific	<ul style="list-style-type: none"> • Honolulu • Noumea
Time Format – This option allows to choose the format of the time displayed	<ul style="list-style-type: none"> • am/pm • 24 hour 	
Date Format – This option allows to choose the format of the date displayed	<ul style="list-style-type: none"> • DD/MM/YY • DD/MM/YYYY • MM/DD/YYYY • YYYY/MM/DD 	
Use GPS time – Allows the control of whether the internal GPS can be used to automatically correct the internal date/time.	<ul style="list-style-type: none"> • Disable • Enable (Default) 	
Use HTC time – Configures the EG4 to derive system time from a connected HTC, ensuring synchronisation between the devices.	<ul style="list-style-type: none"> • Disable (Default) • Enable 	
Network Time Servers – Allows the entry of network time server URLs that can be used by the EG4 to automatically set and correct the internal date/time. Note: This only has any function when connected to a network.	Keyboard display	

3.7.2.4 Passcodes and Permissions⁴⁰

Feature	Values
Maintenance Passcode	<ul style="list-style-type: none"> • Change • Add
USB update requires password – When a USB is inserted, the user will be prompted for the passcode before any update can take place	<ul style="list-style-type: none"> • Disable (Default) • Enable
Maintenance Timeout (seconds)	0 to 600 (0 by default)
Driver Passcode – This is the code the driver has to enter to access the EG4 (if set)	Add
Driver ID Required – This will prompt for a driver's ID to be entered on bootup	<ul style="list-style-type: none"> • Disable (Default) • Enable
Driver Passcode Required – This controls whether the driver has to enter a passcode before being able to use the destination controller	<ul style="list-style-type: none"> • Disable (Default) • Enable
Service Run Number – This is the number displayed on dash destination display which identifies the driver and route of a vehicle	<ul style="list-style-type: none"> • Disable (Default) • Enable

⁴⁰ Setting a value of 0 for a Passcodes and Permissions' feature will disable this feature.

Feature	Values
Destination Change Passcode ⁴¹ – This is whether a passcode is required in order to change the destination	<ul style="list-style-type: none"> • Disable (Default) • Enable
Information Change Passcode ⁴² – This is whether a passcode is required in order to change the information code	<ul style="list-style-type: none"> • Disable (Default) • Enable
Driver HTC Terminal Permission – This grants the driver access to the HTC terminal menu. For more details, refer to Appendix E: HTC Terminal Mode .	<ul style="list-style-type: none"> • Disable • Enable (Default)
Sign Test Maintenance Lock – This means that sign test option is moved to 'behind' the maintenance lock which requires the user to enter the maintenance code before being able to perform sign testing.	<ul style="list-style-type: none"> • Disable (Default) • Enable
Allow driver reboot - Enabling this option provides an option accessible to the driver that allows the driver to reboot the controller.	<ul style="list-style-type: none"> • Disable (Default) • Enable

3.7.2.5 Start USB Disaster Recovery

This feature allows to update the firmware in the case of the EG4 not detecting the USB memory drive, if the firmware is unable to be updated using the standard method (refer to [4.3 Firmware Update](#)) or if instructed by Hanover to perform a 'USB Disaster Recovery' procedure.

It is shown as **Start USB Disaster Recovery**:

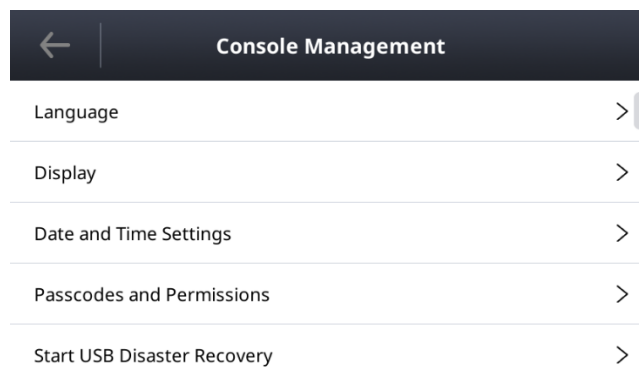

First, prepare the USB flash memory drive by following the procedure below:

Step	Description
1	Obtain a copy of the "recovery update package" from Hanover and save the files on a Windows PC.
2	Insert the USB flash memory drive (formatted to FAT32) into the PC. It appears as USB DRIVE (D:) . Note: The name and drive letter are variable and in this case, the drive letter allocated to the USB flash memory drive by the PC is 'D:'.
3	Locate the "recovery update package" and copy all of the individual files onto in the root of the USB drive.
4	'Safely remove' the USB flash memory drive from the PC. To do so, look for "Safely remove Hardware" icon on the taskbar. Right-click the icon and select the hardware you want to remove.

^{41 42} This can be set via HELEN by adding the appropriate parameter. Refer to [Appendix F](#).

Then, selecting “Start USB Disaster Recovery” on the EG4 will request the USB memory drive containing the “recovery update package” to be inserted:

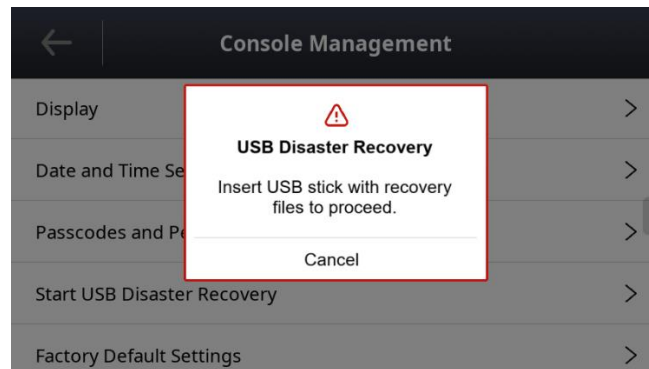

The EG4 will then reboot:

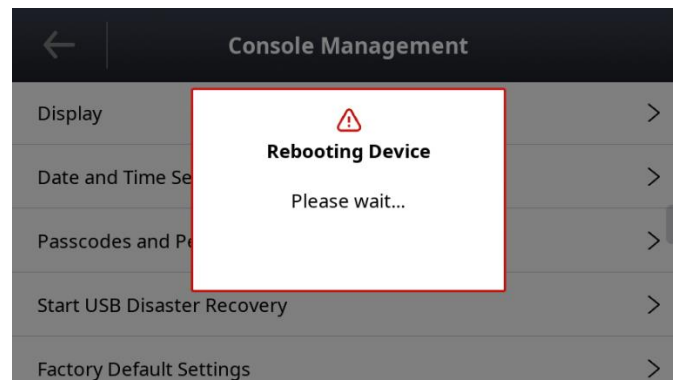

The EG4 will automatically start with the “USB Disaster Recovery” procedure.

3.7.2.6 Factory Default Settings



Be careful when using this function. Incorrect or improper use will erase the currently stored database and / or may reset all configuration and system parameters rendering your EG4 unusable within the vehicle until a database is reloaded.

This function resets all the configuration settings to their default values and erases the database.

It is shown as **Factory Default Settings**:

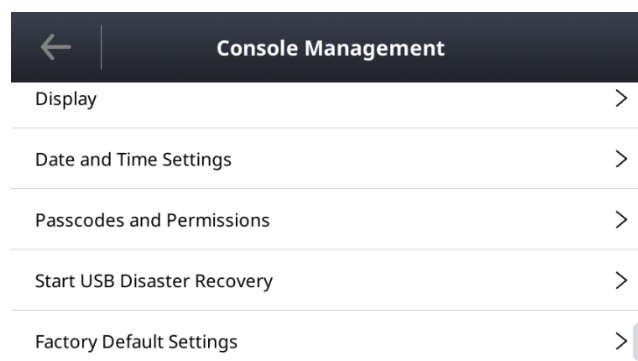

By selecting “Factory Default Settings”, the user will be prompted to enter the passcode. The following will then be displayed:

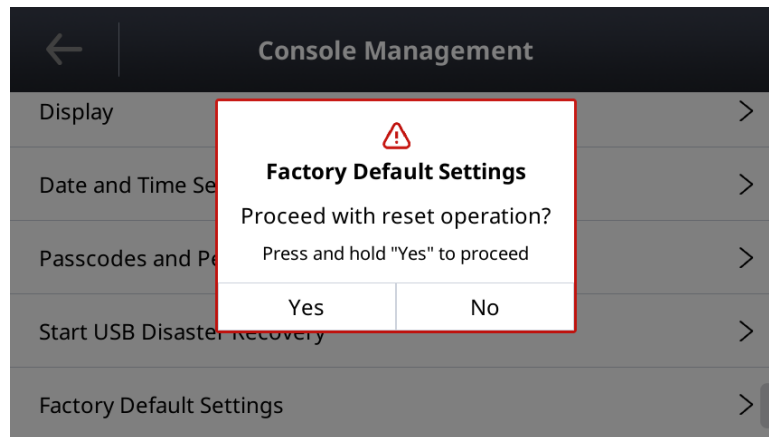

Pressing and holding “Yes” will proceed with the factory default settings.

3.7.2.7 Reboot Device

This function allows the user to perform a reboot of the EG4 controller without performing a power cycle on the vehicle.

It is shown as **Reboot device**:

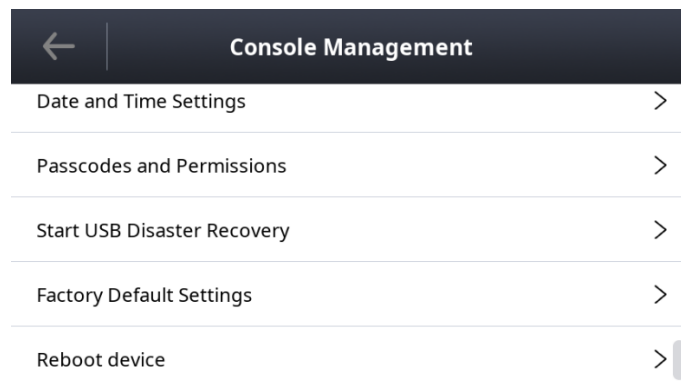

Selecting “Reboot device” will allow to reboot the destination controller. The following will then be displayed:

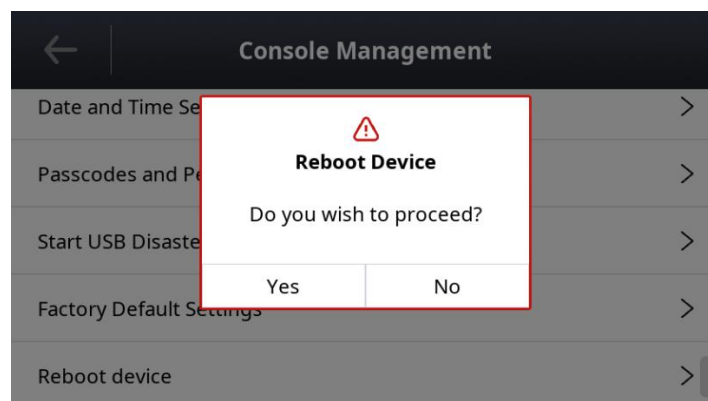

Pressing and holding “Yes” will proceed with the reboot device.

4. Firmware

4.1 Overview

Occasionally, it may be necessary to update the firmware in the EG4 for any of the following two reasons:

- There is an error in the functionality of the destination controller that affects its operation.

All software changes are tested thoroughly before release but even in the most rigorous test regime, it is possible for bugs to remain undetected. Most installations deploying standard, well-proven functions are very unlikely to be affected by bugs of this type.

- An update is needed in connection with a new feature.



Be careful as a firmware update will erase the controller's database which will need to be uploaded again afterwards.

4.2 EG4's firmware version

To know which firmware version your EG4 is equipped with:

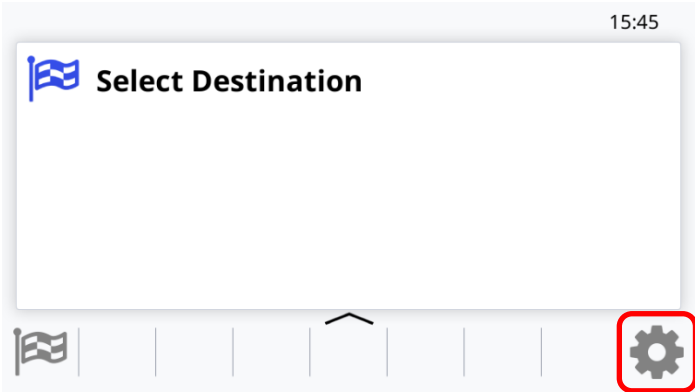
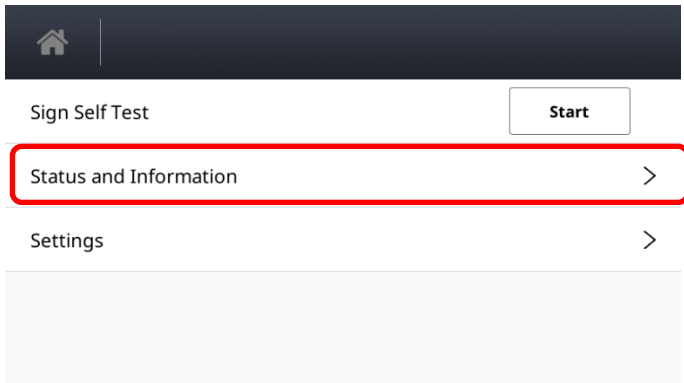
Step	Description
1	Using the touchscreen, tap the  icon. <div style="text-align: center; margin-top: 10px;">  </div>
2	Tap "Status and Information". <div style="text-align: center; margin-top: 10px;">  </div>

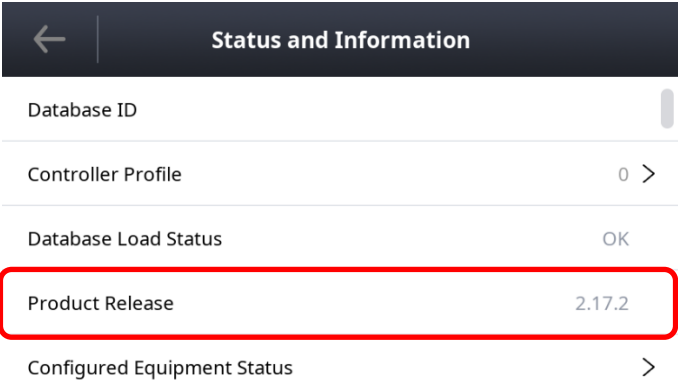
Step	Description
3	<p>The firmware version will be under “Product Release” as shown:</p>  <p>The screenshot shows a mobile application interface titled 'Status and Information'. It lists several system parameters: Database ID, Controller Profile (0), Database Load Status (OK), Product Release (2.17.2), and Configured Equipment Status. The 'Product Release' field is highlighted with a red rectangular box.</p>

For any enquiry about the latest released firmware version, please contact Hanover (refer to section [5.2 Hanover Technical Support](#)).

4.3 Firmware Update

The firmware of the EG4 destination controller can be updated in the two following ways:

- Either [4.3.1 Via “Wireless Data Manager” software](#)
- Or [4.3.2 Via an USB flash memory drive](#)

4.3.1 Via “Wireless Data Manager” software

It is possible to update the firmware on the EG4 via the “Wireless Data Manager” software. For more details about “Wireless Data Manager” software, refer to Wireless Data Manager – Commissioning and Operation Guide (ref. 540934).

The destination controller should be configured by loading a Config.ini file using an USB flash memory drive.

For more details about the parameters of the Config.ini file, refer to [Appendix C-1: Parameters of Config.ini file](#).

To update the Config.ini file on the EG4, refer to [Appendix C-2: Updating the Config.ini file on the EG4](#).

4.3.2 Via an USB flash memory drive



If the following methods cannot be used for updating the EG4 firmware, refer to [3.7.2.5 Start USB Disaster Recovery](#).

- For any firmware version prior to V0.11.2, the EG4 controller will first need to be upgraded to V0.11.2 using the 'recovery update package'. Refer to [4.3.2.1 Prior to firmware version V0.11.2](#).
- From firmware version V0.11.2 up to and including V0.12.0, the EG4 controller can then be upgraded to the latest firmware version available using the EG4 update mechanism. Refer to [4.3.2.2 From firmware version V0.11.2 up to and including V0.12.0](#).
- From firmware version V0.13.0 onwards, the EG4 controller can then be upgraded to the latest firmware version available using the EG4 update mechanism. Refer to [4.3.2.3 From firmware version V0.13.0 onwards](#).

The EG4 uses a USB flash memory drive to update the firmware via its USB port. The USB flash memory drive must be formatted to use the FAT32 file system.

4.3.2.1 Prior to firmware version V0.11.2

i. Preparing the USB flash memory drive

Prepare the USB flash memory drive as follows:

Step	Description
1	Insert the USB flash memory drive into the PC. It appears as USB DRIVE (D:) . Note: The name and drive letter are variable and in this case, the drive letter allocated to the USB flash memory drive by the PC is 'D:'.

ii. Loading the firmware to the USB flash memory drive

Load the firmware to the USB flash memory drive as follows:

Step	Description
1	Obtain a copy of the "recovery update package" from Hanover.
2	Save all of the individual files onto the root of the USB drive.
3	'Safely remove' the USB flash memory drive from the PC. To do so, look for "Safely remove Hardware" icon on the taskbar. Right-click the icon and select the hardware you want to remove.

iii. Loading the firmware to the EG4

Transfer the firmware from the USB flash memory drive to the EG4 as follows:

Step	Description
1	Insert the USB flash memory drive into the USB port on the front of the destination controller.
2	Power up the EG4 destination controller with the USB flash memory drive already inserted into the USB port on the front panel. The new firmware will be updated on the EG4. Note: If the EG4 is not uploading the new firmware from the USB memory drive, then go to 3.7.2.5 Start USB Disaster Recovery .

4.3.2.2 From firmware version V0.11.2 up to and including V0.12.0

i. Preparing the USB flash memory drive

Prepare the USB flash memory drive as follows:

Step	Description
1	Insert the USB flash memory drive into the PC. It appears as USB DRIVE (D:) . Note: The name and drive letter are variable and in this case, the drive letter allocated to the USB flash memory drive by the PC is 'D:'.
2	Create the following location on the USB: \\hanover\hdl-eg4\delta

ii. Loading the firmware to the USB flash memory drive

Load the firmware to the USB flash memory drive as follows:

Step	Description
1	Obtain a copy of the delta firmware file(s) from Hanover.
2	Save the firmware file on the USB in the location created in above step 2.
3	'Safely remove' the USB flash memory drive from the PC. To do so, look for "Safely remove Hardware" icon on the taskbar. Right-click the icon and select the hardware you want to remove.

iii. Loading the firmware to the EG4

Transfer the firmware from the USB flash memory drive to the EG4 as follows:

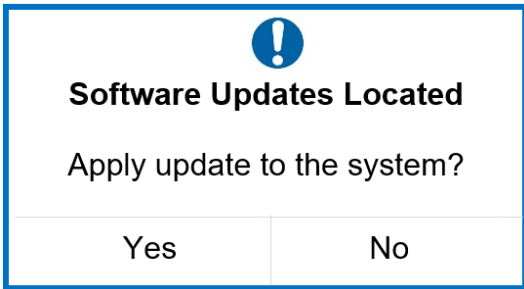
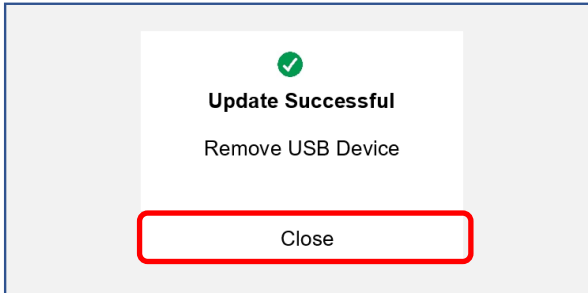
Step	Description	Figure
1	Insert the USB flash memory drive into the USB port on the front of the destination controller.	
2	The following will be displayed on the screen. Tap "Yes" to apply the software update. Note: The EG4 will start updating the firmware. There is a progress bar to indicate the update progress. Some functions can be used but it would be recommended not to use the unit during the update. The firmware update should take approximately 2 minutes to complete.	
3	When update is complete, the destination controller will display "Update Successful" and "Remove USB Device". Tap "Close" and the USB flash memory drive can be removed. The firmware has been updated on the EG4.	

4.3.2.3 From firmware version V0.13.0 onwards

i. Preparing the USB flash memory drive

Prepare the USB flash memory drive as follows:

Step	Description
1	Insert the USB flash memory drive into the PC. It appears as USB DRIVE (D:) . Note: The name and drive letter are variable and in this case, the drive letter allocated to the USB flash memory drive by the PC is 'D:'.
2	Create the following location on the USB: \\hanover\eg4\delta

ii. Loading the firmware to the USB flash memory drive

Load the firmware to the USB flash memory drive as follows:

Step	Description
1	Obtain a copy of the delta firmware file(s) from Hanover.
2	Save the firmware file on the USB in the location created in above step 2.
3	'Safely remove' the USB flash memory drive from the PC. To do so, look for "Safely remove Hardware" icon on the taskbar. Right-click the icon and select the hardware you want to remove.

iii. Loading the firmware to the EG4

Transfer the firmware from the USB flash memory drive to the EG4 as follows:

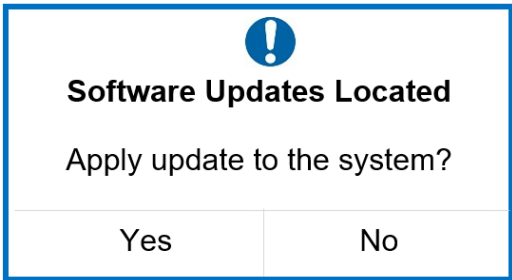
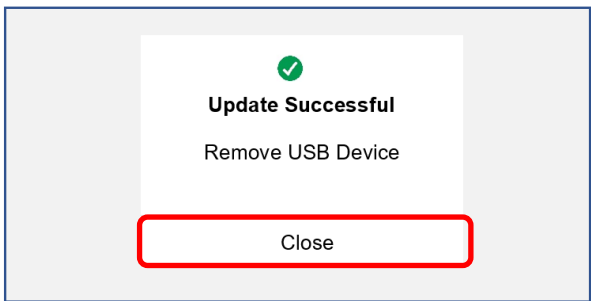
Step	Description	Figure
1	Insert the USB flash memory drive into the USB port on the front of the destination controller.	
2	The following will be displayed on the screen. Tap "Yes" to apply the software update. Note: The EG4 will start updating the firmware. There is a progress bar to indicate the update progress. Some functions can be used but it would be recommended not to use the unit during the update. The firmware update should take approximately 2 minutes to complete.	
3	When update is complete, the destination controller will display "Update Successful" and "Remove USB Device". Tap "Close" and the USB flash memory drive can be removed. The firmware has been updated on the EG4.	

5. Troubleshooting

5.1 Overview

This section lists the more common queries that occur with the EG4 destination controller. The destination controller is not intended for disassembly by the user. Hanover should be consulted (please refer to section [5.2 Hanover Technical Support](#)) if a solution cannot be found by means of altering settings manually or via the HELEN software as described below.

Section	Issue
5.1.1	No display or backlight on destination controller
5.1.2	No communication or required information not displayed on destination displays
5.1.3	List will not load into EG4 destination controller
5.1.4	EG4 loads list correctly but shows 'Bad Destination or Bad Route'

5.1.1 No display or backlight on destination controller

No.	Description	Refer to section
1	Check that pins 1 and 10 on the mini fit connector are wired correctly by making sure the pins are pushed in securely into the connector and that the required voltage is present	Appendix D-1: SK1 Appendix A-1: SK1 18-way mini fit connector

5.1.2 No communication or required information not displayed on destination displays

No.	Description	Refer to section
1	Check that the RS485 communication is wired correctly (pin 11 = red (+) and pin 2 = black (-)) by making sure the pins are pushed in securely into the connector	Appendix A-1: SK1 18-way mini fit connector
2	Check all other cables and connections	
3	Run the sign self test to check that power and communications are reaching each destination display. A test pattern should be visible on the destination displays: <ul style="list-style-type: none"> If visible, the destination list loaded is possibly not compatible with the destination display system on the vehicle. Check that the HELEN database file has been configured correctly If not visible, then there is probably a hardware / communications problem 	3.4 Sign Self Test Function

5.1.3 List will not load into EG4 destination controller

No.	Description	Refer to section
1	Check there is a valid destination list on the USB drive and that it has been correctly configured	3.2.2 Updating the destination list using an USB flash memory drive
2	Check that the USB drive is formatted to FAT32	
3	If problem still persists, check if the USB drive is faulty	

5.1.4 EG4 loads list correctly but shows 'Bad Destination or Bad Route'

No.	Description	Refer to section
1	Ensure a valid destination or route code is being entered	
2	The database may have been saved and loaded as a standard 4-digit code rather than a 10-digit route browse (or vice versa). Check in HELEN that the correct option has been selected	3.2.2 Updating the destination list using an USB flash memory drive
3	Resave the database to the USB drive if necessary and then upload it to the EG4 again	

5.2 Hanover Technical Support

Please do not hesitate to contact Hanover Technical Support located in Lewes, UK for any problem encountered or for any advice needed for using the EG4 destination controller:

Contact	
Phone	+44 (0)1273 477528 Ext.615 or Option 2
Email	support@hanoverdisplays.com

6. Queries, FAQs and other information

6.1 Overview

The previous section provides in-depth information on diagnosing problems that can occur with the EG4. This 'how to' section provides answers to typical questions and queries associated with the unit and includes cross-references and links where appropriate to the relevant sections of the manual.

If the answer is not found here, users can contact Hanover Technical Support – please refer to section [5.2 Hanover Technical Support](#).

6.2 Queries/FAQs

Questions	Answers
Configure a USB flash memory drive for loading a database into the EG4	3.2.2 Updating the destination list using an USB flash memory drive
Determine the sizes and addresses of the destination displays	3.4 Sign Self Test
Change the language setting in the EG4	3.7.2.1 Language
Add a 'bus reversing' message to the destination displays	3.7.1.2 Digital I/O
Add an 'emergency' message to the destination displays	3.7.1.2 Digital I/O
Use the 'battery guard' feature	3.7.1.2 Digital I/O
Do I need a special loading device?	No, you can use an off-the-shelf USB flash memory drive. It should be noted that these are not 100% compatible so you may need to try more than one.
How do I load the EG4?	A database of destination information (plus adverts and other messages if required) is prepared on a standard Windows PC using HELEN sign-editing software. This is transferred to a USB flash memory drive and then loaded directly into the EG4. Please refer to section 3.2 Loading a HELEN database into the EG4 .
Can I change a DERIC+ for an EG4?	Yes, you will need Hanover adaptor cable CX330K and a USB flash drive. Please refer to 2.2.2.1 CX330K – For replacing a DERIC+ destination controller .

Questions	Answers
Can I change an ERIC++ for an EG4?	Yes, you will need Hanover adaptor cable CX330N and a USB flash drive. Please refer to 2.2.2.2 CX330N – For replacing an ERIC++ destination controller.
Do I need a new database for the EG4?	No, your existing database will work.
I have to use a HELEN-compressed database, will this work?	Yes.
My database uses profiles, will this work with the EG4?	Yes, the EG4 supports profile databases. Refer to 3.7.1.1 Controller Profile.

Appendix A: Function of connectors on rear of EG4 destination controller

The functions of the 3 types of mini fit connectors (SK1, SK2 and SK3) and M12 Ethernet connectors (ETH1/ETH2) are described in this appendix.

Appendix A-1: SK1 18-way mini fit connector

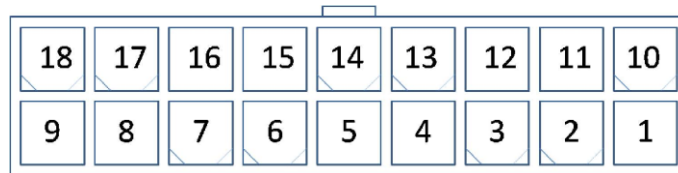

Figure 11 - diagram showing the 18-way mini fit connector

Pin	Pin name	Description
1	-VBAT	Main power input 0V
2	SIGN RS485 [B]	Destination display port RS485 B
3	I/F 1 [D]: [varies]	Secondary comms (multifunction) routed to plug-in site. Refer to Interface 1 pin D in Appendix A-1-1: SK1 COMMS OPTIONS: 18-way mini fit connector
4	I/F 1 [B]: [varies]	Secondary comms (multifunction) routed to plug-in site. Refer to Interface 1 pin B in Appendix A-1-1: SK1 COMMS OPTIONS: 18-way mini fit connector
5	DIG I/P 2 [+]	Digital input 2 (isolated) – Anode connection (+) – (+8V) to (+32V)
6	DIG I/P 0 [+]	Digital input 0 (isolated) – Anode connection (+) – (+8V) to (+32V)
7	DIG I/P 1 [-]	Digital input 1 (isolated) – Cathode connection (-) – (+8V) to (+32V)
8	RS485/J1708 [A]	Secondary RS485/J1708 A
9	RS232 [TX]	RS232 Transmit
10	+VBAT	Main 24V power input – (+8V) to (+32V)
11	SIGN RS485 [A]	Destination display port RS485 A
12	I/F 1 [C]: [varies]	Secondary comms (multifunction) routed to plug-in site. Refer to Interface 1 pin C in Appendix A-1-1: SK1 COMMS OPTIONS: 18-way mini fit connector
13	I/F 1 [A]: [varies]	Secondary comms (multifunction) routed to plug-in site. Refer to Interface 1 pin A in Appendix A-1-1: SK1 COMMS OPTIONS: 18-way mini fit connector
14	DIG I/P 0 [-]	Digital input 0 (isolated) – Cathode connection (-) – (+8V) to (+32V)
15	DIG I/P 2 [-]	Digital input 2 (isolated) – Cathode connection (-) – (+8V) to (+32V)
16	DIG I/P 1 [+]	Digital input 1 (isolated) – Anode connection (+) – (+8V) to (+32V)
17	RS485/J1708 [B]	Secondary RS485/J1708 B
18	RS232 [RX]	RS232 Receive

Note: Please ensure that pair of pins 6 and 14, pair of pins 7 and 16 and pair of pins 5 and 15 of the 18-way mini fit connector correspond to the correct external input (I0, I1 or I2) in HELEN software:

- Pair of pins 6 and 14 (digital input 0 of EG4) correspond to external input I0 in HELEN software
- Pair of pins 7 and 16 (digital input 1 of EG4) correspond to external input I1 in HELEN software
- Pair of pins 5 and 15 (digital input 2 of EG4) correspond to external input I2 in HELEN software

Appendix A-1-1: SK1 COMMS OPTIONS: 18-way mini fit connector

Pin		13	4	12	3
COMMS	INTERFACE 1 PIN	A	B	C	D
	RS232	TX	23V ⁴³ 5V ⁴⁴ RTS ^{*45}	RX	0V
	RS422	TX A	TX B	A	B
	Isolated RS485	Shield	ISO GND	A	B
	J1708	-	-	A	B
	IBIS SLAVE	TX+	TX-	RX+	RX-
	RS485	-	-	A	B

*RTS: Request To Send

Note: I/F 1 corresponds to **Port 4** in the EG4 firmware and HELEN software package:

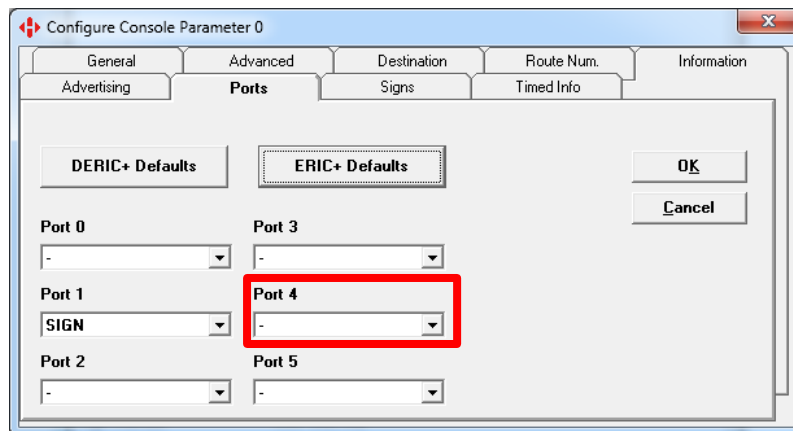

^{43 44 45} Dependent on plug-in variant.

Appendix A-2: SK2 14-way mini fit connector

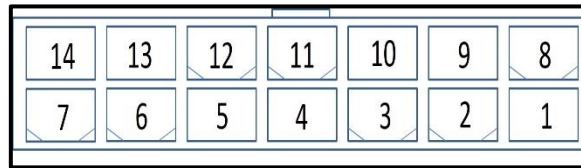

Figure 12 - diagram showing the 14-way mini fit connector

Pin	Pin name	Description
1	I/F 2 [D]: [varies]	Secondary comms (multifunction) routed to plug-in site. Refer to Interface 2 pin D in Appendix A-2-1: SK2 COMMS OPTIONS: 14-way mini fit connector
2	I/F 2 [B]: [varies]	Secondary comms (multifunction) routed to plug-in site. Refer to Interface 2 pin B in Appendix A-2-1: SK2 COMMS OPTIONS: 14-way mini fit connector
3	DIG O/P 0 - COLLECTOR	Digital output 0 - COLLECTOR
4	DIG O/P 1 - COLLECTOR	Digital output 1 - COLLECTOR
5	ODO GND	Odometer ground
6	ISO_CAN GND ⁴⁶	Isolated CAN ground reference
7	CAN HIGH ⁴⁷	CAN high line
8	I/F 2 [C]: [varies]	Secondary comms (multifunction) routed to plug-in site. Refer to Interface 2 pin C in Appendix A-2-1: SK2 COMMS OPTIONS: 14-way mini fit connector
9	I/F 2 [A]: [varies]	Secondary comms (multifunction) routed to plug-in site. Refer to Interface 2 pin A in Appendix A-2-1: SK2 COMMS OPTIONS: 14-way mini fit connector
10	DIG O/P 0 - EMITTER	Digital output 0 - EMITTER
11	DIG O/P 1 - EMITTER	Digital output 1 - EMITTER
12	ODO SIG	Odometer signal
13	ODO PWR I/P	Odometer power input
14	CAN LOW ⁴⁸	CAN low line

⁴⁶ Pin 6 only to be used if using the isolated CAN bus option (will lose plug-in site 1).

⁴⁷ ⁴⁸ 120R line termination resistor is needed between the CAN high and CAN low lines if the EG4 is at the end of the CAN bus.

Appendix A-2-1: SK2 COMMS OPTIONS: 14-way mini fit connector

Pin		9	2	8	1
COMMS	INTERFACE 2 PIN	A	B	C	D
	RS232	TX	23V ⁴⁹ 5V ⁵⁰ RTS ⁵¹	RX	0V
	RS422	TX A	TX B	A	B
	Isolated RS485	Shield	ISO GND	A	B
	J1708	-	-	A	B
	IBIS SLAVE	TX+	TX-	RX+	RX-
	RS485	-	-	A	B

*RTS: Request To Send

Note: I/F 2 corresponds to **Port 5** in the EG4 firmware and HELEN software package:

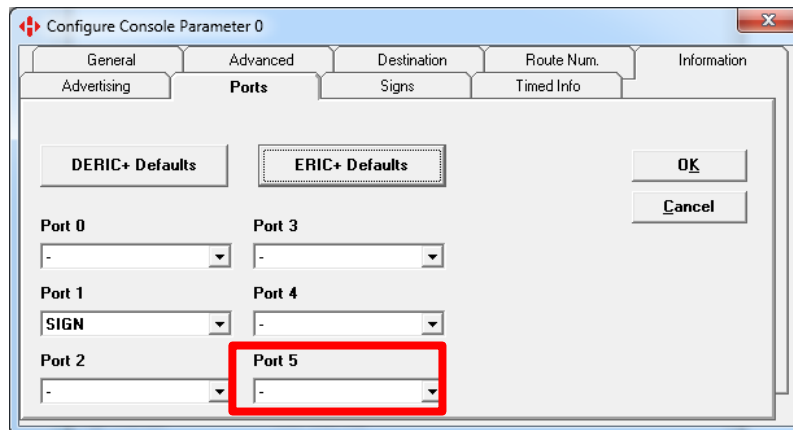

^{49 50 51} Dependent on plug-in variant.

Appendix A-2-2: Wiring variation for additional communication protocols

Detailed 18-way and 14-way mini fit connector pinout for additional communication protocols provided by Hanover plug-in devices are shown below:

RS232 com

7521-01-01 plug-in interface

(18-way) I/F 1 Pin	(14-way) I/F 2 Pin	Pin	Function	Description
13	-	A	TxD (Port 4)	RS232 Plug-in Transmitted Data
4	-	B	GND (Port 4)	RS232 Plug-in Common Ground
12	-	C	RxD (Port 4)	RS232 Plug-in Received Data
3	-	D	RTS (Port 4) ⁵²	RS232 Request to Send
-	9	A	TxD (Port 5)	RS232 Plug-in Transmitted Data
-	2	B	GND (Port 5)	RS232 Plug-in Common Ground
-	8	C	RxD (Port 5)	RS232 Plug-in Received Data
-	1	D	RTS (Port 5) ⁵³	RS232 Request to Send

RS485 comms

7202-01-03 plug-in interface

(18-way) I/F 1 Pin	(14-way) I/F 2 Pin	Pin	Function	Description
12	-	C	RS485 A (Port 4)	RS485 Plug-in Data A
3	-	D	RS485 B (Port 4)	RS485 Plug-in Data B
-	8	C	RS485 A (Port 5)	RS485 Plug-in Data A
-	1	D	RS485 B (Port 5)	RS485 Plug-in Data B

Isolated RS485 comms

7756-01-01 plug-in interface

(18-way) I/F 1 Pin	(14-way) I/F 2 Pin	Pin	Function	Description
13	-	A	100Ω GND (Port 4)	Isolated RS485 Plug-in 100Ω Termination to GND
4	-	B	ISO GND -R (Port 4)	Isolated RS485 Ground -R
12	-	C	RS485A (Port 4)	Isolated RS485 Plug-in Data A
3	-	D	RS485 B (Port 4)	Isolated RS485 Plug-in Data B
-	9	A	100Ω GND (Port 5)	Isolated RS485 Plug-in 100Ω Termination to GND
-	2	B	ISO GND -R (Port 5)	Isolated RS485 Ground -R
-	8	C	RS485A (Port 5)	Isolated RS485 Plug-in Data A
-	1	D	RS485 B (Port 5)	Isolated RS485 Plug-in Data B

⁵² ⁵³ Dependent on plug-in variant.

IBIS slave comms
7206-01-02 plug-in interface

(18-way) I/F 1 Pin	(14-way) I/F 2 Pin	Pin	Function	Description
13	-	A	Tx Data (Port 4)	WBSD (Wagenbus Senden Data) (White)
4	-	B	Rx GND (Port 4)	WBME (Wagenbus Masse Empfangen) (Green)
12	-	C	Rx Data (Port 4)	WBED (Wagenbus Empfangen Data) (Yellow)
3	-	D	Tx GND (Port 4)	WBMS (Wagenbus Masse Senden) (Brown)
-	9	A	Tx Data (Port 5)	WBSD (Wagenbus Senden Data) (White)
-	2	B	Rx GND (Port 5)	WBME (Wagenbus Masse Empfangen) (Green)
-	8	C	Rx Data (Port 5)	WBED (Wagenbus Empfangen Data) (Yellow)
-	1	D	Tx GND (Port 5)	WBMS (Wagenbus Masse Senden) (Brown)

J1708 comms
7624-01-01 plug-in interface

(18-way) I/F 1 Pin	(14-way) I/F 2 Pin	Pin	Function	Description
13	-	A	N/C	N/C
4	-	B	N/C	N/C
12	-	C	J1708 A (Port 4)	J1708 A
3	-	D	J1708 B (Port 4)	J1708 B
-	9	A	N/C	N/C
-	2	B	N/C	N/C
-	8	C	J1708 A (Port 5)	J1708 A
-	1	D	J1708 B (Port 5)	J1708 B

Appendix A-3: SK3 Audio 10-way mini fit connector

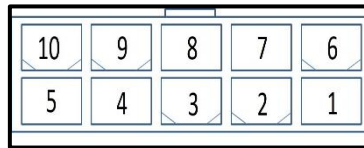

Figure 13 - diagram showing the 10-way mini fit connector

Pin	Pin name	Description
1	LINE O/P [-]	Line output [-]
2	N/C	Not connected
3	AMB MIC [-]	Ambient microphone [-]
4	N/C	Not connected
5	SPK- (4 - 8Ω)	Speaker [-] (4 - 8Ω)
6	LINE O/P [+]	Line output [+]
7	LINE OUTPUT SHIELD	For use with line out (pin 1 and 6)
8	AMB MIC [+]	Ambient microphone [+]
9	AMB MIC SHIELD	For use with dedicated ambient mic input (pin 3 and 8) and speaker-as-mic input (pin 5 and 10)
10	SPK+ (4 - 8Ω)	Speaker [+] (4 - 8Ω)

Appendix A-4: M12 ETHERNET

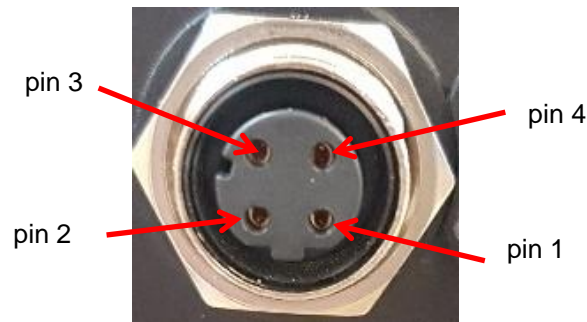

Figure 14 - diagram showing the M12 Ethernet connector

Pin	Function	Description
1	ETH TX+	Transmit+
2	ETH RX+	Receive+
3	ETH TX-	Transmit-
4	ETH RX-	Receive-

Appendix B: Serial Ports

		Feature	Values
Serial Ports	Port 1 Port 2 Port 3	Linked Protocol	<ul style="list-style-type: none"> • AESYS-A • ALMEX • BUS-STOPPING-SIGN (Default) • CGA-A • DASH (Default) • DUBWAYF • DUHAMEL • ECHO • EMT-MALAGA • GTMH-1 • HANCIS (Default) • HANO-1 • HANO-1F • HTC • HTC-IO-ERIC • HTC-PRESENTATION-LED • IBIS • IBIS-4 • IBIS-MASTER • IVNUPLOAD • J1708-1 • J1708-2 • J1708-2A • J1708-3 • J1708-4 • J1708-5 • NYCT • OCTA • ROUTE (Default) • SIGN (Default) • SLE • SOCRIE-A • SOCRIE-B • TGX150-A • TGX150-C • TGX150-D
		Hardware	RS485
		Port ID Mapping ⁵⁴	-

⁵⁴ For more information about Port ID Mapping, refer to [Port Mapping](#).

Feature			Values	
Serial Ports	Port 1 Port 2 Port 3 Port 4 Port 5	Advanced Settings	Baud Rate ⁵⁵ <ul style="list-style-type: none"> • 2400 • 4800 (Default) • 9600 • 19200 • 38400 • 57600 • 115200 	
			Word Length <ul style="list-style-type: none"> • 7 • 8 (Default) 	
			Parity Checking <ul style="list-style-type: none"> • None (Default) • Even • Odd 	
			Stop Bits <ul style="list-style-type: none"> • 1 (Default) • 2 	
			Flow Control <ul style="list-style-type: none"> • None (Default) • Hardware 	
			Break Signal <ul style="list-style-type: none"> • Allow • Ignore (Default) 	
			Wait Read Length	0 to 255 (0 by default)
			Read Timeout in Seconds	0.0 to 25.5 (0.1 by default)

⁵⁵ Baud rate: rate transmission speed between the destination controller and displays. Destination displays themselves must have their processors set to the same baud rate as the destination controller.

Appendix C: Config.ini file

Appendix C-1: Overview

The config.ini file is separated into sections, each section is separated by [*heading*] as shown below. These separators must be included in the config.ini file.

Not all sections or parameters are required to be present in the config.ini. It is possible to set/update a combination of any parameters from the available list.

Example of config.ini file:

```
UNIT_ID=1234
BUS_PROFILE_NUM=0

[ETH0]
ENABLE_DHCP=0
IP_ADDRESS=192.168.0.245
SUBNET_MASK=255.255.255.0
DEFAULT_GATEWAY=172.21.51.1

[WLAN]
DHCP=1
ADDRESS=192.168.0.245
NETMASK=255.255.255.0
GATEWAY=172.21.51.1
DNS_SERVERS=1.1.1.1

[WIFI-Test]
SSID=Hanover-Test
PSK=67a036e95609845df790d4ff9719c0b66e993b02beaffe85c51e33fd852f9544

[GSM_MODEM]
ENABLE=1
APN=my_wifi
USER=eecure
PASS=secure
PIN=1234

[FTP]
FTP_SERVER_IP=sftp://sftp.hanover.cloud:2022
FTP_SERVER_USER_NAME=1026_200
FTP_SERVER_PASSWORD=2L2L6a9M
FTP_SERVER_DELAY_WAIT=60
CTRL_LOADING_ROUTEDEST=-1|-1
FTP_PORT=2022

[OBC]
VHTC_ENABLE=1
VHTC_UDP_PORT=1599
```

```
[CAN1]
BITRATE_KBITS=250
LOOPBACK=0
LISTEN_ONLY=0
FEATURES=STATE-OF-CHARGE
```

```
[CAN_ENTRY_0] ; BYD
MESSAGE_TYPE=STATE_OF_CHARGE
ID=0x18F737F4
PGN=
BIT_MASK=0xFF00000000000000
RANGES=0-100,101-254,255
ACTIONS=LITERAL,REPLACEMENT_TEXT=??,INVALID
OVERRIDES=*,*,*
SCALING=
OFFSET=
DECIMAL_PLACE_COUNT=
```

```
[CAN_ENTRY_1] ; BYD
MESSAGE_TYPE=CHARGING_STATUS
ID=0x18F534F4
PGN=
BIT_MASK=0xFC00000000000000
RANGES=0,1,2,3
ACTIONS=DISPLAY_LOOKUP_REFERENCE=SC00044412,DISPLAY_LOOKUP_REFERENCE=S
C00044413,DISPLAY_LOOKUP_REFERENCE=SC00044414,DISPLAY_LOOKUP_REFERENCE=
SC00044415
OVERRIDES=*,*,*,*
SCALING=
OFFSET=
DECIMAL_PLACE_COUNT=
```

```
[CAN_ENTRY_2] ; BYD
MESSAGE_TYPE=CHARGING_GUN_STATE
ID=0x18F55D89
PGN=
BIT_MASK=0x0000000C00000000
RANGES=0,1,2,3
ACTIONS=OVERRIDE_CONTROL_ONLY,OVERRIDE_CONTROL_ONLY,INVALID,INVALID
OVERRIDES=0,1,*,*
SCALING=
OFFSET=
DECIMAL_PLACE_COUNT=
```

```
[TIME_ZONE]
TIME_ZONE=Asia/Hong_Kong
```

Parameter	Description
CONSOLE_MQTT	Enables the HanIP MQTT service Values: 0 = Disabled or 1 = Enabled
SOC_SIGN_OUTPUT_ROUTEDDEST	Route/destination pairs that must match the selected Route/destination for the State of Charge (SoC) message to be displayed -1 -1 (displays SoC in any destination code, 0000 0001 displays SoC in only route no. 0, destination code 1 etc.). Multiple codes can be specified and separated by a comma.
UNIT_ID	Id of unit Refers to the customer reference assigned to the unit that is used when it connects to the FTP server to locate the relevant files for transfer – 29-character limit, must be Alphanumeric (0-9, a-z, A-Z), must not be one of the following reserved names: "CON", "PRN", "AUX", "NUL", "COM1", "COM2", "COM3", "COM4", "COM5", "COM6", "COM7", "COM8", "COM9", "LPT1", "LPT2", "LPT3", "LPT4", "LPT5", "LPT6", "LPT7", "LPT8", "LPT9".
BUS_PROFILE_NUM	Set Bus Profile Number. Range 0-99

[Eth0]

Parameter	Description
ENABLE_NETWORK	<p>Enable/Disable Network To enable networking on devices support ethernet.</p> <p>Values: 0 = Disabled or 1 = Enabled</p>
ENABLE_DHCP	<p>Enable/Disable DHCP If “1”, the unit will attempt to connect to a DHCP server to obtain an IP address for the unit. If it fails to communicate with a DHCP server, it will default back to the manual IP address as if “0” had been selected.</p> <p>Values: 0 = Disabled or 1 = Enabled</p>
IP_ADDRESS	<p>Static IPv4 Address The manually entered IP address the unit will use as its own address if DHCP is set to “0” or fails to locate a DHCP server when set to “1”.</p> <p>Acceptable values of the format X.X.X.X where X can range from 0-255.</p>
SUBNET_MASK	<p>Static subnet mask The subnet mask associated with the unit for attempting to connect to the FTP server.</p> <p>Acceptable values of the format X.X.X.X where X can range from 0-255.</p> <p>If not specified, defaults to 255.255.255.0</p>
DEFAULT_GATEWAY	<p>Static default gateway Acceptable values of the format X.X.X.X where X can range from 0-255.</p>
DNS_SERVER	<p>IPv4 address of DNS server If FTP_Server_IP is given in the form of a URL and needs to be resolved by DNS, the DNS Server Address must be configured (unless this address is to be provided by DHCP).</p> <p>Acceptable values of the format X.X.X.X where X can range from 0-255.</p>
DHCP_SERVER	<p>DHCP Server Enables DHCP server on eth0 port.</p> <p>Values: 0 = Disabled or 1 = Enabled</p>
DHCP_LEASE	<p>DHCP Lease range Specifies the range of addresses available for leasing to devices connected to eth0 for DHCP.</p> <p>Acceptable values of the format X.X.X.X-X.X.X.X</p>

[Eth1] or [wlan]

Parameter	Description
ENABLE	<p>Enable/Disable Network or WLAN To enable networking on devices support ethernet or wireless LAN device support.</p> <p>Values: 0 = Disabled or 1 = Enabled</p>
DHCP	<p>Enable/Disable DHCP If “1”, the unit will attempt to connect to a DHCP server to obtain an IP address for the unit. If it fails to communicate with a DHCP server, it will default back to the manual IP address as if “0” had been selected. Acceptable values are: “1” or “0”.</p>
ADDRESS	<p>Static IPv4 Address The manually entered IP address the unit will use as its own address if DHCP is set to “0” or fails to locate a DHCP server when set to “1”. Acceptable values of the format X.X.X.X where X can range from 0-255.</p>
NETMASK	<p>Static subnet mask The subnet mask associated with the unit for attempting to connect to the FTP server. Acceptable values of the format X.X.X.X where X can range from 0-255. If not specified, defaults to 255.255.255.0</p>
GATEWAY	<p>Static default gateway Acceptable values of the format X.X.X.X where X can range from 0-255.</p>
DNS_SERVERS	<p>IPv4 address of DNS server If FTP_Server_IP is given in the form of a URL and needs to be resolved by DNS, the DNS Server Address must be configured (unless this address is to be provided by DHCP). Acceptable values of the format X.X.X.X where X can range from 0-255.</p>
DHCP_SERVER	<p>DHCP Server Enables DHCP server on eth1 port.</p> <p>Values: 0 = Disabled or 1 = Enabled</p>
DHCP_LEASE	<p>DHCP Lease range Specifies the range of addresses available for leasing to devices connected to eth1 for DHCP. Acceptable values of the format X.X.X.X-X.X.X.X</p>

[WiFi-xxxx] – Where xxxx is any name you want to give for the WiFi network

Parameter	Description
SSID	This is the network name (ssid) of the wifi connection
PSK	This is the passphrase for the network. It can be specified as plain text in quotes or a hashed passphrase without quotes. E.g. Plain text: psk="passphrase" Hashed: psk=67a036e95609845df790d4ff9719c0b66e993b02beaffe85c51e33fd852f9544 Note: hashed keys can be created using commonly available online tools. Search "create hashed password online".
KEY_MGNT	Specifies the security protocols to use for this connection. The protocols must be separated by a space. The default is blank and uses "WPA-PSK WPA-EAP". Security protocols: - NONE : No password required, or WEP (which is not supported) - WPA-PSK : Requires psk to login to network - WPA-EAP : Not supported - IEEE8021X : Not supported
PRIORITY	Prioritises the selection when more than one network is available.
SCAN_SSID	SSID scan technique 0 scans for the SSID using a broadcast Probe Request frame while 1 uses a directed Probe Request frame. Access points that cloak themselves by not broadcasting their SSID require technique 1, but this scheme can cause scanning to take longer to complete. Use scan_ssid=1 if your network is hidden. Values: 0 = Default or 1

[GSM_MODEM]

Parameter	Description
ENABLE	Enables/disables the current gsm modem service and hardware. Values: 0 = Disabled or 1 = Enabled
APN	Sets the access point name (apn) required by some service providers.
USER	Sets the username used when the service provider requires authentication.
PASS	Sets the password used when the service provider requires authentication.
PIN	Sets the mobile SIM card PIN required when a lock code is applied to the SIM card.

[FTP]

Parameter	Description
UNIT_ID	To set the Vehicle Unique Identifier Values: one of characters 0-9 and A-Z.
FTP_HOST_NAME or FTP_SERVER_IP	IPv4 address of FTP server or URL The IP address (or URL) of the FTP server that the unit will attempt to connect to. Acceptable values of the format X.X.X.X where X can range from 0-255. Note: URL can be specified if DNS lookup available either via DHCP or by configuring DNS.
FTP_PORT	The port used when attempting to connect to the FTP server – value must be numerical. Default value: 21.
FTP_SERVER_USER_NAME	Username of FTP account The username required to log into the FTP server – 29-character limit
FTP_SERVER_PASSWORD	Password of FTP account The password required to log into the FTP server – 29-character limit
FTPSERVER_PAYLOAD_DIR	To set the FTP payload directory Part of the config for Wireless data manager. When a directory is set, this directory will be added at the beginning of the default payload directory that the unit will connect to and download the data file. If empty, then this will operate as default and no directory changes will be made.
FTPSERVER_MANIFEST_DIR	To set the FTP manifest directory Part of the config for Wireless data manager. This is the directory into which the unit will first look when it logs onto the FTP server. The unit will look for its manifest files in this folder. The manifest files tell the unit where on the server to look for data files (such as the database or a firmware file).
FTPSERVER_LOG_DIR	To set the FTP log directory Part of the config for Wireless data manager. This is the sub-directory into which the unit will place any log files. The log files are the mechanism by which the unit communicates its update progress back to the Wireless data manager application.
FTP_SERVER_ROOT	To set the root directory for all FTP operations
FTP_SERVER_DELAY_WAIT	Period within which the unit will poll the FTP server The amount of time in seconds that the unit should leave between attempting to connect to the FTP server – value must be numerical.
PASSIVE_MODE_ENABLE	To enable FTP passive mode access Values: 0 = Disabled or 1 = Enabled
CTRL_LOADING_ROUTEDEST	Route/destination pairs (up to 10 pairs) that must match the selected Route/destination for the unit to access the FTP server -1 -1 (loads file in any destination code, 0000 0001 loads list in only route no. 0, destination code 1 etc.). Multiple codes can be specified and separated by a comma.

[OBC]

Parameter	Description
VHTC_ENABLE	Enable virtual HTC terminal option in the settings menu of the user interface Values: 0 = Disabled (Default) or 1 = Enabled
VHTC_UDP_PORT	Set the port number of the virtual HTC Values: [0-65535]

[CAN1]

Parameter	Description
BITRATE_KBITS	Baud rate of CAN interface in kbit/s Valid values: [1000, 800, 500, 250, 125, 50, 20, and 10]
LOOPBACK	CAN Interface Control Mode Setting – Loopback allows transmitting nodes to receive their own data. Values: 0 = Disabled (Default) or 1 = Enabled
LISTEN_ONLY	CAN Interface Control Mode Setting – No transmit capability, locks the node to only listening. Values: 0 = Disabled or 1 = Enabled (Default)
FEATURES	Specifies the current Active CAN features desired on this interface. Comma separated list without whitespace. Values: STATE-OF-CHARGE

[CAN_ENTRY_x] where x is an incrementing value starting at 0 e.g. CAN_ENTRY_0.

Parameter	Description
MESSAGE_TYPE	<p>Specifies the type of message being defined by this Entry, allowing the system to place the data in the correct components and locations.</p> <p>Values: STATE_OF_CHARGE, CHARGING_STATUS, CHARGING_GUN_STATE</p>
ID	<p>Specifies the expected message CAN ID for this entry – This is OPTIONAL if a PGN has been provided instead.</p> <p>In the event both a CAN ID and PGN are provided, the CAN ID will be used as it is more specific, including source address and priority flags.</p> <p>Values: [0x00000000-0xFFFFFFFF] (Unsigned 32bit - Hex Format with preceding 0x)</p>
PGN	<p>Specifies the expected message PGN for this entry – This is OPTIONAL if a CAN ID has been provided instead.</p> <p>In the event both a CAN ID and PGN are provided, the CAN ID will be used as it is more specific, including source address and priority flags.</p> <p>Values: [0-4,294,967,295] (Unsigned 32bit - Decimal Format)</p>

Parameter	Description
BIT_MASK	<p>Specifies the required Unsigned 64bit Mask required to be applied to the data to extract the data of interest for this Message Type E.g. 0x00FF000000000000 will flag the data found in Byte 1, Bits 7-0 should be processed. (Assuming Bytes indicated as 0-7 and Bits 7-0)</p> <p>Values: [0x0000000000000000 - 0xFFFFFFFFFFFFFFFF] (Unsigned 64bit - Hex Format with preceding 0x)</p>
RANGES	<p>If not present or blank: Treats the whole range of incoming data for this entry as a literal value, Actions and Overrides should be similarly not present or blank</p> <p>Otherwise: Specifies the ranges of incoming data that will have different Actions and Overrides assigned to them. As such equal numbers of comma separate values are required in Ranges/Actions/Overrides so they can be mapped to each other.</p> <p>Values: Comma separated single integers or Hyphen separated integer ranges. E.g. 0-3,4,5-9,10</p>
ACTIONS	<p>Specifies the Action to be taken if the incoming data value is in the corresponding data range. REPLACEMENT_TEXT= should not contain commas, DISPLAY_LOOKUP_REFERENCE= is a Helen DB lookup which should have a corresponding entry in the Helen DB OVERRIDE_CONTROL_ONLY= No additional action to be taken, just examine the Overrides value and set accordingly. INVALID= Ignore this message</p> <p>Values: Comma separated actions from the below list where X is replaced with desired data for that instance.</p> <p>LITERAL REPLACEMENT_TEXT=XXXXX DISPLAY_LOOKUP_REFERENCE=SCXXXXXXXXX OVERRIDE_CONTROL_ONLY INVALID</p>

Parameter	Description
OVERRIDES	<p>Specifies whether an Override should be enabled, disabled or left in its current state when an incoming data value is in the corresponding data range. Enabling the override will attempt to surplant the currently displayed data on the Destination Signs unless a message of higher priority is already in effect (e.g. Emergency Message) Disabling the override will return the display to its previous lower priority message data.</p> <p>Values: Comma separated options from the below list:</p> <p>0 = Disable Override 1 = Enable Override * = Maintain current state</p> <p>E.g. 0,1,*,*</p>
SCALING	<p>Specifies the value by which the incoming CAN Data value should be multiplied to correctly scale for its intended meaning.</p> <p>Only functional when RANGES is empty or not present.</p> <p>Values: Float value - Negatives and decimal places allowed</p>
OFFSET	<p>Specifies the value that the incoming CAN Data value should have added to it to correctly offset the outcome for its intended meaning.</p> <p>Only functional when RANGES is empty or not present.</p> <p>Values: Float value - Negatives and decimal places allowed</p>
DECIMAL_PLACE_COUNT	<p>Specifies the number of Decimal places that the output should be trimmed to after calculation ready for display.</p> <p>Only functional when RANGES is empty or not present.</p> <p>Values: Number of Decimal places - Integer</p>

[TIME_ZONE]

Parameter	Description
TIME_ZONE	<p>To set the time zone of the controller.</p> <p>TIME_ZONE="Region"/"Country"</p> <p>For example: For Hong Kong, TIME_ZONE=Asia/Hong_Kong.</p> <p>Refer to table below for all available region/country.</p>

Region	Country				
Africa	Abidjan	Cairo	Juba	Maseru	Tunis
	Accra	Casablanca	Kampala	Mbabane	Windhoek
	Addis_Ababa	Ceuta	Khartoum	Mogadishu	
	Algiers	Conakry	Kigali	Monrovia	
	Asmara	Dakar	Kinshasa	Nairobi	
	Asmera	Dar_es_Salaam	Lagos	Ndjamena	
	Bamako	Djibouti	Libreville	Niamey	
	Bangui	Douala	Lome	Nouakchott	
	Banjul	El_Aaiun	Luanda	Ouagadougou	
	Bissau	Freetown	Lubumbashi	Porto-Novo	
	Blantyre	Gaborone	Lusaka	Sao_Tome	
	Brazzaville	Harare	Malabo	Timbuktu	
	Bujumbura	Johannesburg	Maputo	Tripoli	
	America	Adak	Cancun	Ensenada	Juneau
Anchorage		Caracas	Fort_Nelson	Kentucky	Monterrey
Anguilla		Catamarca	Fort_Wayne	Knox_IN	Montevideo
Antigua		Cayenne	Fortaleza	Kralendijk	Montreal
Araguaina		Cayman	Glance_Bay	La_Paz	Montserrat
Argentina		Chicago	Godthab	Lima	Nassau
Aruba		Chihuahua	Goose_Bay	Los_Angeles	New_York
Asuncion		Coral_Harbour	Grand_Turk	Louisville	Nipigon
Atikokan		Cordoba	Grenada	Lower_Princes	Nome
Atka		Costa_Rica	Guadeloupe	Maceio	Noronha
Bahia		Creston	Guatemala	Managua	North_Dakota
Bahia_Banderas		Cuiaba	Guayaquil	Manaus	Nuuk
Barbados		Curacao	Guyana	Marigot	Ojinaga
Belem		Danmarkshavn	Halifax	Martinique	Panama
Belize		Dawson	Havana	Matamoros	Pangnirtung
Blanc-Sablon		Dawson_Creek	Hermosillo	Mazatlan	Paramaribo
Boa_Vista		Denver	Indiana	Mendoza	Phoenix
Bogota		Detroit	Indianapolis	Menominee	Port-au-Prince
Boise		Dominica	Inuvik	Merida	Port_of_Spain
Buenos_Aires		Edmonton	Iqaluit	Metlakatla	Port_Acre
Cambridge_Bay	Eirunepe	Jamaica	Mexico_City	Porto_Velho	
Campo_Grande	El_Salvador	Jujuy	Miquelon	Puerto_Rico	

Region	Country				
America	Punta_Arenas	Santarem	St_Kitts	Toronto	
	Rainy_River	Santiago	St_Lucia	Tortola	
	Rankin_Inlet	Santa_Domingo	St_Thomas	Vancouver	
	Recife	Sao_Paulo	St_Vincent	Virgin	
	Regina	Scoresbysund	Swift_Current	Whitehorse	
	Resolute	Shiprock	Tegucigalpa	Winnipeg	
	Rio_Branco	Sitka	Thule	Yakutat	
	Rosario	St_Barthelemy	Thunder_Bay	Yellowknife	
	Santa_Isabel	St_Johns	Tijuana		
Antarctica	Casey	Macquarie	Palmer	Syowa	
	Davis	Mawson	Rothera	Troll	
	DumontDUrville	McMurdo	South_Pole	Vostok	
Asia	Aden	Chongqing	Jerusalem	Novokuznetsk	Tashkent
	Almaty	Chungking	Kabul	Novosibirsk	Tbilisi
	Amman	Colombo	Kamchatka	Omsk	Tehran
	Anadyr	Dacca	Karachi	Oral	Tel_Aviv
	Aqtau	Damascus	Kashgar	Phom_Penh	Thimbu
	Aqtobe	Dhaka	Kathmandu	Pontianak	Thimphu
	Ashgabat	Dili	Katmandu	Pyongyang	Tokyo
	Ashkhabad	Dubai	Khandyga	Qatar	Tomsk
	Atyrau	Dushanbe	Kolkata	Qostanay	Ujung_Pandang
	Baghdad	Famagusta	Krasnoyarsk	Qyzylorda	Ulaanbaatar
	Bahrain	Gaza	Kuala_Lumpur	Rangoon	Ulan_Bator
	Baku	Harbin	Kuching	Riyadh	Urumqi
	Bangkok	Hebron	Kuwait	Saigon	Ust-Nera
	Barnaul	Ho_Chi_Minh	Macao	Sakhalin	Vientiane
	Beirut	Hong_Kong	Macau	Samarkand	Vladivostok
	Bishkek	Hovd	Magadan	Seoul	Yakutsk
	Brunei	Irkutsk	Makassar	Shanghai	Yangon
	Calcutta	Istanbul	Manila	Singapore	Yekaterinburg
	Chita	Jakarta	Muscat	Srednekolymusk	Yerevan
	Choibalsan	Jayapura	Nicosia	Taipei	

Region	Country				
Atlantic	Azores	Cape_Verde	Jan_Mayen	South_Georgia	
	Bermuda	Faeroe	Madeira	St_Helena	
	Canary	Faroe	Reykjavik	Stanley	
Australia	ACT	Currie	Lindeman	Perth	Victoria
	Adelaide	Darwin	Lord_Howe	Queensland	West
	Brisbane	Eucla	Melbourne	South	Yancowinna
	Broken_Hill	Hobart	NSW	Sydney	
	Canberra	LHI	North	Tasmania	
Europe	Amsterdam	Copenhagen	London	Riga	Ulyanovsk
	Andorra	Dublin	Luxembourg	Rome	Uzhgorod
	Astrakhan	Gibraltar	Madrid	Samara	Vaduz
	Athens	Guernsey	Malta	San_Marino	Vatican
	Belfast	Helsinki	Mariehamn	Sarajevo	Vienna
	Belgrade	Isle_of_Man	Minsk	Saratov	Vilnius
	Berlin	Istanbul	Monaco	Simferopol	Volgograd
	Bratislava	Jersey	Moscow	Skopje	Warsaw
	Brussels	Kaliningrad	Nicosia	Sofia	Zagreb
	Bucharest	Kiev	Oslo	Stockholm	Zaporozhye
	Budapest	Kirov	Paris	Tallinn	Zurich
	Busingen	Lisbon	Podgorica	Tirane	
	Chisinau	Ljubljana	Prague	Tiraspol	
Indian	Antananarivo	Cocos	Mahe	Mayotte	
	Chagos	Comoro	Maldives	Reunion	
	Christmas	Kerguelen	Mauritius		
Pacific	Apia	Fiji	Kiritimati	Noumea	Samoa
	Auckland	Funafuti	Kosrae	Pago_Pago	Tahiti
	Bougainville	Galapagos	Kwajalein	Palau	Tarawa
	Chatham	Gambier	Majuro	Pitcairn	Tongatapu
	Chuuk	Guadalcanal	Marquesas	Pohnpei	Truk
	Easter	Guam	Midway	Ponape	Wake
	Efate	Honolulu	Nauru	Port_Moresby	Wallis
	Enderbury	Johnston	Niue	Rarotonga	Yap
	Fakaofu	Kanton	Norfolk	Saipan	

Appendix C-2: Updating the Config.ini file on the EG4

The Config.ini file can be placed on the same USB alongside the destination list and other Hanover devices configurations file(s).

i. Preparing the USB flash memory drive

Prepare the USB flash memory drive as follows:

Step	Description
1	Insert the USB flash memory drive into the PC. It appears as USB DRIVE (D:) . Note: The name and drive letter are variable and in this case, the drive letter allocated to the USB flash memory drive by the PC is 'D:'.
2	Create the following location on the USB: \\hanover\eg4

ii. Loading the Config.ini file to the USB flash memory drive

Load the Config.ini file to the USB flash memory drive as follows:

Step	Description
1	Save the Config.ini file on the USB in the location created in above step 2.
2	'Safely remove' the USB flash memory drive from the PC. To do so, look for "Safely remove Hardware" icon on the taskbar. Right-click the icon and select the hardware you want to remove.

iii. Loading the Config.ini file to the EG4

Transfer the Config.ini file from the USB flash memory drive to the EG4 as follows:

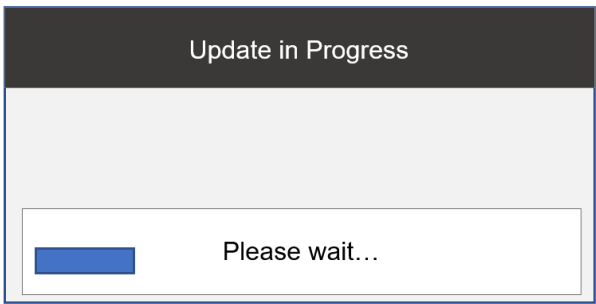
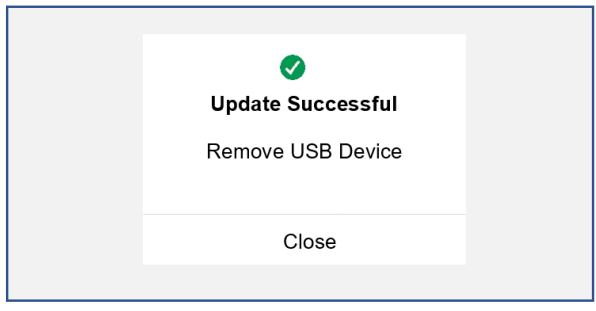
Step	Description	Figure
1	Insert the USB flash memory drive into the port in the front of the destination controller.	
2	The EG4 will automatically find the Config.ini file – the destination controller will transfer and save the database.	
3	When update is complete, the destination controller will display "Update Successful" and "Remove USB Device". Tap "Close" and the USB flash memory drive can be removed. The Config.ini file has been updated on the EG4.	

Appendix D : Virtual HTC Terminal

The Virtual HTC Terminal allows the modification of parameters via the:

- [Appendix E-5: Settings Menu](#)
- [Appendix E-2: Simulation Menu](#)
- [Appendix E-3: Volumes Menu](#)
- [Appendix E-4: System Tests](#)

Appendix D-1: Access to Virtual HTC Terminal

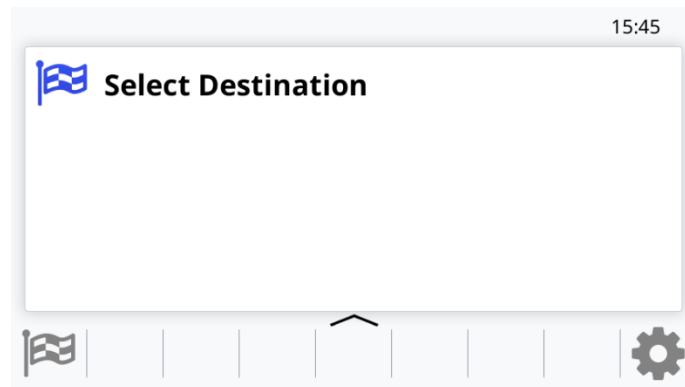

The function 'Virtual HTC Terminal' is accessed using the settings icon () on the front panel of the destination controller.

It is shown as **Settings**:

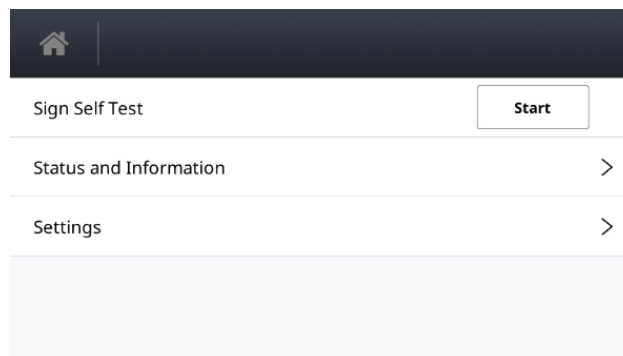

Selecting "Settings" will request a 4-digit passcode.

Once the 4-digit passcode is entered followed by the ✓ (green tick), the EG4 destination controller will show the following options:

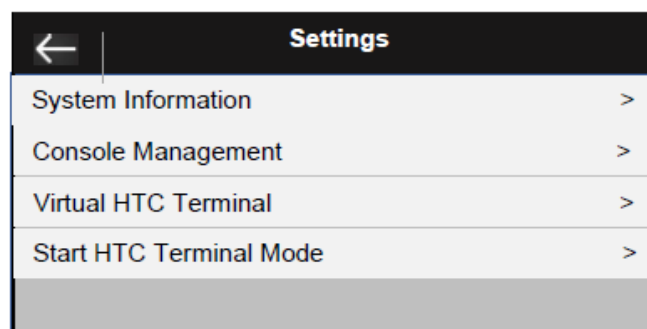

Selecting 'Virtual HTC Terminal' will now enter the 'Driver Menu'.

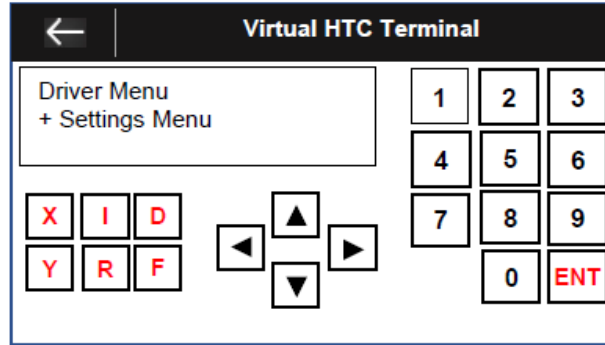

The flow chart below shows the procedure for accessing the different options of the Virtual HTC Terminal:

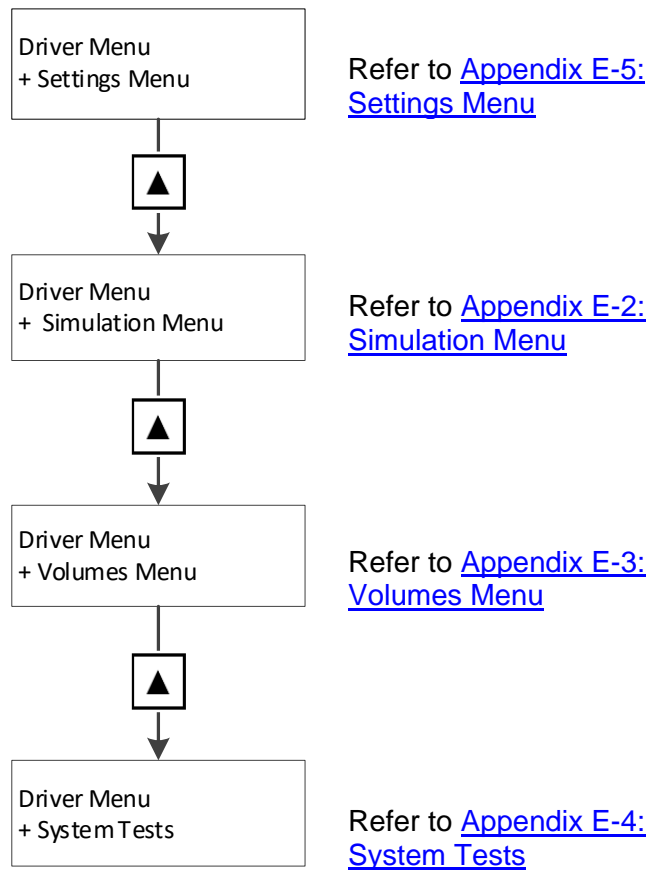



Appendix E: HTC Terminal Mode

The HTC Terminal Mode allows the modification of parameters via the:

- [Appendix E-2: Simulation Menu](#)
- [Appendix E-3: Volumes Menu](#)
- [Appendix E-4: System Tests](#)
- [Appendix E-5: Settings Menu](#)

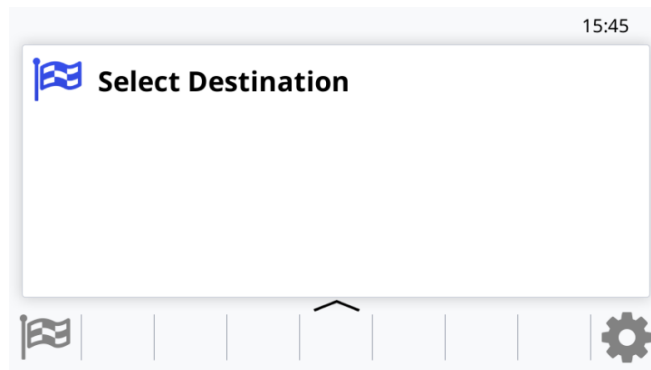
Appendix E-1: Access to HTC Terminal Mode



The function 'HTC Terminal Mode' is accessed using the settings icon () on the front panel of the destination controller.

It is shown as **Settings**:

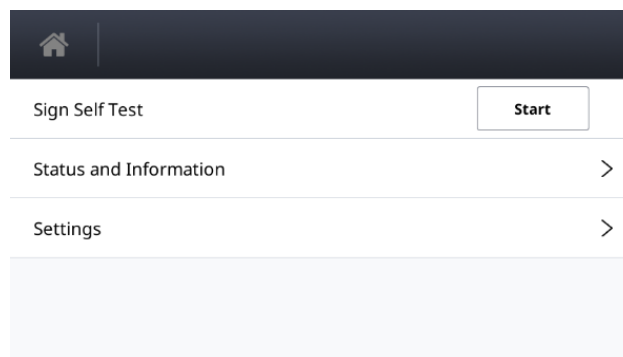

Selecting "Settings" will request a 4-digit passcode.

Once the 4-digit passcode is entered followed by the ✓ (green tick), the EG4 destination controller will show the following options:

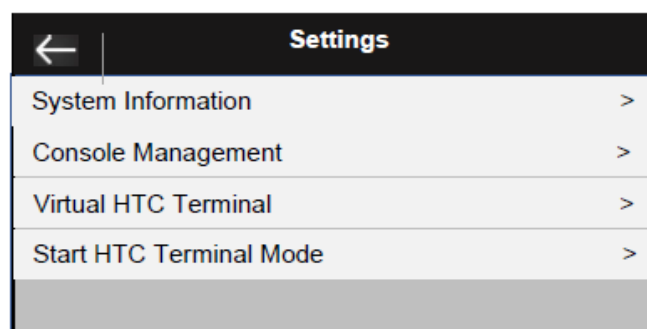

Selecting 'Start HTC Terminal Mode' will now enter the 'HTC Terminal Menu'.

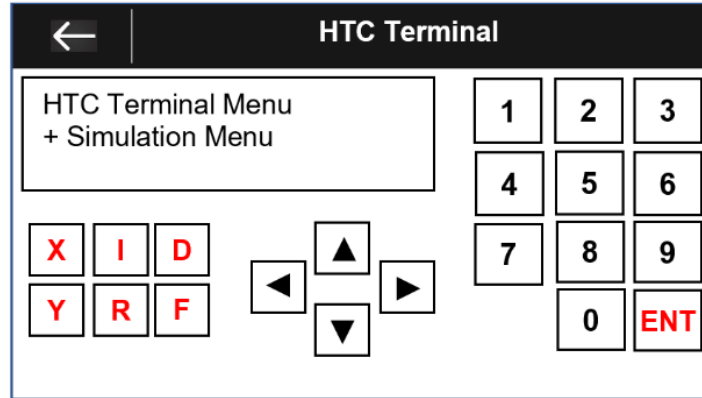

The flow chart below shows the procedure for accessing the different options of the HTC Terminal Menu:

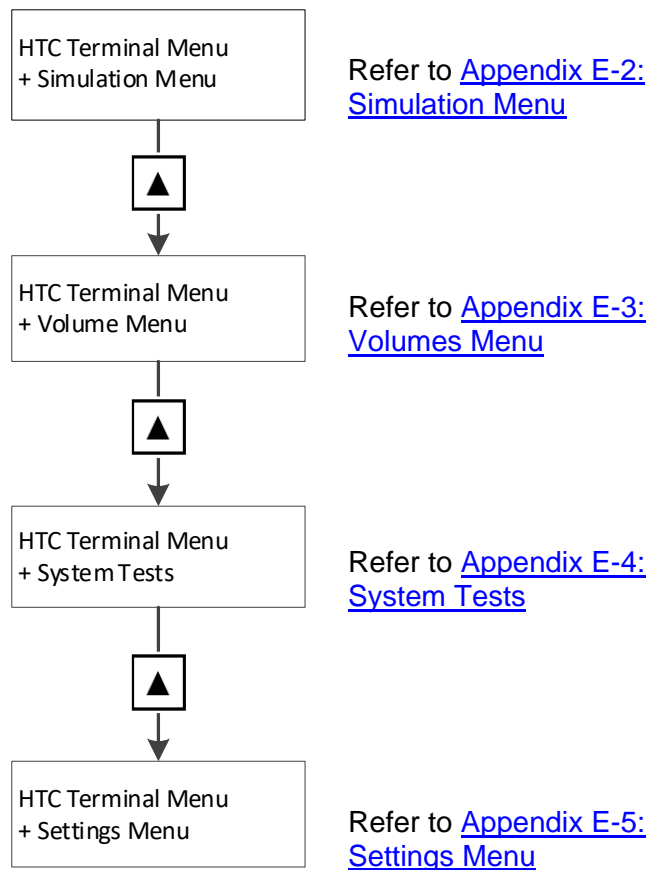

Appendix E-2: Simulation Menu

The flow chart below shows the procedure for accessing the different options of the Simulation Menu:

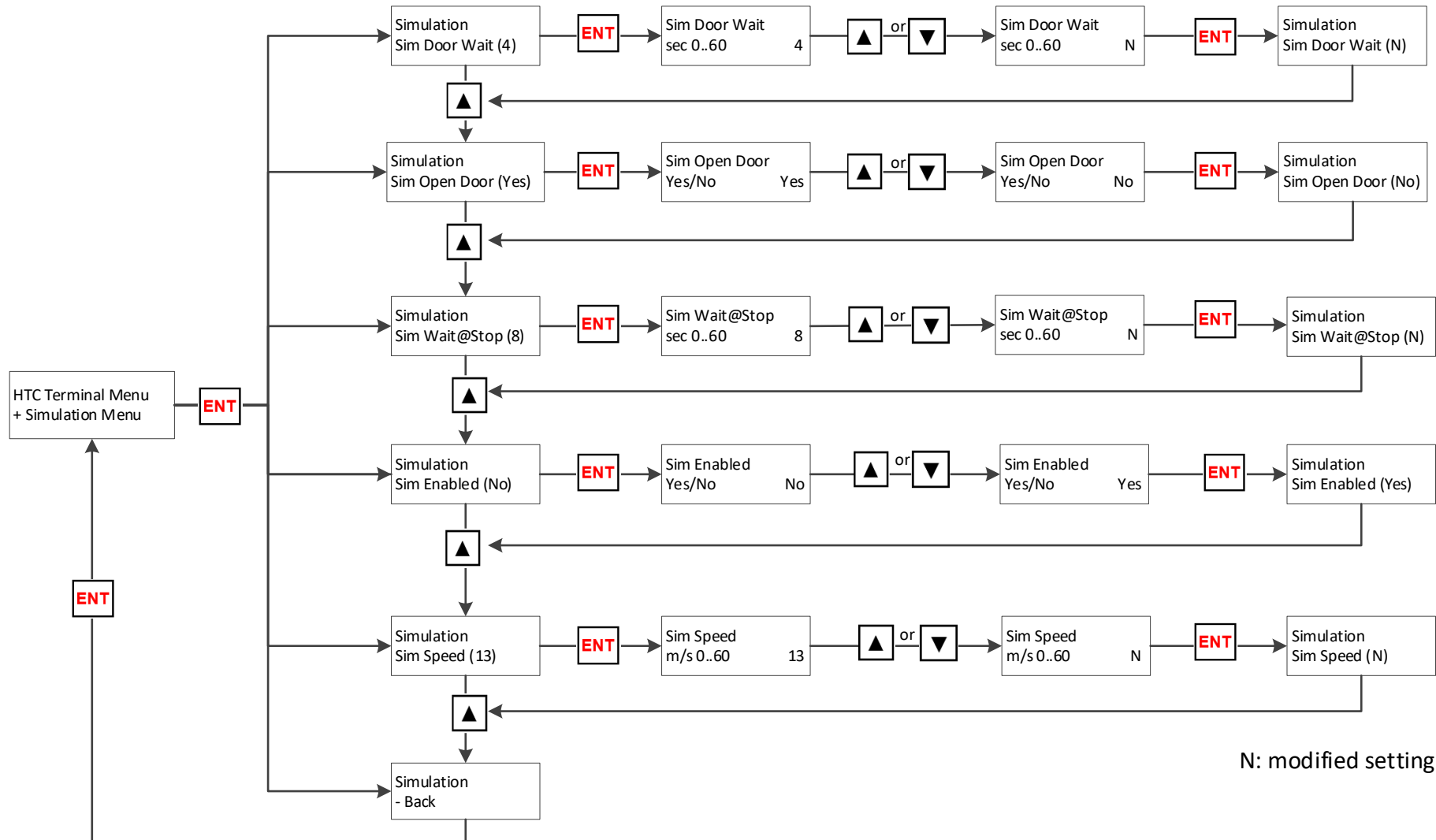

Appendix E-3: Volumes Menu

The flow chart below shows the procedure for accessing the different options of the Volumes Menu:

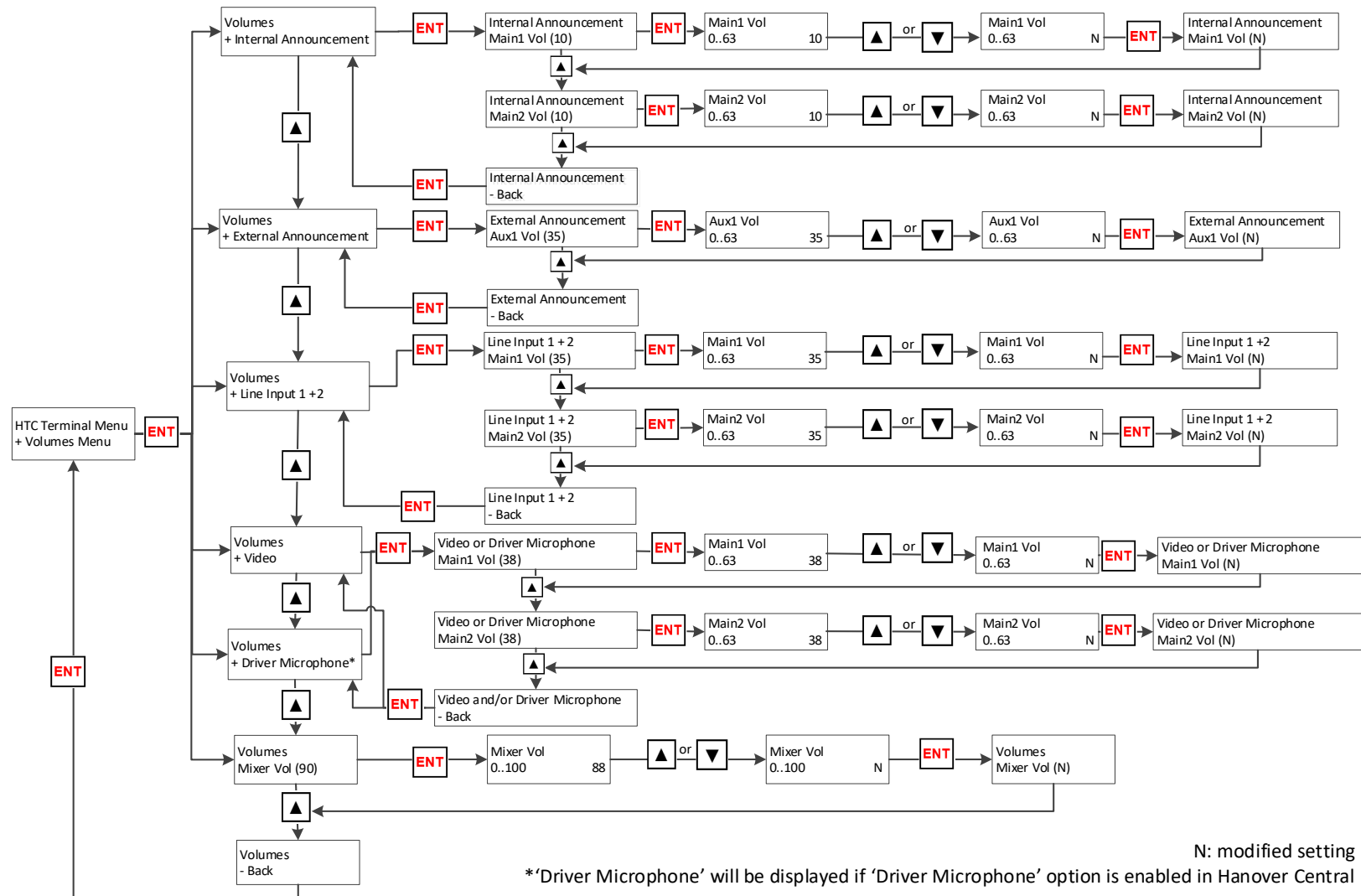

Appendix E-4: System Tests

The flow chart below shows the procedure for accessing the different options of the System Tests:

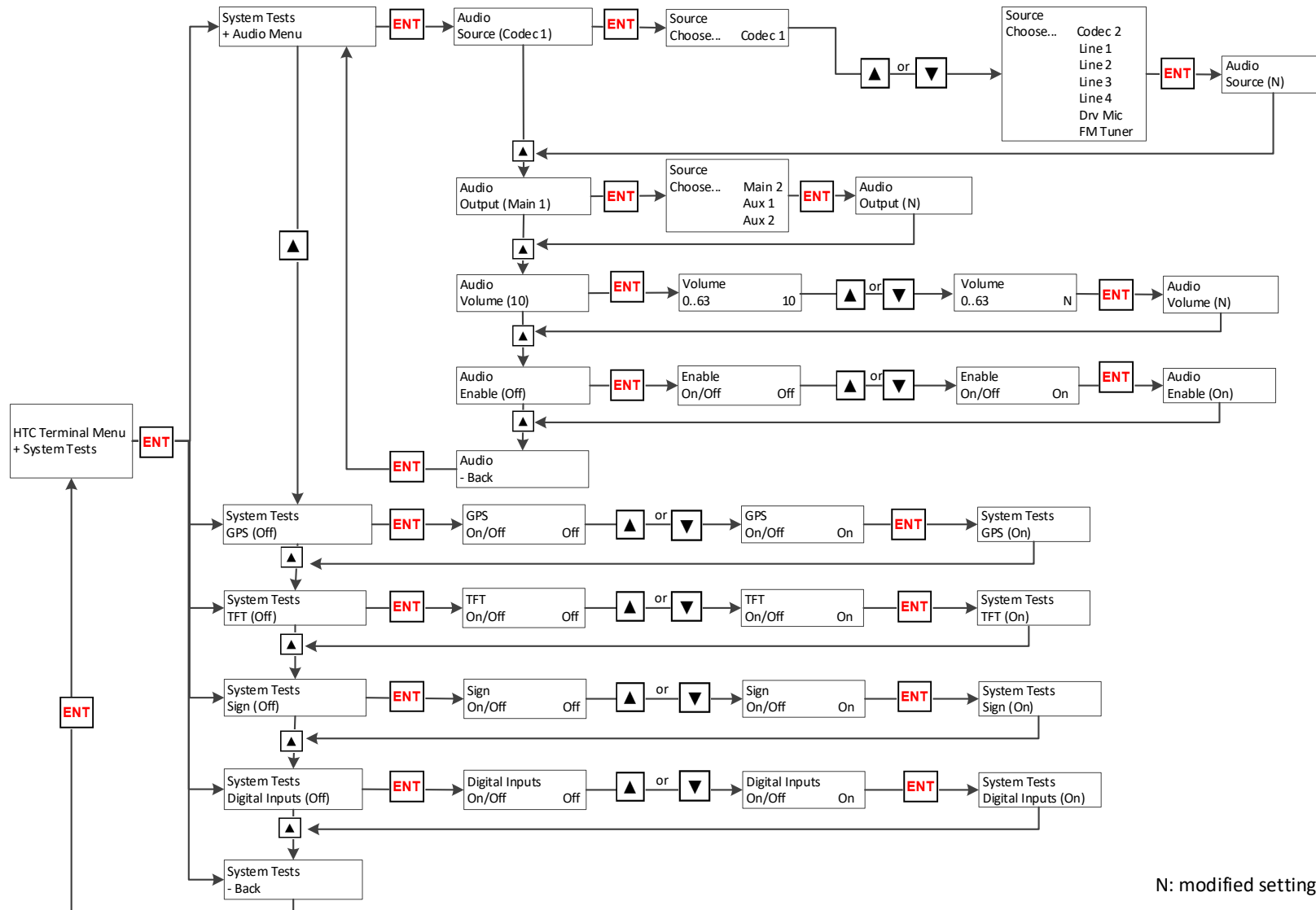

Appendix E-5: Settings Menu

The flow chart below shows the procedure for accessing the different options of the Settings Menu:

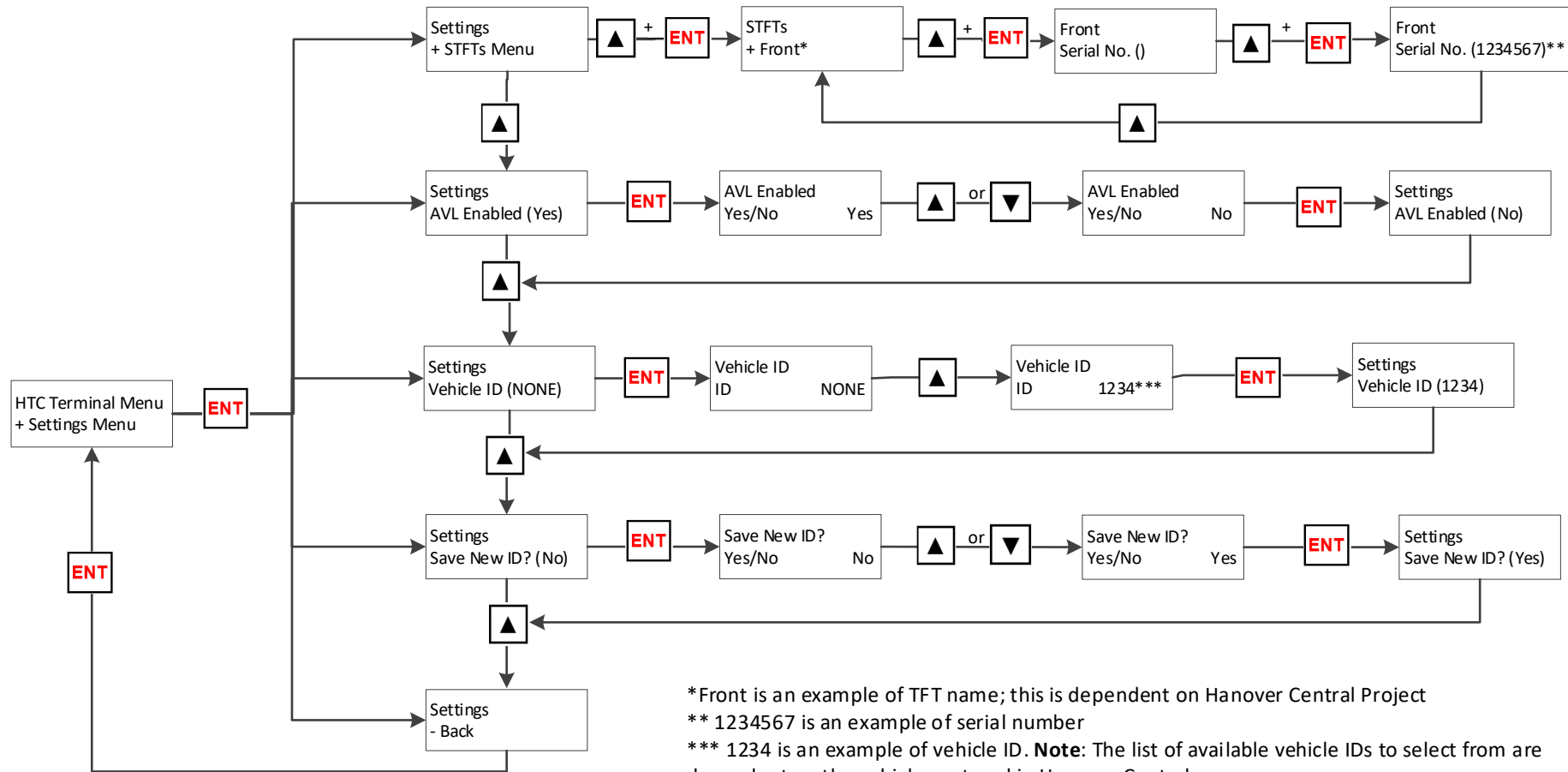

Appendix F: Parameter Settings in HELEN Software

This appendix lists the parameters that can be set via HELEN software (in the 'Extensions' box):

Feature	Parameter	Values	Description
Default configs	!!	1	If !=1 not present in database config, all parameters will be set to default before loading new configs.
Autobaud ping period	ABP	0 - 60	The time between autobaud ping messages in seconds (default = 5s). If ABP is set to 0, autobaud ping will be turned off.
Advertising Signs	AL	0 - 4	Sets the quantity of advertising signs connected to the destination controller and causes their addresses to be numbered immediately following the last-addressed destination display. Note: This is not the preferred method of address-setting for the advert destination displays; it is better done from within the HELEN software, using the expression Sn=EX (where n= the address number of the destination display carrying the advertising message).
Auto/Man menu enable	AM	0 = disabled 1 = enabled	If this is active (AM=1), a prompt "AUTO/MAN" is available from behind the lock code. The destination controller can be fixed into 'auto' (where it is not possible for the driver to alter the destination) or 'man' (where only driver-entered destination codes will be accepted).
Destination Announcement Repeat Period	ADR	0 - 100000	Refer to Audio Settings . Sets the repeat of the destination message during a defined period i.e ADR = xxxxxx where xxxxxx is the time in ms.
Stop Destination Announcement on De-active Event	ADS	0 = disabled 1 = enabled	Refer to Audio Settings . Allows the destination audio file to be interrupted as soon as the trigger is no longer active.
Trigger Destination Announcement on Input Event	ADT	0 = automatically scheduled 1 = triggered off input event	Refer to Audio Settings . Allows to select how the destination audio announcement would be played.

Feature	Parameter	Values	Description
Information Announcement Repeat Period	AIR	0 - 100000	Refer to Audio Settings . Sets the repeat of the information message during a defined period i.e AIR = xxxxxx where xxxxxx is the time in ms.
Stop Information Announcement on De-active Event	AIS	0 = disabled 1 = enabled	Refer to Audio Settings . Allows the information audio file to be interrupted as soon as the trigger is no longer active.
Trigger Information Announcement on Input Event	AIT	0 = automatically scheduled 1 = triggered off input event	Refer to Audio Settings . Allows to select how the information audio announcement would be played.
Prompt for Advert Number	AN	0 = disabled 1 = enabled	Controls: <ul style="list-style-type: none"> • advert only messages on internal destination displays and • advert number prompt on the destination controller screen
Auto Load Transfer Speed	AS	2400, 4800, 9600, 19200, 38400, 57600, 115200	Sets transfer speed of sign firmware updating (for e.g. an oled.bin file)
Stop Announcement Repeat Period	ASR	0 - 100000	Sets the repeat of the stop message during a defined period i.e ASR = xxxxxx where xxxxxx is the time in ms.
Stop Stop Announcement on De-active Event	ASS	0 = disabled 1 = enabled	Allows the stop audio file to be interrupted as soon as the trigger is no longer active.
Trigger Stop Announcement on Input Event	AST	0 = automatically scheduled 1 = triggered off input event	Allows to select how the stop audio announcement would be played.
Audio Output Function	AU1	D = Destination announcements I = Information announcement S = Stop announcements	Assigns the audio output to an audio function. Multiple functions can be assigned by chaining values.

Feature	Parameter	Values	Description
Audio Output Function	AU2	D = Destination announcements I = Information announcement S = Stop announcements	Assigns the audio output to an audio function. Multiple functions can be assigned by chaining values.
Audio Output Function	AU3	D = Destination announcements I = Information announcement S = Stop announcements	Assigns the audio output to an audio function. Multiple functions can be assigned by chaining values.
Audio Output 0 Startup Delay	AUSD0	0 - 5000	Refer to Audio Settings . Delay in milliseconds before playing audio to allow the external audio amplifier to start up.
Audio Output 1 Startup Delay	AUSD1	0 - 5000	Refer to Audio Settings . Delay in milliseconds before playing audio to allow the external audio amplifier to start up.
Audio Output 2 Startup Delay	AUSD2	0 - 5000	Refer to Audio Settings . Delay in milliseconds before playing audio to allow the external audio amplifier to start up.
Audio Output 0 Volume	AUV0	0 - 100	Refer to Audio Settings . Audio output 0 volume as a percentage of the maximum supported by the output.
Audio Output 1 Volume	AUV1	0 - 100	Refer to Audio Settings . Audio output 1 volume as a percentage of the maximum supported by the output.
Audio Output 2 Volume	AUV2	0 - 100	Refer to Audio Settings . Audio output 2 volume as a percentage of the maximum supported by the output.
Blank Code	BC	x where: x is the specific destination code	Ability to set the controller to a specific destination code when in idle rather than to blank the signs.
Battery Charge (Auto)	BCA	0 = disabled 1 = enabled	BCA=1 turns on automatic display of charging message when charger is connected. Works only with CAN interfaces which have been specifically designed to show Battery charge status.
Browse to Idle	BI	0 = disabled	Allows:

Feature	Parameter	Values	Description
		1 = Browse to Idle is only allowed if RM=1 2 = Browse to Idle is always allowed	<ul style="list-style-type: none"> destination browse to include destination 0000 and route code 0000 to browse to Idle in route browse mode
Destination Browser	BR	0 = disabled 1 = enabled	Requires Destination to be enabled (DN=1) and is not available if 'Route Browse' enabled (RB=1). Note: Do not confuse this code with that for bus reversing, which is set as an external input option - please refer to section Displaying 'Bus reversing' .
Blanking Timer	BT	0 - 100	Refer to section Connected Equipment . Blanking timer in minutes (used with battery guard feature - please refer to section Blanking the destination display (battery guard) .
Brightness Limit	BL	0 - 100 where: 0 = 100% (maximum brightness) 100 = 0%	Refer to section Connected Equipment . Brightness limit of destination displays during BT-defined period (please refer to BT above) following which, destination displays go blank - please refer to Blanking the destination display (battery guard) .
Confirm Browse	CB	0 = does not prompt 1 = prompts	Prompts for selection confirmation when driver browses destinations in a route.
Time Entry	CC	Inn	Information code: parameter CC=Inn is included in the database config. The info code nn will be automatically set when the countdown time value is entered. When the time value runs down to zero, this info code will be automatically cancelled. For CC=Inn to function, make sure to have IN=1 or information selected in HELEN software.
Canned Vox	CM	0 = disabled 1 = enabled	If CM=1, just pressing any of the numeric keys 0-9 will cause a hanvox play command to be sent for playing files called M0.mp3 to M9.mp3.
Display Brightness	DB	AUTO and/or 0-100	Refer to Display . Specifies the display brightness of the destination controller. The value contains 1 or 2 items separated by a plus sign '+'. The first item is the brightness which can be either AUTO or a value between 0-100. The second item specifies a range 0-100 which is the minimum and maximum brightness. Examples: <ul style="list-style-type: none"> DB=80: Set brightness to 80% fixed

Feature	Parameter	Values	Description
			<ul style="list-style-type: none"> DB=75+5-80: Set brightness to 75% fixed, brightness must be in the range of 5% to 80% DB=AUTO: Set automatic brightness using default maximum DB=AUTO+5-80: Set automatic brightness in the range 5% to 80% <p>Note: if the parameter DB/value is not present, the existing setting will be unaffected.</p>
Driver's Display	DD	<p>* = use of driver's destination controller display text from HELEN</p> <p>0 - 9, A - E = show content from selected destination display on driver's display</p>	Determines what is shown on driver's destination controller display.
Driver's ID	DI	<p>0 = disabled</p> <p>1 - 5 = number of digits allowed</p>	<p>Prompt for driver's ID (i.e. PIN).</p> <p>This is used by the HTC, Hancis etc: when activated, it leads to PIN request. ID number length is set by DI value.</p>
Display Mode	DM	<p>0 = use of only the top line of the destination controller screen</p> <p>1 = use of the top two lines of the destination controller screen</p> <p>2 = attempts a 'best-fit' of driver's message within destination controller screen (if necessary, by re-sizing)</p> <p>T = shows time in hours, mins, secs (24h clock) - where clock is enabled</p> <p>T12, T12S, T24, T24S = displays (12h / 24h) clock without / with seconds - where clock is enabled</p>	Controls how driver's message is displayed on the destination controller screen
Prompt for Destination Number	DN	<p>0 = no</p> <p>1 = yes</p>	<p>Refer to section Destination code.</p> <p>In standard destination mode: it controls if</p> <ul style="list-style-type: none"> destination information and numbers are shown on the passenger destination displays and destination codes can be viewed and changed on the destination controller. <p>In route browse mode: this feature has no effect.</p>

Feature	Parameter	Values	Description
Display Off Timeout	DO	0 - 120	Refer to Display . Specifies the amount of time in seconds following the last interaction by the user on the controller before the controller display turns off. Note: if the parameter DO/value is not present, the existing setting will be unaffected.
Destination Code Size	DS	3 - 8	Controls the size of the destination code shown on the destination controller screen; it can be set from 3 to 8 digits.
Display Inactivity Timeout	DT	0 - 120	Refer to Display . The period of time between the last interaction by a user on the controller and when the controller display dims. Setting 0 disables the timeout. Note: if the parameter DT/value is not present, the existing setting will be unaffected.
Escaped Binary	EB	0 = disabled 1 = enabled	When switched on, this option allows faster delivery of information to the destination display and is thus used to speed up delivery of large-sized graphic messages. Note: It has no effect on Super-X messages, whether or not they contain graphic images.
Encoding Format for Configuration File	FMT0	ANSII or UTF-8	Specifies the character encoding of an incoming USER.BIN configuration section. Default: ANSII (assumed when parameter is absent)
Group Browse	GB	0 = disabled 1 = Mode 1 2 = Mode 2	Variations on Route-Browse. Mode 1: When a route no. is entered with the 'R' key, the user can then browse all entries with this route no., but also any other destinations which share the same 3 'group' digits (if not 000). When subsequently browsing with the Up and Down keys, the entries available will be those provided by the original Route no. entry with 'R' key, not the currently active route no. which may be different. Mode 2: 'SBS lookup' mode, which requires a specially ordered database (customer specific).

Feature	Parameter	Values	Description
Hide Adverts	HA	0 = does not require lock code 1 = requires lock code	Adverts are shown on passenger destination displays and the advert code is shown on the destination controller screen. This feature controls whether changing the advert code requires the lock code.
Hide Destination	HD	0 = does not require lock code 1 = requires lock code	Destination is shown on passenger signs and the destination code is shown on the controller screen. This feature controls whether changing the destination code requires the lock code.
Hide Information	HI	0 = does not require lock code 1 = requires lock code	Information is shown on passenger signs and the information code is shown on the controller screen. This feature controls whether changing the information code requires the lock code.
HTC Timer1	HT1	0 - 100	Configurable time delay that causes the EG4 to wait the defined time before transmitting update information. This is to allow the user time to enter both a new Route number and Destination number before the message is sent to the HTC. Unit of measure: Seconds (Default = 10 Seconds)
HTC Hot Key Enable	HTK	0 = disabled (default) 1 = enabled	Used for enabling the HTC hot keys. These are used by sending an ascii digit 0-9 to the HTC terminal.
HTC Hot Key Icon	HTI	DEFAULT = use the generic HTC icon (default) ANNOUNCEMENT = use the audio announcement icon	Used to select the required icon for the home screen HTC hot icon.
Inactivity Brightness Adjust	IA	0 – 100	Refer to Display . The percent brightness to set the controller display when display dimming is triggered. Default: 0. Attempt to dim above the current brightness will result in no change in brightness. Note: if the parameter IA/value is not present, the existing setting will be unaffected.
Database ID	ID	x	Refer to Status and Information .

Feature	Parameter	Values	Description
		where: x is the name set in profile	Name set in profile of destination controller config (optional)
External Input 0	I0	-, 1, 1A, 1B, 1C, 2 ... 10, IN, INI, DV, DVI, BR, BRI	Please refer to section Digital I/O . Note: AL1 to AL4: 4 messages which work in the same way as Bus Stopping, in that they are only displayed on destination displays which have data for this message in the database. Requires additional parameter to be added to database (in 'Advanced' extensions box in HELEN): AL1=nnnn where nnnn is the database code containing the message to be displayed (AL1I to AL4I means input sense is inverted) e.g. I0 = AL4, AL4=9996.
External Input 1	I1	-, 1, 1A, 1B, 1C, 2 ... 10, IN, INI, DV, DVI, BR, BRI	Please refer to section Digital I/O . Note: AL1 to AL4: 4 messages which work in the same way as Bus Stopping, in that they are only displayed on destination displays which have data for this message in the database. Requires additional parameter to be added to database (in 'Advanced' extensions box in HELEN): AL1=nnnn where nnnn is the database code containing the message to be displayed (AL1I to AL4I means input sense is inverted) e.g. I1=AL2, AL2=9998.
External Input 2	I2	-, 1, 1A, 1B, 1C, 2 ... 10, IN, INI, DV, DVI, BR, BRI	Please refer to section Digital I/O . Note: AL1 to AL4: 4 messages which work in the same way as Bus Stopping, in that they are only displayed on destination displays which have data for this message in the database. Requires additional parameter to be added to database (in 'Advanced' extensions box in HELEN): AL1=nnnn where nnnn is the database code containing the message to be displayed (AL1I to AL4I means input sense is inverted) e.g. I2=AL3, AL3=9994.
Inactivity Brightness Adjust	IA	0 – 100	The percentage of brightness to set the destination controller display when display dimming is triggered. Default is 0. Attempt to dim above the current brightness will result in no change in brightness. If the key/value is not present, the existing setting will be unaffected.
Information Code Trigger	IC	nn where nn = 01 - 99	Information code triggered by external input. Requires additional parameter to be added to database (in 'Advanced' extensions box in HELEN): IC=nn.
Home Screen Icon Order	ICN	DN - Select Destination RT - Set round trip	The setting is a string and uses 2 letter codes that must match the short_name that is present in each icon. Each letter code must be separated by a non-

Feature	Parameter	Values	Description
		RN - Set Route Number IN - Select Information Messages DT - Set Departure time FA - Show Faults screen SR - Set Service Run HK - HTC hot key ST - Settings LO - Logout driver. UA - Destination Change Up arrow DA - Destination Change Down arrow SC - State of Charge	alphanumeric character. This character may be anything other than comma (,), colon (:) or hyphen (-). So, space (), full stop (.) or forward slash (/) is fine. Any icon not present in the string will be auto placed. Any letter codes not recognised will be ignored. Using a hyphen '-' will generate a gap. The string orders the icons left to right, top to bottom. If more fields are present than supported, the additional fields are ignored.
Prompt for Information Number	IN	0 = no 1 = yes (and can be changed)	Controls whether: <ul style="list-style-type: none"> information code is visible or accessible on the destination controller, and information is shown on the passenger destination displays Note: An information message can be selected on activation of the external input. The message is enabled by adding the parameter IC = nn, where nn = 01 – 99 in the 'Extensions' box of HELEN software. Refer to Information message .
Ext IP INFO mode	IP	0 = The system behaves as with a normal HELEN-configured information message. 1 - 8 = The number of destination pages is limited to this value. After they have all been shown, the information message is shown. X = The information page is shown after every individual destination page.	Determines how the information pages are presented when an information message is externally (using IN/INI) selected. For externally activated information messages, refer to Information message .
Global INFO mode	IPG	0, ..., 8, X	Behaves in the same way as IP=n but affects all other INFO messages (IP=n only affects externally triggered info message).
J1708 parameter	JBS	0000-9999	J1708 Bus stopping feature: sends out J1708 'M' text messages to destination displays connected to the J1708 bus.

Feature	Parameter	Values	Description	
			Message by default will be “Stop Requested”. This message can be changed by programming a text message in the database under destination code BSnnnnnnnn. The value of JBS is a representation of the addresses (0 – 9) of up to 4 destination displays to display the message on. E.g. JBS=0002 – only shows bus stopping on destination display address 2 or JBS=6780 – displays message on destination displays 6, 7 and 8. Also, the external input must be configured as Bus Stopping e.g. I1=BS	
	JDF	DEFAULT, HEX, DEC	J1708 - Selects HEX or Decimal number format for ‘D’ message.	
	JPF	DEFAULT, HEX, DEC	J1708 - Selects HEX or Decimal number format for ‘P’ message.	
	JRF	DEFAULT, HEX, DEC	J1708 - Selects HEX or Decimal number format for ‘R’ message.	
	JOF	DEFAULT, HEX, DEC	J1708 - Selects HEX or Decimal number format for ‘O’ message.	
Lock Code	LC	0000 - 9999	Refer to Passcodes and Permissions . This is the code the user has to enter to access the settings of the EG4.	
Language	LG	DA - Danish EN - English FI - Finnish FR - French DE - German HE - Hebrew ID - Indonesian IT – Italian	PT - Portuguese ES - Spanish SV - Swedish NO- Norwegian RO - Romanian TR - Turkish ZH - Chinese NL - Dutch	Refer to Language . Determines the language used by destination controller (Not all languages are programmed into HELEN by default)
Internal Sign Number	LN	- = no setting (disabled) * = automatic assignment 0...31 = number of destination display assigned by HELEN EX = adverts HV = Hanvox voice announcement system	This is the physical sign address of the internal sign (if connected directly to the EG4)	

Feature	Parameter	Values	Description
		HANCIS/HTC = Hancis (or HTC) on-board computer RN = To use this feature, you have to configure a destination display to be “RN” NN = Driver-entered Run No. feature. To use this feature, you have to configure a destination display to be “NN”	
Sign Test Maintenance Lock	LS	0 = always accessible (default) 1 = behind the maintenance lock code	Indicates whether the sign test operation on the user interface should be always accessible or behind the maintenance lock code.
Lock Terminal Mode	LT	0 = disabled 1 = enabled	When enabled, it will challenge the driver for the lock code when trying to enter the terminal mode by holding down the Ent key. An incorrect lock code will still allow the viewing of the Status Pages.
Port Mapping (port n)	MPn (n: 0 to 5)	0 - 5	Refer to Port Mapping . Maps the setting from the specified serial port (protocol assignment) Example: MP0=2 means the protocol is set to port 0 but is physically wired into the EG4 on port 2.
Multipage SuperX	MPSX	0 = disabled 1 = enabled	Allows Multipage messages to synchronise to Info messages. MPSX messages are SuperX messages which are concatenated together as a single database field – the destination display then controls the page timings. Setting of this parameter is required if the database contains any MPSX messages.
Override Destination Browse to use code entry	OB	0 = disabled 1 = enabled	Overrides the BR setting so that the same eric.bin files can be used on EG3/DG3
Digital Output 0 Assignment	OU0	AU (Audio amp output) AUI (Audio amp output inverted)	Assigns the digital output 0 function. When the function is triggered, it will provide +24V to a connected device. Example: To control a PA amplifier to indicate when the EG4 is making an announcement.

Feature	Parameter	Values	Description
Digital Output 1 Assignment	OU1	AU (Audio amp output) AUI (Audio amp output inverted)	Assigns the digital output 1 function. When the function is triggered, it will provide +24V to a connected device. Example: To control a PA amplifier to indicate when the EG4 is making an announcement.
Port #n configuration	Pn (n: 1 to 5)	x where: x is an available protocol. Refer to Appendix B: Serial Ports for the list of available protocols.	Protocol set to the port
Profile	PF	Name 0 – Name 99	Profile of destination controller Example: PF=x where x is the value of the profile
Power Save Mode Support	PST	x where x is in seconds.	Configuration parameter PST is added for low power delay in seconds. Default delay is 30 minutes. EG4 will enter low power mode in case the vehicle ignition is OFF for PST amount of time.
Comms Loss Sign Page Updates	PU	0 = disabled 1 = enabled	Continue sending sign page updates during comms loss. Default is 0.
Display Bad Destination	QF	0 = disabled 1 = sends destination code to destination controller screen and connected destination displays if 'bad destination'	Instead of 'Bad destination' appearing on the EG4 screen, the relevant destination code is sent as a text message to the destination displays and is also shown on the destination controller.
Display of information message if no destination set	QG	0, 1, 2, 10, 11, 12	<ul style="list-style-type: none"> If QG=0; if an info message is selected but no destination is selected on the EG4 then the info message will not be displayed on the signs. If QG=1; if an info message is selected but no destination is selected on the EG4 then the info message will be displayed on the signs. If QG=2; then only if there is a blanking code (set by parameter BC=xxxx) active will the Info message be displayed (alternated with blanking message) if no destination is set. QG=10 is the same as QG=0, QG=11 is the same as QG=1 and QG=12 is the same as QG=2 except if you select a destination and an info message has already been selected, the info message will be automatically cleared on the EG4 and from the signs.

Feature	Parameter	Values	Description
			With QG set to 10, 11 or 12 you can select an info message after a destination has been selected, and that info message will then be displayed on the EG4 and signs, but if you then select another destination the info message will be automatically cleared again.
Dash Sign Display Preference	QH	0 = disabled 1 = enabled	<ul style="list-style-type: none"> If QH=1, then any destination display configured as RN or NN (driver-entered No/text display) will only display the driver-entered No/text if there is no database entry for this destination display under the current destination. If there is database data present, it will be displayed instead. If QH=0, then the driver-entered No/text will always be displayed. When used with J1708-1/2, the Dash destination display is fixed at #7. So, to use NN as manual dash destination display, make S7=NN and QH=1.
Timed Information	Qn (n: 1 to 4)	01/01 – 31/12 00:00 – 23:59	Configurable date and time sensitive info messages <ul style="list-style-type: none"> When adding configuration to database: <ul style="list-style-type: none"> Date-sensitive info messages Qn = d1/m1 – d2/m2 [ii] (i.e Qn = StartDate – EndDate [Info_code]) The config should be typed without spaces (except between d2/m2 and ii) e.g. Q1=01/01-31/03 01 means between 1st Jan and 31st Mar, info code 01 will be active. Time-sensitive info messages QTn = hh/mm hh/mm ii (i.e QTn = StartTime EndTime Info_code) The config should be typed without spaces (except between hh/mm and ii) e.g. QT1 = 01/00 01/30 01 means between 01:00 and 01:30, info code 01 will be active. <p>Note: If Q1 is also present, then the time and date are combined such that from 01:00 on 1st Jan until 01:30 on 31st Mar, info 01 will be active. If you wish to 'nest' the time within a date range, for instance to enable Info code 01 between the hours 01:00 and 01:30 every day from 01st Jan to 31st Mar, you need to enter a Qn date range and a QTn Time range with the same Info No. but with different values of n.</p> <ul style="list-style-type: none"> When entering manually from the 'Configure' menu: Manual entry allows for a time range to be entered as well as date, this in effect is incorporating the parameter Qn and QTn under a single menu item Qn. Info no: [* *] Date: ** / ** - ** / ** Time: ** : ** - ** : ** Example:

Feature	Parameter	Values	Description
			Info no: [0 1] Date: 0 1 / 0 1 – 3 1 / 0 3 Time: 0 1 : 0 0 – 0 1 : 3 0 This means between the hours 01:00 and 01:30 every day from 1 st Jan and 31 st Mar, info code 01 will be active.
Route Browse	RB	0 = disabled 1 = enabled	Refer to section Route code . A route number is first entered and then all destinations available for that route can be scrolled and selected. Note: the entries in the HELEN database must have 10-digit codes of the form 00RRRRDDDD where RRRR is the Route No to be entered and DDDD identifies the destination within that route.
Route Number Characters	RC	0123456789ABCDEFGHIJKLMNQRST UVWXYZ	The characters that are available to be used when using programmable route number. Certain characters can be omitted so they are not available by the user to select. Example: RC=ABCD01234 would only allow the characters A-D and number 0-4 to be able to be entered via the EG4.
Route Number Length	RL	3 - 7	Defines the length of route number.
Remote Enable	RM	0 = no 1 = yes (default is 1 for comms-enabled versions)	Refer to section Driver Display Control - Common . Controls whether remote control function is enabled.
Route Number	RN	0 = no 1 = yes	Refer to Route code . Controls whether driver-configurable route numbers can be viewed and changed on the destination controller. Notes: <ul style="list-style-type: none"> Pre-configured route codes cannot be altered directly via the destination controller. This feature has no effect if the destination controller is in route browse mode.
Remote Priority	RP	0 = No remote priority – manual selections stay put	Refer to section Driver Display Control - Common .

Feature	Parameter	Values	Description
		1 = Always remote priority – will always override any manual selection 2 = Temporary remote allows manual override, but if a different remote number is requested to that manually overridden, it will override the manual 3 = Special for Dublin bus 4 = Do not allow remote to set 'Idle'	This is a way of specifying the way the driver-entered destinations can override remote commands and vice-versa.
Reset Settings	RS	When RM = 1 (enabled): * = All visible parameters are reset, passenger destination displays are blank and EG4 enters into IDLE mode. If a number is now entered manually, EG4 stays in Local mode and will not respond to further remote inputs until 0 for destination or 99 for information is entered locally. 0 = No reset: passenger and driver destination displays return to their pre-reset state. 1 = EG4 reset to IDLE mode. 2 = Returns to last remotely selected destination, or to IDLE mode if no previous selected remote location is available.	Refer to section Driver Display Control - Common . Resets destination controller in various ways, depending on whether or not remote control is enabled.
		When RM = 0 (disabled): * and 0 = No reset. Passenger and driver displays show Destination, Route Number and Information as normal. 1 and 2 = EG4 reset to IDLE mode. Passenger destination displays are blank.	
Reset Destination	RSD	* , 0, 1 and 2 the same as for parameter RS	Overrides the value of parameter RS for the Destination number. Accepted values are the same as for RS.

Feature	Parameter	Values	Description
Reset Route	RSR	*, 0, 1 and 2 the same as for parameter RS	Overrides the value of parameter RS for the Route number. Accepted values are the same as for RS. If in route Browse mode – use RSR to set reset value for destination.
Reset Information	RSI	*, 0, 1 and 2 the same as for parameter RS	Overrides the value of parameter RS for the Information number. Accepted values are the same as for RS.
Reset Advert	RSA	*, 0, 1 and 2 the same as for parameter RS	Overrides the value of parameter RS for the Advert number. Accepted values are the same as for RS.
Round Trip	RT	0 = pressing X or Y has no effect on destination controller display 1 = enables the X key to be used to set the destination code for 'Out' prompt and the Y key for 'Return' prompt.	Refer to section Driver Display Control - Destination .
Route Zeros allow	RZ	0 = do not allow 1 = allow	Determines whether or not leading zeros of a route number are shown. If RZ = 0, leading zeros are deleted (single zero is allowed).
Sign Mapping for sign #n	Sn (n: 0 to 8, A to E)	0-31, HANCIS/HTC, HTC, RN, NN, LN	This is an optional manual override to enable the contents of a destination display to be changed to display a different programmed destination display in HELEN. Example: S0=5 will map the contents of sign 5 in HELEN to the sign which is set to address 0.
Sign Brightness Control	SCn (n: 0 to 15) Where n is the physical sign address	MB, MINB, BG	Note: Parameter SCn is not available in the EG4 user interface and must be set in the destination list. <ul style="list-style-type: none"> Maximum Brightness (MB) The maximum brightness setting determines the maximum brightness in % that a sign is allowed to reach. For e.g., MB50 limits the maximum sign brightness to 50%. Minimum Brightness (MINB) The minimum brightness setting determines the minimum brightness in % that a sign is not allowed to go below. For e.g., MINB90 limits the minimum sign brightness to 90%. Brightness Gain (BG)

Feature	Parameter	Values	Description
			<p>The brightness gain changes from 1 to 100 (default 10) in units of 1 tenth. This corresponds to gain of 0.1 to 10. The higher the gain, the brighter the sign will be for a given level of ambient illumination until the actual brightness reaches 100%.</p> <p>For examples:</p> <ul style="list-style-type: none"> • SC0=BG50; MB=60 This gives a brightness gain of 5 and a maximum brightness of 60%. • SC1=BG20 This gives a brightness gain of 2. This level might be appropriate for when a sign is installed below a tinted window. • SC2=MINB50 This sets the minimum brightness to 50%.
Substitute Charge Driver	SCD	Default is #.	<p>Specifies the character that is substituted by the state of charge value in driver messages.</p> <p>Can be set to any symbol except comma (,), colon (:), equals (=) or asterisk (*).</p>
Substitute Charge Sign	SCS	Default is #.	<p>Specifies the character that is substituted by the state of charge value in sign data.</p> <p>Can be set to any symbol except comma (,), colon (:), equals (=) or asterisk (*).</p>
Slow Proxy Mode	SPY	0 = disabled 1 = enabled	<p>Configure the destination display comms for a slow running proxy between the destination controller and the destination displays. For 'Movia' mode – adds large timeouts to destination display comms traffic.</p>
Sign Speed	SS	AUTO, 4800, 9600, 19200, 38400	<p>Refer to Appendix B: Serial Ports.</p> <p>Baud rate = data transmission speed between the destination controller and displays. Destination displays themselves must have their processors set to the same baud rate as the destination controller and as each other. The AUTO setting is rarely used.</p>
Sign Status Timeout	SST	Allowable range: 100 - 3000 100 = default timeout for short status request 3000 = same as Slow Proxy Mode (SPY)	<p>Duration allowed for a sign to respond to a status request in ms.</p> <p>Applies to both short status and extended status requests.</p>

Feature	Parameter	Values	Description
Substitute Time Driver	STD	Default is #.	Specifies the character that is substituted by the departure time in driver messages. Can be set to any symbol except comma (,), colon (:), equals (=) or asterisk (*).
Substitute Time Sign	STS	Default is tilda (~).	Specifies the character that is substituted by the departure time in sign data. Can be set to any symbol except comma (,), colon (:), equals (=) or asterisk (*).
SuperX Information Paste	SXP	0 = disabled 1 = enabled	Enables the pasting of a Route Number into an Info page. When SXP = 1, this allows Info messages to specify that any combination of route, top line or bottom line of Destination page is pasted onto the Info page – ONLY works with SuperX. Info page should be programmed with single % character in those fields which is to be pasted into.
Timer 0	T0	10 - 3000	Sets the display time in deciseconds of the first destination page.
Timer 1	T1	10 - 3000	Sets the display time in deciseconds of the second and subsequent destination pages.
Timer 2	T2	10 - 3000	Sets the display time in deciseconds of all the information pages.
Timer 3	T3	0 - 3000	This will set the time that a Super-X scrolling page is allowed to scroll.
TCP Port Protocol Configuration	TCP1	w x y z where: <ul style="list-style-type: none"> w = protocol x = tcp port y = SERVER or CLIENT z = server address 	Refer to Network . Configuration of Ethernet port. Assigns protocol, sets port number, sets server/client, sets server address. Notes: <ul style="list-style-type: none"> There is space between each value. Server address is an optional parameter if configuration is set to SERVER.
TCP Port Protocol Configuration	TCP2	w x y z where: <ul style="list-style-type: none"> w = protocol x = tcp port y = SERVER or CLIENT z = server address 	Refer to Network . Configuration of Ethernet port. Assigns protocol, sets port number, sets server/client, sets server address. Notes: <ul style="list-style-type: none"> There is space between each value. Server address is an optional parameter if configuration is set to SERVER.
Controller Theme	TH	LIGHT, DARK or a value range	Refer to Display .

Feature	Parameter	Values	Description
			<p>Specifies the theme or at what brightness the themes will automatically switch. Settings are LIGHT, DARK or a value range as in 5 -15. The first value is the brightness below which triggers dark theme, the second value is the brightness above which triggers the light theme. This acts as a hysteresis.</p> <p>Note: if the parameter TH/value is not present, the existing setting will be unaffected.</p>
SPEC timer	TL	0 - 1000	<p>Both SPEC-A and SPEC-B interfaces simply send out the current destination code whenever it changes or at time intervals. SPEC-A sends out the current 4-digit destination code with leading space characters instead of zeros. SPEC-B sends out a 10-digit code with leading zeros and can be used with route browse. Both use a parameter TL=n, where n is in 1/10 seconds. This is the time period of the message (the message is however, always sent out upon a change of destination). TL=0 means 'only send out the message on power-up and when destination is changed'.</p>
Time Entry	TV	0 = feature disabled 1 = sets time in hours and mins 2 = countdown timer in mins 3 = inserts current time in place of '~'	<p>1 = used to set a fixed time, which will be substituted for any '~' character within the HELEN destination or driver display database.</p> <p>2 = counts down from a specified number of minutes when destination/information code is selected. For more details about parameter CC to include in the database config i.e. in the 'Extensions' box of HELEN software.</p> <p>3 = inserts current time when destination code containing '~' is selected.</p>
Adjust sign timing	TZ	0 = disabled 1 = enabled	<p>To adjust the time of the destination displays connected to the destination controller. Subtracts the transmission time from the page time set in T0 T1 T2 can sometimes make page timings more accurate.</p>
USB Update Lock Code	UC	Default (if not specified) is 9876.	<p>Specifies the lock code required to be entered by the user before accepting updates from a USB device.</p>
UDP Port Protocol Configuration	UDP1	w x y z where: <ul style="list-style-type: none"> w = protocol x = udp port y = SERVER or CLIENT z = server address 	<p>Refer to Network.</p> <p>Configuration of Ethernet port.</p> <p>Assigns protocol, sets port number, sets server/client, sets server address.</p> <p>Notes:</p> <ul style="list-style-type: none"> There is space between each value. Server address is an optional parameter if configuration is set to SERVER.

Feature	Parameter	Values	Description
UDP Port Protocol Configuration	UDP2	w x y z where: <ul style="list-style-type: none"> w = protocol x = udp port y = SERVER or CLIENT z = server address 	Refer to Network . Configuration of Ethernet port. Assigns protocol, sets port number, sets server/client, sets server address. Notes: <ul style="list-style-type: none"> There is space between each value. Server address is an optional parameter if configuration is set to SERVER.
USB Update Lock Code	UL	0 = disabled (default) 1 = enabled	Enables the requirement to enter the USB update password before accepting updates from a USB device.
Front Panel USB Power	UP	Enabled = USB Power always ON Disabled = USB Power is OFF. USB power is activated for 2 mins when the Maintenance Lock Code is entered to allow for updates. 1 – 5 = USB Power is ON for the specified number of minutes then it is switched OFF. Power can be re-enabled for the specified time by entering the Maintenance Lock Code.	To configure the power of the USB port in the front panel of the controller.
Vehicle ID	VI	0 - 5	To set a driver-entered ID for the vehicle
Wayfarer Address No.	WA	0 – 15 (default depends on Wayfarer interface)	Function depends on Wayfarer settings
Wayfarer Device No.	WD	0 – 15 (default depends on Wayfarer interface)	Function depends on Wayfarer settings
Wayfarer Timer	WT	0 - 100	Function depends on Wayfarer settings
XY allez/retour flag	XY	0 = function not used 1 = X key selects out and Y key selects return	Refer to section Driver Display Control - Destination . Specifies how the X and Y keys will operate in aller-retour (round trip) mode. Note: RT also needs to be enabled for this setting to be effective

Feature	Parameter	Values	Description
Port #n serial setting	Yn (n : 0 to 5)	Baud rate / parity / data bits / stop bits / flow control / delay time parity - N, E, O, M, or S (value must be capital) word length - 7 or 8 stop bits - 1 or 2 flow control 0 - None, 1 - Hardware delay time - in milliseconds	This setting specifies all the parameters for the port. The parameters must be separated by a forward slash (/). The parameters are ordered baud / parity / data bits / stop bits / flow control / delay time. Parameters may be excluded from the right and if not present, are defaulted. Example: Y4 = 9600/N/8/1 will set the baud rate of port 4 (P4) to 9600, no parity, 8 data bits and 1 stop bit.
ZW browse mode	ZW	0 = browse disabled until route number entered 1 = browse enabled	This setting requires RN=1 and BR=1 to work.
ZY (HTC)	ZY	0 = function disabled 1 = renders first six digits of 10-digit code as zeros	This feature requires RB =1 (route browse 'on') to work. Applies to a message sent to an HTC or another on-board computer as a 'd' message. The EG4 can be networked with an on-board computer such as an HTC. Messages are sent periodically from the destination controller to the computer in the form of 'd' messages (destination data), 'i' messages (information data) or 't' messages (time data).
X-Browse mode	XB	0 = disabled 1 = enabled	Only applies if EG4 is being used by a specific customer. <ul style="list-style-type: none"> • If current destination code is between 1000-3999 and if the current destination code plus 3000 exists, then add 3000 to destination code when X key is pressed. • If current destination code is between 4000-6999 and if the current destination code minus 3000 exists, then subtract 3000 from destination code when X key is pressed.