

Ground Distribution

Electronic gnd to Dash harness

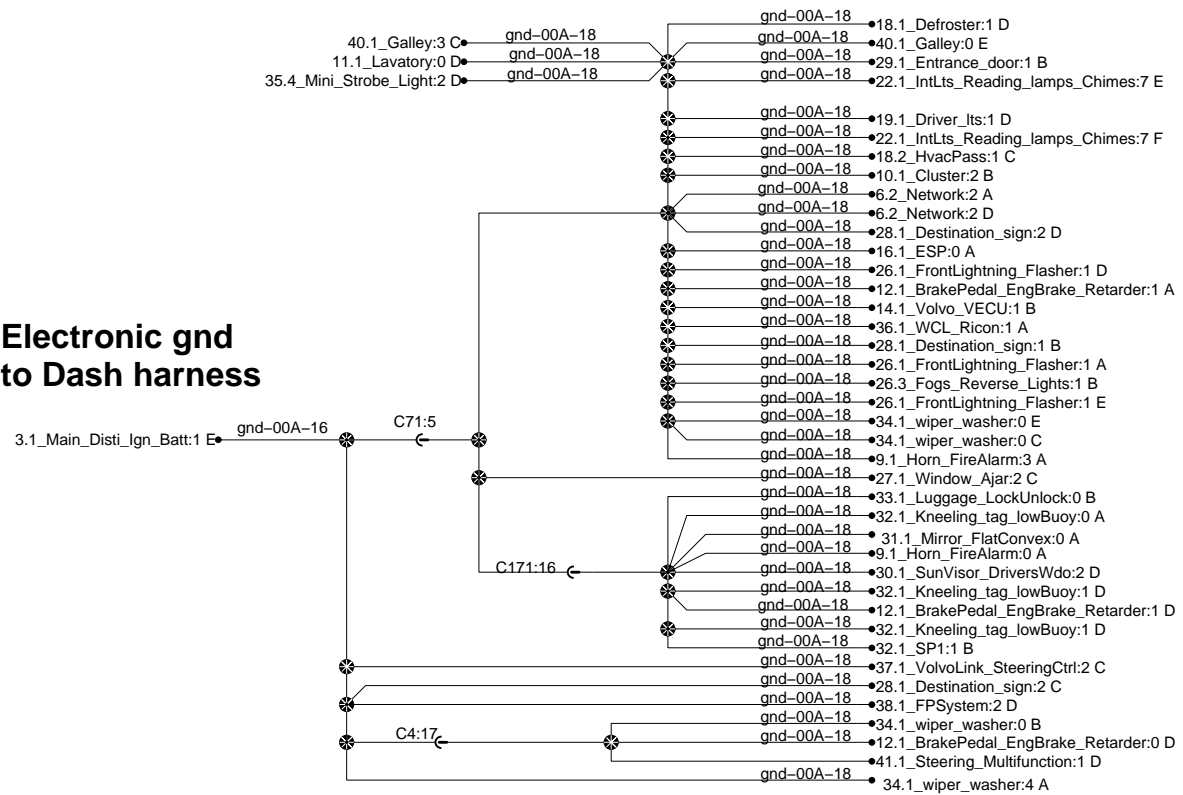

Dash stud

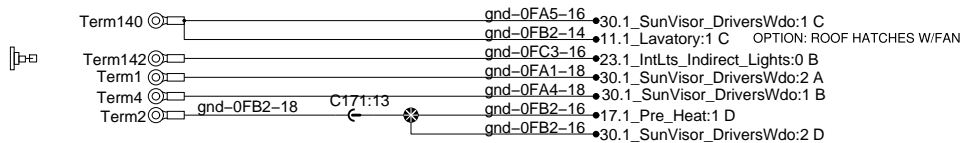

OPTION:ELECT CHAIR

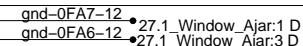

Electronic gnd to FJB

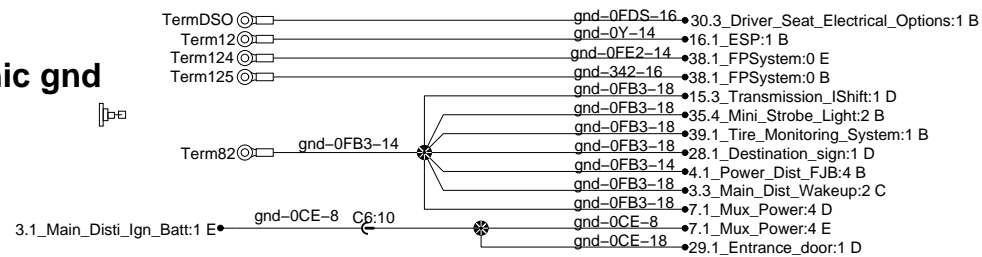

Front stud

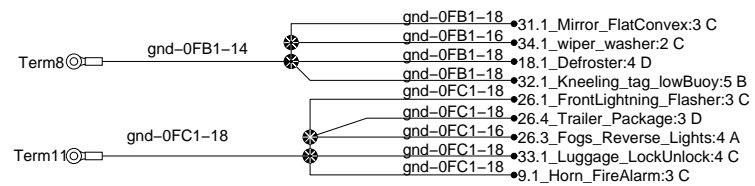

RH Console stud

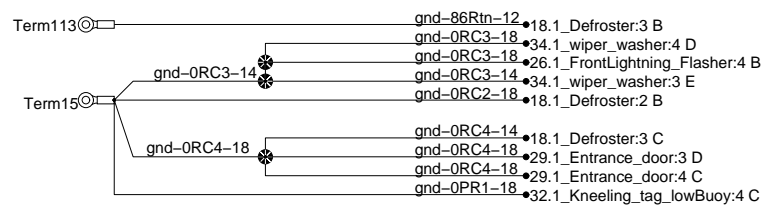

Chassis gnd Parcel Rack stud

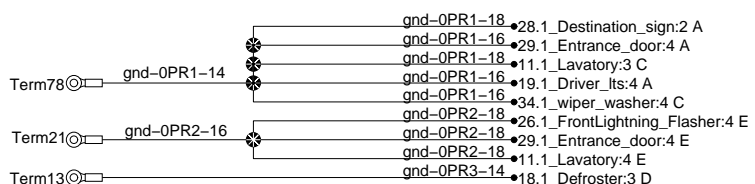

Condensor cmpt. stud

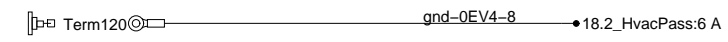

Evaporator cmpt. stud

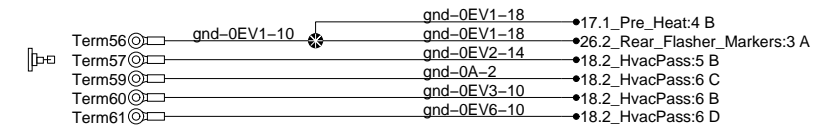

Electronic gnd to Rr mux 0G

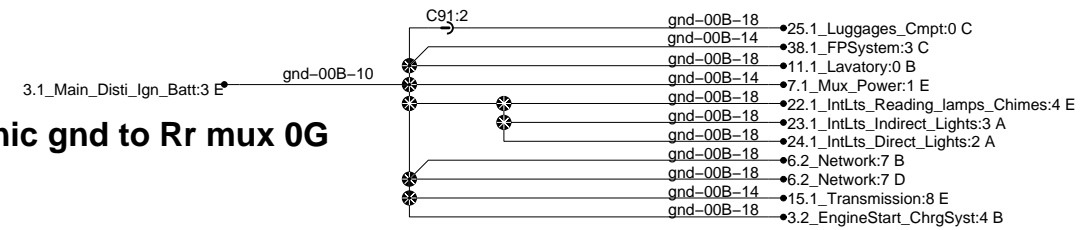

RJB stud Chassis Gnd

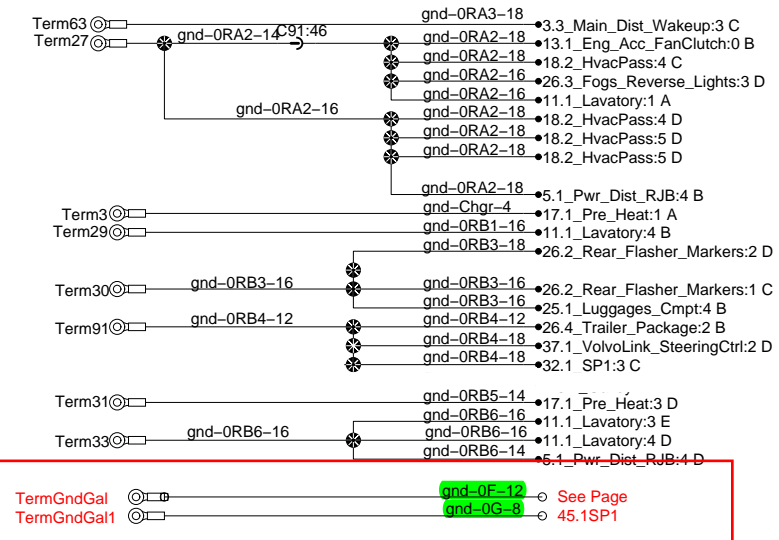

OPTION:plug 12V add

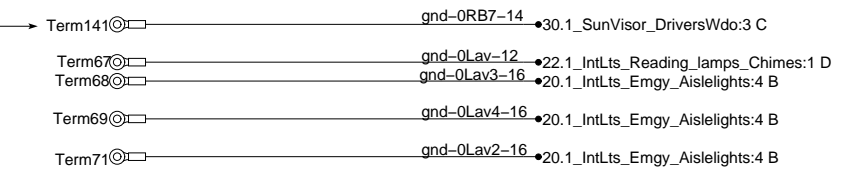

Lavatory Stud

Eng. cmpt gnd stud



Eng. cmpt gnd stud

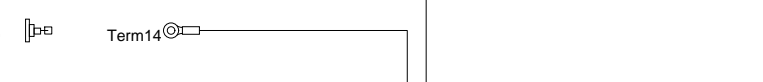

Engine

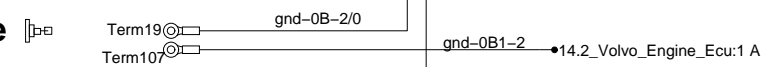

Engine

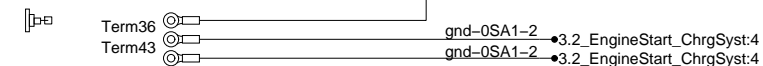

Engine

