

GROUND

WIRING DIAGRAM ZC

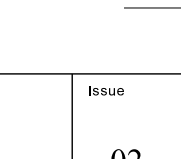
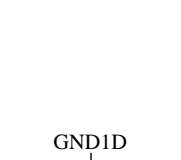
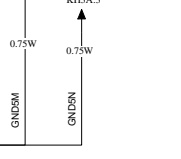
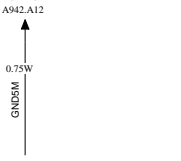
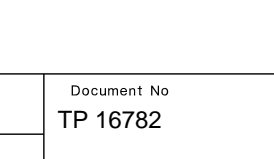
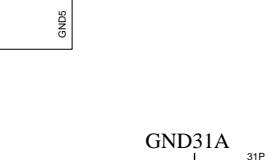
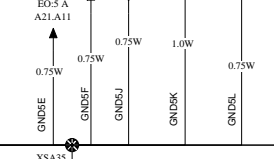
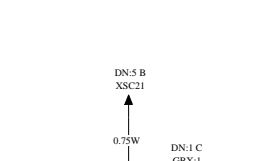
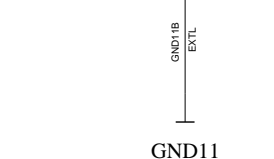
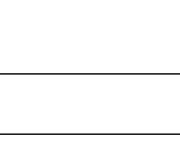
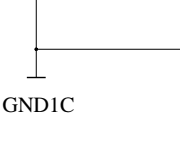
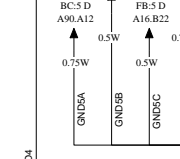
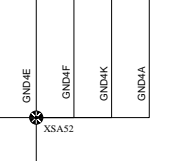
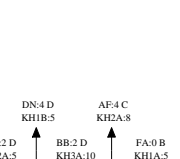
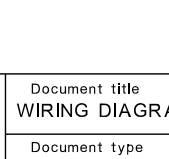
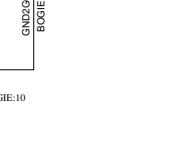
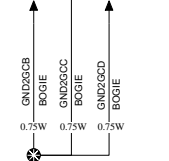
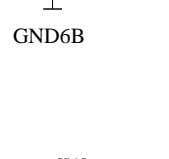
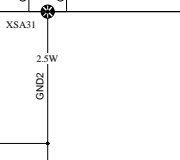
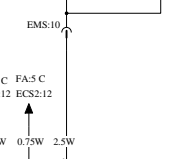
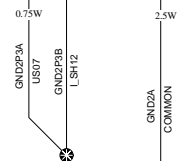
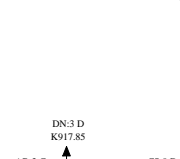
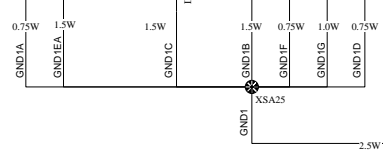
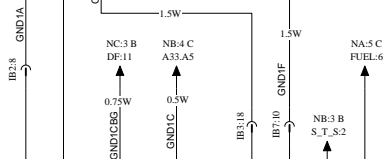
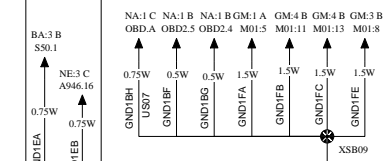
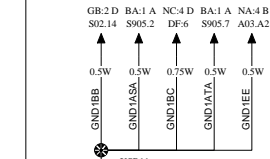
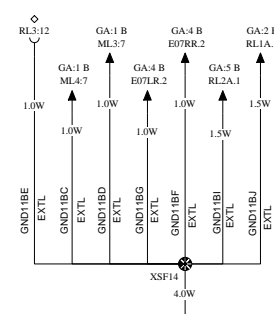
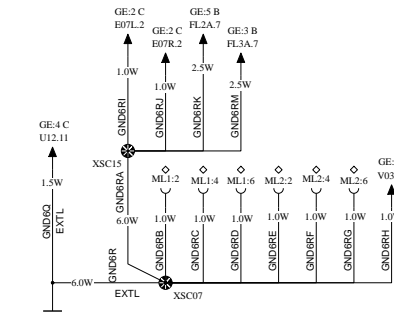
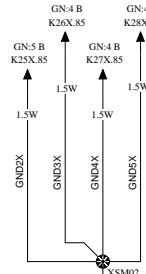
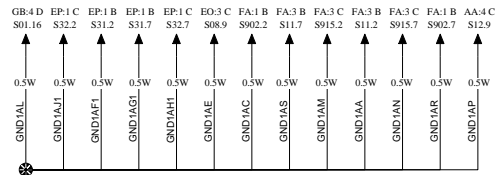

Volvo Bus Corporation

Document title
WIRING DIAGRAM ZC
Document type
PRODUCT SCHEMATIC

Document No
TP 16782

Issue
02
Volume
01(02)
Page
31(31)