

# PREVOST

## Pneumatic diagram

### PNEUMATIC DIAGRAMS WE & WM BUS SHELL WITH INDEPENDENT SUSPENSION SYSTEM

NO:	<b>D140385P0</b>	REVISION :	<b>G</b>
-----	------------------	------------	----------

EFF. OC#	2010001 WE 2010060 WM	PRIOR TO OC#	2011095	DR.	Robert Bouillon	date	2013-02-06
EFF. VEH#	#B-5003 WE #C-5097 WM	PRIOR TO VEH#	#C-5233 WE #C-5236 WM	CHK	Marc-Jose Handfield	appr	Marc-José Handfield

REV.	DATE	DESCRIPTION	PAGE	BY	CHK.	APPR.
A	2010-11-26	WE with Independent Front Suspension IFS, Production Vehicle #B-5003...		Rob.	M.J.H.	M.J.H.
	2011-06-01	WM with Independent Front Suspension IFS, Preliminary veh. WM #C-5070, Production Vehicle #C-5097...		Rob.	M.J.H.	M.J.H.
B	2011-05-18	#D140385 P6.0 REVISION: B (AHI REPLACED) #D140385 P7.0 REVISION: B (AHI REPLACED)	P6.0 & 6.1 P7.0 & 7.1	R.LAM.	M.J.H.	M.J.H.
C	2011-10-04	#D140385 P1.0 REVISION: B (UPDATE) Effectif #C-5234	P1.0 1.1@1.4	Rob.	M.J.H.	M.J.H.
D	2011-10-24	#D140385 P1 Revision C (NEW IFS 19 LBS) #D140385 P2 Revision B Production Vehicle WE #C-5133 Production Vehicle WM #C-5236	P1.0 1.1@1.4 P2.0 & 2.1	Rob.	M.J.H.	M.J.H.
E	2011-11-04	VOLVO ENGINE VERSION WITHOUT DRV VALVE Production vehicle WE : #C-5233	P.6 & 7 P6.1&7.1	Rob.	M.Pelletier	M.Pelletier
F	2012-02-07	#D140385 P1 Revision D (UPDATE)	P1.0 1.1@1.4	Rob.	M.J.H.	M.J.H.
G	2013-02-06	NEW #D140385SP1 #D-5454 WITH SPECIAL OPTION AIR HORN	SP1,SP1.1	J.Aubry	M.J.H.	M.J.H.

# PREVOST

## Pneumatic diagram

### *PNEUMATIC DIAGRAMS WE & WM BUS SHELL WITH INDEPENDENT SUSPENSION SYSTEM*

<b>PRODUCTION NUMBER</b>	<b>REV</b>	<b>EFF. VEH.</b>	<b>ECN</b>	<b>S.A.V. NUMBER</b>	<b>REV</b>	<b>DESCRIPTION</b>
D140385P1.0	D	#C-5133...	2010070	D140385P1.1	D	FULL PNEUMATIC ABS 6 AIR BRAKE SYSTEM
				D140385P1.2	D	ACCESSORIES
				D140385P1.3	D	BRAKES SYSTEM
				D140385P1.4	D	SUSPENSION
D140385P2.0	B	#C-5133	2010070	D140385P2.1	B	LEVEL-LOW OPTION
D140385P3.0	A	#B-5003	2010001	D140385P3.1	A	AIR BRAKE SYSTEM ESP OPTION
D140385P4.0	A	#B-5003	2010001	D140385P4.1	A	AIR BRAKE SYSTEM ESP OPTION WITH AIR BRAKE ON TRAILER HITCH OPTION.
D140385P5.0	A	#B-5003	2010001	D140385P5.1	A	WITH FRONT SINGLE SLIDE OUT OPTION, LEFT SIDE
D140385P6.0	C	#C-5233	2011095	D140385P6.1	C	ALLISON TRANSMISSION WITHOUT RETARDER OPTION (AHI)
D140385P7.0	C	#C-5233	2011095	D140385P7.1	C	ALLISON TRANSMISSION WITH RETARDER OPTION (AHI)
D140385P8.0	A	#C-5097	2010060	D140385P8.1	A	TWO SLIDE OUT FRONT AND REAR, LEFT SIDE
D140385SP1.0	A	#D-5454	-	D140385SP1.1	A	WITH SPECIAL OPTION AIR HORN

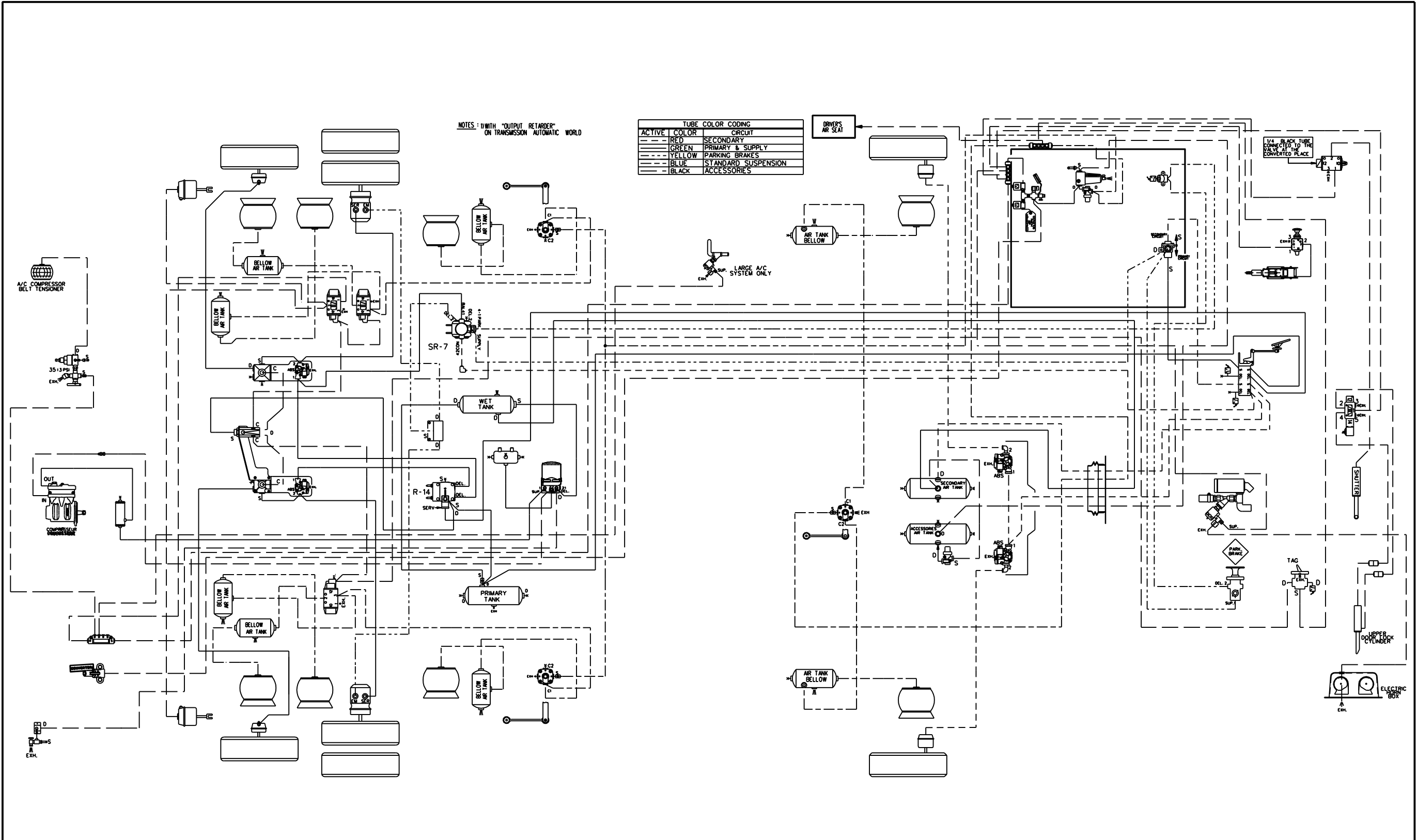

NOTES: WITH "OUTPUT RETARDER" ON TRANSMISSION AUTOMATIC WORLD

ACTIVE	COLOR	CIRCUIT
---	RED	SECONDARY
---	GREEN	PRIMARY & SUPPLY
---	YELLOW	PARKING BRAKES
---	BLUE	STANDARD SUSPENSION
---	BLACK	ACCESSORIES

**PREVOST®**

DESCRIPTION: BUS SHELL WE WITH FULL PNEUMATIC SYSTEM

REV.: A  
DATE: 2010/11

PAGE: D140385 P1.1

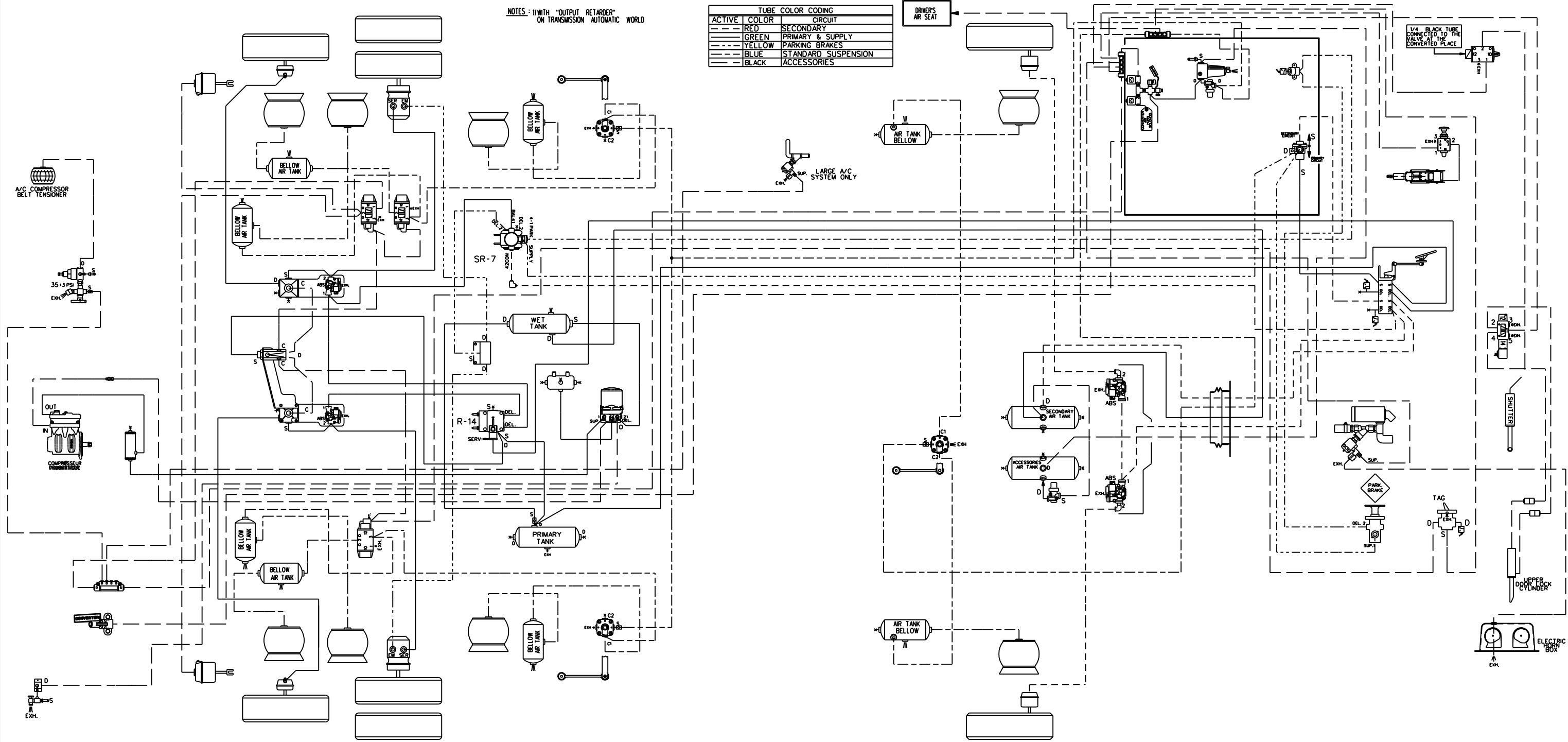

**PREVOST®**

DESCRIPTION:

BUS SHELL WE  
WITH FULL PNEUMATIC SYSTEM

REV.:

B

PAGE:

D140385 P1.1

DATE:

2011/10

NOTES: WITH "OUTPUT RETARDER"  
ON TRANSMISSION AUTOMATIC WORLD

ACTIVE COLOR	TUBE COLOR CODING	CIRCUIT
RED	SECONDARY	
GREEN	PRIMARY & SUPPLY	
YELLOW	PARKING BRAKES	
BLUE	STANDARD SUSPENSION	
BLACK	ACCESSORIES	

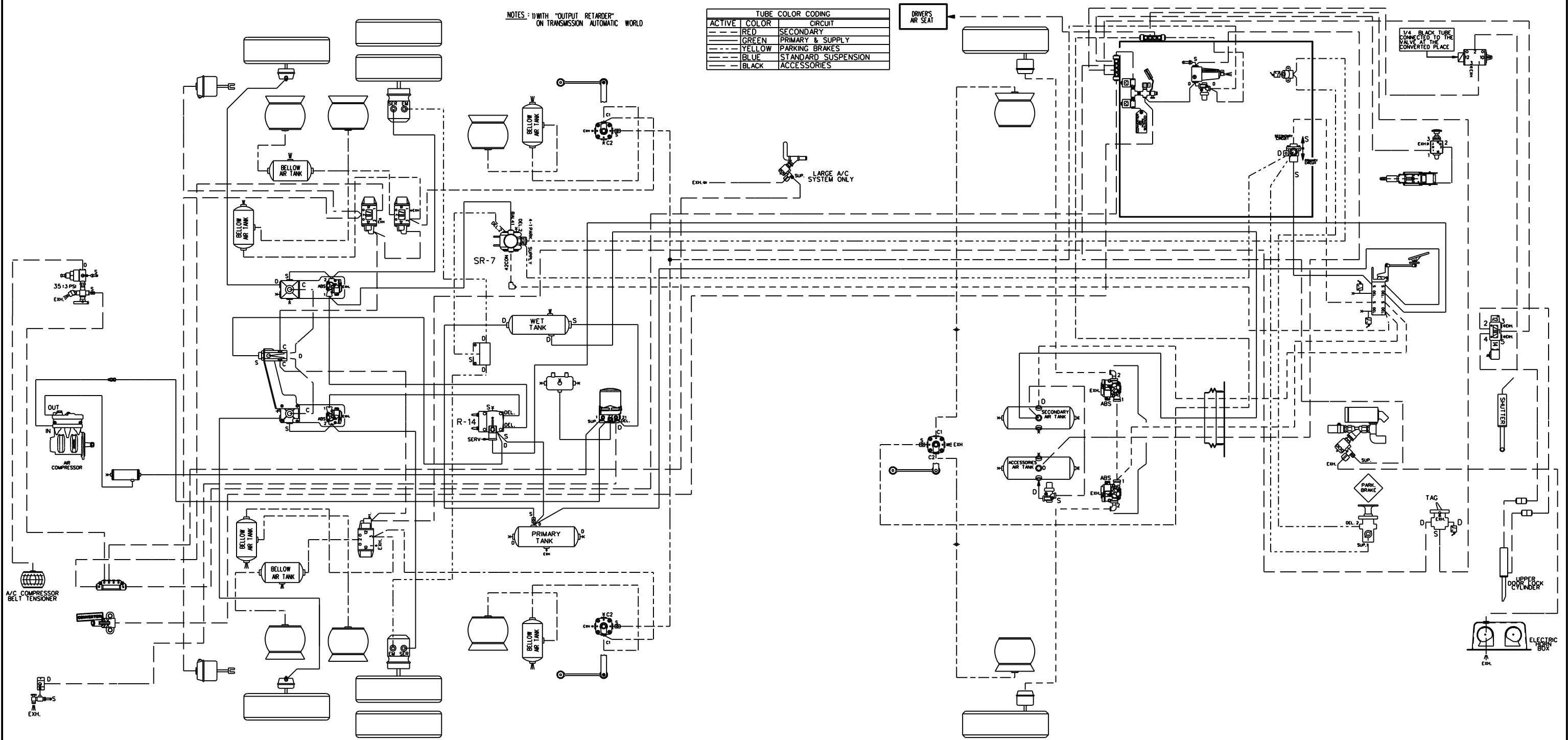

**PREVOST®**

DESCRIPTION:

BUS SHELL WE  
WITH FULL PNEUMATIC SYSTEM

REV.:

D

PAGE:

D140385 P1.1

DATE:

2012/02

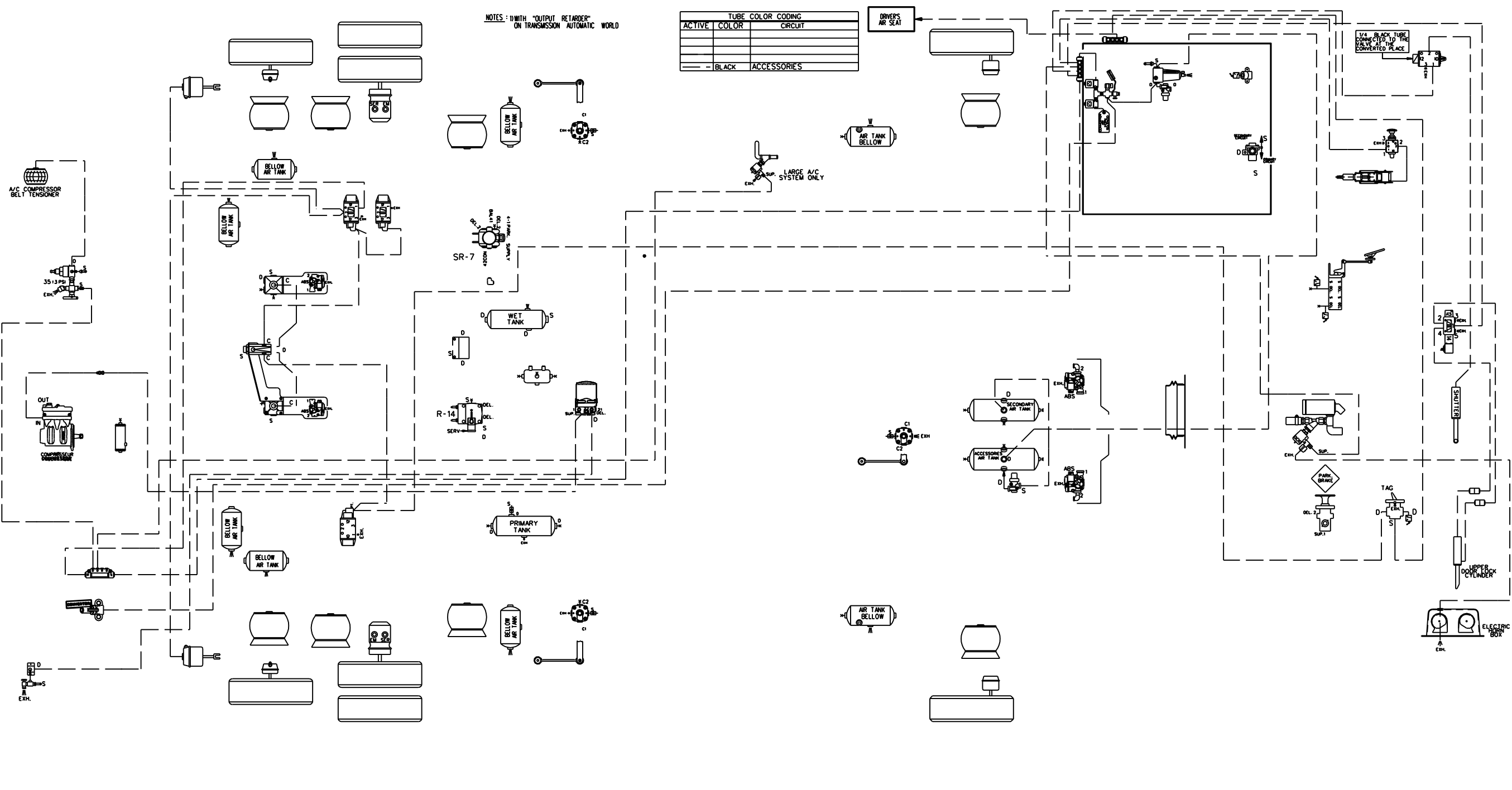

NOTES : WITH "OUTPUT RETARDER"  
ON TRANSMISSION AUTOMATIC WORLD

ACTIVE	TUBE COLOR CODING
COLOR	CIRCUIT
- BLACK	ACCESSORIES

**PREVOST**<sup>®</sup>

DESCRIPTION:  
BUS SHELL WE  
ACCESSORIES

REV.: A  
DATE: 2010/11

PAGE:  
D140385 P1.2

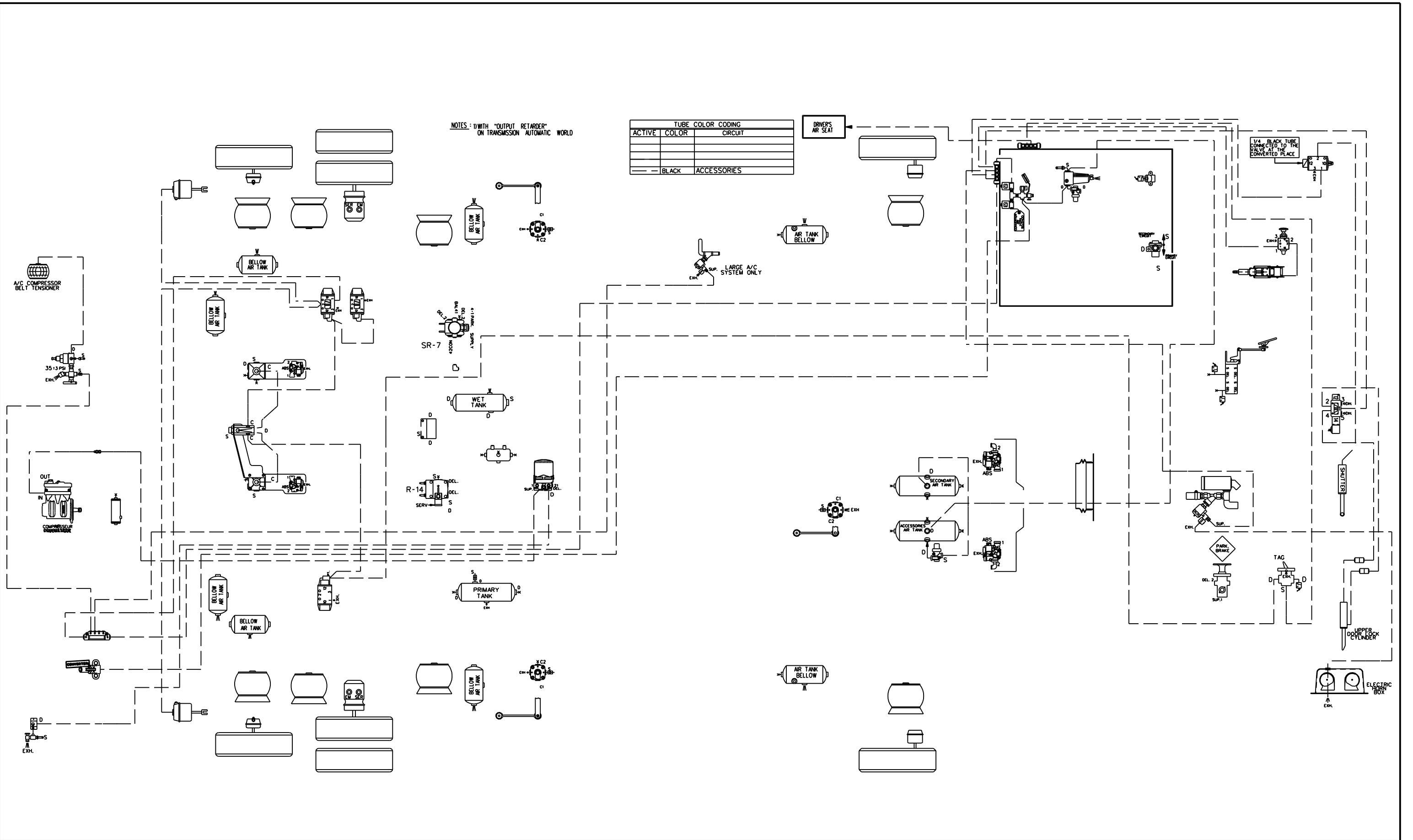

**PREVOST®**

DESCRIPTION:

BUS SHELL WE  
ACCESSORIES

REV.:

B

PAGE:

DATE:

2011/10

D140385 P1.2

NOTES: 1) WITH "OUTPUT RETARDER"  
ON TRANSMISSION AUTOMATIC WORLD

TUBE COLOR CODING		
ACTIVE	COLOR	CIRCUIT
---	BLACK	ACCESSORIES

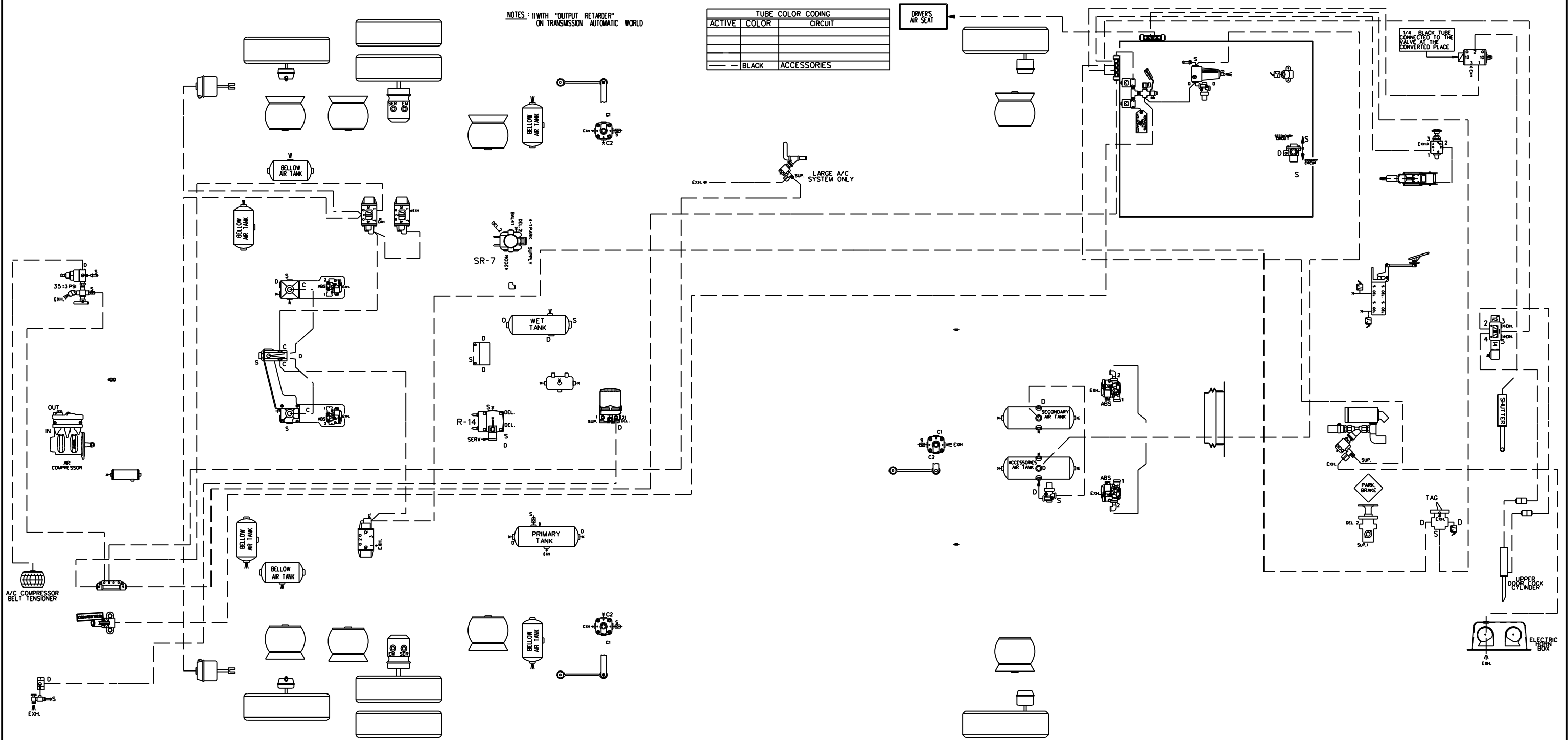

**PREVOST**®

DESCRIPTION:

BUS SHELL WE  
ACCESSORIES

REV.:

D

PAGE:

DATE:

2012/02

D140385 P1.2



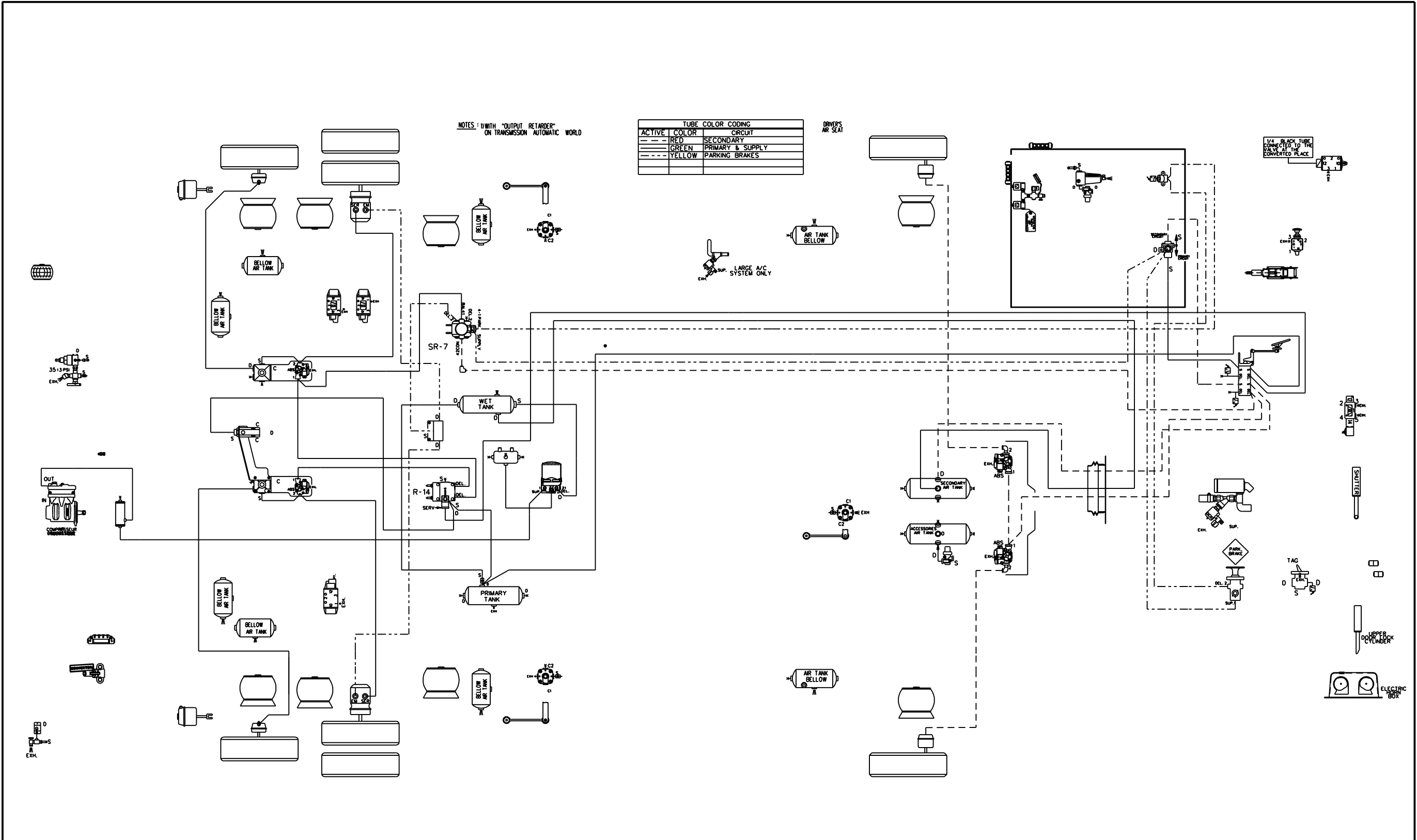

NOTES: 1) WITH "OUTPUT RETARDER"  
ON TRANSMISSION AUTOMATIC WORLD

ACTIVE	COLOR	CIRCUIT
---	RED	SECONDARY
---	GREEN	PRIMARY & SUPPLY
---	YELLOW	PARKING BRAKES

DRIVERS  
AIR SEAT

LARGE A/C  
SYSTEM ONLY

1/4" BLACK TUBE  
CONNECTED TO THE  
VALVE AT THE  
CONVERTED PLACE

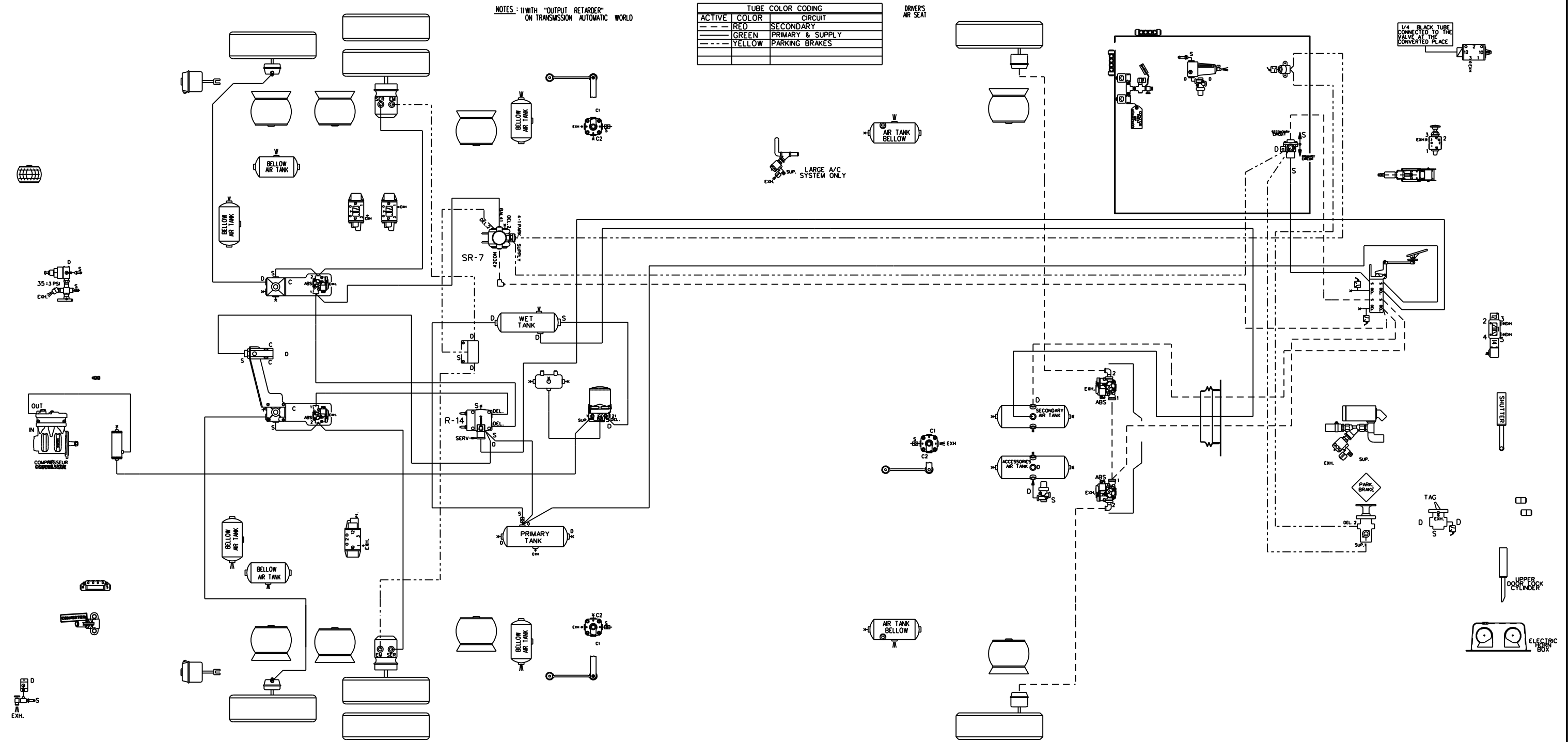

**PREVOST**®

DESCRIPTION:

BUS SHELL WE  
BRAKES SYSTEM

REV.:

B

PAGE:

DATE:

2011/10

D140385 P1.3

NOTES: 1) WITH "OUTPUT RETARDER"  
ON TRANSMISSION AUTOMATIC WORLD

TUBE COLOR CODING		
ACTIVE	COLOR	CIRCUIT
---	RED	SECONDARY
---	GREEN	PRIMARY & SUPPLY
---	YELLOW	PARKING BRAKES

DRIVERS  
AIR SEAT

LARGE A/C  
SYSTEM ONLY

1/4 BLACK TUBE  
CONNECTED TO THE  
VALVE AT THE  
CONVERTED PLACE

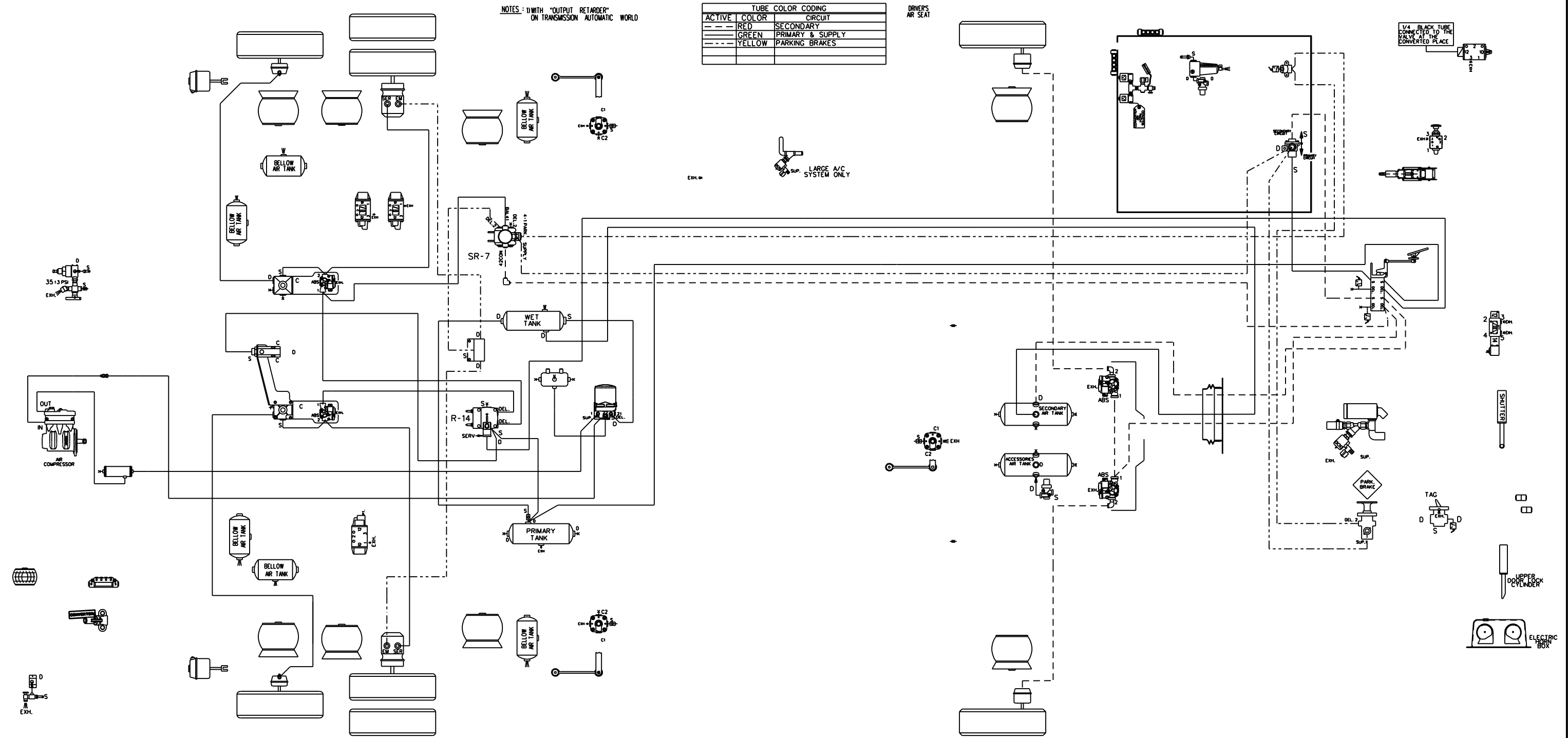

**PREVOST**

DESCRIPTION:  
BUS SHELL WE  
BRAKES SYSTEM

REV.: D  
DATE: 2012/02

PAGE:  
D140385 P1.3

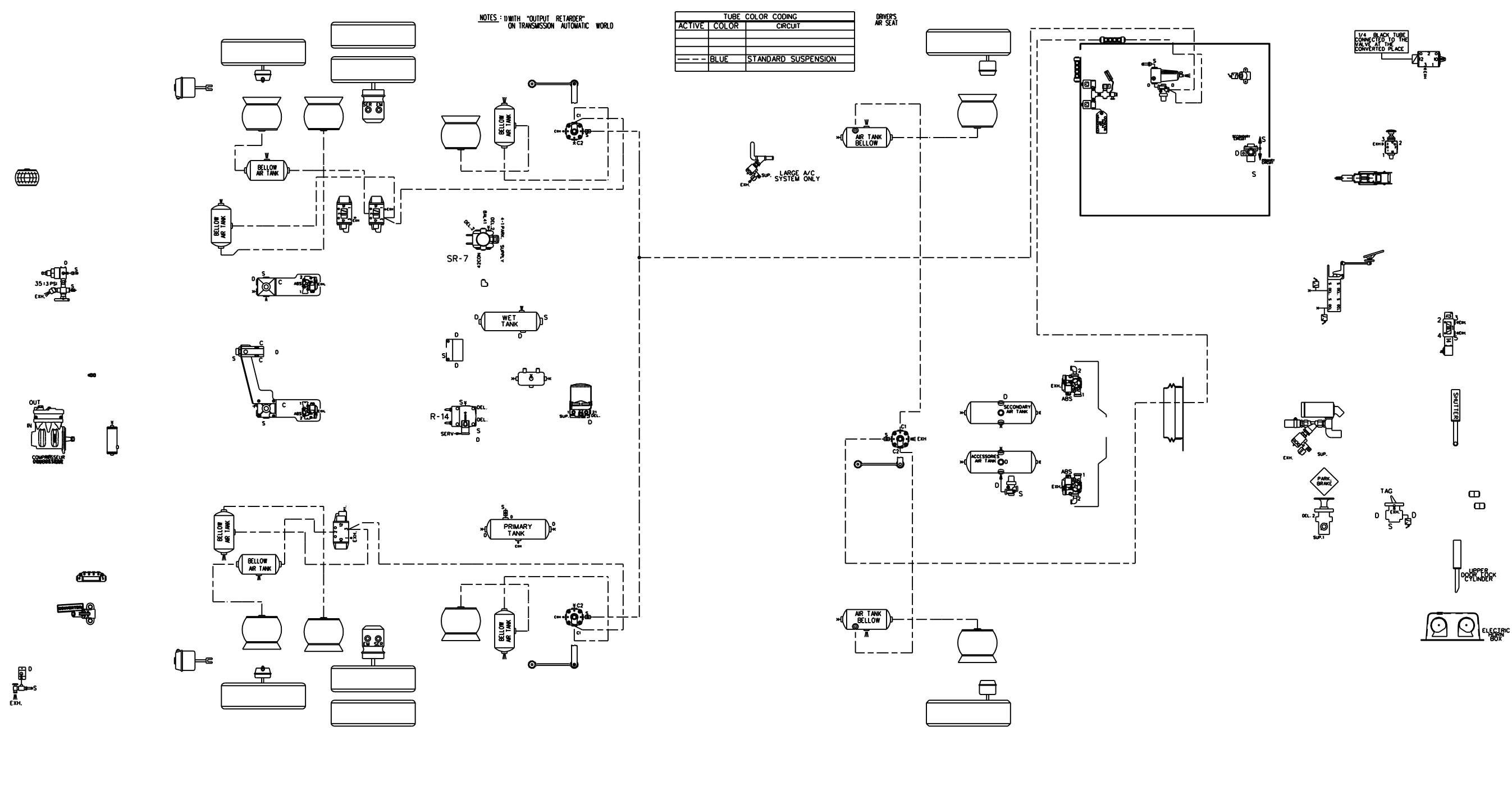

**PREVOST.**

DESCRIPTION:  
 BUS SHELL WE  
 STANDARD SUSPENSION

REV.: A  
 DATE: 2010/11

PAGE:  
 D140385 P1.4

NOTES: 1) WITH "OUTPUT RETARDER"  
ON TRANSMISSION - AUTOMATIC WORLD

TUBE COLOR CODING	
ACTIVE	CIRCUIT
---	BLUE
---	STANDARD SUSPENSION

DRIVERS  
AIR SEAT

LARGE A/C  
SYSTEM ONLY

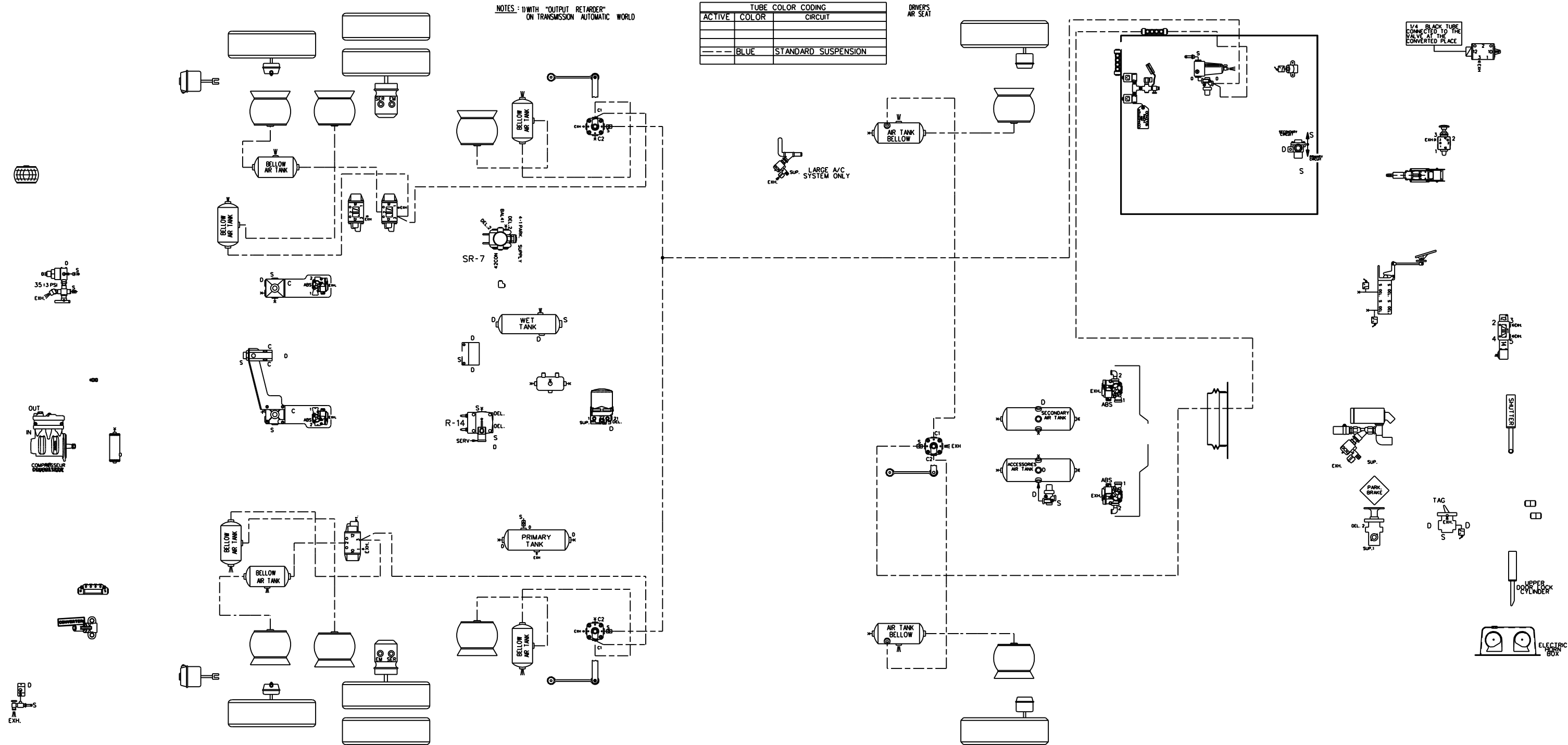

**PREVOST**®

DESCRIPTION:

BUS SHELL WE  
STANDARD SUSPENSION

REV.:

B

PAGE:

DATE:

2011/10

D140385 P1.4

NOTES: 1) WITH "OUTPUT RETARDER"  
ON TRANSMISSION - AUTOMATIC WORLD

TUBE COLOR CODING		
ACTIVE	COLOR	CIRCUIT
---	BLUE	STANDARD SUSPENSION

DRIVERS  
AIR SEAT

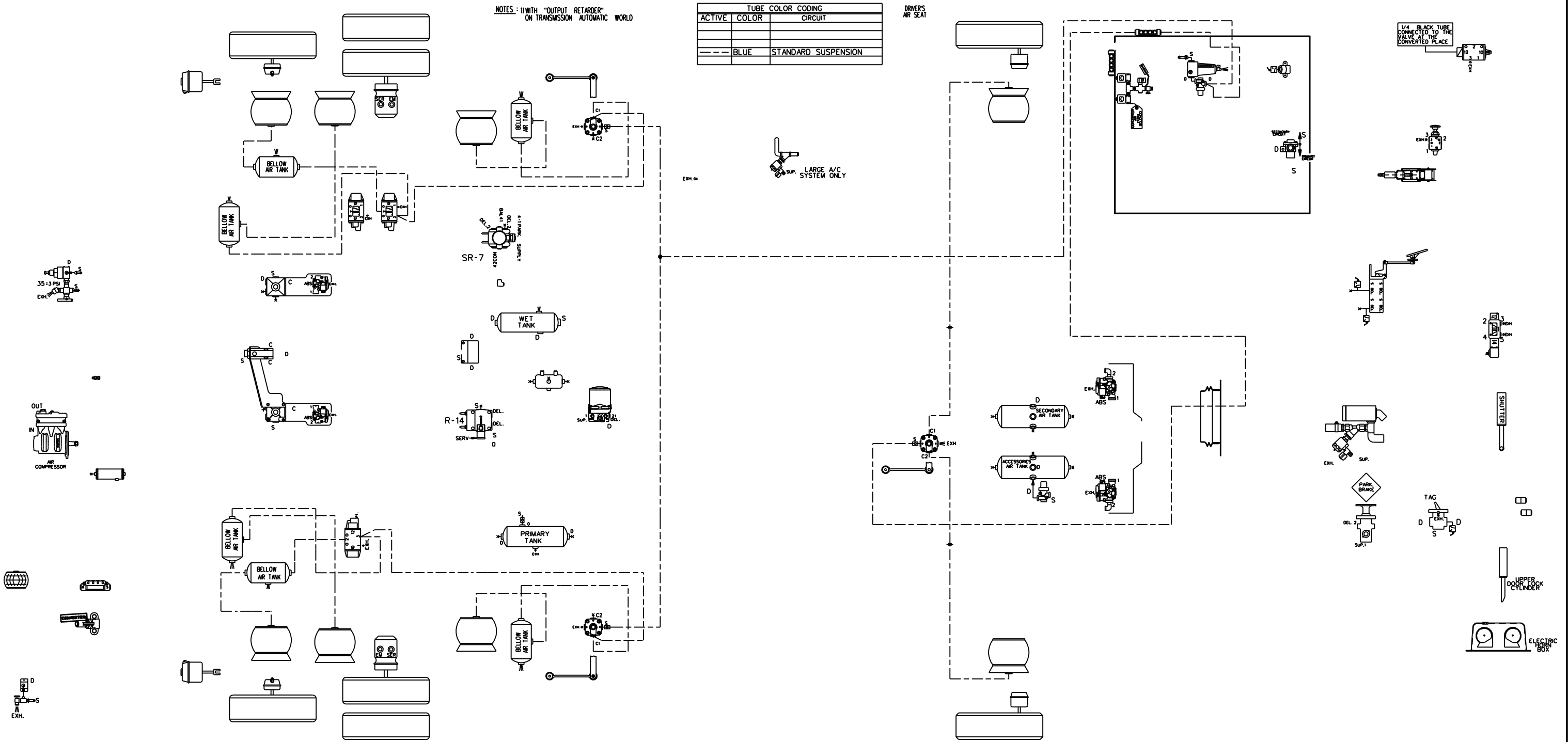

**PREVOST®**

DESCRIPTION:  
BUS SHELL WE  
STANDARD SUSPENSION

REV.: D  
DATE: 2012/02

PAGE:  
D140385 P1.4

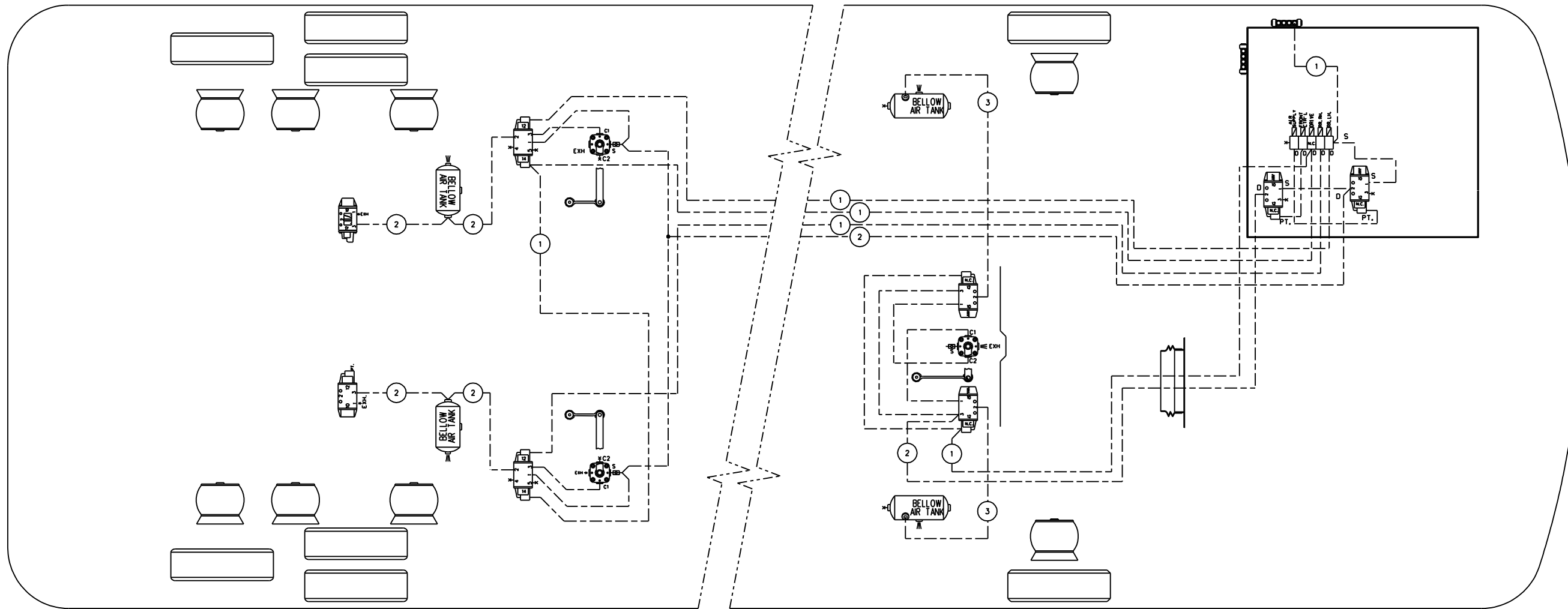

TUBE COLOR CODING	
ACTIVE COLOR	CIRCUIT
---	BLACK ACCESSORIES
---	BLUE STANDARD SUSPENSION

BALLOON	PIPE
*1	1/4" O.D. BLACK
*2	3/8" O.D. BLUE
*3	1/2" O.D. BLUE

**PREVOST**®

DESCRIPTION: BUS SHELL WE WITH OPTION LEVEL LOW

REV.: A  
DATE: 2010/11

PAGE: D140385 P2.1

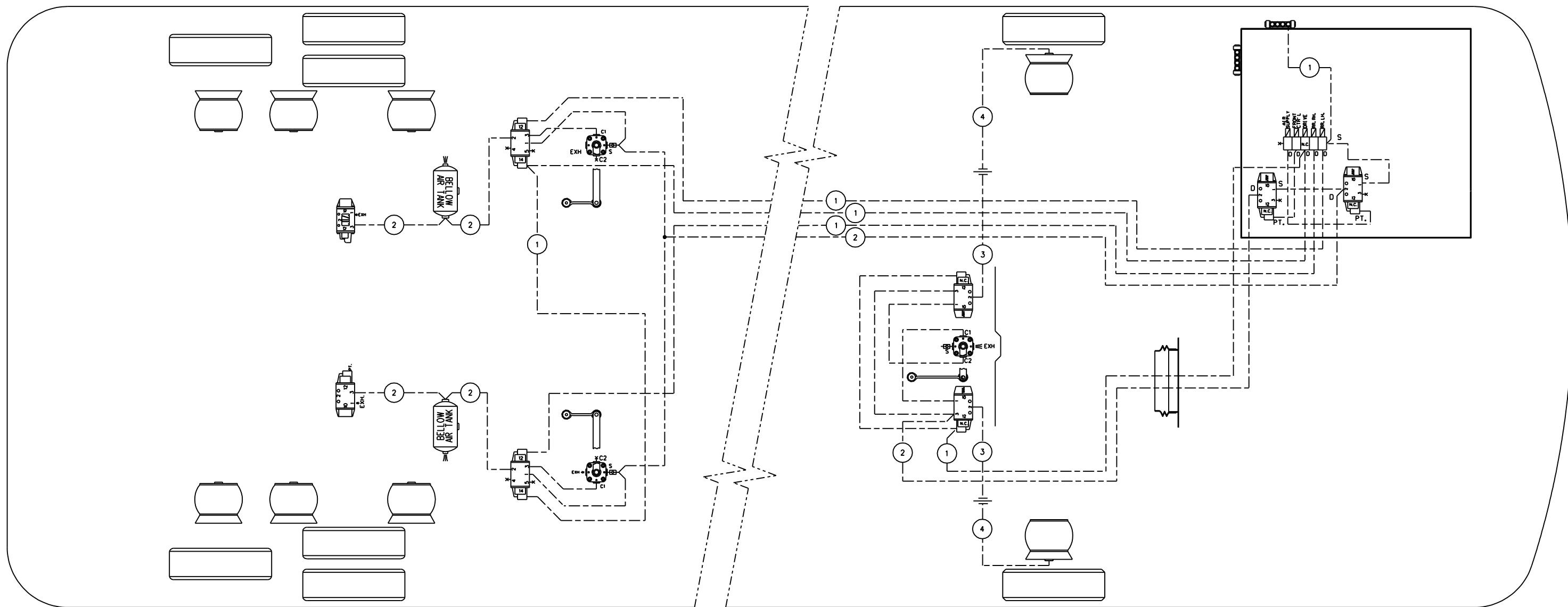

TUBE COLOR CODING	
ACTIVE COLOR	CIRCUIT
—	BLACK ACCESSORIES
- - -	BLUE STANDARD SUSPENSION

BALLOON	PIPE
*1	1/4" O.D. BLACK
*2	3/8" O.D. BLUE
*3	1/2" O.D. BLUE
*4	HOSE ASSY (*8)

**PREVOST®**

DESCRIPTION:

BUS SHELL WE  
WITH OPTION LEVEL LOW

REV.:

B

PAGE:

DATE:

2011/10

D140385 P2.1



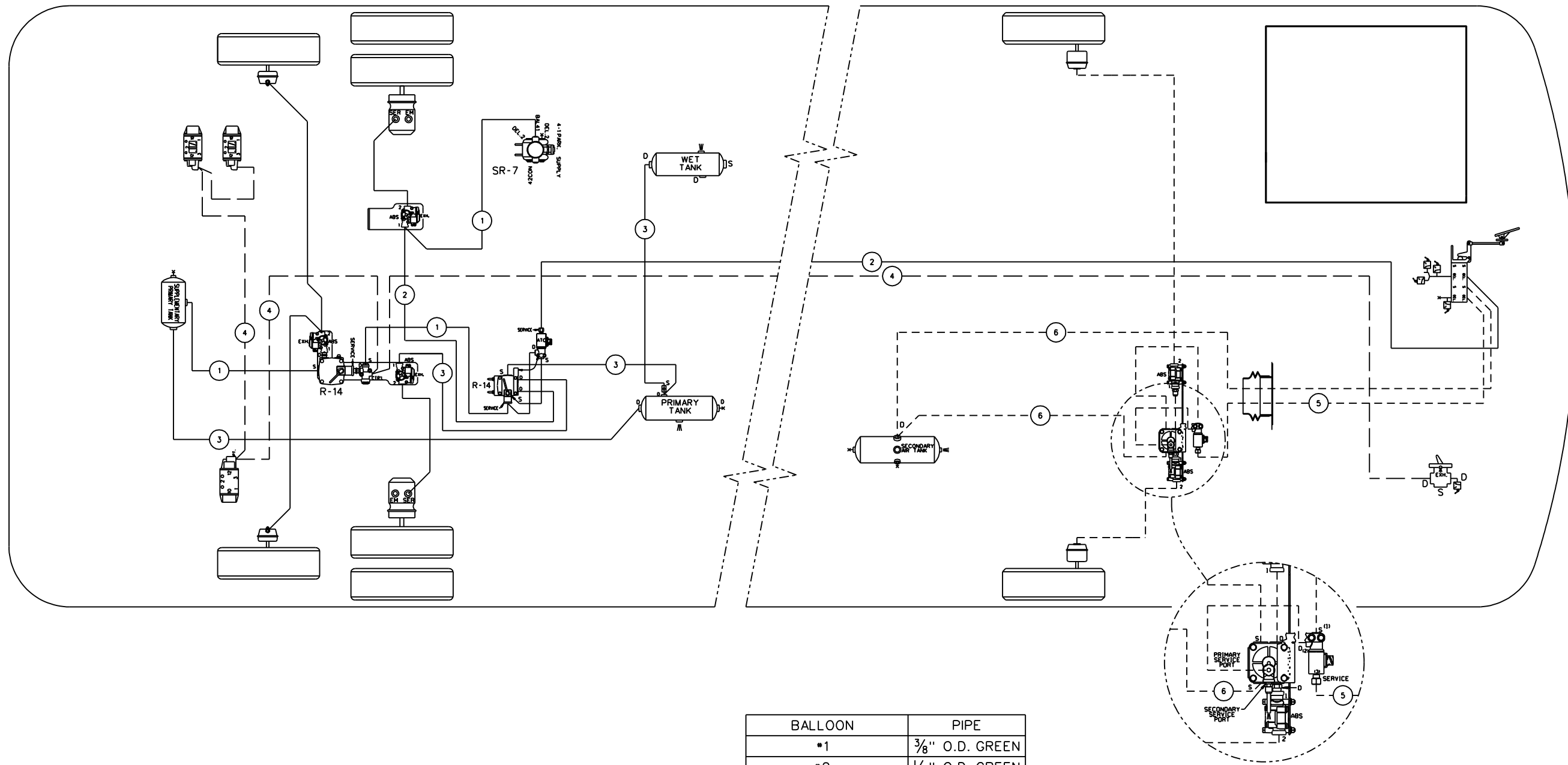

BALLOON	PIPE
*1	3/8" O.D. GREEN
*2	1/2" O.D. GREEN
*3	5/8" O.D. GREEN
*4	1/4" O.D. BLACK
*5	1/2" O.D. RED
*6	5/8" O.D. RED

TUBE COLOR CODING	
ACTIVE COLOR	CIRCUIT
— GREEN	PRIMARY & SUPPLY
— BLACK	ACCESSORIES
--- RED	SECONDARY

**PREVOST**®

DESCRIPTION:

WE BUS SHELL  
WITH OPTION ESP BRAKE SYSTEM

REV.:

A

PAGE:

DATE:

2010/11

D140385 P3.1

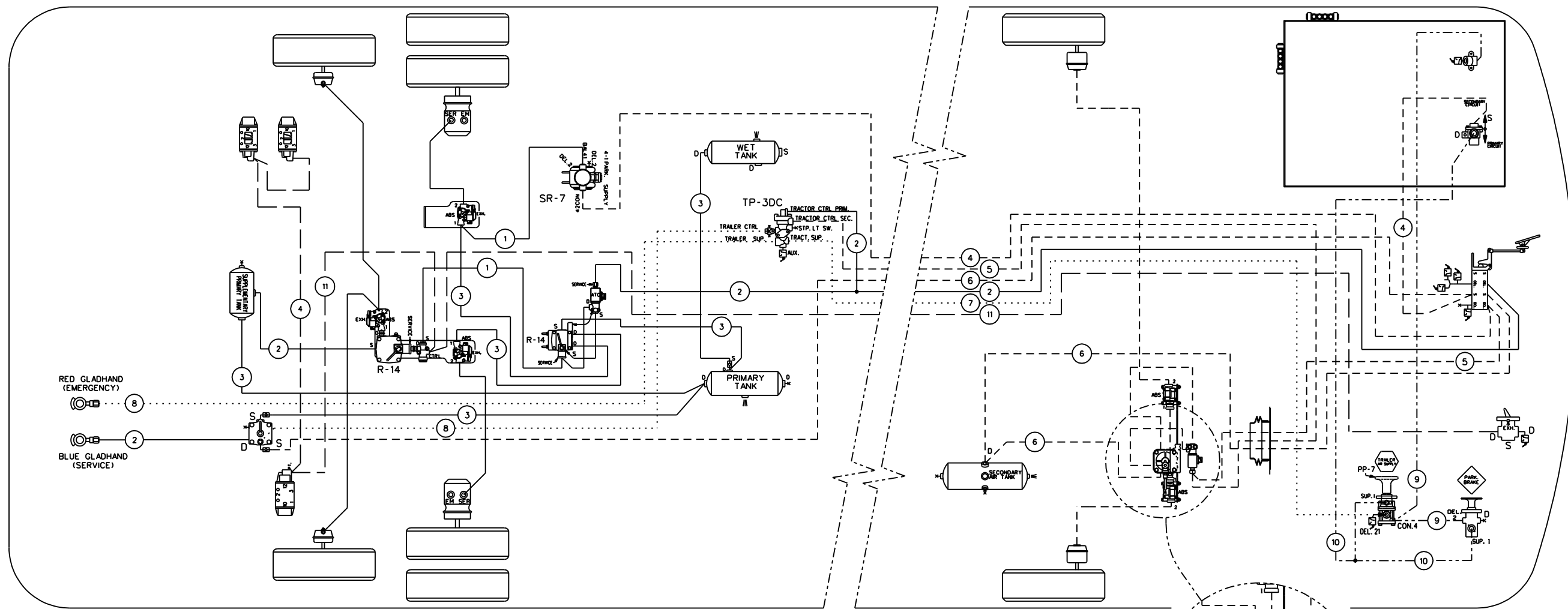

RED GLADHAND  
(EMERGENCY)

BLUE GLADHAND  
(SERVICE)

BALLOON	PIPE
•1	3/8" O.D. GREEN
•2	1/2" O.D. GREEN
•3	3/8" O.D. GREEN
•4	3/8" O.D. RED
•5	1/2" O.D. RED
•6	3/8" O.D. RED
•7	3/8" O.D. BROWN
•8	1/2" O.D. BROWN
•9	1/4" O.D. YELLOW
•10	3/8" O.D. YELLOW
•11	1/4" O.D. BLACK
•12	3/8" O.D. BLACK

TUBE COLOR CODING	
ACTIVE COLOR	CIRCUIT
---	RED SECONDARY
---	GREEN PRIMARY & SUPPLY
---	YELLOW PARKING BRAKE
---	BROWN TRAILER
---	BLACK ACCESSORIES

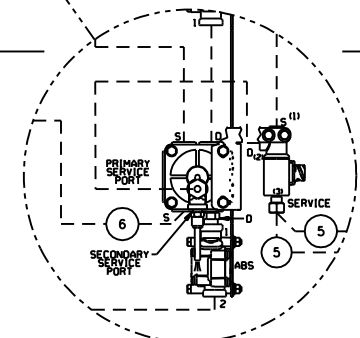

**PREVOST®**

DESCRIPTION:

BUS SHELL WE WITH OPTION TRAILER HITCH AIR BRAKE WITH ESP BRAKE SYSTEM

REV.:

A

PAGE:

DATE:

2010/11

D140385 P4.1

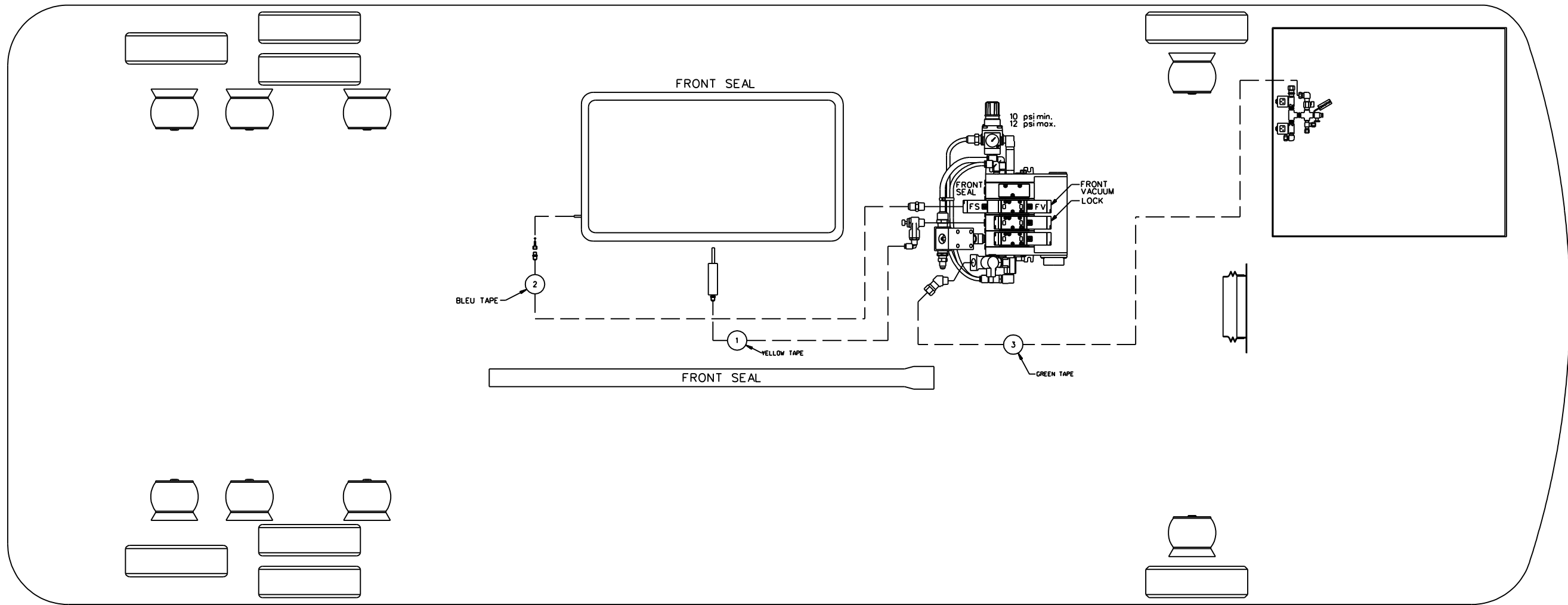

BALLOON	PIPE
*1	1/8" O.D. BLACK
*2	3/8" O.D. BLACK
*3	1/2" O.D. BLACK

TUBE COLOR CODING		
LINE TYPE	COLOR	CIRCUIT
---	BLACK	ACCESSOIRES

**PREVOST®**

DESCRIPTION:  
BUS SHELL WE WITH OPTION SINGLE SLIDE-OUT

REV.: A  
DATE: 2010/11

PAGE:  
D140385 P5.1

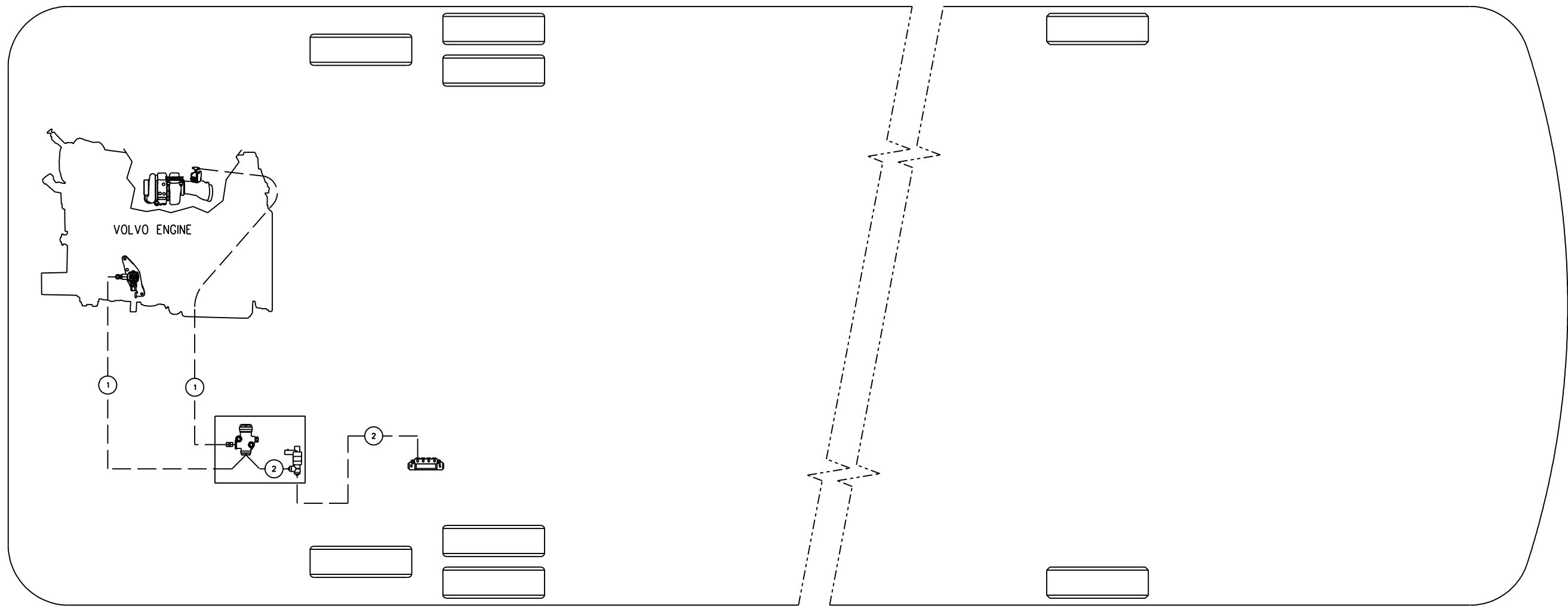

TUBE COLOR CODING		
ACTIVE	COLOR	CIRCUIT
—	BLACK	ACCESSORIES

BALLOON	PIPE
*1	HOSE ASS'Y
*2	1/4" O.D. BLACK

**PREVOST**®

DESCRIPTION:

WE BUS SHELL  
WITH OPTION WITHOUT OUTPUT RETARDER ON WORLD  
TRANSMISSION

REV.:

A

PAGE:

DATE:

2010/11

D140385 P6.1

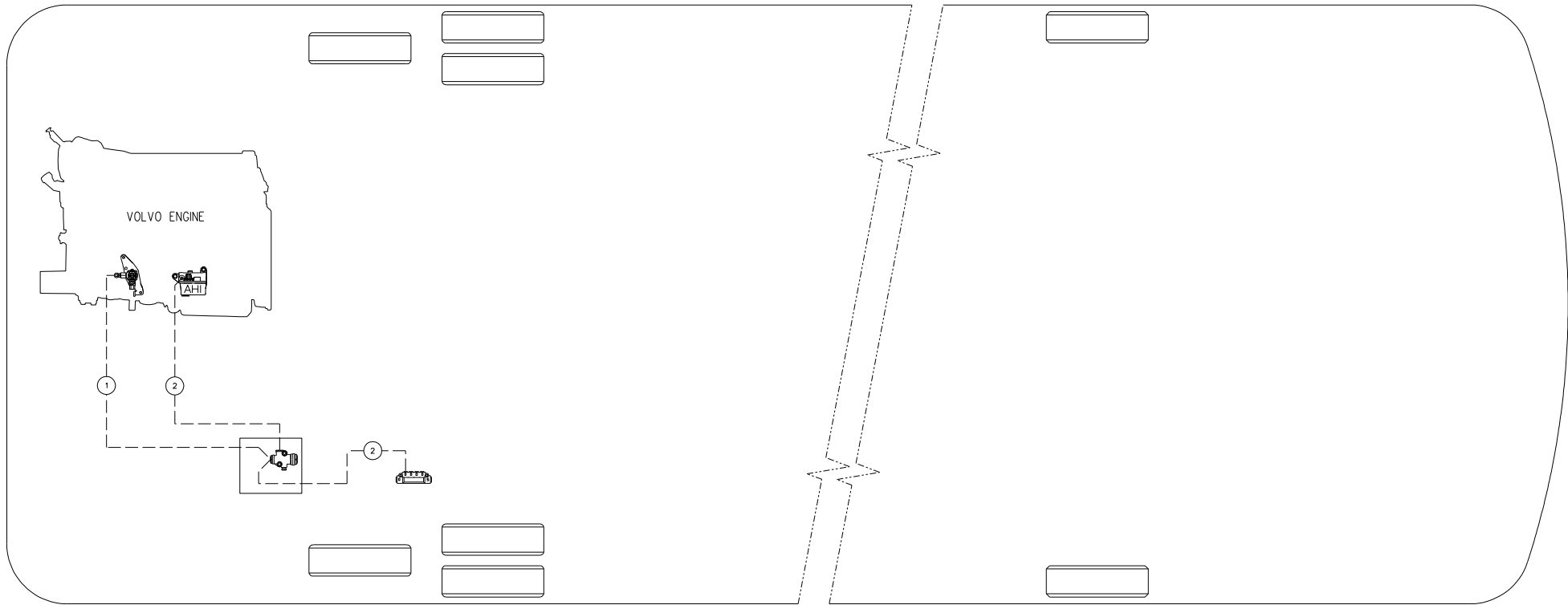

TUBE COLOR CODING		
ACTIVE	COLOR	CIRCUIT
---	BLACK	ACCESSORIES

BALLOON	PIPE
*1	HOSE ASS'Y
*2	1/4" O.D. BLACK

**PREVOST®**

DESCRIPTION:

WE BUS SHELL  
WITH OPTION WITHOUT OUTPUT RETARDER ON WORLD  
TRANSMISSION

REV.:

B

DATE:

2011/02

PAGE:

D140385 P6.1

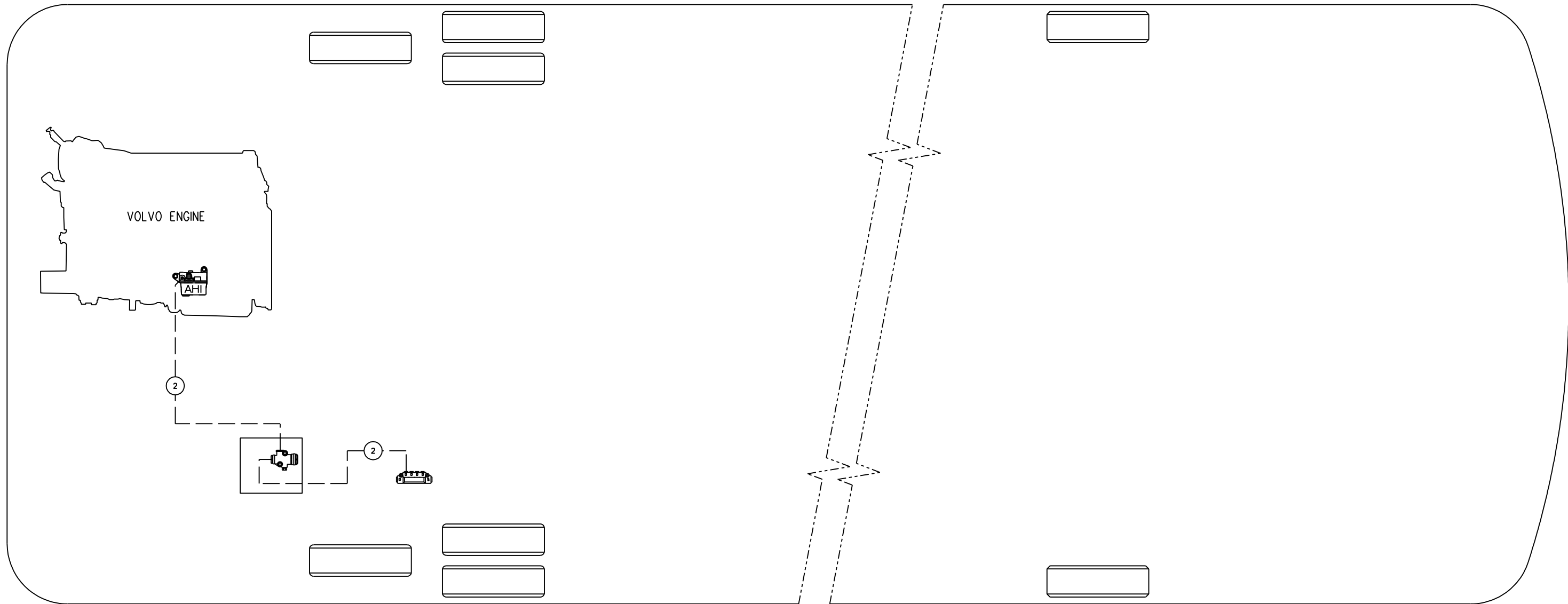

TUBE COLOR CODING		
ACTIVE	COLOR	CIRCUIT
---	BLACK	ACCESSORIES

BALLOON	PIPE
*1	---
*2	1/4" O.D. BLACK

**PREVOST®**

DESCRIPTION:

WE BUS SHELL  
WITH OPTION WITHOUT OUTPUT RETARDER ON WORLD  
TRANSMISSION

REV.:

C

PAGE:

D140385 P6.1

DATE:

2011/12

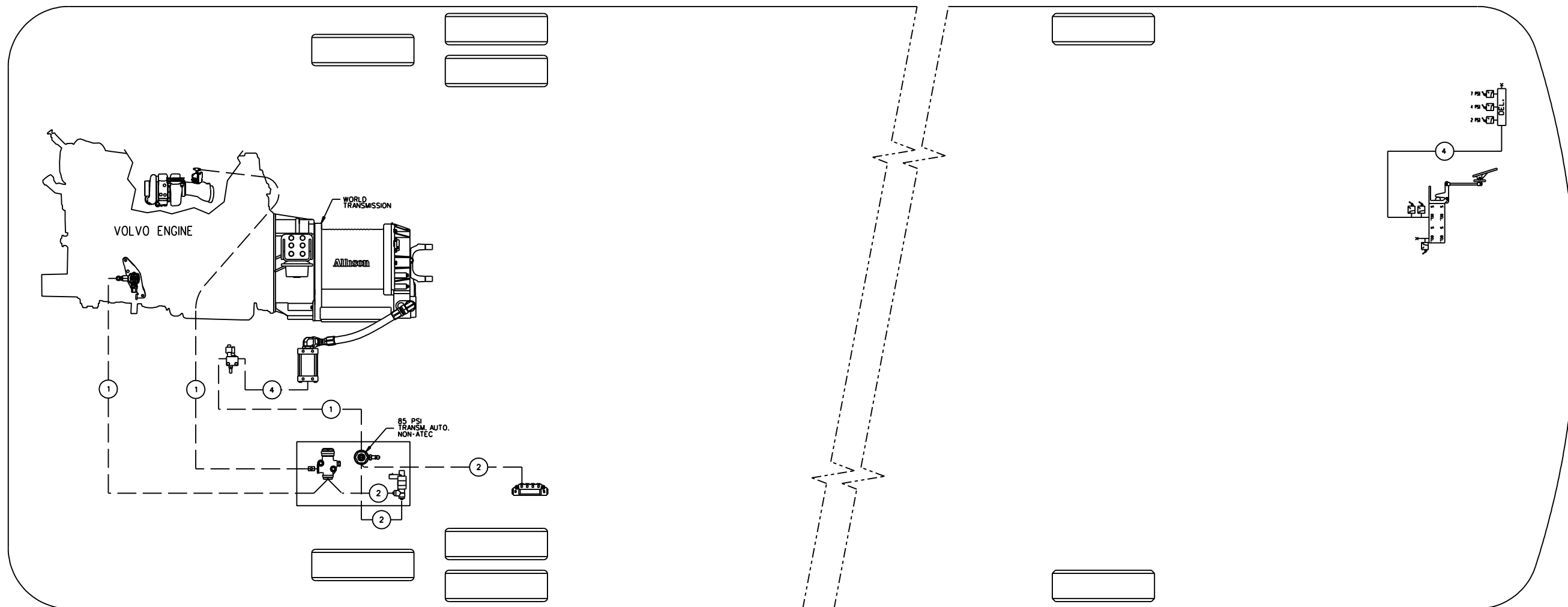

TUBE COLOR CODING		
ACTIVE	COLOR	CIRCUIT
---	BLACK	ACCESSORIES
---	GREEN	PRIMARY & SUPPLY

BALLOON	PIPE
*1	HOSE ASS'Y
*2	1/4" O.D. BLACK
*3	3/8" O.D. BLACK
*4	3/8" O.D. GREEN

**PREVOST**®

DESCRIPTION:

WE BUS SHELL WITH OPTION OUTPUT RETARDER ON  
WORLD TRANSMISSION

REV.:

A

PAGE:

DATE:

2010/11

D140385 P7.1

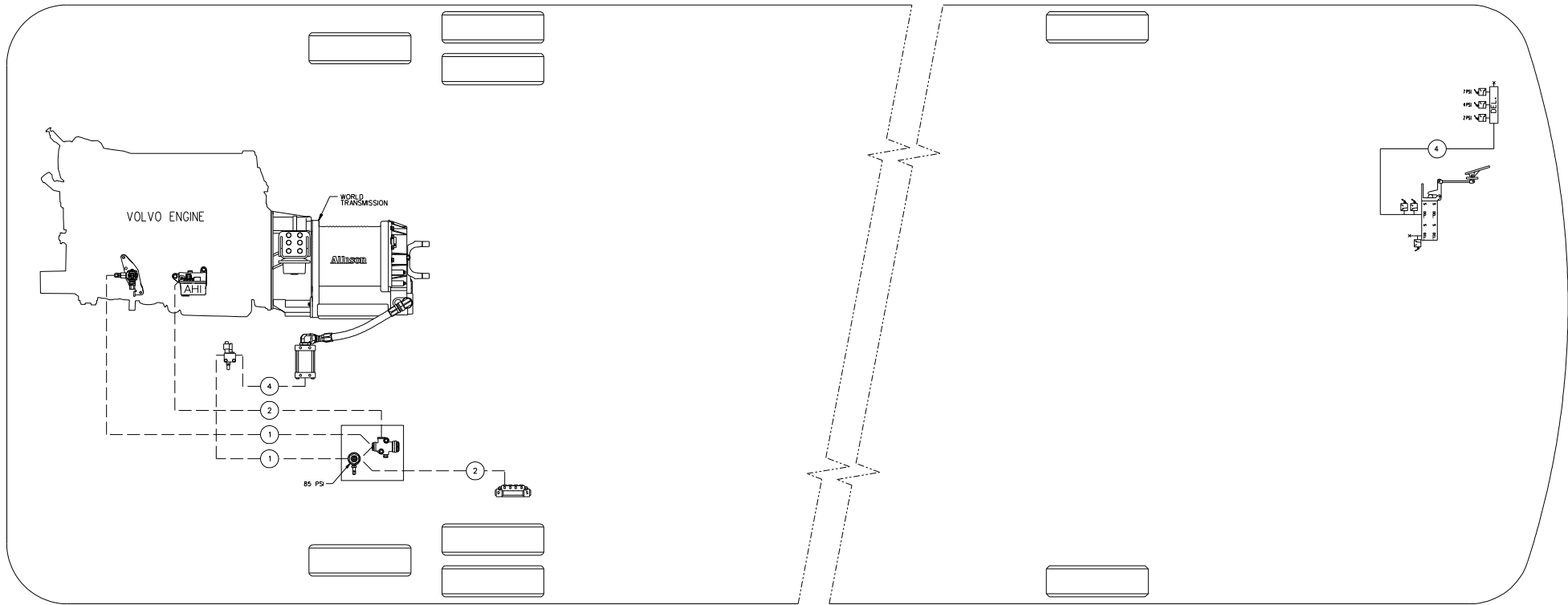

TUBE COLOR CODING		
ACTIVE	COLOR	CIRCUIT
---	BLACK	ACCESSORIES
---	GREEN	PRIMARY & SUPPLY

BALLOON	PIPE
*1	HOSE ASS'Y
*2	1/4" O.D. BLACK
*3	3/8" O.D. BLACK
*4	3/8" O.D. GREEN

**PREVOST**®

DESCRIPTION:

WE BUS SHELL WITH OPTION OUTPUT RETARDER ON  
WORLD TRANSMISSION

REV.:

B

DATE:

2011/02

PAGE:

D140385 P7.1



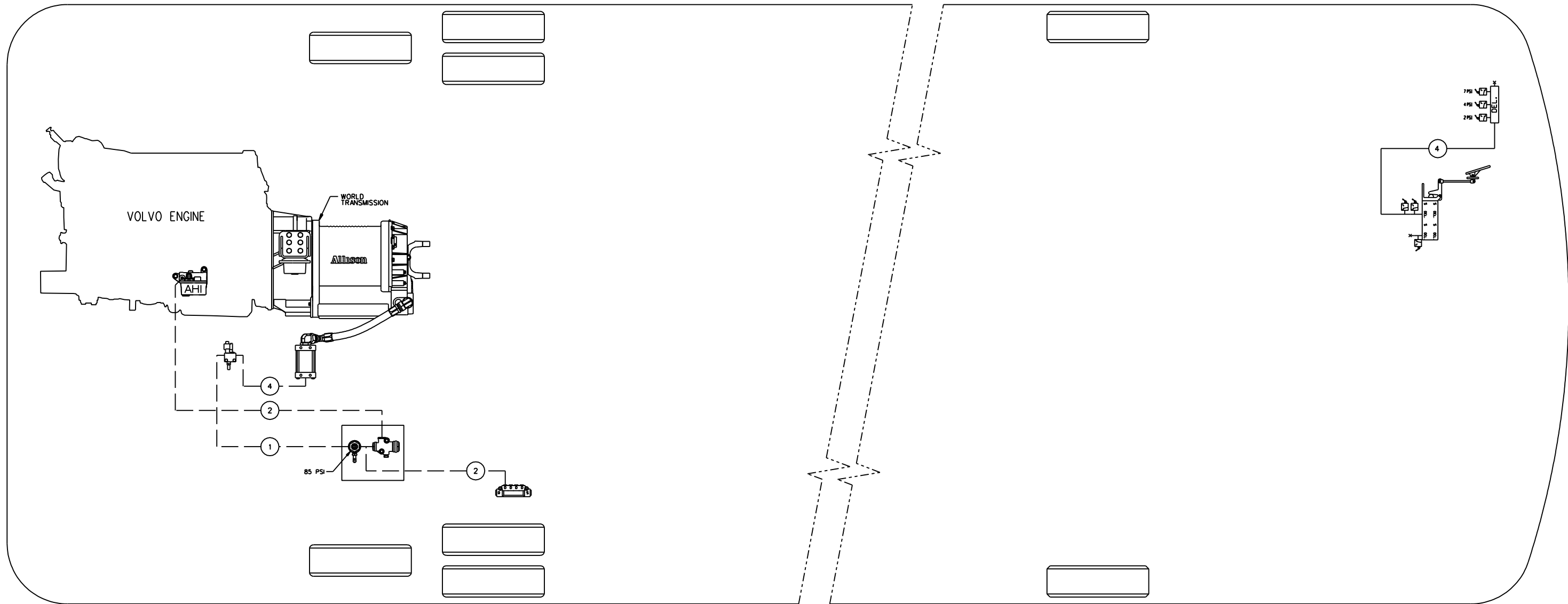

TUBE COLOR CODING		
ACTIVE	COLOR	CIRCUIT
---	BLACK	ACCESSORIES
---	GREEN	PRIMARY & SUPPLY

BALLOON	PIPE
*1	HOSE ASS'Y
*2	1/4" O.D. BLACK
*3	3/8" O.D. BLACK
*4	3/8" O.D. GREEN

**PREVOST**®

DESCRIPTION:

WE BUS SHELL WITH OPTION OUTPUT RETARDER ON  
WORLD TRANSMISSION

REV.:

C

PAGE:

DATE:

2011/12

D140385 P7.1

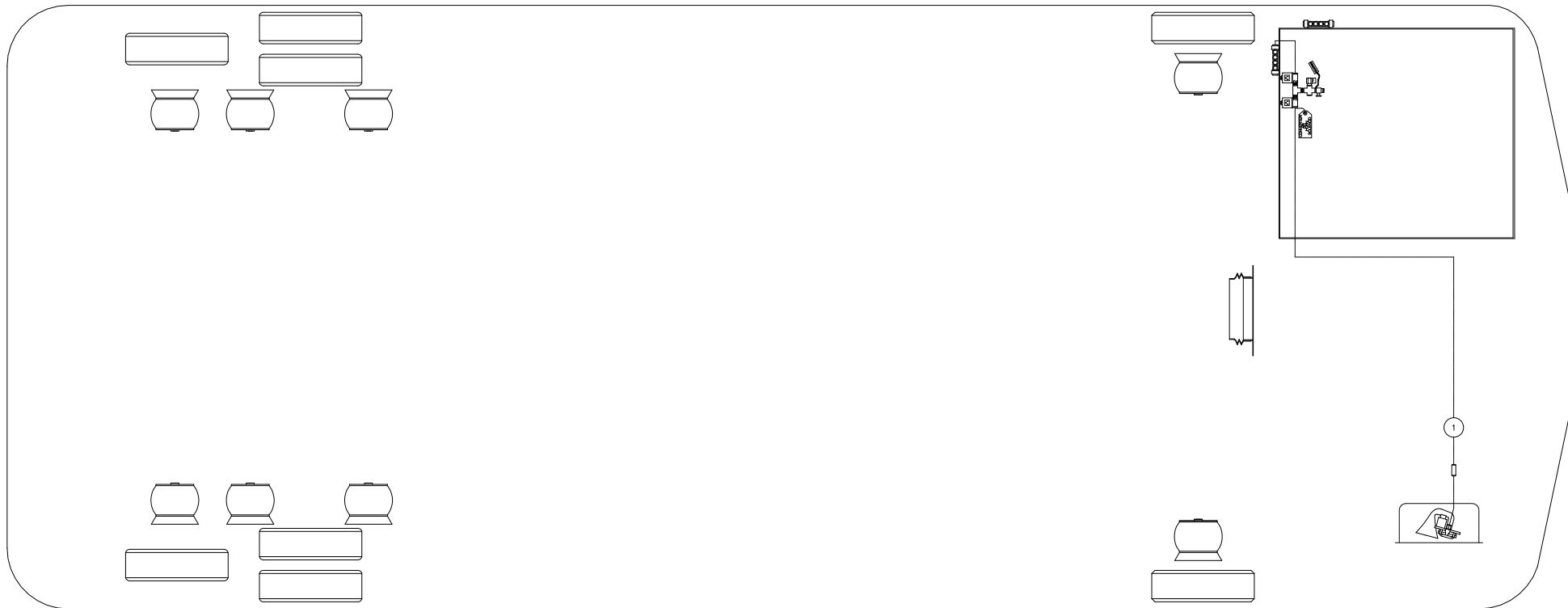

BALLOON	PIPE
*1	1/4" O.D. BLACK

TUBE COLOR CODING		
LINE TYPE	COLOR	CIRCUIT
	BLACK	ACCESSOIRES

**PREVOST®**

DESCRIPTION:

BUS SHELL WE WITH SPECIAL OPTION AIR HORN

REV.:

A

DATE:

2013/02

PAGE:

D140385 SP1.1

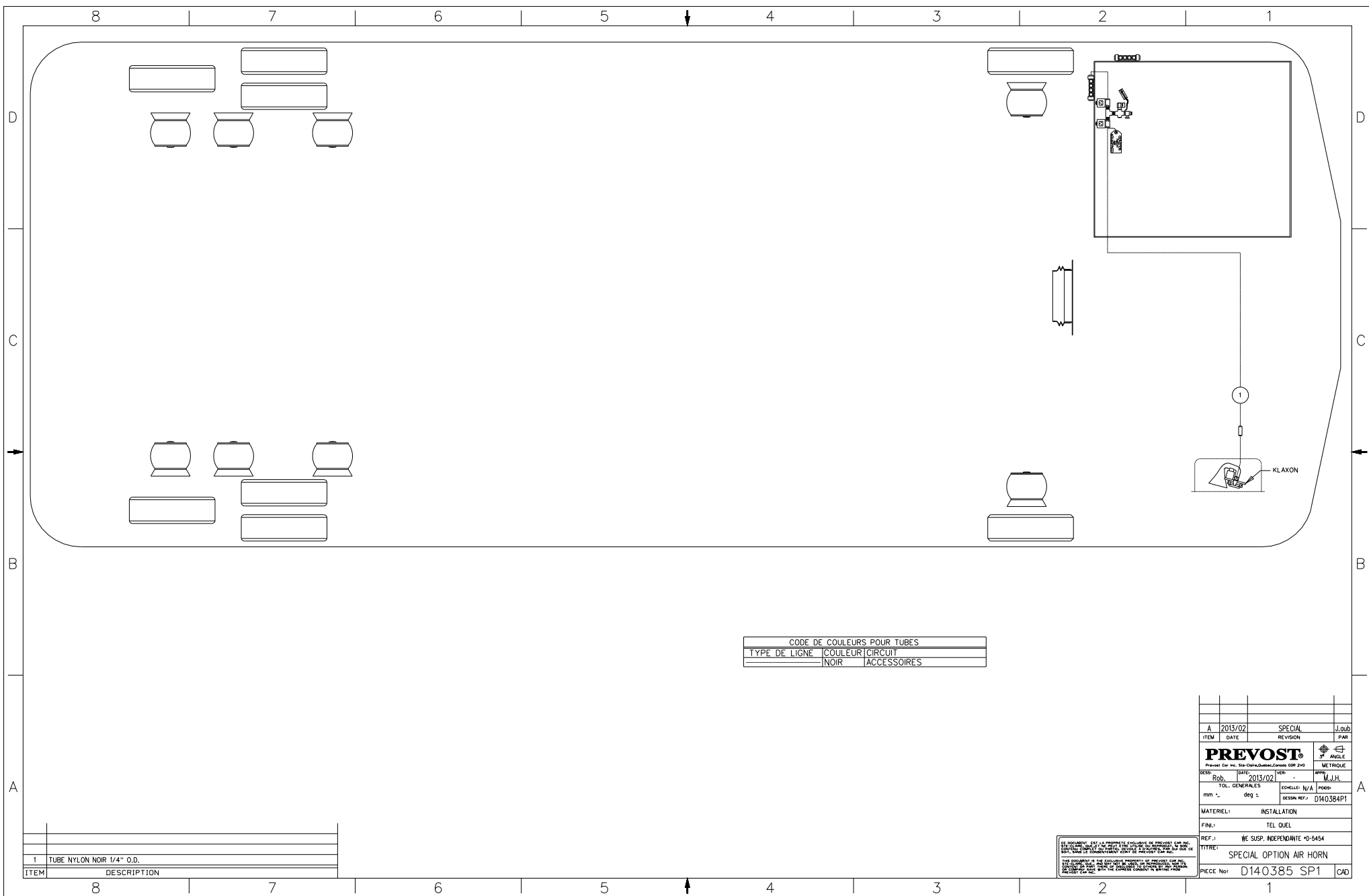

CODE DE COULEURS POUR TUBES		
TYPE DE LIGNE	COULEUR	CIRCUIT
---	NOIR	ACCESSOIRES

ITEM	DESCRIPTION
1	TUBE NYLON NOIR 1/4" O.D.

CE DOCUMENT EST LA PROPRIETE EXCLUSIVE DE PREVOST QUI NE  
 SAUVEGARDE AUCUN DROIT DE RESERVE EN CE QUI CONCERNE  
 LE DROIT DE REPRODUCTION DE CE DOCUMENT POUR UN BUT DE  
 COMMERCIAL QUEL QU'IL SOIT. LE PRESENT DOCUMENT NE PEUT  
 ETRE REPRODUIT NI COMMUNIQUE EN TOUT OU EN PARTIE  
 SANS L'AUTORISATION ECRITE DE PREVOST.

ITEM	A	DATE	2013/02	REVISION	SPECIAL	J.oub
REF.	WE SUSP. INDEPENDANTE D-5454					
TITRE:	SPECIAL OPTION AIR HORN					
PIECE No:	D140385	SP1	CD			