

PREVOST

Instruction Sheet

IS-23505







H3 SUBWOOFER INSTALLATION

First Release

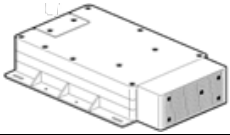
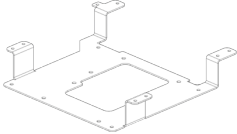
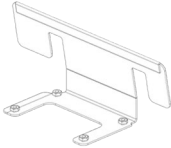
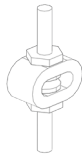
09-14-2023

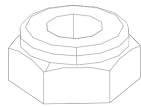
MATERIAL

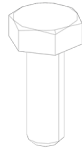
Kit #IS23505 includes the following parts:

Part No	Description		Qty
901193	SUBWOOFER VB-170		2
406293	FIXING PLATE		2
405829	DEFLECTOR		4
5060076	VIBRATION DAMPING MOUNTS		8
500526	SCREW TAPPING HEXW N500 #12X3/4		8
502874	NUT HEX NYRT NX500 1/4-20		16
500877	WASHER FLAT N500 .250X.562X.065		8
5001746	SCREW CAP HEX N500 1/4-20X.75 G5		16
500473	WASHER LOCK SPLIT Z050 .262X.489X.062		16

504637	CABLE TIE, NYLON BLACK		10
IS-23505	Instruction Sheet		1
FI-23505	Feuille d'instructions		1

NOTE
<i>Material can be obtained through regular channels.</i>

SAFETY PRECAUTIONS

- Eye protection should always be worn when working in a shop.
- Rules for Personal Protection Equipment should always be respected. Wear your PPE including but not limited to the following:



Safety First!



PROCEDURE



DANGER

Park vehicle safely, apply parking brake, stop engine. Prior to working on the vehicle, set the ignition switch to the OFF position and trip the main circuit breakers equipped with a trip button. On Commuter type vehicles, set the battery master switch (master cut-out) to the OFF position.

Lock out & Tag out (LOTO) must be performed during set-up, maintenance or repair activities. Refer to your local procedure for detailed information regarding the control of hazardous energy.

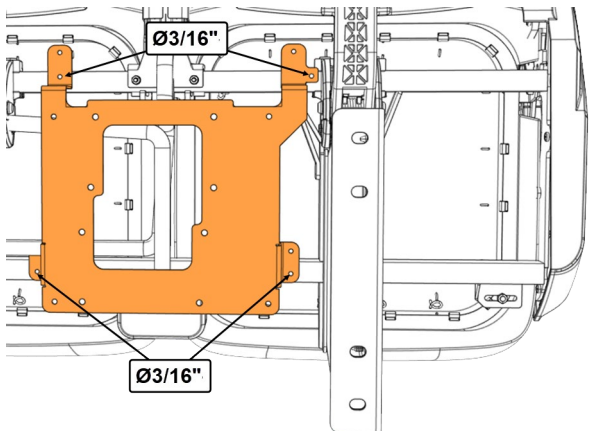
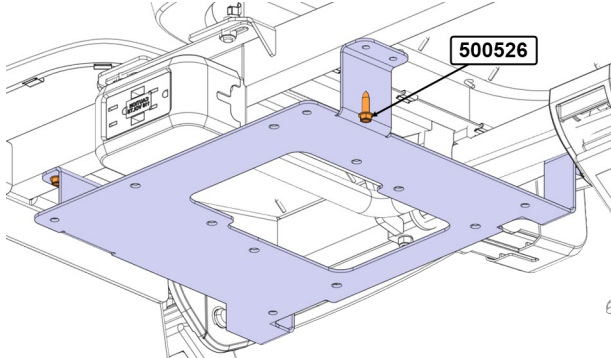
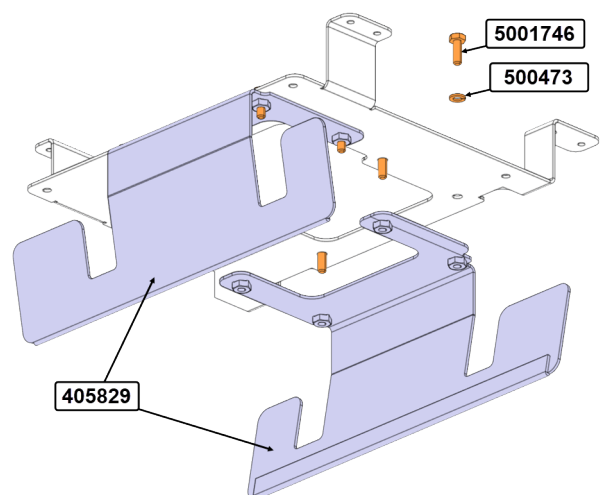
<ol style="list-style-type: none">1. Position the mounting plate longitudinally with mounting holes as centered as possible in relation to the seat tubes.2. Take a hydraulic jack to keep the mounting plate in place.3. Drill 4 holes $\text{\O}3/16''$ using the mounting plate as a positioning template. Drill only through the first wall.	
<ol style="list-style-type: none">4. Insert screws 500526 (4x) into the holes to pre-form the threads, then remove the screws.	
<ol style="list-style-type: none">5. Install the deflectors 405829 (2x) on the mounting plate with screws 5001746 (8x) and lock washer 500473 (8x).	

6. Install mounts 5060076 (4x) on the mounting plate with nuts 502874 (4x).

Do not tighten the nuts on mount too tightly.

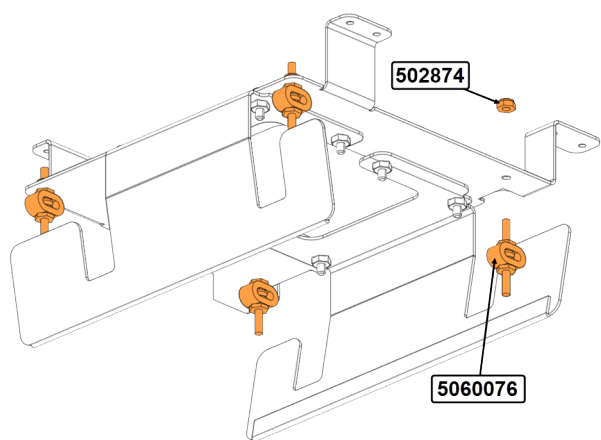

7. Install the subwoofer 901193 on the mount with flat washers 500577 (4x) and nuts 502874 (4x). Make sure the speaker connector is positioned as shown.

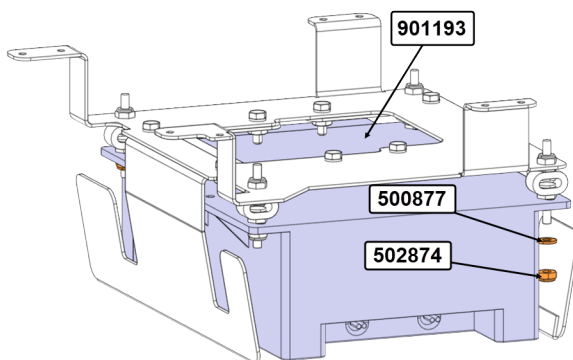

8. Connect the interface cable to the existing wiring.
9. Connect the interface cable to the subwoofer.
10. Use cable ties 504637 (5x) to secure the wiring with the seat structure.
11. Repeat the previous steps for the second speaker.
12. Test the operation of both subwoofers.

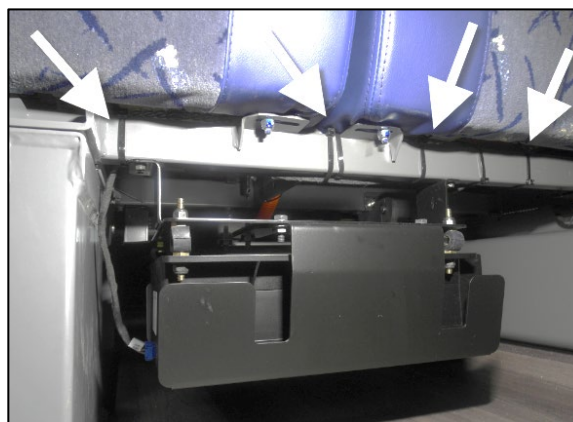

PARTS / WASTE DISPOSAL

Discard waste according to applicable environmental regulations (Municipal/State[Prov.]/ Federal)