

Safety Recall

SR14-82

Date Expiration Group No. Page
04.2014 **n/a** **01** **1(7)**

SLIDING SEATS PEDESTALS INSPECTION AND REPLACEMENT 9700 (B13R) US/CAN

MODEL YEAR(S) AND VEHICLE SERIAL NUMBERS (VIN) INVOLVED

VIN					
Model affected	Vehicles affected				
Volvo 9700 US/CAN Model Year: 2009 up to 2014	3CET2M62695133174	3CET2M626A5136399	3CET2S223B5143807	3CET2S221D5155361	3CET2S224D5160764
	3CET2M62X95133288	3CET2M629A5136400	3CET2S222B5145919	3CET2S223D5155362	3CET2S226D5160765
	3CET2M62395133293	3CET2M621A5139727	3CET2S229B5145920	3CET2S225D5155363	3CET2S229D5160985
	3CET2M62295133513	3CET2M620A5139721	3CET2S220B5145921	3CET2S228D5155373	3CET2S220D5160986
	3CET2M62495133514	3CET2M626A5139724	3CET2S222B5145922	3CET2S22XD5155374	3CET2S222D5160987
	3CET2M62695133515	3CET2M623A5139728	3CET2S225B5147664	3CET2S221D5155375	3CET2S224D5160988
	3CET2M62X95133517	3CET2M621A5139730	3CET2S229B5148252	3CET2S223D5155376	3CET2S226D5160989
	3CET2M62295133964	3CET2M623A5139731	3CET2S220B5148253	3CET2S227D5155493	3CET2S220E5162495
	3CET2M62495133965	3CET2M625A5139732	3CET2S224B5148434	3CET2S229D5155494	3CET2S226E5162498
	3CET2M624A5135803	3CET2M627A5139733	3CET2S226B5148435	3CET2S220D5155495	3CET2S228E5162499
	3CET2M626A5135804	3CET2M629A5139734	3CET2S226B5148659	3CET2S227D5157597	3CET2S220E5162500
	3CET2M620A5135801	3CET2M625A5140332	3CET2S222B5148853	3CET2S225D5157596	3CET2S222E5162501
	3CET2M623A5136019	3CET2M627A5140333	3CET2S226B5148855	3CET2S221D5159698	3CET2S220E5162609
	3CET2M62XA5136129	3CET2M629A5140334	3CET2S224B5148854	3CET2S223D5159699	3CET2S226E5163098
	3CET2M628A5136131	3CET2M620A5140335	3CET2S228B5148856	3CET2S226D5159700	3CET2S228E5163099
	3CET2M627A5136377	3CET2M622A5140336	3CET2S22XB5148857	3CET2S22XD5159697	3CET2S220E5163100
	3CET2M629A5136378	3CET2M62XA5140469	3CET2S22XC5152652	3CET2S228D5160296	3CET2S222E5163101
	3CET2M62195133518	3CET2M626A5140470	3CET2S228D5154823	3CET2S22XD5160297	3CET2S224E5163102
	3CET2M62695134115	3CET2M628A5140471	3CET2S227D5155218	3CET2S225D5160756	3CET2S226E5163103
	3CET2M622A5136397	3CET2S229B5142239	3CET2S229D5155219	3CET2S227D5160757	3CET2S222E5163728
3CET2M624A5136398	3CET2S221B5143806	3CET2S225D5155220	3CET2S229D5160758		

DESCRIPTION

On the vehicles affected by this recall, the sliding seats which can be moved to make room for wheelchair passengers, have lock down handles that may bend causing damage to the locking mechanism and allowing the seat to not lock in place. If not locked in place, the seat may move forward and backwards on the track, increasing the risk of injury to the seat passenger if the coach is involved in a crash.

The purpose of this procedure is to verify and replace as required the passenger sliding seat pedestals, install plates along the sliding seat rail to show correct locking positions and provide an addendum to the operation instruction decals on the seats.

Date	Expiration	Group	No.	Page
04.2014	n/a		01	2(7)

If you do not have the ability or the required tools to perform this bulletin, please contact your Prevest Service Center or Authorized Service Provider to schedule an appointment at your earliest convenience. Please mention Safety Recall SR14-82. A complete list of all 135+ affiliated Prevest service points is available at: www.prevestcar.com/network

MATERIAL

NOTE: THE MATERIAL REQUIRED FOR ONE SLIDING SEAT IS SHOWN BELOW.

Part No	Part description	Quantity	Comments
7775036	Left Sliding Pedestal	1	As required
7775038	Right Sliding Pedestal	1	As required
7775033	Plate	2	
7775034	Screw	12	
7775032	Decal instructions	1	

PROCEDURE



DANGER

Park vehicle safely, apply parking brake and stop engine prior to working on the vehicle.

Part I: Inspection of Sliding Pedestals.

1) Inspection of Lever Mechanism Alignment.

With the pedestal side cover removed, inspect if the lever mechanism is aligned straight (as showed on picture below). If there is any deformation on the hand lever or any interference generated between components, likely caused by the over-torqueing or general misuse of the lever, it is necessary to replace the entire pedestal.

NOTE: If no damage is found go to next step, if damage is found go to Part II step 6 according to this bulletin.



Date	Expiration	Group	No.	Page
04.2014	n/a		01	3(7)

2) Inspection of the Adjusting Screw

Remove both adjusting screw covers; you will see the adjusting screw which permits the tightening of the guides. First inspect if the screw is loose; a loose screw could be caused by inadequate service. If you identify a loose screw, follow the adjusting instructions shown in Part II step 11

NOTE: All sliding pedestals have to be inspected.



3) No Damage Found.

Once all the pedestals have been inspected and no damage has been found, proceed to the rail cleaning, installation of the Plates and QR driver decal installation.

Install the plates that indicate the sliding seat position according to the procedure shown in this bulletin.

4) Rails Cleaning Procedure

Cleaning procedure is mandatory to be executed in all cases mentioned in this bulletin. Using a vacuum cleaner, remove all dirt and debris that may have accumulated in the sliding seats rails. This will ensure optimal sliding seat performance.

After rail has been cleaned always verify the seat can slide freely.

NOTE: Do not use any kind of lubricant on the rails.

Date	Expiration	Group	No.	Page
04.2014	n/a		01	4(7)

Part II Pedestal Replacement

- 5) Pull the side lever (A) to release and flip up the seat cushion.

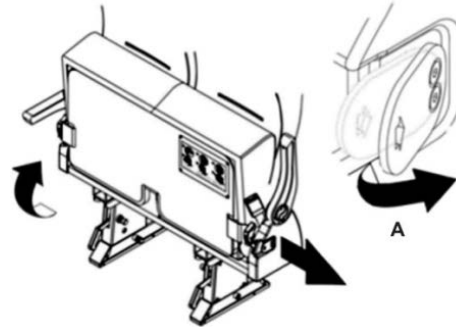

- 6) Pull the lock (B) and use your hand to move the lever up (C).

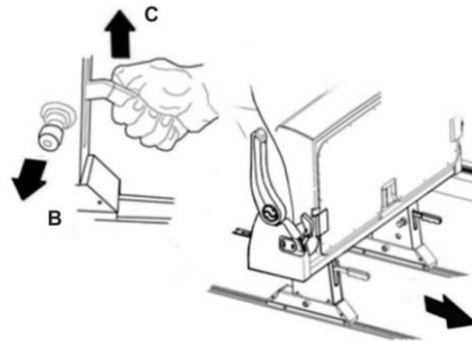

- 7) Slide the seat to the end of the rail and remove it.

NOTE: Is recommended 2 people perform this step.



DANGER

The sliding seat is heavy and bulky. Be sure to use necessary lifting equipment. In case of failure, the sliding seat may fall suddenly and cause injuries.



- 8) Install the new pedestal. This procedure is performed as follows.



CAUTION

For optimal results, it is recommended to perform this operation outside of the vehicle.

- 1.1 Install the new sliding pedestal(s) and tighten lightly, the distance between pedestals must be 485mm (19.1po).

NOTE: Make sure the guides are aligned to the rails.

- 1.2 Move the lever down and fix the pedestal

NOTE: Make sure that the seat slide freely, otherwise perform adjustment procedure Part II, step 11.

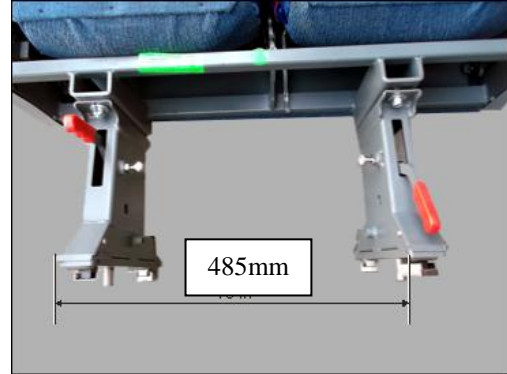

- 9) Adjustment Procedure.

- 9.1 Remove both adjusting screw covers.

- 9.2 Loosen the nut and hand tight the screws, back off 1.5 turns and tighten the nut.

NOTE: Be sure to untighten the screw one and a half turns in order to allow some clearance between the slider and the rail.

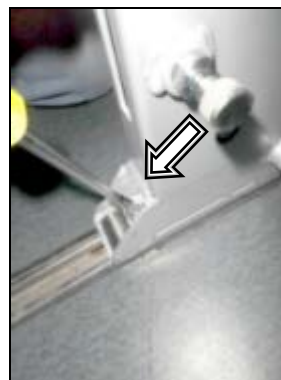

Date	Expiration	Group	No.	Page
04.2014	n/a		01	6(7)

Part III: Plates Installation.

- 1) Install the plates according to the dimensions an orientation shown in images 1 and 2. Use the stopper plate as reference (A).

NOTE: Each sliding seat requires two plates.

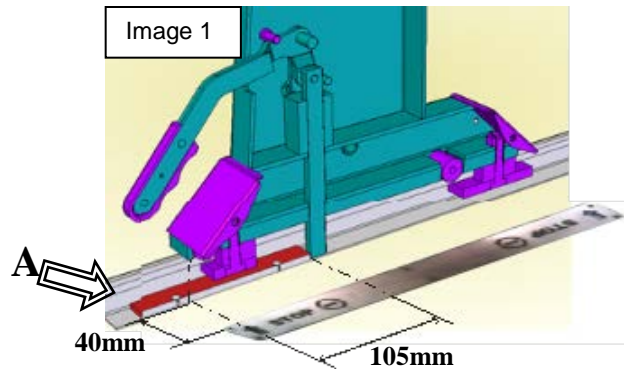

DANGER

The edges of the pedestal need to be aligned with the arrows on the lateral plate. Do not try to push the levers down if the pedestal is not aligned with the arrows.

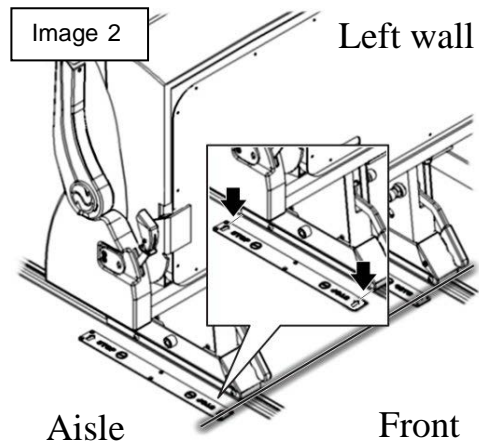

- 2) Push down the lever (C) using your hand. And fold the seat cushion down.

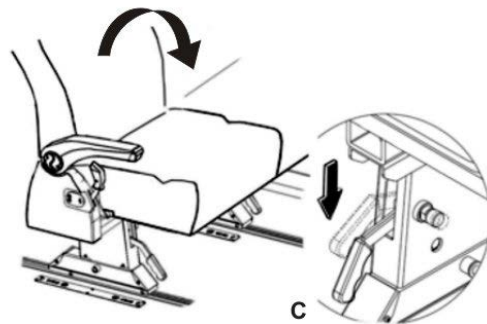

Part IV: Decal Replacement.

- 1) Heat with a heat gun and remove the decal.

NOTE: Clean remaining glue.

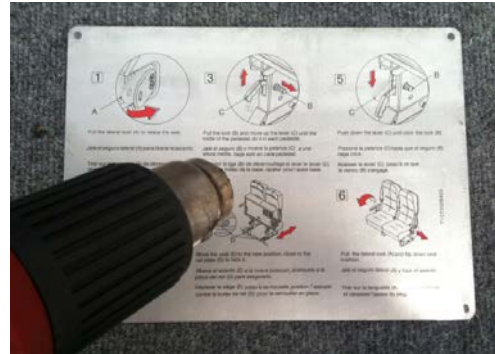

- 2) Stick and trim surplus material according to the plate profile.

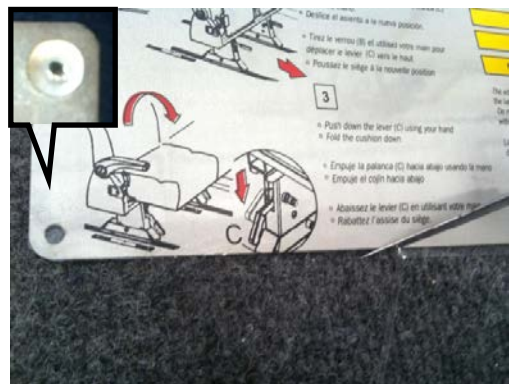

PARTS / WASTE DISPOSAL

DO NOT RETURN THE REPLACED PARTS. Discard waste according to applicable environmental regulations (Municipal/State[Prov.]/ Federal)

WARRANTY

This modification is covered by Prevo's normal warranty. We will reimburse you the parts and two hour(s) (2.0) of labor plus fifteen minutes (0.15) for each pedestal ordered upon receipt of a warranty claim. Please submit claim via our Online Warranty System, available at www.prevo.com (under Service \ Warranty section). Use Claim Type: "Bulletin/Recall" and select "Safety Recall SR14-82".

OTHER

VBC Bulletin	TBC
Fail Code	25.00
Defect Code	09
Syst.Cond.	R
Causal Part	7775036

Access all our Service Bulletins on
<http://prevostparts.volvo.com/technicalpublications/en/pub.asp>

or scan the QR-Code with your smart phone.

E-mail us at technicalpublications_prev@volvo.com and type "ADD" in the subject to receive our warranty bulletins by e-mail.

