

Starting and Stopping Procedures 6-1

STARTING THE ENGINE	2
STARTING FROM THE DRIVER'S SEAT	2
STOPPING THE ENGINE	2
STARTING FROM THE ENGINE COMPARTMENT	2
COLD WEATHER STARTING	3
ENGINE BLOCK HEATER	3
ENGINE PROTECTION SYSTEM	4
AUTOMATIC ENGINE SHUTDOWN	4
IDLE SHUTDOWN TIMER	4
JUMP STARTING	4
ENGINE WARM-UP	5
ALLISON TRANSMISSION WARM-UP	6
STARTING THE VEHICLE AFTER A FIRE ALARM	6

STARTING THE ENGINE

In normal circumstances, the engine should be started from the driver's seat. However, a rear-start panel in the engine compartment permits starting the engine from that location, mainly for maintenance purposes.

STARTING FROM THE DRIVER'S SEAT

- Apply the spring-loaded parking brakes by pulling the parking brake control button all the way up;
- Make sure that the starter selector switch located in the engine compartment is set to the *NORMAL* position;
- Place transmission in neutral;
- Turn ignition key to *START* position (refer to "Controls and Instruments" chapter), release the key after the engine starts.
- Brake pedal must be applied when selecting Drive (D) otherwise the transmission will stay in neutral (N).

 CAUTION
Do not engage starter for more than 15 seconds at a time. If engine does not start within 15 seconds, release ignition key and let starter cool for one minute before attempting to restart.

 CAUTION
Do not press accelerator pedal before starting. This could result in an electronic control unit fault and degrade the fuel system control.

 CAUTION
Special precautions are necessary with turbocharged engines to avoid possible turbine damage. After starting, run the engine at slow idle for two minutes to allow lubricating oil to reach the turbocharger. Then run the engine at fast idle. Let oil pressure reach normal operating range before driving.

<i>NOTE</i>
<i>If engine does not start, return key to OFF position before attempting to restart.</i>

<i>NOTE</i>
<i>If the accelerator pedal is depressed before starting, release and wait 30 seconds before attempting to restart.</i>

STOPPING THE ENGINE

- Apply parking brake and place transmission in neutral (N);
- Allow engine to idle for at least two minutes before shutting engine *OFF*. This insures that the turbine speed drops and allows time for the engine exhaust gas temperature to drop to about 300°F (150°C);
- Shut off all electrical loads;
- Turn the ignition key to the *OFF* position.

 CAUTION
Do not shut <i>OFF</i> engine when running above slow idle.

 CAUTION
Set the battery master switch (master cut-out) to the <i>OFF</i> position after parking and when left unattended for an extended period of time.

STARTING FROM THE ENGINE COMPARTMENT

Switches to start and stop the engine from inside the engine compartment are mounted on a small panel above the air filter.

 DANGER
Apply parking brake and place transmission in neutral (N) before starting engine from inside the engine compartment.

Set the battery master switches (ignition and master cut-out) to the *ON* position;

Set the starter selector switch to the *REAR START* position;

Press the *REAR START* push-button switch. Release push-button after the engine starts.

 **DANGER**

Do not wear loose clothing when working near engine. Stand clear of rotating components.

 **CAUTION**

Refer to cautions in “Starting From The Driver’s Seat” in this chapter

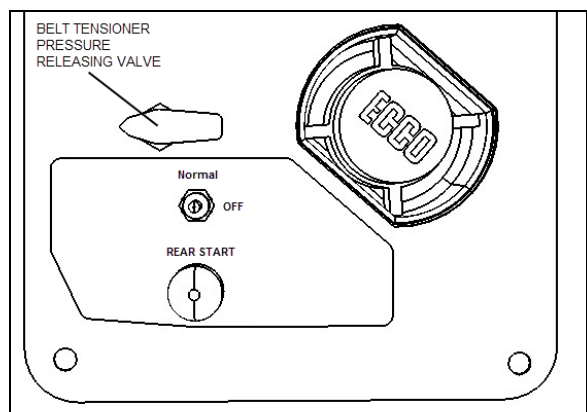

REAR START PANEL 06622_3

 **DANGER**

Rotating shafts can be dangerous. You can snag cloths, skin, hair, hands, etc. This can cause a serious injury or death. Do not work on a shaft (with or without a guard) when the engine is running.

Stopping the Engine

To stop the engine, set the starter selector switch to the *OFF* position.

 **CAUTION**

Do not stop engine by any other method.

COLD WEATHER STARTING

When starting a cold engine, the intake air should be warmed up by using the intake air preheater. Turn the ignition switch to the ON position. The preheater will not engage at coolant temperature above 54°F (12°C). If the coolant temperature is below 54°F (12°C), the

preheater will engage and will light the preheater telltale between 0 and 50 seconds, depending on the engine coolant temperature. Wait before the preheater telltale has turned off before starting the engine.

If necessary, once the engine has started, the preheater will reengage (post heating) for the same length of time as the preheat time.

 **WARNING**

Do not use ether or other combustable starting aid fluid on any engine equipped with an intake air preheater. If the engine is equipped with a preheater, introduction of ether or similar starting aids could cause a fire or explosion resulting in severe property damage, serious personal injury or death.

Engines not equipped with an intake air preheater may, depending on coolant temperature, take longer to start. If this should happen, DO NOT release the ignition key until the engine has started (while still observing the 15 second maximum cranking time).

ENGINE BLOCK HEATER

The vehicle may be equipped with an engine immersion-type electric block heater to assist cold weather starting. The 110-120 VAC power connector is located to the right, behind the engine compartment rear doors. Connect the female plug of an extension cord to the 110-120 VAC male outlet. Plug the extension cord into a 110-120 VAC power source only. Use the engine block heater whenever the vehicle is parked for an extended period of time in cold weather and when a 110-120 VAC power source is available.

 **CAUTION**

Use only a 110-120 VAC power source. Use only grounded (three prongs) extension cords with a minimum rated capacity of 15 amps. Disconnect the extension cord before starting. Before driving, make sure the extension cord is disconnected and the engine compartment door is closed.

6-4 Starting and Stopping Procedures

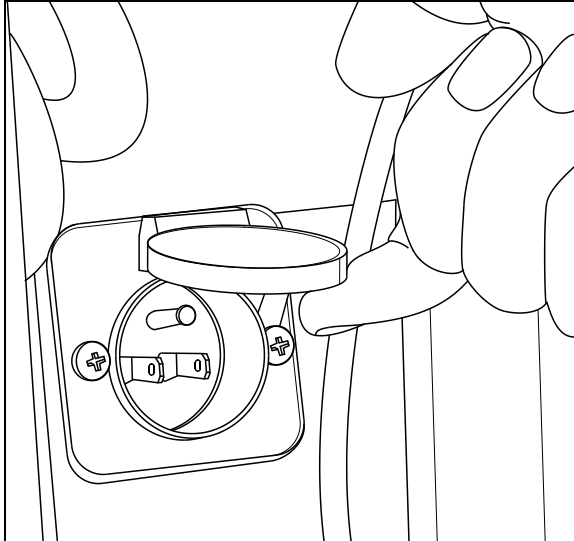

110-120 VOLTS CONNECTOR

06390

ENGINE PROTECTION SYSTEM

The engine protection will automatically derate or stop the engine when certain engine conditions reach a critical stage.

In the event of a serious fault, the red STOP telltale light comes on and an audible alarm will sound if the engine is running.



An illuminated STOP telltale light indicates a serious problem has been detected, and the driver must respond immediately to the problem. The vehicle must be safely pulled off the road and stopped. In some instances, the engine must be switched off immediately.

AUTOMATIC ENGINE SHUTDOWN

Prior to an actual automatic shutdown, the engine will automatically derate, go to idle, and then stop as the vehicle speed gets below 2 mph (3 km/h).

The engine shutdown protection will automatically derate and stop the engine when one or more of the conditions listed below reaches a critical point:

- High engine coolant temperature
- High engine oil temperature
- Low engine oil pressure
- High crankcase pressure (rate of change)

After the automatic engine shutdown sequence, the engine may be restarted. To do so, turn the

ignition switch to the OFF position during 7 seconds and then turn it back to ON. However, it will only operate for 30 seconds unless the problem is resolved.

Use this function sparingly and in order to move the vehicle to a safe parking place only. Excessive use may result in severe engine damage.



WARNING

Failure to take necessary action when the STOP telltale light is on can ultimately result in automatic engine derate and shutdown.

IDLE SHUTDOWN TIMER

The idle shutdown timer (optional) is programmed to shut down the engine after a specific engine idling time. The idling time cannot be changed by the driver but can be changed with the use of a laptop computer and Premium Tech Tool. In this case, the engine idling time can be set from 30 seconds up to 1 hour.

The engine will shut down at the set time under the following conditions:

- Vehicle speed is 0
- Engine is running at normal idle speed
- Engine coolant temperature above 120°F (49°C)
- Parking brake applied
- Transmission into neutral (N)
- Wheelchair lift system not in use

NOTE

Pressing the fuel pedal will prevent engine shutdown and restart countdown.

JUMP STARTING

In order to avoid damage to solid-state electrical components, it is important that jumper (booster) cables be used correctly and only in emergencies. To jump start, use another 24 volt DC, negative grounded, power source. Use only jumper cables rated at 500 cranking amperes.



DANGER

Injury, explosion, battery acid damage or charging system overload may result if these jump starting procedures are not precisely followed.



WARNING

Wear eye protection and remove rings, metal jewelry and watches with metal bands.



DANGER

The battery could rupture or explode if jump started when the run-down battery fluid is frozen or if the battery fluid level is low. Check condition of run-down battery before attempting to jump start.



DANGER

The gases given off by batteries while jump starting are explosive. Do not smoke near batteries.



CAUTION

Do not let the two vehicles touch. Keep a walk-through distance between the two vehicles. Make sure positive (red) and negative (black) jumper cable clamps do not touch.



CAUTION

Never connect the jumper cable to the negative terminal post of the run-down battery.



CAUTION

Do not jump start if a maintenance-free battery has a yellow test indicator. Have the battery replaced.



WARNING

Before attempting to jump start, make sure the

parking brake is applied and the transmission is in neutral (N). Turn off all lights, heaters and other electrical accessories.

To jump start, proceed as follows:

1. Connect one end of the red jumper cable to the positive (+) post of the booster power source. If the good battery is in another vehicle, that vehicle's engine must be shut *OFF* before connecting;
2. Connect the other end of the same red jumper cable to the positive (+) terminal bar on the battery;
3. Connect one end of the black jumper cable to the negative (-) post on the booster power source;
4. Connect the other end of the same black jumper cable to the negative (-) terminal on the structure; If the good battery is in another vehicle, start that vehicle's engine;
5. Let the engine run for a few minutes, then start the vehicle with the run-down battery;
6. Disconnect the jumper cables in reverse order given in steps 1 through 4.

NOTE

Jumper cables must be rated at 500 cranking amperes. If jumper cable length is 20 feet (6 m) or less, use 2/0 (AWG) gauge wires. If cable length is between 20 to 30 feet (6 to 9 m), use 3/0 (AWG) gauge wires.

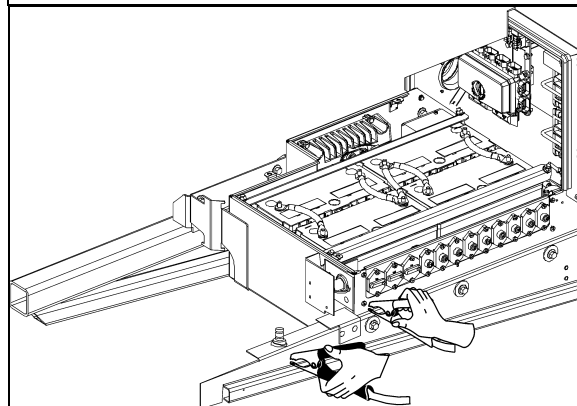

JUMP STARTING 06645

ENGINE WARM-UP

After starting the engine, keep the parking brake applied and let the engine run at slow idle for two minutes to allow lubricating oil to reach the turbocharger. Increase engine speed to fast idle, using the FAST IDLE switch located on the

6-6 Starting and Stopping Procedures

dashboard for five minutes, without loading the engine. Monitor the gauges and indicator lights to make sure all conditions are normal. If an abnormal condition is observed, stop the engine immediately and have the condition corrected.

	DANGER
Never let the engine run in an enclosed, non-ventilated area. Engine exhaust fumes contain dangerous gases which can be fatal if inhaled. Before warming up the engine, open the door(s) or move the vehicle outside.	

NOTE

The engine will reach normal operating temperature shortly after driving. Avoid driving at full throttle until engine coolant temperature reaches 140°F (60°C).

ALLISON TRANSMISSION WARM-UP

When the transmission temperature falls below -20°F (-29°C), the CHECK TRANS telltale light illuminates after the engine is started. In this case, the transmission will be locked in neutral (N) until the transmission temperature rises above -20°F (-29°C) and the CHECK TRANS telltale light goes out. The transmission will only operate in first or reverse gears until it reaches normal operating temperature.

STARTING THE VEHICLE AFTER A FIRE ALARM

The vehicle may be started after a fire alarm without resetting the system. Refer to section 7 SAFETY FEATURES AND EQUIPMENT under "Fire suppression system (AFSS)" for the complete procedure.