

Driver's Handbook

Volvo 9700 US/CAN

B13R, EPA17



W0112588

VOLVO

Foreword

The following levels of observations, cautions and warnings are used in this Service Documentation:

Danger: Indicates an unsafe practice where serious personal injury or death could occur.

Warning: Indicates an unsafe practice where personal injury or severe damage to the product could occur.

Caution: Indicates an unsafe practice where damage to the product could occur.

Note: Indicates a procedure, practice, or condition that must be followed in order to have the vehicle or component function in the manner intended.

This manual contains information concerning the operation and function of the Volvo 9700 “US/CAN” version. Equipped with 3rd generation of the multiplex electrical system **BEA-3** (Bus Electrical Architecture, version 3) and the diagnostic protocol **OBD 17** (*On Board Diagnostics, 2017*).

The information in this manual applies to vehicles complying with **EPA 17** Emissions level standard.

This manual contains general information about instruments and controls, as well as driving instructions. In case a bus is not equipped with all functions described in this manual, it is due to the custom adaptation and different levels of equipment.

Volvo Bus Corporation

Göteborg, Sweden

Order number: 89253584

©2016 Volvo Bus Corporation, Göteborg, Sweden

All rights reserved. No part of this publication may be reproduced, stored in retrieval system, or transmitted in any forms by any means, electronic, mechanical, photocopying, recording or otherwise, without the prior written permission of Volvo Bus Corporation

Foreword

For service information, please refer to our service manuals and other service literature. The section “If something happens”, page 144 provides information and instructions to be followed when something unexpected happens.

Technical data, construction information, descriptions and illustrations in this driver’s handbook, that were current when the book was published, can have been changed. The Volvo company reserve the right to make changes without prior notice.

The National Highway Traffic Safety Administration (NHTSA) and Prevost should be informed immediately if you believe that the vehicle has a defect that could cause a crash, injury or death.

Contact NHTSA by calling the Auto Safety Hotline at 1 (888) 327-4236, by writing to NHTSA, U.S. Department of Transportation, Washington, DC 20590, by TTY at 1 (800) 424-9153, or visit their website at: www.nhtsa.dot.gov.

Please keep this manual in the vehicle at all times.

Note: Illustrations in this manual are used for reference only and may be differ slightly from the actual vehicle. However, key components addressed in this document are represented as accurately as possible.

Volvo Bus Corporation

Göteborg, Sweden

Order number: 89253584

©2016 Volvo Bus Corporation, Göteborg, Sweden

All rights reserved. No part of this publication may be reproduced, stored in retrieval system, or transmitted in any forms by any means, electronic, mechanical, photocopying, recording or otherwise, without the prior written permission of Volvo Bus Corporation

Contents

Introduction	1
Driver's responsibility	1
Keys	2
Key and cylinder replacement	3
Entering the bus	4
Emergency stop.....	5
Protection against batteries discharge.....	5
Batteries cut-off switch	6
Doors and hatches	7
Doors.....	7
Opening the bus from inside.....	8
Closing the bus.....	9
Hatches and doors opened warning	10
Doors and hatches configurations	10
Doors and hatches configuration.....	11
Doors and hatches configuration (bus with WCL)	12
Roof Hatches.....	13
Driver's area	14
Driver's area	14
Driver's seat.....	15
Driver's seat features label.....	16
Horn	17
Dashboard	18
Instruments and controls	19
Faults and warnings	19
Accelerator pedal deactivated.....	20
STOP message	21
Warning message	21
Stop at the next bus stop message.....	21
Instrumentation	22
Types of instruments	22
Instrument panel lamps and symbols.....	28
Lights switch.....	30
Switches	32
Emergency stop switch	32
Kneeling system.....	33
Level control.....	34
Increasing load on the drive axle (bogie lift).....	35
Traction Control System (TCS).....	35
Differential lock	36
Hill start assistance (optional).....	36
Retarder enabled (if installed).....	37
Passenger compartment lighting.....	37

Night lighting (optional)	37
Half-light lighting	38
Driver compartment lighting.....	38
Passenger’s individual lighting.....	38
Position lights	39
Destination sign lighting (optional)	39
Electrically heated rear view mirrors	40
Driver window heating	40
Driver blower.....	40
Central locking.....	41
Sun visor	41
Toilet activation	41
Audio system	42
Opening service door from the outside.....	42
Wheel Chair Lift (WCL) system; (optional).....	43
Emergency window in use indicator lamp.....	44
Wheel Chair Lift (WCL) system indicator light.....	44
Switches into the electrical center.....	45
Controls.....	47
Ignition switch	47
Adjusting external rear view mirrors	49
Open door brake.....	50
Steering wheel adjustment.....	52
Directional indicator, dipped/full beam changer.....	53
Windscreen wipers, windscreen headlight washer	54
Transmission	55
I-Shift transmission lever selector (optional).....	55
I-Shift transmission pad selector.....	56
Allison automatic transmission (optional).....	57
Allison transmission shifter	58
Allison transmission, mode function	59
Transmission overheating	60
Retarder (if installed)	61
Retarder overheating	62
Brakes	63
Parking brake	63
Blocking valve	65
Service brakes	66
EBS (Electronically-controlled Braking System).....	68
Compensating for differences in the wear of the brake pads.....	69
High brake temperature warning	70
A/C Controller (multiplexing system)	71
Destination sign (optional).....	72
Destination sign Innova	73
Destination sign Mobitec	74

Interior equipment.....	75
Interior equipment.....	75
Toilet.....	76
Rear trash bin.....	76
Passengers thermometer and clock display.....	77
Passengers panel.....	78
Passengers AC (alternate current) 110 V power outlets.....	79
TGW (Telematics Gate Way) system and Liaison communication system.....	81
Passengers sliding seats.....	82
Control pendant (for Wheel Chair Lift equipment).....	83
Audiovisual system.....	84
Audiovisual system.....	84
Audiovisual control panel.....	85
Video system.....	85
Audio system.....	86
Guide or driver microphone (optional).....	87
Emergency and safety equipment.....	88
Overview.....	88
Fire extinguisher.....	89
Automatized Fire Extinguished System (AFES).....	90
Park pilot system.....	92
Tire Pressure Monitoring System (TPMS).....	93
Warning triangle.....	95
First aid kit.....	95
Tire inflation valve.....	96
External air supply connection.....	96
Hydraulic jack.....	97
Toolbox.....	98
Engine control panel in engine bay.....	99
Emergency exits.....	100
Doors.....	100
Roof hatches.....	101
Emergency windows.....	102
Starting and driving.....	103
Checking before driving.....	103
Bus interior and exterior cleaning and maintenance.....	104
Check the warning lights.....	105
Daily inspection.....	106
Engine oil level.....	106
Hydraulic level fluid for the engine coolant fan.....	107
Power steering hydraulic oil level.....	107
Engine coolant system fluid level.....	107
Windshield washer fluid.....	108

Fuel replenishment.....	109
Diesel Exhaust Fluid (DEF) tank.....	111
Engine block heater.....	113
Starting the engine.....	114
Starting.....	114
Indicator lights on after the engine has been started.....	116
Engine idle speed adjustment.....	117
Cruise control activation.....	119
Retarder (if installed).....	121
Power steering.....	126
Exhaust Aftertreatment System (EATS) components.....	127
Exhaust Aftertreatment System (EATS), warnings.....	128
Diesel Particulate Filter (DPF) regeneration required icon.....	129
High engine exhaust system temperature.....	130
Emission green house gas component warranty.....	131
I-Start system.....	132
I-Start system (continue).....	133
I-Start system failure detection.....	134
ARMS (Automatic Reset Main Switch).....	136
I-Start system power relays.....	137
Batteries charger.....	138
Bulk charge time estimation.....	139
Some advice for driving.....	140
Safe driving.....	140
Economy driving.....	141
Driving in cold weather.....	142
QR code labels.....	143
If something happens.....	144
Assistance and rescue on highway.....	144
Safety.....	145
If the engine is not working.....	146
Punctures.....	148
Punctured air bellows.....	148
Towing.....	149
Towing (continue).....	150
Bus towing considerations.....	151
Alternative towing procedure.....	152
Additional fire detection system (multiplexed).....	154
Releasing the parking brake.....	155
Release the parking brake with air from the bus tires.....	155
Parking brake mechanical releasing.....	156
Parking brake on disc brakes mechanical releasing.....	157
Change the batteries.....	158
Starting assistance.....	160

Jump start batteries procedure	161
Jump start batteries procedure warnings	162
Ground stud for jump start batteries	163
Batteries cut-off switch	164
I-Start system failure detection	166
Bulb replacement	167
Headlamps	167
Xenon lights	168
Rear lights	168
License plate lighting	169
Electrical fault general lookup	170
Bus electrical center	171
Chassis electric circuit relays	172
Chassis electric circuit fuses	175
Body electric circuit relays	182
Body electric circuit fuses	183
Fuse boxes inside to the batteries compartments	187
Fuses and relays electrical box inside to the right hand side batteries compartment	188
Mini fuse box holder inside to the left hand side batteries compartment	191
Wheels replacement	192
Spare wheel	193
Recommendations to avoid unnecessary tire wear	194
Recommended tire pressures	195
Check of tire wear	196
Technical data	201
General dimensions	201
9700 US/CAN (6x2 only)	201
Electrical system specifications	202
Bulbs for lighting lamps	203
Engine specifications	204
Automatic and automatized gearbox specifications	205
Transmission ratios	205
Rear axle specifications	206
Wheels and tires specifications	207
Front wheels alignment specifications	208
Diesel Emission Fluid (DEF) tank specification	209
Vehicle identification	210
Bus identification plate	211
Vehicle Identification Number (VIN)	212
Engine identification labels	213
Vehicle emission control information label	214
I-Shift transmission identification plate (if installed)	215
Allison transmission (identification plate)	216
Rear axle identification plate	217
Retarder identification plate (if installed)	218

Service intervals.....219

Index.....221

Safety information

IMPORTANT: Before driving this vehicle, be certain that you have read and that you fully understand each and every step of the driving and handling information in this manual. Be certain that you fully understand and follow all safety warnings.

IT IS IMPORTANT THAT THE FOLLOWING INFORMATION BE READ, UNDERSTOOD AND ALWAYS FOLLOWED.

The following types of advisories are used throughout this manual:



DANGER

Danger indicates an unsafe practice that could result in serious personal injury or death. A danger advisory banner is in **white** type on a **black** background with a **black** border.



WARNING

Warning indicates an unsafe practice that could result in personal injury. A warning advisory banner is in **black** type on a **gray** background with a **black** border.



CAUTION

Caution indicates an unsafe practice that could result in damage to the product. A caution advisory is in **black** type on a **white** background with a **black** border.

Note: Note indicates a procedure, practice, or condition that must be followed in order for the vehicle or component to function in the manner intended.

Driver's responsibility

- As the driver, you are responsible for the safety and comfort of the passengers during the journey. Therefore, do not drive the bus before you have read this driver's manual. You must be familiar with all the indicators and warning lights and know what to do if something unexpected happens.
- As the driver of the vehicle, you should be aware of the vehicle weight and loading capacity. See instructions on warning stickers, the vehicle registration book and on the identification plate.
- As the driver of the vehicle, it is your responsibility to foresee any hazards that could threaten your passengers.
- It is also your responsibility to ensure that all the safety equipment of the bus is in place. Therefore check regularly the working order of safety belts, emergency door and window opening, door sensitive edges, fire extinguishers and first aid equipment.
- The brakes on the bus are operated by compressed air. Never drive if the air pressure is too low or if you discover other problems with the brakes.
- Pay attention to any steering faults. The vehicle can be steered even if the power steering is not working, although the steering will be heavy.
- Never crawl under the bus if it is supported by a “hydraulic jack”. Use approved vehicle supports or a solid pallet in case of punctures or wheel changes.
- Lifting devices and supports should stand securely on a horizontal surface. The wheels that are not to be lifted should be blocked to ensure that the vehicle will not start to move.
- Re-tighten the wheel nuts after approximately **125 mi (200 km)** if the wheels have been removed.
- Tighten the wheel nuts every **6 months** regardless of whether the wheels have been removed or not.
- Follow the recommended service and maintenance program to maintain the bus's condition and safety.
- Pay attention to exhaust and fuel smells. Any leaks should be taken care of immediately at the garage.
- The bus tires and rims should be approved for the intended load and speed in accordance with current legal requirements.

2 Introduction

Keys

The following keys are delivered with the bus:

- 1 Ignition key.
- 2 Exterior and interior hatches and doors.
- 3 Right hand side rear service hatch and radiator service access hatch.

Note: There may be alternative versions of the keys, depending on the types of locks that are fitted.

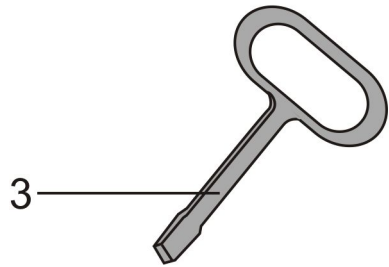
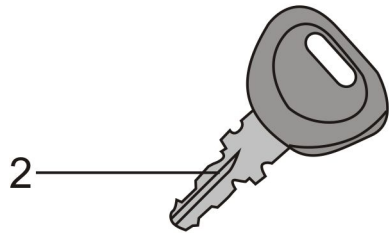
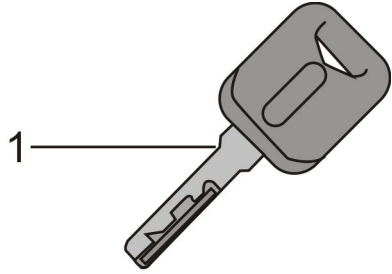

W0089523

Note: Note the number of the ignition key to facilitate ordering of spare keys.

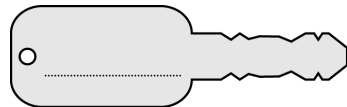

T0013333

Key and cylinder replacement

In the following table its provide the part number of cylinders and keys for replacement.

Key and Cylinder Replacement	
Location	Part Number
Exterior and interior hatches and doors.	70348099 (cylinder) 70364098 (key). ¹
Ignition key.	8159908 (1 ignition lock + switch, 2 door locks, 2 keys).
Right hand side rear service hatch and radiator service access hatch.	70348255 (cylinder) 70319047 (key).

¹ Both parts (cylinder and key) must be ordered.

4 Introduction

Entering the bus

To open the front service door proceed as follows:

- Turn the key in the lock to the horizontal position.
- Turn the knob to the vertical position.
- Push the pneumatic door opening button.

The button for the pneumatic opening of the first door is placed in the door handle.

Note: In case of total or partial emptying of the door pneumatic system, open the door by pushing the right side of the door.

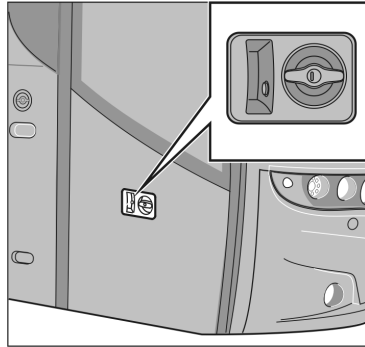

T8012405

Emergency stop

An emergency switch is located on the left side of the dashboard. Depending on the market specification, the emergency switch may disconnect the bus electrical power supply, cut **OFF** the fuel supply and activate the hazard warning lights.

Note: Only use the emergency cut out in an emergency situation.

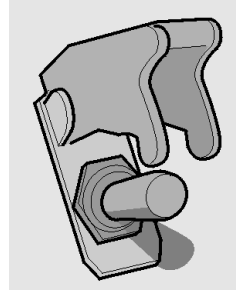

T0009170

Protection against batteries discharge

In order to prevent battery discharge while the bus is standing, the Volvo 9700 US/CAN bus is equipped with an Automatic Reset Main Switch (ARMS; see the following section in this manual: “ARMS (Automatic Reset Main Switch)”, page 136) function that disconnects the supply to major electrical consumers such as: electric heaters, some external lighting, etc.

If the ignition switch is in position **I** + a **click**, power to these consumers is switched **OFF** around **120 seconds** (for Starter batteries it is **120 seconds** after voltage is below **23.5 V** and for Consumer batteries it is **130 seconds** after voltage is below **23 V**).

Note: Turn **OFF** the ignition switch to position **0**, each time the bus is out of service.

For more information about ARMS function refer to this section in this manual “I-Start system”, page 132 and “ARMS (Automatic Reset Main Switch)”, page 136.

Also see the separate operating instructions: “I-Start”.



T0014333

6 Introduction

Batteries cut-off switch

Also called “General switch”. This switch is used to completely cut **OFF** the bus electrical power supply to avoid discharge the batteries. Use this switch if the bus its out of service for **24 hours** or more.

For more information related to this switch, see the following section in this manual:

“Batteries cut-off switch”, page 164.

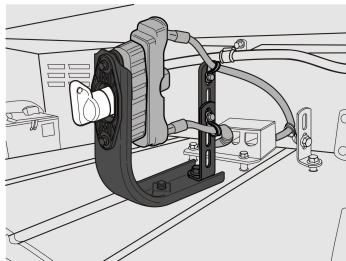

W0108406

Batteries cut-off switch knob.

Doors

The Volvo 9700 US/CAN bus is equipped with one single-leaf door opening outwards. The door is normally operated by pneumatic cylinders.

The door may be equipped with a system protecting passengers from being trapped in the doorway during opening or closing, this system has sensors measuring the air pressure in the door system.



T0012008

Note: In the case of excessive drop of the door pneumatic system air pressure, the “Door failure” warning lamp lights in the lower right corner of the bus instrument cluster.

8 Doors and hatches

Opening the bus from inside

There is a button for door opening on the right hand side of the driver's dashboard. Pushing the button causes the door to open. The button indicator lamp is lit when the door is open.

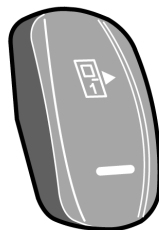

T3018176



CAUTION

Before closing the door ensure that there are no passengers standing in the doorway.

Closing the bus

To close the bus proceed as follows:

- 1 Select neutral position on the gear selector.
- 2 Engage the parking brake.
- 3 Turn on the switch that activates the door opening push-button in the door handle.
- 4 Open the door.
- 5 Turn **OFF** the power supply with the ignition key in position **0**, to refer see the following section in this manual: “Ignition switch”, page 47.
- 6 Leave the bus and close the door using the push-button in the door handle.
- 7 Lock the door with the key.

Note: After locking the door with the key, the push-button in the door handle becomes inactive.

After turning off the power supply with the ignition switch, the light above the entrance door remains on for about **90 seconds**.

If the button activating the button in the handle for opening the door **is not switched on**, in order to enter the bus again, the emergency valve must be used.

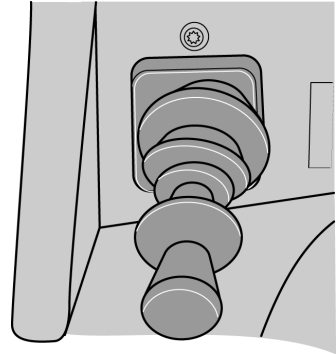

T5014881

Parking brake lever control.

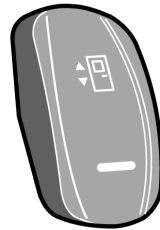

T1008555

Button for outside opening of the service door.

10 Doors and hatches

Hatches and doors opened warning

If any of the bus hatches are open or not properly closed, a “hatch open” symbol will appear on the driver’s information display.

Note: The engine cannot be started unless the engine hatch is closed.

Note: With the engine hatch open, the engine can be started by means of a button in the control box, see the following section in this manual: “Engine control panel in engine bay”, page 99



T3018116

Doors and hatches configurations

The configuration of the service doors, hatches and luggage compartment hatches depends on the bus version.

Possible configurations according to the bus version are shown in the next page. The description placed refers to items located behind the door or hatch.

Doors and hatches configuration

9700 US/CAN UWCL (without Wheel Chair Lift)

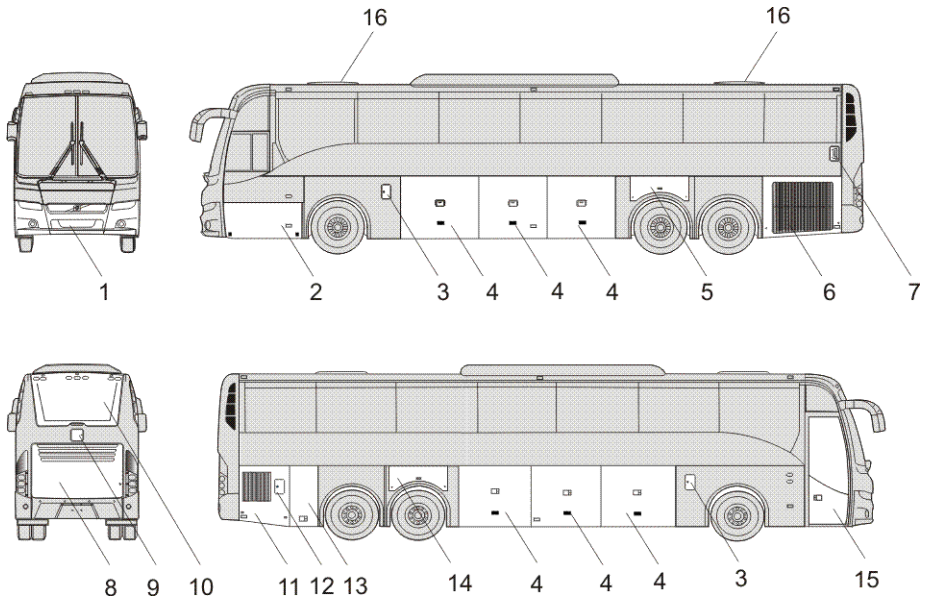

W0100254

- | | |
|---|---|
| <ul style="list-style-type: none"> 1 Compartment hatch for external air valve, front towing point and spare wheel access. 2 Compartment hatch for tool box and washer fluid reservoir access. 3 Fuel filler (<i>left and right side</i>) hatches. 4 Luggage compartment hatches (<i>left and right side</i>). 5 Compartment hatch for “I-Start” battery box (<i>consumer side</i>) and fuse box access. 6 Radiator service hatch access. 7 DEF* injector service hatch access. 8 Engine compartment hatch and rear towing point access. 9 Coolant filler hatch access. | <ul style="list-style-type: none"> 10 Aftertreatment catalyst compartment panel cover for service access. 11 Auxiliary heater service hatch access. 12 DEF* filler hatch. 13 Septic tank compartment hatch access. 14 Compartment hatch for “I-Start” battery box (<i>starter side</i>), battery cut-off switch (“<i>general switch</i>”) and fuse box access. 15 Service door (<i>passengers access</i>). 16 Roof hatches (<i>ventilation/emergency exits</i>). <p>* Diesel Emission Fluid, (urea or also AdBlue®).</p> |
|---|---|

12 Doors and hatches

Doors and hatches configuration (bus with WCL)

9700 US/CAN WCL (with Wheel Chair Lift)

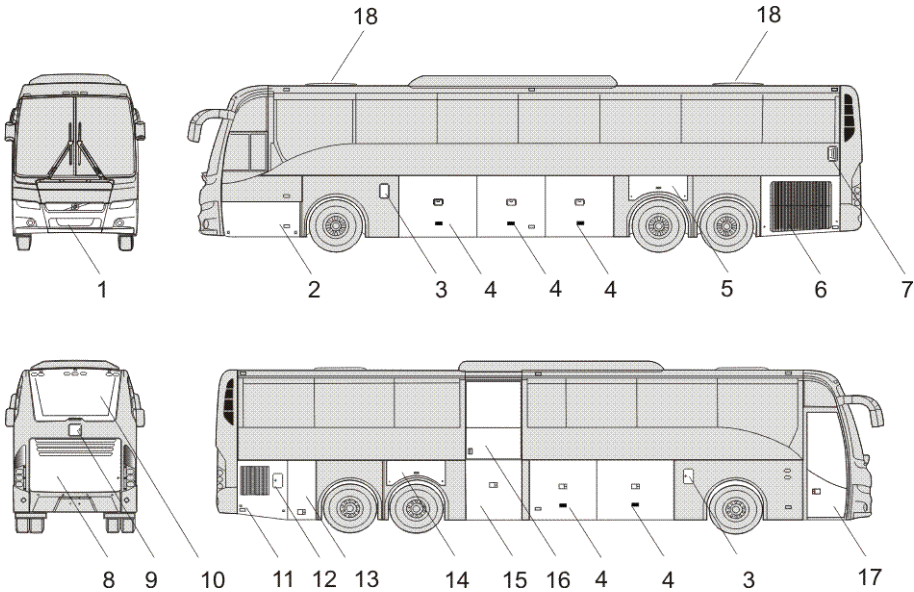

W0100253

- 1 Compartment hatch for external air valve, front towing point and spare wheel access.
- 2 Compartment hatch for tool box and washer fluid reservoir access.
- 3 Fuel filler (*left and right side*) hatches.
- 4 Luggage compartment hatches (*left and right side*).
- 5 Compartment hatch for “I-Start” battery box (*consumer side*) and fuse box access.
- 6 Radiator service hatch access.
- 7 DEF* injector service hatch access.
- 8 Engine compartment hatch and rear towing point access.
- 9 Coolant filler hatch access.
- 10 Aftertreatment catalyst compartment panel cover for service access.
- 11 Auxiliary heater service hatch access.
- 12 DEF* filler hatch.
- 13 Septic tank compartment hatch access.
- 14 Compartment hatch for “I-Start” battery box (*starter side*), battery cut-off (“*general switch*”) switch and fuse box access.
- 15 Compartment door for WCL* elevator system and WCL* control device access.
- 16 Wheel chair door access.
- 17 Service door (*passengers access*).
- 18 Roof hatches (*ventilation/emergency exits*).

* Diesel Emission Fluid, (urea or also AdBlue®).

* (WCL) Wheel Chair Lift).

Roof Hatches

The Volvo 9700 US/CAN bus is equipped with up to two roof hatches manually operated.

This hatches are manually opened by the a handles on each side of the hatch to push it upward to open and allow the ventilation. In addition, the roof hatches can be used as an emergency exits.

To know how operate the opening emergency exit mechanism, see the following section in this manual: “Roof hatches”, page 101 and for more roof hatches information, see separate operating instructions: “Manual roof hatch operation”.

Note: When the A/C is activated in the bus its hatches should be closed, since the air coming in from outside may interfere with the operation of the equipment controlling the temperature inside the bus.

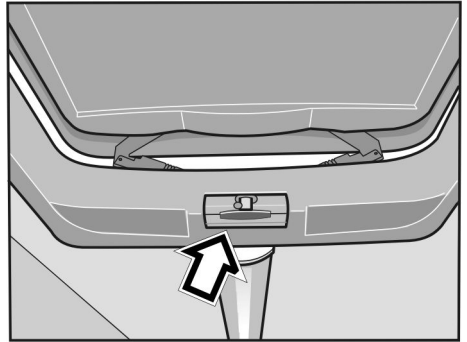

TS010110



CAUTION

Make sure that the hatches are closed when it's raining and when you leave the bus for a longer period of time.

14 Driver's area

Driver's area

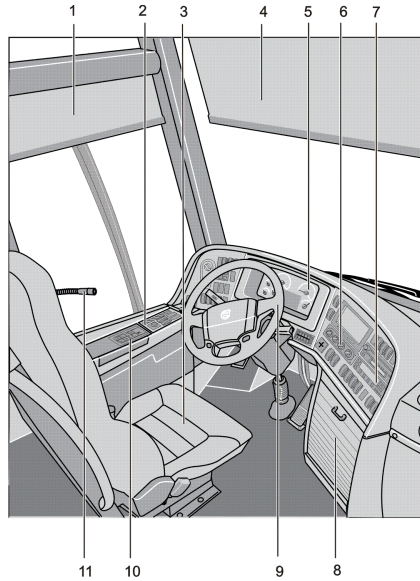

W0089969

- 1 Side sun visor.
- 2 Side panel.
- 3 Driver's seat.
- 4 Front sun visor.
- 5 Dashboard, instrument cluster.
- 6 Controller, A/C.
- 7 Controllers, audiovisual system.
- 8 Locker, audio equipment.
- 9 Steering wheel.
- 10 Gear selector pad.
- 11 Driver's microphone.

Driver's seat

The Volvo 9700 US/CAN bus is equipped with “National Seating” driver's seat type. In some 9700 US/CAN buses a microphone is installed in the driver seat head rest. See the following section on this manual: “Guide or driver microphone (optional)”, page 87, for more information.

For more driver's seat information see separate operating instructions: “Driver's seat”.



W0089527



DANGER

Adjusting seat position or fastening a seat belt should only be performed when the vehicle is stationary. Attempting this while the vehicle is moving may lead to an accident, causing serious personal injury or death.

Note: The safety belt should not be twisted or blocked when properly fastened.

Note: Before adjusting, check whether there are any objects in front of the seat or behind it, that could hinder adjustment.

16 Driver's area

Driver's seat features label

On the side panel in the driver's area an informative label (A) is placed to provide ergonomic features information to the driver; the label is placed as shown on the image (B). For more information how to use the driver's seat, see separate operating instructions: "Driver's seat".

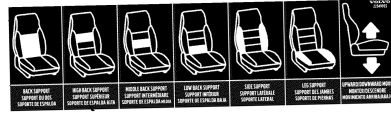

(A) Driver's seat features label.

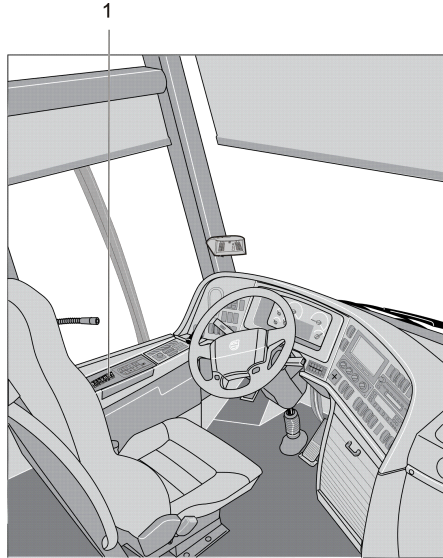

W0101026

(B) Driver's seat features label location on driver's area (1).

Horn

The Volvo 9700 US/CAN bus is equipped with one electrical horn (diaphragm) and one operated by compressed air. Pushing the central part of the steering wheel activates the electrical horn, while pushing one of the two small buttons beneath activates the air horn.

Note: Remember that the use of horns is subject to regulations.

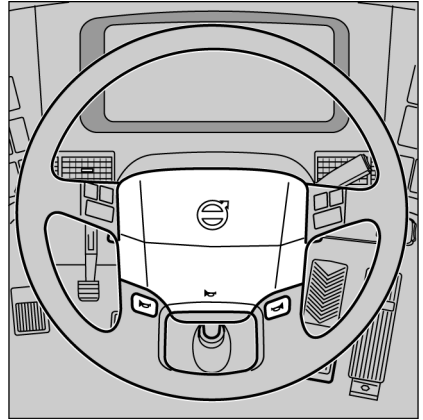

T6010187

18 Driver's area

Dashboard

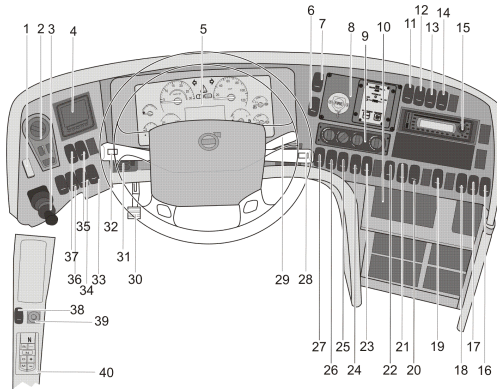

W0101128

- 1 Emergency stop switch.
- 2 Light switch.
- 3 Parking brake.
- 4 Tire monitoring system.
- 5 Instrument cluster.
- 6 Delay Automatized Fire Extinguished System (AFES).
- 7 Emergency windows open warning.
- 8 Automatized Fire Extinguished System (AFES).
- 9 A/C controller.
- 10 Spare.
- 11 Light for driver's position.
- 12 Front sun visor.
- 13 Wheel chair lift system enable and door ajar.
- 14 Wheel chair lift main switch.
- 15 Audio and video system.
- 16 Toilet activation.
- 17 Driver's fan.
- 18 Spare.
- 19 Central lock.
- 20 Driver's microphone enabled.
- 21 Position lights.
- 22 Service first door.
- 23 Door lock.
- 24 Night light under seats.
- 25 Interior lights.
- 26 Reading light.
- 27 Night light.
- 28 Display control stalk, wipers and washers control stalk.
- 29 Retarder.
- 30 Steering wheel adjustment pedal.
- 31 Air inlet.
- 32 Control stalk at the steering wheel, direction indicators and cruise control.
- 33 Traction control system.
- 34 Hill start auxiliary.
- 35 Bogie.
- 36 Bus level.
- 37 Kneeling.
- 38 Mirror heater.
- 39 Mirror adjustment.
- 40 I-Shift selector pad or Allison transmission shifter (depends bus configuration).

Faults and warnings

There are three different types of signals that give the driver all the necessary information on the vehicle:

- **STOP** message.
- **WARNING** message.
- **Stop at the next bus stop** message.

Above the display there are three lamps for (*Stop at the next bus stop*, **WARNING** and **STOP** messages), that alert the driver's attention when necessary.

Messages with appropriate symbols are shown automatically on the display.

Several messages can be active simultaneously. A new message will only replace the current message on the display if it is of higher priority. This means that the display always shows the message with the highest priority.

For more detailed information about display functions, see separate operating instructions: "Display".



T3014364

Stop message.



T3014365

Warning message.

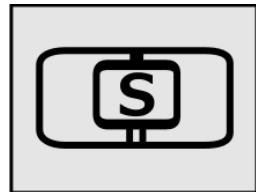

W3079585

Stop at the next bus stop message.

Accelerator pedal deactivated

The 9700 US/CAN bus is fitted with prioritized brake function.

This function deactivates a request for acceleration if **both** the accelerator pedal and the foot brake pedal or parking brake have been activated simultaneously.

If above its happens, the accelerator pedal remains deactivated until it is reset deactivating this function (prioritized brake function), for deactivate must be fully release the service foot brake pedal or in tis case release the parking brake (see also the following section in this manual: “Parking brake”, page 63).

For additional information on this function, see separate operating instructions: “EBS system”.

Note: The symbol shown in the driver display when the prioritized brake function is active, also occurs; when the bus speed exceeds the permitted limit when the bus air suspension is in the highest or lowest position (see the following section in this manual: “Level control”, page 34).

For more information, see also the separate operating instructions: “display”.



T0013511

Symbol shown in the driver display when the prioritized brake function is active.

STOP message

	WARNING
<p>If this lamp lights while driving, stop the bus immediately and turn off the engine. Continuing to drive may be severely endanger the vehicle, the driver or passengers. If appears the STOP message while the engine is running, also its heard an audible warning buzzer.</p>	



T3014364

Note: If the **STOP** message appears while the engine is running, it is accompanied by activation of the audible warning buzzer. °

Warning message

If this lamp lights, the vehicle must be taken to a workshop for repair as soon as possible. There is no immediate danger of the vehicle breaking down, and under normal circumstances it should be possible to complete the journey. This lamp is also used to draw the driver's attention to problems other than vehicle failures, e.g. as a warning in the case of an open luggage compartment hatch. °



T3014365

Stop at the next bus stop message

Simultaneously with this lamp lighting up, a new message is shown on the display. The fact that this lamp lights up does not mean that there is something wrong with the vehicle. This lamp may for example illuminate to draw the driver's attention to low fuel level.

Acknowledge the message with **ESC** key. If the information message is still activate, it will be shown again next time the starter key is turned to the starting position. °

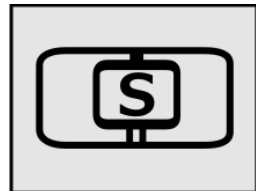

W3079585

° For more detailed information about display functions, see separate operating instructions: "Display".

22 Instruments and controls

Instrumentation

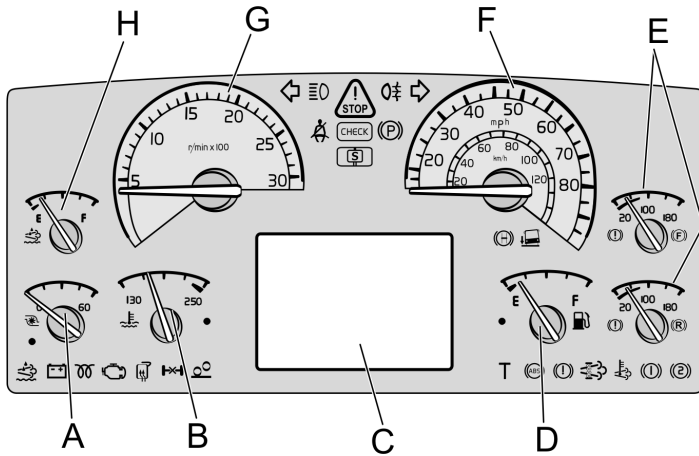

W3081293

Types of instruments

- A Turbo pressure gauge.
- B Coolant temperature gauge.
- C For the display, see separate operating instructions: "Display".
- D Fuel gauge.
- E Air pressure gauge for circuit brakes.
- F Speedometer.
- G Tachometer.
- H Diesel exhaust fluid gauge.

Turbo pressure gauge (A)

The turbo pressure gauge indicates the pressure in the intake manifold. A high turbo pressure increases fuel consumption. This gauge helps you drive in the most economical manner. When driving on level roads at constant speed, the pointer should remain still within the green zone.

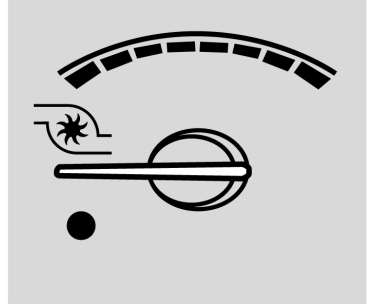

T0082692

Engine coolant temperature gauge (B)

This gauge indicates the temperature in the engine's coolant system. Under normal driving conditions, the pointer should stay just below the red zone (normal operating temperature is between **80°C (176°F)** and **100°C (212°F)**).

The engine is fitted with overheating protection, that reduces the engine power output to **50%** if the temperature reaches the red zone. The bus can still be driven even after activation of the overheating protection.

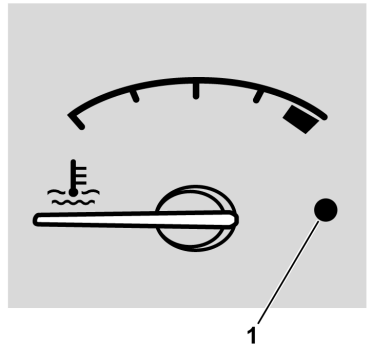

T0082691

 CAUTION
<p>The bus must not be driven if the temperature rises even higher as this can result in damage to the engine.</p>

1 Warning lamp, red.

An indicator signals when the cooling system temperature is too high.

- Warning lamp light (1).
- **STOP** lamp light.
- The acoustic signal sound (if the engine is running).

24 Instruments and controls

Driver display (C)

The driver display consists of the main menu and several submenus with their relevant functions.

For additional information, see separate operating instructions: “Display”.

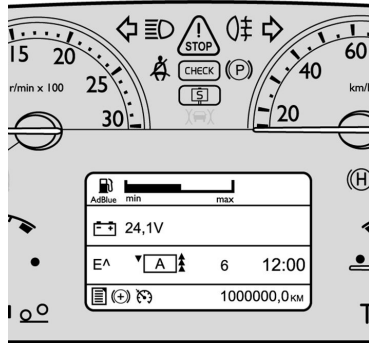

T0098814

Fuel gauge (D)

The fuel gauge shows the amount of fuel in the tank. The red zone and the warning lamp (1) give a warning of low fuel level.

The display gives considerable information on the fuel situation, i.e. fuel consumption, **A** to **B** information and remaining fuel.

For more information, see separate operating instructions: “Display”.

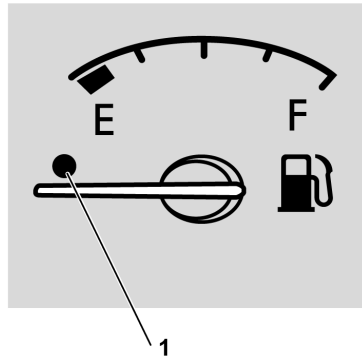

T0082696

Pneumatic system pressure gauge (E)



DANGER

Stop the bus immediately if any of the warning lamps illuminate! A warning lamp will illuminate if there is an excessive pressure drop in the braking system. Investigate the cause of the fall in pressure. Failure to do so may result in failure of the vehicles brakes that may cause an accident, leading to serious personal injury or death.

If the engine remains switched off for a long time, the compressed air pressure may fall to a level which will prevent the bus being started immediately. The warning lamp remains lit until the pressure in the pneumatic system rises to a sufficiently high level. If the compressed air in the braking system has been completely exhausted, it may take quite a long time before the pressure starts to rise. During driving, the gauge pointer should remain within the green zone, but it can temporarily drop below that zone during braking.

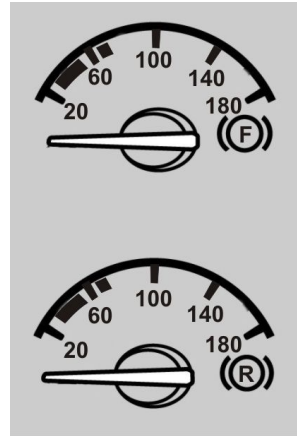

T0015292

F — Air pressure for front brake circuit.

R — Air pressure for rear brake circuit.

26 Instruments and controls

Speedometer (F)

The speedometer indicates the speed of the bus in mph. For some markets, speedometers are also available that indicate speed both in mph and km/h.

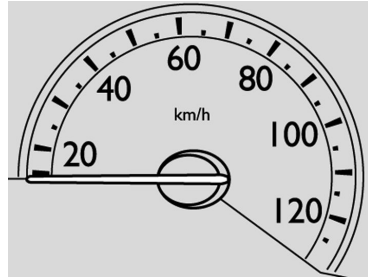

T0082695

Tachometer (G)

The tachometer scale is divided into three zones. During normal driving you should stay within the green zone, which gives the best fuel economy.

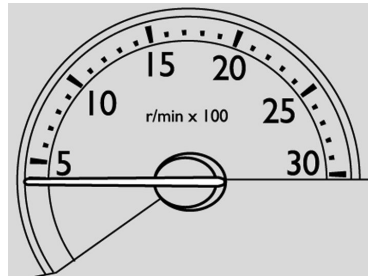

T0082694



CAUTION

Avoid operating the vehicle with the tachometer in the red zone. Such high engine speeds can result in damage to the engine and the transmission.

Diesel exhaust fluid gauge (H)

The Diesel Exhaust Fluid (DEF) gauge shows the amount of **DEF** in the tank. The red zone and warning lamp (1) give a warning of low **DEF** level.

The following will be indicate if the **DEF** level drops too low:

- If level is equal or less than about **12%** tank volume the dash lamp will light constantly, it warns drivers to fill the tank.
- If the warning was ignored and the gauge reads empty, the dash lamp starts flashing and the engine will experience a **25%** torque reduction.
- If driver continues to ignore warnings and the bus becomes stationary, the bus speed will be limited to **5 mph**.

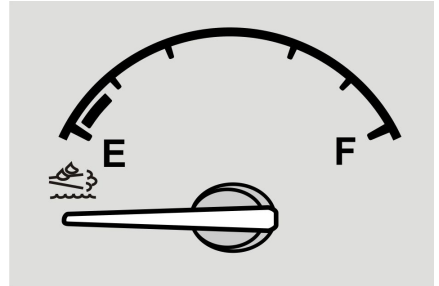

T0061352

DEF fluid gauge in the instrument cluster.

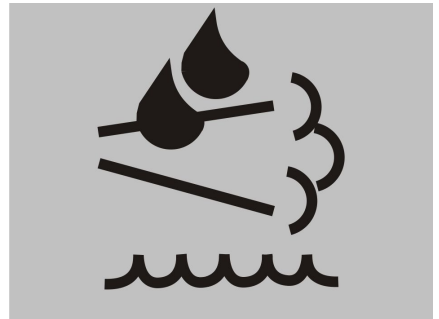

T8061207







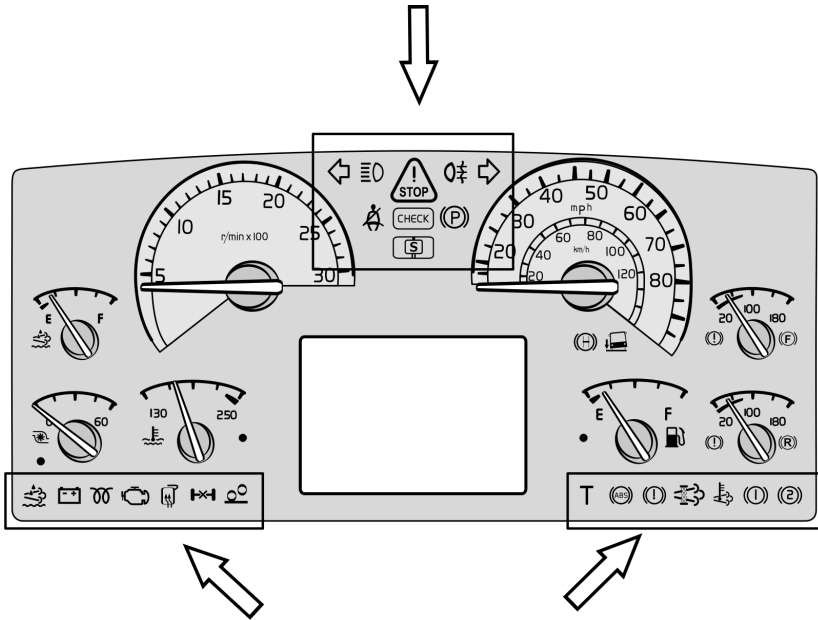



Low DEF fluid symbol indicator in the instrument panel lamps.

28 Instruments and controls















Instrument panel lamps and symbols



W3081294

Symbol	Meaning	Symbol	Meaning
	Left indicator ON.		Main beam.
	If there is a problem with the bus you must stop.		Fog Light Rear.
	Right indicator ON.		Safety belt reminder.
	Check.		Parking brake applied.
	Stop at the next bus stop.		Kneeling activated (for easier access).

Instrument panel lamps and symbols (continue)

Symbol	Meaning	Symbol	Meaning
	Door brake activated.		Battery not charging.
	DEF low level.		Engine, Malfunction Indicator Light (MIL).
	Pre-heating ON.		Differential lock activated.
	Screen / mirrors heating activated.		ABS not functioning.
	The switch for increasing load on the drive axle (bogie lift) of the bogie is on.		DPF regeneration required.
	Tachograph event.		Brake air pressure circuit 1 low.
	Brake air pressure low.		Brake air pressure circuit 2 low.
	High exhaust system temperature (HEST).		

30 Instruments and controls

Lights switch

- a Lights OFF or automatic activation of Dipped Beam
 - b Parking Lights
 - c Dipped Beam
 - d Auxiliary Spotlights
- 1 Lighting Switch
Pressing the switch turns the front fog lights on and off. Pulling it turns the rear fog lights **ON** and **OFF**.
- 2 Indication (Repeater) Lamp, Front Fog Light.
- 3 Indicator Light, Fog Light, Rear.
- 4 Instrument Lighting Rheostat.
- 5 Hazard Warning Lights.

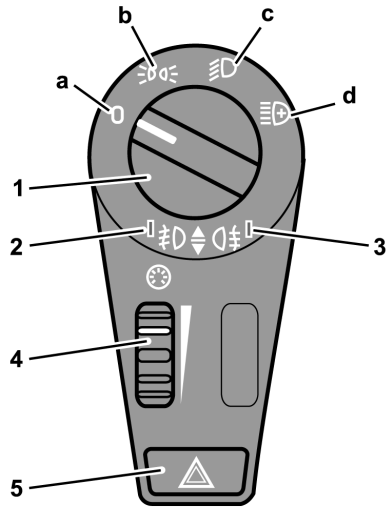

T0012036

Hazard warning lights

Pressing this button in will turn on all the bus hazard warning lights (both sets of direction indicators). The hazard warning lights will work even if both the ignition and power supply are turned **OFF** (with the main power switch through by the ignition key in position **I**).

⚠ DANGER

Use the hazard warning lights if the bus is stopped in a manner that may put other road users at risk. Failure to do so may lead to an accident, resulting in serious personal injury or death.

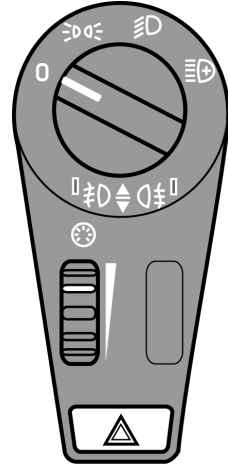

T0014325

Two rear upper lights (**A**; at each side of the bus) works as direction indicators and hazard warning lights

When exterior lights switch is at **ON** position, five upper rear lamps (**B**) turns on.

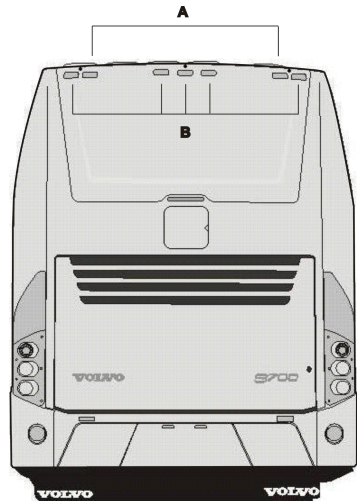

W0089559

32 Instruments and controls

Switches

The number of switches depends on the bus specification.

Emergency stop switch

Note: Only use the emergency stop switch only in an emergency situation as: A fire, collision or accident; **to switch off the bus electrical feed in normal conditions place the ignition key in 0 position** (see the following section in this manual: “Ignition switch”, page 47).

When the emergency stop is activated the following occurs (can vary from country to country):

- Air is exhausted from the door system.
- Engine is stopped.
- Power supply to the main electrical consumers is cut **OFF**.
- Fuel supply to the engine is cut **OFF** and so is outflow of fuel from the tanks.
- Hazard lights are switched **ON**.
- Lights above the doors are switched **ON**.

Activate the emergency cut out by lifting the cover (in red color) upwards and pressing up the switch. When the red color cover is closed the power switch automatically is pressed down to the disconnected position.

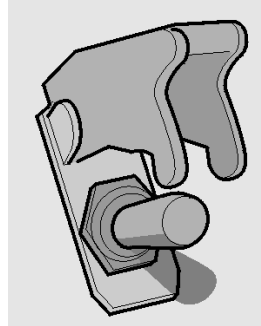

T0009170



CAUTION

If use the emergency stop switch to turn **OFF** the bus electrical power, may be have a batteries or accumulators fully electrical charge consuming risk, due when turn this switch some bus components are put into operation for the emergency mode and remaining active until emergency stop switch its turned **OFF**. To avoid this, place the ignition key in position **0** (to refer see the following section in this manual: “Ignition switch”, page 47 or use **only under a normal conditions the cut-off switch** (to refer see the following section in this manual: “Batteries cut-off switch”, page 164 to disconnect the bus electrical power.

Kneeling system

The Volvo 9700 US/CAN is equipped with a kneeling system to facilitate the entering in the bus, which is controlled by a switch located in the dashboard. This switch allows the right-hand side of the bus to be lowered (*kneeling*) to a level that facilitates passenger entry and exit.

There are two possible operating modes for the kneeling switch:

- 1 The bus lowers while the kneeling switch is depressed. After reaching the lowest level, i.e. entry/exit level, kneeling stops and the switch can be released. Releasing the switch prior to reaching the lowest level causes the bus to return to the normal ride height.
- 2 Pressing the switch once lowers the bus to its lowest level for entry/exit.

When kneeling function is active, an icon in the instrument cluster lit and a blinking lamp is activated at the door as well an acoustic signal.

Various ways to resume normal riding height:

- Pressing the upper part of the switch.
- Closing the door.
- Starting the bus and accelerating beyond **3 mph (5 km/h)** road speed (only buses without door brake function).
- Restarting the engine.

Conditions for kneeling:

- Engine idle running (vehicle stopped).
- Bus without courtesy step.

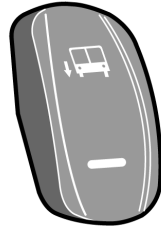

T0012054

Switch in the dashboard.

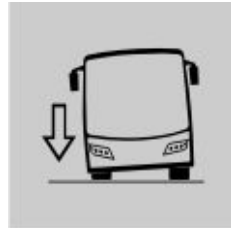

W0081879

Icon lit in the dashboard.



WARNING

Ensure that the bus can kneel without the risk of trapping passengers' feet between the door sill and the curb. Failure to do so may result in serious personal injury.

34 Instruments and controls

Level control

The ground clearance of the bus (suspension height) can be adjusted with this switch.

- To lower the bus press the lower part of the switch, e.g. while passing under a low bridge.
- To raise the bus press the upper part of the switch, e.g. while driving onto a ferry.

Note: Levelling control should only be used temporarily. During normal driving the switch **must** be in the middle position.

When the bus reaches the selected level a symbol is shown on the display panel. The suspension system attempts to keep the bus at a constant ride height independent of the load. Any faults in the system are indicated by a symbol on the display panel.

Note: If the air suspension of the bus is in the highest or lowest position and the bus speed exceeds **12 mph (20 km/h)**, a message alert is sent to the display driver, therefore, the acceleration pedal is deactivated (Showing the corresponding symbol on the driver display, see the following section on this manual: “Accelerator pedal deactivated”, page 20).

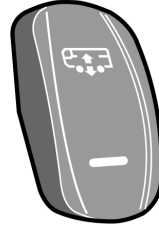

T0012058

Switch in the dashboard.



W0108964

Air suspension system is working.



T0012224

Low pressure in the air suspension system.



W0108966

Fault in the air suspension system.

Increasing load on the drive axle (bogie lift)

The drive axle load is increased by pressing this switch. Increase in drive axle load is often an advantage when moving on slippery surfaces.

Pressing this switch increases the load on the driving axle by removing the suspension load on the trailing (non-driving) axle.

The unweighting continues until one of the following takes place:

- Speed of the bus rises above **20 mph (30 km/h)**.
- The switch is pressed again.

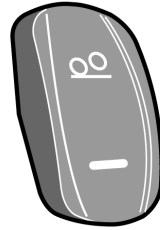

T0012046

Switch on the dashboard.

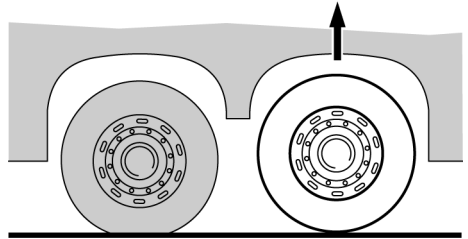

T6009559

Tag axle lift.

Traction Control System (TCS)

The TCS system automatically reduces the driving torque of the engine if the drive wheels start to spin.

At speeds below **25 mph (40 km/h)** the TCS system also acts as an automatic differential brake, braking the driving wheel that begins to spin.

For more information, see separate operating instructions: “EBS system”.

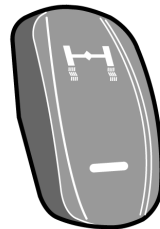

T0012059



CAUTION

Turn off the TCS before towing. Failure to do so may result in damage to the system components.

Differential lock

Differential lock allows drive axle shafts to be connected together. The wheels then rotate at the same speed, which makes driving on slippery surfaces easier.

The differential lock is only to be used on slippery surfaces. Engage as soon as the bus is on the slippery surface. It can be coupled in during driving, at any speed, but will not actually engage until the bus is travelling at less than **10 mph (15 km/h)**.

Note: Do not forget to disengage the differential lock when you have left the slippery surface! For more information, see separate driver instructions “EBS system”.

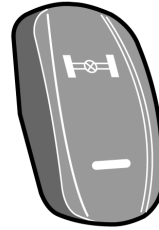

T0012041

3 stage switch for the manual/automatic coupling of the differential lock.



CAUTION

The differential lock is only to be used on slippery surfaces. Other uses may result in damage to the drive axle.

Hill start assistance (optional)

The Volvo 9700 US/CAN bus may be equipped with the hill start assistance function. This function helps the driver to pull away on inclines by holding the bus still until the required torque at the wheels is applied.

This function's mode of operation depends on whether the bus is equipped with a manual or automatic transmission.

For more information, see separate operating instructions: “EBS system”.

Note: This function not apply in buses equipped with **Allison** transmission.

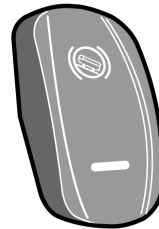

T0012045

Retarder enabled (if installed)

The Volvo 9700 US/CAN bus may be equipped with a retarder, which (if installed) is an auxiliary brake component and its operation is enabled by a switch located in the dashboard.

This switch enables the retarder control using the brake pedal or by manipulating a lever located at the right side on the steering column.

For more information about retarder, see the following section on this manual: “Retarder (if installed)”, page 121.

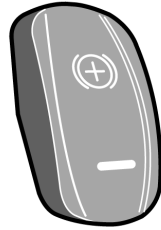

T1008547

Passenger compartment lighting

This switch turns on the passenger compartment lighting as follows:

- Press button once— after **3 seconds**, all lamps will illuminate at **50%** intensity.
- Press twice— after **3 seconds**, all the passenger compartment lights will illuminate at **100%** intensity.
- Press three or more times — switching between interval of **3 seconds** the light intensity decreases from **100% to 50%** and vice versa.
- Press and hold button for **3 seconds** — to turn off passenger compartment lighting.

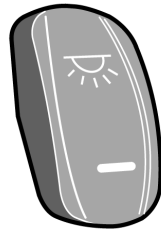

T1008556

Night lighting (optional)

The Volvo 9700 US/CAN bus may be equipped with a night light for passengers compartment activated by a switch located in the dashboard. This switch has two positions, **ON and OFF**. Activation of the night lighting turns on the lamps illuminating the gangway, which are located under the seats.

When the night lighting is **ON**, the passenger compartment lighting level is dimmed to **30%** regardless of the positions of the other switches.

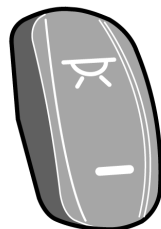

T1008549

38 Instruments and controls

Half-light lighting

This switch turn on the half—light lighting in the passengers compartment and also turn on the blue lights around at the reading lights.

This switch works as follows:

- Press once — to turn **ON** only the blue lights in the passenger compartment.
- Press twice — to turn **ON** the blue lights in the driver's compartment.
- Press three times — to turn **ON** all the blue lights.
- Press and hold for **3 seconds** — to turn **OFF** all the blue lights.

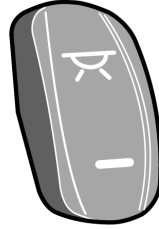

T1008549

Driver compartment lighting

This switch has three positions as follows:

- Position I — or bottom position, all lighting is **OFF**.
- Position II — or middle position, the lighting is **OFF** if the door is closed, but the lighting is on if the door is open.
- Position III — or top position, the lighting turns on without any restriction.

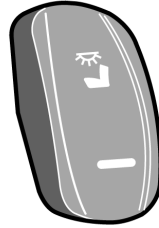

T1008557

Passenger's individual lighting

Enabling/disabling of the passenger's individual lighting. The lamps are located in the panels above the passenger seats.

See the following section on this manual: "Passengers panel", page 78.

This switch has three positions as follows:

- Position I — or bottom position all lamps are turned **ON**.
- Position II — or middle position all lamps are turned **OFF**.
- Position III — or top position every passenger can individually turn on the lighting with the push-button on the panel.

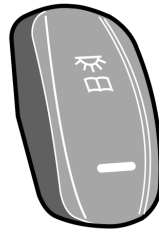

T1008548

Position lights

The position lights switch turn **ON** or **OFF** the bus position lights and operate as follows:

- If the position lights are **OFF**, press and hold the switch to turn on the position lights.
- If the positions lights are **ON**, press and hold the switch to turn **OFF** the position lights.
- Press and depress and so on for position lights blinking.

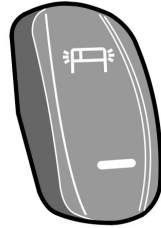

W011159

Destination sign lighting (optional)

The Volvo 9700 US/CAN bus may be equipped with a destination sign activated by a switch.

This switch has three positions as follows:

- Position I — or bottom position, destination sign lighting is **OFF**.
- Position II — or middle position, destination sign lighting turns **ON** when parking lights are on.
- Position III — or top position, lighting turns **ON** when the ignition switch is in position **II**.

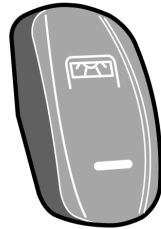

T1008545

For more information for the destination sign, see the following section on this manual: “Destination sign (optional)”, page 72.

Electrically heated rear view mirrors

The Volvo 9700 US/CAN bus is equipped with a electrically heated rear view mirrors, controlled by a switch located in the side panel.

This switch operates as follows:

- A short press of the button (less than **1 second**) turns heating for **8 minutes**.
- Press for more than one second turns **ON** the permanent heating until the button is pressed again.

Heating can be used to remove water droplets and ice from the mirror glass. **Make sure the mirrors are free of mist or ice when driving.**

Note: On some buses this switch, besides heating the rear-view mirrors, also switches on heating of the driver's window and front door window.

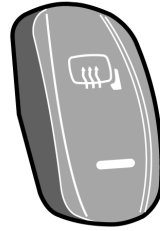

T1008551

Driver window heating

The Volvo 9700 US/CAN bus is equipped with a driver window heating controlled by a switch located in the dashboard.

This switch operates as follows:

- Pressing the button switches **ON** the heating for **8 minutes**.
- Pressing the button again switches **OFF** the heating.

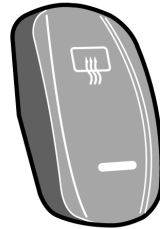

T1008580

Driver blower

This switch turns **ON** or turn **OFF** two small fans located on the top of the driver and guide seats.

This switch operate as follows:

- Push the switch to turn **ON** both fans.
- Push it again this switch to turn it **OFF** the driver blower.

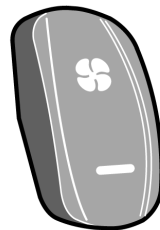

T1008550

Central locking

This switch locks or unlocks all luggage compartment hatches.

Additionally this switch turns **ON** the luggage compartment lights (*Luggage compartment lighting turns off after 10 minutes of luggage hatches stills opened*).



T1008543

Sun visor

This switch facilitates lowering and raising the front windscreen sun visor as follows:

- Lowering — Press at the bottom to low the sun visor, depress to stop the movement.
- Raising — Press at the top to raise the sun visor, depress to stop the movement.



T3018180

Toilet activation

The driver can enabled or disabled the toilet function through by a switch located in the dashboard, which; turn **ON** or turn **OFF** the power supply to the all toilet functions and disengaged the door lock.

For more information see the following section in this manual: “Toilet”, page 76 and the separate operating instructions: “Toilet”.

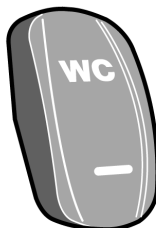

T3018183



CAUTION

Check that this switch or switches is always in the turn **OFF** position before shutting down the engine, **Do not turn ON this switch, if the engine is not running.**

42 Instruments and controls

Audio system

In the dashboard is placed a switch to enable or disable the audio system of the bus.

This switch has two positions and works as follows:

- Position I — or bottom position, enabled radio, CD or mp3 audio for passengers (microphones disabled).
- Position II — or top position, enabled microphones (for driver or guide).



W0082466

Opening service door from the outside

This switch placed in the dashboard, allows the opening or not of the service door from the exterior using the external “push-button” located in the service door handle.

The switch count with an indicator lamp to this function is enabled or disabled. The switch works as follows:

- Enabled (indicator lamp **ON**) — Doesn't allow the service door opening from the exterior through by the handle “push-button”.
- Disabled (indicator lamp **OFF**) — Allow the service door opening from the exterior without any restriction.

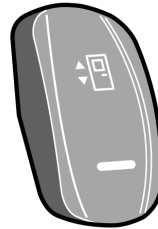

T1008555



CAUTION

Always press this switch to leave the bus.

Wheel Chair Lift (WCL) system; (optional)

The Volvo 9700 US/CAN bus may be equipped with a Wheel Chair Lift (WCL) system to be operated by its remote pendant. The system can be enable or disable with a switch located in the dashboard. This switch operate as follows:

- Position I — or switch downwards, the Wheel Chair Lift (WCL) system its deactivated.
- Position II — or switch upwards, the Wheel Chair Lift (WCL) system its activated.

Note: For more information related to Wheel Chair Lift (WCL) system operation, see separate operating instructions provided by the equipment manufacturer “RICON”.

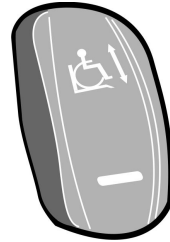

W3081609

44 Instruments and controls

Emergency window in use indicator lamp

The Volvo 9700 US/CAN bus is equipped with some side windows provided with a opening mechanism used to a emergency exit only.

This lamp lights up to indicate that one or more of the emergency windows has been opened.

For more information about for this type of the emergency windows, see the following section in this manual: “Emergency windows”, page 102.

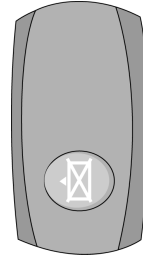

T0015524

Wheel Chair Lift (WCL) system indicator light

This indicator light provide to the driver the status operation related of the Wheel Chair Lift (WCL) system.

This indicator light works as follows:

- Upper light indicates the Wheel Chair Lift (WCL) system is enabled.
- Bottom light indicates Wheel Chair Lift (WCL) door is ajar.

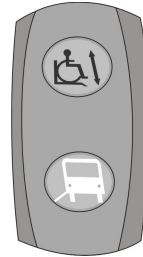

W0110531

Note: For more information related to Wheel Chair Lift (WCL) system operation, see separate operating instructions provided by the equipment manufacturer “RICON”.

Switches into the electrical center

The Volvo 9700 US/CAN bus is equipped with additional “push button type” switches into the electrical center.

This additional switches are:

Air conditioning test

Using this switch the driver can check if the air condition is working.

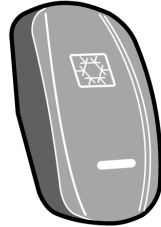

T3018175

MCM (Master Control Module) service switch

There is a switch in the electrical center compartment (with a lock symbol) that needs to be activated when the MCM is being programmed. It is only intended to be used when an update on MCM software is needed. This switch was added because during programming, MCM doesn't have control over its output signals. In this case, the body relay (**K400**) keeps opening and closing, not allowing the MCM programming process. If this switch is activated, the start is disable and an indicator is displayed in the cluster (to refer related with this symbol, see separate operating instructions: “Driver information display”).

To refer about **K400** power relay, see the following section in this manual: “I-Start system”, page 132.



T1008543

MCM (Master Control Module) service switch.

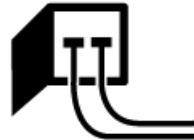

T0014716

MCM (Master Control Module) service switch activated symbol displayed in the driver's information display.

46 Instruments and controls

Door brake switch

A two position “toggle switch” with a protective cover (in red color) is installed into the electrical center to enable or disable the door brake function.

The switch working as follows:

- With the switch in the up position, the door brake is enabled.
- With the switch in the down position, the door brake is disabled.

For more information of the door brake function, see the following section in this manual: “Open door brake”, page 50.

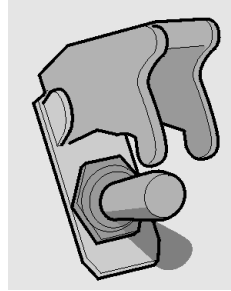

T0009170

Controls

Ignition switch

The ignition switch is located on the right side of the steering column just under the steering wheel.

Standard equipment is a normal ignition switch. A steering wheel lock is available as an option. When the key is removed it actuates a detent pin that prevents the steering shaft from turning.

Note: The vehicle is delivered with 2 identical keys. If more keys are needed, order them through your Volvo authorized dealer.

The keys are laser cut and require a special machine for copying, available through your Volvo dealer. Record the key code and keep in a secure place. A new key can be made, using a key code, if the key are lost., for more reference, see the following section on this manual: “Keys”, page 2.



T0014333

Ignition key switch:

- Main switch function replaced by the ignition key in position **I + a click**.
- ARMS (*Automatic Reset Main Switch*) function is working at ignition key position **I + a click**.

Ignition switch (continue)

The ignition switch has four positions:

0 Stop position. The electric power supply is **OFF**.

I + Electrical accessories / radio position.
a +30 power source, in this position electrical devices can be used (radio and accessories).

In “**I + a click**” position enable the ARMS (*Automatic Reset Main Switch*) function for save batteries to avoid charge drained and close the **main switch** integrated on the ignition key switch.

II Drive position. +30 power source, +DR power source (instrument cluster turns **ON**).

Between positions **II and III** there is a return spring position for preheating (for more information about pre-heating, see the following section in this manual: “I-Start system”, page 132).

Note: At this position, starter and consumer batteries are put in parallel.

III Start position. Start / cranking and spring-return to position **II**.

The main switch (*usually located in the dashboard*) was removed and a cover was placed instead, with this switch was enable +30 power source, now +30 power source enabled by the ignition key in position **I + a click** (Accessories/ Radio position), in this position to be able to use the bus accessories while engine is **OFF**, the ignition key shall be kept on this position.

Note: +30 power source (*for body loads*) can be disconnected by the MCM (*Master Control Module*) that opens **K400** power relay when a low voltage is detected, for starter batteries it is done by **ARMS** relay. To refer this function see the following section in this manual: “I-Start system”, page 132.

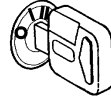

W3001302

Ignition key positions.



DANGER

The ignition switch has a restart inhibitor locking out the start position after one try, which means that the key must be turned back to **0** position before a new attempt at starting can be made.

Removing the key from the starting switch activates the steering lock.

The key can only be removed from the starting switch when it is in the stop position (**0** or **OFF** position).

Do not remove the key from the starting switch when the bus is being towed!

Always remove the key from the starting switch when leaving the bus.

Adjusting external rear view mirrors

Both rear view mirrors are adjusted using the same switch. The switch can be turned to one of the two positions (adjustment of the right or left mirror). The arrow shows which of the mirrors has been selected. The selected mirror is adjusted by moving the switch in the appropriate direction.

Note: Rear view mirrors should be adjusted before starting to drive.

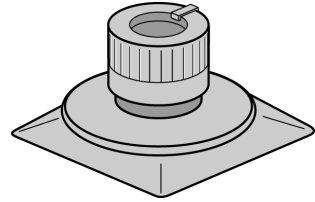

T0014718

Open door brake

The Volvo 9700 US/CAN is equipped with the open door brake function. This function works as follow:

- If the bus is stopped and the service door are open. The bus will not be able to move (because the throttle signal will be deactivated and also the gear selector in the transmission will locked, this previously only applies for buses that are equipped with **I-Shift** transmission, or any transmission multiplexed to the bus electrical system). Also too, the parking brakes will remain applied. So that should be close to the service door to be able move the bus.
- If the bus is in motion, the service doors may not be open until the bus is totally stopped.

The open door brake function goes active only when it has the following conditions:

- Must be activated the open door brake general activation button which located within to the bus electric central (see the following section in this manual: “Door brake switch”, page 46).

- The bus must be go at speeds below to **3 mph (5 km/h)**, even though the open door brake general activation button is activated and the bus speed greater than that indicated speed, the indicator light on the dashboard will not lit, indicating that the open door brake function is not active.
- The bus must be go at maximum speed of **3 mph (5 km/h)**, for the open door brake function may enter in active and ready to enter in a function once the bus is totally stopped (this is indicated when the indicator light lit in the dashboard).

Note: The open door brake does **not** engage at speeds over **3 mph (5 km/h)**.



CAUTION

The open door brake does **not** engage if the brake system registers poor traction when the bus is stopping on a slippery surface. This prevents the bus skidding when stopping on a slippery surface.

Open door brake deactivation

For open door brake deactivation do the following:

- 1 The accelerator must not be active (fully release the accelerator).
- 2 The specified door(s) must be completely closed.
- 3 The accelerator must be activated again (depress the accelerator again).

In the event that, due to the bus stopping on a slippery surface, the brake system has not activated the door brake, you must brake again (in a place where no slippery surface is detected) to enable this brake to be reactivated.

Door brake general deactivation

The electrical center is equipped also with a *toggle switch* used to general disengage the door brake function (“By-pass switch”). This switch only disabled the door brake function, independently of the other functions of the bus (see also the following section in this manual: “Door brake switch”, page 46).

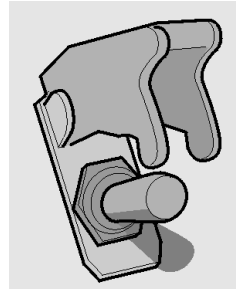

T0009170



WARNING

The switch for disengaging the door brake function must only be used in emergency, if the bus cannot be moved in the usual way. The door brake function normally must be **always** turn **ON**. The bus can not be able to move until the service door be closed.

52 Instruments and controls

Steering wheel adjustment

Both the steering wheel height and its tilt allow of continuous adjustment.

Adjust the steering wheel as follows:

- Depress the pedal to which the arrow points.
- Setting the steering wheel.
- After releasing the pedal the steering wheel is locked in its new position.

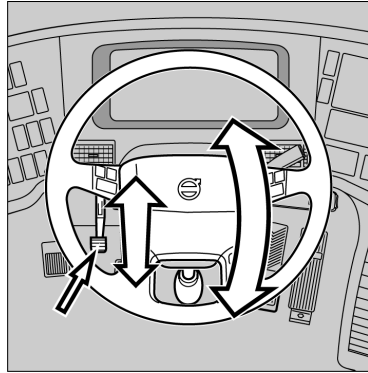

T6010216

DANGER

Steering wheel adjustments should only be performed while the bus is stationary. Adjustments with the vehicle is moving may lead to an accident, resulting in serious personal injury or death.

Directional indicator, dipped/full beam changer

1 Location of point of resistance.

When making maneuvers requiring only slight movements of the steering wheel (changing lanes, overtaking), move the stalk up or down and hold it there. After releasing the stalk, it will immediately return to its neutral position.

2 Move the stalk beyond the resistance point. .

The directional indicators will continue to flash until the stalk is manually moved back to the neutral position, or the steering wheel is returned to the straight ahead position after the turn.

3 Main beam “flash”.

Pull the stalk towards the steering wheel (until you feel slight resistance).

The main beam will stay lit until the stalk is released.

Main/dipped beam switching (lights on).

Pull the stalk towards the steering wheel beyond the “flashing point” and release it. Each time you do this, the headlamps will toggle between main and dipped beam.

In addition, engine idling speed can be controlled with this stalk. See: “Idle speed adjustment”, page 117.

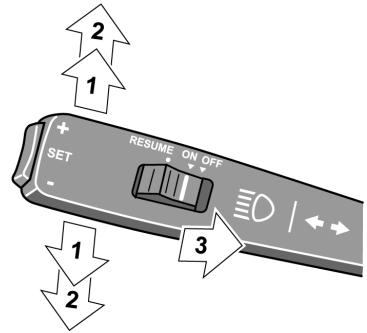

T0012077

Control lever for beam lights change and directional lights.

Windscreen wipers, windscreen headlight washer

Note: This stalk also provides control of the display, for additional information about display control, see separate operating instructions: “Display”.

1 Interval wiping

Used when driving in mist or drizzle conditions.

The wipers make one sweep every **10 seconds**. To reduce the time between sweeps, move the stalk to the normal sweeps, and then, after the desired time interval, back to the interval wiping position. This permits the wiping interval to be set to any value between **1 and 10 seconds**.

2 Flick wipe position.

If you want the wiper to make only one or two strokes (e.g. drizzle), move the lever to the flick wipe position and keep it there with your finger. The wipers will stop in parking position after releasing the lever.

3 Windscreen wipers, normal speed.

4 Windscreen wipers, high speed.

5 Windscreen washers + headlight washers.

Moving the stalk to this position will also activate the windscreen wipers, which will make an additional **2-3 sweeps** after the stalk has been released.

The headlight washers and windscreen washers have a common fluid reservoir.

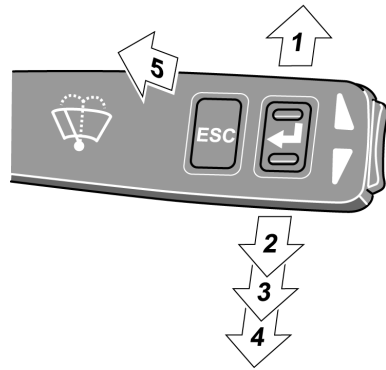

T0012079

Transmission

I-Shift transmission lever selector (optional)

The Volvo 9700 US/CAN bus may be fitted with an **I-Shift** transmission lever selector for gear shifts management in this automatized transmission, generally located at the right bottom side from the driver seat.

In this transmission, both clutch operation and gear shifts are performed fully automatized.

If necessary, the gears can be changed manually by placing the lever in the **M** position and pressing the “+” and “-” buttons located at the side in the lever selector.

The level selector has at its grip upper the “FOLD” button. When pressing and hold this button you can tilting the lever downwards to the position where the lever is on a level with the seat, this is; for provide more space in the driving position.

For more information, see separate operating instructions: “I-Shift”.

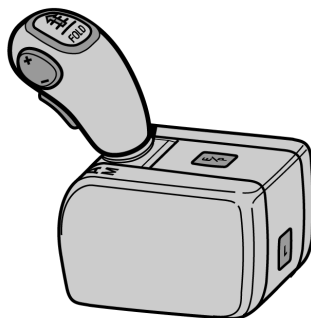

T4021276

I-Shift transmission pad selector

The Volvo 9700 US/CAN bus is fitted with an **I-Shift** transmission pad selector located in the side panel for gear shifts management in this automatized transmission.

In this transmission, both clutch operation and gear shifts are performed fully automatized.

If necessary, the gears can be changed manually through by the “+” and “-” buttons.

The push-button shift selector has six buttons: R, N, D, M and “+” and “-”. Described below:

- R — Reverse: Vehicle must be stopped when selecting this gear.
- N — Neutral: No gear engaged.
- D — Drive: Automatic drive mode. The transmission will select most suitable gear for running conditions such as load, speed, accelerator pedal position, hill climbing, etc.
- M — Manual mode: The driver can be changing up and down gears totally manual, according of his driving style through by use the “+” and “-” buttons, on the pad selector.

For more information, see separate operating instructions: “I-Shift pad gear selector”.

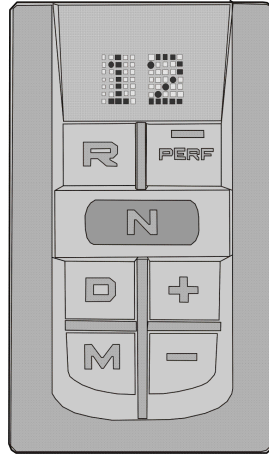

W0089562

Allison automatic transmission (optional)

The Volvo 9700 US/CAN bus can optionally be equipped with an automatic transmission: *Allison 4000 Series model 6B500*, which is an automatic transmission with 6 forward speeds and reverse.

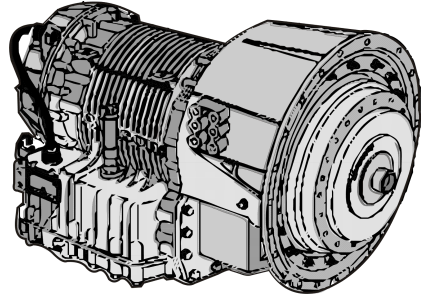

W0095730

Allison transmission shifter

The Volvo 9700 US/CAN bus may be fitted with an Allison transmission shifter, if the Allison automatic transmission is installed in the bus.

The Allison transmission shifter has a six “push-buttons” as: R, N, D, Mode and “+” and “-”. Which described below:

- R — Reverse: Vehicle must be stationary when selecting **R**.
- N — Neutral: No speed coupled.
- D — Drive: Press this button to select Drive function, the highest forward range available will appear in the digital display window under **SELECT**. The transmission will start out in the lowest available forward range, displayed under **MONITOR**, and advance automatically to the highest range.
- Mode — The **MODE** button can allow the driver to enable a secondary shift mode that has been programmed into the **TCM** (Transmission Control Module) unit. Pressing the **MODE** button activates the **PERFORMANCE** shift schedule and illuminates the mode indicator (*LED*).
- + or — buttons: Press respectively the (“Upshift”) or (“Downshift”) arrow button when in **DRIVE** to request the next higher or lower range. One press changes speeds by one range. If the button is held down, the selection will scroll up or down until the button is released or until the highest or lowest possible range is selected. Protection mechanisms inhibit selecting ranges that are not appropriate for the current speed or which may damage driveline components.

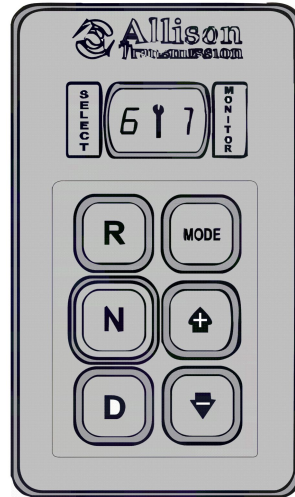

W0095731

Allison transmission, mode function

The **MODE** button have the following function. Both **ECONOMY** (default mode at starting of the engine) and **PERFORMANCE** (secondary shift mode) modes are equivalent from the first to the fourth gear as the transmission upshifts at around **2000 rpm**.

The **ECONOMY** mode allows for upshifts in fifth and sixth gear at around **1700 rpm**. This is a more efficient operation of the transmission and thereby helps improve fuel economy.

The **PERFORMANCE** mode keeps upshifts at **2000 rpm** in fifth and sixth gears. This makes for better performance than the economy mode but with higher fuel consumption. It is recommended this mode be selected while driving up or down grades. The mode indicator (*LED*) is illuminating when **PERFORMANCE** mode is selected. When a button is depressed on the transmission control pad, the corresponding letter or number is displayed indicating the transmission is ready to operate in the selected range. If the transmission control module (**TCM**) detects a serious problem in the transmission, the “CHECK” telltale light will illuminate on the dashboard. For more information see separate operating instructions: “Allison Bus Series Operator’s Manual ” provide by the transmission manufacturer.

Transmission overheating

If the transmission overheats, the “CHECK” lamp will light and the display will show a red symbol.

If the temperature rises further, the red “STOP” lamp will light. Slow down and stop the bus as soon as it is safe to do so.

Contact an Volvo authorized service center to request the assistance road rescue service (see the following section on this manual “Assistance and rescue on highway”, page 144).



T3014365

CHECK icon lit in the dashboard.



T3014364

STOP icon lit in the dashboard.



T0008817

Symbol shown in the driver display.

Retarder (if installed)

The Volvo 9700 US/CAN gearbox may be equipped with a “compact hydraulic” retarder type. If equipped, the retarder helps to decrease the bus speed and the load on the service brakes. Its automatically engaged by the initial movement of the brake pedal (even before that the wheel brakes are applied) or by a control lever at the right side of the steering column.

The retarder operation can be general enable or disable, through by a switch placed in the dashboard (see the following section in this manual: “Retarder enabled (if installed)”, page 37).

This switch has two positions as follows:

- Position I — Switch downwards, the retarder is disabled.
- Position II — Switch upwards, the retarder is enabled.

When the retarder its active, a symbol is shown in the display.

 **DANGER**

Avoid using the retarder on slippery roads because of the risk of locking the wheels and skidding (the retarder brakes only the driving wheels). Failure to do so may be lead to an accident, resulting in serious personal injury or death.

Note: The retarder brake the main shaft to connecting the drive axle with the transmission and in this way, obtain a delay effect on the drive wheels. If the bus is; equipped with anti-lock brake system (ABS), the retarder is automatically disengaged on any signs of the wheels locking.

Note: Under normal driving conditions, the retarder should not be disabled.

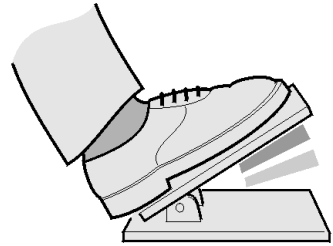

T0009004

Retarder activation area in the brake pedal (optional).



T3018117

Symbol shown in the driver display.

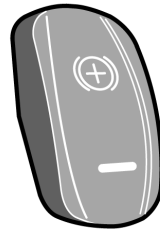

T1008547

Retarder enabled or disabled switch located in the dashboard.

Retarder overheating

Note: Only apply, if the coach equipped with the hydraulic retarder.

If the retarder remains engaged for a long time (e.g. during a long downhill stretch) it may be overheat, causing an increase in retarder oil temperature.

The first indication of retarder overheating is the “CHECK” lamp lighting and the temperature symbol showing up on the display. If this happens, select a lower gear and make greater use of the main brakes.

If the temperature continues to rise, the red “STOP” lamp will light and there will be an increase in the temperature accompanying the symbol on the display. Stop the bus as soon as possible and select neutral, i.e. N. To increase the circulation of the coolant run the engine at higher idle until the temperature returns to the normal level.



T3014365

CHECK icon lit in the dashboard.



T3008844

Symbol shown in the driver display.

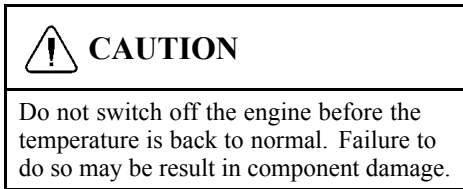

T3014364

STOP icon lit in the dashboard.

Brakes

Parking brake

The parking brake acts on the drive wheels. When the hand control is in the forward position with the compressed air system charged and the blocking valve depressed, the parking brake is released.

When the parking brake hand control is moved backwards, the parking brake is gradually applied. It is fully applied when the hand control is in its backmost, locked position.

To release the parking brake hand control from the locked position, lift the ring upwards and move the lever forwards.

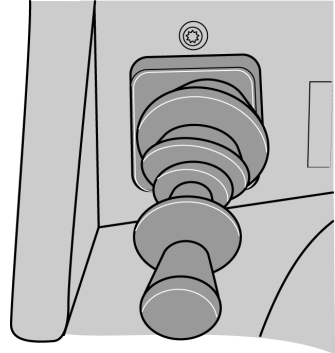

T5014881



DANGER

Pay attention to the following advises:

- Never leave the bus without engaging the parking brake.
- Never start driving while the brake system warning lamp is still lit.
- If the warning lamp lights while driving, stop the bus immediately.

Failure to do so may result in serious personal injury or death.

Emergency brake

To use the parking brake as an emergency brake, move the lever gradually backwards to the parking position. Keep the catch pulled in all the time, or the control will fasten in the locked position.

DANGER

The parking brake is only to be used for parking or as an emergency brake in case of malfunction of the service brake system. Due to the parking brake only brakes the drive wheels, there is a high risk of bus skidding, resulting in a more braking distance than to avoid wheels locking by using the service brakes. Did not take care in the proper use of emergency brake, may be induce to an accident resulting in serious injury or death.

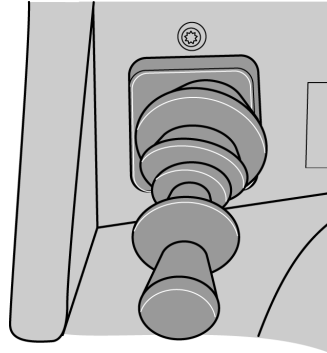

T5014881

Blocking valve

The function of this valve is activate the parking brake blocking by the pneumatic control valve supply blocking, inhibiting the parking brake valve function. Its happened, if the pneumatic circuit pressures to low in the bus, causing; that the blocking valve is automatically activated (the valve is thrown). To release the parking brake do the following:

- 1 Start the engine and charge the pneumatic system of the bus (until the air brake system warning lamp in the instrument panel is turn **OFF**).
- 2 Press the blocking valve.
- 3 Put the parking brake control lever in the brake release position (see the following section on this manual: “Parking brake”, page 63).

Note: Once the blocking valve activated, the parking brake can not release although the parking brake control lever is in its forward position (brake released). To release the parking brake, it should restore the pneumatic circuits pressure of the bus and press the blocking valve.

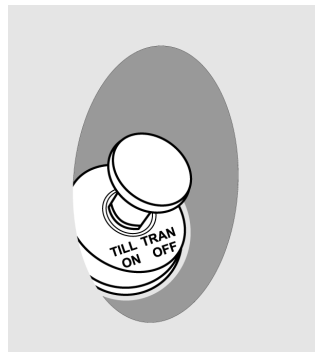

T0015484

Service brakes

The Volvo 9700 US/CAN bus is equipped with an EBS brake system (Electronically-controlled Braking System). This system monitors and controls the brake operation (also, refer to this section on this manual: “EBS (Electronically-controlled Braking System)”, page 68).

If the service brakes are used without care when driving down steep and long inclines, they will heat up very quickly to extreme temperatures. The low speed that is generally the rule in such cases means that the brakes are not cooled as efficiently as when driving on level roads. When driving downhill, in the first instance use the retarder brake, and only supplement this with the main brakes as necessary.

For additional information about the retarder, see the following section on this manual: “Retarder (if installed)”, page 121.

If you have to use the service brakes while driving downhill, **DO NOT** pump the service brake, as this will only use up compressed air, what cause trigger the blocking valve activating the parking brake unexpectedly, raising the risk of a rollover (for information about the valve block, see the next section in this manual: “Blocking valve”, page 65).

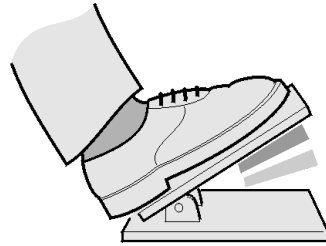

T0009004

Dark zone — only retarder.

Light zone — retarder and foot brake.



T0009682

Symbol shown in the driver display.



T3008834

Icon lit in the dashboard.

Service brakes use

When driving downhill, brake sufficiently hard and then release the brake pedal completely, or just to the pedal position where only the retarder is engaged. Heat builds up very quickly in the brakes, causing increased wear of the brake linings and reduced brake efficiency.



DANGER

Do not start driving if the pneumatic low pressure lamp is turn on in the dashboard. Fully charge the pneumatic system and wait the warning lamp turn off in the dashboard before starting the trip.

If the pneumatic low pressure lamp comes on while driving. Stop the bus immediately and parking in a safe place because the risk that the parking or emergency brake applies unexpectedly raising the risk of a rollover.

EBS (Electronically-controlled Braking System)

The main purpose of the Electronically Braking System (EBS) is to increase the effectiveness and efficiency of the service brake (by shortening braking distances) and so increase the safety while driving.

The Electronically Braking System (EBS) controlled the Antilock Brake System (ABS) and Antislip System Reduction (ASR).

The Electronically Braking System (EBS) is fitted on buses equipped with disc brakes, being the Antilock Brake System (ABS) a part of the Electronically Braking System (EBS) control and works completely automatically. The Antilock Brake System (ABS) prevents the wheels from locking up during braking. In case of Antilock Brake System (ABS) failure, the appropriate symbol appears on display in the dashboard.

Note: Antilock Brake System (ABS) efficiency is limited. Remember, that on slippery surfaces Antilock Brake System (ABS) will not shorten the braking distance significantly. It can nevertheless help in avoiding obstacles during braking.

For more information of the Electronically Braking System (EBS), see separate operating instructions: “EBS”.



T0009682

Symbol shown in the driver display.



T3008834

Icon lit in the dashboard.

Compensating for differences in the wear of the brake pads

If the brake pads on one of the axles wear down faster than those on the other, braking force is redistributed so that a greater portion of the braking force is applied to the wheels on the axle with less wear.

When the thickness of the brake pads is reduced to **20%** of the thickness of new pads, a warning symbol is shown on the display.

Note: This function activates when braking lightly. During in a hard braking the braking force is distributed so as to achieve the most efficient braking.



T5013668



DANGER

When brake pad warning symbol is displayed, immediately proceed to the nearest service station to replace the brake pads with new ones. Driving any further with worn out brake pads may lead to losing control of the vehicle and cause an accident resulting in serious personal injury or death.

70 Instruments and controls

High brake temperature warning

If the temperature of the brakes increases too much, the lamp on the dashboard “CHECK” turn on and the same time the relevant symbol is shown on the display.

Note: If the temperature is allowed to rise further, maintaining the same braking force will require increased pressure on the brake pedal.



T5013670

Symbol shown in the driver display.



T3014365

Icon lit in the dashboard.

A/C Controller (multiplexing system)

The Volvo 9700 US/CAN bus is equipped with an A/C controller “AQuattro” for controlled the multiplexed A/C system. With this control the driver maintains a constant temperature inside the bus.

For more information of the “AQuattro” A/C multiplexing system control, see separate operating instructions: “AQuattro, A/C controller”.

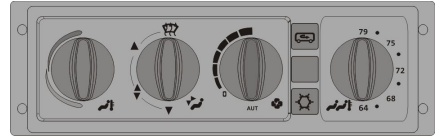

T8061140

72 Instruments and controls

Destination sign (optional)

The Volvo 9700 US/CAN bus may be fitted with a two optional high definition destination signs, “Mobitec” or “Innova” brands.

For use, follow then instructions in the next pages:

Destination sign Innova

“Innova” destination sign control pad has the following buttons, its function is described for each one:

- **Destination text:** Press the (1) button and then use the buttons (2) or (3) until the route message adjust function appears in the display with the following name “RUTA”; Then press the (4) button to enter this function. In this function, use the buttons (2) or (3) to select the wanted destination text and press the (4) button for insert your selection. Press the (1) button to return the main menu.
- **Extra text:** Press the (1) button and use the buttons (2) or (3) until the extra text function appears in the display with the following name “EXTRA”. Then press (4) button to enter the function. The "P-01" message in the display will appear, press (4) button to confirm the selection then "P-ON" message will appear in the display, use the buttons (5) and (6) to insert the wanted extra text that you want. Press (4) button and the message “01:ON” will appear. Use the buttons (5) and (6) to adjust the exposure time for the extra text. Press button (4) for apply the adjustments and return to the main menu.
- **Departure time:** Press the (1) button and use the buttons (2) or (3) until the departure hour function appears in the display by the following name “HrSd”. Then press the (4) button to select the function and use (2) and (3) buttons to adjust the time hour, press (4) button to entered the time hour, now again use the (2) and (3) buttons to adjust the time minutes, press (4) button to entered the time minutes and return to the main menu.

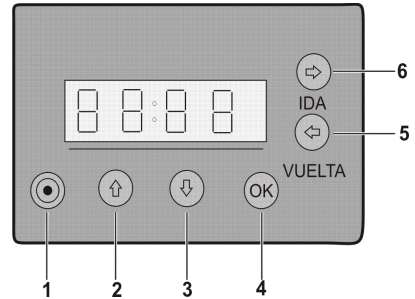

W0091881

“Innova” destination sign digital control.

For more information see the separate user manual provided by “**Innova**”.

Destination sign Mobitec

“Mobitec” destination sign control pad has the following buttons; its function is described for each one:

- Destination text selection: Press the “check mark” button, the digit value to be changed will flash. Use the “up” and “down” buttons for increase or decrease the digit value to be changed. Use the “left” and “right” buttons in order to change the button to be modified.
- Extra text selection: Press the “check mark” button for enter to the destination text selector mode. Press the “right” button for change the extra text. Use the “up” and “down” buttons to increase or decrease the value of the digit to be changed. Use the “right” or “left” buttons to change the digit to be modified.
- Departure time selection: Press the “check mark” button for enter to the destination text selector mode. Press the “right” button for change the departure time text. Use the “up” and “down” buttons to increase or decrease the value of the digit to be changed. Use the “right” or “left” buttons to change the digit to be modified.

After each configuration (departure time, destination and extra text informations), press the “check mark” button to confirm or the “cross” button to cancel.

For more information see the separate user manual provided by “**Mobitec**”.



W0097186

“Mobitec” destination sign digital control.



W0097187

Destination display selector.

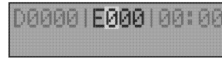

W0097188

Extra text display selector.



W0097189

Departure time display selector.

Interior equipment

To enhance travel comfort, the Volvo 9700 US/CAN bus is fitted with additional interior equipment such as:

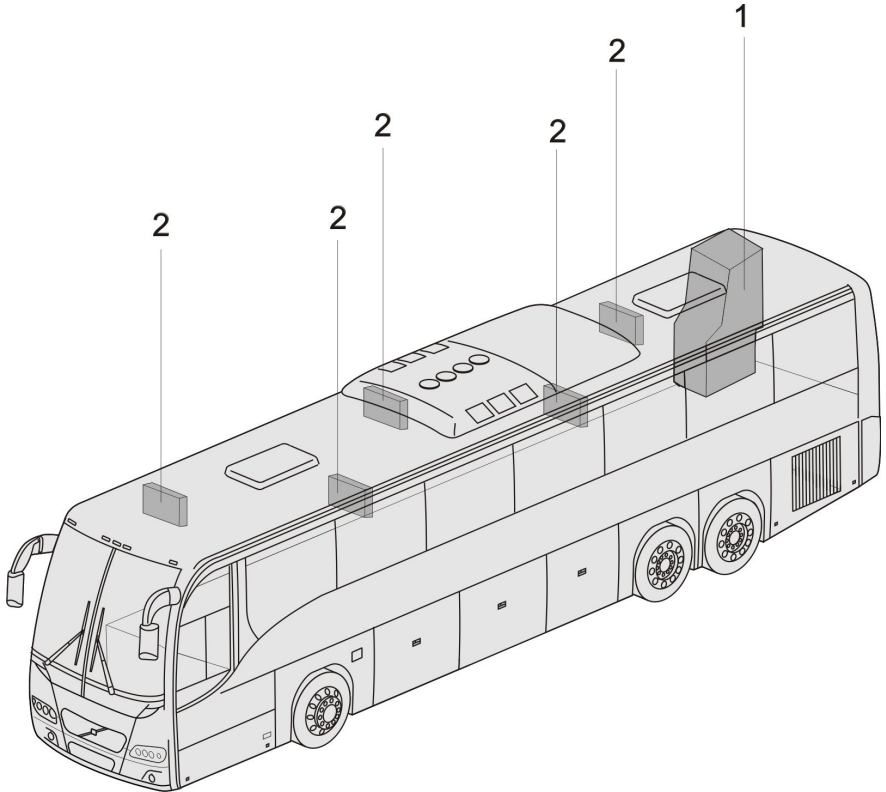

W0089616

- 1 Toilet.
- 2 Monitors.

76 Interior equipment

Toilet

The Volvo 9700 US/CAN bus is equipped with a toilet, located on the right-hand side at the rear of the vehicle. Pressing a switch on the dashboard enables the toilet to be used, by releasing its central lock and switching on the toilet power supply.

While the toilet is occupied (after locking the door) a sign lights up in the passenger compartment.

In the toilet compartment there is an emergency push-button with backlight. After it has been pressed, the toilet indicator lamp flashes on the dashboard.

For additional information and instructions regarding the servicing and maintenance of the toilet, see separate operating instructions: "Toilet".

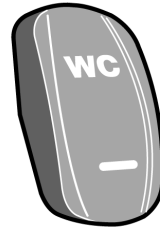

T3018183

Enabled switch located in the dashboard.

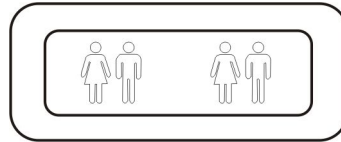

T0015272

Indicator lamp in the toilet cabinet.

Rear trash bin

The Volvo 9700 US/CAN bus is equipped with a trash bin integrated to the interior rear panel, located at the bottom of passengers compartment, beside the toilet.

For more information regarding access and maintenance of the rear trash bin, see separate operating instructions: "Toilet".

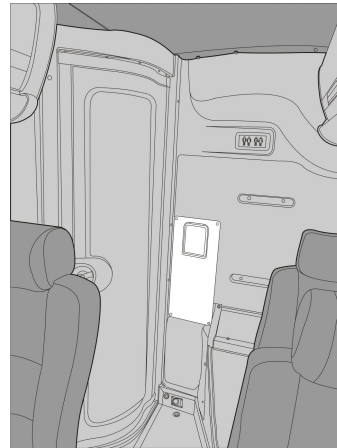

W0095904

Passengers thermometer and clock display

The Volvo 9700 US/CAN bus is equipped with a thermometer and clock display located on the front of the passengers compartment (at the cabin roof).

The display shown the following information:

- Time.
- Date.
- Toilet occupied.
- Toilet unoccupied.

For more information, see separate operating instructions: “Passenger compartment clock display”.

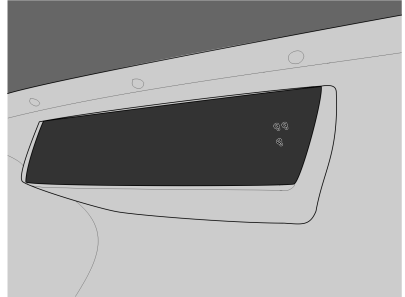

W3081817

78 Interior equipment

Passengers panel

The Volvo 9700 US/CAN bus is feature with a passenger panels above in each pair of passenger seats.

On each panel there are the following elements:

- 1 Left seat reading light **ON/ OFF** switch.
- 2 Right seat reading light **ON/ OFF** switch.
- 3 Loudspeaker **ON/OFF** switch.
- 4 Not in use.
- 5 Reading lights (one for each passenger seat).
- 6 Ventilation and A/C outlet grills (one for each passenger seat).

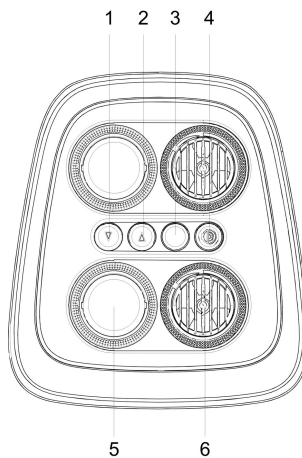

W3081339

LED lighting stripe

The Volvo 9700 US/CAN bus is equipped with a LED lighting stripe (1) mounted on each passengers panel. The lighting stripe illuminate at **100%** when the ignition key is turned **ON** in its position **I** and when the parking brake is released and start the driving, the lighting stripes dim automatically at **50%**.

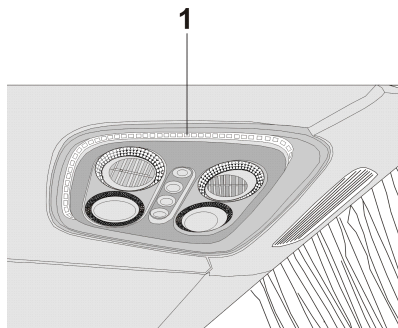

W0089617

Passengers AC (alternate current) 110 V power outlets

The Volvo 9700 US/CAN bus is equipped with passengers AC (alternate current) **110 V** power outlets. For each pair of passengers seats there is a electrical contact located at the center of the front lower frame from each pair of passenger seats to connect electrical devices as:

- Cell phone charger.
- Lap Tops.
- mp3 players.

For more information about use and care of the bus power outlets, see separate operating instructions: “110 V CA passengers power outlets ”.

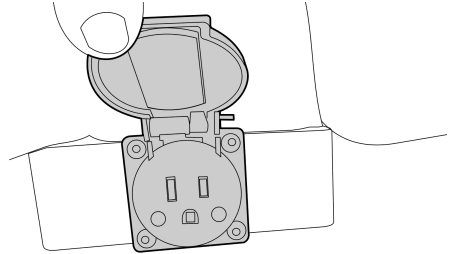

W0096345

Power outlet in the bottom of each pair of passenger seats.



WARNING

Under no circumstances should introduce any objects into the electrical outlets slots. Failure to following this warning result in to a high risk of serious personal injury and possible irreversible damage of the bus electrical system.

80 Interior equipment

Passenger AC 110 V power outlets circuit breaker

In case of an electrical overload, the power outlets circuit is equipped with a thermally protected circuit breaker, which disables the electrical power outlet system. The driver can reset the system by pressing the blue button (1) integrated into the protection device located in the lower center console of the dashboard.

For more information about use of the thermal circuit breaker to the bus power outlets circuit, see separate operating instructions: “110 V AC passengers power outlets”.

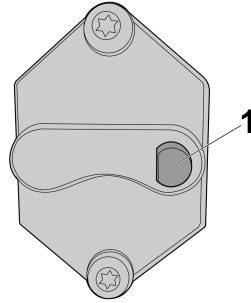

W3081815

Circuit breaker button on thermal protector device.



CAUTION

Should not be allowed to the passengers connect high power consumption electrical devices such as: Hair dryers, curling iron or similar electrical devices, if this equipment is connected to the power outlets, cause a irreversible damage to the bus electrical system.

TGW (Telematics Gate Way) system and Liaison communication system

The Volvo 9700 US/CAN bus is equipped with a TGW system using the new 3G protocol communication.

For USA and Canada markets the coach using the Liaison communication software, which use the TGW-3G system architecture components.

The TGW-3G is a electronic control module used for data logging and communication between the vehicle and fleet manager computer.

The main functions for TGW are as follows:

- Functions as a gateway for remote services. GSM (Global System for Mobile Communications) / GPRS (General Packet Radio Services) / 3G and WLAN.
- Gather and transmit vehicle and driver data that has been logged in other vehicle units.
- Geographic positioning of the vehicle (GPS).
- Functions as a computer interface for third party file transfers.
- Functions as a gateway for AIC to the vehicle network.

TGW also has a SIM (Subscriber Identity Module) reader and a USB interface. TGW is connected to:

- The vehicle's electrical and electronic systems.
- AIC

Note: For more information to the Liaison communication system, see separate operating instructions: "Liaison 2.0 Communication system".

82 Interior equipment

Passengers sliding seats

Note: Apply only for a Wheel Chair Lift (WCL) 9700 US/CAN bus version.



CAUTION

The edges of the pedestal need to be aligned with the arrows on the lateral plate, to properly secure the seat retainers pressing pedestal pedals. Do not try to press down the pedestal pedals if the pedestal is not aligned with the arrows, because the seat retainers does not applies properly.

Only 9700 US/CAN buses equipped with WCL (Wheel Chair Lift) have four pairs of folding and sliding passenger's seats and two pairs of folding passenger's seats, which use when required accommodate a person in a wheelchair.

For more information to operate the folding and sliding passenger's seats, see separate operating instructions: "Wheel Chair Lift equipment".

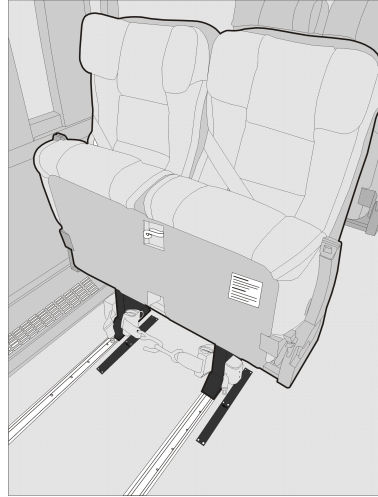

W0089974

Control pendant (for Wheel Chair Lift equipment)

The wheel chair lift is operated with a hand-held, hard-wired remote-control pendant. This control pendant is located on the left side from the Wheel Chair Lift (WCL) compartment.

The control pendant for Wheel Chair Lift (WCL) have the following control buttons:

- Power switch — Turn ON the Wheel Chair Lift equipment.
- Deploy — Extends the platform from the storage compartment.
- Stow — Retracts the platform back into the storage compartment.
- Down — Lowers the platform towards the ground.
- Up — Raises the platform towards the vehicle floor.

For more information about the Wheel Chair Lift (WCL) equipment operation, see separate operating instructions: “Wheel Chair Lift equipment”.

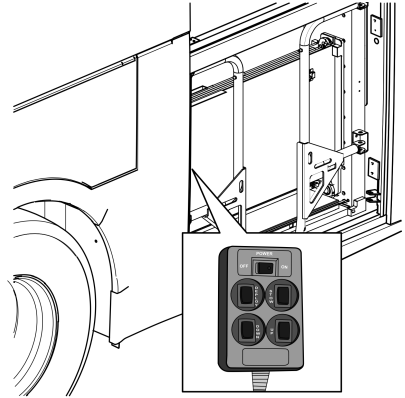

W9089525

Locate of control pendant into the Wheel Chair Lift (WCL) bus compartment.



W0095900

Control pendant.

Audiovisual system

To enhance the comfort of the passengers during journeys, the Volvo 9700 US/CAN bus is equipped with an audiovisual system, whose main components are:

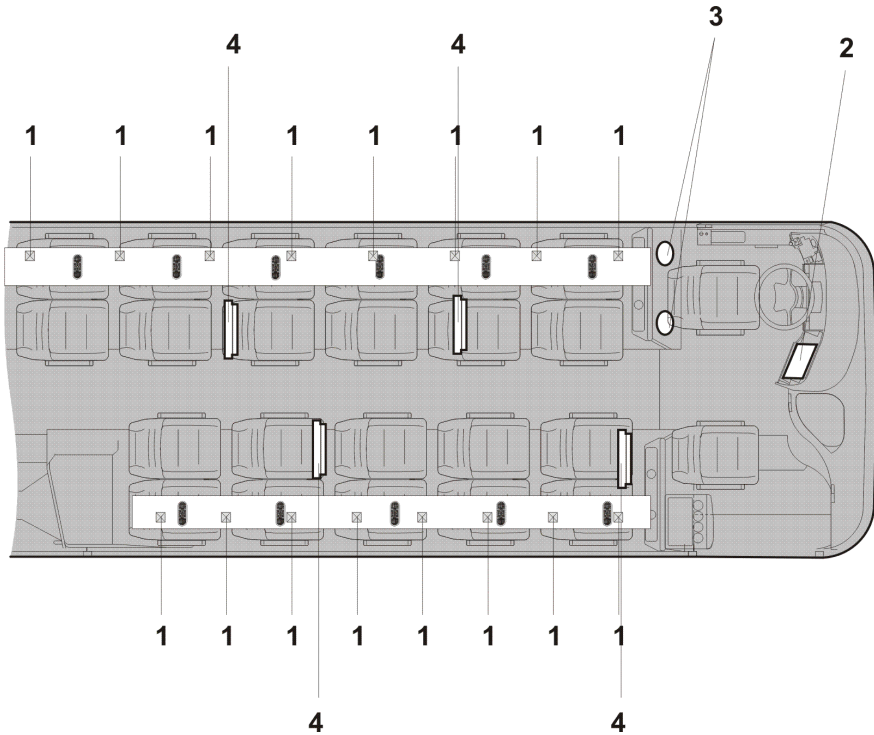

W0089970

- 1 Loudspeakers in the luggage racks.
- 2 CD, DVD player.
- 3 Drivers loudspeakers.
- 4 LCD monitors (mounted in the luggage rack, up to 5 maximum).

Audiovisual control panel

The Volvo 9700 US/CAN bus could be equipped with main unit, giving the driver complete control of the system.

For more information, see separate operating instructions provided by the manufacturer depends which audiovisual system is installed in the bus: “Bosch” or “Blaupunkt”.

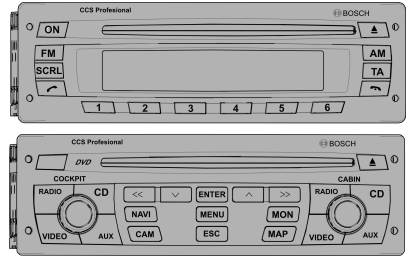

W8081374

“Bosch” control panel.



T8057538

“Blaupunkt” control panel.

Video system

The Volvo 9700 US/CAN is equipped as standard with a video system for the passengers either four or five LCD monitors in the bus. this LCD video monitors are installed in the luggage rack.

The video system monitors are activated by selecting the **VIDEO** signal source on the audiovisual controller.

For more information, see separate operating instructions provided by the manufacturer depends which audiovisual system is installed in the bus: “Bosch” or “Blaupunkt”.

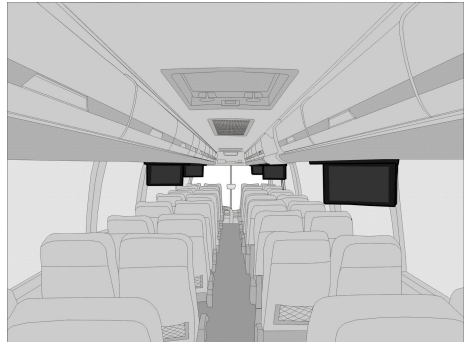

W0089755

LCD video monitors mounted in the luggage rack (up to 5 maximum).

Audio system

The Volvo 9700 US/CAN bus is equipped as standard with an audio system for the passengers.

The main elements of the audio system are:

- Radio.
- CD player.
- USB port for mp3 player input.
- Loudspeakers.
- Gadgets cable connection.

Note: The USB port and the gadgets cable connection are located into the glove compartment in the middle of the dashboard, as shown on the images (A) and (B).

The audio system is activated by a switch located in the dashboard (see the following section in this manual: “Audio system”, page 42) and controlled by selecting the “AUDIO” signal source on the own audio system control panel installed on the bus.

For more information, see separate operating instructions provided by the manufacturer depends which audio system is installed in the bus: “Bosch” or “Blaukpunkt”.

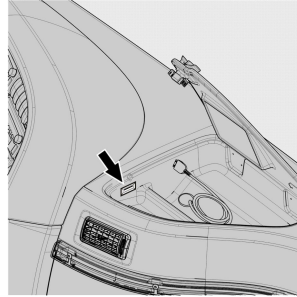

W0101223

(A) USB port to connect a pendrive with mp3 or a plug to charging other electronic devices.

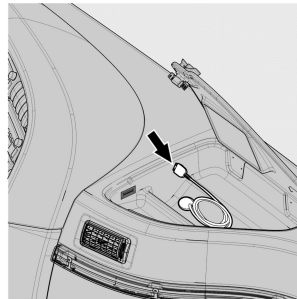

W0101195

(B) Cable connection for gadgets devices.

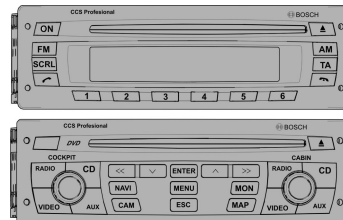

W8081374

“Bosch” control panel.

Guide or driver microphone (optional)

The Volvo 9700 US/CAN bus may be equipped with one or two microphones (for the driver or guide or both) and so give information messages to the passengers along the trip.

For enabled the microphone(s) selecting the “MICROPHONE” signal source on the own audio system control panel installed on the bus.

By doing this, other signal sources in the passenger loudspeakers are silenced and only the microphone(s) signal is heard.

For more information, see separate operating instructions provided by the manufacturer depends which audio system is installed in the bus: “Bosch” or “Blaukpunkt”.

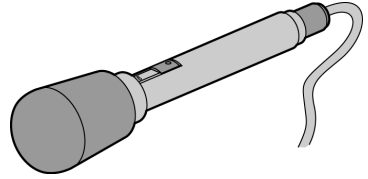

T3019220

Microphone device located in the lower center console of the dashboard.



W0089527

Microphone device placed in the driver seat head rest.

88 Emergency and safety equipment

Overview

As the driver you must always be familiar with the location of the emergency equipment in the bus, and how to use it.

It is essential that all emergency equipment is checked on a regular basis to make sure that it is in working condition and in place. The location of the safety equipment and its scope can vary, depending on the regulations in the country in question. Therefore make sure that you know where the equipment is and check that nothing is missing.

Fire extinguisher

The fire extinguisher is located in the front of the bus (most often mounted under dashboard on the right-hand side).

The fire extinguisher can be used to put out fires in volatile fluids, wood, fabric, paper and electrical equipment. Check regularly that the pressure gauge indicator is in the green zone. How to use the fire extinguisher:

- 1 Remove the fire extinguisher from its holder.
- 2 Hold the extinguisher by its handle with one hand, and pull the safety pin with the other.
- 3 Point the rubber hose at the heart of the fire and press the trigger.

To refer a first aid kit, see the following section in this manual: “First aid kit”, page 95.

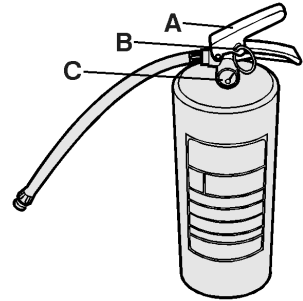

T0008196

- A Trigger.
- B Safety pin.
- C Pressure gauge.

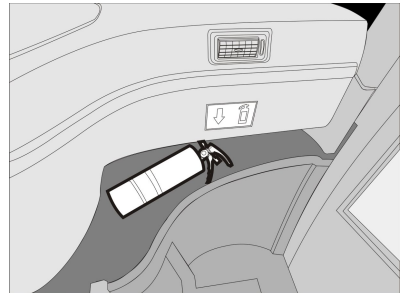

W0111065

Fire extinguisher location in the bus.

Automatized Fire Extinguished System (AFES)

The Volvo 9700 US/CAN bus is equipped with an Automatized Fire Extinguished System (AFES). This system provides continuous monitoring of the hazard areas of the engine bay. It responds to fires fueled by diesel, oil, lubricants and another flammable liquids.

If a fire is detected, the system will alert the driver with both audible and visual alarms while immediately shutting down the air conditioning system. A time delay allows the driver the capability to bring the vehicle to a safe stop prior of the activation of the fire extinguisher and engine shutdown.

Note: If additional time is required the timer can be reset by pressing the “delay engine stop button” placed in the **fire protection panel** located in the dashboard.

For more information related to the Automatic Automatized Fire Extinguished System (AFES) operation, see separate operating instructions: “Automatized Fire Extinguished System (AFES)”. Also, for more information about additional multiplexed fire detection system in the engine bay, see the following section in this manual: “Additional fire detection system (multiplexed)”, page 154.

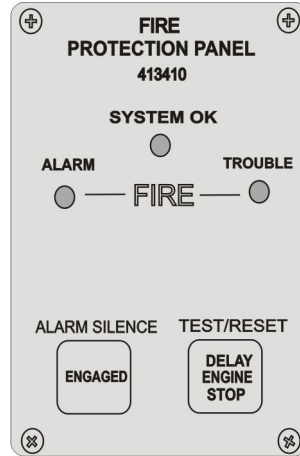

T8061163

Fire protection panel.

Automatized Fire Extinguished System (AFES) manual discharge

In the event of fire do the following:

- 1 Twist and pull tamper seal to remove.
- 2 Lift the cover.
- 3 Push the red button.

If the driver activates the manual discharge switch the following will occur:

- 1 The “FIRE” alarm lamp will illuminate and the alarm buzzer will sound.
- 2 The extinguisher will discharge.
- 3 The engine will shutdown.

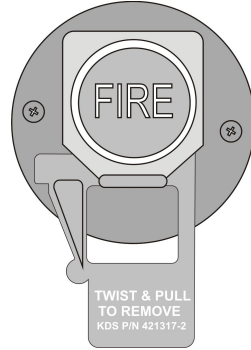

T8061299

Manual discharge (red color) button.



CAUTION

Service the Automatized Fire Extinguished System (AFES) before restarting equipment.

92 Emergency and safety equipment

Park pilot system

The Volvo 9700 US/CAN bus is equipped with the park pilot system. This system is a bus parking assistant with four ultrasonic sensors and helps the driver to reduce the potential collision risk with the obstacles or other vehicles when parking maneuvers are performed.

The park pilot system consist of the following elements:

- Electronic control unit (ECU).
- Driver display (mounted in a base located in the left “A” pillar).
- Four ultrasonic sensors (mounted on the rear bumper).

The system detects the distance between the rear bumper an a obstacle through its four ultrasonic sensors (mounted in the rear bumper). These sensors generate a signal, which is showed on the driver’s display and inform the driver the distance with respect to an obstacle, also and a visual LED bars indicator on the display providing graphical information of the distance between the rear bumper an obstacle and a warning alarm will be heard when the distance to the obstacle is less than 2 meters.

For more information, see separate operating instructions manual provided by the manufacturer “Actia”.

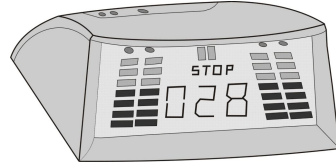

W0095901

Park pilot driver’s display.



W0090067

Park pilot driver’s display location (1).

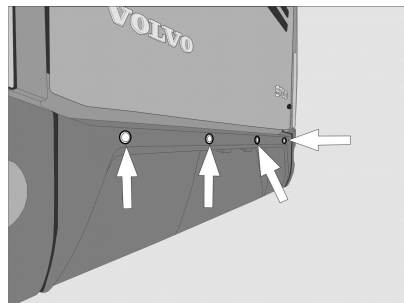

W0090016

Park pilot system ultrasonic sensors located on the rear bumper.



WARNING

The park pilot system does not replace the use of the rear view mirrors and drive the vehicle so cautious.

Tire Pressure Monitoring System (TPMS)

The Tire Pressure Monitoring System (TPMS) is a sensing device (1) designed to identify and display tire operating data and activate an alert or warning when pressure or temperature irregularities are detected.

The system will monitor all vehicle tires plus the spare tire when a spare is supplied.

For more information of the Tire Pressure Monitoring System (TPMS) operation, see separate operating instructions: “Tire Pressure Monitoring System”.

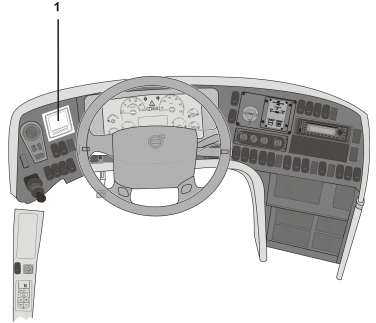

W0089756

Note: Is it driver responsibility to react promptly and with discretion to alerts and warnings. Abnormal tire inflation pressures should be corrected at the earliest opportunity.

(1) Tire Pressure Monitoring System (TPMS) display location in the dashboard.

94 Emergency and safety equipment

Tire Pressure Monitoring System (TPMS) display

The Tire Pressure Monitoring System (TPMS) display knows where the sensor are located. It receives the raw temperature and pressure readings from the TPMS receiver, it reads several signals from the vehicle and does the calculation required to generate the various screens.

When no readings have been received for a tire location or when the received data correspond to a parameter range defined as unavailable and appears as two dash lines “_ _”.

Also characteristics to the Tire Pressure Monitoring System (TPMS) display are:

- The TPMS display is initially configured to define how many axles and running tires are present on the vehicle.
- The TPMS display is also configured with several other parameters, including threshold levels for the alarms.
- The TPMS display power supply turns **OFF** when the ignition key is switched **OFF**.



W0089757

Tire Pressure Monitoring System (TPMS) display.

Warning triangle

The warning triangle is located either in the toolbox located inside of the luggage compartment, or in a holder to the right of the driver.

The warning triangle is used whenever a fault forces the bus to stop in a hazardous location. Switch on the hazard warning lights and place the warning triangle at a distance stipulated by the traffic regulations of the country in question.

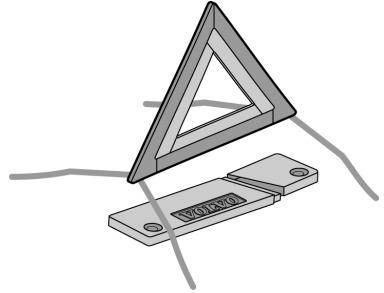

T8011683

First aid kit

The first aid kit contains basic first aid materials.

The first-aid kit is located into a compartment placed inside to the right luggage rack first compartment from the passengers area (for the fire extinguisher, see the following section in this manual: “Fire extinguisher”, page 89).

Note: The first-aid kit compartment is identified with the corresponding labels.

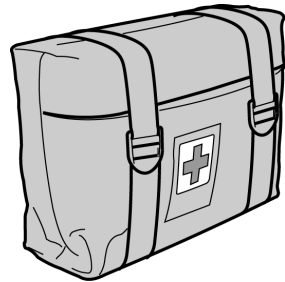

T1008716

First-aid kit.

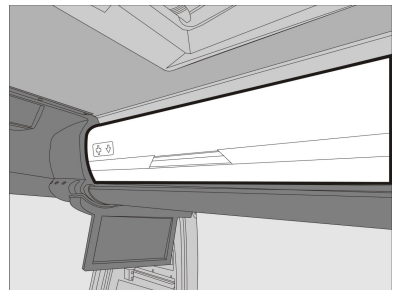

W011066

First-aid kit location in the bus.

Tire inflation valve

The Volvo 9700 US/CAN bus is equipped with output pneumatic valve located next to the driver's seat or inside the first service hatch.

The Valve release the parking brake when is necessary as engine breakdown for instance , e.g. engine breakdown.

The bus toolbox contains a hose that connects between the tire and the tire inflation valve.

Tire inflation valve be used to:

- Inflate a tire using the bus pneumatic system.
- Release the parking brake using the air from a tire.

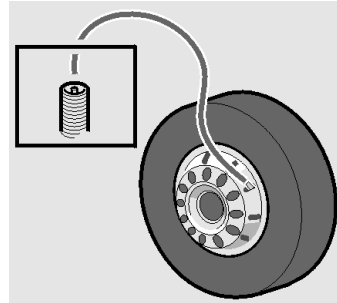

T0009182

External air supply connection

In the Volvo 9700 US/CAN bus, behind the front hatch there is a valve to which an external air supply can be connected. This could be used when parking the bus overnight, to prevent emptying of the air system.

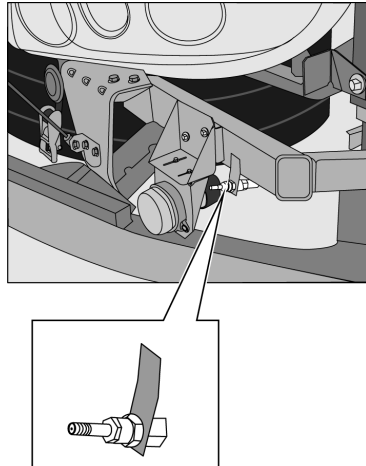

T0015390

Hydraulic jack

The bus is fitted with special jacking points to comply with safety regulations. For detailed information concerning the use of the hydraulic jack and wheel replacement, see separate operating instructions: “Replacement of wheels”.

Note: The hydraulic jack supplied with the bus used to lift the bus over intended lifting points (see the following section in this manual: “Wheels replacement”, page 192) to change a wheel at a time.

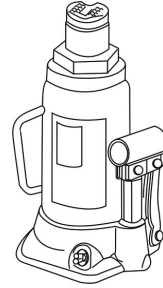

T0015345



DANGER

Always ensure that the bus is standing on a level surface and chock the wheels so it cannot move. Failure to do so may result in serious personal injury or death.

98 Emergency and safety equipment

Toolbox

The toolbox and tools can be purchased from your local dealer. A complete toolbox contains:

Toolbox	
Item	Part Number
Hydraulic jack (2 units).	3124497
Adaptor for the hydraulic jack.	3178753
Wheel wrench.	9521826
Towing kit.	205465449
Hammer.	962207
Pumping hose.	942868
Warning triangle.	3176488
Key for the hatches.	70319047
Female key.	70344906
Male key.	70344905
Pliers.	962042
Adjustable wrench.	755
Screwdriver with bits.	978201
Spare wheel wrench.	1062412
Winch handle.	1590997
Extension for pumping valve.	1621456
Socket wrench 19 & 24 mm.	8189085
Hydraulic jack extension.	1586079
Hydraulic jack extension.	1577686
Wheel wrench extension.	20592217
Tool bag.	1577384
Wheel chocks (2).	8158698

Engine control panel in engine bay

The engine control panel is located behind the engine hatch in the back of the bus. It is used in conjunction with servicing.

	<h3>CAUTION</h3>
<p>To avoid accidental engine turning on while you are in the engine bay, the switch (1) must be in position 0.</p>	

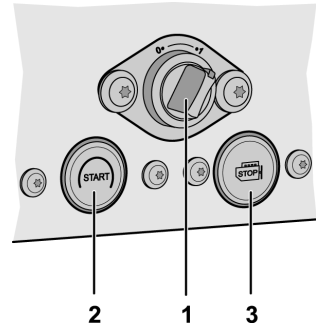

T2023998

The control panel has three controls:

1 Start switch.

When the switch (1) is turned to position 1, the engine can be started from the start button on the control panel, or the key ignition on the dashboard. When the switch (1) is turned to position 0, the engine cannot be started from the engine bay, nor from the dashboard.

2 Start button.

When switch (1) is turned to position 1, when pressing this button (2) starts the engine. The transmission must be in neutral position to start the engine from engine control panel. (N), and the ignition key must be in “DRIVE” position.

3 Emergency stop button.

Press the red button to stop the engine (3).

100 Emergency and safety equipment

Emergency exits

Doors

There is a valve for emergency door opening above to the service door, turning the knob cuts off the compressed air supply to the door and can be opened manually.

After turning the valve knob and hence cutting off the compressed air supply, a warning lamp lights up and a buzzer sounds. To return the compressed air system to normal state, turn the knob back to initial position and press the appropriate open door button on the dashboard (see the following sections in this manual: “Opening the bus from inside”, page 8).

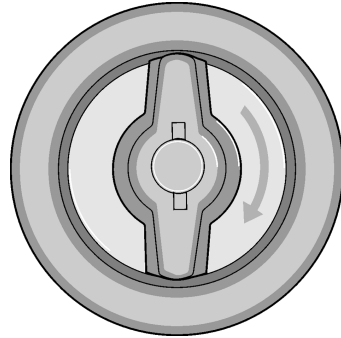

T8009617

Roof hatches

The Volvo 9700 US/CAN bus is equipped with 2 roof hatches used for ventilation and as emergency exits. To open the roof hatches in case of emergency, pull the hatch red handles and push the hatch upwards.

- From inside, pull the hatch red handles and push the hatch upwards.
- From outside, pull the hatch red handles and pull the hatch.

For more information, see separate operating instructions: “Manual roof hatch operation”.

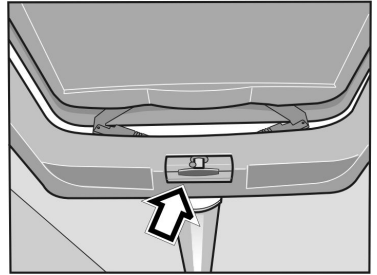

T8010110

Opening roof hatch from inside.

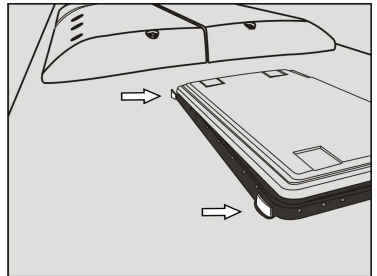

T8061298

Opening roof hatch from outside.

102 Emergency and safety equipment

Emergency windows

The Volvo 9700 US/CAN bus is equipped with this mechanical type of the emergency windows distributed along the passengers compartment. These windows can be opened from inside the vehicle as emergency exits. A decal on window sills indicates the location of the emergency windows.

To open an emergency window, lift the window release bar (sill) and push the window from the bottom to open. To close, lift the release bar and pull the window into position. Push down the release bar to lock the window shut.

For exit from the bus do the following:

- 1 Pull the red bar located at the bottom of each emergency window.
- 2 Push and hold the window with both hands.
- 3 Exit carefully.



F8061781

Emergency windows with the opening mechanism at the bottom of the window glass.

Checking before driving

Before starting the bus and driving off, check the pressure sensitive edges on the doors. If the door leaf during opening encounters an obstacle, the door should stop. If the door leaf encounters an obstacle during closing, the door should open again. It should not be possible to open the doors by hand while the engine is running.

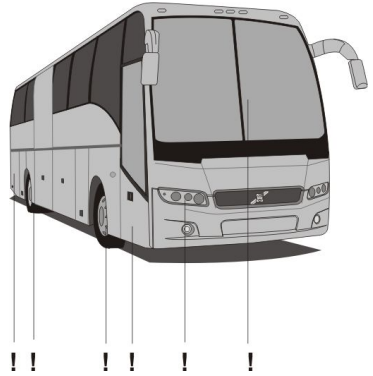

T0015270



WARNING

Make sure that the sensitive edges on the door work prior to vehicle use. Failure to do so may lead to personal injury of passengers.

Always make sure of the following:

- All the hatches are closed.
- All the lighting is working properly.
- The windshield wipers and washers working properly.
- The safety equipment is in corresponding place.
- The direction lights indicators and the horn are working properly.
- The tires air pressure is correct and any object is stuck between the dual rear wheels.
- The destination sign information and the line number are correct.
- The service doors emergency opening system are working properly.

104 Starting and driving

Bus interior and exterior cleaning and maintenance

It is recommended to perform daily bus cleaning will keep the attractive look of the vehicle to ensure that the service life and durability for optimal operation conditions. For more information about care and precautions when is performed the cleaning of bus interior, see separate operating instructions: “Interior cleaning and maintenance”.

When washing the outside of the bus, only use agents that are intended for this purpose, see the separate operating instructions: “Exterior cleaning and maintenance”.

Note: The areas subjected to intensive use by passengers require more attention.

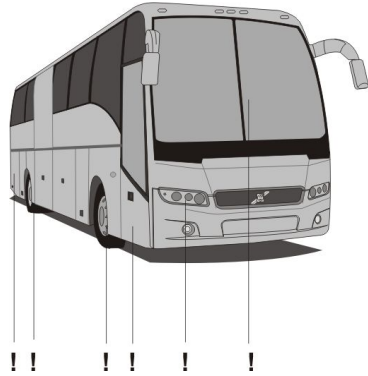

T0015270

Check the warning lights

When the ignition key is in the **I** position, the control system verify that all warning lights are working properly.

All warning indicator lights in the dashboard turn on by approximately **5 seconds**. The ABS system warning indicator turn on some more time than the other indicator lights.

	<h3>CAUTION</h3>
<p>If the ABS system warning lights on, the malfunction indicator light (MIL) or the “CHECK” light continue turn on after 5 seconds of turn the ignition key to the I position, indicates that one or many electronic problems in the bus systems. If this happens, you must go immediately to an authorized Volvo service center, to correct the existing problems.</p>	



T3014364

Stop message.



T3014365

Warning message.

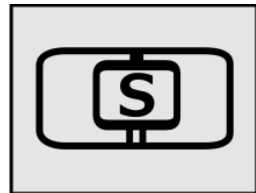

W3079585

Stop at the next bus stop message.

106 Starting and driving

Daily inspection

The fluid levels on the bus as engine oil, power steering fluid and the coolant, should be reviewed daily. This checking must be made with the **warm** and engine **OFF**. All the fluid reservoirs are located at the rear of the bus.

Note: Its recommended make these checks after a trip, when the engine is at normal operation temperature.

Engine oil level

To check the engine oil level, do the following:

- Park the bus over leveled ground and open the engine hatch compartment (use the appropriate key, see the following section on this manual: “Keys”, page 2).
- If the engine is cold, leave in idle speed at least by **1-3 minutes**.
- Shut off the engine. Wait at least **5 minutes** before carry out the inspection.
- Get out the oil dipstick.
- Check the engine oil level in the oil dipstick marks. The engine oil level must be between of the “**MAX**” and “**MIN**” marks and clean up the oil dipstick with a clean cloth.
- Add oil if necessary.
- Close the oil pipe with their cap.
- Close the engine compartment hatch.

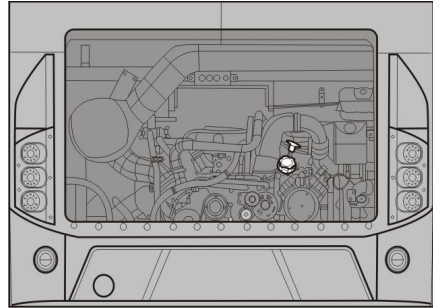

T8056919

Hydraulic level fluid for the engine coolant fan

Park the bus over leveled ground, open the engine compartment hatch (use the appropriate key, see the following section on this manual: “Keys”, page 2) and check that the hydraulic oil level its between of the “MAX” and “MIN” marks on the fluid reservoir for the engine coolant system fan. Add hydraulic oil if necessary and close the corresponding fluid reservoir and the engine compartment hatch.

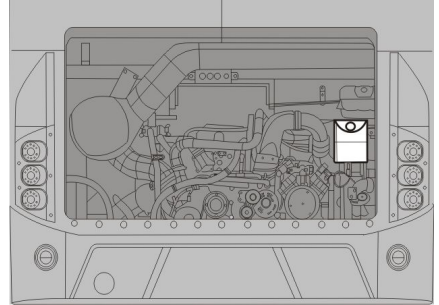

T8056920

Power steering hydraulic oil level

Park the bus over leveled ground and open the engine compartment hatch (use the appropriate key, see the following section on this manual: “Keys”, page 2) and check that the power steering hydraulic oil level its between of the “MAX” and “MIN” marks on the corresponding fluid reservoir. Add hydraulic oil fluid if necessary and close the fluid reservoir and the engine compartment hatch.

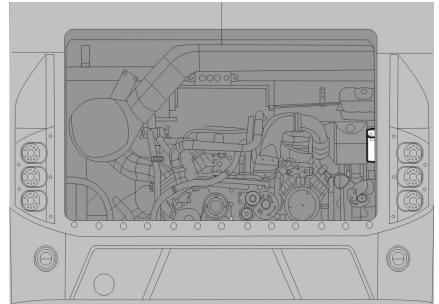

W0108035

Engine coolant system fluid level

Park the bus over leveled ground and open the coolant reservoir compartment hatch (as refer, see the following sections on this manual: “Doors and hatches configuration”, page 11 or “Doors and hatches configuration (bus with WCL)”, page 12) and check the engine coolant system fluid level its between of the “MAX” and “MIN” marks on the corresponding fluid reservoir. Add coolant if necessary and close the fluid reservoir and the engine compartment hatch.

Note: The reservoir is located over the rear engine door.

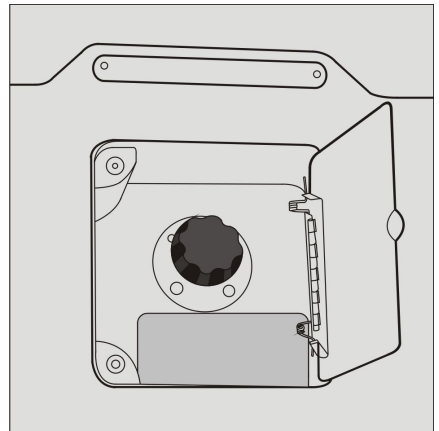

T8061297

Windshield washer fluid

Check the level of the washer fluid in the reservoir. Top up if necessary.

For add the washer fluid, do the following:

- Open the front left lower side hatch (to refer, see the following sections on this manual: “Doors and hatches configuration”, page 11 or “Doors and hatches configuration (bus with WCL)”, page 12).
- Lid the fluid reservoir cap.
- Place a funnel in the fluid reservoir filler neck and pour the washer fluid.
- Add a washer fluid up to its between of the “MAX” and “MIN” marks on the corresponding fluid reservoir.
- Close the washer fluid reservoir.
- Close the front left lower side hatch.

Note: In winter use a washer fluid for lower temperatures to avoid the fluid freezing inside reservoir.

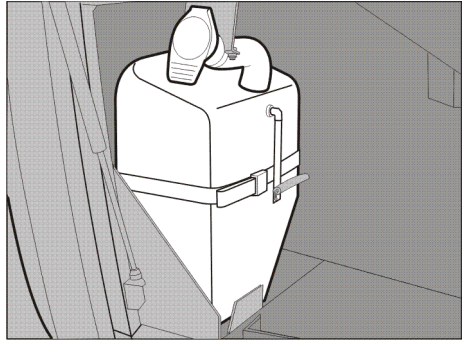

W0100282

Fuel replenishment

The Volvo 9700 US/CAN bus has two tanks with **105 gallons (400 liter)** capacity each one.

For bus fuel replenishment, do the following:

- Open the fuel filler cap hatch (use the appropriate key, see the following section on this manual: “Keys”, page 2).
- Open the filler cap of the fuel tank. To open press firmly with the entire palm hand whole to release the latch of your lock and release the filler cap.
- Insert the end of the fuel dispenser hose within the fuel tank filler neck.
- Fill the fuel tank with diesel fuel. The fuel tank must be filling up to **95%** as maximum to leave space at the top of the fuel tank for the originated fuel vapors and prevent spillage during the trip.
- After filling the fuel tank, remove the fuel dispenser hose and put it in the fuel dispenser pump.
- Close the fuel tank filler cap. To close the filler cap, press firmly with the entire palm hand the filler cap over the fuel tank filler neck to place the latch in the lock to then release the filler cap.
- Close the fuel filler cap hatch.

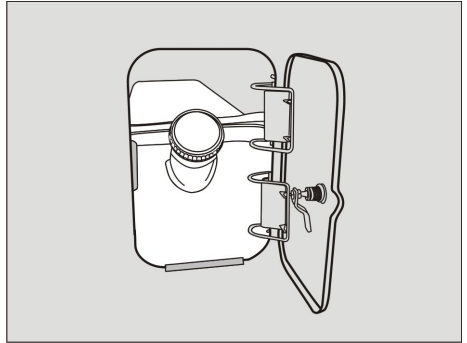

T2061889

110 Starting and driving

Fuel replenishment warnings



CAUTION

The use of Diesel fuel other than ULSD, will adversely affect performance, efficiency and durability of the DPF system and the engine, to the point where the engine may not run at all. Manufacturer's warranties can also be rendered void due to usage of improper fuel. None approved fuel additives (including engine oil) are NOT permitted. Blends of No. **1D** and No. **2D grades of ULSD** are recommended and allowable for cold weather operations.



CAUTION

Use only fuel that meets the recommended Volvo specifications. Contact to Volvo technical advisor to meet the appropriate fuel specifications for the engine installed in the bus.



CAUTION

When filling the fuel tank, don't spill a fuel on the painted surfaces to avoid damaging the paint finish.



WARNING

For your safety and the passengers, only replenishment fuel only in designated locations.

Diesel Exhaust Fluid (DEF) tank

On the right side and on the rear is the Diesel Exhaust Fluid (DEF) tank. To DEF tank fill cap access, open a lid hatch on the rear right side hatch compartment using the appropriate key (see the following section on this manual: “Keys”, page 2).

The DEF tank can hold **60 liters** capacity. As a guide, use **5 — 7%** DEF in relation to the fuel for after treatment systems “EPA 17”.

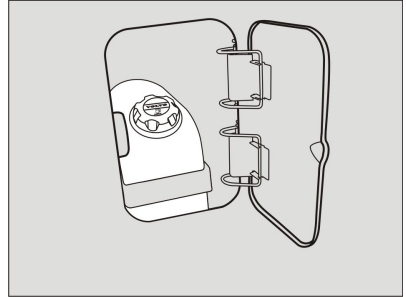

T2061890

Note: Avoid spilling DEF on to painted surfaces. In case of spilling, rinse the painted surfaces immediately.



WARNING

Use only pure certified DEF from an approved dispenser or sealed container.



CAUTION

Do not put diesel fuel in the DEF tank. Diesel fuel, if sprayed into the hot exhaust along with the DEF, could ignite explosively causing a fire resulting in personal injury or damage to the exhaust system.

112 Starting and driving

Diesel Exhaust Fluid (DEF) level related messages

The Diesel Exhaust Fluid (DEF) level is shown in the driver display in the dashboard, on the “Gauges” menu, then in the sub-menu “DEF tank, level”.

If the Diesel Exhaust Fluid (DEF) level fall down of a defined level (**20% reservoir capacity**), in the driver display shown a warning message in the dashboard, if this warning message appears fill the Diesel Exhaust Fluid (DEF) tank as soon as possible. If a fault condition occurs in the aftertreatment system, will display the corresponding malfunction icon in the driver display in the dashboard and the indicator light will flashes in the cluster, indicating that a problem relates to the emissions control system.

For more information related with the exhaust aftertreatment system to the emissions control used in “EPA 17” engines, see separate operating instructions: “Exhaust aftertreatment system”.



T3014365

Indicator light “CHECK” on in the cluster, when occurs the Diesel Exhaust Fluid (DEF) lower fluid tank level.

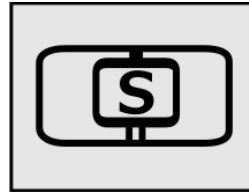

W3079585

Indicator light “Stop at the next bus stop” on in the cluster, when occurs the Diesel Exhaust Fluid (DEF) lower fluid tank level.

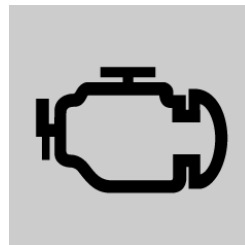

T3019966

Malfunction icon indicator shown in the driver display if the Diesel Exhaust Fluid (DEF) fluid tank level is below of **20%**.

Engine block heater

An electric engine block heater can be installed for keeping the coolant hot when the vehicle is parked

This equipment has the following features:

- The heater is mounted through the side of the engine block with the heater coils in the coolant jacket.
- The heater does not interfere with normal operation and can be permanently installed.
- The heater runs on **120 V** and has an easily accessible plug, located on the right side of the engine compartment.

Note: The plug will hook up to a normal extension cable.

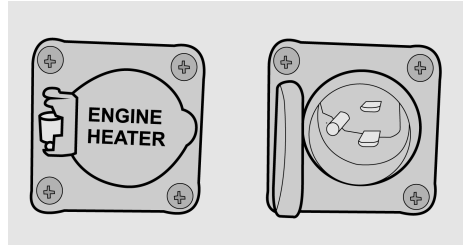

T0015492

Starting the engine

Starting

When engine starts, the parking brake must be engaged and the gear selector must be in neutral **N**, turn the ignition switch up to **III** position “starting position” and once the engine starts, release the key switch.

For more information about the ignition switch positions, see the following section on this manual: “Ignition switch”, page 47.

Start a cold engine

When starting the engine at temperatures around **50 °F (10 °C)** and below, the air entering the engine should be heated. To prevent wear and possible damage to the engine when it is cold, gradually bring it up to operating temperature before high engine speed operations or full load. After starting and before moving the vehicle run the engine at **800 to 1000 rpm** for **3 to 5 minutes**.

Operate at partial engine load until the coolant temperature reaches **167 °F (75 °C)**.

For an engine cold start, **proceed as follows**:

- Turn **ON** the ignition key switch between **II** and **III** positions, this starts the preheating.
- The indicator light of the preheating relay turn on in the dashboard during the preheating which can take up to **50** seconds, it depends of coolant temperature.
- Once the pre-heater indicator has turn **OFF** and the needle of the temperature gauge has moved out lower limit, the engine can be started.



T0014333



CAUTION

Do not let a cold engine run faster than **1000 rpm** in very low temperatures (**< -68 °F (-20 °C)**). Failure to do so may be cause internal engine damage.

Starting a warm engine

Engine starts when key switch turned on start position (**III**).

For more information about the ignition switch positions, see the following section on this manual: “Ignition switch”, page 47.

Shutdown the engine

To shut down the engine, turn the ignition switch key to the **0** position.

For more information about the ignition switch positions, see the following section on this manual: “Ignition switch”, page 47.

In an emergency situation the engine can be shut down by using the emergency stop switch.

For more information related to the emergency stop switch see the following section on this manual: “Emergency stop switch”, page 32.



CAUTION

Before turning **OFF** engine. If the engine has run at high temperature for a significant time before it is shut down, let the engine run at idle for **3 minutes** to cool the engine **OFF** to avoid heat soak.

Indicator lights on after the engine has been started.

Indicator lights on when the engine starts:

- The coolant level warning lamp lights up for second when the engine starts.
- The parking brake warning lamp lights up when the parking brake is engaged.
- After releasing the parking brake, the lamp should remain lit until the pressure increases to roughly **78 psi (540 kPa)**.
- The foot brake warning lamp and the “STOP” lamp should remain lit until the pressure in the compressed air tanks reach a sufficiently high level.



DANGER

Do not drive the vehicle until the warning lamps have gone out, as the brake system needs the correct air pressure to work properly. Failure to do so may be lead to an accident, resulting in serious personal injury or death.

Engine idle speed adjustment

The normal engine idling speed is **575–625 rpm**. Keeping the idling speed constant is the task of the engine electronic control system, which makes manual adjustment unnecessary. When the bus is stationary, the idling speed can be temporarily raised to **1200 rpm** adjusting as follows.

Idle speed adjustment

Before you start to adjust the engine idling speed, the engine must be warmed up to operating temperature, adjust the idle speed as follows:

- The switch **(B)** in the control lever at the steering column left side, should be in **ON** position.
- Press the “SET” button **(A)**, located at the end on the same lever) to the “+” position. Each time this button is pressed to this position is obtained by an increase of **10 rpm** on the idle speed.
- If the idle speed torn high, can be reduce by press the “SET” button **(A)** to the position “-”. Each time this button is pressed to this position is obtained by an decrease of **10 rpm** on the idle speed.

Note: The change in idling speed is only temporary. After pressing a pedal, engaging a gear or releasing the parking brake, the idling speed will return to its manufacturer settings (**575–625 rpm**).

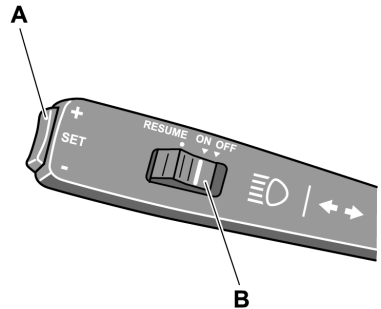

T0012078

118 Starting and driving

Engine idle speed adjustment (continue)

If new programming of idling rpm is required, proceed as follows:

- Maintain your foot on the brake pedal.
- Adjust the new idle speed according to the previous procedure.
- Move the switch **B** in the control lever at the steering column left side to the **RESUME** position when the idle speed is the desired and release the switch.
- Shut down the engine for programming this idle speed.

The next time to start the engine and you want that the engine runs to the last idle speed programming do the following:

- Start the engine.
- Let stabilize the default idle speed.
- Move the switch **B** in the same control lever to the **RESUME** position and release the switch.

The engine runs to the last programmed idle speed (this function non counts with a historical programming), to quit the programmed idle speed for the engine runs to the default idle speed, do the following:

- Press the throttle pedal.
- Press the brake pedal.
- Move the switch **B** in the control lever to the **OFF** position.

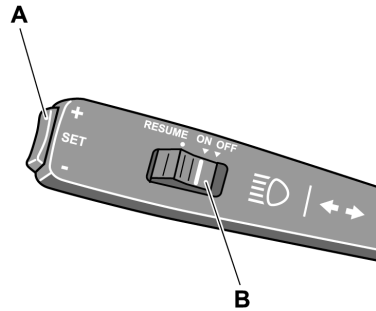

T0012078

Note: If the engine do not “runs smoothly” at the default programmed by the manufacturer, please visit an authorized Volvo service center.

Cruise control activation

To activated the cruise control do the following:

- Move the switch **B** in the control lever at the steering column left side to the **ON** position.
- When the bus reached the desired speed, press the “SET” button **A** located in the same lever to the “+” or “-” position for idle speed established.
- Press the “SET” button **A** in the same lever to the “+” position for increase established idle speed.
- Press the “SET” button **A** in the same lever to the “-” position for decrease established idle speed.

Note: If the speed is desired to increase temporarily, for example; to pass other vehicle, accelerate the bus and when you finish the maneuver, release the throttle and move the switch **B** in the control lever at the steering column left side to the **RESUME** position and release the button. The bus return to the established speed.

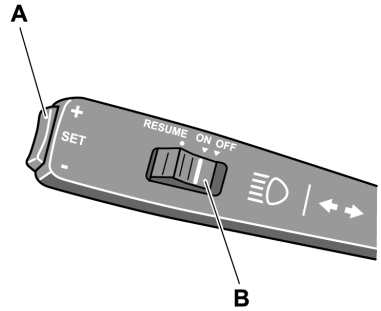

T0012078

120 Starting and driving

Cruise control deactivation

Cruise control is deactivated if do the following:

- The brake pedal is pressed.
- The clutch pedal is pressed.
- The retarder control lever its move to the other position.
- The switch **B** in the control lever at the steering column left side to the **OFF** position.

Note: After cruise control has been switched off, the most recent set speed can be restored by moving the switch **B** to **RESUME**. This however does not apply if cruise control has been deactivated by moving switch (**B**) to its **OFF** position.

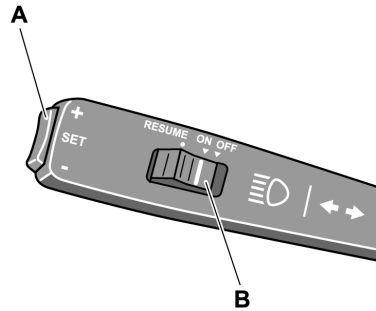

T0012078

Retarder (if installed)

The Volvo 9700 US/CAN bus may be equipped with an auxiliary brake equipment called “retarder”. The function of the retarder is to supplement the service brake acting directly on the main drive shaft that connects the shaft from transmission output with the carrier decreasing its speed, and thus serve an additional assistance brake.

The retarder works without a problem together with the **VEB** (engine brake patented by Volvo), **EPG** (exhaust gasses shutter) and the service brake for obtain a longer delay effect to braking more efficient, preventing it from overheating the service brake.

To completely retarder enable or disable, its count with a switch in the dashboard. But, to retarder activated or deactivated while driving use the control lever located at the steering column right side slightly above to the wipers control lever.

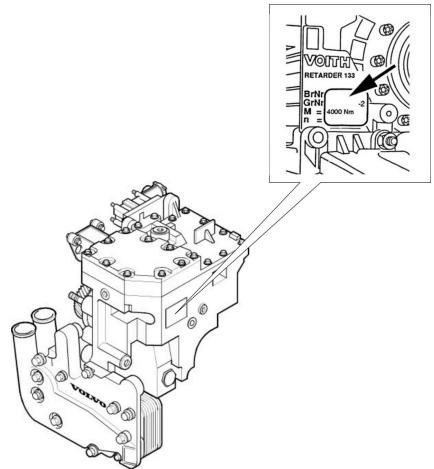

W0089959

122 Starting and driving

Retarder use (if installed)

This control lever count with many positions which are:

- Position **0**: The retarder is deactivated.
- Position **A**: The retarder is coupled in the automatic mode, this is that the retarder is matched every time the driver press the brake pedal by the time the **RECU** (retarder electronic control unit) select the appropriate intensity braking level depending the operational parameters obtained in real time. This function allows the optimal use of the retarder.
- Position **1**: Softly retarder brake intensity.
- Position **2**: Medium retarder brake intensity.
- Position **3**: Highest retarder brake intensity.
- Position **B**: In this position the control lever have a spring backward, when select it activated a braking program which combine automatically the retarder brake together with the engine and the exhaust brakes (if this auxiliary brake systems are installed in the engine) with brake intensities automatically adjusting by the **EBS** system according to vehicle speed, weight, tilt, engine speed and other more operational parameters. This braking function should be use when you want decrease quickly the bus speed without apply service brakes.

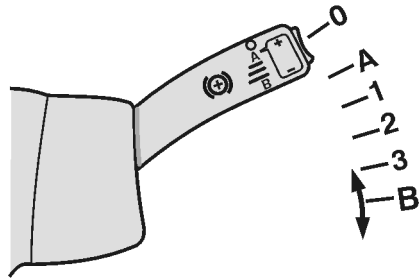

T0010263

Note: The **B** position for the retarder control lever only appears in buses equipped with **I-Shift** transmission.

For more information, see separate operating instructions: "EBS".

Retarder use (continue)

When you place the retarder control lever in either **1 to 3** positions, the bus is braked by the retarder with the corresponding brake intensity as soon as release the throttle pedal. The retarder power brake is gradually increase by sequentially moving down the retarder control lever and the retarder power brake is gradually decrease by sequentially moving up the same control lever.

In some coaches the retarder may be activated or deactivated by brake pedal.

For more information, see the following section on this manual: “Service brakes”, page 66.

Its important to mention while driving if maintain the retarder continuously operated and in this moment apply a panic or emergency brake, the **ABS** system enter and turn on the indicator light in the dashboard. When occurs this, the retarder function its automatically deactivated. This is completely normal to avoid damages on any brake system component.

The retarder operation and control functions are integral managed by the **EBS** system. For more information, see separate operating instructions: “EBS”.

Note: The bus minimum speed for retarder can activated is of **19 mph (30 km/h)**. Below this speed the retarder its automatically deactivated.

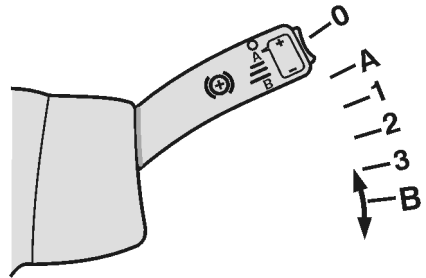

T0010263



DANGER

Avoid using the retarder on slippery roads because of the risk of locking the wheels and skidding because the reason that the retarder brakes only the driving wheels, in these conditions drive with sufficient safety margins. Failure to do so may lead to an accident, resulting in serious personal injury or death.

124 Starting and driving

Speed limiting

When the bus is driven downhill with the retarder stalk in position **A**, the retarder acts as a speed limiter.

For use the retarder in this operating mode, do the following:

- When the bus has reached the desired speed, lightly press the adjusting “SET” button **A** Located at the retarder control lever end (in the steering wheel column right side) to the “+” or “-” positions. The retarder keep the bus speed on the last adjustment when press the “SET” button **A**.
- The established speed may be can increase or decrease, pressing the “SET” button **A** in the same control lever to the “+” or “-” positions. Each time press the button increase or decrease the speed in relation of **0.6 mph (1 km/h)**.
- If maintain pressing the “SET” button **A** in the same control lever, the speed is adjust in relation of **0.6 mph (1 km/h)** per second that maintain pressed the button.

Note: The buses that have a switch for retarder activation in place of the control lever, the retarder not count with this function.

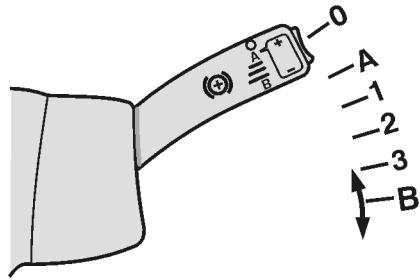

T0010263

Use the “SET” button **A** in the retarder control lever to control the speed limiter.

Combined cruise control and speed limiting

If the bus is equipped with the cruise control (see the section on this manual “Cruise control activation”, page 119), This system can operate together with the retarder. For this its possible, the retarder control lever should be in the “A” position. With the activated cruise control system the retarder will engaged if the bus speed exceed the established cruise control speed by **3 mph (5 km/h)**. This speed adjust value may be modified at any moment by press the “SET” button **A** located at the end in the control lever at the steering wheel left side to the “+” or “-” position. This over speed value can be modified to any value in the range **2 to 9 mph (3 to 15 km/h)**.

Note: The retarder is automatically deactivated if there is a risk for wheel locking, this is completely normal.

For more information, see the following in this manual: “Retarder (if installed)”, page 121.



T3008844



CAUTION

If the symbol for high retarder temperature is displayed, a lower gear range must be selected to cool it down.

For more information, see separate operating instructions: “Display”.

Power steering

The Volvo 9700 US/CAN bus is equipped with a servo assisted, increasing the driving comfort specially when performing maneuvers in yard or parking.

If the wheel is blocked on one side, i. e. against a curb, drive carefully forward and turn the steering wheel to allow the bus to move away from the kerb. Never try to force the wheels to turn.

Do not attempt to turn the bus by means of the use of excessive force on the steering wheel. Use excessive force on the steering wheel increases the pressure in the cooling system, causing a risk of overheating that can damage the hydraulic steering pump.

If the power steering is malfunctioning it may be feel as if the steering gear was blocked or a steering gear excessively hard, if this happens, do not start the trip and immediately contact an authorized Volvo service center to request the assistance road rescue service to move the bus and fix the problem (see the following section on this manual “Assistance and rescue on highway”, page 144.

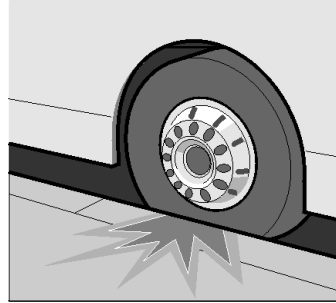

T0008960

DANGER

Never drive with the steering system in malfunction condition or damaged. Failure to do so may be lead to an accident, resulting in serious personal injury or death.

Exhaust Aftertreatment System (EATS) components

The Volvo 9700 US/CAN bus has an exhaust gasses aftertreatment system which complies with the environment emissions regulation **EPA 17**.

The Exhaust Aftertreatment System (EATS) complies with the emissions regulation **EPA 17** have the following main components:

- 1 Diesel Particulate Filter (DPF).
- 2 Diesel Emission Fluid (DEF) dosing valve.
- 3 Catalytic converter.

In normal operation, the catalyst surface can reach high temperatures around by **662° F (350° C)** so you have to take extreme precautions to avoid a burn, if for any reason its required an inspection in nearest catalyst or DPF areas specially when the engine is in operation or just getting to a certain destination.

Inspection of the **Exhaust Aftertreatment System (EATS)** components to detect a possible failure and fixed by authorized technicians as soon as possible. Its also important to check in the catalyst or in the DPF surfaces does not have substance traces that may be potentially flammable and may be cause fire due to the high system temperatures during normal operation.

New stringent standards for exhaust emissions control begin with the US 2017 engine model year. The Diesel Particulate Filter (DPF) system has been developed to act in combination with ultra low sulfur diesel (ULSD) fuel to reduce particulate emissions to meet the requirement. The Exhaust Aftertreatment System (EATS) includes all the engine and exhaust emissions control components that are required to meet the stringent **EPA 17** standard.

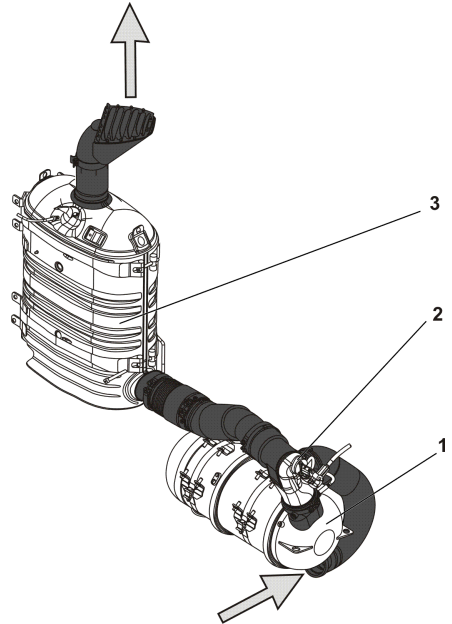

W0100283

Exhaust Aftertreatment System (EATS), warnings



CAUTION

The Diesel Particulate Filter (DPF), Diesel Emission Fluid (DEF) Dosing Valve, Catalytic reducer and associated components are part of a U.S. EPA and California Air Resources Board (CARB) certified engine emissions system. These components **must no be moved, altered or modified from OEM installation in any way** any alterations may cause component damage and is prohibited by the law. Tampering with these systems render the emissions warranty void and may result in possible tampering charges by the EPA or CARB.



WARNING

When you arrive from a trip or the engine is in operation and the exhaust system is warm, do not stay nearest to the Diesel Particulate Filter (DPF) area, if it is necessary to perform an inspection on nearby components or the Exhaust Aftertreatment System (EATS). Must wait for the engine exhaust system to cool to avoid the risk burn.



DANGER

The DPF and the Catalytic reducer cover should not be removed while the vehicle is in use. Also, only remove the cover, once the vehicle is out of use and the Catalytic Reduction and the DPF is sufficiently cooled. Failure to follow these instructions can result in fire, which can cause component damage, personal injury or death.

Diesel Particulate Filter (DPF) regeneration required icon

If the icon “DPF Regeneration Required” lights on, means that the diesel particulate filter is becoming full and regeneration is needed; the icon flashes when the filter is full, maintain uninterrupted highway speed for an automatic regeneration or move the vehicle to a safe location and initiated a parked regeneration.

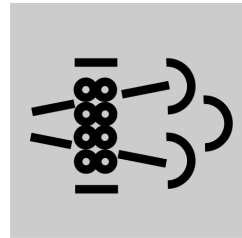

T0015482

High engine exhaust system temperature

The icon “High engine exhaust system temperature” lights on when a parked regeneration is initiated. It also indicates high exhaust gas temperature during an speed regeneration. When the high exhaust system temperature icon is light on, do not park or operate the vehicle near people, or any flammable materials, vapors, or structures. For more information about Exhaust Aftertreatment System (EATS), see separate operating instructions: “Exhaust Aftertreatment System”.

Note: It is important to enable regeneration as soon as possible to avoid engine problems. Long—term engine operation with regeneration disabled will result in a loss of engine performance including horsepower, torque and speed decrease.

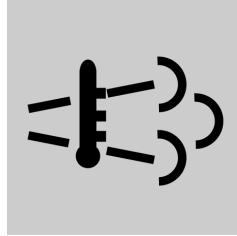

T0015483

Emission green house gas component warranty

Critical emissions related maintenance

- **Source of parts and repair:** A repair shop or person of the owner's choosing must maintain, replace, or repair emission control devices and systems per manufacturer's recommendations.
- **Replace of the tires that are GHG certified:** The original equipment tires installed on this vehicle at the factory were certified to the U.S. EPA Greenhouse Gas (GHG) and National Highway Traffic Safety Administration (NHTSA) fuel efficiency regulations. Replacement of these tires should be with a tire of equal or lower rolling resistance levels (TRRL or Crr). Please consult tire supplier(s) for appropriate replacement tires.
- **Maintaining a GHG certified tire:** In order to maintain the certified tilling resistance of the tires which optimize fuel economy, the maintenance procedures provide by the tire manufacturer must be followed. *Please visit PrevoSt Web Site for further information about Warranty.*

I-Start system

The Volvo 9700 US/CAN bus is equipped with the I-Start system, which is a dual battery system where divide the starter batteries from the consumer batteries.

The I-Start system is designed to improve and secure cranking also to provide a longer service life for the batteries even if deep-cycled by the consumers.

The I-Start system avoid discharge the batteries when the bus is not used for a time, this is supported by the main switch function when the ignition key is in (I) position.

With I-Start system the body loads can be active for a longer period without the risk of affecting the crank ability because the starter batteries are protected from draining.

For more information related to I-Start system, see separate operating instructions: "I-Start".

The electric circuit loads for the bus are split in two circuits which are the following:

- Chassis electronics connected to the starter batteries (*right hand side batteries compartment*).
- Body electronics connected to consumer batteries (*left hand side batteries compartment*).

Note: Inside of the right side batteries compartment is installed the cut-off batteries switch ("General switch"), for more about this switch, see the following section in this manual: "Batteries cut-off switch", page 164.



C0080351

I-Start system symbol.

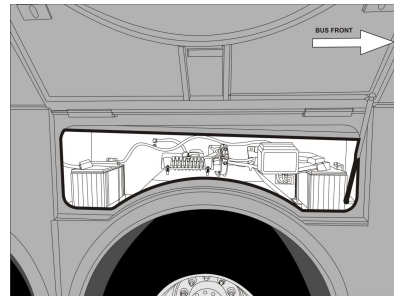

W0110919

Starter batteries compartment (*right hand side batteries compartment*).

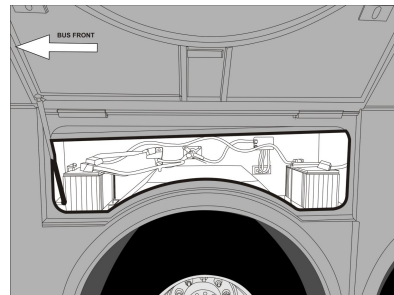

W0110920

Consumer batteries compartment (*left hand side batteries compartment*).

I-Start system (continue)

Inside on each batteries compartments placed a fuse box, this fuse boxes are identified with a decal placed on each fuse box showing which batteries are placed in the compartment:

- Chassis fuse box in the starter batteries compartment.
- Body fuse box, in the consumer batteries compartment.

For more information related relays and fuses positions inside in these electrical boxes, see the following sections in this manual:

- “Relays in the electrical distribution box corresponding to the I-Start system”, page 188.
- “Fuses in the electrical distribution box corresponding to the I-Start system”, page 189.
- “Mini fuse box holder inside to the left hand side batteries compartment”, page 191.

A decal with the system description in three languages is placed on the right hand side batteries compartment hatch backside.

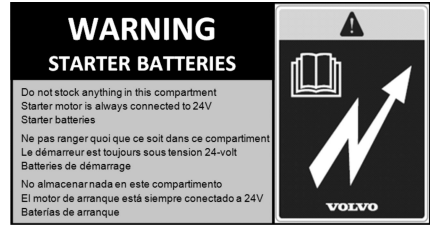

W0111068

Starter batteries decal.

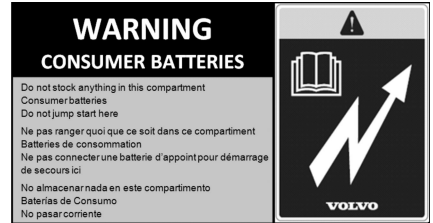

W0111069

Consumer batteries decal.

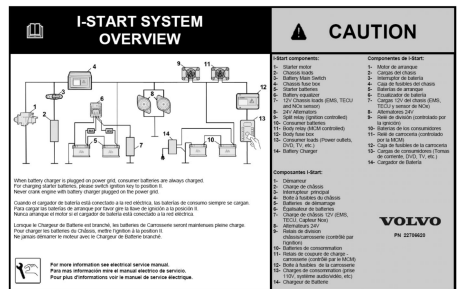

W0111070

I-Start system description decal.

I-Start system failure detection

Due to the reason the I-Start system is multiplexed to the bus electrical architecture bus (*BEA2*), the system operation is continuous monitored by the auto-diagnostic system which informs the driver (through by the driver's information display located in the instrument cluster) of the following conditions (which are the most common):

- MCM (*Master Control Module*) will check and warn if the batteries reach a voltage level higher than **28 V** when the engine is **OFF**. With the engine is **ON**, the voltage threshold was set in **23.5 V** (*low*) and **31 V** (*high*).
- Two messages were also created to inform if there is a problem in the K300 (*PID 158 FMI 1*) or K400 (*PID158 FMI 12*) relays. The messages below will appear on the LCD (*Liquid Crystal Display*) screen of the driver's information display in the instruments cluster whenever MCM (*Master Control Module*) sends the fault codes to BIC (*Bus Instrument Cluster*).

For more information about K300 and K400 relays, see the following section in this manual: "I-Start system power relays", page 137

- MCM sends the information to BBM (*Body Builder Module*) through the *CAN Bus*, and BBM (*Body Builder Module*) sends the fault codes to the driver's information display in the instrument cluster.

For more information related to the MCM (*Master Control Module*), see the following section in this manual: "MCM (Master Control Module) service switch", page 45.

Note: For more information related to I-Start system faults; see separate operating instructions: "I-Start" and for the symbols displayed in the driver's information display related to I-Start system diagnostics; see separate operating instructions: "Driver's information display".

Starter and consumer batteries failure detection

For the starter batteries, the state of charge is monitored by the BIC (*Bus Instrument Cluster*) module. The BIC (*Bus Instrument Cluster*) module will check and warn in case of high or low voltage being detected in the starter batteries.

In case for the consumer batteries, in order to protect the consumer batteries from draining and prolong their service life, a system based on ARMS (*Automatic Reset of Main Switch*), the MCM (*Master Control Module*) monitored the consumer batteries voltage and opens the **K400** power relay (also see: “I-Start system power relays”, page 137) when **23 V** is detected for more than **130 seconds**, shutting down the + **30** body power source.

Note: For the consumer batteries voltage control, this function will only act if the ignition key is on position **I** (for ignition key positions, see the following section in this manual: “Ignition switch”, page 47).

Note: For more information related to I-Start system faults; see separate operating instructions: “I-Start” and for the symbols displayed in the driver’s information display related to I-Start system diagnostics; see separate operating instructions: “Driver’s information display”.

136 Starting and driving

ARMS (Automatic Reset Main Switch)

The I-Start system in order to secure energy for cranking, the ARMS (*Automatic Reset of Main Switch*) relay was introduced. The ARMS relay is responsible for shutting down +30 power source to prevent starter batteries from getting drained when **23,5 V** are detected for more than **120 seconds**.

The control is made by BBM (*Body Builder Module*) through ARMS (*Automatic Reset of Main Switch*) relay, located in the fuse box inside to the right hand side batteries compartment.

This function will only act if the ignition key is on position **I + a click**, to refer the ignition key positions, see the following section in this manual: “Ignition switch”, page 47.

ARMS failure detection

When a fault is detected on the ARMS (*Automatic Reset of Main Switch*) relay output the BBM (*Body Builder Module*) will generate a fault code in case of an ARMS (*Automatic Reset Main Switch*) relay open circuit and an icon and/or lamp and text shall be displayed in the driver’s information display.

Note: For more information related to I-Start system faults; see separate operating instructions: “I-Start” and for the symbols displayed in the driver’s information display related to I-Start system diagnostics; see separate operating instructions: “Driver’s information display”.

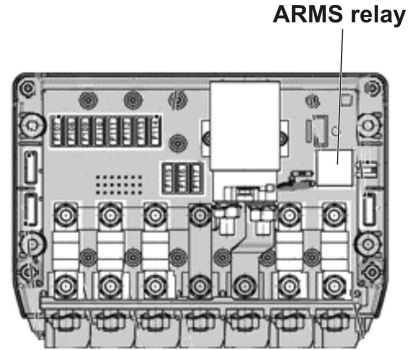

W0111465

ARMS relay inside to the chassis fuse box, located in the right side batteries compartment (*starter side batteries*).

I-Start system power relays

The I-Start system have a two power relays that are part of the system: .

- Body relay (**K400**) which doing the separation between consumer batteries and body loads. This power relay its controlled by MCM (*Master Control Module*).
- Split relay (**K300**) which connecting both chassis and body electronics. This power relay its activated by the ignition key position **II** to refer the ignition key positions, see the following section in this manual: “Ignition switch”, page 47.

Due to **K300** power relay control by the ignition key position **II**, the batteries sets will be put in parallel before starting, providing a higher CCA (*Cold Cranking Amps*), helping with the cranking.

Note: Both power relays have a decal in three languages for a better identification.



W011071

K300 power relay decal.



W011072

K400 power relay decal.

Batteries charger

The Volvo 9700 US/CAN bus is equipped with a batteries charger (120 V AC \pm 10%, 60 Hz \pm 10%), installed in the luggage bay, on the left side.

In the right hand side batteries compartment hatch there is installed an electrical outlet for connecting the charger to the power grid.

The batteries charger has the following charging modes:

- If ignition key is **OFF**, on position **0** or **I** + a **click**, only the consumer batteries are charged.
- If Ignition key is on position **II**, starter and consumer batteries are charged.

Note: The bus must not be started with the battery charger connected to the power grid.



W0111073

Batteries charger electrical outlet location in the bus.

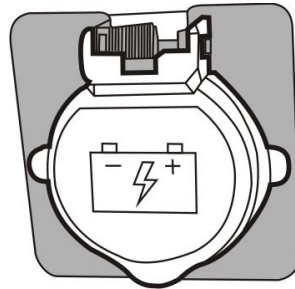

W0111074

Batteries charger electrical outlet.

Bulk charge time estimation

Consumer batteries charging (ignition key **OFF**, position **0** or position **I** + a click) :

- State of charge from **50% to 80%**:
Around **45 minutes**.*
- State of charge from **60% to 80%**:
Around **30 minutes**.*
- State of charge from **70% to 80%**:
Around **15 minutes**.*

Consumer batteries and starter batteries charging (ignition key on position **II**), at this position **+DR** power line is activated causing a higher consumption (*lower current charging the batteries*):

- Starter and Consumer Batteries with state of charge from **50% to 80%**: Around **6 hours**.*
- Starter and Consumer Batteries with state of charge from **60% to 80%**: Around **4 hours**.*
- Starter and Consumer Batteries with state of charge from **70% to 80%**: Around **2 hours**.*

* Considering SOH (State Of Health) **100%** and **25 °C**.

The values were estimated and may vary according to specific conditions.

To refer about ignition key positions, see the following section in this manual: “Ignition switch”, page 47.

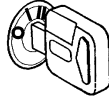

W3001302

Ignition key positions.

Safe driving

Attend and follow this advises to obtain a safe driving all the trip:

- 1 After starting, and regularly while driving, check that the instruments are giving their normal readings. If any warning lamp lights while driving, stop the bus and investigate the cause.
- 2 Never race a cold engine! Also avoid idling speed for long periods.
- 3 Never cover the radiator! The thermostat keeps the temperature constant regardless of ambient conditions. Check the coolant level regularly and use always the correct type of coolant. Check the hoses, pipes and tensioning of the belts. Do not drive with a cooling or heating system leakages.
- 4 Never drive off before the brake system warning lamps have extinguished in the dashboard.
- 5 Do not forget to release the parking brake.
- 6 The **ABS/EBS** indicator lamps may be light along the trip or stay lit after starting the engine, if this happens; the bus can be driven since the lights only indicate that the **ABS/EBS** auto diagnostic system detected a malfunctioning.
- 7 If one of the front wheels is blocked sideways, never try to force it to turn by applying excessive force to the steering wheel, because you can damage the servo-mechanism hydraulic pump.
- 8 While driving downhill and for gradual braking use the retarder (for more information see the following section in this manual: “Retarder (if installed)”, page 121). Take special care when driving in slippery conditions as there may be a risk of block the drive wheels using the retarder or disable the retarder altogether in this conditions to prevent the risk of wheels block and avoid skidding.
- 9 When driving on slippery surfaces, for example; in snow or heavy rain, reduce speed and avoid rapid steering wheel movements. Brake and accelerate gently, to make the journey as safe as possible for passengers. Driving in slippery conditions requires extra caution when there are strong side winds. Side winds can produce a lifting force acting on the front axle losing total directional control.

Economy driving

As the driver, you are the most important link in the chain for getting the best overall driving economy.

Follow these tips to get an acceptable economy driving:

- 1 **Warm up the engine as quickly as possible.** A warm engine (normal operation temperature) consumes less fuel than a cold one and there is less wear, extending the engine life time.
- 2 **Treat the throttle pedal gently.** Don't "pump" the throttle pedal. The pump action increases fuel consumption without increasing the speed. The information provided by the turbo boost pressure indicator will help to drive economically.
- 3 **High speeds increase fuel consumption.** Since, air resistance increases sharply when increases the speed. Front and side strong winds increase fuel consumption even more.
- 4 **Timely and correct servicing.** Timely and correct servicing will keep the bus in good condition, this will also contribute to preserving low fuel consumption.

Driving in cold weather

Before driving in cold weather conditions with ambient temperature of **41 °F (5 °C)** or below, pay attention to the following points:

- 1 The cooling system must be protected against freezing.
- 2 The washer fluid reservoir must be filled with winter liquid.
- 3 Batteries must be in good conditions. In low temperatures, the batteries capacity to deliver current drops, i. e. when starting the engine. Make sure that the poles of the batteries are thoroughly clean, with the cable terminals properly tightened and covered with grease, and that there is the correct amount of electrolyte in every cell.
- 4 Engine oil, as well as transmission and rear axle oil, must have the correct viscosity.
- 5 Fill up the tanks with winter fuel. This reduces the risk of wax settling in the fuel system. If this has already happened, change the fuel filters and fill up the tanks with winter fuel. Keep the tanks as full as possible.
- 6 The compressed air system is particularly sensitive to low temperatures. Excessive condensation in the primary tank indicates that the air drier is not working properly. Drain the tank and change the desiccator cartridge in the air drier. If none of these measures help, use an external heating source to defrost the system.

QR code labels

There are some QR code labels distributed inside the bus. The QR code labels provide the passenger's and the driver a basic information about the bus.

To access this information, must have a smart phone with the QR code labels reader application.

The QR code labels in the bus are the following:

- 1 For driver is located on left windshield pillar and cabin door (WCL) frame right structure pillar.

Link:

<https://www.prevostcar.com/QRPassP-revost>

- 2 For passengers are located in the side windows pillars.

Link:

<https://www.prevostcar.com/QRDrivV-2014>

Note: QR codes can be read by mobile devices.



W0091714

QR code label for driver.

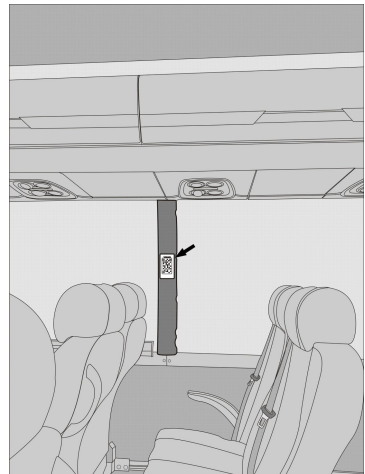

W0095902

QR code labels for passengers.

144 If something happens

Assistance and rescue on highway

(VAS, Volvo Action Service)

In all Volvo buses, is stuck a label on the right bottom corner of the window of the driver seat. On this label will find the contact telephone numbers to request at any time **(24 hrs, 365 days a year)** the assistance and rescue on highway service provided by Volvo and its dealers network (service available in Mexico and in the United States).

Note: Before request the assistance and rescue on highway service should be ready with the following information: Complete Vehicle Identification Number (**VIN**).

For more information, see the following section on this manual: “Bus identification plate”, page 211), the vehicle location (the most precise as possible) and a clear brief description to the problem.



W0086993

Label with the contact details to request the assistance and rescue on highway service VAS in Mexico and in the United States.

Safety

Note: Always make passenger safety your first priority!

If something unexpected happens you should always proceed as follows:

- 1 Stop the bus in a place which is safe for the passengers, and where the bus itself does not constitute an obstacle for other road users and switch on the hazard warning lights.
For more information, see the following section on this manual: “Hazard warning lights”, page 31.
- 2 Activate the emergency stop switch.
For more information, see the following section on this manual: “Emergency stop switch”, page 32.
- 3 Set the ignition key switch in **0** position (to refer the ignition switch positions see the following section in this manual: “Ignition switch”, page 47).
- 4 Open the service door(s). If necessary, use the emergency valve located at the top of each door.
- 5 Let the passengers out.
- 6 Place a warning triangle behind the bus. Remember that the distance between the warning triangle and the vehicle depends on local regulations.
- 7 Immediately call an authorized Volvo service center, describe the problem and request the assistance and rescue on highway service.
For more information, see the following section on this manual: “Assistance and rescue on highway”, page 144.

146 If something happens

If the engine is not working

If the engine does not start, check the following:

- 1 The emergency switch its not activated (The cover of the emergency switch is down.).
For more information, see the following section on this manual: “Emergency stop switch”, page 32.
- 2 The ignition switch is in **III** position.
For more information, see the following section on this manual: “Ignition switch”, page 47.
- 3 The gear selector is in neutral position (**N**).
For more information, see separate operating instructions: “I-Shift”.
- 4 The parking brake is engaged (see the following section in this manual: “Parking brake”, page 63).
- 5 The switch in the engine compartment is in (**1**) position, (see the following section on this manual: “Engine control panel in engine bay”, page 99).
- 6 Appropriate battery voltage in the starter batteries (*right hand side batteries compartment*), the engine cannot be started when the battery voltage is too low (below **18 V**).
For more information about appropriate voltage in the electrical charge system, see separate operating instructions: “I-Start”.
- 7 The engine cannot be started if either the engine hatch or the front service hatch is opened. In that case the display will show

an appropriate symbol. Close the hatch before trying to start the engine.



T3018116

Symbol as shown in the driver information display related to currently open hatches in the bus.

For more information about the symbols shown in the driver information display, see separate operating instructions: “Display”.

Note: This vehicle is equipped with a battery discharge prevention system. If, with the parking brake applied, the battery voltage drops below **23.5 V**, the ARMS (*Automatic Reset Main Switch*) system acts and cuts the power of the chassis loads (to refer for ARMS function, see the following section in this manual: “ARMS (Automatic Reset Main Switch)”, page 136).

When ARMS (*Automatic Reset Main Switch*) is acting, for re-start the bus, you must turn **OFF** and turn **ON** the ignition key switch or turn **OFF** and turn **ON** the batteries cut-out switch in the vehicle.

To refer about key positions, see the following section in this manual: “Ignition switch”, page 47.

If the engine is not working (continue)

Note: When ARMS (*Automatic Reset Main Switch*) is acting for doing the rest it is needed to turn **OFF** and turn **ON** the ignition switch.

If these reviews don't get starting the engine, immediately contact an authorized Volvo service center to request the assistance and rescue on highway service.

For more information, see the following section on this manual: "Assistance and rescue on highway", page 144.

Punctures

There are several safety requirements that need to be considered in the event of a punctured tire.

For detailed information concerning wheel changing, see separate operating instructions: “Wheel replacement and towing”.

Punctured air bellows

If any of the vehicle’s air bellows are punctured, further driving should be avoided. The preferred alternative is to replace the bellow at the current location or the vehicle should be towed to the nearest Volvo work shop.

Only if other options are judged not feasible, the vehicle shall be driven. In such case, the speed must be reduced to maximum **12 mph (20 km/h)** and during approximate **0,5 hour (30 minutes)** in order to avoid consequential faults or park the bus in a safe place out of the way and stop the engine and immediately contact an authorized nearest Volvo service center to request the assistance and rescue on highway service (see the following section on this manual: “Assistance and rescue on highway”, page 144).

For information about changing air bellows, see separate operating instructions: “Replacing wheels and bellows”.

Towing

The bus has for attaching a front and a rear drag points, see the accompanying illustration for the general location. For all long distance towing, assure that the tow vehicle has the necessary equipment to reach the front axle, per bus specifications, to refer see the following section on this manual: “Technical data”, page 201.

Towing or moving the bus for short distances can also be performed using a towing rod or bar, refer to the accompanying illustrations for attaching points location.

It may be necessary for the tow vehicle to attach an air supply to the bus during towing. To perform the towing its necessary use a bar of drag to tow and deploy it to the corresponding drag point (either to the front or back), release mechanically the parking brake and mechanically disconnect the transmission (either by removing the axle shaft or the main drive shafts to the drive wheels).

Towing requires either the drive shaft or both drive shafts to be removed, because otherwise the transmission may be damaged due to insufficient lubrication.

For more information about the transmission care in the towing process (for buses equipment with the Volvo I-Shift transmission), see separate operating instructions: “I-Shift”.

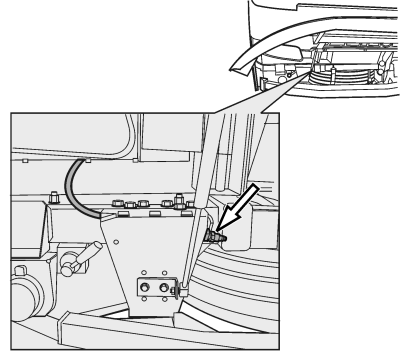

W1000252

Front air supply connection location.

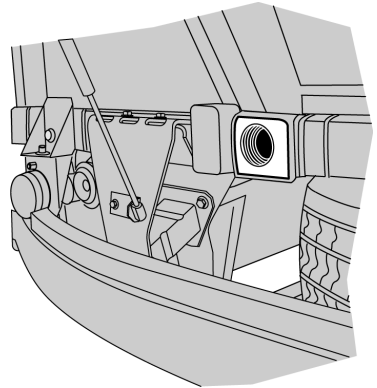

T8012390

Place for towing bar attachment (front).

150 If something happens

Towing (continue)

During the preparations for the bus towing, pay attention and take care at all the time the mechanically parking brake release of the bus, because after that the bus may be not be stopped (with the service brake or parking brake). First block the drive wheels, or connect a drag bar in another vehicle, so that the bus will not be able to start moving after you have released the parking brake. After mechanically releasing the parking brake, the bus cannot be braked either with the main brake or with the parking brake. Block the wheels or connect to the tow vehicle, so that the bus cannot start moving after the parking brake has been released.

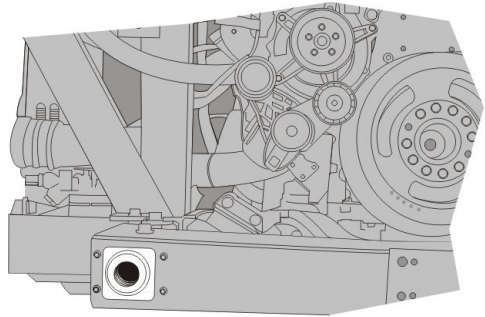

T8059309

Place for towing bar attachment (rear).

Note: TCS should be turned off if one of the axles is raised during towing and for, punctures, the tire must be repaired before towing begins.



CAUTION

Failure to disconnect the drive shaft, remove the drive axle shaft(s) or lift the drive wheels off the ground before towing or pushing the vehicle, can cause serious transmission damage and void the transmission warranty.

Bus towing considerations

When you perform the bus towing, also consider the following indications:

- The hydraulic steering will not work during the vehicle towing due to the engine is not operating, so will be very difficult to steer the vehicle.
- A punctured or flat tire must be repaired before the vehicle towing.
- The connections for the drag bar are only to be used in the bus towing. Should not be used for other purpose.
- Bus conditioned with a low mounted coupling for trailer reduces the ground clearance. Make contact with the ground can cause damage to the bus!
- The TCS (traction control System) needs to be disabled if an axle is lifted during vehicle towing.



CAUTION

The towing requires that the axle shaft or both drive wheels main shafts are removed, otherwise the gearbox may be damaged due to insufficient lubrication.

152 If something happens

Alternative towing procedure

Note: This procedure apply only for buses equipped with I-Shift AMT-D (Automatized Manual Transmission) and have the management software that include the alternative towing function.

If can not follow the bus standard towing procedure due to road conditions or any other circumstances, the I-Shift transmission provides an alternative function to bus towing which will allow it to tow the bus without axle drive shafts or drive wheels main shafts removals regardless of the distance that the vehicle needs to travel during the towing.

For the alternative towing procedure can take place, you must engage the **3 HR** speed in the transmission; for this it to be possible you must meet certain conditions, follow the alternative towing procedure described at the next page.



CAUTION

Do not replace the towing standard procedure, this procedure does not have any indicator, if any of the steps below are not fulfilled a transmission damage may be occur.

Alternative towing procedure (continue)

Bus alternative towing procedure:

- The gear selector lever or the gear selector pad must be in neutral (N) position. For more information, see separate operating instructions: “I-Shift”.
- Engine is not running.
- There must be enough air pressure to the gearbox servo mechanism (minimum **4 bar / 58 psi**).
- The vehicle must have enough electrical power in the batteries.
- The ignition key must be in “ON” position.
- Vehicle must be towed forward.



CAUTION

Reverse towing is not allowed when such towing alternative procedure applied.
Reverse towing can damage the gearbox.

154 If something happens

Additional fire detection system (multiplexed)

The Volvo 9700 US/CAN bus is equipped with a fire detection multiplexed system in the engine bay. This system is multiplexed to the bus electrical architecture “BEA3”. When the presence of fire in the engine bay is detected, the warning lamp “STOP” in the dashboard will turn on at the same time will emitted an audible signal and a symbol appears in the driver display in the dashboard.

Park the bus off the road in a safe place, stop the engine and immediately contact to the assistance and rescue on highway service to the phone provided in the stick placed at the bottom right corner on the driver window (for more information, see the following section on this manual: “Assistance and rescue on highway”, page 144).

Also, for more information about additional Automatized Fire Extinguished System (AFES), see the following section in this manual: “Automatized Fire Extinguished System (AFES)”, page 90.



T0012298



DANGER

When this warning is presented, park the bus off the road in a safe place and shut down the engine immediately! Failure to do so may be keep the radiator fan running which impels air into the engine bay and fans the fire. Failure to do so may be result in serious personal injury or death.

Releasing the parking brake

Release the parking brake with air from the bus tires

Only in an emergency case, you can use the bus tire or wheel air pressure to release the parking brake in case of being left without air pressure in the pneumatic system circuit.

To perform this, do the following:

- 1 Block the drive wheels or grip a drag bar to another vehicle in order to prevent the bus movement when the parking brake is released.
- 2 Connect the clamp head of the tire inflation hose to the valve of one of the wheels.
- 3 Move the parking brake control to the drive position (parking brake release, for more information see the following section on this manual: “Parking brake”, page 63).
- 4 While pressing the other end of the tire inflation hose against the pump nipple, press in the blocking valve. Now the brake system is filled with the air from the wheel. Filling can be interrupted as soon as the air flow stops.

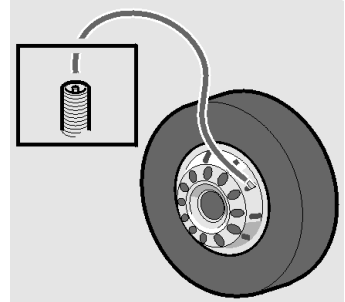

T0009182



DANGER

Block the drive wheels to prevent the bus from moving when releasing the parking brake. Failure to do so may result in serious personal injury or death.

156 If something happens

Parking brake mechanical releasing

To perform the bus towing procedure if there's no enough air pressure to release the parking brakes, these can be released mechanically.

To do this, proceed as follows:

- 1 Block the drive wheels or clamp a towing bar to another vehicle in order to prevent the vehicle to move when of releasing the parking brake.
- 2 In both drive shaft brake cylinders there are release bolts. Screw until you see out a red plastic button in the center of the screw, this the same in the other side, then the parking brakes are released. The full compression of the parking brake spring requires approximately **45 turns**, use the wrench, the socket and the fastener shank found in the tool box. Whenever possible try to fill with air the parking brake cylinders, this makes easier to turn the nuts of the release mechanism.
- 3 The bus can be towed when the parking brakes are fully released. Remember to make the bus towing must be done using the drag bar.

For more information about two available bus towing procedures, see the following sections on this manual: "Towing", page 149 or "Alternative towing procedure", page 152.

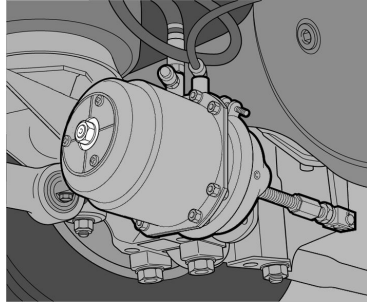

T5014634

Note: Do not forget to reset the bolts to their original position and attach the plastic cover after towing has been completed.



DANGER

Block the drive wheels to prevent the bus from moving when releasing the parking brake. Failure to do so may be result in serious personal injury or death.

Parking brake on disc brakes mechanical releasing

The Volvo 9700 US/CAN bus is equipped in all axles with disc brakes, which in the drive axle can be mechanically released if there's no enough air pressure to release the parking brakes.

To do this, proceed as follows:

- 1 Block the drive wheels or clamp a towing bar to another vehicle in order to prevent the vehicle movement when releasing the parking brake.
- 2 In the disk brakes set for the drive wheels, both brake cylinders are equipped with a release screw, screw until you see out a red plastic button in the center of the screw, do this in the other brake cylinder side, then the parking brakes are released. The full compression of the parking brake spring requires approximately **45 turns**, use the wrench, the socket and the fastener shank found in the tool box. Whenever possible try to fill with air the parking brake cylinders, this makes easier to turn the nuts of the release mechanism.
- 3 The bus can be towed when the parking brakes are fully released. Remember to make the bus towing must be done using the drag bar.
For more information about two available bus towing procedures, see the following sections on this manual: "Towing", page 149 or "Alternative towing procedure", page 152.

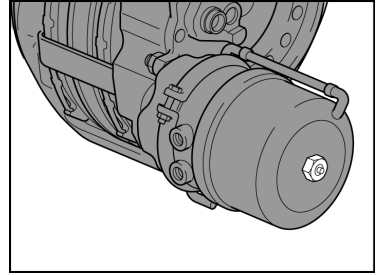

T5014635

Note: Do not forget to reset the bolts to their original position and attach the plastic cover after towing has been completed.



DANGER

Block the drive wheels to prevent the bus from moving when releasing the parking brake. Failure to do so may be result in serious personal injury or death.

Change the batteries

When changing the batteries, both batteries should have the same capacity and be of the same age. When connecting batteries correct polarity must be observed (to refer about correct batteries polarity, see the following section in this manual: “Starting assistance”, page 160).

To change a battery, proceed as follows:

- 1 Turn **OFF** the power supply with the ignition switch located in the left side of the steering wheel column (see the following section on this manual: “Ignition switch”, page 47).
- 2 Open the batteries compartment hatch (*Right or left hand side*)

Note: Use the proper key to open, see the following section in this manual: “Keys”, page 2.

- 3 Turn **OFF** the total power supply through by the batteries *cut-off switch* (“General switch”).
As a reference, see the following section in this manual: “Batteries cut-off switch”, page 164.
- 4 Disconnect the cable terminal from the battery negative pole.
- 5 Disconnect the cable terminal from the battery positive pole.
- 6 Change the battery or batteries.
- 7 Clean the cable terminals and both poles of the battery or batteries.

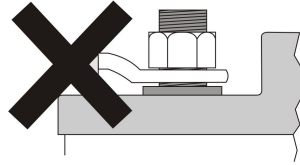
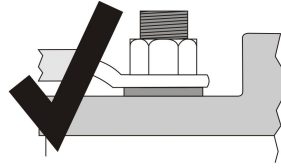

W011158

Upper: Mounted properly, the terminal firmly tighten to the battery post.

Lower: Improperly mounted, the terminal doesn't tighten to the battery post.

Change the batteries (continue)

8 — Connect the positive cable terminal to the battery pole (tighten firmly).

9 — Connect the negative cable terminal to the battery pole (tighten firmly).

10 — Apply an anti-corrosive agent to the poles with terminals.

11 — Turn **ON** the batteries power supply through by the batteries *cut-off switch* (“General switch”).

As a reference, see the following section in this manual: “Batteries cut-off switch”, page 164.

12 — Turn **ON** the power supply with the ignition switch (to refer the ignition switch positions, see the following section on this manual: “Ignition switch”, page 47).

13 — Close the batteries compartment hatches (*Right or left hand side*).

For more information about care and bus batteries handle, see separate operating instructions: “I-Start” .

Note: When you connect the cable terminals to the battery posts, should be tightened firmly, in order to avoid a false contact and cause cables overheating.



CAUTION

Incorrect batteries polarity connection will seriously damage the electrical system.



WARNING

If a cable clamp has been incorrectly installed (seated), the battery terminal must be reamed to give a sufficiently large mating surface when correctly installed (seated). Incorrect installation entails a high risk of oxidation in the space between the top of the battery terminal and the battery cable clamp.

160 If something happens

Starting assistance

In the event that the batteries are unable to start the engine, auxiliary batteries can be used to help in starting. These batteries are connected in parallel with the ordinary bus batteries.

For more information about the auxiliary batteries connection to the electrical system bus, see separate operating instructions: “I-Start”.

For connect the batteries in case of starting assistance, proceed as follows:

Note: The batteries polarity is indicated by decals on both batteries compartments.

Note the polarity plus to plus and minus to minus. It is important to handle the battery in a suitable environment, contact a Volvo dealer when discarding or storing batteries.

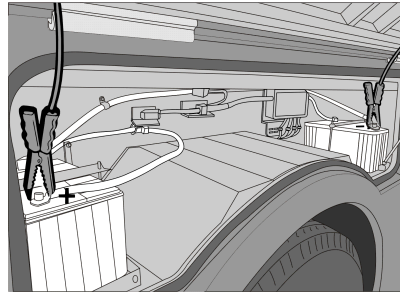

W0101443

Jump start.

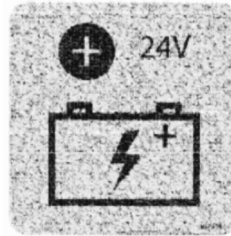

W0111075

Positive pole polarity decal.

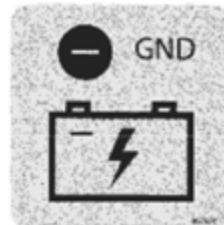

W0111076

Ground pole polarity decal.

Jump start batteries procedure

For jump start batteries, proceed as follows:

- 1 Place the ignition switch in **0** position.
- 2 Make sure the auxiliary batteries have **24 V** total voltage or **24 V** voltage on the system.
- 3 Turn **OFF** the engine on the “assistance vehicle” and make sure the vehicle do not touch each other.
- 4 Open the right hand side batteries compartment hatch.
- 5 Connect one of the red cable clamps to the positive terminal of the auxiliary battery. The positive terminal is marked in red, **P** or +.
- 6 Connect the other red cable clamp to the positive terminal in the bus battery. The positive terminal is marked in red, **P** or +.
- 7 Connect one of the black cable clamps to the negative terminal of the auxiliary battery marked in blue, **N** or -.
- 8 Connect the other black cable clamp to a ground stud for jump start placed inside to the right hand side batteries compartment.
- 9 Run the engine of the “assisting vehicle”. Let the engine run for about **1 minute**, at approximately **1000 rpm**.
- 10 Start the engine of the other vehicle.
- 11 Remove the clamp on the black cable from the ground terminal.
- 12 Remove the clamp on the black cable from the negative terminal on the auxiliary battery.
- 13 Remove the red cable.
- 14 Close the right hand side batteries compartment hatch.

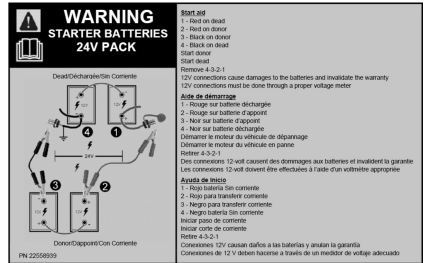

W0111077

Batteries jump start instructions decal.

Note: To refer about the ground stud for batteries jump start, see the following section in this manual: “Ground stud for jump start batteries”, page 163.

For batteries polarity identification, see the polarity decals placed into the batteries compartments.

In the backside of the right hand side batteries compartment hatch there is a decal with instructions for jump start in three languages.

162 If something happens

Jump start batteries procedure warnings



CAUTION

Make sure the cable clamps are firmly fixed to the battery poles to avoid risk of sparks and resulting explosion.



CAUTION

Battery chargers with a start boost feature must not be used for starting assistance. Failure to do so may cause damage to the electrical system.



CAUTION

Do not touch the auxiliary batteries cables or the terminals while starting the engine (risk of sparkles).
Do not lean over the batteries.



WARNING

Do not connect auxiliary battery rechargers to start the vehicle, since they operate at high voltage and can damage the electronic control units (ECU's).

Always use another vehicle or other batteries to assist in jump-starting the engine.



DANGER

Batteries contain sulfuric acid (which is corrosive and toxic) that can cause severe burning. If the acid contacts eyes, skin or clothes, flush with abundant water. If the acid spills on the eyes, visit a doctor immediately. Do not lean on or stand on the batteries.

Ground stud for jump start batteries

Inside of the right hand side batteries compartment, a stud for batteries jump start was placed at the right on the top of the batteries compartment frame. One ground indication decal is placed next to the stud.

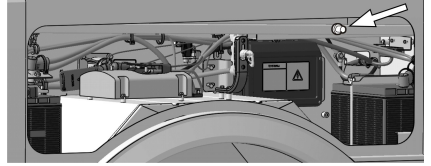

Ground stud for batteries jump start location in the right hand side batteries compartment.



Ground stud indication decal.

Batteries cut-off switch

Also called “General switch”, is located into the right side batteries compartment and is there to completely cut off the bus power supply. To prevent battery discharge when the bus is standing for **24 hours** or more, turn **OFF** the battery cut-off switch to the **0** or **OFF** position.

For more information about to the batteries power supply and the general switch function, see separate operating instructions: “I-Start”.

Note: After using the battery cut-off switch and to avoid the vehicle’s equipment may loose memory functions. For example: the radio code or trigger fault codes recordings due a lack of power to the control units.

The **B+** power supply is taken directly from the I-Start consumer batteries and is not disconnected by the batteries cut-off switch. This was intended especially to keep clock and radio memory when is necessary to turn **OFF** the batteries cut-off switch.

To refer the I-Start system in this manual, see the following section: “I-Start system”, page 132.

For more information related to the I-Start system, see separate operating instructions: “I-Start”.

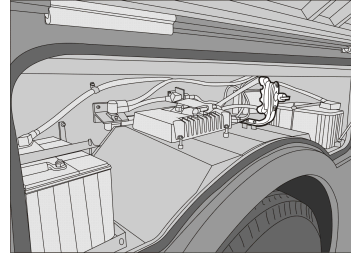

W0100418

Batteries cut-off switch location.(right side batteries compartment).

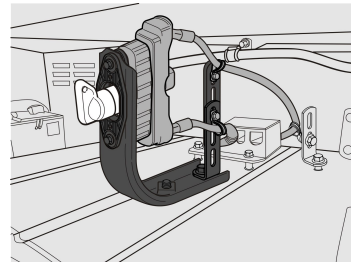

W0108406

Batteries cut-off switch knob.

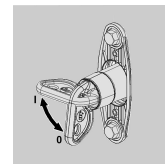

T0076655

Battery cut-off switch positions:

Position I: Connected.

Position 0: Disconnected.



CAUTION

Always switch **OFF** the power with the cut-off switch when charging the batteries and when connecting an auxiliary batteries to start the engine.

Before using the battery cut-off switch, the power must always be switched **OFF** using the ignition key at the right side of the wheel steering column in position **O** (to refer the ignition key positions, see the following section in this manual: “Ignition switch”, page 47).

Failure to do so may cause damage to the electrical system.

Operation of the SCR (Selective Catalyst Reduction) system

When the engine is **OFF**, the SCR injection system continues working to clear Diesel Emission Fluid (DEF) from the injector and supply tubes. This process takes approximately **90 seconds**.



CAUTION

Wait at least **5 minutes** after shutting **OFF** the engine to turn **OFF** the main switch (by ignition key in position **0**) so that the cleaning process can be completed. Otherwise, the Diesel Emission Fluid (DEF) in the SCR system can freeze at low temperatures.

For more information, see separate operating instructions: “Exhaust Aftertreatment System (EATS)”.

166 If something happens

I-Start system failure detection

The I-Start system continuously perform an operating status auto-diagnostics using the MCM (*Master Control Module*) to check the wiring harness status, batteries temperature, batteries voltage level, ARMS (*Automatic Reset Main Switch*) operation and other I-Start system operating issues.

If a fault or faults are detected, these will be shown in the driver's information display located in the cluster of the instrument panel by a symbols and informative or warning messages.

To learn more about these symbols and diagnostic messages displayed in the driver's information display; see separate operating instructions: "Driver's information display".

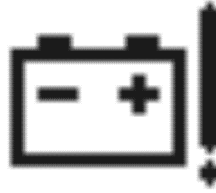

T3113158

I-Start failure symbol showed in the driver's information display.

Bulb replacement

Headlamps

Headlamp bulb replacement

For headlamp bulb replacement (right or left side), must do the following:

- 1 Lift the front bumper.
- 2 Loosen the securing screws (A) and (B), delicately lower the lamp module and tilt it open.
- 3 Disconnect power supply cables.
- 4 Remove the bulb(s).
- 5 Replace the bulb(s) as required.
- 6 Check the proper operation of the lights.
- 7 Install the lamp module.
- 8 Close the front bumper.

Note: Replace it with a new bulb of **24 V**, the same type and power rating (see the bulb part number in the following section in this manual: “Bulbs for lighting lamps”, page 203).

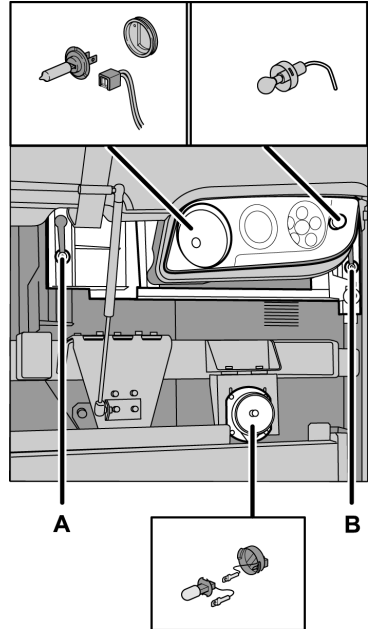

Xenon lights

DANGER

Xenon lights should only be serviced at an authorized service facility.

Never try to repair the lights on your own. Ignition voltage in xenon bulbs is **28,000 V**. Servicing these lights without the necessary knowledge and service information may result in serious personal injury or death.

Rear lights

Tail lamp replacement

For tail lamp replacement (right or left side), must do the following:

- 1 Unscrew the five cover fixing screws in the tail lamp.
- 2 Replace the lamps(s) as required.
- 3 Check the proper operation of the tail lamps.
- 4 Assembly the tail lamp set.

Note: Make sure that the lamp is replaced with a new lamp of **24 V**, the same type and power rating (see the lamp part number in the following section on this manual: “Bulbs for lighting lamps”, page 203).

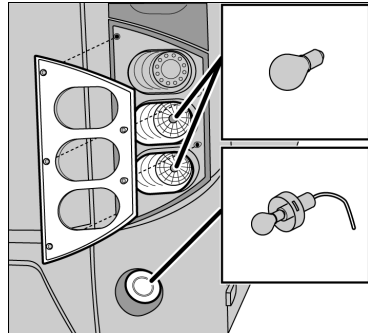

T3019941

License plate lighting

License plate lighting lamp replacement

Replace the license plate lamp as follows:

- 1 Unscrew the cover fixing screws of the lamp.
- 2 Replace the lamps(s) as required.
- 3 Check for proper operation.
- 4 Assembly the lamp set.

Note: Make sure that the lamp is replaced with a new lamp of **24 V**, the same type and power rating (see the lamp part number in the following section on this manual: “Bulbs for lighting lamps”, page 203).

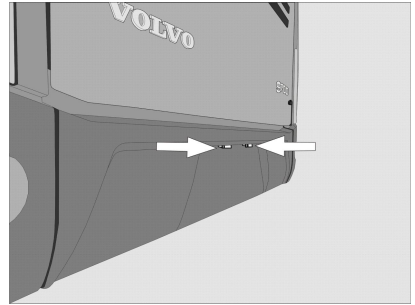

W0089795

170 If something happens

Electrical fault general lookup

The first step to take when troubleshooting the electrical system is to check the fuses in the bus electrical center and check the messages displayed by the On-Board Diagnostic (OBD) system.

A burnt-out fuse can be seen with the eye. In this case, remove the fuse from the fuse holder and replace it. If the same fuse burns repeatedly, the bus should be contact to a Prevost or Volvo authorized dealer to have the electrical system repaired.



WARNING

Never replace fuses with higher capacity fuses or with metal elements like wires, coins, etc.

Bus electrical center

The Volvo 9700 US/CAN bus is equipped with an electrical center where install the protect fuses and relays to the chassis and body electric circuits.

This electrical center is located at the front right of the bus, next to the entrance stairs and under to the partition wall.

Note: At the back side of the electrical center hatch, is stuck a label which has the description of each relay and fuse installed in the power load center to the chassis electrical circuits.

Similarly, for the fuse and relay box corresponding to the body electrical circuits, is stuck a label at the box lid back side which indicates the description of each fuse and relay installed inside the box.

Also the description for each symbol must be checked in this manual.

The label for the chassis electrical circuits on the electrical distribution unit only uses symbols for identification.



W0089803



WARNING

The relays in the electrical distribution unit that have this symbol next to them are mandatory for vehicle operation. Do not use the relays to replace other faulty relays.

172 If something happens

Chassis electric circuit relays

This electrical distribution unit is located in the bus electrical center, which is installed at the left side and beside of the service door.

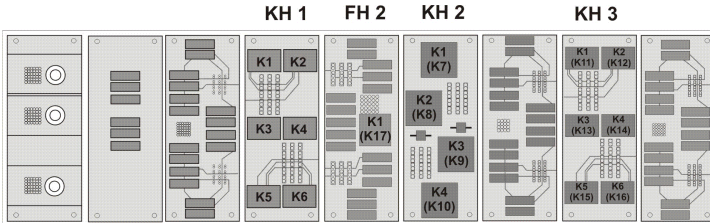

W0114430

The relays numbering its according to the circuit board position and into the parenthesis the equivalent position printed on the electrical distribute unit labels.



Relays “KH1 section”					
K1	— —	Not in use.	K2		Over load indicator.
K3		ECS (Electronic Control Suspension).	K4		Transmission “I-Shift” .
K5	— —	Not in use.	K6 ¹	— —	Not in use.

¹ 12 V Relay only.

Note:

The relays numbering positions in the circuit board are equal with the relays positions printed on the electrical distribute unit labels.

Chassis electric circuit relays (continue)



Relays “KH2 section”					
K1 (K7)		Start engine.	K2 (K8) ¹		VECU (Vehicle Electronic Control Unit). EMS (Engine Management System).
K3 (K9) ¹		Wiper motor. Washer.	K4 (K10)	— —	Not in use.

¹ Depends on version.

Note:

The relays numbering match as follows:

Circuit board position / (label position).

Relays “KH3 section”					
K1 (K11)		Prevent start engine.	K2 (K12)		Luggage compartment lighting.
K3 (K13)		Emergency switch relay.	K4 (K14)	SPARE	Spare.
K5 (K15)	SPARE	Spare.	K6 (K16)	SPARE	Spare.

Note:

The relays numbering match as follows:

Circuit board position / (label position).

Relays “FH2 section”		
K1 (K17)		Ignition “+ 15”.

Note:









The relays numbering match as follows:

Circuit board position / (label position).

174 If something happens

Other chassis electric circuit relays

Chassis electric circuit relays located outside from the bus electrical center.

Relays chassis					
K35 ¹		Relay disconnect headlight wash.	K48 ²		Relay engine preheating.
K53 ³		Relay starter key .	K79 ⁴		Prevent star relay.
K300 ³		I-Start main relay.	K400 ⁵	BODY +30	I-Start +30 Relay (Body builder).
K911 ⁶		Relay DRL front lights.	K918 ³		Relay for Allison gear selector ECU, I-Shift TECU, Aftertreatment NOX sensors, Relay 12 V EMS2 (Engine Management System, version 2), Solenoid valve AVU, engine brake / EPG.
K919 ³		Allison Gear selector ECU, Allison control module, power supply relay. Relay 12 V IVS.			

1 Depends on version.

2 Located inside of the under floor rear compartment at the back side of the passengers compartment.

3 Located inside of the right hand side batteries box.

4 Located inside of the engine compartment.

5 Located inside of the left hand side batteries box.

6 Located inside in the electric center.

Chassis electric circuit fuses



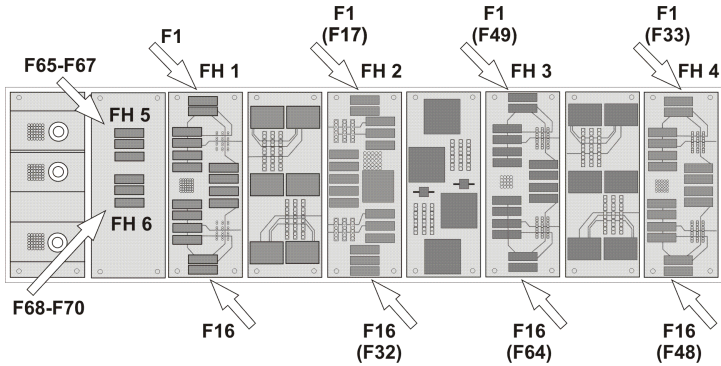







This electrical distribution unit is located in the bus electrical center, which is installed at the left side and beside of the service door.



W0114429

The fuses numbering its according to the circuit board position and into the parenthesis the equivalent printed on the electrical distribute unit labels.

176 If something happens













Fuses “FH1 section”							
F1	5A		Electronic Control Suspension (ECS).	F2	10A		Instrument Cluster (IC08).
F3	15A	— —	Not in use.	F4 ¹	20A		Electronic Brake System (EBS). Anti lock Brake System (ABS).
F5	5A		Horn.	F6	5A	— —	Not in use.
F7 ¹	15A		Gear Electronic Control Unit (GECU) I-Shift.	F8 ¹	5A		Gear selector pad or lever (I-Shift transmission).
F9	5A		Engine bay control panel to “start / stop”.	F10	5A		Fire alarm.
F11 ₁	10A	FMS	Dynafleet. Fleet Management System (FMS).	F12	5A	BODY +30	Body + 30.
F13 ₁	10A		Allison transmission control unit. Allison transmission shifter.	F14	5A	BBM	Body Builder Module (BBM).
F15	15A		Engine Electronic Control Module (EECU).	F16	5A	VECU	Vehicle Electronic Control Unit (VECU).

¹ Depends on version.

Note:

The fuses numbering positions in the circuit board are equal with the fuses positions printed on the electrical distribute unit labels.

Chassis electric circuit fuses (continue)















Fuses "FH2 section"							
F1 (F17)	5A		Switch feed.	F2 (F18)	5A		Alternator.
F3 (F19)	10A	HYMER	Hymer.	F4 (F20) ¹	10A		Electronic Brake System (EBS). Anti lock Brake System (ABS).
F5 (F21)	15A		Wipers and washer windscreen.	F6 (F22) ¹	10A		Gear selector pad or lever (I-Shift transmission).
F7 (F23) ¹	5A	FMS	Adaptive Cruise Control (ACC). Fleet Management System (FMS).	F8 (F24)	5A		Instrument Cluster (IC08).
F9 (F25)	15A		Washer motor.	F10 (F26)	5A		Electronic Control Suspension (ECS).
F11 (F27) ¹	10A	---	Not in use.	F12 (F28)	10A		Retarder Electronic Control Unit (RECU).
F13 (F29)	5A	BODY +DR	Body + DR (ignition key switch).	F14 (F30) ¹	20A		Electronic Brake System (EBS); Not in use.
F15 (F31) ¹	10A		Hydraulic oil. After treatment cleaner system control unit DNOx2.	F16 (F32)	5A		Tacograph.

¹ Depends on version.

Note: The fuses numbering match as follows:
Circuit board position / (label position).

178 If something happens













Chassis electric circuit fuses (continue)

Fuses "FH3 section"							
F1 (F49)	5A		Cut out fuel valve.	F2 (F50) ¹	10A	— —	Not in use.
F3 (F51)	5A		Radio.	F4 (F52)	10A		Luggage compartment light.
F5 (F53) ¹	10A		Bogie control valve. Heater water separator.	F6 (F54) ¹	5A		Luggage compartment hatches. Engine compartment hatch.
F7 (F55) ¹	10A		Exhaust gases Pressure Governor (EPG). Pre heating relay. Fan speed.	F8 (F56)	10A		Volvo Engine Brake (VEB).
F9 (F57)	5A		Key switch.	F10 (F58)	5A		Fuel Tank Monitor (FTM).
F11 (F59) ¹	10A	BIO	BIO (Bus Intakes — Outs) control module.	F12 (F60) ¹	10A		I-Shift lever. Sensor foot brake valve.
F13 (F61) ¹	10A		Light. Luggage room.	F14 (F62)	20A		Light sleeping compartment.
F15 (F63) ¹	5A		Overload indicator (Not in use).	F16 (F64)	10A		Load indicator.

¹ Depends on version.

Note: The fuses numbering match as follows:
Circuit board position / (label position).

Chassis electric circuit fuses (continue)

Fuses "FH4 section"							
F1 (F33)	5A		Instrument Cluster (IC08).	F2 (F34)	5A		Instrument Cluster (IC08).
F3 (F35)	25A		Lighting Control Module (LCM).	F4 (F36)	25A		Lighting Control Module (LCM).
F5 (F37)	25A		Lighting Control Module (LCM).	F6 (F38) ¹	—	SPARE	Spare.
F7 (F39) ¹	25A		After treatment cleaner system control unit DNOx2.	F8 (F40)	—	SPARE	Spare.
F9 (F41)	20A		Radio.	F10 (F42) ¹	5A		Main switch (ignition key in position I + a click).
F11 (F43) ¹	—	SPARE	Spare.	F12 (F44)	25A		Lighting Control Module (LCM).
F13 (F45)	25A		Lighting Control Module (LCM).	F14 (F46)	25A		Lighting Control Module (LCM).
F15 (F47)	5A		Left side marker lights.	F16 (F48)	5A		Right side marker lights.

¹ Depends on version.

Note: The fuses numbering match as follows:
Circuit board position / (label position).

180 If something happens

Chassis electric circuit fuses (continue)

Fuses "FH5 section"							
F65 ¹	30A	BODY +30	+30 Feed "A" (Not in use).	F66 ¹	15A	BODY +30	+30 Feed "B" (Not in use).
F67	—	SPARE	Spare.				

¹ Depends on version.

Note:

The fuses numbering match according to the position printed on the electrical distribute unit labels.

Fuses "FH6 section"							
F68 ¹	30A	B+	B+ Feed "B" (Not in use).	F69	—	SPARE	Spare.
F70	—	SPARE	Spare.				









¹ Depends on version.

Note:

The fuses numbering match according to the position printed on the electrical distribute unit labels.

Other chassis electric circuit fuses

Chassis electric circuit fuses located outside from the bus electrical center.

Fuses chassis							
F76 ¹	80A		12V Equalizer.	F77 ¹	40A		24V Equalizer,
F99 ¹	15A		Allison transmission control module +30 power supply.	F100 ¹	10A		ODB (On Board Diagnostic) connection to B+.
F206 ²	5A		External pre-heater.	F907 ³	20A		12V I-Shift.
F915 ³	30A	EMS	12V EMS2 (Engine Management System).	F955 ³	20A	EMS	12V EMS (Engine Management System) Act.
F956 ³	10A		12V Fuel pump.	F957 ³	20A		12V Cool fan.
F958 ³	10A		12V Allison transmission, gear box and OBD diagnostic connector.				

1 Located inside of the right hand side batteries box.

2 Located inside of the rear fuse box installed in the engine compartment (VPDUR; Volvo Power Distribute Unit Rear).

3 Located inside of the right hand side batteries box (on FH1; Fuse Holder board 1).

182 If something happens

Body electric circuit relays

This electrical distribution unit is located in the bus electrical center, which is installed at the left side and beside of the service door.

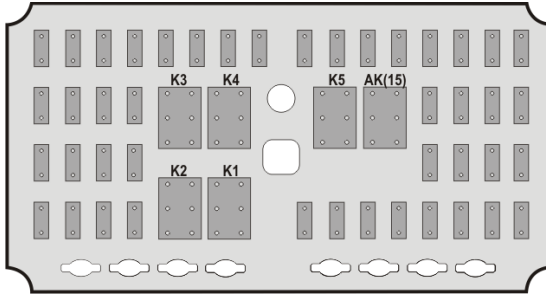

T8059319

Body relays					
AK (15)	BODY +15	Loads +15.	K3		Defroster speed 2.
K1		Over speed control 59 mph (95 km/h).	K4		Defroster speed 3.
K2		Defroster speed 1.	K5 ¹	 	Free relay.
					Night light.

¹ Depends on version.

Other body electric circuit relays

Body electric circuit relays located inside the bus electrical center.

Other body relays					
K910 ¹		KIDDE protection panel (Automatized Fire Extinguished System, AFES).	K911 ¹		Audio & video on demand.
K912 ¹		Tire Pressure Monitoring System (TPMS) relay.			

¹ Located inside in the electric center.

Body electric circuit fuses

This electrical distribution unit is located in the bus electrical center, which is installed at the left side and beside of the service door.

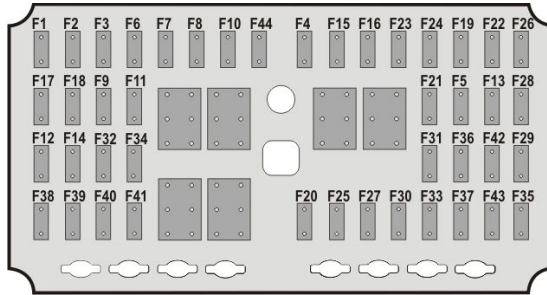













T8058916

Body fuses							
F1	3A	BODY +30	Feed +30 service kit.	F7	5A	BIO	Climate unit I/O A module.
F2 ¹	5A		Bosch entertainment system. DRL (Day Run Lights).	F8 ¹	15A		Defroster flap.
F3	20A		Audio & Video 12V.	F9	5A		Red led switches.
F4	30A		Feed relay K5.	F10	20A		Defroster.
F5	30A	BIO	Floor I/O B module.	F11	30A	BIO	Floor left 2 I/O B module.
F6	5A	BIO	Climate I/O A module.	F12 ¹	7.5A		Innova control. MCM (Master Control Module) feed.

1 Depends on version.













184 If something happens

Body electric circuit fuses (continue)

Body fuses (body electric circuits, continue)							
F13 ¹	7.5 A	BIO	Left & middle toilet I/O B module.	F22	15A	B+	+B feed MCM.
	15A		AFES (Automatized Fire Extinguished System).				
F14	20A		Electric window.	F23	5A		Light under seats.
F15	30A		Wheel Chair Lift (WCL).	F24	5A	BIO	Middle door I/O A module.
F16	30A	BIO	Roof left I/O B module.	F25	5A		Webasto timer 3.
F17	5A		Webasto timer 2.	F26	5A	BIO	Dashboard I/O A module.
F18	20A		Audio & Video 24 V.	F27	30A		24V CD Output in driver side.
F19	7.5 A	BIO	Toilet I/O B module.	F28	5A		Pressure switch.
F20 ¹	15A		Dashboard converter. Cigarette lighter output.	F29 ¹	3A		Copiloto. Volvo link.
F21 ¹	5A		Copiloto. TD7. Wi — Fi.	F30	5A		Control panel air.

¹ Depends on version.

Body electric circuit fuses (continue)

Body fuses (body electric circuits, continue)							
F31 ¹	3A	BODY +15	Feed +15 TD7.	F38	3A		Volvo link.
F32 ¹	5A	BODY +15	Innova (+15).	F39 ¹	7.5 A		Roof hatch front.
F33	15A		DRC Air conditioning.	F40 ¹	7.5 A		Roof hatch rear.
F34	20A		Audio & Video (+15).	F41	5A		Webasto timer 1.
F35	10A		Park pilot system.	F42	15A		Electrical blinder.
F36	5A		Time & temperature display.	F43	5A		Auxiliary heater.
F37	15A		TPMS (Tire Pressure Monitoring System).	F44	15A		Feed over speed relay.

¹ Depends on version.

186 If something happens

Other body electric circuit fuses

Body electric circuit fuses located inside the bus electrical center.

Other body fuses			
F107 ¹	40A		I-Start B+ supply from body electrical center (distribution box).

¹ Located inside in the electric center.

Fuse boxes inside to the batteries compartments

The Volvo 9700 US/CAN bus is equipped with 2 fuses and relays electrical boxes mounted inside to the batteries compartments. This fuses and relays boxes are follows:

- (A) Chassis fuses and relays box, including protect elements for the “I-Start” system (for more information, see separate operating instructions: “I-Start”).
- (B) Mini fuse box holder for body builder equipment electrical distribution.

The fuse and relay box lid corresponding to “I-Start” system has a label in one of its sides, which; description provide for each relay and fuse are install.

In the information shown below, its provide the fuse and relay description installed in both electrical boxes for a quickly references guide.

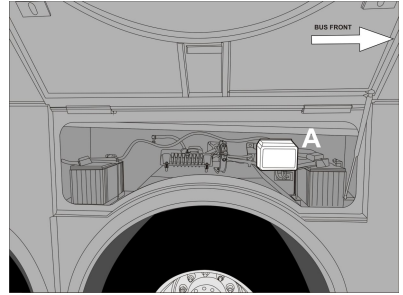

W0111079

(A) Chassis fuses and relays box inside to the right hand side batteries compartment.

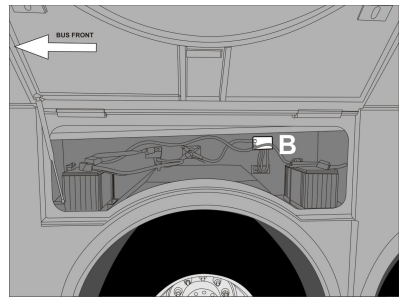

W0111080

(B) Mini fuse box holder inside to the left hand side batteries compartment.

188 If something happens

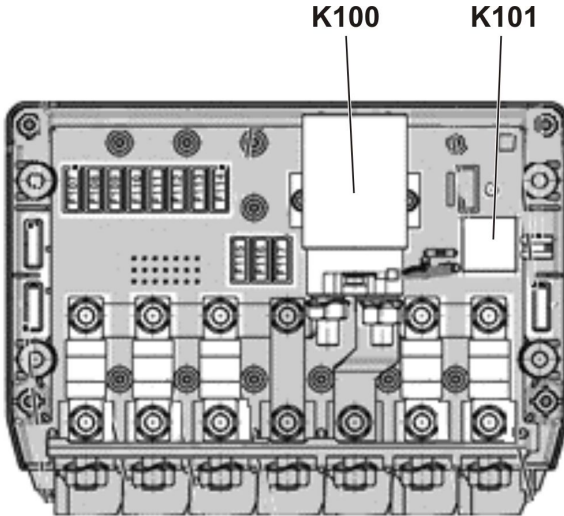

Fuses and relays electrical box inside to the right hand side batteries compartment

Relays in the electrical distribution box corresponding to the I-Start system



W0108044

Relays in the electrical distribution box corresponding to the I-Start system

K100		Main relay.	K101		Automatic Resetting Main Switch (ARMS).
------	---	-------------	------	---	---

Fuses in the electrical distribution box corresponding to the I-Start system

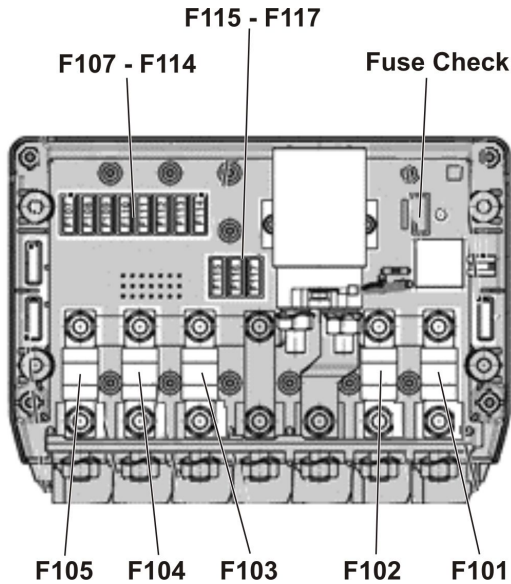





W0108045

Fuses in the electrical distribution box corresponding to the I-Start system							
F101	150 A	B+	Chassis B+.	F102 ₁	100 A	B+	Chassis B+.
F103	150 A	+30	Chassis +30.	F104	150 A	(G)	Alternator B+.
F105 ¹	200 A	(G)	Alternator B+.	F107	5 A	(G)	Alternator B+.

1 Fuse unused.

190 If something happens

Fuses in the electrical distribution box corresponding to the I-Start system (continue)

Fuses in the electrical distribution box corresponding to the I-Start system							
F108 ¹	10 A		Alternator B+.	F109	10 A		Alternator B+.
F110 ¹	10 A		Alternator B+.	F111 ¹	10 A		Alternator B+.
F112 ¹	20 A	B+	Chassis B+.	F113	10 A	B+	Chassis B+.
F114	5 A	B+	Chassis B+.	F115 ¹	15 A	B+	Chassis B+.
F116 ¹	20 A	B+	Chassis B+.	F117 ¹	20 A	B+	Chassis B+.

¹ Fuse unused.

Mini fuse box holder inside to the left hand side batteries compartment

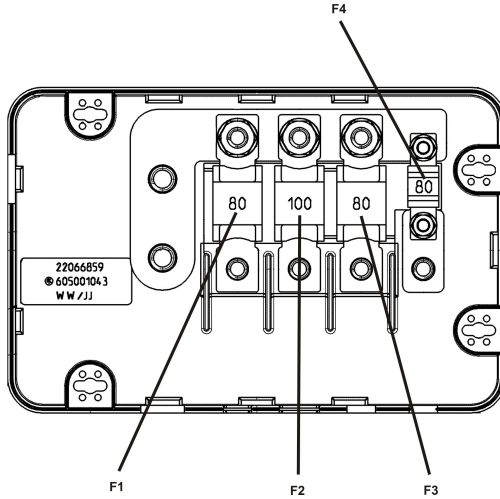

W0108046

Mini fuse box holder							
F1	80A	BODY +30	Body electric center +30.	F2	100A		Inverter.
F3	80A		AC unit.	F4 (mini)	60A		Wheel Chair Lift (WCL).

192 If something happens

Wheels replacement

All Volvo buses have a structural lift points (in both sides) for raise the bus and sustain it without a problem for change any punctured tire. These structural points are marked by a label stick on the bus in the exact location where the structural lift points are located on the bus. Only in this points, the hydraulic jack provided in the bus toolbox must be placed (see also the following section in this manual: “Hydraulic jack”, page 97).

For more information about cautions and wheel replacement procedure on the road, see separate operating instructions: “Wheels and air springs replacement”.

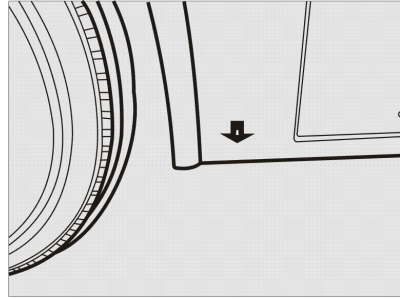

W0089967

Sticker to indicate the location of the bus structural lift points.

 CAUTION
Place the hydraulic jack in a different marked body structure points. So may be a considerably bus body structure damaging risk.

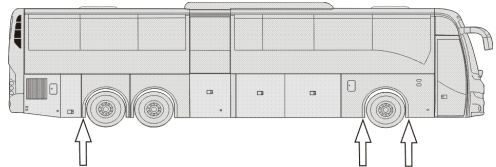

W0089962

Structural lift points localization (symmetrically on both sides, 6x2 configuration).

Valid in models with Wheel Chair Lift (WCL) or without WCL.

Spare wheel

All Volvo buses feature with a wheel of a spare installed from the factory. For the case of the Volvo 9700 US/CAN bus the spare wheel is mounted in the front of the bus under the driving cab floor.

Do the following to access the mechanism that holds the spare wheel:

- 1 Get off the bus and open the front hatch.
- 2 Unhook the spare wheel clamping system.
- 3 Drop the spare wheel base support to the floor.
- 4 Pull the spare wheel to the outside.
- 5 Perform the spare wheel change.
- 6 Install the punctured wheel in the spare wheel base support.
- 7 Lift the spare wheel base support and lock the clamping system.
- 8 Close the front hatch.

Note: You should periodically verify the proper spare wheel pressure inflation and so keep it always ready at any time for when it happens a contingency.

For more information about release or set up the spare wheel, see separate operating instructions: “Wheels and air bellows replacement”.

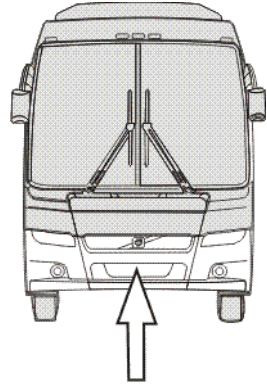

W0089968

Spare wheel location in the bus.

194 If something happens

Recommendations to avoid unnecessary tire wear

- Perform periodic inspections.
- Keep the correct air pressure, checking it against the load.
Note: Always check the pressure with a cold tire.
- Wear increases with increasing speed.
- Do not overload the tires with an unevenly distributed load.
- Do not drive when the tires are unbalanced and with different pressures.
- Check the wheel toe periodically.
- Rotate the wheels regularly.
- Keep the tires free of rocks and other objects on the tread grooves.
- Do not allow the tires to contact solvents, fuels and mineral lubricants.
Note: When mounting the tire on the rim, use only vegetal lubricant.

Recommended tire pressures

Always follow the tire manufacturer's recommendations. When this information is not available, you may temporarily use the tire pressures on the table below as a reference.

Note: The values in the table of tire pressures below come from (Latin American Tire and Rim Association).

Tire / Measurement	Load Index		Inflation pressure - lb/pl ² (bar)										
			75 (5,2)	80 (5,5)	85 (5,8)	90 (6,2)	95 (6,5)	100 (6,9)	105 (7,3)	110 (7,6)	115 (8,0)	120 (8,3)	125 (8,5)
			Load per tire in Kg										
315/80 R22,5	154	D	230	242	254	266	278	289	301	312	324	335	-
	/ 150	S	257	271	284	298	311	324	337	350	362	375	-

196 If something happens

Check of tire wear

Check to make sure the tires are wearing normally.

Compare the wear with the figures, checking for various types of wear.

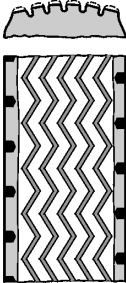
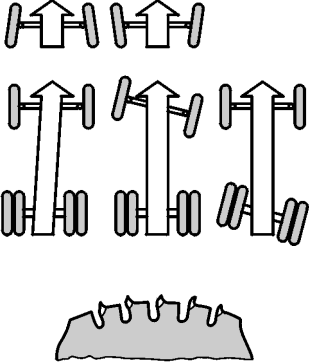
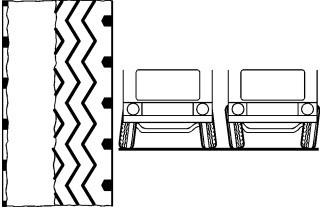
Symptoms	Probable cause	Illustration
Normal wear, fast.	<ol style="list-style-type: none">1 Hill roads with many curves or poorly paved.2 High ambient temperature.3 Improper tire for the usage type.4 Bad driving habits, specially incorrect use of the brakes and high speeds.	
Uneven wear, fast.	<ol style="list-style-type: none">1 Incorrect parallelism of the front wheels.2 Incorrect parallelism between axles.3 Lack of regular inspections.	
Wear, one side.	<ol style="list-style-type: none">1 Excessive positive or negative camber.2 Excessive bending of the axle due to overload.	

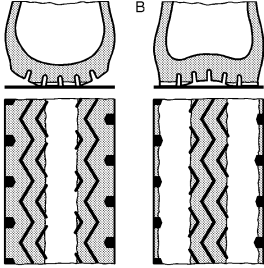
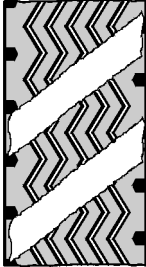
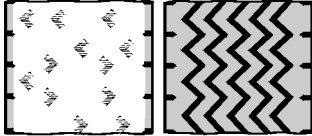
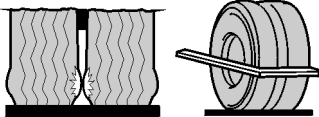
Symptoms	Probable cause	Illustration
<p>Central wear (A) and shoulders wear (B).</p>	<p>Incorrect pressure:</p> <p>A Pressure above recommendation.</p> <p>B Pressure below recommendation.</p>	
<p>Diagonal wear</p>	<ol style="list-style-type: none"> 1 Tire fluctuation. 2 Doubles poorly combined. 3 Erratic operation of the brakes. 4 Heavy loads ("distribution"). 5 Low air pressure or pressure difference between doubles. 6 Tire breakdowns. 	
<p>Fast wear in one of the double assembly tires.</p>	<ol style="list-style-type: none"> 1 Tires with different diameters. 2 Calibration. 3 Bent axle. 4 Overload. 	
<p>Wear due to friction between tires ("double assembly").</p>	<ol style="list-style-type: none"> 1 Inappropriate pressures. 2 Wheels incorrectly centered. 3 Minimum spacing between tires outside the recommended. 4 Incorrect tires type. 	

198 If something happens

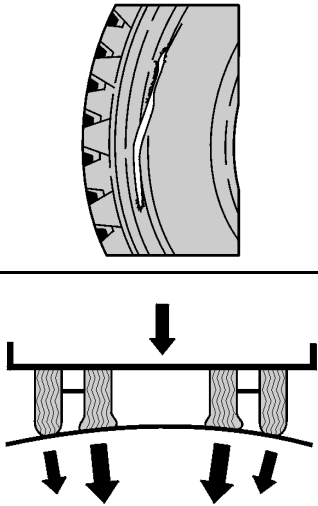
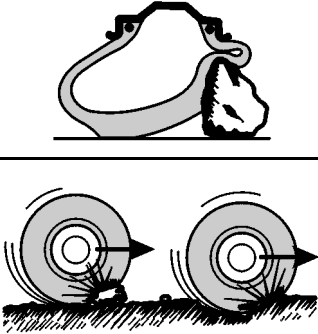
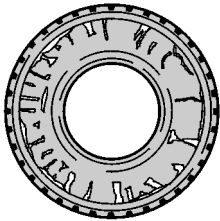
Symptoms	Probable cause	Illustration
<p>Housing broken on the flank.</p>	<ol style="list-style-type: none"> 1 Underinflated tire. 2 Load unevenly distributed on the vehicle. 3 Incorrect double assembly (dimensions, different wears, etc). 4 Bulged roads. 5 Accidental cut. 	 <p>The illustration consists of two parts. The top part shows a close-up of a tire's sidewall with a vertical cut. The bottom part is a schematic diagram showing a horizontal line representing a road surface with two downward-pointing arrows indicating a dip or bulge. Below this, two vertical lines represent tire sidewalls, with arrows pointing down to show the uneven load distribution.</p>
<p>Housing broken due to impacts.</p>	<ol style="list-style-type: none"> 1 Excessive pressure. 2 High speed over big obstacles. 3 Over-charging. 4 Suspension, spring and dampers problems. 5 Pinching by obstacle. 	 <p>The illustration consists of two parts. The top part shows a tire that has been severely damaged, with the tread and sidewall peeling away. The bottom part is a diagram showing two wheels on a vehicle moving from left to right. The front wheel is shown hitting a small obstacle on the ground, with an arrow indicating the direction of travel.</p>
<p>Tire driven while empty or with low pressure.</p>	<ol style="list-style-type: none"> 1 Tire tube failure. 2 Object penetration. 3 Small leakage. 	 <p>The illustration shows a top-down view of a tire mounted on a rim. There is a small, irregular hole in the tread area.</p>

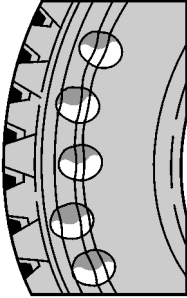
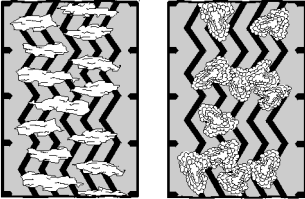
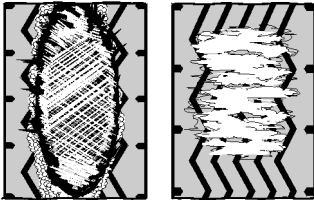
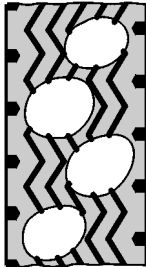
Symptoms	Probable cause	Illustration
Contamination of rubber.	<ol style="list-style-type: none"> 1 Contact of the tire with fuel, lubricants, burnt oil, greases, etc. 	
Multiple cuts.	<ol style="list-style-type: none"> 1 Improper tire for the usage type. 2 Excessive pressure. 3 Gravel roads, poorly kept roads, job sites, mines, etc. 4 Excess of acceleration (“abusive usage”). 	
Localized wear due to brakes.	<ol style="list-style-type: none"> 1 New brakes not broke-in. 2 Abrupt braking. 3 Brake System unbalanced. 	
Wear of wave, bubble, etc. type.	<ol style="list-style-type: none"> 1 Incorrect assemblies. 2 Incorrect matching of double assemblies. 3 Anomalies on the fuel system operation. 4 Pressures too low or unbalanced pressure in double assembly tires. 5 Fatigued dampers and/or springs. 	

200 If something happens

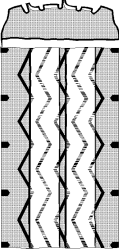
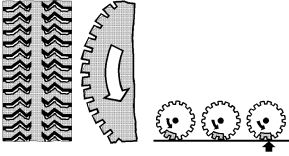
Symptoms	Probable cause	Illustration
Longitudinal grooves.	1 Normal in non-drive wheels, good roads and long travels.	 A vertical cross-section of a tire tread showing a series of parallel longitudinal grooves. The tread is filled with a fine, cross-hatched pattern.
Wear on the grooves edges ("tread").	1 It is normal, depending on the size of the tread; wear increases with increased weight.	 An illustration showing two vertical sections of tire tread on the left, one with a wavy pattern and one with a zigzag pattern. To the right is a cross-section of a gear tooth with a curved arrow indicating its rotation. Below the gear are three smaller gear teeth on a horizontal axis, with an arrow pointing to the right.

General dimensions

9700 US/CAN (6x2 only)

General dimensions for Volvo 9700 US/CAN bus in 6X2 axle configuration only.
 General dimensions valid too: “9700 US/CAN WCL; with Wheel Chair Lift” version.

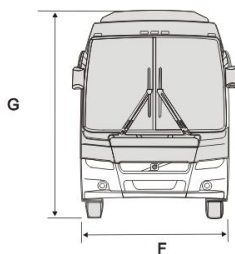
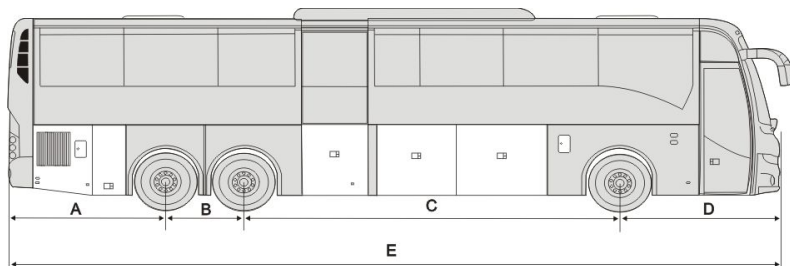

T8061190

General dimensions	
	3 axle (Only); 13.7 m
A	2,780 mm (109 in.)
B	1400 mm (55 in.)
C	6660 mm (262 in.)
D	2,850 mm (112 in.)
E	13,690 mm (539 in.)
F	2600 mm (102 in.) ¹
G	3671 mm (145 in.) ²

1 The dimension doesn't consider the side-view mirrors.

2 The air conditioning equipment is considered.

Electrical system specifications

Voltage	24 V and 12 V (separately circuits).
Number of batteries	4
Connection to ground.....	Negative poles connected to the chassis.
Voltage (1 battery)	12 V
Capacity in 20 hours	105 Ah (consumer and starter batteries).
Electrolyte density	1.3 g/cm ³ (charged). 1.18 g/cm ³ (half charged). 1.09 g/cm ³ (uncharged).
Alternator	150 A x 2
Starting Motor.....	5.6 kW (at +68 °F battery and wiring resistance 8 Ω).

Bulbs for lighting lamps

In the table below, its provide the bulbs for lighting lamps part numbers, when require the order to be replaced.

Light	Rated Power	Volvo P/N
Main beam.	70 W	990037
Dipped beam.	35 W	21008653
Direction indicator, front.	21 W	982558
Direction indicator, rear.	21 W	982558
Fog lamps, front.	70 W	943903
Rear direction indicator lamp (LED).	—	22393677
Reversing lamp (LED).	—	22393680
Central tail lamp (LED).	—	70324417
Rear fog lamps.	21 W	945091
License plate lamp (LED).	—	21135967
Directional side lamp (LED).	2.64 W	22273875
Navigation side light (amber colour).	1.2 W	22358184
Navigation side light (red colour).	1.2 W	22358181
Cockpit upper light.	—	21599992

Engine specifications

Type	D13M
Number of cylinders	6
Maximum wattage	324kW (435hp) at 1700 rpm
Max torque.....	2250 Nm (1650 lb – ft) at 1100 rpm
Cylinder displacement	781 in ³ (12.8 L)
Compression ratio	16:1
Injection sequence.....	1 - 5 - 3 - 6 - 2 - 4
Emissions regulation.....	EPA 17
Fasteners and threads	Metric.

Automatic and automatized gearbox specifications

Transmission ratios

Speed	Reductions, Volvo I-Shift AT2612D	Reductions, Allison 6B500 ¹
1st	14,94:1	3,51:1
2nd	11,73:1	1,91:1
3rd	9,04:1	1,43:1
4th	7,09:1	1,00:1
5th	5,54:1	0.74:1
6th	4,35:1	0.64:1
7th	3,44:1	N.A. ²
8th	2,70:1	N.A.
9th	2,08:1	N.A.
10th	1,63:1	N.A.
11th	1,27:1	N.A.
12th	1,00:1	N.A.
Reverse gear R1	17,48:1	4,80:1
Reverse gear R2	13,73:1	N.A.
Reverse gear R3	4,02:1	N.A.
Reverse gear R4	3,16:1	N.A.

1 Gear ratios do not include torque converter multiplication.

2 Not Apply.

Rear axle specifications

Designation	RS1228 C
Differential type	MS17X
Final drive/ratio	2,64:1
Number of teeth on differential (crown wheel/pinion)	45 / 17

Wheels and tires specifications

Wheels		Tires
Alloy disc wheels (with DuraBrite™ finished).	9.00 x 22.5	315/80R22,5

Front wheels alignment specifications

Toe—in.	1 to 3 mm	
Caster.	$+3^\circ \pm 0.25^\circ$	
Left driver's position vehicle:		
Camber. ¹	LHS	RHS
	+0.4°	-0.2°
King pin inclination.	5.75°	6.5°
Lock angle (°) left and right turn.	Front axle $\pm 1,0^\circ$	
	Inner wheel	Outer wheel (not adjustable)
	50	41.4
	Tag axle (steering) $+1^\circ / -2^\circ$	
	- - -	- - -

¹ Tolerance for vehicles in service at kerb weight= $\pm 0.5^\circ$

Note: Measure with the vehicle empty.

Diesel Emission Fluid (DEF) tank specification

Capacity 60 L

Vehicle identification

Some components that integrate the Volvo 9700 US/CAN bus, for example; the engine, transmission, retarder (*if installed*), drive axle, among the others. may be have a plate or a label used for component identification, where provide a useful information to identify the component, some of these usually data are:

- Manufacturer.
- Manufacturing date and place.
- Serial number.
- Component model.
- Important technical data related with the component configuration.
- Internal own component manufacturer control information.

Below will mention only the most important identification plates or labels (as corresponds) in the bus for familiarization.

Bus identification plate

The Volvo 9700 US/CAN bus Vehicle Identification Number (VIN) its marked on the bus identification plate located in the front lower part of the bus access stairs.

Within its inside border, the identification plate is subdivided into a legal requirement section, as well as three boxes for the chassis number, drive and wheelbase. These latter are not used for buses, only for lorries. The identification plate is located by the driver's seat and contains the following information:

- G.V.W.R (Gross vehicle weight rating), is the maximum allowable total weight of the vehicle.
- G.A.W.R (Gross axle weight rating), is the maximum distributed weight that may be supported by an axle VIN is the same number that can be found on the frame member.
- Maximum gross vehicle weight (kg / lb). The technical weight refers to the weight for which it was built the bus.
- The maximum weight (kg / lb), for the 3rd. axle (auxiliary or drag axle).
- Tires dimensions.
- Rims dimensions
- Cold inflation pressure, is the inflation pressure of the tires before the vehicle is driven and the tires warmed up.
- VIN is the same number that can be found on the frame member.

AXLES/ISSUE		G.A.W.R./TABLE		TIRES/PNEUS	RIMS/ JANTS	COLD INFLATION PRESS./ PRESS. A FROID		SINGLE OR DUAL/ SIMPLE OU DOUBLE
		KG	LBS			KPA	PSI	
FRONT/AVANT	7464	(165 00)		315 / 80R22.5(J)	22.5/9.00	830	(120)	S
REAR/ARRIERE	10024	(221 00)		315 / 80R22.5(J)	22.5/9.00	620	(90)	D
REAR/ARRIERE	4800	(106 00)		315 / 80R22.5(J)	22.5/9.00	500	(85)	S

MANUFACTURED BY: VOLVO BUS CORPORATION
FABRIQUE PAR: VIM

G.V.W.R.: 22407 KG. (49400 LBS)

DATE OF MFG:
DATE DE FAB:

THIS VEHICLE CONFORMS TO ALL APPLICABLE U.S. FEDERAL MOTOR VEHICLE SAFETY STANDARDS AND CANADIAN MOTOR VEHICLE SAFETY REGULATIONS IN EFFECT ON THE DATE OF MANUFACTURE SHOWN ABOVE. CE VEHICULE EST CONFORME A TOUTES LES NORMES QUI LUI SONT APPLICABLES EN VERTU DES REGLEMENTS SUR LA SECURITE DES VEHICULES AUTOMOBILES DU CANADA EN VIGUEUR A LA DATE DE SA FABRICATION INDICIEE CI-HAUT.

VEHICLE IDENTIFICATION NO. TYPE: BUS B1A
NO. IDENTIFICATION VEHICULE

T0015663

212 Technical data

Vehicle Identification Number (VIN)

This is stamped on the chassis C-beam at the right-hand front end of the vehicle, in the wheel arch in front of or behind the front axle.

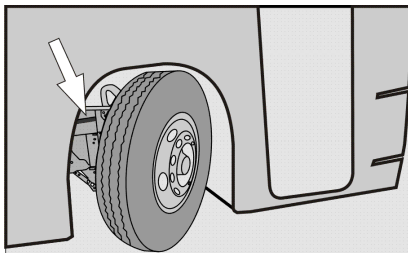

W0089910

The **VIN** number consists of 17 alphabetic and numeric characters, in which are expressed characteristics, vehicle origin place, manufacturing date and place, as well as the manufacturing consecutive number or serial number, among other data.

For example, with this **VIN** number **YV3R7G62151106335** express the following:

YV3	Manufacturer identification.
R7	Chassis version.
G6	Engine version.
2	Brake system type.
1	Check digit (according ISO 13779).
5	Model year.
1	Assembly factory.
106335	Chassis number.

Engine identification labels

For the engine identification has a couple of labels adhered to the right side of the valve cover.

In these labels will find the following information:

- Application type.
- Part number.
- Engine serial number.
- Chassis serial number.
- Information of emission certification.

Also on the engine block count with the following information (which is marked with a punch in the middle of the engine block near the transfer pump):

- Engine control module part number (label adhered on the module).
- Engine type and application.
- Stamped engine serial number.
- Engine certifications.

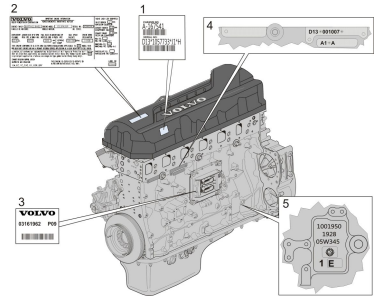

W0089939

Vehicle emission control information label

In the engine compartment, an additional label is placed **(A)**. Which label contains information regarding to vehicle emission control **(B)**. This label is located as shown in the image **(A)**.

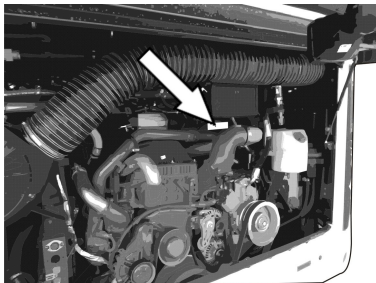

W0101024

(A) Vehicle emission control label location inside the engine compartment.

VEHICLE EMISSION CONTROL INFORMATION	
VOLVO BUS CORPORATION A DIVISION OF VOLVO GROUP	
	
VEHICLE FAMILY IDENTIFICATION: FVPT2V0VCF00	VIN3CET2V221F5171421
REGULATORY SUB-CATEGORY: Heavy duty vocational vehicle.	
DATE OF MANUFACTURE: 02/2015	
VEHICLE EMISSION CONTROL SYSTEM: LRR4	
THIS VEHICLE COMPLIES WITH U.S. EPA REGULATIONS FOR MY 2015 HEAVY DUTY VEHICLES.	
22204124	

W0101015

(B) Vehicle emission control label information.

I-Shift transmission identification plate (if installed)

The type designation and serial number of the **I-Shift** transmission are marked on the identification plate located at the top of the transmission.

The information provided in the plate is as follows:

- Transmission model.
- Service type.
- Part number.
- Serial number.

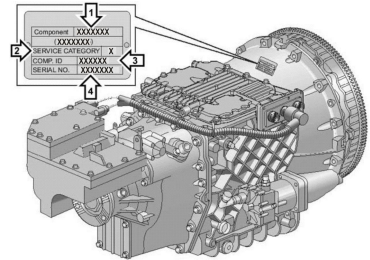

W0091964

Allison transmission (identification plate)

The transmission series, the transmission model and the serial number are punched on the plate located in the left side of the transmission.

The information provided on the plate as follows:

- Transmission series and model.
- Serial number.
- Part number.

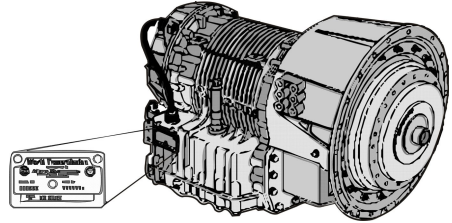

W0095903

Rear axle identification plate

The plate is located on the carrier housing in the drive axle.

The information provided in the plate is as follows:

- Carrier model.
- Carrier ratio.
- Category or service type.
- Drive axle part number.
- Carrier assembly number.
- Chassis serial number assigned.
- Axle serial number.

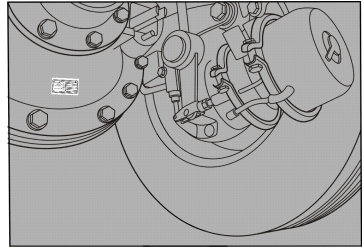

W0089943

Retarder identification plate (if installed)

Retarder serial number and its version are stamped on rear left side of retarder housing. The information provided in the plate is as follows:

- Retarder model.
- Serial number.
- Manufacturing date.
- Part number assigned by “VOITH”.
- Part number assigned by “Volvo”.

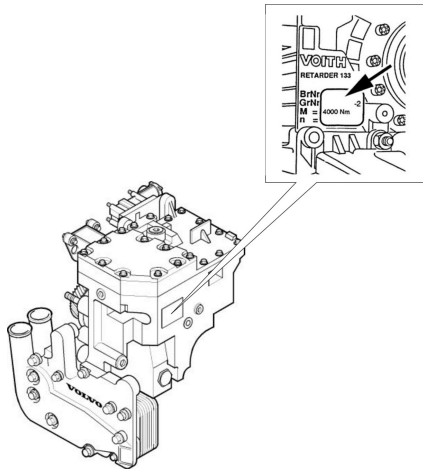

Service intervals

Regular servicing in accordance with the special service schedule is required to maintain the bus to its original specifications throughout its service life.

Carry out all servicing and maintenance of the bus at a Volvo workshop or, for Prevost support vehicles, in Prevost service center/provider.

These workshops have the trained personnel, special tools and necessary service literature that are vital in ensuring high quality of servicing. This quality also depends on the use of Volvo Original parts, which are of identical quality to the components installed at the Volvo manufacturing facility.

For service intervals, see the separate service literature to know this intervals. Refer to the separate service information related to the 9700 BSTAR — NAM-SPEC and B13R EM-USA17 model.

Note: When washing the bus, only use agents that are intended for this purpose, see separate operating instructions: “Interior maintenance” and “Exterior maintenance”.

A

A/C Controller, multiplexing system..... 71

Accelerator pedal
deactivated..... 20

Additional fire detection system (multiplexed)..... 154

Adjusting external rear view mirrors..... 49

Air conditioning test switch..... 45

Allison automatic transmission..... 57

Allison identification plate..... 216

Allison transmission mode function..... 59

Allison transmission shifter..... 58

Alternative towing procedure..... 152

ARMS (Automatic Reset Main Switch)..... 136

ARMS failure detection..... 136

Assistance and rescue on highway (VAS, Volvo Action Service)..... 144

Audio system..... 42, 86

Audiovisual control panel..... 85

Audiovisual system..... 84

Audiovisual system..... 84

Automatic and automatized gearbox specifications..... 205

Automatized Fire Extinguished System (AFES) manual discharge..... 91

Automatized Fire Extinguished System..... 90

B

Batteries charger..... 138

Batteries cut-off switch..... 6, 164

Blocking valve..... 65

Body electric circuit fuses..... 183

Body electric circuit relays..... 182

Body fuses..... 183

Body fuses, continue..... 184–185

Body relays..... 182

Bulb replacement..... 167

Bulbs for lighting lamps..... 203

Bulk charge time estimation..... 139

Bus electrical center..... 171

Bus identification plate..... 211

Bus interior and exterior cleaning and maintenance..... 104

Bus structural lift points..... 192

Bus towing considerations..... 151

C

Central locking..... 41

Change the batteries..... 158

Chassis electric circuit fuses..... 175

Chassis electric circuit relays..... 172

Check the warning lights..... 105

Checking before driving..... 103

Checking of tire wear..... 196

Closing the bus..... 9

Combined cruise control and speed limiting..... 125

Compensating for differences in the wear of the brake pads..... 69

Control pendant (for Wheel Chair Lift, WCL equipment)..... 83

Critical emissions related maintenance..... 131

Cruise control activation..... 119

Cruise control deactivation. 120

D

Daily inspection. 106
 Dashboard. 18
 Destination sign control. 72
 Destination sign lighting. 39
 Destination sign, Innova. 73
 Destination sign,
 Mobitec. 74
 Diesel Emission Fluid (DEF)
 tank specification. 209
 Diesel Exhaust Fluid
 (DEF) level related
 messages. 112
 Diesel Exhaust Fluid (DEF)
 tank. 111
 Diesel exhaust fluid
 gauge. 27
 Diesel Particulate Filter
 (DPF) regeneration
 required icon. 129
 Differential lock. 36
 Directional indicator, dipped
 / full beam changer. 53
 Door brake general
 deactivation. 51
 Door brake switch. 46
 Doors and hatches. 7
 Doors and hatches
 configurations. 10
 Doors. 7
 Driver blower. 40
 Driver compartment
 lighting. 38
 Driver display. 24
 Driver window heating. 40
 Driver's area. 14
 Driver's area. 14
 Driver's responsibility. 1
 Driver's seat. 15
 Driver's seat features
 label. 16
 Driving in cold weather. 142

E

EBS, Electronically-
 controlled braking
 system. 68
 Economy driving. 141
 Electrical fault general
 lookup. 170
 Electrical system
 specifications. 202
 Electrically heated rear view
 mirrors. 40
 Emergency and safety
 equipment. 88
 Emergency and safety
 equipment. 88
 Emergency brake. 64
 Emergency exits —
 doors. 100
 Emergency stop switch. 32
 Emergency stop. 5
 Emergency window in use
 indicator lamp. 44
 Emergency windows. 102
 Emission green house gas
 component warranty. 131
 Engine block heater. 113
 Engine control panel in
 engine bay. 99
 Engine coolant system fluid
 level. 107
 Engine coolant temperature
 gauge. 23
 Engine identification
 labels. 213
 Engine idle speed
 adjustment. 117
 Engine oil level. 106
 Engine specifications. 204
 Entering the bus. 4
 Exhaust Aftertreatment
 System (EATS)
 components. 127
 Exhaust Aftertreatment
 System (EATS),
 warnings. 128
 External air supply
 connection. 96

F

Faults and warnings..... 19
 Fire extinguisher..... 89
 First aid kit..... 95
 Front wheels alignment
 specifications..... 208
 Fuel gauge..... 24
 Fuel replenishment
 warnings..... 110
 Fuel replenishment..... 109
 Fuse boxes inside
 to the batteries
 compartments..... 187
 Fuses and relays electrical
 box inside to the right
 hand side batteries
 compartment..... 188
 Fuses chassis..... 181
 Fuses FH1 section..... 176
 Fuses FH2 section..... 177
 Fuses FH3 section..... 178
 Fuses FH4 section..... 179
 Fuses FH5 section..... 180
 Fuses FH6 section..... 180
 Fuses in the electrical
 distribution box
 corresponding to the I-Start
 system..... 189
 Fuses in the right hand
 side batteries compartment
 electrical box..... 189–190

G

General dimension, Volvo
 9700 US/CAN (6X2)
 bus..... 201
 General switch..... 6
 Ground stud for jump start
 batteries..... 163
 Guide or driver
 microphone..... 87

H

Half-light lighting..... 38

Hatches and doors opened
 warning..... 10
 Hazard warning lights..... 31
 Headlamp bulb
 replacement..... 167
 Headlamps..... 167
 Headlight washers..... 54
 High brake temperature
 warning..... 70
 High engine exhaust system
 temperature..... 130
 Hill start assistance..... 36
 Horn..... 17
 Hydraulic jack..... 97
 Hydraulic level fluid for the
 engine coolant fan..... 107

I

I-Shift transmission
 identification plate..... 215
 I-Shift transmission lever
 selector..... 55
 I-Shift transmission pad
 selector..... 56
 I-Start system batteries
 compartments decals..... 133
 I-Start system failure
 detection..... 134, 166
 I-Start system power
 relays..... 137
 I-Start system..... 132
 If something happens..... 144
 If the engine is not
 working..... 146
 Ignition switch..... 47
 Increasing load on the drive
 axle (bogie lift)..... 35
 Indicator lights on after
 the engine has been
 started..... 116
 Instrument cluster..... 22
 Instrument panel lamps and
 symbols..... 28
 Instruments and controls..... 19
 Interior equipment..... 75
 Interior equipment..... 75

Introduction 1

J

Jump start batteries
procedure warnings. 162

Jump start batteries
procedure. 161

K

Key and cylinder
replacement. 3

Keys. 2

Kneeling system. 33

L

LED lighting stripe. 78

Level control. 34

Liaison communication
system 81

License plate lighting lamp
replacement. 169

License plate lighting. 169

Lighting Switch 30

Lights switch. 30

M

Main/dipped beam, switching
(lights on) 53

MCM (Master Control
Module) service switch. 45

Mini fuse box holder inside to
the left hand side batteries
compartment. 191

Mini fuse box holder. 191

N

Night lighting. 37

O

Open door brake
deactivation. 51

Open door brake. 50

Opening service door from
the outside. 42

Opening the bus from
inside. 8

Other body electric circuit
fuses. 186

Other body electric circuit
relays. 182

Other body fuses. 186

Other body relays. 182

Other chassis electric circuit
fuses. 181

Other chassis electric circuit
relays. 174

P

Park pilot system. 92

Parking brake mechanical
releasing. 156

Parking brake on disc brakes
mechanical releasing. 157

Parking brake. 63

Passenger AC 110 V power
outlets circuit breaker. 80

Passenger compartment
lighting. 37

Passenger's individual
lighting. 38

Passengers AC 110 V power
outlets in the passengers
seats. 79

Passengers panel. 78

Passengers sliding seats. 82

Passengers thermometer
and clock display. 77

Pneumatic system pressure
gauge. 25

Position lights. 39

Power steering hydraulic oil
level. 107

Power steering. 126

Prioritized brake function. 20

Protection against batteries
 discharge..... 5
 Punctured air bellows..... 148
 Punctures..... 148

Q

QR code labels. 143

R

Rear axle identification
 plate..... 217
 Rear axle specifica-
 tions..... 206
 Rear lights..... 168
 Recommendations to avoid
 unnecessary tire wear. 194
 Recommended tire
 pressures. 195
 Relays chassis..... 174
 Relays FH2 section. 173
 Relays in the electrical
 distribution box
 corresponding to the I-Start
 system. 188
 Relays in the right hand
 side batteries compartment
 electrical box..... 188
 Relays KH1 section. 172
 Relays KH2 section. 173
 Relays KH3 section. 173
 Release the parking brake
 with air from the bus
 tires. 155
 Retarder enabled. 37
 Retarder identification
 plate..... 218
 Retarder overheating. 62
 Retarder use..... 122
 Retarder..... 61, 121
 Roof hatches 13
 Roof hatches. 101

S

Safe driving. 140

Safety information. 11
 Safety. 145
 Selective Catalyst Reduction
 (SCR). 165
 Service brakes use..... 67
 Service brakes..... 66
 Service intervals..... 219
 Shutdown the engine. 115
 Some advice for driving..... 140
 Spare wheel. 193
 Speed limiting. 124
 Speedometer. 26
 Start a cold engine. 114
 Starter and consumer
 batteries failure
 detection. 135
 Starting a warm engine. 115
 Starting and driving 103
 Starting assistance. 160
 Starting the engine. 114
 Steering wheel
 adjustment..... 52
 Stop at the next bus stop
 message. 21
 STOP message..... 21
 Sun visor. 41
 Switches into the electrical
 center..... 45
 Switches. 32

T

Tachometer..... 26
 Tail lamp replacement. 168
 Technical data..... 201
 Telematics Gate Way
 system 81
 Tire inflation valve. 96
 Tire Pressure Monitoring
 System (TPMS) display. 94
 Tire Pressure Monitoring
 System (TPMS)..... 93
 Toilet activation. 41
 Toilet. 76
 Toolbox..... 98
 Towing..... 149

Traction Control System
(TCS)..... 35
Transmission overheat-
ing..... 60
Transmission ratios..... 205
Trash bin; rear..... 76
Turbo pressure gauge..... 23

V

Vehicle emission control
information label..... 214
Vehicle Identification
Number (VIN)..... 212
Vehicle identification..... 210
Video system..... 85

W

Warning message..... 21

Warning triangle..... 95
Wheel Chair Lift (WCL)
system indicator light..... 44
Wheel Chair Lift (WCL)
system; (optional)..... 43
Wheels and tires
specifications..... 207
Wheels replacement..... 192
Windscreen washers..... 54
Windscreen wipers..... 54
Windscreen wipers,
windscreen headlight
washer..... 54
Windshield washer fluid..... 108

X

Xenon lights..... 168

VOLVO

Volvo Bus Corporation

Göteborg, Sweden