

# **Driver's Handbook**

## **VOLVO D13J Engine Operator's Manual**

PREVH, PREVX, B13R, 9700 USCAN

**VOLVO**

# Foreword

This manual contains information concerning the safe operation of your vehicle. It is extremely important that this information is read and understood before the vehicle is operated. This manual also contains a considerable amount of information concerning the vehicle, such as vehicle identification, Preventive Maintenance recommendations and a log for your service records. Please keep this in the vehicle at all times. Information from other component manufacturers is supplied in separate manuals in the Owners Package.

Illustrations in this manual are used for reference only and may differ slightly from the actual vehicle. However, key components addressed in this document are represented as accurately as possible.

The National Highway Traffic Safety Administration (NHTSA) and Prevost should be informed immediately if you believe that the vehicle has a defect that could cause a crash, injury or death.

Contact NHTSA by calling the Auto Safety Hotline at 1(888) 327-4236, by writing to NHTSA, U.S Department of Transportation, Washington, DC 20590, by TTY at 1 (800) 424-9153, or visit their web site at <http://www.safercar.gov>

## **Volvo Bus Corporation**

Göteborg, Sweden

**Order number: 89166953**

©2014 Volvo Bus Corporation, Göteborg, Sweden

All rights reserved. No part of this publication may be reproduced, stored in retrieval system, or transmitted in any forms by any means, electronic, mechanical, photocopying, recording or otherwise, without the prior written permission of Volvo Bus Corporation

---

# Contents

<b>VOLVO Engines</b> .....	<b>1</b>
Information For the Owner .....	1
General .....	3
Federal Emission Requirements .....	4
Tampering with exhaust emission control systems Prohibited .....	5
Noise Emissions .....	5
Safety Information .....	11
Proper Maintenance Procedure .....	11
During Maintenance.....	13
Compressed Air and Water .....	14
Asbestos Information .....	14
Fluid Penetration.....	14
Injury Prevention .....	15
Burn Prevention .....	15
Fire or Explosion Prevention .....	17
Engine Damage Prevention.....	23
Before Starting the Engine.....	23
Engine Starting.....	23
Electric and Electronic Systems.....	25
Reporting Safety Defects .....	26
USA.....	26
Canada.....	27
On-Call Assistance.....	27
Introduction.....	27
Fuel .....	28
Engine Oil .....	29
Engine Operation .....	30
Engine Overview, D13J Left Side View .....	33
Engine Overview, D13J Right Side View .....	34
Exhaust Emissions and Aftertreatment Diesel Particulate Filters (DPFs).....	35
Exhaust Aftertreatment System .....	37
DPF Systems .....	39
Selective Catalytic Reduction (SCR) .....	40
Aftertreatment Hydrocarbon Dosing System.....	43
Diesel Exhaust Fluid (DEF).....	44
Aftertreatment Control Module (ACM).....	46
Smart NOx Sensor .....	47
Aftertreatment Inducement Screens.....	49
Aftertreatment DEF Tank Level - Driver Warning & Inducement.....	49
Aftertreatment DEF Quality - Driver Warning & Inducement .....	50
Aftertreatment Tampering - Driver Warning & Inducement .....	52
Misfilling Diesel or Aftertreatment DEF Tanks.....	54
Warranty and Maintenance .....	55
Exhaust Aftertreatment System Maintenance.....	55
Emissions Maintenance .....	55

---

Engine Maintenance Intervals.....	55
Engine Gaseous Emission Control Systems .....	56
Emissions Control System Warranty .....	57
Engine Gaseous Emissions Control System Warranty .....	58
Federal Emission Requirements .....	59
Emission Control System Warranty — California.....	59
Emissions Control System Warranty .....	62
Emission Green House Gas Component Warranty (If Equipped) .....	64
Engine Brake.....	65
Engine Components, Service Schedules.....	66
Cooling System.....	67
General Coolant Information.....	67
Regular Coolant Change Interval.....	70
Extended Life Coolant Change Interval .....	70

---

# Safety Information

**IMPORTANT:** Before driving this vehicle, be certain that you have read and that you fully understand each and every step of the driving and handling information in this manual. Be certain that you fully understand and follow all safety warnings.

IT IS IMPORTANT THAT THE FOLLOWING INFORMATION BE READ, UNDERSTOOD AND ALWAYS FOLLOWED.

The following types of advisories are used throughout this manual:



## DANGER

Danger indicates an unsafe practice that could result in serious personal injury or death. A danger advisory banner is in **white** type on a **black** background with a **black** border.



## WARNING

Warning indicates an unsafe practice that could result in personal injury. A warning advisory banner is in **black** type on a **gray** background with a **black** border.



## CAUTION

Caution indicates an unsafe practice that could result in damage to the product. A caution advisory is in **black** type on a **white** background with a **black** border.

**Note:** Note indicates a procedure, practice, or condition that must be followed in order for the vehicle or component to function in the manner intended.

---

## Information For the Owner

If there are questions on the maintenance and performance of your vehicle, please discuss them with your Prevost Service Manager or Prevost Service Center. Your authorized Prevost Service Center is required to have trained mechanics, special tools and spare parts to fully service your vehicle.

In addition to this Operator's Manual, there may be additional instruction/operators manuals supplied by component manufacturers. These manuals are placed in the Owners Package and placed in the vehicle. Be sure to read all the manuals thoroughly before operating the vehicle.

Also, various safety labels may be placed on components by the component manufacturer. Be sure to read and follow these labels to prevent damage to the vehicle, personal injury or even death.

Information in this manual refers to VOLVO components and VOLVO drivetrain. For detailed information on non-VOLVO drivetrains contact your nearest Prevost Service Center.

Establish a Preventive Maintenance Program with the help of your Prevost Service Center/ Provider. A Preventive Maintenance Program makes it possible to maximize the amount of time your vehicle is up and running, resulting in longer component life. This makes for a safer vehicle by reducing any mechanical failures due to poor maintenance practices.

**Note:** Federal law requires manufacturers to notify owners of its products in the event of a Federal Motor Vehicle Safety Standard or if a safety related defect is discovered. If you are not the original owner of this vehicle, please notify us about the change in ownership at the address below or through an authorized Prevost Service Center. This is the only way we will be able to contact you if necessary.

Prevost Warranty Departement  
850 Chemin Olivier  
St-Nicolas, Qc  
G7A 2N1  
Canada  
Fax: 418-831-930

## 2 VOLVO Engines

---

This Operator's Manual covers all VOLVO vehicles manufactured by Prevost or Volvo Bus, including the whole chassis and all VOLVO manufactured components. For specific maintenance information on vendor components, manufactured by, for example: Fuller, Meritor, etc., see the respective manufacturers service and maintenance literature.

This manual, together with manuals for specific components contain important information to be able to operate this vehicle safely. They contain advice and instructions which will enable you to get the operating economy and performance that you expect from this quality vehicle.

All information, illustrations and specifications contained in this manual are based upon the latest product information available at the time of publication. If any questions arise concerning the current status of Federal or state laws, the appropriate Federal or state agency should be contacted.

**Note:** Illustrations are used for reference only and may differ slightly from the actual vehicle, however, key components addressed in this manual are represented as accurately as possible.

VOLVO Bus Corporation reserves the right to make changes at any time or to change specifications or design without notice and without incurring obligation.



---

## **General**

### *USA*

#### USA

The Federal Clean Air Act, Section 203 (a) (3), states the following concerning the removal of air pollution control devices or modification of a certified engine to a non-certified configuration:

CAA, Section (a) (3) (A) prohibits any person from removing or rendering inoperative any emission control device or element of design installed on or in a motor vehicle or motor vehicle engine in compliance with federal regulations under the Clean Air Act prior to the sale and delivery of the vehicle to the ultimate purchaser. The statute also prohibits any person from knowingly removing or rendering inoperative any emission control device or element of design after sale and delivery of a vehicle or engine to the ultimate purchaser. Any person who violates these provisions either by removing or rendering inoperative emissions control devices prior to the sale or delivery of an engine or vehicle to an ultimate purchaser, or by knowingly removing or rendering inoperative such devices after the sale and delivery of an engine or vehicle to an ultimate purchaser, can be subject to penalties of up to \$3,750 per incident. Any dealer or manufacturer who violates these provisions can be subject to penalties of up to \$37,500 per incident.

### *Canada*

The same conditions that apply in the USA apply to Canada, with one exception. After the vehicle is sold to a retail customer, that is, the end user, the jurisdiction controlling the emission control devices becomes the province in which the vehicle is licensed. No changes should be made that render any or all of the devices inoperative.

Should the owner/operator wish to make any changes to the emission control devices, check with the provincial authority before making any such changes.

### *Mexico*

The same conditions that apply in the USA apply to Mexico. Refer to the Mexican Federal Law for Emission Control which adheres to EPA regulations. No changes should be made that render any or all of the emissions control devices inoperative.

Should the owner/operator wish to make any changes to the emission control devices, check with the state authority before making any such changes.

## **4 VOLVO Engines**

---

### **Federal Emission Requirements**

This section covers the requirement of the United States Clean Air Act which states:

The manufacturer shall furnish with each new motor vehicle or motor vehicle engine such written instructions for the maintenance and use of the vehicle or engine by the ultimate purchaser as may be reasonable and necessary to assure the proper functioning of emission control devices and systems.

This section also covers the requirements of the emissions regulations promulgated under the Motor Vehicle Safety Act in Canada.

---

## Tampering with exhaust emission control systems Prohibited

The Federal Clean Air Act prohibits the removal or rendering inoperative of any device or element of design installed on or in a motor vehicle or motor vehicle engine in compliance with Federal Emission Regulations by:

- 1 Any person prior to its sale and delivery to the ultimate purchaser, or
- 2 Any manufacturer or distributor after its sale and delivery to the ultimate purchaser, or
- 3 Any person engaged in the business of repairing, servicing, selling, leasing, or trading motor vehicles or motor vehicle engines following its sale and delivery to the ultimate purchaser, or
- 4 Any person who operates a fleet of motor vehicles following its sale and delivery to the ultimate purchaser.

**Note:** For specifics of the prohibited vehicle/engine modifications refer to the Volvo Bus or Prevest documentation.

## Noise Emissions

Prevest warrants to the first person who purchases this vehicle for purposes other than resale and to each subsequent purchaser, that this vehicle as manufactured by Prevest was designed, built and equipped to conform, at the time it left the control of Prevest, with all applicable U.S. EPA Noise Control Regulations.

This warranty covers this vehicle as designed, built and equipped by Prevest, and is not limited to any particular part, component or system of the vehicle manufactured by Prevest Defects in design, assembly or in any part, component or system of the vehicle as manufactured by Prevest, which, at the time it left the control of Prevest caused noise emissions to exceed Federal standards, are covered by this warranty for the life of the vehicle.

## 6 VOLVO Engines

---

### *Noise Control System, Operator Inspection and Maintenance Requirements*

A Noise Control System Maintenance Log is located in this manual. This log should be used to document all Noise Control System related maintenance, whether the maintenance results from a specific noise control system inspection, or a deficiency identified during another general maintenance event.

If additional log space is needed, further entries may be added on a separate sheet of paper. Store these additions with the main log to preserve a comprehensive record. It is recommended that copies of all noise emissions related maintenance invoices be retained.

The following Noise Control System inspection and maintenance instructions contain suggested maintenance intervals. These intervals may need adjustment in order to best accommodate the specific vehicle usage. The following instructions only concern Noise Emissions related items and do not address or modify any general vehicle maintenance requirements.

The following elements make up the Noise Control System:

- Noise Shielding and Insulation Devices
- Cooling System
- Exhaust System/DPF System
- Air Intake/Air Induction System
- Engine Control, EGR and Fuel Systems
- Selective Catalytic Reduction (SCR)

## *Tampering with Noise Control System*

Federal law prohibits the following acts or the causing thereof:

(1) The removal or rendering inoperative by any person, other than for purposes of maintenance, repair, or replacement, of any device or element of design incorporated into any new vehicle for the purpose of noise control prior to its sale or delivery to the ultimate purchaser or while it is in use;

or

(2) the use of the vehicle after such device or element of design has been removed or rendered inoperative by any person.

Among the acts that constitute tampering are the acts listed below:

- Removal, or rendering inoperative, of any exhaust components, including mufflers, heavy or double-wall exhaust tubing, flexible tubing or exhaust pipe clamping.
- Removal, or rendering inoperative, of the temperature-modulated cooling fan system.
- Removal of the cooling fan shroud.
- Removal, or rendering inoperative, of the air cleaner or air intake in-line silencer.
- Removal or rendering inoperative any vehicle body mounted sound insulation components.
- Removal, or rendering inoperative, of the engine speed governor so as to allow engine speed to exceed the manufacturers specifications.
- Removal of splash shields located inside the wheel housings.
- Removal of engine block shields.
- Removal of engine crankcase shields or insulation.
- Removal of insulated rocker arm covers.
- Removal of transmission noise shields.

## *Noise Shielding and Insulation Devices*

### **Maintenance**

Ensure sound shielding and insulating devices are intact. Inspect components for damage. Primary system components requiring noise related inspection include the engine compartment insulating materials (including engine covers, hatches insulation) wheel housings, fenders, and body panels. Inspect all related fasteners, brackets, and clamps for damage and tightness.

## 8 VOLVO Engines

---

### Regulatory Compliance

Acts that constitute tampering with the Noise Shielding and Insulation Devices:

Removing or rendering inoperative the engine and/or transmission noise deadening panels, shields or insulating materials.

Removing or rendering inoperative any vehicle body mounted sound insulation components and/or shields (fender shields, skirts, wheel housing splash shields, etc.).

### Cooling System



#### WARNING

DO NOT work near the fan with the engine running or the ignition in the ON position. The engine fan can engage at any time without warning. Anyone near the fan when it turns on could be seriously injured.

### Maintenance

Visually inspect cooling system components for damage, and/or misalignment.

Primary system components requiring noise related inspection include fan blades, fan clutch, fan shroud, fan ring, and recirculation shields. Check fan blades, fan ring, fan shroud, belt tensioner and recirculation shields for any damage. Verify that fan blades clear the fan ring. Inspect all related fasteners, brackets, and clamps for damage and tightness. Confirm operation of temperature modulated fan clutch.

### Regulatory Compliance

Acts that constitute tampering with the Cooling System:

Removing or rendering inoperative cooling system components (such as the temperature modulated fan clutch, fan shroud, fan ring, recirculation shields, etc.).

---

## *Exhaust System*

**WARNING**

Hot engine! Avoid all movable parts or hot engine parts, exhaust gases, and/or fluids. A hot engine, exhaust, and/or fluids can cause burns.

### **Maintenance**

Make sure the exhaust system is intact. Inspect for damage, misalignment and/or leakage. Primary system components requiring noise related inspection include exhaust manifold, turbocharger, and all exhaust system (rigid and flexible) piping. Closely check the system for exhaust leaks. Special attention should be given to all welds, seams, gaskets, support points, clamps, couplings and connections.

Inspect all exhaust system fasteners, brackets, and clamps for damage and tightness.

### **Regulatory Compliance**

Acts that constitute tampering with the Exhaust System:

Removing or rendering inoperative exhaust system components (such as the pipes, clamps, etc.).

## *Air Intake/Air Induction System*

### **Maintenance**

Make sure the air intake system is intact. Inspect components for damage, misalignment and/or leakage. Primary system components requiring noise related inspection include the air cleaner housing, air cleaner element, turbocharger, charge air cooler and intake manifold.

Also inspect all ducts, pipes, hoses, tubing and elbows used to interconnect the system. Special attention should be given to all welds, seams, gaskets, support points, clamps, couplings and connections.

Inspect all intake system fasteners, brackets, and clamps for damage and tightness.

# 10 VOLVO Engines

---

## **Regulatory Compliance**

Acts that constitute tampering with the Air Intake/Air Induction System:

Removing or rendering inoperative air intake/induction system components (filter, filter housings, ducts, etc.).

## *Engine Control, EGR and Fuel Systems*

Acts that constitute tampering with Engine Control, EGR and Fuel Systems:

Removing rendering inoperative, or modifying the engine control system such as the ECU, EGR system components, or fuel system components, in order to allow the engine to operate outside of the manufacturers specifications is not allowed and violates both warranty and legislation.



---

## Safety Information

### Proper Maintenance Procedure



#### **DANGER**

Before working on a vehicle, set the parking brakes, place the transmission in neutral, and chock the wheels. Failure to do so can result in unexpected vehicle movement and can cause serious personal injury or death.



#### **DANGER**

Exhaust gases contain carbon monoxide. Always run the engine outdoors or use a properly vented exhaust hose. Prolonged or excessive exposure may cause serious illness or death.



#### **DANGER**

Never operate the engine in an area where hydrocarbon vapors (gasoline, for example) are present or are suspected to be present. Hydrocarbon vapors can enter the air intake and over speed the engine, causing severe engine damage and/or an explosion and fire. Serious personal injury or death could occur.



#### **DANGER**

Never try to operate or work on this vehicle while under the influence of alcohol. Your reflexes can be affected by even a small amount of alcohol. Drinking and operating this vehicle can lead to an accident, causing serious personal injury or death.

## 12 VOLVO Engines

---



### **WARNING**

DO NOT attempt to repair or service this vehicle without having sufficient training, correct service literature and the proper tools. Failure to follow this could lead to personal injury or making your vehicle unsafe.



### **WARNING**

Diesel engine exhaust and some of its constituents are known to the state of California to cause cancer, birth defects and other reproductive harm.

---

## During Maintenance

Remove key from ignition while working on vehicle or engine.

**DO NOT allow unauthorized personnel on, around or in the vehicle when maintenance or repair is being performed.**

- When operating the engine in an enclosed area, vent the exhaust to the outside.
- Before servicing your vehicle, apply the parking brakes and adequately chock the wheels in order to prevent unintended vehicle movement. If the service procedure requires the parking brakes to be released recheck to ensure that the wheels are adequately chocked to prevent any forward and/or rearward movement.
- DO NOT use combustibile substances in or around the engine either during repair or maintenance or when running the engine.
- DO NOT wear loose clothing or jewelry that can catch or get snagged by parts or moving components on the engine. Also wear all protective equipment required by the job conditions, such as protective glasses, hearing protection, etc.
- Make certain that all protective covers and guards are in place and properly secured.
- Never put maintenance fluids into glass containers since glass containers can break.
- Report all problems in a timely manner before they threaten the safety of operating the vehicle.
- DO NOT work on the engine while it is running.
- Make sure protective locks and covers are in their proper place.
- DO NOT use high amperage electronic starting devices for jump-starting the engine. Rely on conventional battery charging for charging the batteries or jump-start with the help of a start battery.
- DO NOT attempt repairs you do not understand. If you do not have the proper tools/knowledge to perform the repairs correctly, Prevost recommends contacting your nearest Prevost Service Center for all necessary repairs.
- When starting an engine after repairs have been made to the fuel or injection system, prepare equipment for shutting off the engine intake air and/or fuel supply (to stop the engine), in case there is an over speed on start-up.
- Start the engine only from the driver seat. Never operate the starter motor across the starter terminals or the batteries as this could bypass the engine neutral-start system as well as causing damage to the electrical or electronic systems.

### Compressed Air and Water



#### DANGER

Compressed air can cause serious personal injury. When using compressed air for cleaning, wear a protective face shield, protective clothing and protective shoes. Pressurized water could cause particles and/or hot water to be sprayed in your direction and cause personal injury. The maximum air pressure must be below 30 psi (200 kPa) for cleaning purposes.

### Asbestos Information

**Note:** The VOLVO engine and replacement parts for it shipped from the factory are asbestos free. VOLVO recommends the use of only genuine VOLVO spare parts.

Never use any parts that contain or are thought to contain asbestos. Exposure to asbestos fibers can create serious health risks, including death.

### Fluid Penetration



#### DANGER

Always use a piece of paper or cardboard when checking for a leak. Escaping fluid under high pressure, even a pin-hole sized leak, can penetrate body tissue, causing serious injury or death. If fluid is injected into your skin, immediate treatment must be administered by a doctor familiar with this type of injury.

## Injury Prevention

### Burn Prevention

#### *Engine Parts*



#### **WARNING**

Hot engine. Keep yourself clear of all hot engine parts and/or fluids. A hot engine and/or fluid can cause serious burns.



#### **WARNING**

DO NOT raise the engine hood if you see or hear steam or coolant escaping from the engine compartment. Wait until steam or coolant cannot be seen or heard any longer before raising the hood.

DO NOT remove the coolant fill cap if the coolant in the surge tank is boiling. Also, do not remove the cap while the engine and radiator are still hot. Scalding fluid and steam may be blown out under pressure if the cap is taken off too soon, which can cause personal injury and damage to engine components.



W0001525

DO NOT touch any part of the engine while it is hot. Allow the engine to cool before any repair or maintenance is performed on the engine.

Relieve all pressure in air, oil, fuel or cooling systems before any lines, fittings or related items are disconnected or removed.

## 16 VOLVO Engines

---

### Coolant



#### WARNING

Coolant may be combustible. Coolant leaked or spilled onto hot surfaces or electrical components can cause a fire. Clean up coolant spills immediately.



W0001527

To prevent personal injury, use suitable, properly positioned ladder to reach and remove the filler cap. At normal operating temperature, the engine coolant is very hot and under pressure. If pressure is relieved rapidly in a hot cooling system, the hot coolant can turn into steam. Any contact with hot coolant or steam can cause severe burns. The radiator and all heating system and radiator lines and hoses contain hot coolant.

Verify coolant level only by the markings on the expansion tank. Open the filler cap only after the engine is stopped and cooled down. Remove the filler cap slowly to relieve pressure.

### Oils



#### WARNING

Hot engine. Keep yourself clear of all hot engine parts and/or fluids. A hot engine and/or fluid can cause serious burns.

Hot oil can cause severe burns. DO NOT allow hot oil to contact the skin. When changing oil, wear protective gloves.

## Batteries



### WARNING

Always wear eye protection when working around batteries to prevent the risk of injury due to contact with sulfuric acid or an explosion.



### WARNING

Battery posts, terminals and related accessories contain lead and lead compounds, chemicals known to the State of California to cause cancer and reproductive harm. Wash hands after handling.

Battery electrolyte contains acid and can cause injury. Avoid contact with the skin and eyes. Wash hands after touching batteries and connectors. Use of gloves is recommended. Always wear protective glasses when working with batteries.

## Fire or Explosion Prevention



### DANGER

The diesel engine will operate on any fuel which enters the cylinder, whether it is from the injectors or from the air intake system. Therefore, if any solvent is used to flush out the air cleaner element, the engine may over speed during start-up. Engine damage and severe injury and/or death from burns or explosion can occur.



### DANGER

Excessive heat may cause the pressurized components of the air conditioned system to explode. Some mixtures of R134a refrigerant can become combustible at elevated pressures. Never weld, solder, steam clean or use a gas torch near any part of the air conditioning system. Severe injury or death may occur from an explosion.



W0001526



## **DANGER**

DO NOT service any part of the fuel system while smoking or in the presence of flames, sparks or hot surfaces. Failure to follow these precautions can result in fire, which can cause serious injury or death.



## **WARNING**

DO NOT store fuel containers in the vehicle. They may leak, explode and cause or feed a fire. Empty or full, they present a hazard that may lead to burns in the event of a fire.



W0001527



The engine should not be operated in an area where combustible gases are suspected to be in the air. These could be drawn into the engine through the engine air intake system and could cause the engine to over speed with possible serious damage to the engine and bodily injury or property damage.

Make provisions for shutting off the engine intake air or fuel supply to stop the engine if there is an over speed on start-up after performing repair or maintenance on it.

Contact your nearest authorized Prevost Service Center for any necessary air conditioning testing or repairs.

All fuels, most lubricants and some coolant mixtures are flammable. Diesel fuel is flammable. Gasoline is flammable. The mixture of diesel and gasoline fumes is extremely explosive. DO NOT smoke while refueling or when in a refueling area.

Keep all fuels and lubricants stored in properly marked containers and away from all unauthorized personnel. Store oily rags or other flammable material in a protective container, in a safe place.

Remove all flammable material such as fuel, oil and other substances before they accumulate on the engine.

DO NOT expose the engine to flames, driving over burning ground.

DO NOT weld or flame cut on or around pipes or tubes that contain flammable fluids.

Exhaust heat shields may be installed to protect oil or fuel carrying lines and pipes from hot exhaust parts. To protect from pipe or seal failure, install heat shields correctly.

Provide adequate and proper waste oil disposal. Always dispose of waste liquids according to Federal and local regulations. Oil and fuel filters should be properly installed and housing covers tightened to the proper torque when being changed.

## *Fire Extinguisher*

Anytime work is being done to the fuel system or any other area where flammable substances are being used, have a fire extinguisher available and know how to use it. Inspect and have it serviced as recommended on its instruction label.

## 20 VOLVO Engines

---

### *Respiratory Hazard Prevention*



#### **DANGER**

Exhaust gases contain carbon monoxide. Always run the engine outdoors or use a properly vented exhaust hose. Prolonged or excessive exposure may cause serious illness or death.



#### **WARNING**

Diesel engine exhaust and some of its constituents are known to the state of California to cause cancer, birth defects and other reproductive harm.



W0001523

Always work in a well ventilated space if the engine needs to be running and use a hose to route the exhaust to the outside.

### *Poisonous Substances*



#### **DANGER**

Coolant is toxic; risk of poisoning.  
DO NOT drink coolant. Use proper hand protection when handling. Keep coolant out of reach of children and animals. Failure to follow these precautions can cause serious illness or death.

Cooling system supplemental additive contains alkali. To prevent personal injury, avoid contact with the skin and eyes.

DO NOT drink coolant of any concentration.

## Crushing or Cutting Prevention



### DANGER

Before working on a vehicle, set the parking brakes, place the transmission in neutral and chock the wheels. Failure to do so can result in unexpected vehicle movement and can cause serious personal injury or death.



### WARNING

DO NOT work near the fan with the engine running or the ignition in the ON position. The engine fan can engage at any time without warning. Anyone near the fan when it turns on could be seriously injured.



W0001524

Never attempt adjustments or repairs while the engine is running, see your authorized Prevost Service Center.

Inspect the fan blade assembly before service for cracks or loose mounting before starting the engine. *Never* stand alongside a rotating fan assembly, particularly at high fan speeds.

Wear protective glasses when striking objects to avoid injury to your eyes. Chips or other debris can fly off objects that are struck. Make sure no one can be injured by flying debris before striking any object.

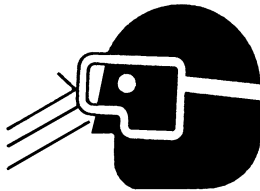

W0001528

### *Climbing Up and Down*



#### **DANGER**

Always use a three-point stance (one foot and two hands or two feet and one hand) whenever climbing up or down. Failure to follow this warning can result in serious personal injury or death.

DO NOT climb up on or jump off from the engine or stand on components that cannot support your weight. Use an adequate ladder or scaffolding, suitably situated.

Clean steps, handholds and areas of the vehicle on which you will be working or are around. Refer to the Operators Manual for proper entry and exit procedures.

---

# Engine Damage Prevention

## Before Starting the Engine



### **DANGER**

Before working on a vehicle, set the parking brakes, place the transmission in neutral and chock the wheels. Failure to do so can result in unexpected vehicle movement and can cause serious personal injury or death.

Inspect engine for potential hazards. Make sure all protective guards and covers are properly installed if an engine needs to be started to make adjustments or checks. To help prevent an accident by moving parts, work carefully around them.

DO NOT disable or bypass automatic alarm/shutoff circuits. They are provided to prevent personal injury and engine damage.

Only properly trained and authorized Prevost Service Technicians may attempt repairs on this vehicle.

## Engine Starting

DO NOT start the engine or move any of the controls or disengage the parking brake if the warning tag DO NOT OPERATE is attached to the ignition key or located on the dash. Check with the person who attached the tag before starting.

Make sure no one is working on or close to the engine or components driven by the engine before starting it. Always make an inspection of the engine before and after starting.

Diesel engine exhaust contains products of combustion which may be harmful to your health. Always start and operate the engine in a well-ventilated area, and if in an enclosed area, vent the exhaust to the outside.

Start the engine only from the driver seat in the cab. Never start the engine by shorting across the starter motor terminals or batteries to start the engine as this could bypass the engine neutral-start system as well as damage the electrical and electronic system. Always start the engine according to the required engine starting procedure described in this operators manual to prevent major engine component damage and personal injury.

### Starting Aids



#### **DANGER**

DO NOT use ether or other combustibile starting aids on any engine equipped with a preheater. If the engine is equipped with a preheater, introduction of ether or similar starting aids could cause a fire or explosion resulting in severe property damage, serious personal injury or death.

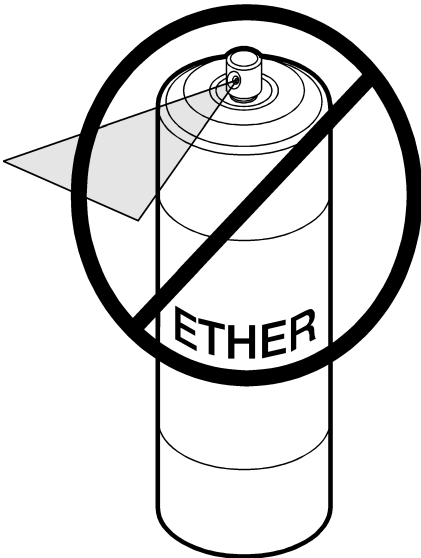

W0001484

## Electric and Electronic Systems



### WARNING

Always wear eye protection when working around batteries to prevent the risk of injury due to contact with sulfuric acid or an explosion.



W0001526

Never disconnect any charging unit circuit or battery circuit cable from the battery when the charging unit is operating. A spark can cause the flammable vapor mixture of hydrogen and oxygen to explode.

To prevent potential sparks from igniting combustible gases produced by some batteries, attach the negative (-) terminal last when hooking up and remove the negative terminal first after the engine has started. Check regularly around the engine and engine compartment for loose or frayed wires. Have all loose or frayed electrical wires tightened, repaired or replaced before operating the vehicle.

### *Grounding Practices*

Proper grounding for vehicle and engine electrical and electronic systems is necessary for proper vehicle and engine performance and reliability. Improper grounding will result in uncontrolled and unreliable electrical paths.

Uncontrolled engine electrical circuit paths can result in damage to main bearings, crankshaft journals surfaces and aluminum components. Uncontrolled electrical circuit paths can also cause electrical noise which may degrade vehicle and radio performance.

Operating engines without the engine-to-frame ground strap installed can cause damage to the engine. To prevent electrical discharge damage, check to make sure the engines electrical system has an engine-to-frame ground strap. All ground connections should be tight and free of corrosion.

### *Electronic Engine Control System*



#### **DANGER**

The engine uses high voltage to the electronic unit injectors. **DO NOT** come in contact with the unit injector terminals while the engine is running. An electric shock can cause an involuntary muscle spasm and cause loss of balance and falls leading to severe personal injury or death.



W0001522

Tampering with the electronic system installation can be dangerous and could result in personal injury or death and/or engine damage. It is very important to take the proper precautions with the electrical and electronic system when charging the batteries, jump-starting or performing electric welding on the vehicle. See the vehicle operator's manual for correct procedures.

This engine is equipped with monitoring features that may cause reduced power or shutdown under certain conditions. The power output, monitoring and idling features can only be programmed and/or changed with electronic service tools and passwords.

Certain features, such as low oil pressure, high coolant temperature or low coolant level could cause the engine power and/or vehicle speed to be limited and the engine may also shut down. The shutdown will take approximately 30 seconds from the time the warning feature is activated. See the vehicle operator's manual for more information.

## Reporting Safety Defects

### USA

The National Highway Traffic Safety Administration (NHTSA) and PrevoSt should be informed immediately if you believe that the vehicle has a defect that could cause a vehicle accident, injury or death.

Contact NHTSA by calling the Auto Safety Hotline at 1 (888) 327-4236, by writing to NHTSA, U.S. Department of Transportation, Washington, DC 20590, by TTY at 1 (800) 424-9153, or visit their website at <http://www.safercar.gov>.



## Canada

Refer customer complaints to Prevost — Customer Service.

850 Chemin Olivier

St-Nicolas, Qc

G7A 2N1 Canada

Fax: 418-831-9301

Canadian customers who wish to report a safety-related defect to Transport Canada, Defect Investigations and Recalls, may telephone the toll free hotline 1 (800) 333-0510 (within Canada only) or call 1 (613) 993-9851 (from Ottawa region or outside Canada). Contact Transport Canada by mail at: Transport Canada, ASFAD, Place de Ville Tower C, 330 Sparks Street, Ottawa ON K1A 0N5.

For additional road safety information, please visit the Road Safety website at: <http://www.tc.gc.ca/roadsafety/menu.htm>

## On-Call Assistance

Prevost Action Service, provides on-call assistance. For help contact Prevost Action Service directly: 24 hours a day at 1 800 463 7738.

## Introduction

The US2010 VOLVO D13J engines meet the very stringent new emissions standards which apply to all heavy-duty diesel engines built after January 1, 2010 for on-highway coaches. The new standards for US 2010 requires 83% reduction in nitrogen oxides (NOx). This represents a total reduction of 99% of all emissions from original levels.

Key Features of the VOLVO engines:

- Improved Fuel Economy
- Extended Oil Drain Intervals
- Improved Cooling Capacity
- Low Maintenance Catalyzed Aftertreatment Diesel Particulate Filter (DPF)
- Enhanced Engine Brake Performance
- Selective Catalytic Reduction (SCR)

### Fuel



#### CAUTION

Diesel engines for US 2010 vehicles are designed to operate only with ultra low sulfur diesel (ULSD) fuel. Use of fuel other than ULSD will reduce the efficiency and durability of the engine, permanently damage the advanced emission control systems, reduce fuel economy and possibly prevent the engine from running at all. Manufacturer's warranties are likely to be rendered void by usage of improper or incorrect fuel, and usage of fuels other than ULSD fuel in diesel-powered vehicles is illegal and punishable with civil penalties. Use of fuel additives to compensate for the lower sulfur content is NOT recommended by Volvo.

Fuel sold for use in diesel-powered engines for US 2010 vehicles may only contain a maximum sulfur content of 0.0015% by weight. This was done to reduce particle emissions in the exhaust.

**Ultra Low Sulfur  
Diesel Fuel Only**

20836671

W2059486

Diesel Fuel Only Decal

---

## Engine Oil

EO-O Premium Plus (or VDS-4) diesel engine oil is mandatory for use in all US 2010 emission compliant VOLVO engines. Chassis equipped with a US 2010 emission compliant engine, which can be identified by the presence of an Aftertreatment Selective Catalytic Reduction (SCR) system, also require the use of ultra low sulfur diesel (ULSD) fuel. EO-O Premium Plus oils exceed the new API service category CJ-4.

### Engine Operation

#### **DANGER**

Do not use ether or other combustible starting aids in any VOLVO engine. Introduction of ether or similar starting aids could cause a fire or explosion resulting in severe property damage, serious personal injury or death.

#### **CAUTION**

DO NOT crank the engine for more than 30 seconds at a time; wait two minutes after each try to allow the starter to cool. Failure to follow these instructions could cause starter damage.

**Note:** Some starters are equipped with starter protection. If the engine is running, the starter temperature is too high or the transmission is not in neutral, starter engagement is inhibited.

Allow the engine to slow down and idle for 3 to 5 minutes before shutting it off. This allows the turbo to slow down and the cooling system to dissipate the engine heat. Switch the engine off by turning the ignition key to the OFF position.

#### **CAUTION**

Shutting off an engine immediately after high speed or full load operation can damage the turbo and cause heat stress in the engine. Always let the engine idle for 3 to 5 minutes before shutting it off.

## Engine Shutdown System

### Stopping the Engine

Allow the engine to slow down and idle for 3 to 5 minutes before shutting it off. This allows the turbo to slow down and the cooling system to dissipate the engine heat. Switch the engine off by turning the ignition key to the B, or OFF, position.



### CAUTION

Shutting off an engine immediately after high speed or full load operation can damage the turbo and cause heat stress in the engine. Always let the engine idle for 3 to 5 minutes before shutting it off.



### DANGER

Failure to take the necessary precautions when the CHECK or STOP tell-tales are on, can ultimately result in automatic engine shut-down and the loss of power steering. Vehicle crash can occur.

### Engine Shut-Down System



W3005170



W3005171

## 32 VOLVO Engines

---

The engine shut-down system will automatically derate or stop the engine when one or more of the systems listed below reaches a critical stage:

- High Coolant Temperature
- Low Oil Pressure
- Low Coolant Level
- High Crankcase Pressure
- High Diesel Particulate Filter Soot Level
- Low DEF Fluid Level

When the shut-down is activated, the tell-tales come on and the buzzer is also activated. From that time it will take 30 seconds before the engine shuts down. In this time period, find a safe place to pull off of the road.

After the engine has been shut down by the system, the override will allow a restart of the engine for 30 seconds. This is so the vehicle may be pulled off the road, if necessary. The alarm will remain activated until repairs have been made to correct the problem.

The operator should not continually override the system as this can cause serious damage to the vehicle's engine.

# Engine Overview, D13J Left Side View

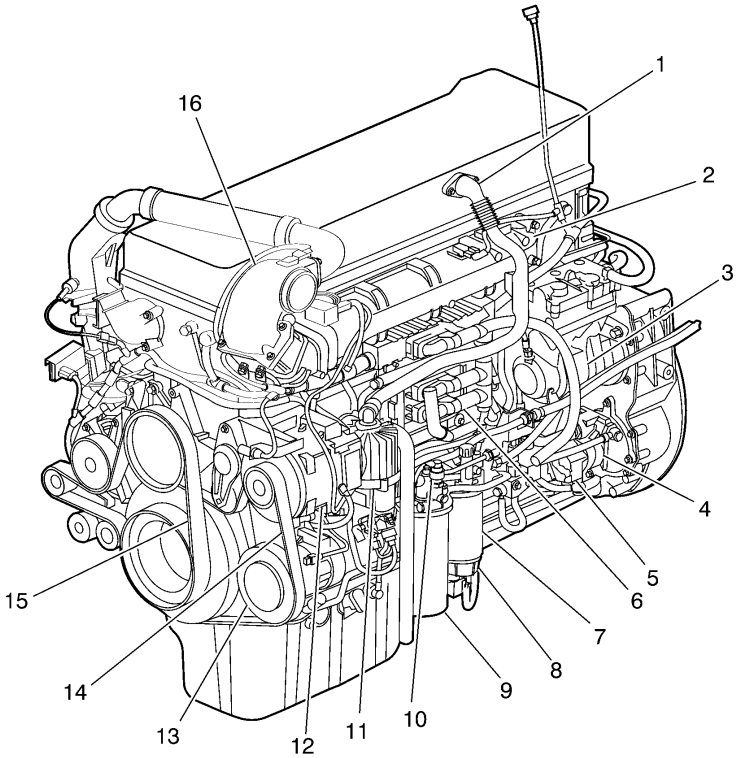

W2006034

## D13J Engine

**Note:** Illustration is used for reference only and may differ slightly from the actual vehicle.

1. Breather Tube	9. Fuel Filter
2. Intake Manifold	10. Hand-Priming Pump
3. Air Compressor	11. Crankcase Ventilator
4. Power Steering Pump	12. Alternator
5. Fuel Pump	13. AC Compressor
6. Engine Control Module (ECM)	14. Alternator/AC Compressor Belt
7. Fuel Filter	15. Fan/Coolant Pump Belt
8. Fuel/Water Separator	16. EGR Mixing Chamber

## 34 VOLVO Engines

### Engine Overview, D13J Right Side View

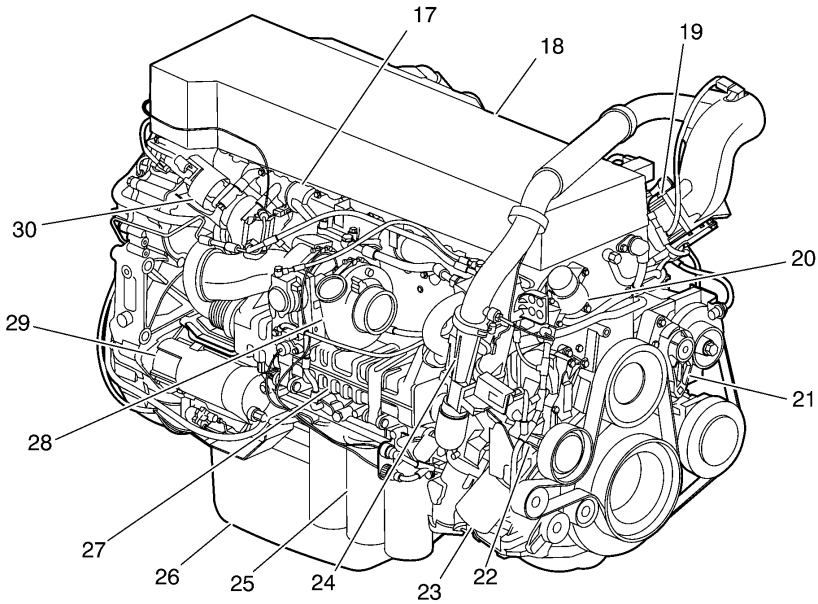

W2006035

#### D13J Engine

**Note:** Illustration is used for reference only and may differ slightly from the actual vehicle.

17. Exhaust Manifold	24. Venturi Pipe
18. Valve Cover	25. Oil Filters
19. Intake Air Heater (IAH) optional	26. Oil Pan
20. Thermostat	27. EGR Cooler
21. Belt Tensioner	28. Turbocharger
22. Coolant Pump	29. Starter Motor
23. Coolant Filter	30. EGR Valve



---

## **Exhaust Emissions and Aftertreatment Diesel Particulate Filters (DPFs)**

### *General*

#### **USA**

Emissions Control Compliance: The Federal Clean Air Act, Section 203 (a) (3), states the following concerning the removal of air pollution control devices or modification of a certified engine to a non-certified configuration:

“The following acts and the causing thereof are prohibited:

(3) For any person to remove or render inoperative any device or element of design installed on or in a motor vehicle or motor vehicle engine in compliance with regulations under this part prior to its sale and delivery to the ultimate purchaser, or for any manufacturer or dealer knowingly to remove or render inoperative any such design after sale and delivery to the ultimate purchaser.”

Specifically, please note that no person may make such changes prior to the sale and delivery of the vehicle to the ultimate purchaser, and, in addition, no manufacturer or dealer may make take such action after sale and delivery of the vehicle to the ultimate purchaser. The law provides a penalty of up to \$10,000 for each violation.

Modifications, such as reprogramming of the fuel system so the engine will exceed the certified horsepower or torque, or removing the mufflers are examples of illegal changes.

Changes should not be made to a certified engine that would result in an engine that does not match the configuration of an engine model that is currently certified to meet Federal Standards.

#### **Mexico**

The same conditions that apply in the USA apply to Mexico. Refer to the Mexican Federal Law for Emission Control which adheres to EPA regulations. No changes should be made that render any or all of the emissions control devices inoperative.

If the owner/operator wishes to make changes to the emission control devices, check with the state authority before changes are made.

#### **Canada**

The same conditions that apply in the USA apply to Canada, with one exception. After the vehicle is sold to a retail customer, that is, the end user, the jurisdiction controlling the emission control devices becomes the province in which the vehicle is licensed. No changes should be made that render any or all of the devices inoperative.

Should the owner/operator wish to make any changes to the emission control devices, check with the provincial authority before making any such changes.

### *Exhaust Emissions and Aftertreatment DPF with Vertical SCR Catalyst*

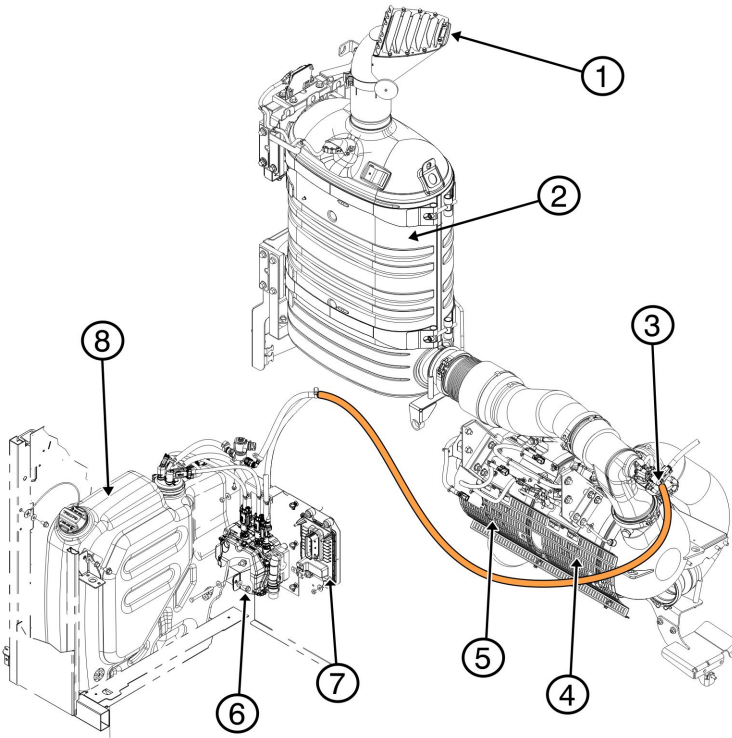

W2081002

1. Diffuser AssemblyAftertreatment
2. Catalytic Converter
3. DEF Injection Nozzle
4. Diesel Particulate Filter (DPF)
5. Diesel Oxidation Catalyst (DOC)
6. DEF Pump
7. Aftertreatment Control Module
8. Aftertreatment DEF Tank

## Exhaust Aftertreatment System



### DANGER

The DPF/SCR shield should not be removed while the vehicle is in use. Also, only remove the shield, once the vehicle is out of use and the SCR/DPF is sufficiently cooled. Failure to follow these instructions can result in fire, which can cause component damage, personal injury or death.



### CAUTION

The Diesel Particulate Filters (DPF), Selective Catalytic Reduction unit (SCR) and their components, **can not** be moved or altered from the OEM installation in any fashion. Any alterations may cause component damage and is prohibited by the law.

These components are part of the overall vehicle emissions control system. In normal operation, these components can experience surface temperatures as high as 350° C (662° F). It is important to verify the temperature at which the material or substance in, or associated with, the body can ignite. If it is possible for the material or substance to fall or leak from the body, take steps to prevent them from contacting or collecting on the DPF or SCR. Failure to do so may result in fire.

It is important to note that additional shielding may, depending upon conditions and the material or substance, trap flammable substances between the additional shield and the DPF/SCR. If this condition can develop, advise the user of the vehicle to periodically check to ensure there are no trapped substances.

**Note: The DPF/SCR and associated components are part of a U.S. EPA and California Air Resources Board (CARB) certified engine emissions system. These components must not be moved, altered or modified in any way. Tampering with these systems render the emissions warranty void and may result in possible tampering charges by the EPA or CARB.**

New stringent standards for exhaust emission control begin with the US 2010 engine model year. The Diesel Particulate Filter (DPF) system has been developed to act in combination with ultra low sulphur diesel (ULSD) fuel to reduce particulate emissions to meet the requirement. The Exhaust After-Treatment System (EATS) includes all the engine and exhaust emissions control components that are required to meet the stringent US 2010 standard.

Particulate matter consists of soot and ash in the exhaust that engines with an EGR system alone, are not equipped to handle. The particulate matter is considered a contaminant that contains undesirable elements. The DPF system reduces the unwanted elements to a more acceptable level defined in the regulations. There are multiple methods of reducing these emissions. VOLVO has selected to use a Diesel Oxidation Catalyst (DOC) with a catalyzed diesel particulate filter. The other uses a diesel particulate filter of a different kind without a DOC and in its place uses a combustion chamber to heat the exhaust mixture thus causing active regeneration.

The particulate matter removed from the exhaust collects on the filter surfaces. To avoid eventual blockage, which would increase exhaust back pressure and affect power and fuel economy, the filter must be cleaned. The DPF is cleaned automatically. The soot breaks down to safer substances before being released to the atmosphere. Some of the ash remains, but takes a long time to reach the point where ash clogs the filter.

Cleaning a filter so it can continue to function is called “regeneration.” Depending on vehicle usage, the engine utilizes a passive or parked regeneration system. Either system uses high heat to break down the chemical properties.

In “passive regeneration,” the exhaust produces enough heat continuously to convert the soot, with approximately 260 °C (500 °F) being required. The process is slow and continues indefinitely. Passive regeneration is possible only in vehicle applications where the temperature is likely to remain at or above the required temperature level, making active regeneration unnecessary.

Parked regeneration is initiated manually by the driver when alerted by the dash. The vehicle must be stationary to begin the regeneration, and remain stationary to complete. The Aftertreatment DPF Regeneration system is self-monitoring. Under certain duty cycles driver action is needed to perform a parked regeneration. When driver action is needed to perform a parked regeneration the Aftertreatment DPF Regeneration Needed icon on the instrument cluster flashes and the message “Parked REGEN Needed” is displayed. Initiate a parked Aftertreatment DPF regeneration at the next stop.



### **WARNING**

Prior to ever working on the exhaust, allow time for the entire exhaust system to cool. Failure to do so may result in personal injury. Severe burns can occur.

## DPF Systems

The VOLVO systems chemically alters soot by high heat into a harmless gas which passes out through the stack pipe. At these high temperatures, the process is relatively rapid (10–12 minutes). Eventually, the filter must be removed to permit clearing away of the ash with special equipment.

The DPF-muffler has an integrated heat insulation that covers most areas of the muffler. The DPF mufflers are un-insulated at the V-clamp body connections, inlet and outlet pipes. The following surface temperatures have been measured with the muffler freely positioned in a room temperature environment with no forced cooling or wind (only self convection).

**Note:** These are **not** maximum temperatures! The surface temperature in a certain vehicle installations, is dependent on the degree of encapsulation and the airflow around the muffler.

### Compact DPF Temperatures

Position	Thickness of Heat Insulation	at exhaust temperature of 350 °C (662 °F) at the DPF-muffler inlet (no regeneration)	at exhaust temperature 450 °C (842 °F) at the DPF-muffler inlet (no regeneration)
Inlet section — top	10 mm (0.4 in.)	170 °C (338 °F)	190 °C (374 °F)
Inlet section — side	No insulation	260 °C (550 °F)	320 °C (608 °F)
DOC section	9 mm (0.35 in.)	175 °C (347 °F)	215 °C (419 °F)
DPF section	10.5 mm (0.41 in.)	145 °C (293 °F)	190 °C (374 °F)
Outlet section — side	4.5 mm (0.18 in.)	100 °C (212 °F)	150 °C (302 °F)
Outlet section — bottom	4.5 mm (0.18 in.)	120 °C (248 °F)	170 °C (338 °F)
Clamping area — side	No insulation	230 °C (446 °F)	300 °C (572 °F)

## Selective Catalytic Reduction (SCR)

Selective Catalytic Reduction (SCR) is an emissions-reduction technology with the ability to deliver near-zero emissions of nitrogen oxides (NOx), a smog-causing pollutant and greenhouse gas. SCR's performance has been proved in millions of miles of real-world truck operations in other countries, as well as in long-term field tests in the U.S.

SCR reduces NOx emissions to very low levels, while at the same time delivering excellent fuel economy and reliability. The system doesn't change the design or operation of the basic engine. Rather, SCR is an aftertreatment system which converts NOx in the exhaust stream into harmless gases. Modern diesels already use exhaust aftertreatment systems, called diesel particulate filters, to control emissions of another pollutant, soot (also known as particulate matter or PM).

SCR works by injecting Diesel Exhaust Fluid (DEF) into the exhaust stream, after the DPF. DEF is a safe, simple solution of water and urea. DEF works with the heat of the exhaust and a catalyst to convert NOx into nitrogen and water vapor - two harmless and natural components of the air we breathe. The end result is cleaner air, excellent fuel efficiency and a reliable emissions control system for today's modern diesel engine.

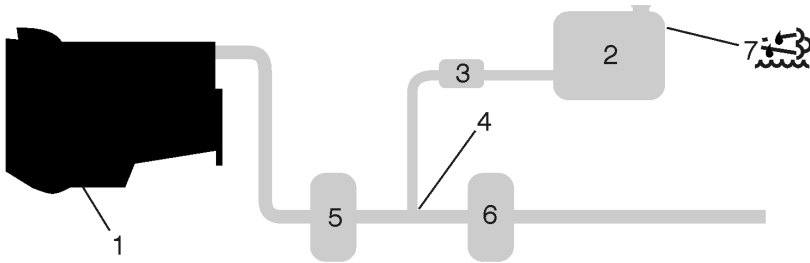

W2031651

1. Diesel Engine
2. Aftertreatment DEF Tank
3. Aftertreatment DEF Pump
4. Aftertreatment DEF Dosing Unit
5. Aftertreatment Diesel Particulate Filter (DPF)
6. Selective Catalytic Reduction (SCR) Catalyst
7. Aftertreatment DEF Tank Sending Unit and DEF Low Level Indicator

**SCR Surface Temperatures**

<b>Position</b>	<b>Thickness of Heat Insulation</b>	<b>at exhaust temperature of 350 °C (662 °F) at the SCR-muffler inlet</b>	<b>at exhaust temperature 450 °C (842 °F) at the SCR-muffler inlet</b>
Casing – all round	Muffler filled with insulation	75 °C (167 °F)	125 °C (257 °F)
End wall – in/outlet side	20 mm (0.78 in.)	100 °C (212 °F)	150 °C (302 °F)
End wall – other side	20 mm (0.78 in.)	125 °C (257 °F)	200 °C (392 °F)
Mounting strap area	No insulation	225 °C (437 °F)	300 °C (572 °F)

## 42 VOLVO Engines

---



### CAUTION

Do not put diesel fuel in the Aftertreatment DEF tank. Diesel fuel, if sprayed into the hot exhaust along with the DEF, could ignite explosively causing a fire resulting in personal injury or damage to the exhaust system.

The VOLVO SCR system is simple and effective, with few components. It consists of a Aftertreatment DEF tank positioned near the standard diesel tank, plus a Aftertreatment DEF pump, Aftertreatment DEF Dosing unit and SCR catalyst. The advantage of using DEF is that it enables the engine to use less EGR -- and higher oxygen levels -- for better combustion, while meeting the EPA near-zero NOx emissions requirement of 0.2 g/hp-hr NOx. By using DEF, we avoid the disadvantages of increasing EGR to massive levels. This results in better fuel economy from your VOLVO engine.



W2055491

Vertical SCR, vertical inlet



## Aftertreatment Hydrocarbon Dosing System

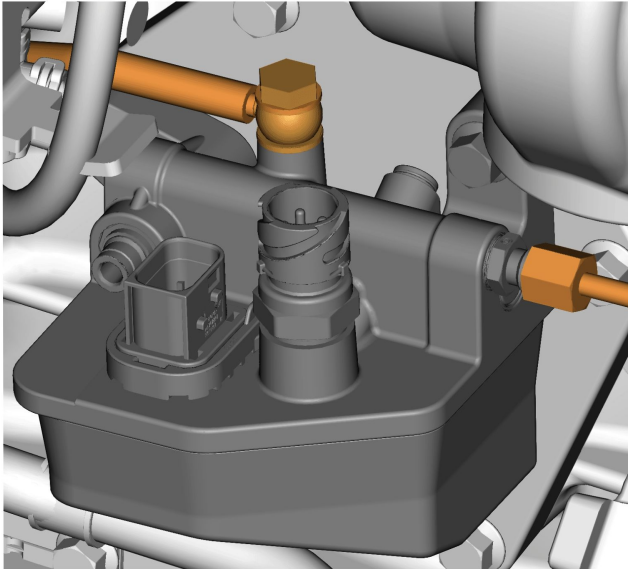

W2064634

The aftertreatment hydrocarbon dosing system is a part of the exhaust aftertreatment system and is used to increase the exhaust gas temperature (EGT) needed for the aftertreatment system.

The dosing system allows diesel fuel to be injected into the exhaust system of the engine to increase the amount of hydrocarbon (HC) released.

The injected fuel will increase the EGT by oxidation of hydrocarbon. An aftertreatment diesel oxidation catalyst (DOC) is mounted upstream of the aftertreatment diesel particulate filter (DPF). This elevated temperature is needed for the aftertreatment selective catalytic reduction (SCR) system and DPF. The HC-system shall be governed by the engine control module (ECM).

The dosing system has interfaces with a most of the vehicle's, major control systems including the fuel system, compressed air system , exhaust system, electrical system, control system and external mechanical interfaces.

### Diesel Exhaust Fluid (DEF)

Diesel Exhaust Fluid (DEF) is a reactant that's key to the SCR process. It's a nontoxic, aqueous solution of 32.5% urea and 67.5% water. Urea is a compound of nitrogen that turns to ammonia when heated. It is used in a variety of industries, perhaps most commonly as a fertilizer in agriculture. The fluid is not flammable, nor is it dangerous when handled normally. However, it is corrosive to metal, particularly copper and aluminium. Read the separate section concerning the handling of DEF solution.

#### *Diesel Exhaust Fluid (DEF) Handling*

When handling DEF solution, it is important that electrical connectors to be connected or well encapsulated. Otherwise there is a risk that the DEF will cause oxidation that cannot be removed. Water or compressed air do not help, since DEF quickly oxidizes metal. If a connector comes into contact with the DEF solution it must be replaced immediately to prevent the DEF solution from creeping further into the copper wiring, which takes place at a speed of about 60 cm (2.4 in) per hour.



#### **CAUTION**

When detaching hoses and components, do not spill DEF on disconnected connectors. If DEF is spilled on a connector, the connector must be replaced immediately



W2059485

## Things to know about spilled Diesel Exhaust Fluid (DEF)

If urea solution comes into contact with the skin, rinse with plenty of water and remove contaminated clothing.
If urea solution comes into contact with the eyes rinse for several minutes and call for medical help if necessary.
If inhaled breathe fresh air and call for medical help if necessary.
Do not allow the DEF solution to come into contact with other chemicals.
The DEF solution is not flammable. If the DEF solution is exposed to high temperatures for long periods of time, it breaks down into ammonia and carbon dioxide.
The DEF solution is corrosive to certain metals, including copper and aluminium. This is similar to the corrosion caused by salt water.
If the DEF solution is spilled onto the vehicle, wipe off the excess and rinse with water. Spilled DEF solution can form concentrated white crystals on the vehicle. Rinse off these crystals with water.

**Note:** Do not flush DEF spills into the normal drain system.

 <b>WARNING</b>
DEF spilt onto hot components will quickly vaporize. Turn your face away!

## *Diesel Exhaust Fluid (DEF) Consumption*

DEF consumption is related to fuel consumption. A bus may travel 225-300 miles (360 — 480 kilometers) or more on one gallon (3.8 liters) of DEF. A gauge much like a fuel gauge will indicate the level of DEF in the tank. A DEF low-level warning activates when DEF is low. If a driver runs out of DEF completely, vehicle power will be reduced to derate mode. When the DEF tank is refilled, the engine will resume normal power.

**Note:** DEF tanks are sized for a two to one fuel to DEF ratio in order to meet US 2010 requirements.

## *Diesel Exhaust Fluid (DEF) Availability*

DEF is available in 2.5 gallon (9.6 liters) containers, 55 gallon (200 liters) drums, 275 gallon (1000 liters) IBC and in bulk storage for fleet locations, truck stops and dealerships. All major truck stops, dealers and distributors carry DEF. For more information on DEF and availability please visit the website [www.volvoscr.com](http://www.volvoscr.com).

### Aftertreatment Control Module (ACM)

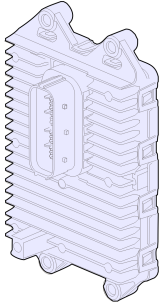

W2038621

The ACM controls the following components in the exhaust aftertreatment system:

- Aftertreatment DEF Dosing Unit
- Aftertreatment DEF Tank Heater Valve
- Aftertreatment DEF Line Heaters
- Aftertreatment DEF Pump
- Aftertreatment DEF Return Valve
- Aftertreatment DEF Tank Level Sensor

The ACM also monitors the following values in the exhaust aftertreatment system:

- Aftertreatment DEF Dosing Absolute Pressure
- Aftertreatment DEF Tank Temperature
- Aftertreatment DEF Tank Level
- Aftertreatment DPF Inlet/Outlet Temperature
- Aftertreatment DPF Differential Pressure
- NOx Sensors

The ACM is a stand alone module. Depending on your configuration it may be mounted as part of the DEF tank (as shown above) or on a bracket near the DEF tank.

## Smart NOx Sensor

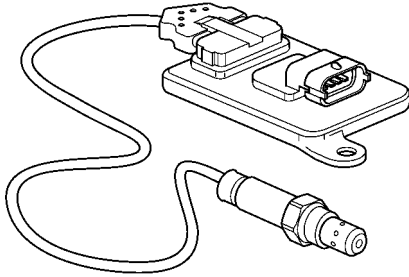

W9000948

The Smart NOx- sensor is used to monitor the emission reduction system. Two NOx sensors are needed for US 2010 vehicles. One sensor is positioned on the DPF/muffler outlet, the other on the exhaust pipe after the SCR-muffler on the SCR-muffler outlet (vertical version).

**Note:** The Smart NOx sensors should not be moved or modified in anyway. To do so would inhibit the proper operation of the Aftertreatment system

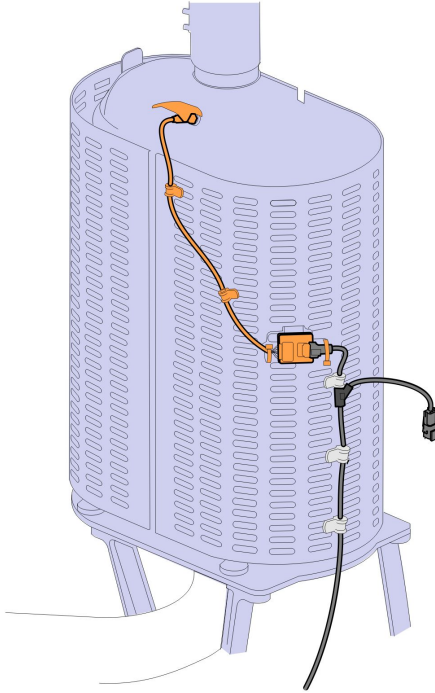

W2081003



NOx Sensor Locations for Vertical SCR

## Aftertreatment Inducement Screens







### Aftertreatment DEF Tank Level - Driver Warning & Inducement

Aftertreatment DEF tanks are sized to have no less than two times the diesel fuel tank mileage.

The vehicle instrument cluster has an aftertreatment DEF tank level gauge.

Triggers	Aftertreatment DEF Tank Low Level Indicator	Driver Information Display Screen
100% to 12% Aftertreatment DEF Tank Level Gauge	None	None
<=12% Aftertreatment DEF Tank Level Gauge	 <p style="text-align: center; font-size: small;">W2029416</p> <p style="text-align: center;">Solid indicator</p>	Low DEF level Refill to avoid Engine derate
0% Aftertreatment DEF Tank Level Gauge (~1% DEF Remaining)	 <p style="text-align: center; font-size: small;">W2029415</p> <p style="text-align: center;">Blinking indicator</p>	DEF Tank Empty Engine in derate Refill to avoid 5 Mph
0% Aftertreatment DEF Tank Level Gauge AND either: <ol style="list-style-type: none"> <li>1 Vehicle stationary for 20 minutes, or</li> <li>2 Diesel fuel Refueling &gt; 15% with parking brake engaged.</li> </ol>	 <p style="text-align: center; font-size: small;">W2029415</p>	DEF tank empty Speed limited to 5 Mph

## Aftertreatment DEF Quality - Driver Warning & Inducement

Triggers	Lamp Status	Driver Information Display Screen
Good DEF Quality	None	None
Poor DEF Quality DTC Initially Detected	 <small>W2029417</small>	SCR performance low Engine derate in < xxx mins
Poor DEF Quality DTC Initially Detected + 1 hour of operation	 <small>W2029417</small>	SCR performance low Engine derate in < xxx mins
Poor DEF Quality DTC Initially Detected +4 hours of operation	 <small>W2029417</small>	SCR performance low Engine in derate 5 Mph in < xxx mins
Poor DEF quality DTC initially detected + 4 hours of operation AND either: <ol style="list-style-type: none"> <li>1 Vehicle stationary for 20 minutes, or</li> <li>2 Diesel Fuel Refueling &gt; 15% with parking brake engaged</li> </ol>	 <small>W2029417</small>	SCR Performance low Engine in derate 5 Mph at next stop
By means of 1 engine start or use of a service tool temporary exit from 8 Km/h (5 Mph) Inducement	 <small>W2029417</small>	SCR performance low Speed limited to 5 Mph
Ignition Key Cycle before DEF Quality Evaluation has been completed	 <small>W2029417</small>	SCR perf. check Engine in derate 5 Mph Limit removed



**Exit conditions for DEF Quality "8 Km/h (5 mph) road speed limit" Inducement:**





**Next 1 Engine Starts:** Return to 25% torque reduction until there is a proper DEF quality evaluation. If poor DEF quality is detected during the next monitoring cycle then 8 Km/h (5 mph) is resumed after the vehicle is stationary for 20 minutes. After one engine start has been exhausted then a Tech Tool is required to exit the 8 Km/h (5 mph) road speed limit.





**With Tech Tool DTC Clearing:** Invoke 25% torque reduction until there is a proper DEF quality evaluation. If poor DEF Quality is detected during the next monitoring cycle then 8 Km/h (5 mph) is resumed after the vehicle is stationary for 20 minutes.

## Aftertreatment Tampering - Driver Warning & Inducement

When the SCR tampering fault is active for one or more hours a new Driver Information Display screen appears. The text changes for the Driver Information Display (DID) screen associated with this fault are listed in the table below.

**Note:** Repeated acts of tampering will result in more severe Inducement.

Triggers	Lamp Status	Driver Information Display Screen
No fault	None	None
<p>Tampering Fault Detect</p> <p><b>Note:</b> For examples of various SCR sensor tampering types refer to the “SCR Tampering ” table below</p>	 <p>W2029417</p>	<p>SCR system fault Engine derate in &lt; xxx mins</p>
<p>Second Drive Cycle with Active DTC.</p>	 <p>W2029417</p>  <p>W3031200</p>	<p>SCR System Fault Engine in derate 5Mph in &lt;xxx mins</p>
<p>Driving with Active Fault for + 1 hour.</p>	 <p>W2029417</p>  <p>W3031200</p>	<p>SCR system fault Engine in derate 5 Mph in &lt; mins</p>

<p>Driving with Active Fault for + 4 hours</p>	 <p>W2029417</p>  <p>W3031200</p>	<p>SCR system fault Engine in derate 5 Mph at next stop</p>
<p>Active tampering DTC initially detected + 4 hours of operation AND either:</p> <ol style="list-style-type: none"> <li>1 Vehicle stationary for 20 minutes, or</li> <li>2 Diesel Fuel Refueling &gt; 15% with parking brake engage</li> </ol>	 <p>W2029417</p>  <p>W3031200</p>	<p>SCR system fault Speed limited to 5 Mph.</p>

<b>SCR Tampering</b>
Aftertreatment Control Module (ACM) Disconnected
Aftertreatment Inlet NOx sensor disconnected
Aftertreatment Oulte NOx sensor disconnected
DEF Pump Disconnected
DEF Dosing Valve Disconnected
DEF Tank Level Sensor Disconnected
DEF Dosing valve or line blocked.
DEF Pump pressure build up failure
DEF Return Line Blocked or Plugged

**Note:** For additional DID information refer to the Driver Information Display Manual.

## Misfilling Diesel or Aftertreatment DEF Tanks

Although diesel fuel and Aftertreatment DEF caps are clearly labeled and filler necks and nozzles are different accidents can happen.

Contamination of fluids by- misfilling of diesel or DEF in the wrong tank may result in vehicle malfunction.

### Results of Misfilling DEF in Diesel Tank

- Engine may run poorly or not at all
- Engine injectors may be damaged
- Exhaust system corrosion may occur between engine turbocharger and Aftertreatment DPF
- On Board Diagnostic (OBD) Diagnostic Trouble Codes (DTC)

- Costly repairs

### Results of Misfilling Diesel in Aftertreatment DEF Tank

- Aftertreatment SCR system may be damaged by diesel
- SCR Catalyst may be damaged by diesel (chemical damage)
- Emissions may be non-compliant
- On Board Diagnostic (OBD) Diagnostic Trouble Codes (DTC)
- Costly repairs

## Warranty and Maintenance

### **Exhaust Aftertreatment System Maintenance**

The vehicle must be taken to an authorized Prevost Service Center to remove the ash from the Aftertreatment Diesel Particulate Filter and clean the Aftertreatment Doser.

### **Emissions Maintenance**

1. If owner's manual recommends Aftertreatment DPF replacement within useful life, the manufacturer must pay for the replacement; however, a random failure within the useful life is covered only per the above warranty provisions.
2. First maintenance interval in life of the engine is allowed at 160 000km (100,000 miles), 3000 hours.

### **Engine Maintenance Intervals**

For specific engine maintenance intervals reference the “Maintenance Manual PREVH, PREVX.”

### Engine Gaseous Emission Control Systems

#### WARRANTY MAINTENANCE

#### GASEOUS EMISSION CONTROL SYSTEMS WARRANTY

Prevost warrants the Emission Control Systems on each new VOLVO diesel engine in a new Prevost coach to comply with all United States Federal and Canadian emissions regulations applicable at the time of manufacture of the engine, and to be free from defects in material and workmanship under normal use and service up to 60 months, or 100,000 miles, whichever occurs first, provided all Prevost, maintenance requirements are followed as described in this manual. All warranty periods are calculated from the date-in-service of the new vehicle. The repair or replacement of defective parts will be made without charge for the cost of parts and, if repairs are made at an authorized Prevost Service Center, there will be no charge for labor. Prevost's obligation under this warranty is limited to the repair or replacement, at Prevost's option, of any part(s) of the Emission Control Systems of such engine and/or vehicle found to be defective upon examination by Prevost and provided that such part(s) were returned to Prevost or its nearest authorized Service Center within a reasonable period of time.

#### *Qualifications and Limitations:*

**Note: Not covered** by the Emissions Control Systems Warranty:

- Malfunctions caused by misuse, improper adjustments, modification, alteration, tampering, disconnection, improper or inadequate maintenance and use of improper diesel fuel or DEF.
- Damage resulting from accident, acts of nature or other events beyond the control of Prevost.
- Inconvenience, loss of use of the vehicle, commercial loss of any kind including, but not limited to, consequential or incidental damages
- Any vehicle in which the odometer has been altered or damaged so that mileage cannot be readily determined.

**THIS WARRANTY IS EXPRESSLY IN LIEU OF ALL OTHER WARRANTIES AND REPRESENTATIONS OR CONDITIONS, STATUTORY OR OTHERWISE, EXPRESSED OR IMPLIED INCLUDING, BUT NOT LIMITED TO, IMPLIED WARRANTY OF MERCHANTABILITY OR FITNESS FOR A PARTICULAR PURPOSE.**

---

## **Emissions Control System Warranty**

The following engine components are covered by the supplemental emissions control system warranty policy as required by the Federal code of emission regulations.

- 1 Engine Turbocharger Assembly
  - Variable Geometry Turbo (VGT) Actuator
- 2 Charge Air Cooler (CAC)
- 3 Engine Control Module (ECM)
- 4 Injectors
- 5 EGR Cooler
- 6 EGR Valve and EGR Valve Control
- 7 EGR Venturi
- 8 Crankcase Breather (Does not include Crankcase Pressure Sensor)
- 9 Crankcase Separator
- 10 Crankcase Tubing and Hoses before Separator
- 11 Aftertreatment Wiring Harness (DPF)
- 12 Aftertreatment Wiring Harness (SCR)
  - Jumper to AHI Pressure Regulator
  - ACM Power Supply
  - Heater NOx Care
  - DEF Tank
- 13 Aftertreatment Control Module (ACM)
- 14 Aftertreatment Diesel Particulate Filter (DPF) with Aftertreatment Diesel Oxidation Catalyst (DOC)
  - Aftertreatment Doser
  - Aftertreatment Fuel Shutoff Valve
  - Aftertreatment Fuel Pressure Sensor
  - Engine Exhaust Gas Temperature (EGT) Sensor
  - Aftertreatment DPF Intake Temperature Sensor
  - Aftertreatment DPF Outlet Temperature Sensor
  - Aftertreatment DPF Differential Pressure Sensor
- 15 Sensors:
  - Crankshaft Position (CKP) Sensor
  - Transmission Speed Sensor
  - Engine Coolant Temperature (ECT) Sensor
  - Intake Manifold Air Temperature/Pressure Sensor
  - Exhaust Gas Recirculation (EGR) Temperature Sensor
  - Aftertreatment Outlet NOx Sensor
  - Aftertreatment Intake NOx Sensor
  - Engine Exhaust Gas Recirculation Differential Pressure Sensor
  - Ambient Air Temperature (AAT) Sensor
- 16 SCR
  - Aftertreatment Selective Catalytic Reduction (SCR) Catalyst
  - Aftertreatment Diesel Exhaust Fluid (DEF) Pump
    - Aftertreatment DEF Dosing Absolute Pressure Sensor
    - Aftertreatment DEF Return Valve
  - Aftertreatment DEF Dosing Valve
  - Aftertreatment DEF Tank
  - Aftertreatment DEF Tank Heater/Sender
  - Aftertreatment DEF Tank Heater
  - Aftertreatment DEF Tank Heater Valve
  - Aftertreatment DEF Tank Temperature Sensor
  - Aftertreatment DEF Level Sensor

- Aftertreatment DEF Heated Lines
  - Aftertreatment DEF Quality Sensor
17. Instrument Cluster (Repair of Microprocessor)
18. Exhaust Gas Piping (from Turbocharger to Aftertreatment System)

### **Engine Gaseous Emissions Control System Warranty**

The emission warranty for the diesel particulate filter and SCR Systems covers defects in workmanship only. Normal maintenance, such as cleaning ash from the filter at regular maintenance intervals and cleaning the Aftertreatment fuel injector on Diesel Oxidation Catalyst (DOC) DPF systems, is not covered by the emission warranty. With the Thermal Regeneration DPF system, cleaning the ignition electrodes and fuel injection nozzle at the regular maintenance intervals is considered normal maintenance and not covered by the emission warranty.



## Federal Emission Requirements

This section covers the requirement of the United States Clean Air Act which states: “The manufacturer shall furnish with each new motor vehicle or motor vehicle engine such written instructions for the maintenance and use of the vehicle or engine by the ultimate purchaser as may be reasonable and necessary to assure the proper functioning of emission control devices and systems.” This section also covers the requirements of the emissions regulations promulgated under the Motor Vehicle Safety Act in Canada.

### TAMPERING WITH GASEOUS EMISSION CONTROL SYSTEMS PROHIBITED

The Federal Clean Air Act prohibits the removal or rendering inoperative of any device or element of design installed on or in a motor vehicle or motor vehicle engine in compliance with Federal Emission Regulations by:

- 1 Any person prior to its sale and delivery to the ultimate purchaser, or
- 2 Any manufacturer or distributor after its sale and delivery to the ultimate purchaser, or
- 3 Any person engaged in the business of repairing, servicing, selling, leasing, or trading motor vehicles or motor vehicle engines following its sale and delivery to the ultimate purchaser, or
- 4 Any person who operates a fleet of motor vehicles following its sale and delivery to the ultimate purchaser.

**Note:** For specifics of the prohibited vehicle/engine modifications refer to the VOLVO Body Builders documentation .

## Emission Control System Warranty — California

The California Air Resources Board and Prevost. are pleased to explain the California emission control system warranty on your new motor vehicle engine. In California, new motor vehicle engines must be designed, built and equipped to meet the State’s stringent anti-smog standards. Prevosti. must warrant the emission control system on your engine for the period of time listed below provided there has been no abuse, neglect, or improper maintenance of your engine. Your emission control system may include parts such as the fuel-injection system, turbocharger assembly, electronic control module and other emission-related assemblies.

Where a warrantable condition exists, Prevost will repair your engine at no cost to you including diagnosis, parts, and labor. **MANUFACTURER’S WARRANTY COVERAGE:** If an emission-related part of your engine is defective, the part will be repaired or replaced by Prevost. This is your emission control system DEFECTS WARRANTY.

### OWNER'S WARRANTY RESPONSIBILITIES:

As the motor vehicle engine owner, you are responsible for the performance of the required maintenance listed in this manual. Prevost recommends that you retain all receipts covering maintenance of your vehicle, but Prevost cannot deny warranty solely for the lack of receipts or for your failure to ensure the performance of all scheduled maintenance listed in other manuals which were supplied with your vehicle. You are responsible for presenting your motor vehicle engine to a Prevost Service Center as soon as a problem exists. The warranty repairs should be completed in a reasonable amount of time, not to exceed 30 days. As the motor vehicle engine owner, you should also be aware that Prevost may deny you warranty coverage if your vehicle or a part has failed due to abuse, neglect, improper maintenance, or unapproved modifications. If you have any questions regarding your warranty rights and responsibilities, you should contact the Prevost Department 850 Chemin Olivier, St-Nicolas, Qc, G7A 2N1, Canada, Fax 418-831-9301, or the California Air Resources Board at 9480 Telstar Avenue, El Monte, California 91731. **(Applicable only to vehicles and/or engines certified for sale and registered in the State of California)** Prevost warrants the Emission Control Systems on each new VOLVO diesel engine in a new Prevost coach to comply with all State of California emissions regulations applicable at the time of manufacture of the engine, and to be free from defects in material and workmanship under normal use and service up to 60 months or 160 000 km (100,000 miles), whichever occurs first, provided all Prevost maintenance requirements are followed as described in this manual. All warranty periods are calculated from the date-in-service of the new vehicle. The repair or replacement of defective parts will be made without charge for the cost of parts and, if repairs are made at an authorized Prevost Service Center, there will be no charge for labor. Prevost's obligation under this warranty is limited to the repair or replacement, at Prevost's option, of any part(s) of Emission Control Systems of such engine and/or vehicle found to be defective upon examination by Prevost and provided that such part(s) were returned to Prevost or its nearest authorized Dealer within a reasonable period of time.

### *Qualifications and Limitations:*

**Not covered** by the Emissions Control Systems Warranty:

- Malfunctions caused by misuse, improper adjustments, modification, alteration, tampering, disconnection, improper or inadequate maintenance and use of improper diesel fuel or DEF.
- Damage resulting from accident, acts of nature or other events beyond the control of Prevost
- Inconvenience, loss of use of the vehicle, commercial loss of any kind including, but not limited to, consequential or incidental damages.
- Any vehicle in which the odometer has been altered or damaged so that mileage cannot be readily determined.

**THIS WARRANTY IS EXPRESSLY IN LIEU OF ALL OTHER WARRANTIES AND REPRESENTATIONS OR CONDITIONS, STATUTORY OR OTHERWISE, EXPRESSED OR IMPLIED INCLUDING, BUT NOT LIMITED TO, IMPLIED WARRANTY OF MERCHANTABILITY OR FITNESS FOR A PARTICULAR PURPOSE.**

### Emissions Control System Warranty

The following engine components are covered by the supplemental emissions control system warranty policy as required by the California code of regulations.

- 1 Engine Turbocharger Assembly
  - Variable Geometry Turbo (VGT) Actuator
- 2 Charge Air Cooler (CAC)
- 3 Engine Control Module (ECM)
- 4 Injectors
- 5 EGR Cooler
- 6 EGR Valve and EGR Valve Control
- 7 EGR Venturi
- 8 Crankcase Breather (Does not include Crankcase Pressure Sensor)
- 9 Crankcase Separator
- 10 Crankcase Tubing and Hoses before Separator
- 11 Aftertreatment Wiring Harness (DPF)
- 12 Aftertreatment Wiring Harness (SCR)
  - Jumper to AHI Pressure Regulator
  - ACM Power Supply
  - Heater NOx Care
  - DEF Tank
- 13 Aftertreatment Control Module (ACM)
- 14 Aftertreatment Diesel Particulate Filter (DPF) with Aftertreatment Diesel Oxidation Catalyst (DOC)
  - Aftertreatment Doser
  - Aftertreatment Fuel Shutoff Valve
  - Aftertreatment Fuel Pressure Sensor
  - Engine Exhaust Gas Temperature (EGT) Sensor
  - Aftertreatment DPF Intake Temperature Sensor
  - Aftertreatment DPF Outlet Temperature Sensor
  - Aftertreatment DPF Differential Pressure Sensor
- 15 Sensors:
  - Crankshaft Position (CKP) Sensor
  - Transmission Speed Sensor
  - Engine Coolant Temperature (ECT) Sensor
  - Intake Manifold Air Temperature/Pressure Sensor
  - Exhaust Gas Recirculation (EGR) Temperature Sensor
  - Aftertreatment Outlet NOx Sensor
  - Aftertreatment Intake NOx Sensor
  - Engine Exhaust Gas Recirculation Differential Pressure Sensor
  - Ambient Air Temperature (AAT) Sensor
- 16 SCR
  - Aftertreatment Selective Catalytic Reduction (SCR) Catalyst
  - Aftertreatment Diesel Exhaust Fluid (DEF) Pump
    - Aftertreatment DEF Dosing Absolute Pressure Sensor
    - Aftertreatment DEF Return Valve
  - Aftertreatment DEF Dosing Valve
  - Aftertreatment DEF Tank
  - Aftertreatment DEF Tank Heater/Sender
  - Aftertreatment DEF Tank Heater
  - Aftertreatment DEF Tank Heater Valve
  - Aftertreatment DEF Tank Temperature Sensor
  - Aftertreatment DEF Level Sensor

- Aftertreatment DEF Heated Lines
- Aftertreatment DEF Quality Sensor

17. Instrument Cluster (Repair of Microprocessor)

18. Exhaust Gas Piping (from Turbocharger to Aftertreatment System)

### **Emission Green House Gas Component Warranty (If Equipped)**

#### *Critical Emissions-Related Maintenance*

**Source of parts and repair:** A repair shop or person of the owner's choosing must maintain, replace, or repair emission control devices and systems per manufacturer's recommendations.

**Replacement of tires that are GHG certified:** The original equipment tires installed on this vehicle at the factory were certified to the U.S. EPA Greenhouse Gas (GHG) and National Highway Traffic Safety Administration (NHTSA) Fuel Efficiency regulations. Replacement of these tires should be with a tire of equal or lower rolling resistance levels (TRRL or Crr). Please consult your tire supplier(s) for appropriate replacement tires.

**Maintaining a GHG certified tire:** In order to maintain the certified rolling resistance of the tires which optimize fuel economy, the maintenance procedures provide by the tire manufacturer must be followed.

*Please visit PrevoSt Web Site for further information about Warranty.*

## **Engine Brake**

The engine brake is operated by the Engine Brake buttons on the steering wheel. It works together with the exhaust brake to provide two levels of braking power. There are three Engine Brake buttons on the steering wheel: OFF, (1) LOW and (2) HIGH. When the Engine Brake button (1) LOW is depressed, only the exhaust brake is engaged. When the Engine Brake button (2) HIGH is depressed, both the exhaust brake and the compression brake are activated. The following conditions must be met:

- Engine Brake button (1) LOW or (2) HIGH depressed
- Engine Brake/Transmission Retarder selector switch is set to Engine Brake position (selector switch can be found on the dashboard only if the vehicle is equipped with both systems)
- Vehicle speed over 12 km/h (7.5 mph)
- Engine temperature over 43°C (110°F)
- Accelerator pedal is released
- Engine speed exceeds 1150 rpm

## Engine Components, Service Schedules

Component	Operation	Km (Miles)/Maximum Months/Hours
Engine Fuel Filter	Change	Each oil change *
Water Separator	Filter change	Each oil change *
Air Filter US 2010	Change	160 000 (100,000) or 12 months, whichever comes first
Engine Coolant	Change	500 000 (300, 000) or 24 months, whichever comes first
Engine Coolant (ELC)	Change	1 000 000 (600,000) or 48 months, whichever comes first
Coolant Filter US 2010	Change	80 000 (50,000) or 6 months, whichever comes first
Engine Coolant Filter (ELC) US 2010	Change	240 000 (150,000) or 12 months, whichever comes first
Valves/Engine Injectors **	Initial Adjust	200 000 (125,000) or 12 months, whichever comes first
Valves/Engine Injectors **	Adjust	400 000 (250,000) or 24 months, whichever comes first
Catalyzed DPF Filter (If equipped)	Change	400 000 (250,000) or 4,500 hours, whichever comes first.
Aftertreatment Diesel Exhaust Fluid Dosing Valve	Clean	240 000 (150,000) or 4,500 hours, whichever comes first.
Aftertreatment Diesel Exhaust Fluid (DEF) Pump Filter	Change	First Change; 161 000 (100,000), 3200 hours or three (3) years. Then every 241 000 (150,000) 4800 hours or three (3) years, whichever comes first.
Diesel Exhaust Fluid (DEF) Tank Filler Neck Filter Cleaning	Clean	280 000 (175,000) or 12 months, whichever comes first.

\*Under certain conditions (for example, irregular fuel quality), the fuel/water separator filters may require more frequent replacement.

\*\*Valves must be adjusted whenever the rocker shaft has been removed and reinstalled for any reason.



## **Cooling System**

### **General Coolant Information**



#### **DANGER**

Coolant is toxic; risk of poisoning. DO NOT drink coolant. Use proper hand protection when handling. Keep coolant out of reach of children and animals. Failure to follow these precautions can cause serious illness or death.



#### **WARNING**

Coolant may be combustible. Coolant leaked or spilled onto hot surfaces or electrical components can cause a fire. Clean up coolant spills immediately.



#### **WARNING**

DO NOT raise the engine hood if you see or hear steam or coolant escaping from the engine compartment. Wait until steam or coolant cannot be seen or heard before raising the hood.

DO NOT remove the coolant fill cap if the coolant in the surge tank is boiling. Also, DO NOT remove the cap while the engine and radiator are still hot. Scalding fluid and steam may be blown out under pressure if the cap is taken off too soon and can cause personal injury.



#### **CAUTION**

Prevost and Volvo Bus Corporation does not recommend using plain water in the cooling system. Water alone is corrosive at engine operating temperatures and does not provide adequate boiling protection. The engine may develop corrosion and cavitation problems in the engine and radiator, and the boiling point of the coolant is lowered compared to a proper antifreeze and water mixture. Failure to follow Prevost and Volvo Bus Corporation cooling system care/maintenance recommendations can render the warranty invalid.

The main purpose of coolant is to transport heat from the hot parts of the engine to the radiator and to protect the cooling system from corrosion.

In addition to this, the coolant must:

- Protect against pitting and cavitation erosion damage of the water pump and cylinder liners.
- Protect against freezing and boiling.
- Prevent formation of scale, sludge deposits and clogging.
- Be harmless to polymer materials and seals in the cooling system.
- Maintain its liquid properties in cold climates.

Many engine failures can be traced back to a problem in the cooling system. If the coolant level is allowed to go below the bottom of the tank, there is the risk of the engine shutting down. See the operators manual for more information on the warning functions.

**Note:** Always dispose of coolant according to Federal or local regulations. Take all used coolant to a recycling or waste collection center.

Coolant mixture consisting of an antifreeze solution in water should be used year-round to provide freeze and boil-over protection as well as providing a stable environment for seals and hoses.

**Note:** DO NOT use antifreeze formulated for automobile gasoline engines. These have a very high silicate content that will clog the radiator and leave unwanted deposits in the engine.

Freeze Protection Down To:	Percentage of Antifreeze in Mixture
– 25°C (– 13°F)	40%
– 30°C (– 22°F)	46%
– 38°C (– 36°F)	54%
– 46°C (– 51°F)	60%

A well functioning and maintained cooling system is as important to the engine as performing regular oil changes or using good fuel. To get the best result use quality products and service the system at the correct intervals. Please read this section carefully.

Keep the radiator (including charge air cooler) and the frontal area free from bugs, dirt, leaves, etc.

Check the coolant level in the tank regularly. Fill the tank as necessary with the correct coolant.

Inspection of the whole cooling system is important. Check for swollen or deteriorated heater and radiator hoses, loose hose clamps and connections, and radiator leaks.



## DANGER

DO NOT work near the fan with the engine running. The engine fan can engage at any time without warning. Anyone near the fan when it turns on could be seriously injured. Before turning on the ignition, be sure that no one is near the fan.



## CAUTION

Never add coolant to a hot or overheated engine. Engine damage can result. Allow the engine to cool first.

## Additives

Additives help prevent rust, scale and mineral deposits from forming. Additives also protect metals from corrosion, prevent water pump and cylinder liner cavitation and contain anti-foaming agents. Additives are depleted during normal engine operation and need to be **replaced**. For non-extended life coolant mixture, this means the addition of **Supplemental Coolant Additives (SCA)** at any time the additive goes below the recommended level. For extended life coolant mixture, this means an extender package added halfway through the coolant lifetime.

## 70 VOLVO Engines

---

### Regular Coolant Change Interval

Coolant SCA level must be tested at least twice per year or whenever coolant loss occurs. For maximum coolant system efficiency, test the system at every engine oil change interval, every 1,000 hours or every 6 months (whichever comes first). For proper SCA levels, consult Service Manual.

### *Regular Coolant Filter Change Intervals*



#### **WARNING**

Hot engine. Keep clear of all hot engine parts and fluids. A hot engine and fluids can cause serious burns.

The charged coolant filter contains 8 units of SCA that are released slowly over time to maintain the recommended level during operation. Consult engine service manual for proper SCA level and change intervals.

### Extended Life Coolant Change Interval



#### **WARNING**

Hot engine. Keep clear of all hot engine parts and fluids. A hot engine and fluids can cause serious burns.



#### **CAUTION**

Extended life coolant will test as out of additives (SCA), but SCA should not be added. Shortened engine life may be the result of adding SCA.



#### **CAUTION**

**DO NOT** use a filter that contains SCA. Damage to components can result.

**Note: DO NOT add supplement coolant additives (SCA) to extended life coolant.**

Should the extended life coolant system become contaminated with regular coolant exceeding 10% of the systems total capacity or if SCA is added to extended life coolant, drain the system and refill with new extended life coolant or regular coolant.



**VOLVO**

**Volvo Bus Corporation**

Göteborg, Sweden