

# VIDEO DISTRIBUTION

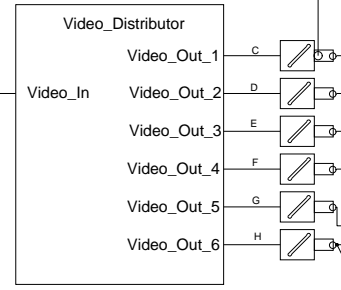

TV SAT  
OR  
DVD2

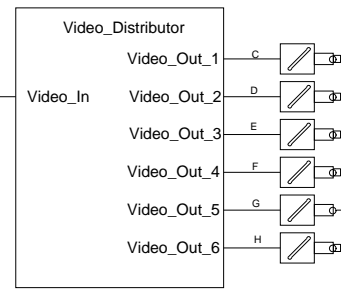
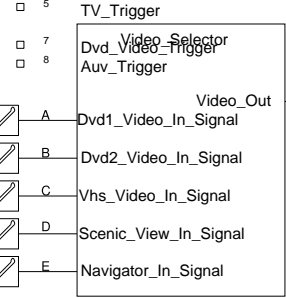
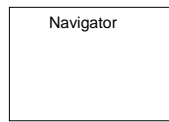
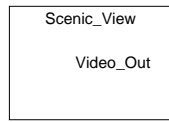
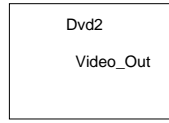
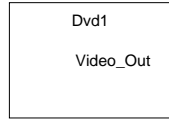

IF Tv Tuner is use without  
video player, AUX1 must  
take the place of TRIG5  
See P.35.0

## WIRELESS INTERNET MODEL RBOX

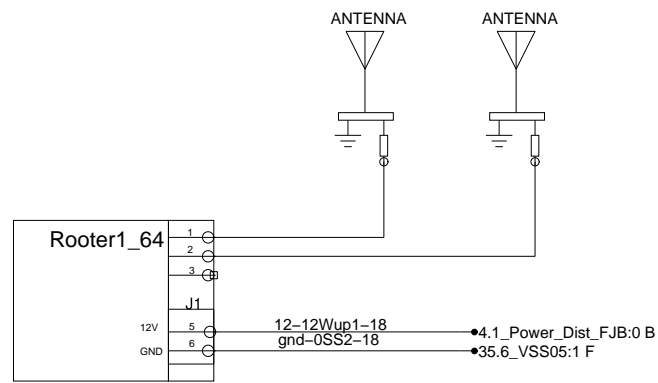

## WIRELESS INTERNET MODEL IMM2200

