

EXHAUST AFTERTREATMENT SYSTEM.....	4
FILTRATION AND REGENERATION UNIT	4
Passive regeneration	4
Active regeneration	4
Stationary (parked) regeneration	4
Initiating a Stationary (Parked) Regeneration	7
Voluntary Interruption of a Stationary Regeneration	7
SELECTIVE CATALYTIC REDUCTION UNIT	8
DIESEL EXHAUST FLUID (DEF)	8
Diesel Exhaust Fluid (DEF) Consumption	8
SELECTIVE CATALYTIC REDUCTION – DRIVER WARNING AND INDUCEMENT	9
DEF TANK LEVEL DRIVER WARNING AND INDUCEMENT.....	10
DEF QUALITY DRIVER WARNING AND INDUCEMENT.....	11
SCR SYSTEM TAMPERING DRIVER WARNING AND INDUCEMENT	12
DRIVER INFORMATION DISPLAY (DID) MENUS	13
DRIVING MODE MENUS	14
GAUGES	14
FUEL DATA	15
TIME/DISTANCE	16
PREVOST LIAISON (OPTION)	17
VEHICLE MESSAGES	17
NON-DRIVING/STATIONARY MODE MENUS	18
DISPLAY SETTINGS	18
DIAGNOSTICS.....	19
PRE-TRIP ASSISTANT (OPTION).....	20
DATA LOG	22
AFTERTREATMENT.....	23
PASSWORD	24
INTELLIGENT SLEEP MODE (ISM).....	25
TRANSMISSION RETARDER.....	25
ENGINE BRAKE	25
VOLVO ENGINE BRAKE (VEB).....	26
CRUISE CONTROL AND ENGINE BRAKE	26
ANTILOCK BRAKING SYSTEM (ABS), TRACTION CONTROL SYSTEM (TCS), ELECTRONIC STABILITY CONTROL (ESC)	27
ANTILOCK BRAKING SYSTEM (ABS).....	27
TRACTION CONTROL SYSTEM (TCS).....	27
ELECTRONIC STABILITY CONTROL (ESC)	27

5-2 Other Features

DRIVER CONTROLLED DIFFERENTIAL LOCK (DCDL)	28
OPERATION TIPS	28
LOCKING THE DCDL.....	28
UNLOCKING THE DCDL	29
KNEELING SYSTEM	29
HI-BUOY	29
LOW-BUOY	29
RETRACTABLE TAG AXLE	30
TAG AXLE UNLOADING	30
ENGINE COOLANT HEATER	30
SWITCHING THE HEATER ON	30
SWITCHING THE HEATER OFF	31
COOLANT HEATER TIMER	31
Timer A: Operating instructions	31
Viewing the Time (Ignition ON)	32
PREHEATER TROUBLESHOOTING AND MAINTENANCE.....	35
WHEELCHAIR LIFT SYSTEM	36
INTRODUCTION	36
OVERVIEW	36
Major lift components.....	36
OPERATING INSTRUCTIONS	38
Safety Precaution.....	38
Hand-Held Control Pendant and Motion.....	39
PLATFORM POSITION WITH INTERMEDIATE HEIGHT (OPTIONAL FEATURE)	39
MANUAL LIFT OPERATION.....	42
To Manually Deploy the Platform.....	43
To Manually Raise the Platform	44
To Manually Lower the Platform	45
To manually stow the platform	46
SEATS RECONFIGURATION	48
WHEELCHAIR RESTRAINT SYSTEMS	48
4-POINT SECUREMENT WITH FLOOR ANCHORAGE.....	48
Wheelchair Occupant Restraint.....	49
4-POINT SECUREMENT WITH ANCHORAGE TO PASSENGERS SEAT PEDESTALS	49
Wheelchair Occupant Restraint.....	50
WHEELCHAIR LIFT SYSTEM - THRESHOLD WARNING SYSTEM (TWS) ADJUSTMENT	50
ADJUST AIMING OF ACOUSTIC SENSOR BEAM.....	50
TEST AIM OF ACOUSTIC SENSOR BEAM	51
ADJUST ACOUSTIC SENSOR TIMING	51
WHEELCHAIR LIFT REMOVAL FOR STORING OR MAINTENANCE PURPOSES	51

WHEELCHAIR LIFT INSTALLATION..... 52

EXHAUST AFTERTREATMENT SYSTEM

The exhaust aftertreatment system consists of two units, the filtration and regeneration unit and the selective catalytic reduction SCR unit.

FILTRATION AND REGENERATION UNIT

The aftertreatment system primary function is to capture and oxidize (regenerate) the particulate matter (soot) in the engine exhaust gases and to reduce NOx. To achieve this goal, the exhaust aftertreatment system is split into two main sections: the exhaust gases first enter the **Diesel Oxidation Catalyst (DOC)** and **Diesel Particulate Filter (DPF)** assembly to capture and regenerate the soot on a regular or passive basis, then the exhaust gases flow through the **catalytic converter** to reduce NOx to minimum level. Through constant monitoring of the exhaust gas temperature and the system back pressure, EMS is able to manage regeneration.

Passive regeneration

Passive regeneration is the process by which the particulate matter is oxidized due to the heat generated by the engine internal combustion process. During normal highway operation, exhaust temperatures alone are usually high enough to oxidize accumulating soot. In low ambient temperatures, however, or in some stop-and-go applications, the system needs a little help to regenerate, or clean itself. This process is called "active" regeneration.

Active regeneration

Active regeneration is necessary when the engine internal combustion process alone does not generate enough heat. A dosing system injects a mist of diesel fuel into the exhaust system to increase and maintain the aftertreatment system temperature. Exhaust temperature must be above 572°F (300°C) to initiate the oxidation catalyst, which in turn oxidizes the injected diesel fuel molecules to achieve up to 1200°F (650°C) exhaust temperature at the particulate filter. This process of active regeneration takes place

during the normal operation cycle of the vehicle without charges in performance or control for the operator. EPA2010 compliant Volvo engines produce less soot, so less active or stationary regeneration will be required.







Stationary (parked) regeneration

In a small number of specific engine duty cycles, engine control module may not be capable of completing an active regeneration. In these situations, the operator will be notified that a stationary or parked regeneration may be required. A DPF telltale light will illuminate indicating the need for user interaction. The lamp gives the operator a grace period to allow this process to take place at a time when most convenient for the operator. This process requires the vehicle to be parked while a driver or maintenance technician initiates the regeneration process using the DID menus. Once initiated, the stationary regeneration process will be complete in about 45 minutes.

The driver will be notified of the need for a stationary regeneration (parked) by illumination of the DPF REGENERATION telltale light.

5-6 Other Features

Diesel particulate filter clogging sequence – Instrument cluster telltale light

<p>LEVEL 1</p>	 solid	<p>REGENERATION NEEDED</p> <p><i>Diesel particulate filter is becoming full</i></p> <p><i>The DPF REGENERATION telltale light illuminates to notify the driver that a stationary regeneration (parked) will be required soon. When this lamp is lit, initiate stationary regeneration process at an appropriate time of day. THERE IS NO URGENCY AT THIS LEVEL.</i></p>
<p>LEVEL 2</p>	 flashing	<p>REGENERATION REQUIRED</p> <p><i>Diesel particulate filter full</i></p> <p><i>If no DPF regeneration occurs after the initial DPF REGENERATION telltale light illumination, the lamp will begin blinking and a stationary regeneration should be initiated as soon as possible in order to prevent from entering into Level 3.</i></p>
<p>LEVEL 3</p>	 flashing + 	<p>ATD SERVICE REQUIRED</p> <p>ENGINE DERATE ACTIVE</p> <p><i>Diesel particulate filter overfull</i></p> <p><i>If the flashing DPF REGENERATION telltale light is still ignored, the CHECK telltale light will illuminate. In that situation, engine performance is limited. Perform a parked regeneration IMMEDIATELY to avoid further derate and prevent from entering into Level 4.</i></p>
<p>LEVEL 4</p>	 flashing +  + 	<p>ATD SERVICE REQUIRED</p> <p>ENGINE SHUTDOWN ACTIVE</p> <p><i>A serious engine problem has occurred. The DPF may be over its maximum capacity.</i></p> <p><i>If a stationary regeneration is still not initiated, a standard Engine Protection Shutdown sequence will occur. All of the following dashboard lamps will be present:</i></p> <ul style="list-style-type: none"> • <i>Blinking DPF REGENERATION telltale light;</i> • <i>Solid CHECK telltale light;</i> • <i>Solid STOP telltale light.</i> <p><i>Once engine derate and/or shutdown sequence is completed, a stationary regeneration must occur to continue vehicle operation. If the driver continues to operate the vehicle without regeneration, additional measures will be taken to protect the engine and ATD from damage, up to and including engine shutdown. Parked regeneration might no longer be possible</i></p> <p>-----</p> <p><i>If engine protection has been initiated and forces the engine to shutdown, you <u>can</u> immediately <u>re-start</u> the engine and perform the necessary steps in order to initiate a stationary regeneration.</i></p> <p style="text-align: center;"><u>Find and solve the cause of the shutdown</u></p>

Initiating a Stationary (Parked) Regeneration

NOTE
 At starting of the engine, if a stationary regeneration is required, the engine coolant temperature must reach 140°F (60°C) before any stationary regeneration may be initiated and completed. Permit the engine to idle for a short while or drive the vehicle until engine temperature increases sufficiently.

 **WARNING**
 Do not initiate a stationary regeneration in a closed area like a garage. Stationary regenerations must be undertaken outdoors only.

 **WARNING**
 During stationary regeneration, exhaust temperature may reach up to 1200°F (650°C) at the particulate filter. Before initiating stationary regeneration, make sure that the DPF outlet diffuser is clear of objects and that no one is working near the DPF outlet diffuser.

 **WARNING**
 Hot surfaces. Keep yourself clear of all hot Aftertreatment Device components, particularly during and after active or stationary regeneration. Hot surfaces can cause serious burns.

NOTE
STATIONARY REGENERATION
 This process requires the vehicle to be parked while the driver or a maintenance technician initiates the regeneration process.

The DPF REGENERATION telltale light illuminates to notify the driver of the need and urgency of a manual stationary regeneration.



DPF REGENERATION telltale light

If stationary regeneration is not performed, this telltale light will blink, indicating that a stationary regeneration is required immediately. If stationary regeneration is still not performed,

“engine power derate and shutdown” sequence may occur as per level 1 to level 4 sequence.

To initiate a stationary regeneration:

- Park the vehicle in a clear area, vehicle speed must be 0 mph (0 km/h);
- Engine must be on normal idle and fully warmed up (coolant temperature above 140°F/60°C);
- Apply parking brakes and set the transmission to neutral (N).
- Press the DID ENTER button and then get to the DID Aftertreatment menu. Select sub-menu Request Parked REGEN and press ENTER button to confirm and initiate regeneration.

The regeneration will begin. Turn off the air conditioning to reduce engine load. The engine idling speed will increase to 1600 rpm. Once the regeneration is completed, the engine speed will return to normal idle.

Voluntary Interruption of a Stationary Regeneration

It is possible to interrupt a stationary regeneration at all time. To do so, get to the DID's Aftertreatment menu, select Cancel REGEN and press ENTER button to confirm. You can stop regeneration simply by releasing the parking brake. Use this procedure in order to move the vehicle in a safe area only.

If regeneration is interrupted, it is very important to reinitiate the regeneration as soon as possible.

 **CAUTION**
 If an active regeneration is stopped repeatedly, the vehicle may need to be taken to a service facility. The service facility will use a service tool to manually initiate the regeneration. Moreover, the interruption of active regeneration should not be considered as a normal practice. Some components of the aftertreatment system might be damaged in the long term.

SELECTIVE CATALYTIC REDUCTION UNIT

Selective Catalytic Reduction (SCR) is a technology that uses Diesel Exhaust Fluid (DEF) and a catalytic converter to reduce nitrogen oxides (NOx) emissions.

SCR is an exhaust aftertreatment system that injects small amount of DEF into the exhaust gas between the DPF and the selective reduction catalytic converter. DEF turns to ammonia and carbon dioxide when heated. The exhaust stream then passes over a catalyst, the ammonia reacts with the NOx to form nitrogen and water vapor.

The basic elements of the SCR system consist of a 15.9 gallons (60 liters) DEF tank complete with pump, lines and heating system, a dosing injector, a catalytic converter and the control and monitoring system.

DIESEL EXHAUST FLUID (DEF)

When handling DEF solution, keep electrical connectors properly connected or well encapsulated, otherwise there is a risk that the DEF will cause oxidation that cannot be removed. Water or compressed air will not help, since DEF quickly oxidizes certain metals. If a disconnected connector comes into contact with the DEF solution, it must be replaced immediately to prevent the DEF solution from creeping further into the copper wiring, which takes place at a speed of about 2.4 in (60 mm) per hour.

 CAUTION
<p>Diesel Exhaust Fluid (DEF) is a nontoxic aqueous solution of urea (32.5%) and ultra-pure water (67.5%). Urea is a compound of nitrogen that turns to ammonia when heated. The fluid is non-flammable, and is not dangerous when handled as recommended. However, it is highly corrosive to certain metals, especially copper and brass.</p> <p>When detaching hoses and components, do not spill DEF on disconnected or unsealed connectors. If DEF is spilled on a disconnected or unsealed connector, the connector must be removed immediately and replaced.</p>

Things to know about spilt diesel exhaust fluid (DEF):

- If urea solution comes into contact with the skin, rinse with plenty of water and remove contaminated clothing.
- If urea solution comes into contact with the eyes rinse for several minutes and call for medical help if necessary.
- If inhaled breathe fresh air and call for medical help if necessary.
- Do not allow the DEF solution to come into contact with other chemicals.
- The DEF solution is not flammable. If the DEF solution is exposed to high temperatures, it breaks down into ammonia and carbon dioxide.
- The DEF solution is highly corrosive to certain metals, including copper and aluminum.
- If the DEF solution is spilled onto the vehicle, wipe off the excess and rinse with water. Spilled DEF solution can form concentrated white crystals on the vehicle. Rinse off these crystals with water.

 WARNING
<p>DEF spilt onto hot components will quickly vaporize. Turn your face away!</p>

 CAUTION
<p>DEF freezing and expansion</p> <p>DEF will begin to crystallize and freeze at 12°F (-11°C). DEF expands by approximately 7% when frozen. During freezing weather, do not store a DEF container on the coach unless it is designed to allow for expansion.</p> <p>Make sure the DEF container is not completely full. DEF expansion may split an inappropriate container, causing a spill and corrosion as a result.</p>

Diesel Exhaust Fluid (DEF) Consumption









DEF consumption is related to fuel consumption. In order to meet EPA2010 requirements, DEF tanks are sized so one refill will be necessary every two refill of the fuel tank.

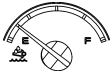

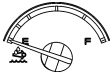

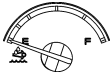

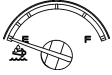

SELECTIVE CATALYTIC REDUCTION – DRIVER WARNING AND INDUCEMENT

SCR system components must not be removed, altered or modified in any way. In order to protect the SCR system from tampering, inducement measures will occur if the following states are detected:









- Disconnection of DEF tank level sensor
- Blocked DEF line or dosing valve
- Disconnection of DEF dosing valve
- Disconnection of DEF pump
- Disconnection of SCR wiring harness
- Disconnection of NOx sensor
- Disconnected exhaust temperature sensor
- Disconnected DEF temperature sensor
- Disconnected DEF quality sensor

5-10 Other Features

DEF TANK LEVEL DRIVER WARNING AND INDUCEMENT				
Conditions / Triggers		DEF Tank LOW LEVEL Indicator, DID Message and audible warning		Inducement
1	Normal DEF tank level sensor reads between 100% and 12%	None		None
2	Low DEF tank warning DEF tank level sensor reads between 12% and 0.1% 	 solid	DEF TANK LEVEL LOW REFILL DEF SOON TO PREVENT ENGINE DERATE  3 cycles of 2 beeps	Warning message
3	DEF tank near empty DEF tank level sensor reads less than 0.1% 	 blinking	DEF TANK EMPTY REFILL DEF AT NEXT STOP TO AVOID 5 MPH LIMIT ENGINE IN DERATE  3 cycles of 2 beeps	Engine torque reduction of 25%
4	DEF tank empty and one (1) hour of operation in engine derate mode 	 blinking	DEF TANK EMPTY 5 MPH (8KM/H) LIMIT NEXT 20MIN VEHICLE STOP  3 cycles of 2 beeps	Engine torque reduction of 40%
5	DEF tank empty and either  <ol style="list-style-type: none"> Diesel fuel refueling done with a fuel level sensor reading increase of 15%, or more Vehicle stationary (speed=0) for 20 minutes with engine off or at idle 	 blinking	REFILL DEF TANK VEHICLE SPEED LIMITED TO 5 MPH (8 KM/H)  continuous cycle of 2 beeps	Vehicle road speed limited (RSL) to 5 mph (8 km/h) <i>Note: The vehicle has to be stationary before 5 mph (8 km/h) road speed limit becomes active</i>

DEF QUALITY DRIVER WARNING AND INDUCEMENT				
Conditions / Triggers		Amber Warning Light & Did Message And Audible Warning		Inducement
1	Good DEF quality	None		None
2	Poor DEF quality detected	 solid	POOR DEF QUALITY DETECTED SERVICE DEF SYSTEM AT NEXT STOP  3 cycles of 2 beeps	Warning message Engine will derate 25% in < 60 mins
3	Poor DEF quality detected and one (1) hour of operation with active diagnostic troubleshooting code	 solid	POOR DEF QUALITY DETECTED ENGINE IN DERATE 5 MPH (8KM/H) LIMIT IN < XXX MINS  3 cycles of 2 beeps	Engine derated 25% Engine will derate 40% in <240 mins
4	Poor DEF quality detected and four (4) hours of operation with active diagnostic troubleshooting code	 solid	SERVICE DEF 5 MPH (8KM/H) LIMIT NEXT 20MIN VEHICLE STOP  3 cycles of 2 beeps	Engine derated 40% 5 mph (8km/h) limit after next 20 min vehicle stop
5	Poor DEF quality detected Diesel fuel refueling done with a fuel level sensor increase of 15% or more or Vehicle stationary (speed=0) for 20 minutes with engine off or at idle or Key cycle trigger	 solid	SERVICE DEF VEHICLE SPEED LIMITED TO 5 MPH (8 KM/H)  continuous cycle of 2 beeps	Service DEF Vehicle road speed limited (RSL) to 5 mph (8 km/h) <i>Note: The vehicle has to be stationary before 5 mph (8 km/h) road speed limit becomes active</i>

5-12 Other Features

SCR SYSTEM TAMPERING DRIVER WARNING AND INDUCEMENT				
Conditions / Triggers		Amber Warning Light, Did Message And Audible Warning		Inducement
1	Normal No diagnostic troubleshooting code active	None		None
2	SCR system tampering diagnostic troubleshooting code confirmed	 solid	SCR SYSTEM FAULT SERVICE SYSTEM AT NEXT STOP  3 cycles of 2 beeps	Warning message
3	Reached one (1) hour of operation with active SCR system tampering diagnostic troubleshooting code confirmed	 solid	SCR SYSTEM FAULT ENGINE IN DERATE 5 MPH (8KM/H) LIMIT IN < XXX MINS  3 cycles of 2 beeps	Engine torque reduction of 25%
4	Reached four (4) hours of operation with active SCR system tampering diagnostic troubleshooting code confirmed	 solid	SCR SYSTEM FAULT REPAIR NEEDED 5 MPH (8KM/H) LIMIT NEXT 20MIN VEHICLE STOP  3 cycles of 2 beeps	Engine torque reduction of 40%
5	Diesel fuel refueling done with a fuel level sensor increase of 15% or more	 solid	SCR SYSTEM FAULT VEHICLE SPEED LIMITED TO 5 MPH (8 KM/H)  continuous cycle of 2 beeps	Vehicle road speed limited (RSL) to 5 mph (8 km/h)

DRIVER INFORMATION DISPLAY (DID) MENUS

There are Driving and Non-Driving menus. Several sub-menus are password-protected while the vehicle is parked. The Non-Driving menu is accessible only when the vehicle is parked.

DRIVING MODE MENUS	NON-DRIVING/STATIONARY MODE MENUS
Gauges <ol style="list-style-type: none"> 1. Current Gear Position (I-Shift) 2. Outside Temperature 3. Engine Oil Temperature 4. Transmission Fluid Temperature 5. Prevost Liaison Compass 6. Accessories Air Pressure 7. A/C Compressor Pressure 8. Battery Voltage 9. Allison Transmission Oil Life 10. Battery State Of Charge 11. Electric Cooling Fan Status 	Display Settings <ol style="list-style-type: none"> 1. Language 2. Units 3. Time/Date 4. Favorite Display Setting 5. Display Light 6. Change Password
Fuel Data <ol style="list-style-type: none"> 1. Fuel Flow / ECO % 2. Trip Fuel Used 3. Distance to Empty 	Diagnostics <ol style="list-style-type: none"> 1. View Active Faults 2. View Inactive Faults 3. Cluster Self Test 4. Part Number 5. Reset Inactive Faults 6. Vehicle Tests
Time-Distance <ol style="list-style-type: none"> 1. Time and Date 2. Alarm Clock 3. Trip Odometer 1 and 2 4. Average Trip Speed 5. Estimated Time of Arrival (ETA) 	Pre-Trip Assistance <ol style="list-style-type: none"> 1. Exterior Light Inspection 2. Air Leakage Monitor
Prevost Liaison <ol style="list-style-type: none"> 1. Read Message 2. Send Message 3. Other Info 	Datalog <ol style="list-style-type: none"> 1. Vehicle ID 2. Total Data 3. Trip Data 4. Reset Trip Data
Vehicle Messages	Aftertreatment <ol style="list-style-type: none"> 1. Request Parked REGEN 2. ATS Status 3. Cancel REGEN
Reset Trip Data	Password <ol style="list-style-type: none"> 1. Enter Password

DRIVING MODE MENUS

GAUGES

There are several gauges in this menu. The gauges are used to view current status of important functions in the vehicle.

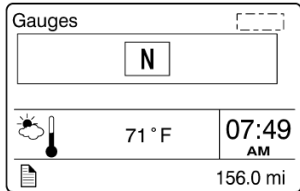

- 1. Current Gear Position (I-Shift transmission only)**
 Indicates the current gear position selected on the I-Shift transmission.
 D= drive
 N= neutral
 R= reverse
 M= manual

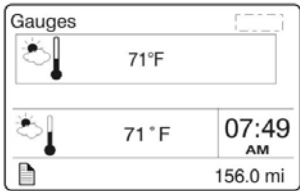

- 2. Outside Temperature**

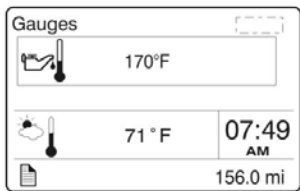

- 3. Engine Oil Temperature**
 Selecting this gauge will display the engine oil temperature.

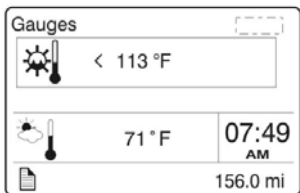

- 4. Transmission Fluid Temperature**

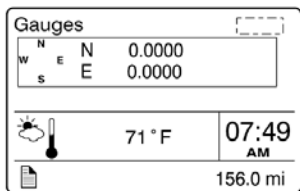

- 5. Prevost Liaison Compass**

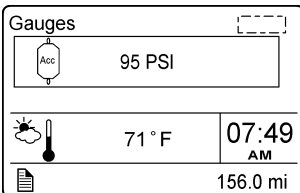

- 6. Accessories Air Pressure**

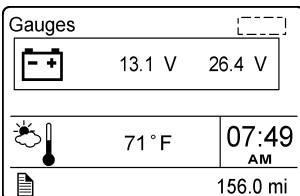

- 7. Battery Voltage**
 Displays current 12-volts and 24-volts systems voltage.

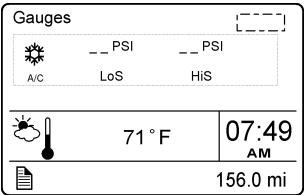

8. A/C Compressor Pressure

Displays the A/C compressor suction pressure value (LoS=low side) and discharge pressure value (HiS=high side).

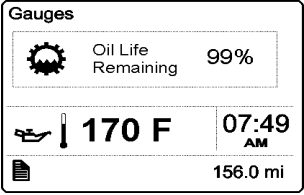

9. Allison Transmission Oil Life

Displays the percentage of the calculated remaining life of the transmission oil. New oil is displayed as 99%. Refer to Appendix C for more details.

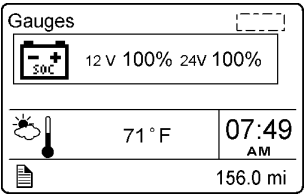

10. Battery State Of Charge

Displays the state of charge of the 12-volt and 24-volt systems, expressed in percentage.

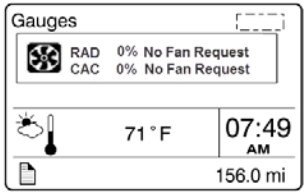

11. Electric Cooling Fan Status

Displays the speed and the state of both Charge Air Cooler and radiator cooling fans, expressed in percentage from 0 to 100%.

FUEL DATA

The Fuel Data menu provides information on the fuel consumption of the vehicle in various situations. For example, how much fuel has been used, how much fuel is remaining before refueling the vehicle.

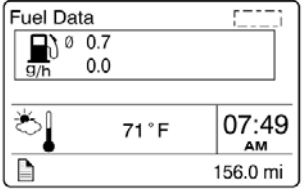

1. Fuel Flow (gph)

The lower numerical value indicates the instantaneous fuel consumption. In this menu, you can reset the upper numerical value which is the average fuel consumption. To reset, hold ENTER button for 1 second.

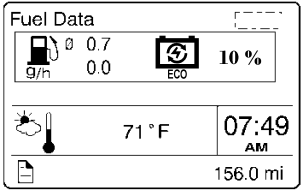

Displays the percentage of trip made on regenerated electricity.

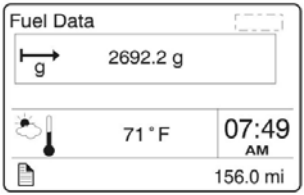

2. Trip Fuel Used

Indicates the total fuel consumption (gallons/liters) since the last reset. Note: You should use Reset function before each new trip.

You can reset the fuel consumption value in this menu. To reset, hold ENTER button for 1 second.

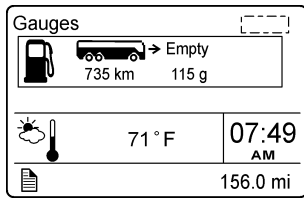

3. Distance to Empty

The left numerical value indicates the distance that can be traveled with the quantity of fuel that remains in the tank as indicated by the right numerical value.

TIME/DISTANCE

The time and date can be set in the Time/Distance menu. The alarm clock can also be set from this menu. Following the alarm clock menu is the Trip Odometer 1 and 2 selection, which allows the operator to see the distance travelled since the last reset. Average trip speed is also shown. By specifying the distance to your destination, the vehicle can calculate the estimated time of arrival (ETA).

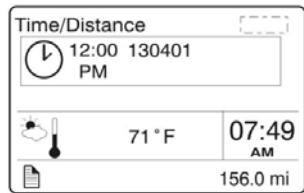

1. Time And Date

Adjust time and date with this menu. The instrument cluster has its own internal battery, so the date and date setting is keep in memory even if the vehicle's battery is disconnected.

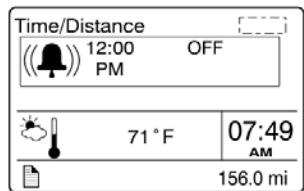

2. Alarm Clock

Use this function to program and activate an alarm on the instrument cluster clock. When the alarm clock goes off, a warning signal is sounded. The alarm shuts off after 60 seconds or if the ESCAPE button is depressed.

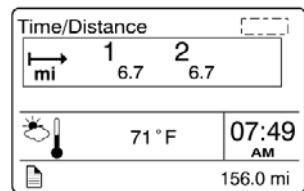

3. Trip Odometer 1 and 2

Allows the operator to see the distance travelled since the last reset. You can reset the trip odometer 1 or 2 in this menu. To reset, depress ENTER button, use UP/DOWN button to select between odometer 1 or 2 and then hold ENTER button for 1 second.

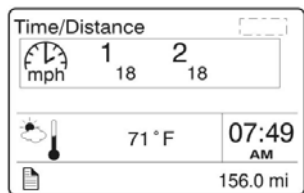

4. Average Trip Speed

This function displays the average speed for the current travel. The average trip speed is calculated as the distance traveled divided by the time the engine has been running (since the last reset). Two average trip speeds can be measured, corresponding to leg 1 and leg 2. Use Reset function before each new travel to start new measurements.

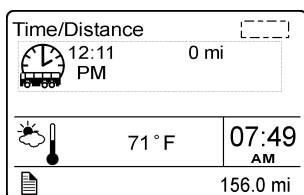

5. Estimated Time of Arrival (ETA)

This function will display the estimated time of arrival if the distance to be traveled is entered first, in this menu. To set distance to be traveled, press ENTER and enter the distance left to drive in mile or km using ENTER and UP/DOWN buttons.

PREVOST LIAISON (OPTION)

The Prevost Liaison system provides cellular communication between the driver and the fleet operator. The driver can send and receive short text messages, which are visible through the Driver Information Display.

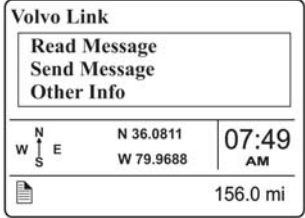

The following menus are available:

- 1. Read Message**
 - Quick Response (only available if there is a message available)
- 2. Send Message**
 - Driver & Equipment
 - Dispatch Messages
 - Free Text
- 3. Other Info**
 - Comm Liaison Info
 - Mailbox Info
 - GPS Info
 - INI Info
 - Configuration Info

VEHICLE MESSAGES

Use this function to consult the vehicle active messages that were previously displayed as pop-up messages and then acknowledged. When consulting a message, the corresponding STOP, CHECK or INFORMATION warning light will illuminate. Scroll through the messages using the up/down button. Press ESC button to return to main menu.

RESET TRIP DATA

When the Reset Trip Data menu is open, pressing and holding down the Enter button for more than 1 second resets the functions listed below. This function will permit to the system to calculate new value from the point of resetting.

- Trip Fuel Used
- Average Trip Speed

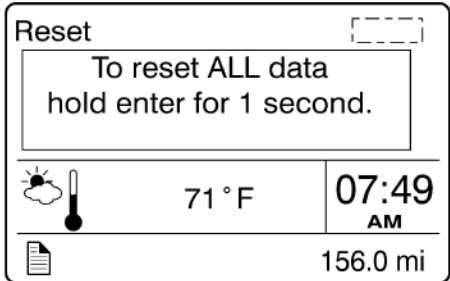

NON-DRIVING/STATIONARY MODE MENUS

DISPLAY SETTINGS

The Display Settings menu is used to change languages and units. The password, time and date can also be changed. The backlight and contrast of the display screen can be adjusted.

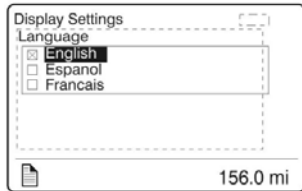

1. Language

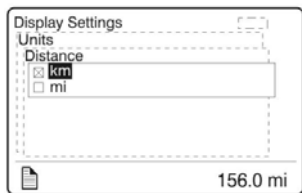

2. Units

Use this function to select desired unit formats for:

- Distance (miles or km);
- Fuel consumption (km/l, l/100km, mpg US or IMP);
- Temperature (°C or °F).

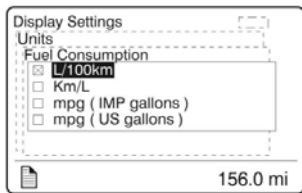

3. Time/Date

Select the time and date format (am, pm, 24h) using this function.

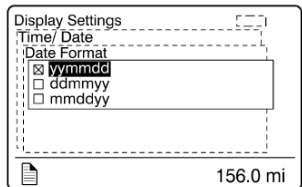

4. Favorite Display Setting

Use this menu to select your favorite display gauges 1, 2 and 3 and replace the default gauges. On vehicles provided with the I-Shift transmission, Favorite Display Gauge 3 cannot be edited as it is kept for display of the transmission status.

Example: You wish to display the engine oil temperature at the Gauge 1 position.

1. Use UP/DOWN button until Gauge 1 position is selected.
2. Press ENTER button to confirm.

Use UP/DOWN button to scroll through the available gauges. When the engine oil temperature gauge is displayed, press ENTER button to confirm (repeat steps 1-3 to change Gauge 2 and Gauge 3 if needed).

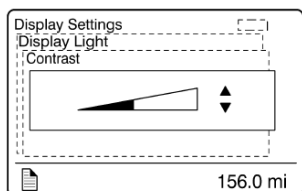

5. Display Light

The Display Light menu has three sub-menus:

- Contrast

Adjust the contrast with the UP/DOWN button and press ENTER button to confirm.

- Backlight

In this menu, the display lighting can be adjusted relative to other instrument lighting with the UP/DOWN button.

- Night/Day

Use the Night/Day menu to choose a dark background with light text and images or a light background with dark text and images. Press ENTER button to toggle between Night and Day.

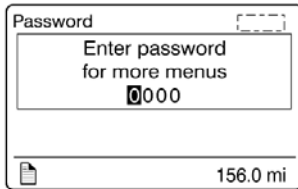

6. Change Password

Use this menu to change the current password. This menu is only accessible if the correct password is entered. The default password is 0000.

1. Mark which password is to be changed with the display UP/DOWN button.
2. Confirm with ENTER button.
3. Set the first digit with the UP/DOWN button.
4. Step to the next digit using ENTER button.
5. Step backwards with ESC button.

DIAGNOSTICS

The Diagnostics menu enables fault tracing on the control units in the vehicle to check for faults. Instrument tests are available to check the telltales, gauges, display and speaker. The part number of a control unit can be identified in the part number menu.

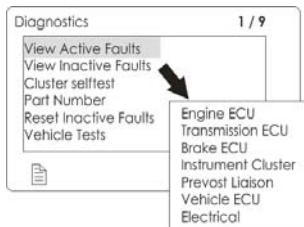

1. View Active Faults

A list of the control units on the vehicle is displayed. Use this function to check for active faults on specific control units.

2. View Inactive Faults

Use this function to check for inactive faults on specific control units.

3. Cluster Selftest

Use this menu to check proper functioning of the following components:

- Telltale lights
- Analog gauges
- Display
- Speakers

The following table describes the available tests. To cancel a test, press the ESC button).

Telltale lights test	Telltales illuminate for approximately five seconds. Press the Esc button to cancel the test.
----------------------	---

Analog gauges	The indicators move forwards and backwards between the end positions. They do not show any particular value. This is just a check to confirm that the indicators move, and to make sure the operators are working. Press the Esc button to cancel the test.
Display test	The entire display lights up until the Esc button is pressed.
Speaker Test	A sound is emitted through the speakers. Press the Esc button to cancel the test.

4. Part Number

A list of the control units on the vehicle with their part numbers is displayed in the Part Number menu.

5. Reset Inactive Faults

Use this menu to delete an inactive fault for a particular control unit. Note: it is not possible to delete inactive faults of the Engine ECU.

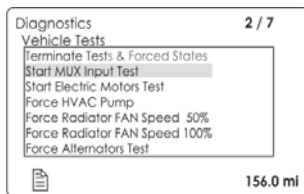

6. Vehicle Tests

Use this menu to perform tests on several components and systems:

- dashboard switches (Mux Input Test)
- electric motors, valve and pump contactors (Electric Motors Test)

In case of overheating of the engine due to a malfunction of the radiator fan you can force activation of the fan using ACTIVATE RADIATOR FAN SPEED 50% or 100%.

The DID status line will show TEST to confirm that one of the test modes is active. To cancel an active test, turn the ignition switch to the OFF position or press ESCAPE button, select TERMINATE TESTS & FORCED STATES submenu and then press ENTER button twice. "TEST" will disappear from the DID status line.

For further information concerning these functions, refer to section 06: Electrical, under "Available Test Modes" and "Limp-home Modes" paragraph of the Maintenance Manual.

PRE-TRIP ASSISTANT (OPTION)

The Pre-Trip Assistance option is a tool to assist the driver in completing the pre-trip inspection of the vehicle. This option is not a substitute for a complete pre-trip inspection. If any system of the vehicle does not pass inspection, the error must be corrected before operating the vehicle. The available pre-trip tests include the Exterior Light Inspection check, and the Air Leakage check.

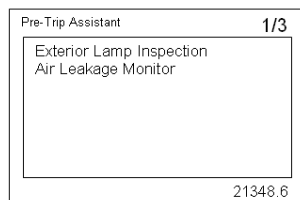



1. Exterior Light Inspection

The Exterior Light Inspection function turns on all the exterior lights simultaneously. This allows the operator to start the test, exit the vehicle and do a visual check that all exterior lights function properly. Press ESCAPE button to end the test and turn off all the exterior lights.

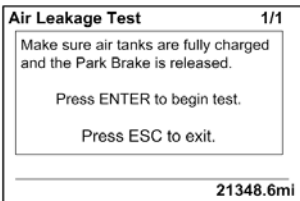
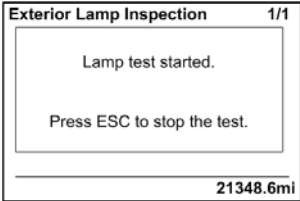

2. Air leakage Monitor

The Air Leakage check allows the driver to accurately measure the amount of air pressure drop in the front and rear brake air systems. After selecting this test from the DID, you are prompted to apply the service brake for 60 seconds. After applying and holding the service brake for 60 seconds, the DID will display the amount of pressure drop in the brake system.

Before starting the test through the DID, complete the following:

- a. Chock the wheels to prevent the vehicle from rolling.
- b. Start the engine and check that the brake systems air pressure is greater than 100 psi.
- c. Turn engine off.
- d. Release the parking and service brakes and allow the system to settle (air gauge needle stops moving).
- e. Press the ENTER button to start the test.
- f. If the air tanks pressure is too low to perform the test (pressure must be greater than 100 psi), the following messages will appear.
- g. You must press and hold brake pedal for 60 seconds, as instructed.
- h. Once the brake pressure test is completed the pressure leak test results are displayed.

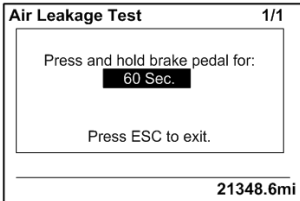
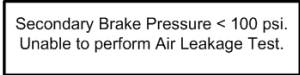
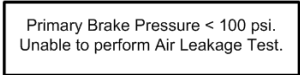

Pressure Leak Test Results

Tank	Before	After	Drop
F	127	127	0
R	129	129	0

(1)VEC 2044.6mi

DATA LOG

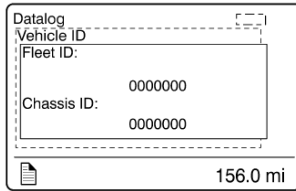

1. Vehicle ID

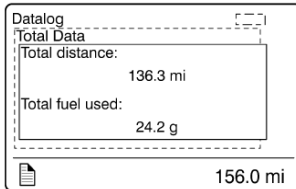

2. Total Data

Total Data menu indicates the accumulated engine values that have been logged during the lifetime of the engine ECU.

Available information:

- Total distance traveled
- Total fuel used
- Total engine hours
- Total idle time
- Total PTO hours
- total engine revolutions

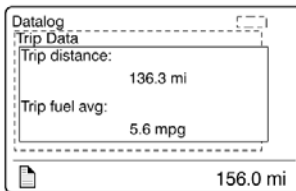

3. Trip Data

This menu displays the trip information listed below. This function must be reset before each measurement (before each new trip or leg) using the Reset Trip Data menu.

Available information for the trip or leg is:

- Trip distance (miles or km)
- Trip fuel average (mpg, liter/100km; km/liter)
- Trip fuel used (gallons or liters)
- Trip duration on cruise control (hours)
- Trip duration with engine rpm greater than economy rpm (hours)
- Trip duration while engine rpm is greater than the desire maximum rpm RPM Limit set in Fleet Limits sub-menu (hours)
- Trip fuel used with engine rpm greater than the economy rpm (gallons/liters)
- Trip average speed (mph, km/h)
- Trip duration with speed greater than the maximum desired speed as set in Fleet Limits sub-menu (hours)
- Trip engine hours
- Trip duration on engine idle (hours)
- Trip fuel used while in engine idle (gallons, liters)

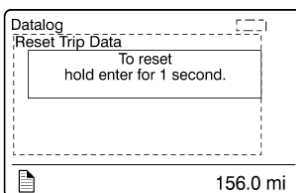

4. Reset Trip Data

This menu can only be accessed if the correct password has been entered. Use this function to reset measurements of the Trip Data menu before each new trip or leg.

AFTERTREATMENT

This menu permits to the driver to initiate a stationary regeneration, to check the status of the aftertreatment system and to interrupt regeneration.

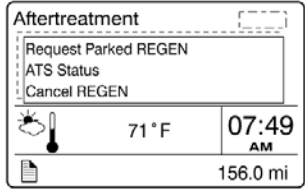

1. Request Parked REGEN

Use this function to initiate a stationary (parked) regeneration.

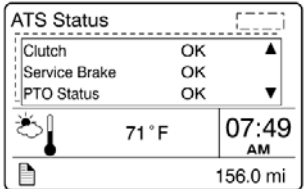

2. ATS Status

The Aftertreatment status sub-menus provide information about the conditions required for performing regeneration. The status can be OK (regeneration allowed), CHECK (regeneration not allowed) or N/A (not applicable). When ATS Status is selected, the following sub-menus are available.

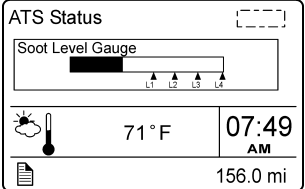
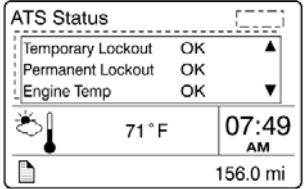
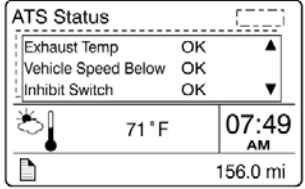
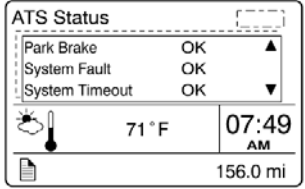
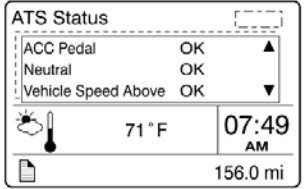

Soot Level Gauge

From the ATS Status sub-menu, you can view the soot level for the Aftertreatment system. When the soot level is high, regeneration is necessary. L1, L2, L3 and L4 under the scale correspond to Level 1 up to Level 4 (see Diesel particulate filter clogging sequence – Engine indicator lamp).



3. Cancel REGEN

From the Aftertreatment main menu, you can cancel a REGEN cycle.

PASSWORD

Certain functions are password-protected. These passwords give the user access to all password-protected functions. The default password is 0000.

1. Password

The following menus are password-protected and marked with a key symbol in the menus:

- Change Password
- Fleet ID
- Reset Trip Data
- Fault Diagnostics
- Inactive Faults

INTELLIGENT SLEEP MODE (ISM)

The ISM is a battery-saving feature designed to monitor the battery State Of Charge (SOC). The ISM will automatically change the vehicle electrical system from normal functional state to sleep mode if the battery SOC falls below 65%.

Once the vehicle has entered into sleep mode, the only actions needed to put the vehicle back into its normal functional state are:

- To cycle the ignition key from OFF to ON;
or
- To open the entrance door;
or
- To turn on the hazard lights.

The ISM forces the vehicle to go into sleep mode if all the following conditions are met:

1. The engine is not running;
2. The parking brake is applied
3. The ignition switch is at the ON, ACC positions or at the OFF position but the 15 minutes “wake up” period after engine shutdown is not expired.
4. The battery state of charge of 12V or 24V system falls below 65%.

The red ALTERNATOR telltale will illuminate 30 seconds before activation of the sleep mode.



TRANSMISSION RETARDER

The transmission retarder is an optional device that helps to reduce the speed of a vehicle. It improves vehicle control, increases driving safety and permits more economical operation. The retarder provides slowing power when it is most needed, such as when descending mountain roads, in stop-and-go traffic and on crowded freeways.

The transmission retarder is a vehicle-slowng device, not a vehicle-stopping device. It is not a substitute for the service braking system. The service brake must be used to bring the vehicle to a complete stop.

The retarder is provided with control buttons on the steering wheel and a lever on the steering column (refer to “CONTROLS AND INSTRUMENTS” chapter).

NOTE

Extended use will raise the temperature of the transmission fluid.

The retarder helps reduce speed on grades without using the vehicle's conventional service braking system. This virtually eliminates brake overheating and reduces the risk of a runaway vehicle. A retarder greatly increases the service life of brake pads and discs, resulting in reduced brake maintenance costs.

NOTE

The stoplights automatically illuminate when the vehicle is slowing down after application of the transmission retarder.

NOTE

For vehicles equipped with the Antilock Braking System (ABS), as the wheels start to lock up on slippery roads, the output retarder automatically deactivates until the wheels roll freely.

ENGINE BRAKE



WARNING

A vehicle speed retarding device (such as engine brake) is not intended to replace the service brake systems on your vehicle nor intended to bring your vehicle to a stop. A vehicle speed retarding device is only intended to reduce the speed of your vehicle under certain conditions.

Several types of engine brake can be installed or are standard on certain engines. All are used to reduce wear on the vehicle brake linings.



WARNING

When descending significant grades, use the service brake as little as possible. If the engine does not slow the vehicle to a safe speed, apply service brake and shift to a lower range. Let the engine (and engine brake) slow the vehicle. Keep brakes cool and ready for emergency stopping.

VOLVO ENGINE BRAKE (VEB)

On vehicles equipped with the Volvo Engine Brake (VEB), the engine brake mode is by default, set to the AUTO mode (A) at vehicle start-up.

When running in AUTO (A) mode, the engine brake is gradually applied to 100% of the braking power when the driver *pushes the brake pedal*. Since AUTO (A) mode will not reduce vehicle momentum unless the brakes are applied, it will have no impact on fuel consumption.

The driver can also choose two other modes using the steering wheel switches; Engine brake LOW (1) and engine brake HIGH (2).

When set to the engine brake LOW (1) mode, 50% of the engine brake power will be applied when the driver *releases the accelerator pedal*. Using engine brake HIGH (2) will apply 100% of the braking power.

It must be noted that since engine brake LOW (1) and engine brake HIGH (2) will reduce vehicle speed upon release of the throttle pedal, they may negatively impact fuel consumption if used for extended periods of time.

On vehicles equipped with an engine brake switch, it is possible to deactivate the engine brake (OFF mode). To do so, the driver must press the engine brake switch located on the left side of the dashboard.



Engine Brake Switch

NOTE
When using engine brake LOW (1) or HIGH (2) mode, pressing the steering switch OFF button will switch back to the default AUTO (A) mode.

DRIVER PEDALS	ENGINE BRAKE MODE	ENGINE BRAKE FORCE
---------------	-------------------	--------------------





ANY POSITION		0%
ACCELERATOR PEDAL RELEASED		0%
BRAKE PEDAL PUSHED		100%
ACCELERATOR PEDAL RELEASED		50%
		100%

ENGINE BRAKE FORCE APPLIED ACCORDING TO SELECTED MODE AND DRIVER PEDAL POSITION.

NOTE
Engine brake is safe to use in any road conditions including adverse conditions.

CRUISE CONTROL AND ENGINE BRAKE

When cruise control is enabled by the driver, the engine brake mode is forced to AUTO (A) mode and the engine brake will progressively engage up to 100% if the selected cruise speed is exceeded by approximately 2 Km/h (1.25 mph). Manually switching to engine brake LOW (1) or HIGH (2) using the steering switches will deactivate the cruise control.

CRUISE CONTROL & SPEED	ENGINE BRAKE MODE	ENGINE BRAKE FORCE
 + CRUISE SPEED SET + 2 Km/h		0%
		UP TO 100%
		N/A
		N/A

ENGINE BRAKE FORCE APPLIED WITH CRUISE CONTROL

NOTE

On vehicles equipped with the Allison transmission, if cruise control is enabled, the current engine brake mode is saved in the vehicle computer (MCM) memory and the engine brake mode is set to Auto mode (A). When the cruise control is disabled, the engine brake mode changes back to the mode saved in the MCM memory.

ANTILOCK BRAKING SYSTEM (ABS), TRACTION CONTROL SYSTEM (TCS), ELECTRONIC STABILITY CONTROL (ESC)

ANTILOCK BRAKING SYSTEM (ABS)

The purpose of the Antilock Braking System (ABS) is to maintain vehicle stability and control during braking and to minimize the stopping distance in any road condition.

On slippery roads and more generally in emergency situations, over-braking frequently induces wheel locking. Wheel locking greatly increases breaking distance on any road

surface. Locked wheels also impede directional control and cause severe tire abrasion. An antilock braking system provides maximum braking performance while maintaining adequate control on slippery roads.

The basis of ABS is constant monitoring of wheel parameters during braking. Sensors on each wheel of the front, drive and tag axles constantly measure wheel speed during braking. This information is transmitted to a six-channel electronic processor which senses when any wheel is about to lock. Modulating valves quickly adjust brake pressure (up to 5 times every second) to prevent wheel lock. Each wheel is therefore controlled according to the available grip.

In this way, the vehicle is brought to a stop in the shortest possible time while remaining stable and under the driver's control.



WARNING

Vehicles following ABS-equipped vehicles may not be able to brake as fast on slippery roads.

TRACTION CONTROL SYSTEM (TCS)

TCS controls wheel spin during vehicle acceleration to improve traction.

- The TCS system will intervene automatically and apply braking pressure to a spinning wheel transferring engine power to the other drive wheel that have better traction. This feature is active only at speeds below 25 mph (40 km/h).
- If all of the drive wheels begin to spin, the TCS system will reduce engine throttle to improve traction at all of the drive wheels.

If drive wheels begin to lose traction during acceleration, TCS will engage automatically to assist the driver in accelerating the vehicle. The TCS icon in the DID will flash rapidly to let you know whenever TCS is actively functioning.

ELECTRONIC STABILITY CONTROL (ESC)

The ESC stability system is an optional feature for ABS-equipped vehicles that reduces the risk of rollovers and loss of control. The ESC system

features include the RSP Roll Stability Program and Yaw Control.

The RSP system counteracts the tendency of a vehicle to tip over while changing direction (typically, while turning).

To reduce the risk of rollover, the RSP system detects potential rollover conditions and slows the vehicle both by reducing engine throttle (and hence, engine torque) and by applying service brakes as needed at the appropriate wheels.

 WARNING
<p>During an RSP system intervention, the vehicle automatically decelerates. The RSP system can slow the vehicle with or without you applying the brake pedal, and even when you are applying the throttle.</p>

During an RSP system intervention, you can always use your service brake pedal to increase the braking pressure that will be applied. However, if you were to apply less braking pressure than needed or even if you release the brake pedal entirely during an intervention, the RSP system will continue to apply the necessary amount of braking pressure automatically to the appropriate wheels to mitigate a potential rollover.

Yaw Control is a feature that reduces the risk of loss of control. If a vehicle's tires start to slide during a turn, Yaw Control counteracts the tendency of that vehicle to spin (or yaw), thereby reducing the risk of loss of control. Many factors, including road conditions, load distribution and driving behavior, can contribute to the development of a spin.

 WARNING
<p>In the case where a vehicle equipped with the ESC system pulls a trailer, the latter must be equipped with ABS.</p>

 CAUTION
<p>Even with ESC-equipped vehicles, the driver remains responsible for ensuring vehicle stability during operation.</p>

<p><i>NOTE</i></p>
<p>For further details, consult "Bendix ABS Operator's Manual".</p>

DRIVER CONTROLLED DIFFERENTIAL LOCK (DCDL)

<p><i>NOTE</i></p>
<p>The DCDL system is not available on vehicles equipped with a ZF A-132 drive axle.</p>

By actuating the electric switch, the driver can lock or unlock differential action.

The purpose of the DCDL is to provide maximum vehicle traction and control on unfavorable road surfaces. When the DCDL is actuated, a clutch collar completely locks the differential case, gearing, and axle shafts together. This feature maximizes traction to both wheels. The lock position will also protect against spinout damage to the differential. The DCDL should not be actuated when favorable road conditions exist.

OPERATION TIPS

1. The DCDL can be locked or unlocked if the vehicle is standing still or moving at a constant low speed when the wheels are not spinning, slipping, or losing traction.
2. When the DCDL is locked, operate the vehicle at low speeds. DCDL will not engage and will disengage in speed higher than 5 MPH (8 km/h).
3. When the DCDL is locked, the vehicle's turning radius will increase. This condition is called "understeer." The driver must use caution, good judgment and drive at low speeds when operating the vehicle with the DCDL locked.
4. Always unlock the DCDL as soon as the need for maximum traction has passed and the vehicle is traveling on a good road.
5. Do not lock the DCDL when the wheels are slipping or losing traction, or damage to the axle can result.
6. Do not lock the DCDL when the vehicle is traveling down steep grades, or potential loss of vehicle stability could occur.

LOCKING THE DCDL

When encountering poor road conditions where maximum traction is needed, follow the recommended procedures:

1. Without the wheels spinning, slipping or losing traction, flip the DCDL control switch to the "LOCK" position while maintaining a constant vehicle speed.
2. Let up momentarily on the accelerator to relieve torque on the gearing, allowing the DCDL to lock.
3. When the DCDL is fully locked, the vehicle will have an "understeer" condition when making turns. Proceed cautiously over poor road conditions.

UNLOCKING THE DCDL

When the vehicle can safely operate and driving conditions have improved, disengage the DCDL following the recommended procedures:

1. Flip the control switch to the "UNLOCK" position, when the vehicle is stopped or when traveling at low speed while the wheels are not spinning, slipping or losing traction.
2. Let up momentarily on the accelerator to relieve torque on the gearing, allowing the DCDL to unlock.
3. Resume driving at normal speed using good driving judgment.

KNEELING SYSTEM

This system lowers the front end, enabling passengers to get on and off the coach without any difficulty.

To operate:

1. Stop the coach and apply the parking brake;
2. Set the transmission to neutral (N);
3. Push down the kneeling rocker switch located on the L.H. control panel (Refer to "Controls & Instruments" chapter).

A status line pictogram will appear on the DID to indicate that the front of the coach is being lowered.

To raise the front of the coach to its normal height:

1. Push up the kneeling rocker switch. The front end will rapidly rise up.



CAUTION

Avoid parking the coach too close to the sidewalk or to other obstacles which could damage the coach during kneeling.

NOTE

Kneeling is disabled when the entrance door is open.

HI-BUOY

The coach may be equipped with the optional front Hi-Buoy or full Hi-Buoy. The front Hi-Buoy system has the same functions as front kneeling. In addition it enables passengers to get on or off the coach easily by raising the front end about 4 inches (100 mm), which may prove useful when the dock is higher than usual. The front Hi-Buoy is combined with front kneeling to increase flexibility of the system. Refer to "Controls & Instruments" chapter.

The full Hi-Buoy system raises the whole coach about 4 inches (100 mm). It can be used to enable passengers to get on or off the coach easily, and to safely travel roads with high obstacles. Refer to "Controls & Instruments" chapter.

NOTE

The Hi-Buoy system does not operate when the coach is traveling over 5 mph (8 km/h). Consequently, the driver cannot inadvertently operate the Hi-Buoy system at higher speeds.

LOW-BUOY

This system lowers the coach about 4 inches (100 mm). It enables the coach to drive through underpasses where the height is less than 12 feet (3.7 m).

Low-Buoy operation is controlled by a valve located on the L.H. control panel. The valve can be switched to either LOW-BUOY or NORMAL positions. A warning light on the dashboard will indicate that the coach is being lowered. Refer to "Controls & Instruments" chapter.



CAUTION

Avoid parking too close to the curb or other obstacles that could damage the coach during low-buoy operation.

NOTE

The Low-Buoy cannot be activated when the coach is traveling over 5 mph (8 km/h). Consequently, the driver cannot inadvertently operate the Low-Buoy system at higher speeds.

RETRACTABLE TAG AXLE

The tag axle is controlled by a valve located on the lateral control panel. The valve can be switched to either the WHEELS UP or WHEELS DOWN position. The axle will be raised or lowered by air pressure according to the valve position. Refer to "Controls & Instruments" chapter.

The tag axle service brakes operate only when the tag axle is in the WHEELS DOWN position. Never lower the tag axle while the coach is moving. When the tag axle is in the WHEELS UP position, the corresponding indicator light will illuminate. The indicator light will start flashing and an audible alarm will sound to warn the driver if the vehicle speed exceeds 12 mph (20 km/h) with tag axle raised. The tag axle can be raised in tight maneuvering areas like in a parking lot or to make it easier to turn a short corner. The tag axle shortens the wheelbase and allows tighter turning. Raising the tag axle transfers extra weight and additional traction to the drive wheels providing improved control on slippery roads.



CAUTION

Do not use tag axle in raised position for an extended period. Raising tag axle increases load on the drive axle, suspension and tires.

Do not drive vehicle with tag axle raised when speed is exceeding 12 mph (20 km/h).

In order to prevent damage to the suspension, always raise the tag axle before lifting the coach.

TAG AXLE UNLOADING

To reduce the turning radius, the air springs pressure will be automatically reduced by 75% when the coach is moving at speed lower than 5 mph (8 km/h) and with more than 1½ turn from the steering.

ENGINE COOLANT HEATER

This optional auxiliary heating system is used for preheating and retaining the heat of water-cooled engines. It can be used before startup to ease starting and to provide rapid operation of the interior heating system. It can also be used with the engine running to maintain coolant heat and interior temperature.

The heater operates independently of the engine. It is connected to the cooling system, heating circuits and to the vehicle's fuel and electrical system.



WARNING

The coolant heating system uses the same fuel as the engine. Do not operate in a closed building or while refueling. Operate only in a well ventilated area.

SWITCHING THE HEATER ON

The timer light illuminates when the heater is switched ON. Air is forced in to flush out the combustion chamber of residual gases and the water circulation pump begins operating. The fuel metering pump delivers fuel in precise amounts to the combustion chamber, where fuel and combustion air form a combustible mixture which is ignited by the ignition unit.

Once the flame sensor has signaled to the control unit that combustion has taken place, the ignition unit is switched OFF. The dashboard telltale light will illuminate to indicate when the burner is ON.

Hot combustion gases are diverted at the end of the flame pipe and are then forced through the indirect heating surfaces of the heat exchanger. The heat exchanger transfers the heat to the coolant water passing through the heat exchanger.

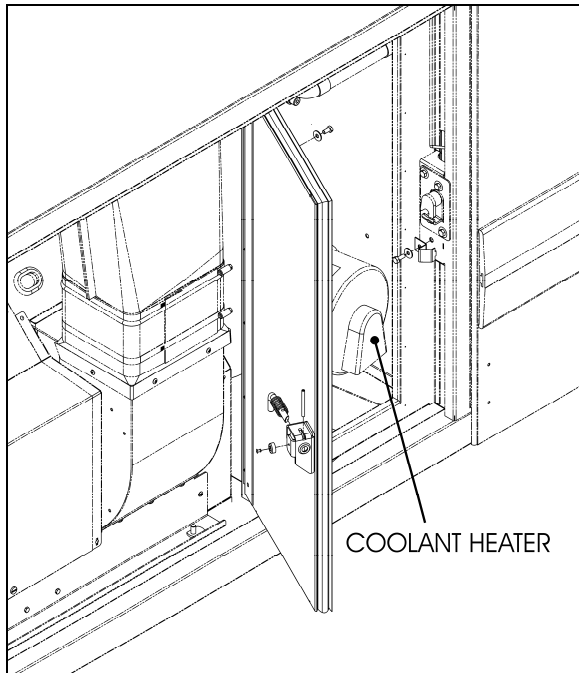

LOCATION OF PREHEATER

18607

The heater is thermostatically controlled and operates intermittently (i.e., the switched-on time of the burner varies depending on the heat requirement). The water temperature is controlled by the built-in water thermostat.

The water circulation pump remains in operation as long as the heater is operating, even during the regulated intervals and during the delayed cut-out of the heater. The pump can also be operated independently of the heater by means of an appropriate circuit. The heater can be switched *ON* at any time (i.e., during the delayed cut-out period). Ignition takes place after the delayed cut-out time expires.

SWITCHING THE HEATER OFF

The fuel supply is interrupted when the heater is switched *OFF*. This causes the flame to go out and a delayed cut-out of 2.5 minutes begins. The circulating combustion air flushes the remaining combustion gases out of the chamber and cools off the heated parts on the exhaust side of the heat exchanger. The water circulation pump continues to transfer the latent heat present in the heat exchanger, thus preventing hot spots. Once the delayed cut-out time expires, both the combustion air blower and the water circulation pump switch *OFF* automatically. A cut-out will automatically take place in case of heater failure. Refer to

Technical Information chapter for additional information.

COOLANT HEATER TIMER

The timer, located on L.H. control panel is used to program the starting and stopping time of the preheating system and to give Fault Codes. The system indicator light, located on the timer, illuminates when the system is functional. Your vehicle is equipped with timer A or timer B.

Timer A: Operating instructions

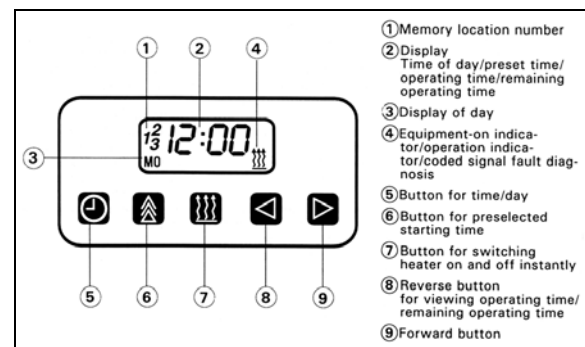

TIMER

22223

These instructions refer to the Valeo timer illustrated above.

Remaining Operating Time

The remaining operating time refers to the period of time the heater still continues to remain in operation. It may be changed while the heater is in operation.

Setting the Digital Timer

After the power has been connected, all symbols on the digital display are flashing. The time of the day and the day of the week must be set.

All flashing symbols of the timer can be set by means of the Forward (9) or Reverse (8) buttons.

When buttons (8) and (9) are pressed for more than 2 seconds, the quick digit advance mode is activated.

Setting the Time and Day of the Week

1. Press button (5) for more than 2 seconds (time display flashes).
2. Press (8) or (9) button to set the time of day.

3. Wait 5 seconds. The time of day is stored (day of week flashes).
4. Press (8) or (9) button to set the correct day of week.
5. Wait 5 seconds. The day of week is stored.

Viewing the Time (Ignition ON)

Continuous display of current time and day of the week.

Viewing the Time (Ignition OFF)

Briefly press button (5) to display current time and day for 5 seconds.

Switching Heater ON (Instant Heating) With Ignition ON:

Press button (7). Heater is switched on (continuous operation) and continues to operate until button (7) is pressed again or ignition is switched off.

NOTE

If the ignition is switched off while heater is in operation, the remaining operating time of 15 minutes flashes on the display and the heater will continue to operate for this period of time.

Switching Heater ON (Instant Heating) With Ignition OFF:

Press button (7). Heater is switched on for preset operating time (the factory-set heater operating duration is 60 minutes)

Switching Heater OFF

Press button (7). The heater starts its after-run cycle and switches off thereafter.

Presetting Starting Time

1. Press button (6). Memory location number flashes.

NOTE

By repeatedly pressing button (6), starting time 2 or 3 can be preset.

2. Press button (8) or (9) until correct startup time is set.
3. Wait 5 seconds. Preset starting time is stored and day of week flashes.
4. Press button (8) or (9) to select the correct startup day of week.

5. Wait 5 seconds. The startup day of week is stored.

The number of memory location remains on the display. The timer is now in the programmed mode and will switch the heater on at the preset time.

NOTE

We recommend that memory locations 1 and 2 be used for presetting times within 24 hours of setting the timer. Memory location 3 can be used for a starting time within the next 7 days of setting the timer.

Recalling Preset Times

Press (6) repeatedly until the desired memory location number and preset time are displayed.

Canceling Preset Time

Press button (6) repeatedly until no more memory location number is visible on the display.

Setting Operating Time

1. With heater off, press button (8). Operating time flashes.
2. Press button (8) or (9) to set the operating time (between 1 and 120 minutes)
3. Wait 5 seconds. Operating time is stored.

The heater remains in operation for the preset time (except for continuous operation).

Setting the Remaining Operating Time

1. With heater in operation, press button (8). Remaining operating time flashes.
2. Set remaining time with button (8) or (9).
3. Wait 5 seconds. Remaining operating time is stored.

9. Push selection button (3) or (6) to switch between 12h and 24h modes. The display shows **HH 12** or **HH 24**.
10. Push enter button (5) to confirm mode.

Timer B: Operating instructions

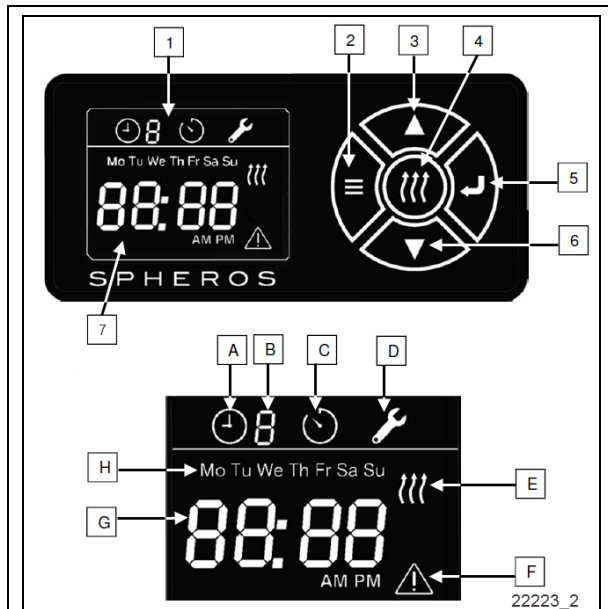

FIGURE 1: PREHEATER TIMER

1. Menu row	A. Preselection time
2. Menu-button	B. Active/deactivate starting
3. Selection UP	C. Operating time
4. Instant heating	D. Setting sign
5. Enter	E. Preheater on
6. Selection DOWN	F. Error
7. Display	G. Time
	H. Day

These instructions refer to the timer illustrated in Figure 1. They are the same instructions provided in the Valeo instruction booklet, provided with your vehicle.

SET TIME AND DAY

Select 12h or 24h mode

6. Push menu-button (2) to show menu row at the top of the display (1).
7. Push selection button (3) or (6) until setting sign (D) is blinking.
8. Push enter button (5) to open hour mode options.

Set time and day with 24h mode selected



1. Display shows.
2. Push selection button (3) or (6) until you get the right day of the week.
3. Push enter button (5) to confirm day.
4. Push selection button (3) or (6) to adjust hours.
5. Push enter button (5) to confirm hours.
6. Push selection button (3) or (6) to adjust minutes.
7. Push enter button (5) to confirm minutes and to return to standard display.

Set time and day with 12h mode selected

1. Display shows.
2. Push selection button (3) or (6) until you get the right day of the week.
3. Push enter button (5) to confirm day.
4. Push selection button (3) or (6) to adjust hours.
5. Push enter button (5) to confirm hours.
6. Push selection button (3) or (6) to adjust minutes.
7. Push enter button (5) to confirm minutes: Display shows **AM**.
8. Push selection button (3) or (6) to switch between **AM** and **PM**.
9. Push enter button (5) to confirm and return to standard display.

ADJUST OPERATING TIME

The operating time is the period, when the preheater is ON through pushing the instant heating button or after activating a starting time.

1. Push menu-button (2) to show menu row at the top of the display (1). 
2. Push selection button (3) or (6) until setting sign (C) is blinking. 
3. Push enter button (5) to show the adjusted operating time.
4. Push selection button (3) or (6) to adjust the operating time.
5. Push enter button (5) to confirm the operating time and to show standard display.

ADJUST REMAINING TIME



The remaining time is the period, when the preheater remains ON after ignition is switched OFF.

If the ignition is switched OFF while the preheater is ON, the remaining time can be adjusted.

1. Push selection button (3) or (6) to adjust remaining time.
2. Push enter button (5) to confirm.

Preheater stops automatically after remaining time is over. The remaining time will not be saved. It has to be adjusted and confirmed every further time. If the remaining time is not confirmed within 10 seconds, the preheater stops.

SET A STARTING TIME

1. Push menu-button (2) to show menu row at the top of the display (1). 
2. Push selection button (3) or (6) until setting sign (A) is blinking. 
3. Push enter button (5) to make starting time number to appear. 
4. Push selection button (3) or (6) to browse the starting time numbers.
5. Push enter button (5) to choose the starting time you wish to setup: display shows day and time and next step day can be adjusted.
6. Push selection button (3) or (6) to adjust day.

7. Push enter button (5) to confirm day.
8. Push selection button (3) or (6) to adjust hours.
9. Push enter button (5) to confirm hours.
10. Push selection button (3) or (6) to adjust minutes.
11. Push enter button (5) to confirm minutes: standard display appears.

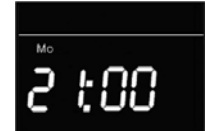

Only in 12h-mode after adjustment of time:

12. Push selection button (3) or (6) to switch between AM and PM.
13. Push enter button (5) to confirm: standard display appears.

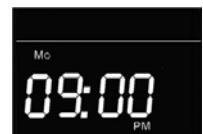



NOTE

Seven starting times are available for a period of seven days, but only one starting time can be active.

For safety reasons a starting time can only be activated for the same or next day.





Activation for Sunday and Monday is possible on Friday; activation for Monday is possible on Saturday.

ACTIVATE STARTING TIME



1. Push menu-button (2) to show menu row at the top of the display (1). 
2. Push selection button (3) or (6) until activate start sign (B) is blinking. 
3. Push enter button (5) to confirm.
4. Push selection button (3) or (6) to browse starting times (programmed days and times appear in the display according to the starting time number).
5. Push enter button (5) to activate the chosen starting time: activated starting time and the chosen number appear in the display.



DEACTIVATE STARTING TIME

1. Push menu-button (2) to show menu row at the top of the display (1). 
2. Push selection button (3) or (6) until deactivate start sign (B) is blinking. 
3. Push enter button (5) to confirm.
4. Push selection button (3) or (6) until sign  and sign  appear in the display.
5. Push enter button (5) to confirm.

START/STOP INSTANT HEATING

1. To start preheater, push instant heating button (4) when ignition is ON; sign is blinking. 
2. If the preheater runs well, the sign stops blinking and appears permanently in the display.
3. To stop preheater, push instant heating button (4). 

OPERATING TIME WITH INSTANT HEATING

1. Push instant heating button (4) when ignition is OFF: operating time value appears in the display.
2. Push selection button (3) or (6) to adjust operating time.
3. Push enter button (5) to confirm: Sign  appears and the preheater will operate for the adjusted time.

<i>NOTE</i>
Date and time have to be adjusted in the settings before using instant heating.

Operational Failure Symptoms via Fault/Flash code

On preheaters equipped with a fault diagnosis system using coded light signals, the equipment-on indicator/operation indicator flashes. Refer to the following table.

PREHEATER TROUBLESHOOTING AND MAINTENANCE

Refer to the Valeo manual for more information.

<i>NOTE</i>
If there are no preheater faults, the preheater will go through a normal start cycle and regulate based on thermostat setting.

<i>NOTE</i>
Switch on the preheating system briefly about once a month, even during the warm season.

 CAUTION
To avoid running down the batteries, do not turn on the preheating system for more than one hour before starting the engine.

 WARNING
The preheating system uses the same fuel as the engine. Do not operate in a building or while refueling. Operate only in a well-ventilated area.

<i>NOTE</i>
<i>If there are no heater faults, the heater will go through a normal start cycle and regulate based on thermostat setting.</i>

WHEELCHAIR LIFT SYSTEM

It is important to passenger safety that the lift operator be familiar with the operating instructions. Read and understand the RICON Mirage F9TF F9TH Wheelchair lift Operator Manual before attempting to use the wheelchair lift. The instructions below are a quick reference only and not a replacement to the information provided by RICON.

Watch the **Prevost Wheelchair Lift Instruction video** on Prevost's YouTube channel. To do so, type "Prevost Coach – YouTube" on your web browser and then select the proper link. Once on Prevost channel, select "Video" tab and then look for the video entitled "Prevost Wheelchair Instruction".

INTRODUCTION

Safe and easy access to the coach is provided by the Ricon Mirage F9TF and F9TH Public Use wheelchair lifts. The Mirage F9TF or F9TH is a dedicated entry model, which is intended for installation in a vehicle baggage compartment.

An electric-motor driven hydraulic pump provides a maximum platform lifting capacity of 660 pounds (300 kilograms) for Mirage Model F9TF and 800 pounds (363 kilograms) for Mirage Model F9TH.

A trained attendant or the vehicle operator operates the lift. For a boarding passenger, the operator uses control switches to withdraw the platform from the vehicle (deploy) and lower it to ground level. The passenger is placed on the platform and then lifted to floor height. After the passenger enters the vehicle, the operator lowers the platform and retracts it back into the vehicle (stow). For an exiting passenger, the operator withdraws the platform from the vehicle (deploy) and raises it to floor height. The passenger is placed on the platform and then lowered to the ground. The passenger departs, and the operator returns the platform to the stowed position in the vehicle.

One individual can manually operate the lift when normal power is not present. A manual release mechanism is provided to ease the task of pulling the platform out of its enclosure. The hydraulic pump assembly includes a manually operated back-up pump to raise the platform, and a pressure release valve to lower it. The front platform rollstop, normally power operated, has a manual override knob for back-up use.

OVERVIEW

Major lift components

Left, Right, Front, Rear	Reference points from outside vehicle looking inward at lift.
Bridgeplate	Plate bridges gap between platform and vehicle floor when platform is at floor level. Acts as barrier during up and down platform motions to prevent wheelchair from rolling off rear of platform.
Carriage	Part of traveling frame that is mounted on rollers; moves on rails located inside enclosure. Supports lifting frame and platform.
Controller	Receives electrical input signals from pendant and lift sensors and sends control signals to lift electrical and hydraulic components.
Control pendant	Hand-held device used to control platform motions.
Cycle counter	Located on rear frame of carriage. Visible when platform is fully deployed. It records number of times platform has moved from floor to ground and back to floor.
Deployment system	Located within carriage. Employs an electric gear-motor to propel platform out of enclosure, or pull it back into enclosure.
Enclosure	Travelling frame housing that is rigidly attached to vehicle chassis.
Fluid reservoir	Container holds hydraulic fluid that is used by hydraulic system.
Folding handrail	(left and right) Provides a handhold for standing passenger (standee).

Front rollstop	Front barrier prevents wheelchair from inadvertently rolling off platform during platform movement.
Handrail release button	(left and right) Locks handrail in vertical position. Must be pushed inward to release handrail.
Hydraulic cylinder	Located within carriage and connected to lifting frame. Receives pressurized fluid from hydraulic pump to lift platform.
Hydraulic pump assembly	Electro-hydraulic unit provides hydraulic pressure used to raise platform. Also mounts components for manual operation.
Lifting frame	Assembly is hinged to front of carriage and to center of platform; raised by single hydraulic cylinder attached to carriage.
Manual pump handle	Used to manually operate hydraulic backup pump and pressure release valve when electrical power is not available. Also used to rotate platform release shafts.
Platform	Curbed area where passenger resides while being raised to vehicle or lowered to ground.
Platform release shaft	(left and right) Used during manual operation of lift. Disengages platform from enclosure to facilitate manual deployment. Engage and rotate either shaft with manual pump handle.
Pull box	Houses electrical termination points to lift, and a hydraulic line disconnect point. Also accepts input harness from control pendant.
Rollstop control knob	Provides manual control of rollstop if electrical power is not available.
Safety belt	Safety restraint belt that spans between handrails to help confine passenger to platform area.
Stow Lock	Safety lock retains platform when in stowed position (retracted); releases when stow lock lever is raised.
Travelling frame	(not shown as unit) Assembly comprised of carriage, lifting frame, and platform.

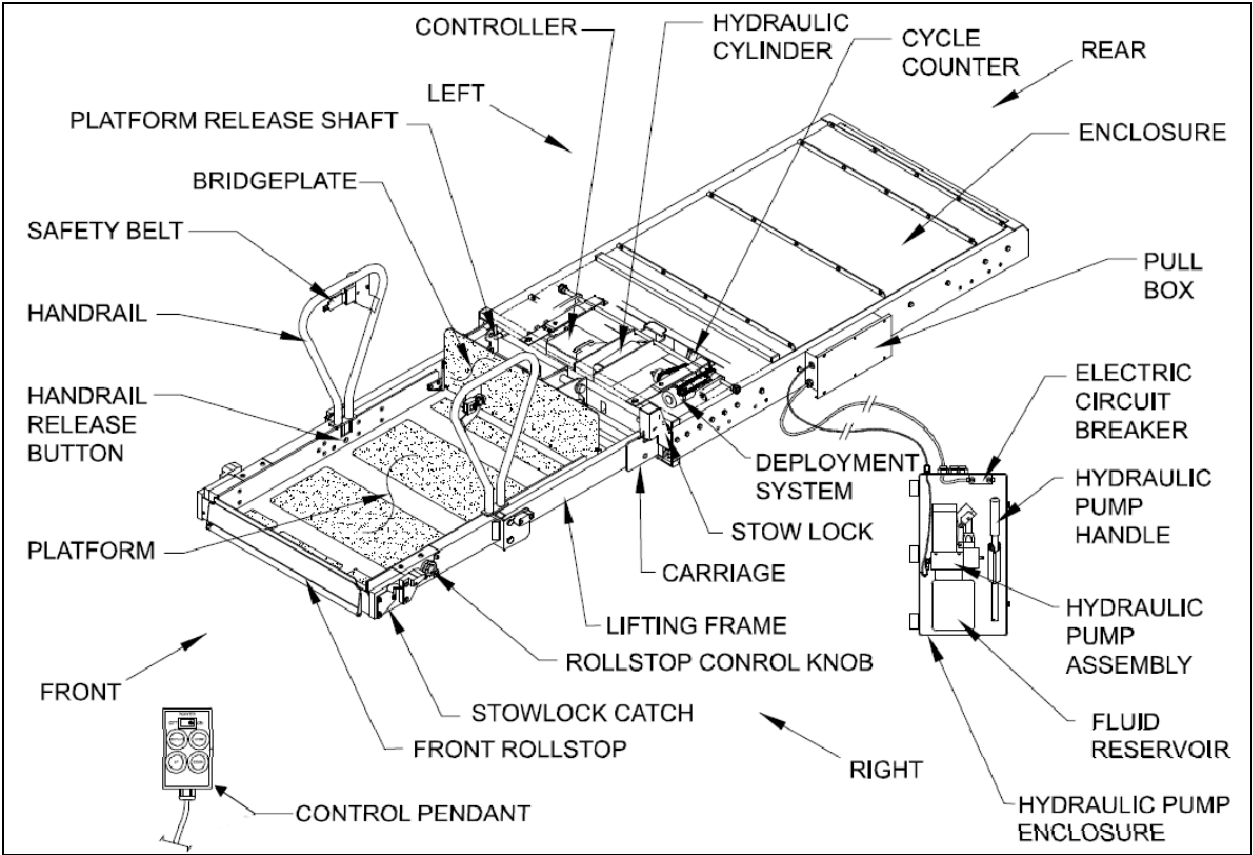

GENERAL SAFETY PRECAUTIONS

- To avoid injury, always exercise caution when operating and be certain that hands, feet, legs, and clothing are not in the path of product movement.
- Read and thoroughly understand the operating instructions before attempting to operate the wheelchair ramp.
- Inspect product before each use. If unsafe conditions, unusual noises or movements, do not operate lift until the problem is corrected.
- Stand clear of doors and platform and keep others clear during operation.

OPERATING INSTRUCTIONS

Safety Precaution

- To operate the wheelchair lift, the coach must be parked on a flat and level surface, with the parking brake applied.
- Inspect the lift before each use as described in the RICON Operator Manual **32DF9T15** under paragraph "Pre-Operation Lift Inspection". If any unsafe condition exists, or if unusual noises or movements are noticed, DO NOT use and contact an authorized RICON dealer for repair.
- Read and comply with all warning labels and symbols affixed to the wheelchair lift.
- Wheelchair occupant should face outward when entering or exiting vehicle.
- Do not back onto platform when exiting vehicle. FACE OUTWARD, and verify that platform is at the same height as floor. Check that front rollstop is up and locked.
- The front rollstop is intended to prevent slow, unintentional, rolling off of platform.
- The front rollstop is not intended to stop a quick moving wheelchair. A quick moving wheelchair could tip if the small front wheels collide with the rollstop. Also, the large rear wheels of a quick moving wheelchair could roll over the rollstop. Possible injury to the occupant might occur in either case.
- Verify that wheelchair fits safely on platform; it must not extend beyond edges or interfere with operation of rollstop.
- Do not operate with a load in excess of 660 lbs (300 kg) for Mirage Model F9TF and 800 pounds (363 kilograms) for Mirage Model F9TH.
- Keep arms, legs, and clothing away from moving lift parts.
- The lift is intended for one wheelchair and its occupant, or one standee. Do not overload lift.
- Keep others clear while operating lift.
- Do not allow an untrained person to operate lift.
- Do not allow anyone to stand on bridgeplate. A bent bridgeplate can interfere with the platform as it raises and lowers.
- Lock wheelchair brakes before raising or lowering platform (power chair users should turn off power and set brake).
- Use great care in wet conditions; the wheelchair brakes are less effective if its tires or the platform are wet.
- Do not leave deployed platform unattended. Return to stowed position after use.

Hand-Held Control Pendant and Motion

The lift is operated with a hand-held, hard-wired remote-control pendant. Turn on the POWER ENABLE switch and then control each lift motion by pressing an appropriate button.

The POWER ENABLE switch provides power to the pendant and thereby enables the lift. When turned on, the power switch and each button illuminate.

Pressing the DEPLOY/OUT button extends the platform from the lift storage compartment, and pressing the STOW button retracts the platform back into the storage compartment. Pressing the DOWN button lowers the platform towards the ground, and pressing the UP button raises the platform towards the vehicle floor.

A button must be held depressed until the motion is completed. Movement of the platform can be halted at any time by releasing the button.



HAND-HELD CONTROL PENDANT

MOTION		DESCRIPTION
	DEPLOY / OUT	Platform extends out of vehicle, or deploys.
	DOWN	Platform lowers from present height towards ground; front rollstop lowers when platform contacts ground
	UP	Platform rises from present height towards vehicle floor; rollstop rises before platform leaves ground.
	STOW / IN	Platform retracts into vehicle, or stows.

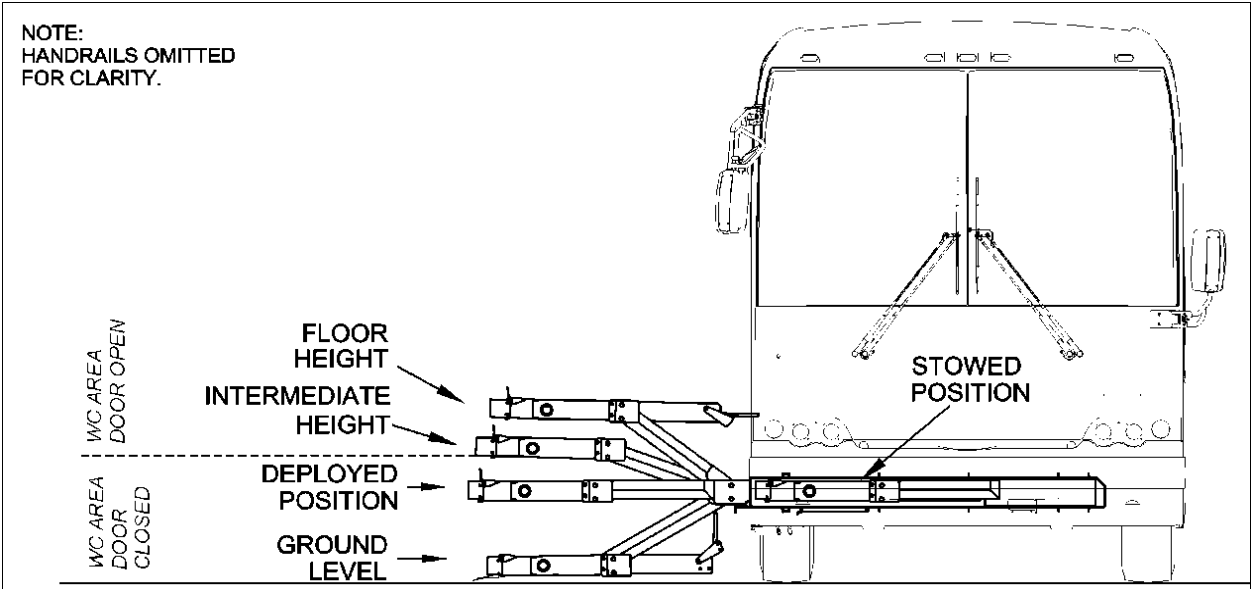

PLATFORM POSITION WITH INTERMEDIATE HEIGHT (OPTIONAL FEATURE)

Normal Lift Operation – To Enter Vehicle

- Before operating lift, be certain vehicle is safely parked on a level area away from traffic. Provide at least 10 feet (3 meters) space for lift operation and passenger boarding.
- The lift operator must take special care to ensure that area is clear before deploying platform. Be certain there are no obstacles beneath platform.
- Open lift compartment door completely.

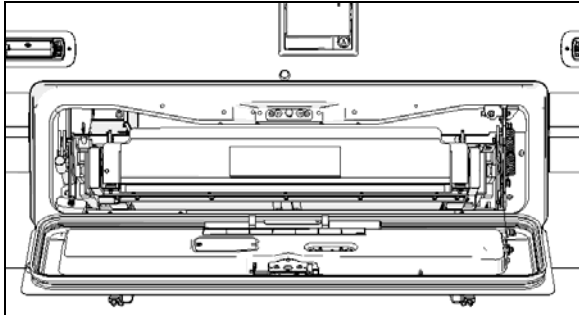

X3 SERIES SHOWN

- Open sliding door directly above lift compartment. This does not apply to models that stop upward platform movement prior to reaching floor level. The sliding door on these models is opened after the platform reaches **intermediate height** (refer to Figure 3).
- The vehicle and lift are equipped with a safety interlock system (i.e. transmission into neutral, parking brake applied). Be certain that it is in the proper mode before attempting to operate lift. The lift will not operate until this feature has been properly engaged.
- Supply power to the wheelchair lift system first by depressing the wheelchair lift activation switch located on the dashboard.

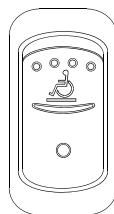

WHEELCHAIR LIFT ACTIVATION SWITCH

NOTE

Whenever the wheelchair lift activation switch is in the ON position, an interlock system prevents releasing of the parking brake and a transmission inhibit feature prevents gear selection when either the lift compartment door or the sliding door is open.

- Enable lift control pendant by turning on POWER switch located on pendant.
- A person that uses the wheelchair lift while standing (does not require mobility aid equipment) is referred to in this manual as a Standee.

1. **ACTIVATE INTERLOCK:** Make sure parking brake is set and transmission is in neutral.
2. **DEPLOY PLATFORM:** Press and hold DEPLOY/OUT button until platform is fully deployed. **NOTE:** Platform cannot be moved up or down unless platform is fully extended.
3. **RAISE HANDRAILS:** Lift right handrail to vertical and push firmly down into its socket. Repeat for left handrail. Verify that both handrails are latched in place by attempting to pull upward on them.
4. **BUCKLE SAFETY BELT (to enable lift controller):** Insert belt tongue into buckle and listen for audible “click” then tug belt to confirm belt is securely fastened.

NOTE

The safety belt acts as a safety device and it prevents raising or lowering the lift when not buckled.

5. **LOWER PLATFORM:** Press and hold DOWN button until platform stops at ground level and rollstop opens completely.
6. **BUCKLE SAFETY BELT.**
7. **BOARD PLATFORM:** Position wheelchair in center of platform, facing outward and advise occupant to lock wheelchair brakes. Power must be turned off on electric-powered wheelchairs.
NOTE: *Standee must stand near the center of the platform, facing in the direction of travel (into vehicle), and firmly grasp handrails. Do not stand on bridgeplate.*
8. **BUCKLE SAFETY BELT (to enable lift controller):** Insert belt tongue into buckle and listen for audible “click” then tug belt to confirm belt is securely fastened.
NOTE: *The next two steps apply only to F9TF/F9TH models that stop upward platform movement at an intermediate level. Other models continue at step 11.*
9. **PARTIALLY RAISE PLATFORM:** Press and hold UP button until platform stops at intermediate height.
10. **OPEN SLIDING DOOR:** Fully open vehicle sliding door located above lift. The lift operator, or attendant should do this.
11. **RAISE PLATFORM:** Press and hold UP button until platform stops at floor height and bridgeplate lowers onto vehicle floor.

**WARNING**

Verify that rear edge of bridgeplate lies flat on floor along its entire edge and does not create a tripping hazard.

12. **EXIT PLATFORM:** Advise passenger to carefully enter vehicle.
13. **BUCKLE SAFETY BELT.**
14. **LOWER HANDRAILS:** Press release button at base of handrail and lift the left handrail upward out of its socket. Lower handrail to platform. Repeat for right handrail.
15. **STOW PLATFORM:** Press and hold STOW/IN button. Close sliding door at intermediate height. Press and hold STOW/IN button until platform reaches STOW height and then fully retracts into vehicle.
NOTE: *Do not use DOWN button to lower platform partway prior to stowing, and then complete the stowing process by using IN button. This method may not properly stow platform.*
16. **CLOSE DOOR.** Close the lift compartment door.

Normal Lift Operation – To Exit Vehicle

1. **ACTIVATE INTERLOCK:** Make sure parking brake is set and transmission is in neutral.
2. **DEPLOY PLATFORM:** Press and hold DEPLOY/OUT button until platform is fully deployed.
3. **RAISE HANDRAILS:** Lift right handrail to vertical and push firmly down into its socket. Repeat for left handrail. Verify that both handrails are latched in place by attempting to pull upward on them.
4. **BUCKLE SAFETY BELT (to enable lift controller):** Insert belt tongue into buckle and listen for audible “click” then tug belt to confirm belt is securely fastened.

NOTE: The next two steps apply only to F9TF/F9TH models that stop upward platform movement at an intermediate level. Other models continue at step 7.

5. **PARTIALLY RAISE PLATFORM:** Press and hold UP button until platform stops at intermediate height.
6. **OPEN SLIDING DOOR:** Fully open vehicle sliding door located above lift. The lift operator, or attendant should do this.
7. **RAISE PLATFORM:** Press and hold UP button until platform stops at floor height and bridgeplate lowers onto vehicle floor.

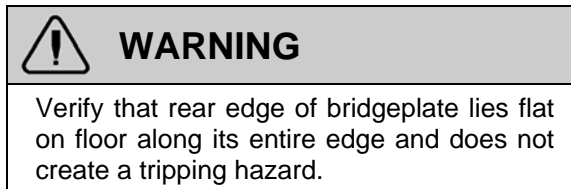

8. **BOARD PLATFORM:** Position wheelchair in center of platform, facing outward and advise occupant to lock wheelchair brakes. Power must be turned off on electric-powered wheelchairs.

NOTE: Standee must stand near the center of the platform, facing in the direction of travel (into vehicle), and firmly grasp handrails. Do not stand on bridgeplate.

9. **LOWER PLATFORM:** Press and hold DOWN button until platform stops at ground level and rollstop opens completely.
10. **UNBUCKLE SAFETY BELT.**
11. **EXIT PLATFORM:** Carefully assist passenger off of platform.
12. **LOWER HANDRAILS:** Press release button at base of handrail and lift the left handrail upward out of its socket. Lower handrail to platform. Repeat for right handrail.
13. **STOW PLATFORM:** Press and hold IN button until platform reaches STOW height and then fully retracts into vehicle.

MANUAL LIFT OPERATION

The lift can be operated manually if it loses electrical power. The following sections describe important safety preparations to be followed before using the lift, and operating procedures to deploy, raise, lower, and stow the lift. Ricon recommends that manual operation be used only to exit from vehicle, not to enter vehicle.

Preparation

- Park vehicle on a level surface, away from traffic. Allow sufficient space for lift operation and passenger boarding.

- The operator must summon assistance to move vehicle to a safe operating area if a breakdown situation exists and vehicle cannot be moved under its own power.
- Check to be certain obstacles are not in path of platform movement.
- Open vehicle doors by hand and secure.
- Caution people in vicinity that platform is about to deploy.
- Follow the "Safety Precautions ".

Manual lift controls

Manual operation components used are a hydraulic backup pump and pump handle, platform release mechanism, and a rollstop control knob.

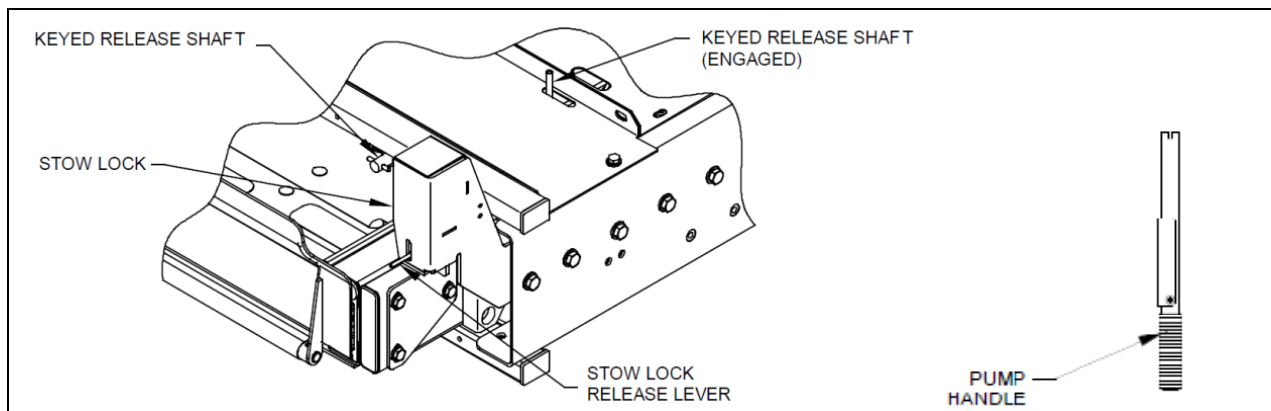

MANUAL LIFT CONTROLS

To Manually Deploy the Platform

1. Fully open sliding door and lift compartment door. Ensure that there are no obstacles in the path of the lift.
2. Take the manual backup pump handle secured inside the manual pump box (H3 Series) or attached to the inner side of the lift compartment door (X3 Series).
3. Engage either keyed release shaft with the pump handle.

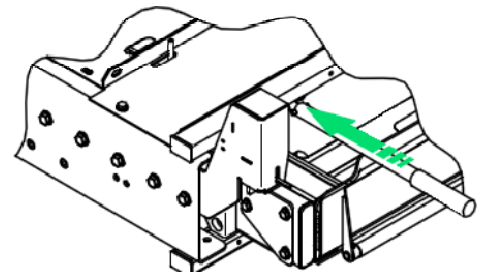
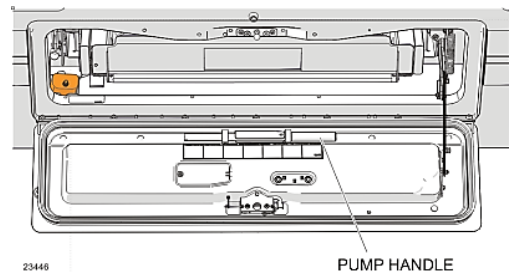

5-44 Other Features

4. Rotate the keyed release shaft $\frac{1}{4}$ -turn (as indicated on adjacent decal) while lifting stow lock lever simultaneously.

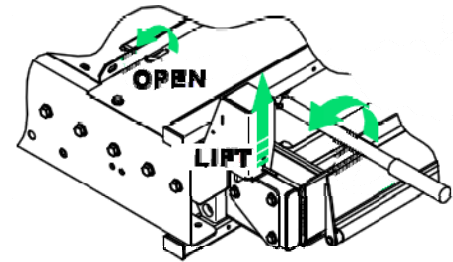
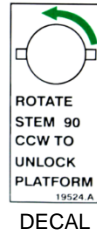

5. Grasp the top edge of the front rollstop with two hands and pull firmly. The platform moves smoothly after an initial resistance. Pull platform straight out to the end of its travel.

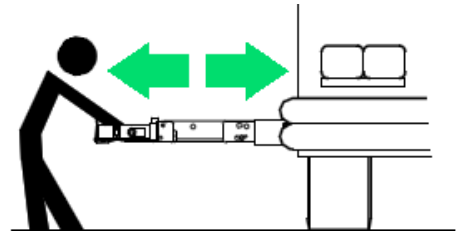

CAUTION

Ensure that release shaft re-engages and locks when platform is fully extended. If release shaft does not engage, use manual pump handle and turn $\frac{1}{4}$ -turn (direction opposite to orientation shown on adjacent decal) to re-engage release shaft.

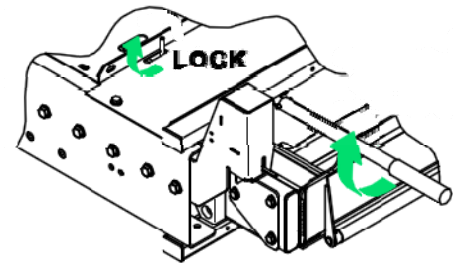

6. Lift right handrail to vertical and push firmly down into its socket. Repeat for left handrail.

To Manually Raise the Platform

1. Verify that rollstop is up (closed). Pull rollstop control knob out and rotate fully clockwise, if it isn't up.

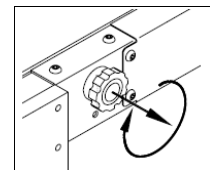
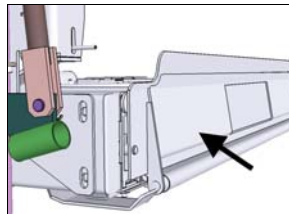

2. Close the backup pump release valve by pushing the actuating rod (A) DOWN (release valve should already be closed).

NOTE: pumping the handle raises the platform when the release valve is closed).

3. Insert pump handle into backup pump socket (B), then pump handle to raise the platform to the floor level.
4. Position wheelchair in center of platform, facing outward, and advise occupant to lock wheelchair brakes. Power must be turned off on electric-powered wheelchairs.

NOTE: Standee must stand near the center of the platform, facing in the direction of travel (into vehicle), and firmly grasp handrails. Do not stand on bridgeplate.

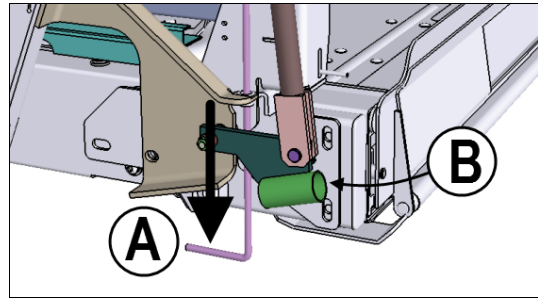

To Manually Lower the Platform

1. Verify that rollstop is up (closed). Pull rollstop control knob out and rotate fully clockwise, if it isn't up.

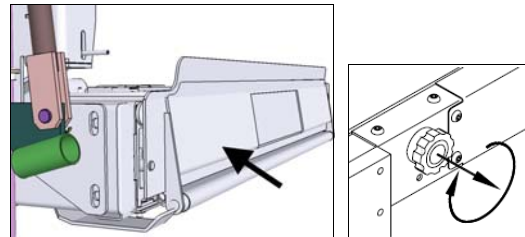

2. Slowly pull the manual backup pump release valve actuating rod (A) UP until the platform begins to lower (opening the release valve lowers platform).

3. Allow the platform to reach ground level.

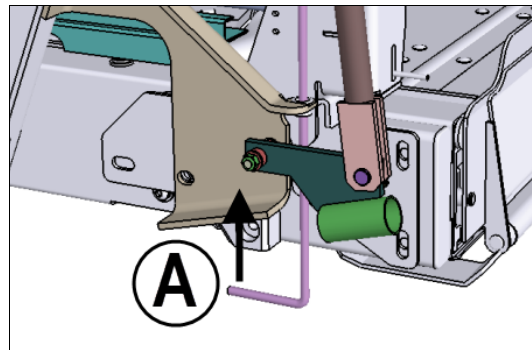

4. Pull rollstop control knob out and rotate fully counterclockwise. Rollstop must lie flat on ground.

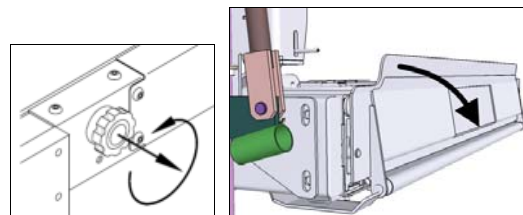

- Carefully assist passenger off of platform.
- Push the backup pump release valve actuating rod back DOWN until lightly-snug.

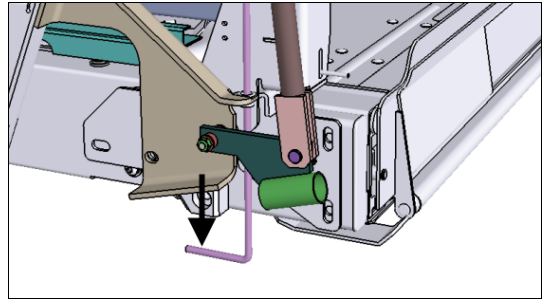

To manually stow the platform

- Verify that the backup pump release valve is closed (actuating rod (A) pushed DOWN).

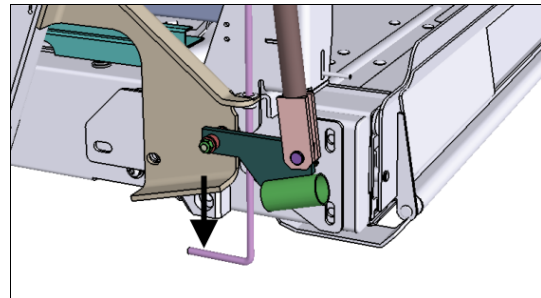

- Raise the platform to stow height; position the top surface of the platform lifting frame arm at the same height as the top surface of the carriage. If the exact height cannot be obtained, a slightly low platform is preferred to slightly high. This alignment eliminates interference between the platform and enclosure when pushing the platform into the enclosure.

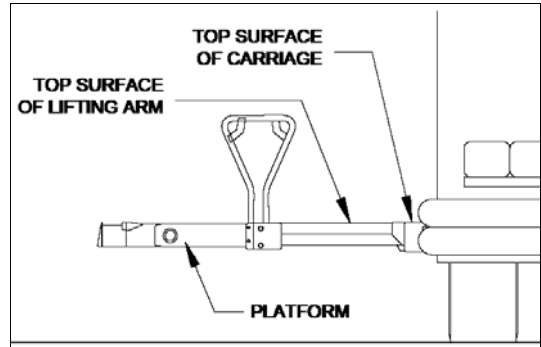

LIFTING ARM AND CARRIAGE AT SAME HEIGHT

- Verify that rollstop is up (closed). Pull rollstop control knob out and rotate fully clockwise, if it isn't up.

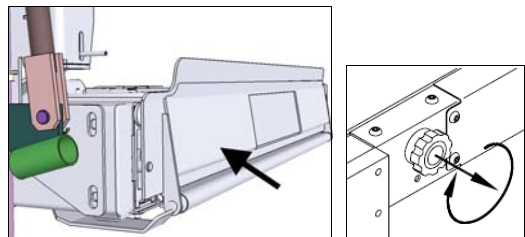

- Lift the left handrail upward out of its socket. Lower handrail to platform. Repeat for right handrail.

	<h2>CAUTION</h2>
<p>An able-bodied person must stow the platform. Use caution and avoid injury.</p>	

- Engage either keyed release shaft with the pump handle.
- Rotate the shaft ¼-turn (as indicated on adjacent decal).

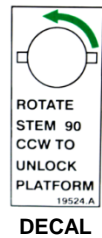
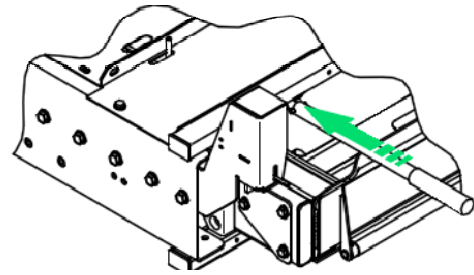

- Grasp the top edge of the rollstop, or the handrails, with two hands and push firmly. The platform moves smoothly after an initial resistance. Push platform in fully.

	<h2>CAUTION</h2>
<p>The platform must lock in place when fully stowed. Check platform retention by attempting to pull platform outward; it must not move.</p>	

- If platform does not lock, rotate either platform release shaft ¼-turn (direction opposite to orientation shown on adjacent decal) to re-engage (lock) release shaft. Platform must be fully stowed before rotating shaft.
- Verify that stow lock striker is engaged and platform is securely stowed.

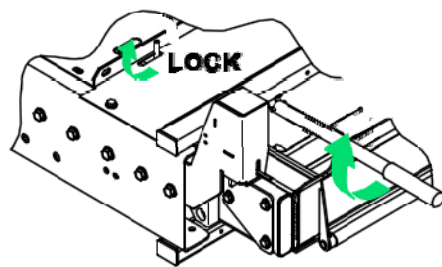

SEATS RECONFIGURATION

To accommodate a wheelchair, one row of seats must be folded and two rows must be folded and slid away. Seats may be folded on both sides of the coach to make room for a second wheelchair.

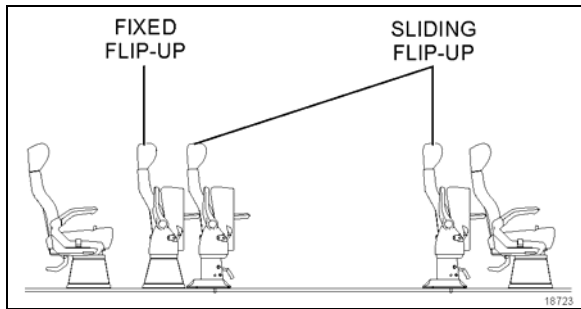

POSSIBLE SEATING ARRANGEMENT

Electrical wheelchair or tri-wheeler may require moving the sliding seats on both sides of the coach to allow enough turnaround space.

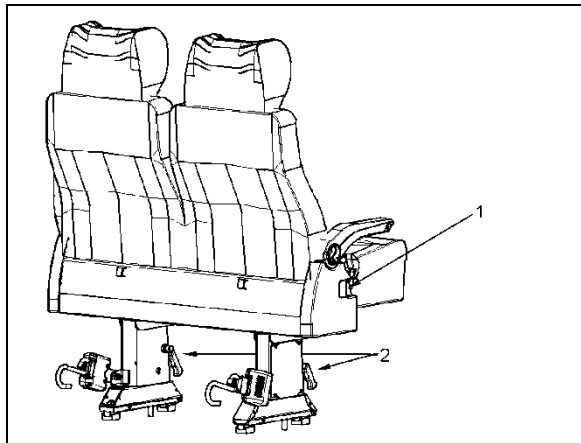

FOLDING AND SLIDING SEATS

To fold a set of seats, raise the seat back then lift up the seat cushion (pull on lever 1). To slide a row of seats, remove the black covers from the floor tracks. Pull the lever 2 while sliding the seat along the track.

WHEELCHAIR RESTRAINT SYSTEMS

Two types of wheelchair restraint systems may be found, depending on the type of seats:

1. 4-point wheelchair and occupant securement with floor anchorage.

2. 4-point wheelchair and occupant securement with anchorage to passengers seat pedestals.

Refer to Q'Straint publications included in the wheelchair restraint plastic pouches for further details.

4-POINT SECUREMENT WITH FLOOR ANCHORAGE

This securement system includes:

- 4 wheelchair tiedown retractors to secure wheelchair to vehicle floor.
- Occupant securements: lap and shoulder belts that integrate to the rear wheelchair restraints.
- Floor anchorages; installed on the vehicle floor.

Two complete sets of wheelchair restraints are kept in plastic pouches and stowed in an overhead compartment. To secure each wheelchair, four tiedown retractors must be used (at all four corners).

Two of the four tiedown retractors have attaching pins to secure the occupant's lap belt. They must be placed at the rear of the wheelchair. Each tiedown retractor slots into a mounting floor pocket.

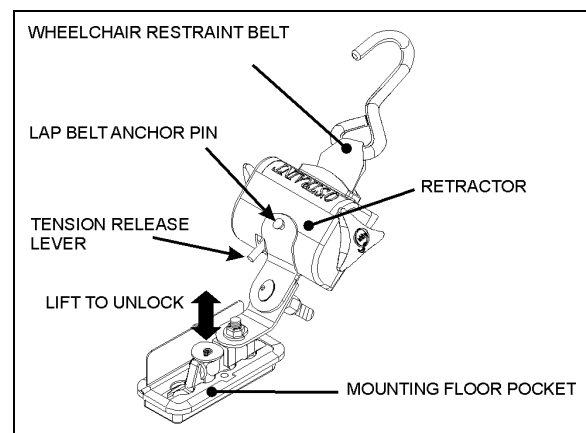

WHEELCHAIR ANCHORAGE SYSTEMS

23266

To anchor the retractors, lift the floor pocket cover, push in the retractor anchor then slide it until it locks in place. Hook one wheelchair restraint belt to each corner of the wheelchair frame (**not the wheels**) and allow the retractors to tension the belts.

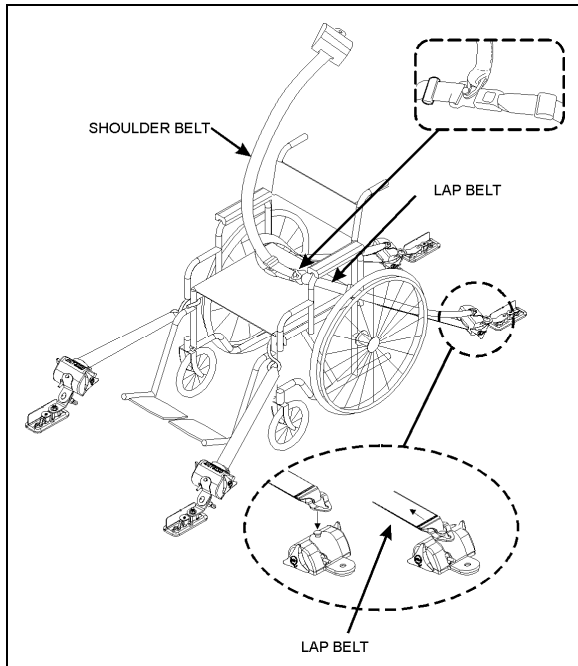

WHEELCHAIR RESTRAINTS AND ACCESSORIES

Use the blue webbing loops whenever the wheelchair restraint belt hook cannot reach a stiff member of the wheelchair chassis.

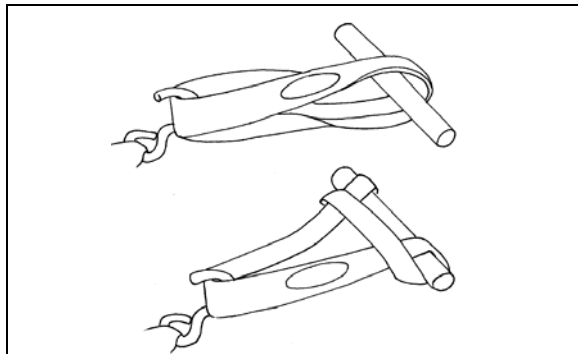

TYPICAL USE OF THE BLUE WEBBING LOOPS

To remove the restraint belts, release tension in the locking mechanism by tightening the belt slightly more with the retractor knob before pushing down the tension release lever found on the retractor. Unhook the wheelchair and allow the belts to retract. Guide the belts in, making sure they remain untwisted as they retract.

Release the anchor by lifting the lock pin then sliding out and up the anchor from the floor pocket. Close the lid to prevent dirt from entering the pocket cavity.

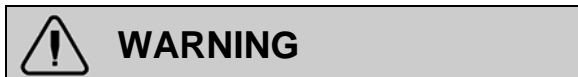

WARNING

Do not let restraint belts or occupant safety belts rub against sharp edges. Do not bleach or dry clean.

Wheelchair Occupant Restraint

Secure the wheelchair occupant in the following manner:

Fix the lap belt to the pins on the retractors of the rear restraint belts. Adjust the lap belt so it sits snug across the hips. Make sure that you place the lap belt buckle on the center aisle side. Fasten the shoulder belt to the pin on the lap belt buckle. A retractor adjusts shoulder belt length automatically.



WARNING

A snug fit with the lap belt positioned low on the hips is necessary to maximize safety. The belt should not be worn or twisted. Avoid pinching the belt and/or hardware. Do not wear over rigid or breakable objects such as eyeglasses, pens or keys as these may cause injuries.



CAUTION

The safety belt buckle provided with the red release button must always be located on the center aisle side.

To release the belts, unfasten the shoulder belt then press the red release button found on the lap belt buckle.

4-POINT SECUREMENT WITH ANCHORAGE TO PASSENGERS SEAT PEDESTALS

This securement system includes:

- 4 wheelchair restraint belts and retractors with anchorage to passengers seat pedestals.
- Occupant securements: lap and shoulder belt.

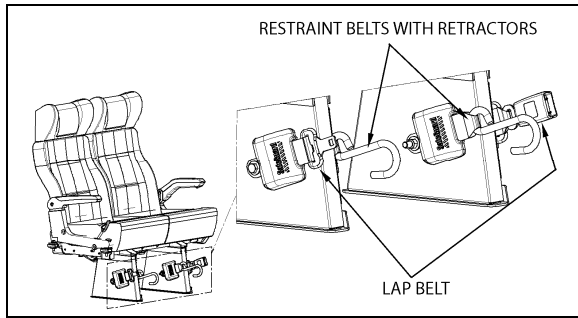

WHEELCHAIR AND OCCUPANT RESTRAINT SYSTEM

To secure the wheelchair, four restraint belts must be used (at all four corners). Hook one wheelchair restraint belt to each corner of the wheelchair frame (**not the wheels**) and allow the retractors to tension the belts.

To remove the restraint belts, push down on the tension release lever found on the retractor. Unhook the wheelchair and allow the belts to retract. Guide the belts in, making sure they remain untwisted as they retract.

Wheelchair Occupant Restraint

Secure the wheelchair occupant in the following manner:

Fasten and adjust the lap belts so it sits snug across the hips. Make sure that you place the lap belt buckle on the center aisle side. Fasten the shoulder belt by inserting the lap belt tab into the shoulder belt buckle. A retractor adjusts shoulder belt length automatically.

	<p>WARNING</p>
<p>A snug fit with the lap belt positioned low on the hips is necessary to maximize safety. The belt should not be worn or twisted. Avoid pinching the belt and/or hardware. Do not wear over rigid or breakable objects such as eyeglasses, pens or keys as these may cause injuries.</p>	

	<p>CAUTION</p>
<p>The safety belt buckle provided with the red release button must always be located on the center aisle side.</p>	

To unfasten the belts, press the red release button on the shoulder belt buckle first and then unfasten the lap belt by pressing the red release button on the lap belt buckle.

WHEELCHAIR LIFT SYSTEM - THRESHOLD WARNING SYSTEM (TWS) ADJUSTMENT

There are three verifications to perform; 1) Adjust Aiming of Acoustic Sensor Beam, 2) Test Aim of Acoustic Sensor Beam, and 3) Adjust Acoustic Sensor Timing.

Adjustment of the sensor timing is done at the factory and should not need to be repeated in the field. Readjustment should only be considered if the sensor aiming could not be adjusted to ignore both the wheelchair in the aisle and the platform during its normal movement.

ADJUST AIMING OF ACOUSTIC SENSOR BEAM

1. Place wheelchair with passenger in center aisle of coach, pointed at doorway where Threshold Warning System (TWS) is installed. The TWS should not detect a wheelchair and passenger when they are located this far from doorway.

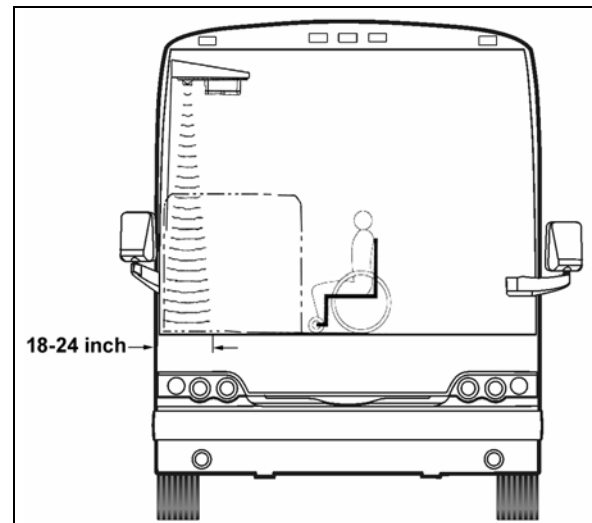

TWS AREA 23371

2. Turn power to lift on (LED on TWS module will light steady) and indicator light on the control device illuminates. If wheelchair and passenger are detected by acoustic sensors the LED will flash, the buzzer will sound and the module red light will flash. If this occurs it is necessary to adjust aiming of sensors.
3. Turn sensor angle adjustment screw clockwise to move direction of beam away

from center aisle and towards doorway. Stop adjustment when LED ceases to flash.

distance of 4½ feet below module. Sheet must be facing sensors.

NOTE
Only in rare instances will adjustment be needed in the counterclockwise direction.

4. Move centerline of small wheels of wheelchair (with passenger) to within 24 inches of doorway and repeat aiming procedure in previous step.

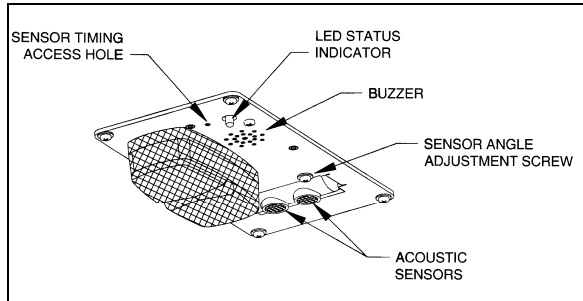

TWS MODULE DETAIL 23368

TEST AIM OF ACOUSTIC SENSOR BEAM

1. Move wheelchair and passenger slowly towards doorway. TWS should detect wheelchair and passenger (LED will flash, buzzer will sound and the module red light will flash) when centerline of front wheels is between 18 and 24 inches from doorway.
2. Open vehicle access door above lift. Lower platform to ground and place wheelchair and passenger at rear of platform. Rollstop (rear barrier) should be up. Raise platform to floor level. This normal platform motion with wheelchair and passenger aboard should not actuate TWS. If LED does flash (buzzer will also sound and module red light will flash), turn sensor adjustment screw slightly counterclockwise.

NOTE
If an adjustment is made, repeat the previous step where wheelchair is between 18 and 24 inches from doorway.

ADJUST ACOUSTIC SENSOR TIMING

1. Support a flat sheet of cardboard, or similar material, directly beneath TWS module at a

NOTE
Before proceeding, visually inspect sensors to verify that they are pointing directly at floor, or nearly, and are not pointing off at an extreme angle.

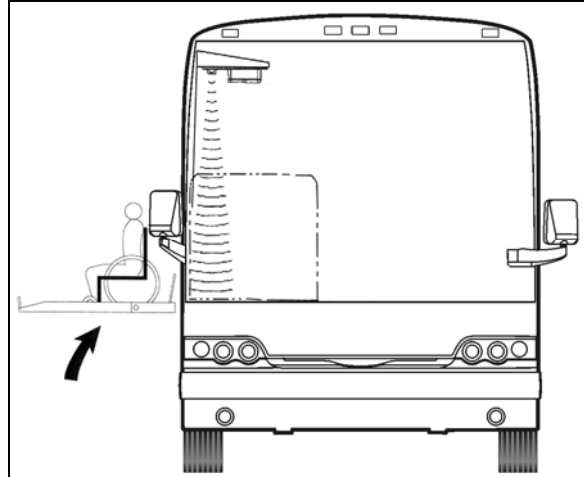

CHECKING NORMAL PLATFORM POSITION 23372

2. Note the sensor timing access hole. This hole provides access to a plunger-actuated switch that sets the sensor timing. Insert a 1/16-inch diameter wire-like object into the access hole and press the plunger inward. The LED will flash momentarily while the module establishes the distance and then remain on steady. Release the plunger when the LED ceases to flash.

NOTE
It is important that objects, such as your body, tools, seats, etc, do not interfere with the beam while the adjustment is being made.

WHEELCHAIR LIFT REMOVAL FOR STORING OR MAINTENANCE PURPOSES

1. Disconnect connector located at compartment ceiling.
2. Remove 4 fixing bolts located inside compartment, on each side of platform.
3. Grasp the platform and pull firmly, sustaining a constant pull so that the

5-52 Other Features

platform slides onto the rails until the carriage come in contact with the stops.

4. Secure the first two telescopic legs onto the platform.

NOTE

There are two telescopic legs for each platform side. The proper side is indicated onto the telescopic leg.

5. Turn telescopic leg crank to raise the carriage to be able to clear the stops.

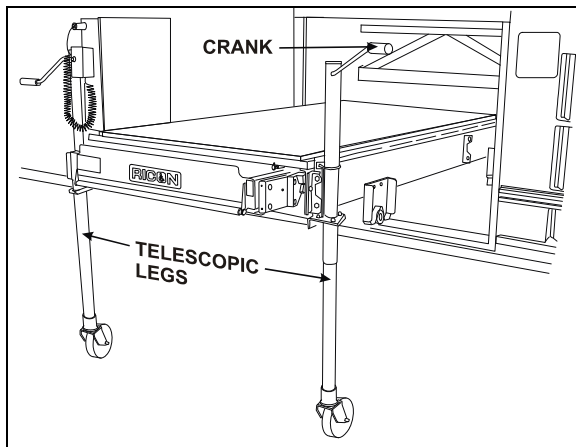

INSTALLATION OF TELESCOPIC LEGS 23333

6. Pull the platform until the rear carriage hit against the stops.
7. Secure the two rear telescopic legs onto the platform then turn telescopic leg crank to be able to clear the stops.
8. Remove platform completely.
9. Lower the platform to minimum height using the telescopic leg cranks before moving it.



WARNING

For better stability, keep the platform at minimum height when moving.



WARNING

Never deploy the platform from enclosure while standing on the telescopic legs.



WARNING

Telescopic legs were designed to support and move the platform only, do not use as a work table.



WARNING

Before moving platform, make sure that floor is level and free of obstacles.

WHEELCHAIR LIFT INSTALLATION

1. Raise the platform to proper level.
2. Insert the platform so that the rear carriage clears the stops.
3. Turn telescopic leg crank until the carriage comes in contact with the rails.
4. Remove the two rear telescopic legs from the platform.
5. Insert the platform until the front carriage clears the stops.
6. Lower the front of the platform.
7. Remove the two front telescopic legs from the platform.
8. Push firmly and make sure that the platform manual release shafts have turned to lock the platform.
9. Secure the 4 fixing bolts located inside compartment, on each side of platform. **Apply a torque of 60 lbf-ft.**
10. Reconnect connector located at compartment ceiling.



WARNING

When re-inserting platform into compartment, make sure that carriage wheels are properly aligned over the L. H. side triangular rail before removing telescopic legs.