

## SECTION 5 OTHER FEATURES

<b>EXHAUST AFTERTREATMENT SYSTEM</b> .....	<b>3</b>
FILTRATION AND REGENERATION UNIT .....	3
<i>Passive regeneration</i> .....	3
<i>Stationary (parked) regeneration</i> .....	3
<i>Diesel particulate filter clogging sequence – Instrument cluster telltale light</i> .....	4
<i>Initiating a Stationary (Parked) Regeneration</i> .....	5
<i>Voluntary Interruption of a Stationary Regeneration</i> .....	5
SELECTIVE CATALYTIC REDUCTION UNIT .....	5
<i>Diesel exhaust fluid DEF</i> .....	6
<i>Diesel Exhaust Fluid (DEF) Consumption</i> .....	6
SELECTIVE CATALYTIC REDUCTION – DRIVER WARNINGS AND INDUCEMENTS .....	6
<b>DRIVER INFORMATION DISPLAY (DID) MENUS</b> .....	<b>9</b>
GAUGES.....	10
FUEL DATA.....	11
TIME/DISTANCE.....	12
VEHICLE MESSAGES .....	13
RESET TRIP DATA.....	13
DISPLAY SETTINGS .....	13
DIAGNOSTICS .....	15
PRE-TRIP ASSISTANT (OPTION).....	17
DATA LOG.....	18
AFTERTREATMENT.....	19
PASSWORD .....	20
BRAKE LINING REMAINING .....	20
PREVOST LIAISON (OPTION).....	21
<b>REAR GAUGE - ENGINE COMPARTMENT</b> .....	<b>22</b>
START-UP MODE.....	22
IGNITION MODE.....	22
SELF-DIAGNOSTIC MODE.....	22
MESSAGE CENTER DISPLAY .....	22
<i>Drive Mode Screen</i> .....	22
<i>Priority Messages</i> .....	23
<i>Settings and Diagnostic Screens</i> .....	24
<b>INTELLIGENT SLEEP MODE (ISM)</b> .....	<b>27</b>
<b>TRANSMISSION OUTPUT RETARDER</b> .....	<b>27</b>
<b>ANTILOCK BRAKING SYSTEM (ABS)</b> .....	<b>27</b>
<b>KNEELING SYSTEM</b> .....	<b>28</b>
<b>UNLOADING TAG AXLE</b> .....	<b>28</b>
<b>RETRACTABLE TAG AXLE</b> .....	<b>28</b>
<b>WHEELCHAIR LIFT SYSTEM</b> .....	<b>29</b>
WHEELCHAIR LIFT SYSTEM DOORS.....	29
BEFORE OPERATING THE WHEELCHAIR LIFT .....	30
<i>Normal Lift Operation – To Enter Vehicle</i> .....	31

## 5-2 OTHER FEATURES

---

<i>Normal Lift Operation – To Exit Vehicle</i> .....	31
THRESHOLD WARNING SYSTEM (TWS) ADJUSTMENT.....	32
<i>Adjust Aiming of Acoustic Sensor Beam</i> .....	32
<i>Test Aim of Acoustic Sensor Beam</i> .....	33
<i>Adjust Acoustic Sensor Timing</i> .....	33
INTERIOR APPOINTMENTS .....	33
<i>Wheelchair Restraint System</i> .....	34
<i>Wheelchair Occupant Restraint</i> .....	34
EMERGENCY OPERATION.....	34
<i>Wheelchair area sliding door emergency unlock</i> .....	34
<i>To manually deploy the platform</i> .....	35
<i>To manually raise the platform</i> .....	35
<i>To manually lower the platform</i> .....	36
<i>To manually stow the platform</i> .....	36
<b>FRONT BUMPER BIKE RACK OPERATION.....</b>	<b>37</b>
LOADING BIKES .....	37
UNLOADING BIKES .....	37

## EXHAUST AFTERTREATMENT SYSTEM

The exhaust aftertreatment system consists of two units, the filtration/regeneration unit and the selective catalytic reduction SCR unit.

### FILTRATION AND REGENERATION UNIT

The aftertreatment system primary function is to capture and oxidize (regenerate) the particulate matter (soot) in the engine exhaust gases and to reduce NOx. To achieve this goal, the exhaust aftertreatment system is split into two main sections: the exhaust gases first enter the **Diesel Oxidation Catalyst (DOC)** and **Diesel Particulate Filter (DPF)** assembly to capture and regenerate the soot on a regular or passive basis, then the exhaust gases flow through the **catalytic converter** to reduce NOx to minimum level. Through constant monitoring of the exhaust gas temperature and the system back pressure, EMS is able to manage regeneration.

#### Passive regeneration

Passive regeneration is the process by which the particulate matter is oxidized due to the heat generated by the engine internal combustion process. During normal highway operation, exhaust temperatures alone are usually high

enough to oxidize accumulating soot. In low ambient temperatures, however, or in some stop-and-go applications, the system needs a little help to regenerate, or clean itself, a stationary regeneration is then required.







#### Stationary (parked) regeneration

In a small number of specific engine duty cycles, engine control module may not be capable of completing a passive regeneration. In these situations, the operator will be notified that a parked regeneration may be required. A DPF telltale light will illuminate indicating the need for user interaction. The lamp gives the operator a grace period to allow this process to take place at a time when most convenient for the operator. This process requires the vehicle to be parked while a driver or maintenance technician initiates the regeneration process using the DID menus. Once initiated, the stationary regeneration process will be complete in about 45 minutes.

The driver will be notified of the need for a stationary regeneration (parked) by illumination of the DPF REGENERATION telltale light.

## 5-4 OTHER FEATURES

### Diesel particulate filter clogging sequence – Instrument cluster telltale light

<p><b>LEVEL 1</b></p>	 steady	<p><b>REGENERATION NEEDED</b></p> <p><i>Diesel particulate filter is becoming full</i></p> <p><i>The DPF REGENERATION telltale light illuminates to notify the driver that a stationary regeneration (parked) will be required soon. When this lamp is lit, initiate stationary regeneration process at an appropriate time of day. THERE IS NO URGENCY AT THIS LEVEL.</i></p>
<p><b>LEVEL 2</b></p>	 flashing	<p><b>REGENERATION REQUIRED</b></p> <p><i>Diesel particulate filter full</i></p> <p><i>If no DPF regeneration occurs after the initial DPF REGENERATION telltale light illumination, the lamp will begin blinking and a stationary regeneration should be initiated as soon as possible in order to prevent from entering into Level 3.</i></p>
<p><b>LEVEL 3</b></p>	 flashing + 	<p><b>ATD SERVICE REQUIRED</b></p> <p><b>ENGINE DERATE ACTIVE</b></p> <p><i>Diesel particulate filter overfull</i></p> <p><i>If the flashing DPF REGENERATION telltale light is still ignored, the CHECK telltale light will illuminate. In that situation, engine performance is limited. Perform a parked regeneration IMMEDIATELY to avoid further derate and prevent from entering into Level 4.</i></p>
<p><b>LEVEL 4</b></p>	 flashing +  + 	<p><b>ATD SERVICE REQUIRED</b></p> <p><b>ENGINE SHUTDOWN ACTIVE</b></p> <p><i>A serious engine problem has occurred. The DPF may be over its maximum capacity.</i></p> <p><i>If a stationary regeneration is still not initiated, a standard Engine Protection Shutdown sequence will occur. All of the following dashboard lamps will be present:</i></p> <p><i>Blinking DPF REGENERATION telltale light;</i>  <i>Solid CHECK telltale light;</i>  <i>Solid STOP telltale light.</i></p> <p><i>Once engine derate and/or shutdown sequence is completed, a stationary regeneration must occur to continue vehicle operation. If the driver continues to operate the vehicle without regeneration, additional measures will be taken to protect the engine and ATD from damage, up to and including engine shutdown. Parked regeneration might no longer be possible.</i></p> <p><b><i>If engine protection has been initiated and forces the engine to shut down, you CAN immediately re-start the engine and perform the necessary steps in order to initiate a stationary regeneration.</i></b></p>

**Initiating a Stationary (Parked) Regeneration**

**NOTE**  
 At starting of the engine, if a stationary regeneration is required, the engine coolant temperature must reach 140°F (60°C) before any stationary regeneration may be initiated and completed. Permit the engine to idle for a short while or drive the vehicle until engine temperature increases sufficiently.

 **WARNING**  
 Do not initiate a stationary regeneration in a closed area like a garage. Stationary regenerations must be undertaken outdoors only.

 **WARNING**  
 During stationary regeneration, exhaust temperature may reach up to 842°F (450°C) at the particulate filter, it will go down to 788°F (420°C) after the catalytic converter and then will be further reduced to 554°F (290°C) at the diffuser outlet. Before initiating stationary regeneration, make sure that the exhaust outlet diffuser is clear of objects and that no one is working close to the exhaust outlet diffuser.

 **WARNING**  
 Hot surfaces. Keep yourself clear of all hot Aftertreatment Device components, particularly during and after active or stationary regeneration. Hot surfaces can cause serious burns.

**NOTE**  
**STATIONARY REGENERATION**  
 This process requires the vehicle to be parked while the driver or a maintenance technician initiates the regeneration process.

The DPF REGENERATION telltale light illuminates to notify the driver of the need and urgency of a manual stationary regeneration.



DPF REGENERATION telltale light

If stationary regeneration is not performed, this telltale light will blink, indicating that a stationary

regeneration is required immediately. If stationary regeneration is still not performed, “engine power derate and shutdown” sequence may occur as per level 1 to level 4 sequence.

To initiate a stationary regeneration:

- Park the vehicle in a clear area, vehicle speed must be 0 mph (0 km/h);
- Engine must be on normal idle and fully warmed up (coolant temperature above 140°F/60°C);
- Apply parking brakes and set the transmission to neutral (N).
- Press the DID ENTER button and then get to the DID Aftertreatment menu. Select sub-menu Request Parked REGEN and press ENTER button to confirm and initiate regeneration.

The regeneration will begin. Turn off the air conditioning to reduce engine load. The engine idling speed will increase to 1200 rpm. Once the regeneration is completed, the engine speed will return to normal idle.

**Voluntary Interruption of a Stationary Regeneration**

It is possible to interrupt a stationary regeneration at all time. To do so, get to the DID’s Aftertreatment menu, select Cancel REGEN and press ENTER button to confirm. You can stop regeneration simply by releasing the parking brake. Use this procedure in order to move the vehicle in a safe area.

 **CAUTION**  
 To avoid damages to the system components, do not set the ignition key to the OFF position to interrupt a stationary regeneration.

If regeneration is interrupted, it is very important to reinitiate the regeneration as soon as possible.

**SELECTIVE CATALYTIC REDUCTION UNIT**

Selective Catalytic Reduction (SCR) is a technology that uses Diesel Exhaust Fluid (DEF) and a catalytic converter to reduce nitrogen oxides (NOx) emissions.

SCR is an exhaust aftertreatment system that injects small amount of DEF into the exhaust gas between the DPF and the selective reduction catalytic converter. DEF turns to ammonia and carbon dioxide when heated. The

## 5-6 OTHER FEATURES

exhaust stream then passes over a catalyst, the ammonia reacts with the NO<sub>x</sub> to form nitrogen and water vapor.

The basic elements of the SCR system consist of a 15.9 gallons (60 liters) DEF tank complete with pump, lines and heating system, a dosing injector, a catalytic converter and the control and monitoring system.

### Diesel exhaust fluid DEF

When handling DEF solution, it is important that electrical connectors to be connected or well encapsulated, otherwise there is a risk that the DEF will cause oxidation that cannot be removed. Water or compressed air will not help, since DEF quickly oxidizes certain metals. If a disconnected connector comes into contact with the DEF solution, it must be replaced immediately to prevent the DEF solution from creeping further into the copper wiring, which takes place at a speed of about 2.4 in (60 mm) per hour.



### CAUTION

Diesel Exhaust Fluid (DEF) is a nontoxic aqueous solution of urea (32.5%) and ultra-pure water (67.5%). Urea is a compound of nitrogen that turns to ammonia when heated. The fluid is non flammable, and is not dangerous when handled as recommended. However, it is highly corrosive to certain metals, especially copper and brass.

When detaching hoses and components, do not spill DEF on disconnected or unsealed connectors. If DEF is spilled on a disconnected or unsealed connector, the connector must be removed immediately and replaced.

Things to know about spilt diesel exhaust fluid (DEF):

- If urea solution comes into contact with the skin, rinse with plenty of water and remove contaminated clothing.
- If urea solution comes into contact with the eyes rinse for several minutes and call for medical help if necessary.
- If inhaled breathe fresh air and call for medical help if necessary.
- Do not allow the DEF solution to come into contact with other chemicals.

- The DEF solution is not flammable. If the DEF solution is exposed to high temperatures, it breaks down into ammonia and carbon dioxide.
- The DEF solution is highly corrosive to certain metals, including copper and aluminum.
- If the DEF solution is spilled onto the vehicle, wipe off the excess and rinse with water. Spilled DEF solution can form concentrated white crystals on the vehicle. Rinse off these crystals with water.



### WARNING

DEF spilt onto hot components will quickly vaporize. Turn your face away!







### Diesel Exhaust Fluid (DEF) Consumption



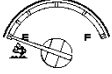

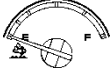

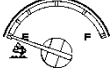

DEF consumption is related to fuel consumption. In order to meet EPA requirements, DEF tanks are sized so one refill will be necessary every two refill of the fuel tank.

### SELECTIVE CATALYTIC REDUCTION – DRIVER WARNINGS AND INDUCEMENTS









SCR system components must not be removed, altered or modified in any way. In order to protect the SCR system from tampering, inducement measures will occur if the following states are detected:

- Disconnection of DEF tank level sensor
- Blocked DEF line or dosing valve
- Disconnection of DEF dosing valve
- Disconnection of DEF pump
- Disconnection of SCR wiring harness
- Disconnection of NO<sub>x</sub> sensor
- Disconnected exhaust temperature sensor
- Disconnected DEF temperature sensor
- Disconnected DEF quality sensor

DEF TANK LEVEL DRIVER WARNINGS AND INDUCEMENTS				
Conditions / Triggers		DEF Tank LOW LEVEL Indicator, DID Message and audible warning		Inducement
1	<b>Normal</b> DEF tank level sensor reads between 100% and 10%	None		None
3	<b>DEF tank near empty</b> DEF tank level sensor reads less than 5% 	 blinking	None	Engine torque reduction of 25%
4	<b>DEF tank empty</b> and one (1) hour of operation in engine derate mode 	 blinking	(3/4) DEF TANK EMPTY  ENGINE IN DERATE 5 MPH LIMIT IF VEHICLE NOT MOVING FOR 20 MIN  3 cycles of 2 beeps	Engine torque reduction of 40%
5	<b>DEF tank empty</b> 1. Diesel fuel refueling done with a fuel level sensor reading increase of 15%, or more 2. Vehicle stationary (speed=0) for 20 minutes with engine off or at idle 	 blinking	(4/4) REFILL DEF TANK  VEHICLE SPEED LIMITED TO 5 MPH (8 KM/H)  continuous cycle of 2 beeps	Vehicle road speed limited (RSL) to 5 mph (8 km/h)

DEF QUALITY DRIVER WARNINGS AND INDUCEMENTS				
Conditions / Triggers		Amber Warning Light & Did Message And Audible Warning		Inducement
1	<b>Good DEF quality</b>	None		None
2	<b>Poor DEF quality detected</b>	 solid	(1/4) DEF QUALITY OK TO CONTINUE DRIVING  3 cycles of 2 beeps	Engine will derate 25% in < 60 mins
3	<b>Poor DEF quality detected</b> and one (1) hour of operation with active diagnostic troubleshooting code	 solid	(2/4) DEF QUALITY OK TO CONTINUE DRIVING  3 cycles of 2 beeps	Poor def quality detected Engine derated 25% engine will derate 40% in <240 mins
4	<b>Poor DEF quality detected</b> and four (4) hours of operation with active diagnostic troubleshooting code	 solid	(3/4) SERVICE DEF 5 MPH LIMIT IF VEHICLE NOT MOVING FOR 20 MIN  3 cycles of 2 beeps	Engine derated 40% 5 mph (8km/h) limit after next 20 min vehicle stop
5	<b>Poor DEF quality detected</b> Diesel fuel refueling done with a fuel level sensor increase of 15% or more or Vehicle stationary (speed=0) for 20 minutes with engine off or at idle or Key cycle trigger	 solid	(4/4) POOR DEF QUALITY 5 MPH LIMIT SERVICE DEF SYSTEM  continuous cycle of 2 beeps	Service DEF 5 mph (8km/h) limit

## 5-8 OTHER FEATURES

SCR SYSTEM TAMPERING DRIVER WARNINGS AND INDUCEMENTS				
Conditions / Triggers		Amber Warning Light, Did Message And Audible Warning		Inducement
1	<b>Normal</b> No diagnostic troubleshooting code active	None		None
3	<b>An SCR fault has been detected</b> Continue driving	 solid	(1/4) SRC SYSTEM OK TO CONTINUE DRIVING  3 cycles of 2 beeps	25% Engine torque reduction in 60 minutes
4	<b>An SCR fault has been detected</b> Continue driving	 solid	(2/4) SRC SYSTEM OK TO CONTINUE DRIVING  3 cycles of 2 beeps	Engine torque derated 25% 40% Engine torque reduction in 240 minutes
5	<b>An SCR fault has been detected</b>	 solid	(3/4) SCR SYSTEM 5 MPH LIMIT IF VEHICLE NOT MOVING FOR 20 MIN  3 cycles of 2 beeps	Engine torque derated 40% Vehicle speed limited to 5 mph (8 km/h) if vehicle is immobilized for more than 20 min
6	<b>An SCR fault has been detected</b> Diesel fuel refueling done with a fuel level sensor increase of 15% or more or Vehicle stationary (speed=0) for 20 minutes with engine off or at idle or Key cycle trigger	 solid	(4/4) SCR SYSTEM 5 MPH LIMIT SERVICE SYSTEM  continuous cycle of 2 beeps	Vehicle speed limited to 5 mph (8km/h)



## DRIVER INFORMATION DISPLAY (DID) MENUS

There are Driving and Non-Driving menus. Several sub-menus are password-protected while the vehicle is parked. The Non-Driving menu is accessible only when the vehicle is parked.

Refer to “Driver Information Display” in CONTROLS AND INSTRUMENTS section for details on how to scroll through DID menus or select an item whose setting is to be changed.

DRIVING MODE MENUS	NON-DRIVING/STATIONARY MODE MENUS
<b>Gauges</b> <ol style="list-style-type: none"> <li>1. Current Gear Position (I-Shift only)</li> <li>2. Outside Temperature</li> <li>3. Engine Oil Temperature</li> <li>4. Transmission Fluid Temperature</li> <li>5. Prevost Liaison Compass</li> <li>6. Accessories Air Pressure</li> <li>7. A/C Compressor Pressure</li> <li>8. Battery Voltage</li> <li>9. Allison Transmission Oil Life</li> <li>10. Battery State Of Charge</li> <li>11. Electric Cooling Fan Status</li> </ol>	<b>Display Settings</b> <ol style="list-style-type: none"> <li>1. Language</li> <li>2. Units</li> <li>3. Time/Date</li> <li>4. Favorite Display Setting</li> <li>5. Display Light</li> <li>6. Change Password</li> </ol>
<b>Fuel Data</b> <ol style="list-style-type: none"> <li>1. Fuel Flow</li> <li>2. Fuel Flow / ECO %</li> <li>3. Trip Fuel Used</li> <li>4. Distance to Empty</li> </ol>	<b>Diagnostics</b> <ol style="list-style-type: none"> <li>1. View Active Faults</li> <li>2. View Inactive Faults</li> <li>3. Cluster Selftest</li> <li>4. Part Number</li> <li>5. Reset Inactive Faults</li> <li>6. Vehicle Tests</li> </ol>
<b>Time-Distance</b> <ol style="list-style-type: none"> <li>1. Time and Date</li> <li>2. Alarm Clock</li> <li>3. Trip Odometer 1 and 2</li> <li>4. Average Trip Speed</li> <li>5. Estimated Time of Arrival (ETA)</li> </ol>	<b>Pre-Trip Assistance</b> <ol style="list-style-type: none"> <li>1. Exterior Light Inspection</li> <li>2. Air Leakage Monitor</li> </ol>
<b>Vehicle Messages</b>	<b>Datalog</b> <ol style="list-style-type: none"> <li>1. Vehicle ID</li> <li>2. Total Data</li> <li>3. Trip Data</li> <li>4. Reset Trip Data</li> </ol>
<b>Reset Trip Data</b>	<b>Aftertreatment</b> <ol style="list-style-type: none"> <li>1. Request Parked REGEN</li> <li>2. ATS Status</li> <li>3. Cancel REGEN</li> </ol>
	<b>Password</b> <ol style="list-style-type: none"> <li>1. Enter Password</li> </ol>
	<b>Brake Lining Remaining</b>
	<b>Prevost Liaison</b> <ol style="list-style-type: none"> <li>1. Read Message</li> <li>2. Send Message</li> <li>3. Other Info</li> </ol>

## 5-10 OTHER FEATURES

---

### GAUGES

There are several gauges in this menu. The gauges are used to view current status of important functions in the vehicle.

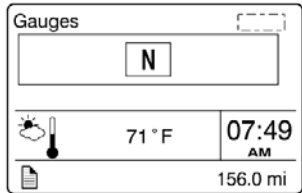

#### Current Gear Position (I-Shift transmission only)

Indicates the current gear position selected on the I-Shift transmission.

D= drive

N= neutral

R= reverse

M= manual

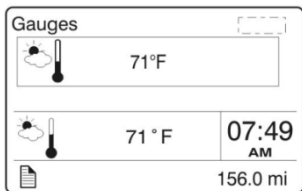

#### 1. Outside Temperature

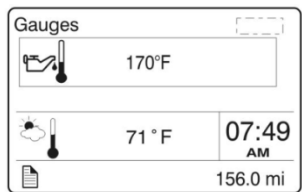

#### 2. Engine Oil Temperature

Selecting this gauge will display the engine oil temperature.

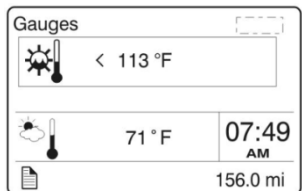

#### 3. Transmission Fluid Temperature

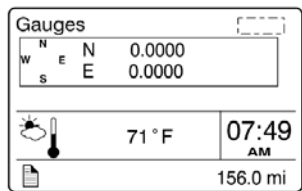

#### 4. Prevost Liaison Compass

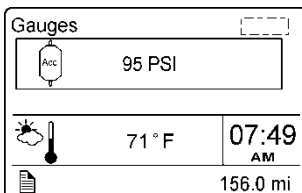

#### 5. Accessories Air Pressure

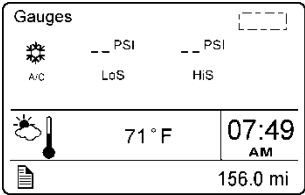

**6. A/C Compressor Pressure**

Displays the A/C compressor suction pressure value (LoS=low side) and discharge pressure value (HiS=high side).

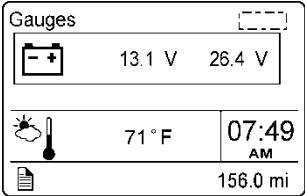

**7. Battery Voltage**

Displays current 12-volts and 24-volts systems voltage.

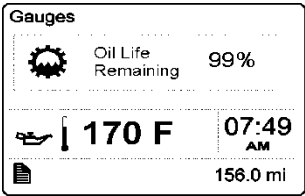

**8. Allison Transmission Oil Life**

Displays the percentage of the calculated remaining life of the transmission oil. New oil is displayed as 99%. Refer to Appendix C for more details.

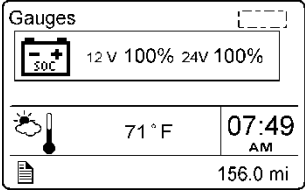

**9. Battery State Of Charge**

Displays the state of charge of the 12-volt and 24-volt systems, expressed in percentage.

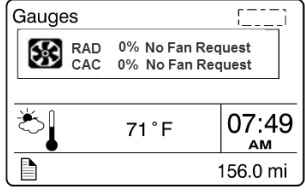

**10. Electric Cooling Fan Status**

Displays the speed and the state of both Charge Air Cooler and radiator cooling fans, expressed in percentage from 0 to 100%.

**FUEL DATA**

The Fuel Data menu provides information on the fuel consumption of the vehicle in various situations. For example, how much fuel has been used, how much fuel is remaining before refueling the vehicle.

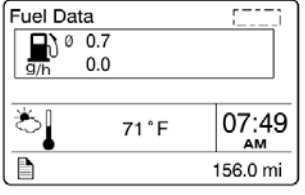

**1. Fuel Flow**

The lower numerical value (0.0) indicates the instantaneous fuel consumption. In this menu, you can reset the upper numerical value which is the average fuel consumption (0.7). To reset, hold ENTER button for 1 second.

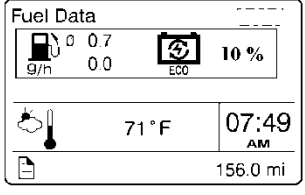

**2. Fuel Flow / ECO%**

The lower numerical value (0.0) indicates the instantaneous fuel consumption. In this menu, you can reset the upper numerical value which is the average fuel consumption (0.7). To reset, hold ENTER button for 1 second.

This menu also displays the percentage of trip made on regenerated electricity (10%).

## 5-12 OTHER FEATURES

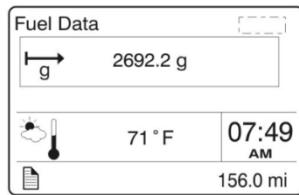

### 3/4 Trip Fuel Used

Indicates the total fuel consumption (gallons/liters) since the last reset.

Note: You should use Reset function before each new trip.

You can reset the fuel consumption value in this menu. To reset, hold ENTER button for 1 second.

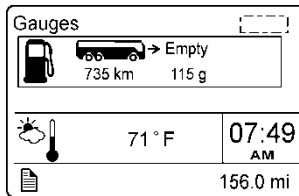

### 4/4 Distance to Empty

The left numerical value indicates the distance that can be traveled with the quantity of fuel that remains in the tank as indicated by the right numerical value.

## TIME/DISTANCE

The time and date can be set in the Time/Distance menu. The alarm clock can also be set from this menu. Following the alarm clock menu is the Trip Odometer 1 and 2 selection, which allows the operator to see the distance travelled since the last reset. Average trip speed is also shown. By specifying the distance to your destination, the vehicle can calculate the estimated time of arrival (ETA).

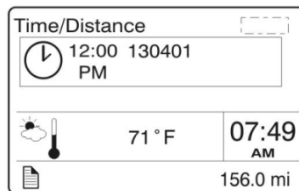

### 1. Time And Date

Adjust time and date with this menu. The instrument cluster has its own internal battery, so the date and date setting is keep in memory even if the vehicle's battery is disconnected.

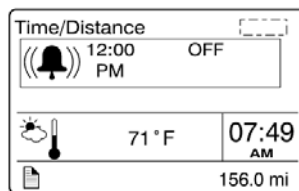

### 2. Alarm Clock

Use this function to program and activate an alarm on the instrument cluster clock. When the alarm clock goes off, a warning signal is sounded. The alarm shuts off after 60 seconds or if the ESCAPE button is depressed.

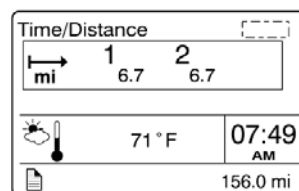

### 3. Trip Odometer 1 and 2

Allows the operator to see the distance travelled since the last reset. You can reset the trip odometer 1 or 2 in this menu. To reset, depress ENTER button, use UP/DOWN button to select between odometer 1 or 2 and then hold ENTER button for 1 second.

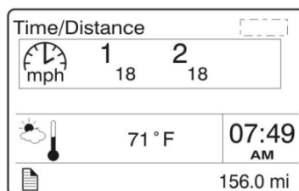

### 4. Average Trip Speed

This function displays the average speed for the current travel. The average trip speed is calculated as the distance traveled divided by the time the engine has been running (since the last reset). Two average trip speeds can be measured, corresponding to leg 1 and leg 2. Use Reset function before each new travel to start new measurements.

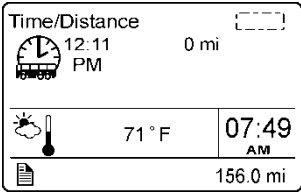

5. Estimated Time of Arrival (ETA)

This function will display the estimated time of arrival if the distance to be traveled is entered first, in this menu. To set distance to be traveled, press ENTER and enter the distance left to drive in mile or km using ENTER and UP/DOWN buttons.

VEHICLE MESSAGES

Use this function to consult the vehicle active messages that were previously displayed as pop-up messages and then acknowledged. When consulting a message, the corresponding STOP, CHECK or INFORMATION warning light will illuminate. Scroll through the messages using the up/down button. Press ESC button to return to main menu.

RESET TRIP DATA

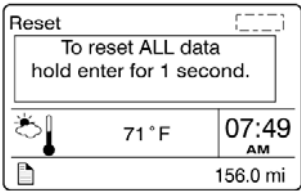

When the Reset Trip Data menu is open, pressing and holding down the ENTER button for more than 1 second resets the functions listed below. This function will permit to the system to calculate new value from the point of resetting.

- Trip Fuel Used
- Average Trip Speed

DISPLAY SETTINGS

The Display Settings menu is used to change languages and units. The password, time and date can also be changed. The backlight and contrast of the display screen can be adjusted.

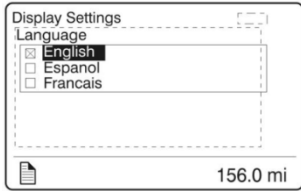

1. Language

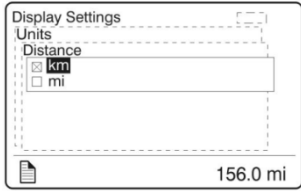

2. Units

Use this function to select desired unit formats for:

- Distance (miles or km)
- Fuel consumption (km/l, l/100km, mpg US or IMP)
- Temperature: °C or °F
- Brake lining: 1/32 inch, mm, %.

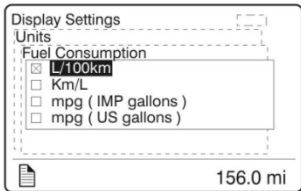

## 5-14 OTHER FEATURES

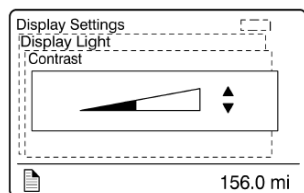
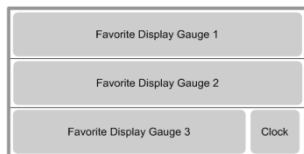
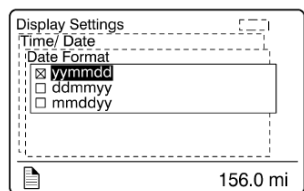
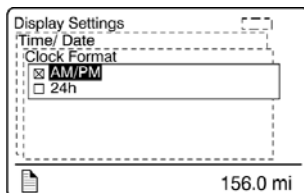
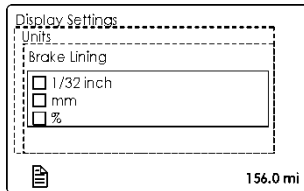
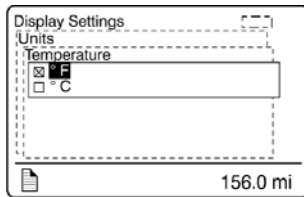

### 3. Time/Date

Select the clock format and date format using this function.

- AM, PM, 24h
- yymmdd, ddmmyy, mmddy

### 4. Favorite Display Setting

Use this menu to select your favorite display gauges 1, 2 and 3 and replace the default gauges. On vehicles provided with the I-Shift transmission, Favorite Display Gauge 3 cannot be edited as it is kept for display of the transmission status.

Example: You wish to display the engine oil temperature at the Gauge 1 position.

- Use UP/DOWN button until Gauge 1 position is selected.
- Press ENTER button to confirm.

Use UP/DOWN button to scroll through the available gauges. When the engine oil temperature gauge is displayed, press ENTER button to confirm (repeat steps 1-3 to change Gauge 2 and Gauge 3 if needed).

### 5. Display Light

The Display Light menu has three sub-menus:

- Contrast: Adjust the contrast with the UP/DOWN button and press ENTER button to confirm.
- Backlight: In this menu, the display lighting can be adjusted relative to other instrument lighting with the UP/DOWN button.
- Night/Day: Use the Night/Day menu to choose a dark background with light text and images or a light background with dark text and images. Press ENTER button to toggle between Night and Day.

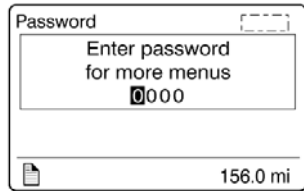
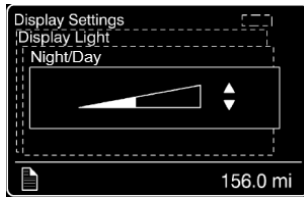
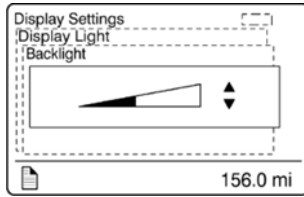

**6. Change Password**

Use this menu to change the current password. This menu is only accessible if the correct password is entered. The default password is 0000.

- Mark which password is to be changed with the display UP/DOWN button.
- Confirm with ENTER button.
- Set the first digit with the UP/DOWN button.
- Step to the next digit using ENTER button.
- Step backwards with ESC button.

**DIAGNOSTICS**

The Diagnostics menu enables fault tracing on the control units in the vehicle to check for faults. Instrument tests are available to check the telltales, gauges, display and speaker. The part number of a control unit can be identified in the part number menu.

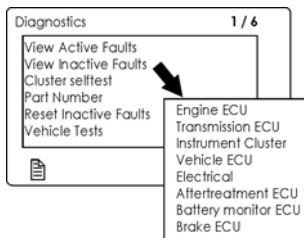

**1. View Active Faults**

A list of the control units on the vehicle is displayed. Use this function to check for active faults on specific control units.

**2. View Inactive Faults**

Use this function to check for inactive faults on specific control units.

**3. Cluster Selftest**

Use this menu to check proper functioning of the following components:

- Telltale lights
- Analog gauges
- Display
- Speakers

The following table describes the available tests. To cancel a test, press the ESC button).

Telltale lights test	Telltale lights illuminate for approximately five seconds. Press the Esc button to cancel the test.
Analog gauges	The indicators move forwards and backwards between the end positions. They do not show any particular value. This is just a check to confirm that the indicators move, and to make sure the operators are working. Press the Esc button to cancel the test.
Display test	The entire display lights up until the Esc button is pressed.
Speaker Test	A sound is emitted through the speakers. Press the Esc button to cancel the test.

**4. Part Number**

A list of the control units on the vehicle with their part numbers is displayed in the Part Number menu.

**5. Reset Inactive Faults**

Use this menu to delete an inactive fault for a particular control unit. Note: it is not possible to delete inactive faults of the Engine ECU.

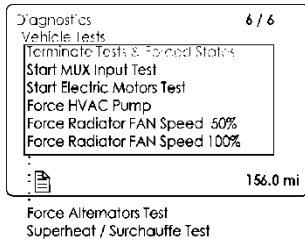

**6. Vehicle Tests**

Use this menu to perform tests on several components and systems:

- dashboard switches (Mux Input Test)
- electric motors, valve and pump contactors (Electric Motors Test)

In case of overheating of the engine due to a malfunction of the radiator fan you can force activation of the fan using ACTIVATE RADIATOR FAN SPEED 50% or 100%.

The DID status line will show TEST to confirm that one of the test modes is active. To cancel an active test, turn the ignition switch to the OFF position or press ESCAPE button, select TERMINATE TESTS & FORCED STATES submenu and then press ENTER button twice. "TEST" will disappear from the DID status line.

For further information concerning these functions, refer to section 06: Electrical, under "Available Test Modes" and "Limp-home Modes" paragraph of the Maintenance Manual.



**PRE-TRIP ASSISTANT (OPTION)**

The Pre-Trip Assistance option is a tool to assist the driver in completing the pre-trip inspection of the vehicle. This option is not a substitute for a complete pre-trip inspection. If any system of the vehicle does not pass inspection, the error must be corrected before operating the vehicle. The available pre-trip tests include the Exterior Light Inspection check, and the Air Leakage check.

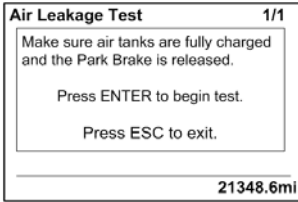
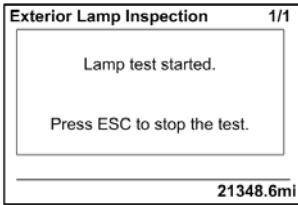
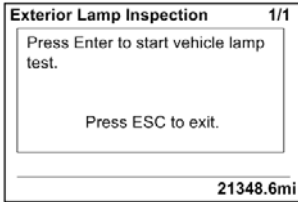

**1. Exterior Light Inspection**

The Exterior Light Inspection function turns on all the exterior lights simultaneously. This allows the operator to start the test, exit the vehicle and do a visual check that all exterior lights function properly. Press ESCAPE button to end the test and turn off all the exterior lights.

**2. Air leakage Monitor**

The Air Leakage check allows the driver to accurately measure the amount of air pressure drop in the front and rear brake air systems. After selecting this test from the DID, you are prompted to apply the service brake for 60 seconds. After applying and holding the service brake for 60 seconds, the DID will display the amount of pressure drop in the brake system.

Before starting the test through the DID, complete the following:

- a. Chock the wheels to prevent the vehicle from rolling.
- b. Start the engine and check that the brake systems air pressure is greater than 100 psi.
- c. Turn engine off.
- d. Release the parking and service brakes and allow the system to settle (air gauge needle stops moving).
- e. Press the ENTER button to start the test.
- f. If the air tanks pressure is too low to perform the test (pressure must be greater than 100 psi), the following messages will appear.

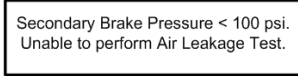
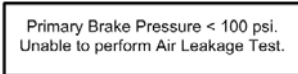

## 5-18 OTHER FEATURES

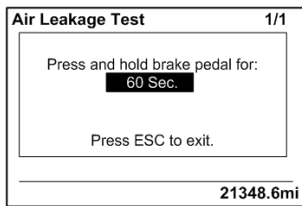

g. You must press and hold brake pedal for 60 seconds, as instructed.

Pressure Leak Test Results

Tank	Before	After	Drop
F	127	127	0
R	129	129	0

(1)VEC 2044.6mi

h. Once the brake pressure test is completed the pressure leak test results are displayed.

### DATA LOG

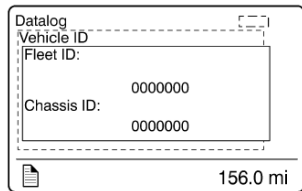

#### 1. Vehicle ID

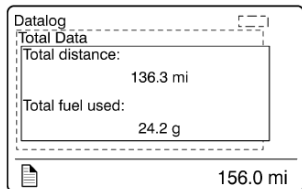

#### 2. Total Data

Total Data menu indicates the accumulated engine values that have been logged during the lifetime of the engine ECU.

Available information:

- Total distance traveled
- Total fuel used
- Total engine hours
- Total idle time
- Total PTO hours
- Total engine revolutions

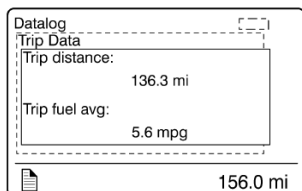

#### 3. Trip Data

This menu displays the trip information listed below. This function must be reset before each measurement (before each new trip or leg) using the Reset Trip Data menu.

Available information for the trip or leg is:

- Trip distance (miles or km)
- Trip fuel average (mpg, liter/100km; km/liter)
- Trip fuel used (gallons or liters)
- Trip duration on cruise control (hours)
- Trip duration with engine rpm greater than economy rpm (hours)

- Trip duration while engine rpm is greater than the desire maximum rpm RPM Limit set in Fleet Limits sub-menu (hours)
- Trip fuel used with engine rpm greater than the economy rpm (gallons/liters)
- Trip average speed (mph, km/h)
- Trip duration with speed greater than the maximum desired speed as set in Fleet Limits sub-menu (hours)
- Trip engine hours
- Trip duration on engine idle (hours)
- Trip fuel used while in engine idle (gallons, liters)

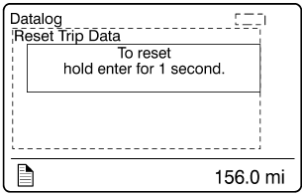

**4. Reset Trip Data**

This menu can only be accessed if the correct password has been entered. Use this function to reset measurements of the Trip Data menu before each new trip or leg.

**AFTERTREATMENT**

This menu permits to the driver to initiate a stationary regeneration, to check the status of the aftertreatment system and to interrupt regeneration.

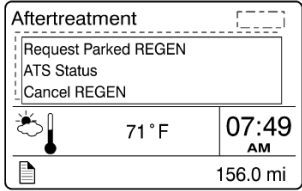

**1. Request Parked REGEN**

Use this function to initiate a stationary (parked) regeneration.

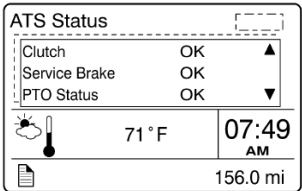

**2. ATS Status**

The Aftertreatment status sub-menus provide information about the conditions required for performing regeneration. The status can be OK (regeneration allowed), CHECK (regeneration not allowed) or N/A (not applicable). When ATS Status is selected, the following sub-menus are available.

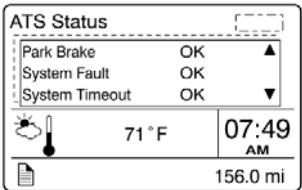
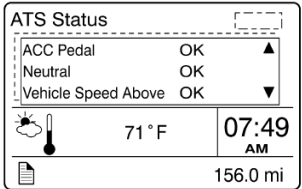

## 5-20 OTHER FEATURES

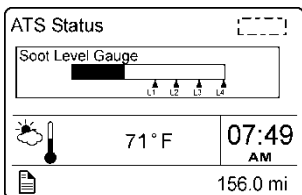
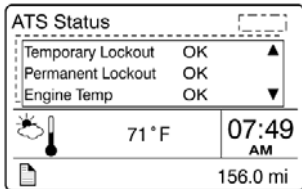
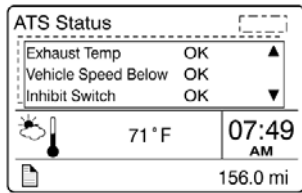

### Soot Level Gauge

From the ATS Status sub-menu, you can view the soot level for the Aftertreatment system. When the soot level is high, regeneration is necessary. L1, L2, L3 and L4 under the scale correspond to Level 1 up to Level 4 (see Diesel particulate filter clogging sequence – Engine indicator lamp).



### 3. Cancel REGEN

From the Aftertreatment main menu, you can cancel a REGEN cycle.

## PASSWORD

Certain functions are password-protected. These passwords give the user access to all password-protected functions. The default password is 0000.

### 1/1 Password

The following menus are password-protected and marked with a key symbol in the menus:

- Change Password
- Fleet ID
- Reset Trip Data
- Fault Diagnostics
- Inactive Faults

## BRAKE LINING REMAINING

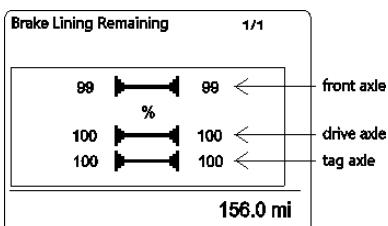

The numerical values indicate the brake lining remaining in 1/32 inch, mm or in term of percentage (%), depending on the unit selected in Display Settings menu (new brake pads are displayed as 100% if the unit selected is %).

## PREVOST LIAISON (OPTION)

The Prevost Liaison system provides cellular communication between the driver and the fleet operator. The driver can send and receive short text messages, which are visible through the Driver Information Display.

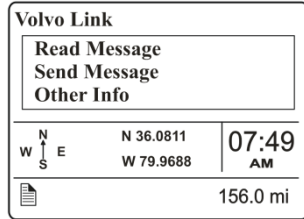

The following menus are available:

### 1. Read Message

- Quick Response (only available if there is a message available)

### 2. Send Message

- Driver & Equipment
- Dispatch Messages
- Free Text

### 3. Other Info

- Comm Liaison Info
- Mailbox Info
- GPS Info
- INI Info
- Configuration Info

## REAR GAUGE - ENGINE COMPARTMENT

The vehicle rear control panel is equipped with a combination tachometer / message display center intended to help the technician with the control and verification of the engine, transmission, UDS system (ACM) parameters among others.

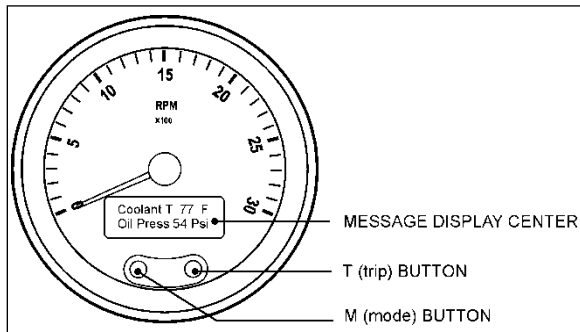

ENGINE COMPARTMENT REAR GAUGE ON REAR START CONTROL PANEL

### START-UP MODE

Gauge pointer will drive to zero position. The pointers will then drive up scale, pausing at half scale, before completing the sweep to full scale.

The pointers will then return to zero position before moving to the commanded position.

During the upscale sweep of the pointer, the LCD will turn all its segments off for one second and then display the opening message. The opening message is the Prevost logo.

### IGNITION MODE

The ignition mode is active as long as the ignition switch is set to the ON position. The ignition is the normal operational mode of the system.

### SELF-DIAGNOSTIC MODE

The self-diagnostic mode is entered through a menu selection using the LCD.

The self-diagnostic includes the following tests:

- Gauges
- LCD
- Binary Inputs
- Analog Inputs
- Communications
- Error codes on Engine, Transmission or UDS

### MESSAGE CENTER DISPLAY

The message display is a graphical, backlit, LCD that displays information to the technician. In addition to basic odometer functions, a variety of customer-defined options will be displayed. Fault codes will also be displayed as they are received. Instrumentation diagnostics can be viewed on the LCD as well.

### Drive Mode Screen

At startup the default drive mode screen is coolant temperature and oil pressure. When the display of engine hours is enabled, then engine hours and oil pressure is displayed on startup.

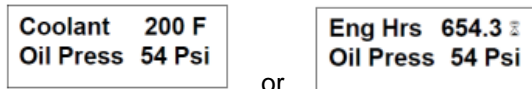

### LCD Display Selection

Pressing **M** and **T** together toggles units between English and Metric. Pressing the **T** button changes the LCD display parameters.

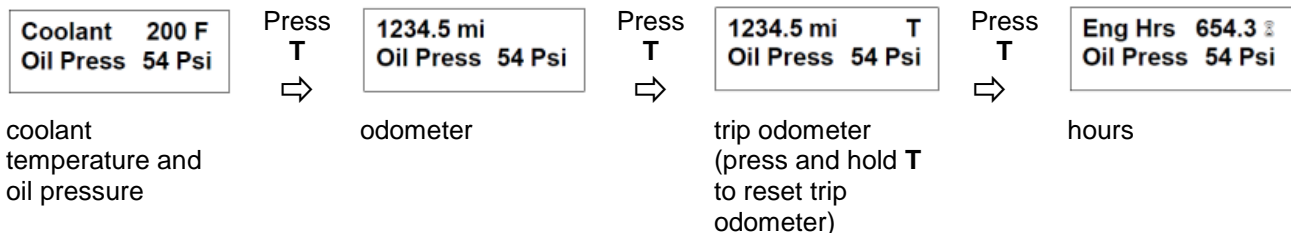

## Priority Messages

No Priority Message will be displayed during the first 10 seconds after ignition ON.

Priority messages can be generated by the engine, transmission or UDS controllers (ACM) or binary inputs.

Priority messages will interrupt the bottom line of the LCD in order to provide the technician with priority information.

A priority message is removed from the display only if its source expires or if the trip button acknowledges it. Some messages can be acknowledged. If acknowledged, it remains removed from the display and will only reappear if the source expires and reoccurs. If the ignition is turned off and then back on and a priority message is still active, it will display again.

If more than one priority message is active, each message will be displayed one after the other for three seconds each.

Assignment	Exact Text	Acknowledge?	Recur?	Turns off if
Engine Comm. Failure	ENG. COMM. ERROR	Yes	No	Communication is re-established
Trans Comm. Failure	TRANS. COM. ERROR	Yes	No	Communication is re-established
ABS Comm. Failure	ABS. COMM. ERROR	Yes	No	Communication is re-established
Inst Panel Comm Failure	IPANEL.COMM.ERROR	Yes	No	Communication is reestablished
High Coolant Temp Alert	CHECK COOL TEMP	Yes	No	DM1 Clears
Low Coolant Level	LOW COOLANT LEVEL	Yes	No	message clears after 30 sec
	LOW COOLANT LEVEL	Yes	No	Flag Clears
Check Coolant SNS	CHECK COOLANT SNS	Yes	No	Flag Clears
Low Oil Pressure Alert	LOW OIL PRESSURE	Yes	No	DM1 clears
High Trans Temp Alert	CHECK TRANS TEMP	Yes	No	DM1 clears
Wait to Start	WAIT TO START	Yes	No	Msg clears
Water in Fuel	WATER IN FUEL	Yes	No	Msg clears
Engine Maintenance	ENG. MAINTENANCE	Yes	No	DM1 clears
+ Stop Engine	STOP ENGINE !!	No	No	Msg clears
Check Engine	CHECK ENGINE !	Yes	No	Msg clears
Transmission Maintenance	TRANSMMAINTENANCE	Yes	No	DM1 clears
Network Fail	NETWORK FAILURE	Yes	No	Input clears
Check Transmission	CHECK TRANSMIS.	Yes	No	Msg clears
Stop Transmission	STOP TRANSMIS.!!	No	No	DM1 clears
Fire Alarm Detect	FIRE ALARM	No	No	Input Clears
ABS Maintenance	ABS.MAINTENANCE	Yes	No	DM1 clears
Check ABS	CHECK ABS!	Yes	No	Msg clears
Alternator charging failure	CHARGING FAILURE	Yes	No	Binary input or flag turn off
Low Battery	LOW BATTERY VOLT.	Yes	No	12V voltage > 12V for 30sec or 24V voltage > 24V for 30sec
High Battery	HIGH BATTERY VOLT	Yes	No	12V voltage < 17V for 30sec or 24V voltage < 30V for 30sec
Check Diesel Particle Filter	DIESEL.PART.FILT..	Yes	No	Message clears
Change Diesel Particle Filter	DIESEL.PART.FILT.	Yes	No	Message clears
Low Primary Air Pressure	LOW.PRIMARY AIR	No	No	Air pressure ≥ 75 psi
Low Secondary Air Pressure	LOW.SECONDARY.AIR	No	No	Air pressure ≥ 75 psi

## 5-24 OTHER FEATURES

---

### Settings and Diagnostic Screens

The Settings and Diagnostic screens can be accessed when the drive mode screen is displayed and the **M** button is pressed for longer than 5 seconds or if no CAN messages are seen then holding the **M** button will enter the menu.

Once in the Settings and Diagnostics menu, pressing the **M** or **T** buttons separately moves the reverse video highlight up or down through the list, as indicated by the arrows. The highlighted item is selected when both **M** and **T** buttons are pressed at the same time. If no button is pressed for 5 seconds, the LCD will go back to the standard Drive Screen. The items available in the menu are:

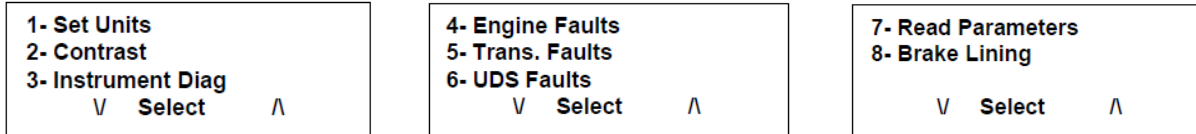

This menu exits to the drive mode screen when there has been inactivity for 5 seconds.

#### 1 - Set Units

Selecting menu item 1 brings up the following screen that is used to select if values are to be displayed in metric units or English units. Pressing **M** or waiting 5 seconds exits to Settings and Diagnostics menu.

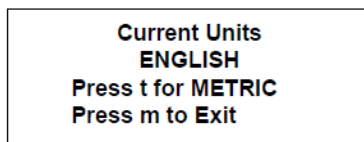

#### 2 – Contrast

Selecting menu item 2 displays a screen to allow setting the LCD contrast. Pressing the **M** (+) button will increase contrast while pressing the **T** (-) button will decrease contrast. After inactivity for 5 seconds this menu exits to the Settings and Diagnostics menu.

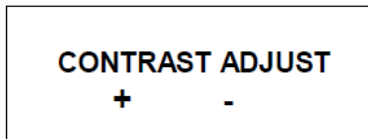

#### 3 – Instrument Diag

Selecting menu item 3 in the Settings and Diagnostic menu will display the instrument diagnostic menu. There are 3 items in this menu and is navigated the same as the previous menu. This menu exits to the Settings and Diagnostics screen when there has been inactivity for 5 seconds.

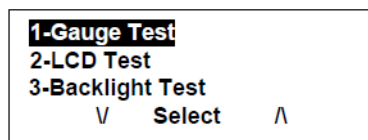

#### Gauge Test

Item 1 – The gauge pointer will be driven through three positions pausing at each position as shown in the LCD as a percentage of scale. This test will proceed and return to the Instrument Diagnostic menu. Pressing the **M** button will end the test and return to the Instrument Diagnostic menu.



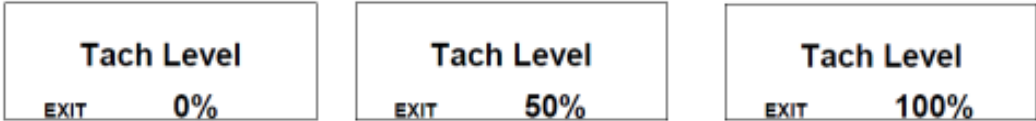

**LCD Test**

Item 2 –Displays the Prevost in normal then reverse video three times and then returns to the

**Backlighting Test**

Item 3 – Cycles the gauge and LCD backlight through 3 brightness levels twice displaying the corresponding intensity on the LCD. Pressing M during the test or allowing the test to complete returns the gauge to the Instrument Diagnostics menu.



**4 – Engine Faults**

For all ECU, an array is defined containing DTC, SPN & Specific FMI. If the SPN is not known, the value is displayed in decimal. For active faults, the array is filled with information obtained from DM1.

This screen displays DTC, SPN & associated FMI, otherwise, the Suspect Parameter Number (SPN) and Failure mode Identifier (FMI) as received from the engine for active faults via J1939.

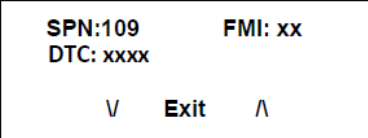

**5 – Trans. Faults**

For all ECU, an array is defined containing DTC, SPN & Specific FMI. If the SPN is not known, the value is displayed in decimal. For active faults, the array is filled with information obtained from DM1.

This screen displays DTC, SPN & associated FMI, otherwise, the Suspect Parameter Number (SPN) and Failure mode Identifier (FMI) as received from the transmission for active faults via J1939.

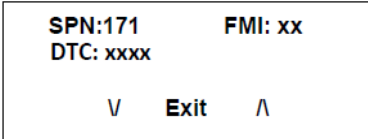

**6 - UDS Faults (ACM, Aftertreatment System ECU)**

For all ECU, an array is defined containing DTC, SPN & Specific FMI. If the SPN is not known, the value is displayed in decimal. For active faults, the array is filled with information obtained from DM1.

This screen displays DTC, SPN & associated FMI, otherwise the Suspect Parameter Number (SPN) and Failure mode Identifier (FMI) as received from the UDS (ACM) for active faults via J1939.

## 5-26 OTHER FEATURES

SPN:241	FMI: xx
DTC: xxxx	
V	Exit
	Λ

### 7 – Read Parameters

Selecting menu item 7 displays various parameters received by the rear gauge (engine RPM, boost pressure, engine load, transmission oil temp, engine coolant temp, engine oil pressure, primary air system pressure, secondary air system pressure, accessory air system pressure, fuel level, instantaneous fuel economy, average fuel economy, total engine hours, wheel based vehicle speed, gear engaged, 24V system voltage, 12V system voltage). The main use for these screens is in troubleshooting the system.

Eng RPM	775 RPM
Boost Pr	5 Psi
Eng Load	23 %
V	Exit
	Λ

Trans T	195 °F
Coolant T	180 °F
Oil Press	40 Psi
V	Exit
	Λ

Prim.Air	115Psi
SecondAir	115Psi
Acc Air	115Psi
V	Exit
	Λ

Fuel Level	74 %
Inst Fuel	15.4 mpg
Avg Fuel	12.6 mpg
V	Exit
	Λ

Hrs	123.45 hrs
Speed	31.1 mph
Gear	Neutral
V	Exit
	Λ

24V Batt.	23.1V
12V Batt.	13.2V
Eng RPM	775 RPM
V	Exit
	Λ

### 8 – Brake Lining (state)

Item 15 - A sub-menu is displayed to choose between 3 types of displaying:

- In 1/32 of inches
- In millimeters
- In %

Brake Lining in 1/32 inch
Brake Lining in mm
Brake Lining in %

The displaying in 1/32 of inches and millimeters requires two parameters:

- Corresponding value in 1/10 of millimeters for 100%
- Offset value in 1/10 of millimeters for 0%

The hardcoded value for these two parameters are:

Parameters	Default value (1/10mm)
100% value	150
0% value	50

The following message is displayed on the screen for showing the Brake Lining State, for a % displaying:

The front wheels are displayed on the left side of the screen, right side on the top. The value is expressed in % for each brake lining.

FR	DR	TR
FL	DL	TL

<b>Brake Lining %</b>		
100	53	43
98	55	42
<- FL Wheel Press m to Exit		

### INTELLIGENT SLEEP MODE (ISM)

The ISM is a battery-saving feature designed to monitor the battery State Of Charge (SOC). The ISM will automatically change the vehicle electrical system from normal functional state to sleep mode if the battery SOC falls below 65%.

Once the vehicle has entered into sleep mode, the only actions needed to put the vehicle back into its normal functional state are:

- To cycle the ignition lever from OFF to ON;  
or
- To open the entrance door;  
or
- To turn on the hazard lights.

The ISM forces the vehicle to go into sleep mode if all the following conditions are met:

1. The engine is not running;
2. The parking brake is applied
3. The ignition switch is at the ON, ACC positions or at the OFF position but the 15 minutes “wake up” period after engine shutdown is not expired.
4. The battery state of charge of 12V or 24V system falls below 65%.

The red ALTERNATOR telltale will illuminate 30 seconds before activation of the sleep mode.



### TRANSMISSION OUTPUT RETARDER

The transmission output retarder is a device that helps to reduce the speed of a vehicle. It improves vehicle control, increases driving safety and permits more economical operation. The retarder provides slowing power when it is most needed, such as when descending mountain roads, in stop-and-go traffic and on crowded freeways.

The transmission output retarder is a vehicle-slows device, not a vehicle-stopping device. It is not a substitute for the service braking system. The service brake must be used to bring the vehicle to a complete stop.

**NOTE**

*Extended use of transmission output retarder will raise the temperature of the transmission fluid.*

A disable switch is located in the RJB close to the master brake interlock.

**NOTE**

*Deactivating the transmission retarder will turn the indicator light located at the front of the coach ON.*

Three levels of retarding power are available with the output retarder enabled: 1/3 of total retarding power is applied as soon as the brake pedal is pressed. If more force is applied to the brake pedal, 1/3 of retarding power is added. Finally, with full force applied to the brake pedal, an additional 1/3 of retarding power is added for a total of 100% of the available output retarding power.

Action	Retarding Power
Initial pressure on the brake pedal	33% of total retarding power
Additional pressure on service brake pedal	66% of total retarding power
Full force on the brake pedal	100% of total retarding power

**NOTE**

*The stoplights automatically illuminate when the vehicle is slowing down after application of the transmission retarder.*

**NOTE**

*As the wheels start to lock up on slippery roads, the output retarder automatically deactivates until the wheels roll freely.*

### ANTILOCK BRAKING SYSTEM (ABS)

The purpose of the Antilock Braking System (ABS) is to maintain vehicle stability and control during braking and to minimize the stopping distance in any road condition.

On slippery roads and more generally in emergency situations, over-braking frequently induces wheel locking. Wheel locking greatly increases breaking distance on any road surface. Locked wheels also impede directional control and cause severe tire abrasion. An antilock braking system provides maximum braking performance while maintaining adequate control on slippery roads.

The basis of ABS is constant monitoring of wheel parameters during braking. Sensors on each wheel of the front and drive axles constantly measure wheel speed during braking. This information is transmitted to a four-channel electronic processor which senses when any wheel is about to lock. Modulating valves quickly adjust brake pressure (up to 5 times every second) to prevent wheel lock. Each wheel is therefore controlled according to the available grip.

In this way, the vehicle is brought to a stop in the shortest possible time while remaining stable and under the driver's control.



### WARNING

Vehicles following ABS-equipped vehicles may not be able to brake as fast on slippery roads.

### KNEELING SYSTEM

This system lowers the front end, enabling passengers to get on and off the coach without any difficulty.

#### NOTE

*This coach is equipped with an interlock system which automatically applies the parking brake when the kneeling system is activated.*

To operate, stop the coach, set the transmission to neutral (N), then push down the rocker switch located on the dashboard. (Refer to "Controls & Instruments" section). The parking brake will be applied automatically and a status line pictogram will appear on the DID to indicate that the front of the coach is being lowered.

To raise the front of the coach to its normal height, push up the rocker switch. The front end will rapidly rise up. The system will release the parking brake and shift the transmission to the previously selected range.



### CAUTION

Avoid parking the coach too close to the sidewalk or to other obstacles which could damage the coach during kneeling.

#### NOTE

*Kneeling is disabled when the entrance door is open.*

#### NOTE

*The kneeling system does not operate when the coach is traveling over 5 mph (8 km/h). Consequently, the driver cannot inadvertently operate the kneeling system at higher speeds.*

### UNLOADING TAG AXLE (OPTIONAL)

To reduce the turning radius, the air springs pressure will be automatically reduced by 75% when the coach is moving at speed lower than 5 mph (8 km/h) and with more than 1½ turn from the steering.

### RETRACTABLE TAG AXLE

The standard tag axle retraction system is controlled by a valve located in the front service compartment. The valve can be switched to either the WHEELS UP or WHEELS DOWN position. The axle will be raised or lowered by air pressure according to the valve position.

The tag axle service brakes operate only when the tag axle is in the WHEELS DOWN position. Never lower the tag axle while the coach is moving. When the tag axle is in the WHEELS UP position, the corresponding status line pictogram will appear in the DID. An audible alarm will sound to warn the driver if the vehicle speed exceeds 12 mph (20 km/h) with tag axle raised. The tag axle can be raised in tight maneuvering areas like in a parking lot or to make it easier to turn a short corner. The tag axle shortens the wheelbase and allows tighter turning. Raising the tag axle transfers extra weight and additional traction to the drive wheels providing improved control on slippery roads.



### CAUTION

Do not use tag axle in raised position for an extended period. Raising tag axle increases load on the drive axle, suspension and tires.

Do not drive vehicle with tag axle raised when speed is exceeding 12 mph (20 km/h).

In order to prevent damage to the suspension, always raise the tag axle before lifting the coach.

### WHEELCHAIR LIFT SYSTEM

Read and understand the RICON Service/Owner Manual before attempting to use the wheelchair lift. The instructions below are a quick reference and serve to complement the information provided by RICON.

 <b>WARNING</b>
<p>To operate the optional wheelchair lift, the coach must be parked on a flat and level surface, with the parking brake applied and the transmission in neutral gear.</p>

Activate the lift mechanism circuit by pressing down on the wheelchair lift system power switch on the dashboard.

<p><b>NOTE</b></p> <p><i>Vehicle flashers will activate when pressing the WCL power switch.</i></p>
---

### WHEELCHAIR LIFT SYSTEM DOORS

To open the wheelchair lift system doors, the coach must be parked on a flat and level surface with the parking brake on and transmission in neutral gear.

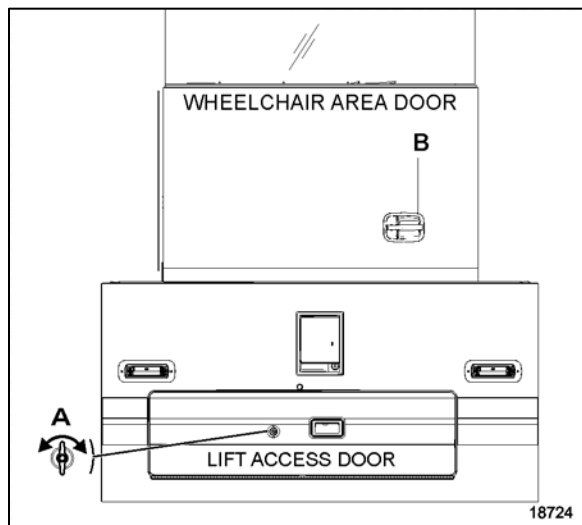

### WHEELCHAIR LIFT SYSTEM DOORS

Unlock the lift access door by rotating the T handle (A). The lift access door is located directly below the wheelchair access door. If the parking brake is not activated, a switch in the door will activate the parking brake when it detects the door is open.

The wheelchair area door is fitted with an electric lock and will unlock when the lift reaches intermediate height.

In the event of a power loss, unlocking the door is possible from inside the vehicle.

Release door lock by turning the slotted emergency unlock mechanism.

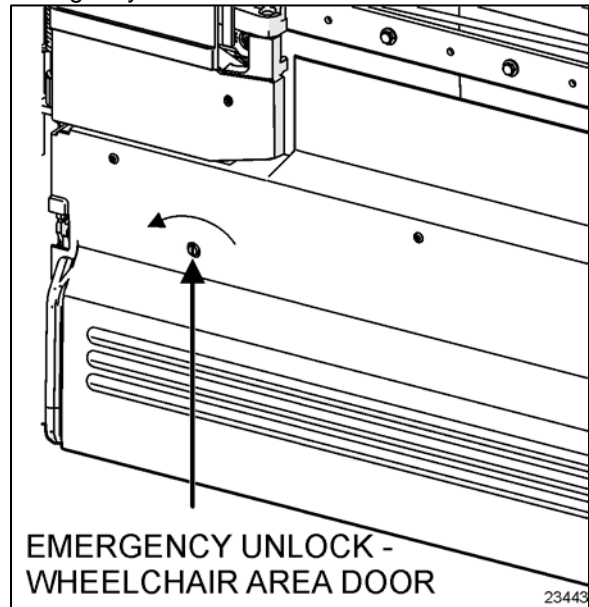

EMERGENCY UNLOCK ON WHEELCHAIR AREA DOOR

Slide the wheelchair area door completely until it locks in the open position at the end of stroke.

To close the door, pull on the handle (B) to release the locking mechanism and slide back the door in closed position.

A light inside the vehicle illuminates the doorway when the wheelchair access door is open.

A pictogram appears on the DID when the lift mechanism access door or the wheelchair access door is open. Refer to Controls and Instruments section.

When either the lift mechanism access door or the wheelchair access door is open, the parking brake cannot be released and the transmission gear selector will not register any gear selection.

<p><b>NOTE</b></p> <p><i>The activation switch must be in the ON position for this interlock feature to be in effect.</i></p>
---

## 5-30 OTHER FEATURES

If in motion and the access door opens, a telltale light will illuminate and an audible alert will sound.

### BEFORE OPERATING THE WHEELCHAIR LIFT

- Before operating lift, be certain vehicle is safely parked on a level area away from traffic. Provide at least 10 feet (3 meters) space for lift operation and passenger boarding.
- The lift operator must take special care to ensure that area is clear before deploying platform. Be certain there are no obstacles beneath platform.
- Open lift access door completely.

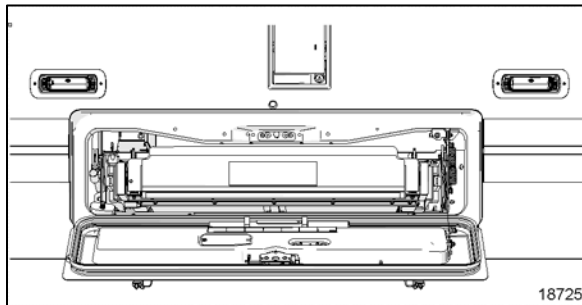

LIFT ACCESS DOOR OPEN

- The vehicle and lift are equipped with a safety interlock system (i.e. transmission into neutral, parking brake applied). Be

certain that it is in the proper mode before attempting to operate lift. The lift will not operate until this feature has been properly engaged.

- Turn on wheelchair lift power switch located on the dashboard.
- Enable lift control pendant by turning on Power switch located on pendant.
- A person that uses the wheelchair lift while standing (does not require mobility aid equipment) is referred to in this manual as a Standee.

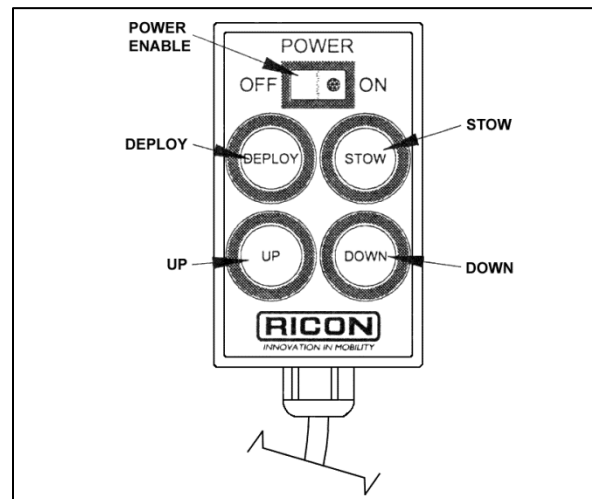

CONTROL PENDANT

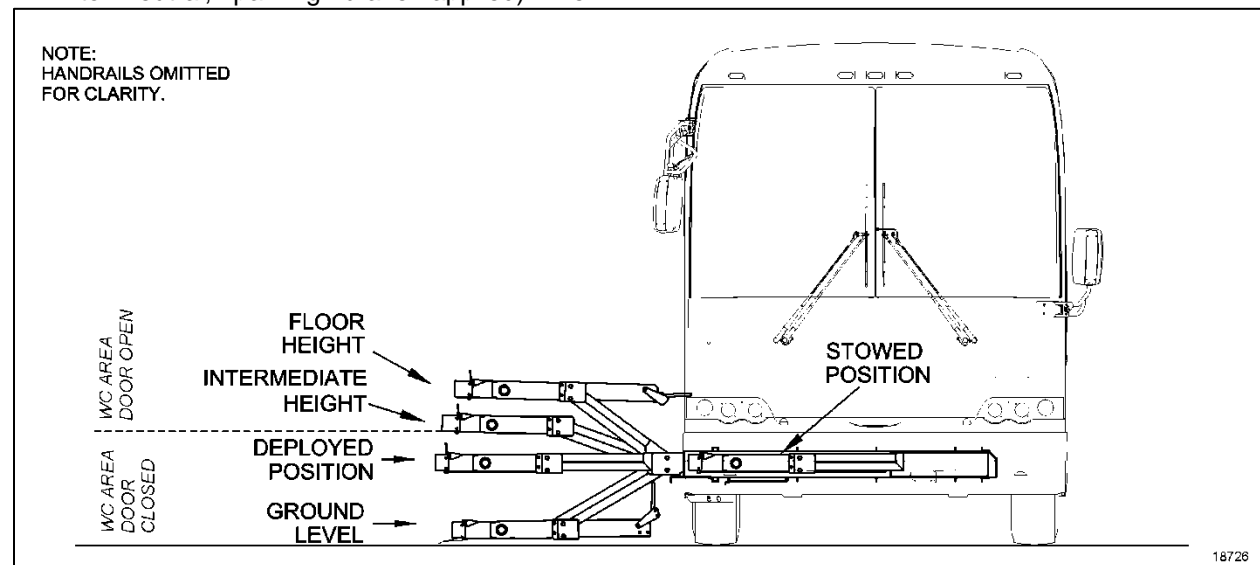

WHEELCHAIR LIFT POSITIONS

**Normal Lift Operation – To Enter Vehicle**

1. **ACTIVATE INTERLOCK:** Make sure parking brake is set and transmission is in neutral. Heed “Before operating the wheelchair lift” guide above.
2. **DEPLOY PLATFORM:** Buckle safety belt. Press and hold DEPLOY button until platform is fully deployed. NOTE: Platform cannot be moved up or down unless platform is fully extended.
3. **RAISE HANDRAILS:** Lift right handrail to vertical and push firmly down into its socket. Repeat for left handrail. Verify that both handrails are latched in place by attempting to pull upward on them.
4. **LOWER PLATFORM:** Press and hold DOWN button until platform stops at ground level and rollstop opens completely.
5. **BOARD PLATFORM:** Position wheelchair in center of platform, facing outward if possible, and advise occupant to lock wheelchair brakes. Power should be turned off on electric-powered wheelchairs. Standee must stand near the center of the platform, facing in the direction of travel (into vehicle), and firmly grasp handrails. Do not stand on bridgeplate.
6. **BUCKLE SAFETY BELT.** Pull safety belt from retractor on left handrail and fasten to other handrail.
7. **PARTIALLY RAISE PLATFORM:** Press and hold UP button until platform stops at intermediate height. The wheelchair area door should unlock automatically.
8. **OPEN WHEELCHAIR AREA DOOR:** Fully open vehicle sliding door located above lift. The lift operator, or attendant should do this.
9. **RAISE PLATFORM:** Press and hold UP button until platform stops at floor height and bridgeplate lowers onto vehicle floor.
10. **EXIT PLATFORM:** Advise passenger to carefully enter vehicle.
11. **LOWER HANDRAILS:** Press release button at base of handrail and lift the left handrail upward out of its socket. Lower handrail to platform. Repeat for right handrail. Buckle safety belt.
12. **STOW PLATFORM:** Press and hold STOW button. Close wheelchair area door at intermediate height. Press and hold STOW

button until platform reaches STOW height and then fully retracts into vehicle.

13. **CLOSE DOOR.** Close the lift access door.

NOTE: Do not use DOWN button to lower platform partway prior to stowing, and then complete the stowing process by using IN button. This method may not properly stow platform.

**Normal Lift Operation – To Exit Vehicle**

1. **ACTIVATE INTERLOCK:** Make sure parking brake is set and transmission is in neutral. Heed “Before operating the wheelchair lift” guide above.
2. **DEPLOY PLATFORM:** Press and hold DEPLOY button until platform is fully deployed.
3. **RAISE HANDRAILS:** Lift right handrail to vertical and push firmly down into its socket. Repeat for left handrail. Verify that both handrails are latched in place by attempting to pull upward on them.
4. **BUCKLE SAFETY BELT.** Pull safety belt from retractor on left handrail and fasten to other handrail.
5. **PARTIALLY RAISE PLATFORM:** Press and hold UP button until platform stops at intermediate height. The wheelchair area door should unlock automatically.
6. **OPEN VEHICLE DOOR:** Fully open vehicle sliding door located above lift. The lift operator, or attendant should do this.
7. **RAISE PLATFORM:** Press and hold UP button until platform stops at floor height and bridgeplate lowers onto vehicle floor.
8. **BOARD PLATFORM:** Position wheelchair in center of platform, facing outward if possible, and advise occupant to lock wheelchair brakes. Power should be turned off on electric-powered wheelchairs. Standee must stand near the center of the platform, facing in the direction of travel (out of vehicle), and firmly grasp handrails. Do not stand on bridgeplate.
9. **LOWER PLATFORM:** Press and hold DOWN button until platform stops at ground level and rollstop opens completely.
10. **UNBUCKLE SAFETY BELT.**
11. **EXIT PLATFORM:** Carefully assist passenger off of platform.

## 5-32 OTHER FEATURES

12. LOWER HANDRAILS: Press release button at base of handrail and lift the left handrail upward out of its socket. Lower handrail to platform. Repeat for right handrail. Buckle safety belt.
13. STOW PLATFORM: Press and hold STOW button. Close wheelchair area door at intermediate height. Press and hold STOW button until platform reaches STOW height and then fully retracts into vehicle.
14. CLOSE DOOR. Close the lift access door.



### WARNING

Inspect the lift before each use as described in the RICON Owner's manual. If any unsafe condition exists, or if unusual noises or movements are noticed, DO NOT use and contact an authorized RICON dealer for repair.



### WARNING

Read and comply with all warning labels and symbols affixed to the wheelchair lift.



### WARNING

Do not operate with a load in excess of 660 lbs (300 Kg).

### NOTE

*The restraint belt acts as a safety device and it prevents raising or lowering the lift when not buckled.*



### WARNING

Use extreme care when rolling on or off the platform and lock the wheelchair brakes while stationary on the platform. Make sure the wheelchair fits safely on the platform. Keep arms and legs away from moving parts.

### NOTE

*The indicator light on the control device illuminates when power is supplied (when the lift electrical circuit is activated by the power switch on the dashboard).*

### THRESHOLD WARNING SYSTEM (TWS) ADJUSTMENT

There are three verifications to perform; 1) Adjust Aiming of Acoustic Sensor Beam, 2) Test Aim of Acoustic Sensor Beam, and 3) Adjust Acoustic Sensor Timing.

Adjustment of the sensor timing is done at the factory and should not need to be repeated in the field. Readjustment should only be considered if the sensor aiming could not be adjusted to ignore both the wheelchair in the aisle and the platform during its normal movement.

#### Adjust Aiming of Acoustic Sensor Beam

1. Place wheelchair with passenger in center aisle of coach, pointed at doorway where Threshold Warning System (TWS) is installed. The TWS should not detect a wheelchair and passenger when they are located this far from doorway.
2. Turn power to lift on (LED on TWS module will light steady) and indicator light on the control device illuminates. If wheelchair and passenger are detected by acoustic sensors the LED will flash, the buzzer will sound and the module red light will flash. If this occurs it is necessary to adjust aiming of sensors.

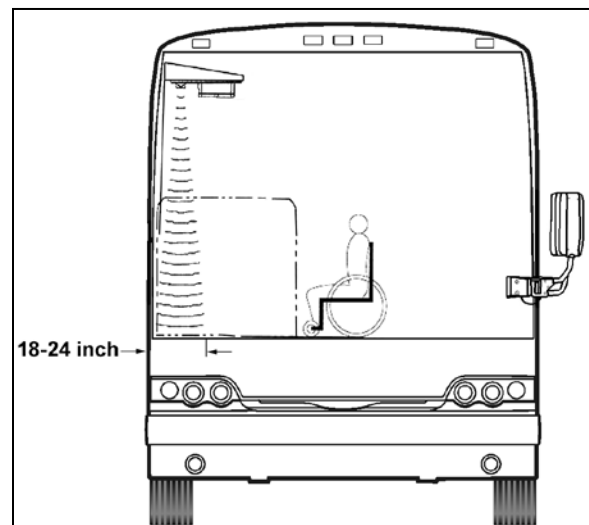

TWS AREA

23371



- Turn sensor angle adjustment screw clockwise to move direction of beam away from center aisle and towards doorway. Stop adjustment when LED ceases to flash.

**NOTE**  
Only in rare instances will adjustment be needed in the counterclockwise direction.

- Move centerline of small wheels of wheelchair (with passenger) to within 24 inches of doorway and repeat aiming procedure in previous step.

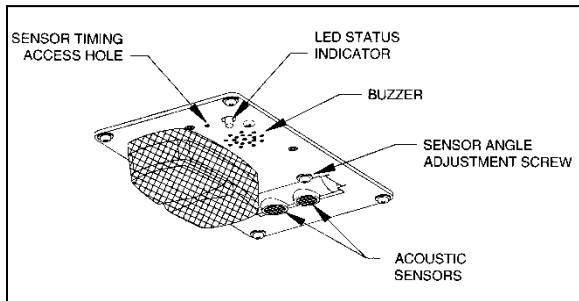

TWS MODULE DETAIL 23368

**Test Aim of Acoustic Sensor Beam**

- Move wheelchair and passenger slowly towards doorway. TWS should detect wheelchair and passenger (LED will flash, buzzer will sound and the module red light will flash) when centerline of front wheels is between 18 and 24 inches from doorway.
- Open vehicle access door above lift. Lower platform to ground and place wheelchair and passenger at rear of platform. Bridgeplate should be up. Raise platform to floor level. This normal platform motion with wheelchair and passenger aboard should not actuate TWS. If LED does flash (buzzer will also sound and module red light will flash), turn sensor adjustment screw slightly counterclockwise.

**NOTE**  
If an adjustment is made, repeat the previous step where wheelchair is between 18 and 24 inches from doorway.

**Adjust Acoustic Sensor Timing**

- Support a flat sheet of cardboard or similar material, directly beneath TWS module at a distance of 4½ feet below module. Sheet must be facing sensors.

**NOTE**  
Before proceeding, visually inspect sensors to verify that they are pointing directly at floor, or nearly, and are not pointing off at an extreme angle.

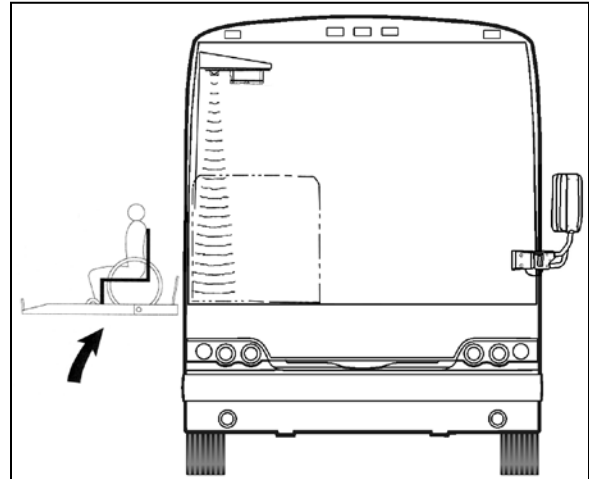

CHECKING NORMAL PLATFORM POSITION 23372

- Note the sensor timing access hole. This hole provides access to a plunger-actuated switch that sets the sensor timing. Insert a 1/16-inch diameter wire-like object into the access hole and press the plunger inward. The LED will flash momentarily while the module establishes the distance and then remain on steady. Release the plunger when the LED ceases to flash.

**NOTE**  
It is important that objects, such as your body, tools, seats, etc., do not interfere with the beam while the adjustment is being made.

**INTERIOR APPOINTMENTS**

To accommodate a wheelchair, one row of seats must be folded and two rows must be folded and slid away. Seats may be folded on both sides of the coach to make room for a second wheelchair.

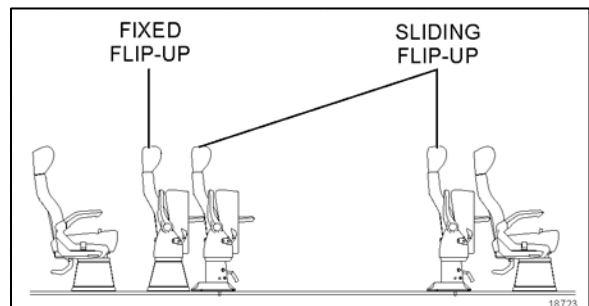

SEATING ARRANGEMENT 18723

## 5-34 OTHER FEATURES

Electrical wheelchair or tri-wheeler may require moving the sliding seats on both sides of the coach to allow enough turnaround space.

Wheelchair occupants have access to a stop request tape switch and a reading light switch on the window sill of the wheelchair area door.

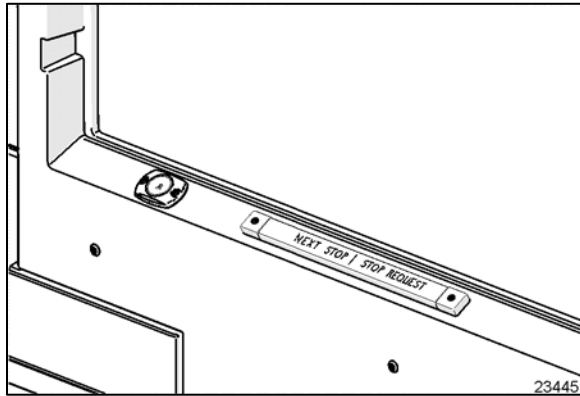

READING LIGHT AND STOP REQUEST SWITCHES

### NOTE

Refer to "Coach Interior" section for additional information.

### Wheelchair Restraint System

This 4-point anchoring system includes four retractors with restraint hook belts (red) located at the base of passengers seats. They must be placed at all four corners to secure the wheelchair frame. Separate blue "scooter belts" are provided to accommodate various wheelchair styles.

Refer to the information labels and placards on the actual seats for detailed proper securement instructions.

Instructions labels and placards on the actual seats take precedence over any instructions in this manual.

### Wheelchair Occupant Restraint

The occupant restraint belt includes a black lap belt and a black shoulder belt with a tongue that attaches on the lap belt stud.

Refer to the information on the actual seats for detailed proper securement instructions.

Instructions labels and placards on the actual seats take precedence over any instructions in this manual.



### CAUTION

Lap belt buckle including belt release button must always be located on aisle side.



### WARNING

A snug fit with the lap belt positioned low on the hips is necessary to maximize safety. The belt should not be worn or twisted. Avoid pinching the belt and/or hardware. Do not wear over rigid or breakable objects such as eyeglasses, pens or keys as these may cause injuries.



### WARNING

Do not let restraint or safety belts rub against sharp edges. Do not bleach or dry clean.

### EMERGENCY OPERATION

In the event of electrical power loss, manual operation of the lift is possible as explained below. It is recommended that manual operation be used only to exit from vehicle, not to enter vehicle.

#### Wheelchair area sliding door emergency unlock

In the event of a power loss, the wheelchair area door can be unlocked from the inside of the vehicle.

Unlock by turning the slotted knob with a quarter or a similar flat object.

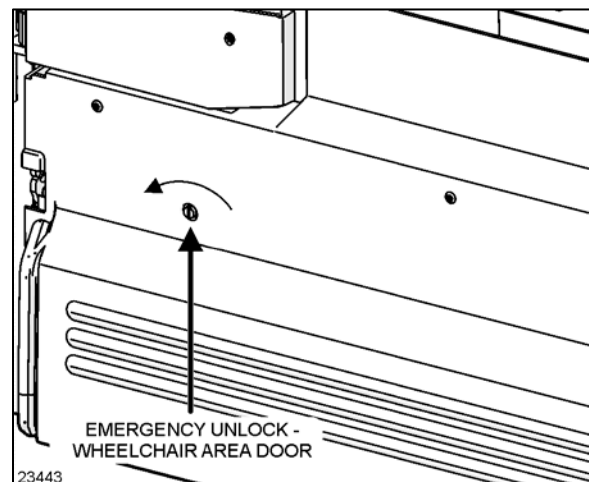

EMERGENCY UNLOCK ON WHEELCHAIR AREA DOOR

**To manually deploy the platform**

Allow enough space for lift operation and passenger boarding. If a break down situation exists and the vehicle cannot be moved so that the lift system can be operated safely, the operator must summon emergency assistance to move the vehicle before operating the lift.

1. Fully open wheelchair access and lift doors. Ensure that there are no obstacles in the path of the lift.

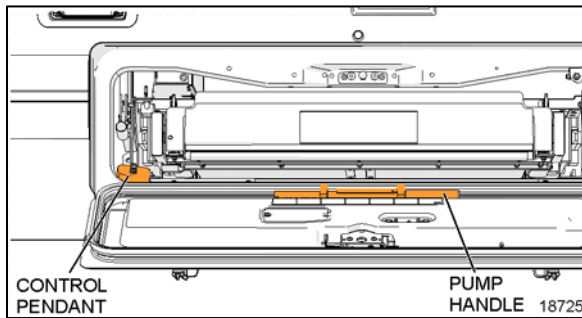

**WHEELCHAIR LIFT MANUAL OPERATION**

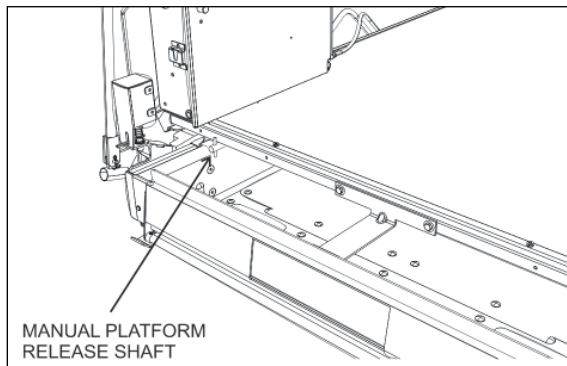

**MANUAL PLATFORM RELEASE SHAFT**

23334

2. Remove the pump handle from inside the lift mechanism access door.

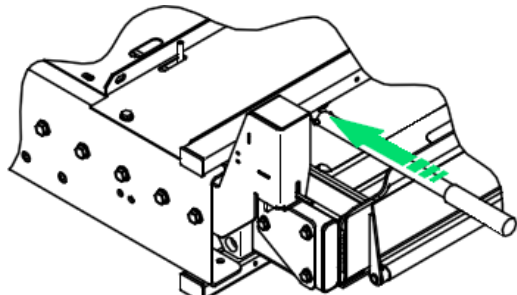

3. Turn the manual platform release shafts using pump handle extension to disengage the platform and then lift the stowlock mechanical catch.

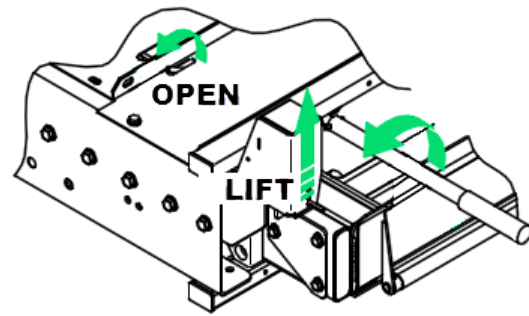

4. Grasp the platform and pull firmly until the lift is all the way out against the carriage stops.

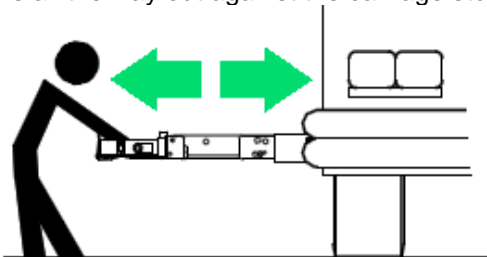

5. Turn the manual platform release shafts using pump handle extension back to previous position to lock the platform.

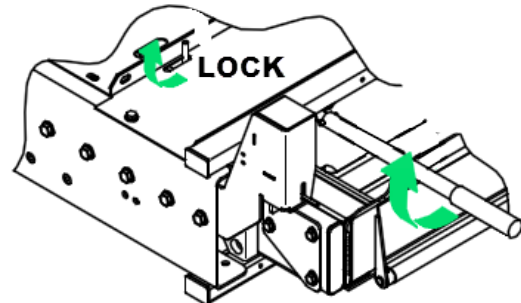

6. Lift right handrail to vertical and push firmly down into its socket. Repeat for left Handrail.

**To manually raise the platform**

1. Remove the pump handle from inside the lift mechanism access door.
2. Close the pump release valve by pushing the actuating rod DOWN (pumping the handle raises the platform when the release valve is closed).

## 5-36 OTHER FEATURES

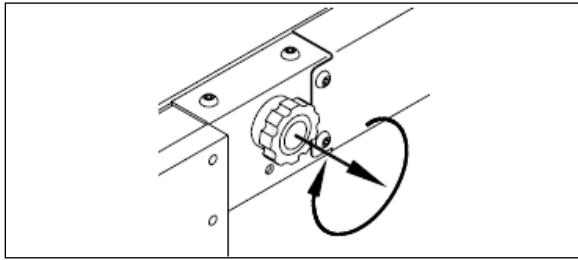

**CLOCKWISE ROTATION CLOSSES ROLLSTOP** 23275

3. Verify that rollstop is up (closed). Pull rollstop control knob out and rotate fully clockwise, if it isn't up.
4. Insert handle extension into manual backup pump handle socket and pump to raise the platform to the vehicle floor level.



### CAUTION

During manual rising of the lift, do not raise the platform more than 1-1/2 inches above the vehicle floor level. Any excessive travel will make it difficult to enter the platform and/or damage the lift bridge plate actuator. The outer edge of the bridge plate must rest squarely on the vehicle floor.

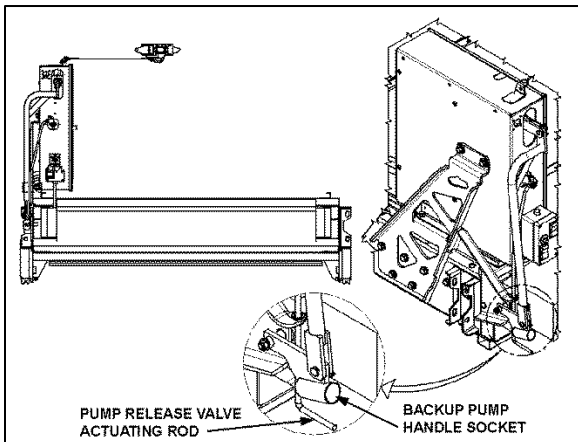

**WHEELCHAIR LIFT MANUAL HYDRAULIC PUMP** 23373

5. The lift passenger and attendant must follow the instructions to ENTER or EXIT the vehicle, as previously described.

### To manually lower the platform

1. Verify that rollstop is up (closed). Pull rollstop control knob out and rotate clockwise, if it isn't up.
2. Slowly pull the pump release valve actuating rod UP until the platform begins to lower (opening the release valve lowers platform).

3. Allow the platform to reach ground level.
4. Push the pump release valve actuating rod back DOWN until lightly-snug.
5. Using the rollstop manual control knob, OPEN the rollstop. Pull rollstop control knob out and rotate fully counterclockwise. Rollstop must lie flat on ground.

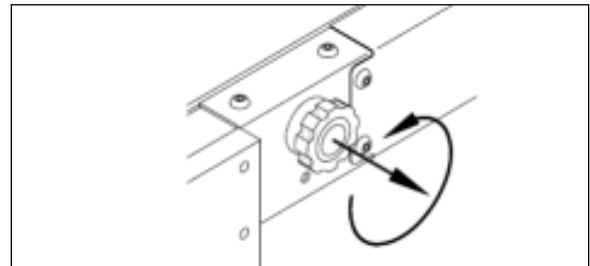

**COUNTERCLOCKWISE ROTATION OPENS ROLLSTOP**

6. The attendant and lift passenger should follow the instructions to ENTER or EXIT the vehicle, as described previously.

### To manually stow the platform

1. Detach the restraint belt, lift each handrail up to unlock and fold handrails. Re-fasten restraint belt.
2. Raise or lower the platform to the deploy/stow position; the platform frame must be parallel to the side of the lift enclosure. If the exact position cannot be obtained, slightly low is preferred to slightly high.
3. Using the rollstop manual control knob and one hand on the rollstop, close the rollstop until it latches.
4. Turn the manual platform release shafts using pump handle extension to disengage the platform.
5. Use one person on each side of the lift to prevent mechanical binding.
6. With fingers up and palms forward, push the platform forcefully to start the lift moving inward. As the lift begins to move inward, maintain a constant pushing motion until the lift comes to rest completely inside the lift enclosure.
7. Push firmly and make sure that the platform manual release shafts have turned to lock the platform.

## FRONT BUMPER BIKE RACK OPERATION

### *NOTE*

*Instruction labels affixed on the bike rack take precedence over this procedure.*

The Sportworks Bike-Rack-for-Buses has been designed to make as low an impact as possible on transit operations. All loading and unloading of bicycles can be done by the bicycle rider. Sportworks suggests that loading of children's bicycles be done by an accompanying adult, but the rack can be easily loaded by young children.

These are the steps that should be followed when using the rack.

### LOADING BIKES

1. Prepare your bike for loading. Remove water bottles, pumps and other loose items that could fall off while the bus is in motion.
2. Inform the bus driver that you will be loading your bike. You must load your bike from the curb or in front of the bus. Do not step into oncoming traffic to load your bike.
3. Squeeze handle up to release latch, then fold down the bike rack. You only need to use one hand to unlatch and pull the bike rack down, so you can hold your bike with your other hand. It is not necessary to lean your bike against the bus.
4. Lift your bike onto the bike rack, fitting wheels into proper wheel slots. Each wheel slot is clearly labeled for the front wheel. The purpose of the directional placement is to make the bike nearest the bus easier to unload.
5. Raise the Support Arm over the front tire. The Support Arm's number one purpose is to add lateral support for the bicycle when the bus is in motion or at rest. Many bikes will sit in the wheel well without the use of the Support Arm, but the rack must not be used without the Support Arm. Bikes with especially thin rims and tires will sway back and forth without its use.

The handle should be placed as close to the front brake and head tube as possible to ensure safety and security of the bike, and in all cases the handle must be closer to the head tube than the highest point of the tire.

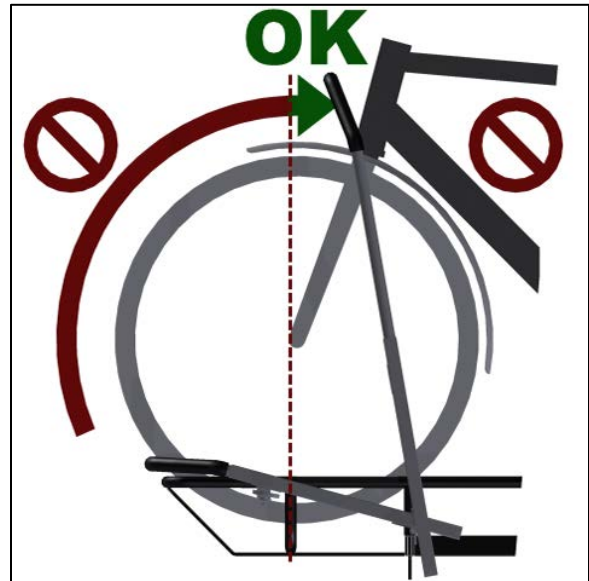

**SUPPORT ARM CORRECT POSITION**  
**IMAGE: SPORTWORKS**

6. Board the bus and enjoy the ride! Choose a seat near the front of the bus to keep an eye on your bike. **DON'T FORGET** you have a bike with you when you get off at your stop. New riders often do!

### UNLOADING BIKES

1. Inform the bus driver that you will be unloading your bike as you approach your stop. Use the front door to exit the bus. Unload your bike from in front of the bus or from the curb, not from the street.
2. Raise the Support Arm off the tire. The Support Arm automatically folds down to a secure position.
3. Lift your bike out of the bike rack.
4. Fold up the Bike-Rack-for Buses if there are no bikes on the rack and no one else is waiting to load their bike. The bike rack locks in place.
5. Step away from the bus with your bike.

