



# SafeGuard PREMIER™

General Use Instructions 

Add-on Child Seat Instructions 

Wheelchair Instructions 

Care and Maintenance 

General Warnings 

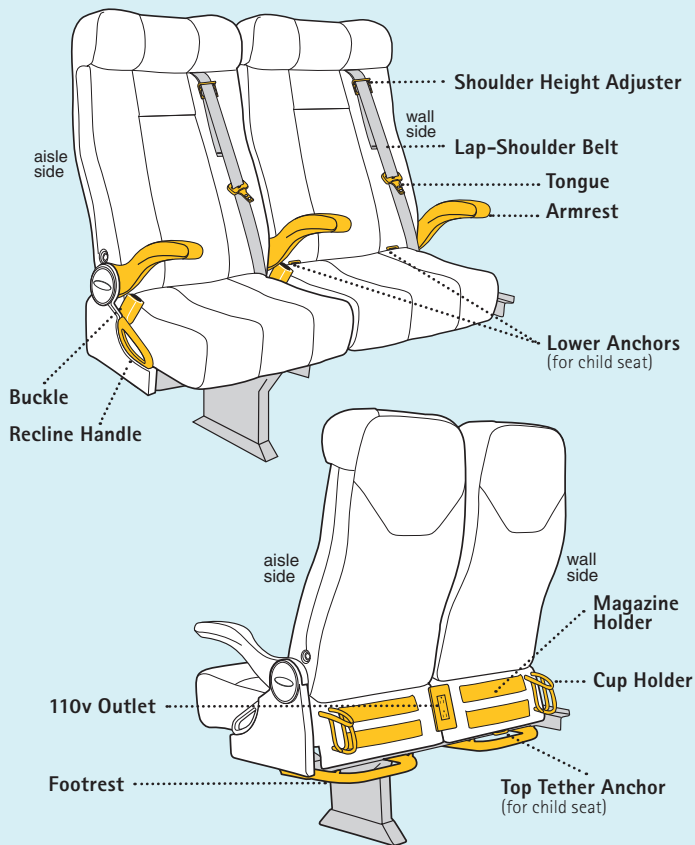

# General Use Instructions

This passenger restraint system conforms to all applicable Federal Motor Vehicle Safety Standards.

## **IMPORTANT NOTICE TO DRIVERS:** **NEVER** assist passengers in fastening their seat belts.

These instructions are intended for motorcoach driver's reference only. Passengers are responsible for proper restraint system use (wheelchair passengers excepted).

### **⚠ WARNINGS**

**DEATH or SERIOUS INJURY** can occur: Follow all instructions on the bus seat and in this manual. Failure to follow the manufacturer's warnings for proper use of this restraint system can result in serious injury or death.

- Use only with passengers at least 4 years old who weigh 40 pounds (18 kg) or more and whose height is 40 inches (102 cm) or more.
- See page 14 for additional warnings.

### Proper buckling of seat belt:

- 1.** Vertically insert the latch into the buckle. Listen for a **CLICK**. **A**
- 2.** **TUG** on the seat belt latch to make sure the belt is securely fastened. **B**
- 3.** **SNUG** the seat belt across the hips, on top of the thighs.
- 4.** Move shoulder height adjuster to place shoulder belt in a comfortable position. **C**

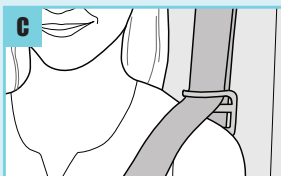
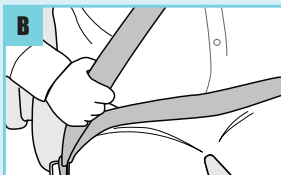
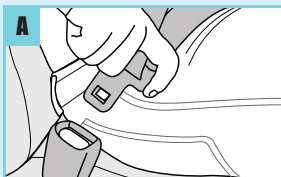

[www.clicktugsnug.com](http://www.clicktugsnug.com)

# Add-On Child Seat Instructions



## IMPORTANT NOTICE TO DRIVERS:

**NEVER** assist passengers in installing child seats.

These instructions are intended for motorcoach driver's reference only. Adult passengers are responsible for proper add-on child seat installation and child passenger securement.

### ⚠ WARNINGS

Follow these instructions as well as all instructions from the manufacturer's child seat manual.

- A locking clip **MUST** be used when installing an add-on child seat using the lap-shoulder seat belt.
- Failure to follow the manufacturer's warnings for proper use of the child seat system could result in serious injury or death.
- See page 14 for additional warnings.

Add-on child seats must be installed in accordance with the instructions provided by the child seat manufacturer. SafeGuard Premier seats are equipped with LATCH and lap-shoulder belt restraints. LATCH lower anchors **A** and top tether anchor **B** locations are shown.

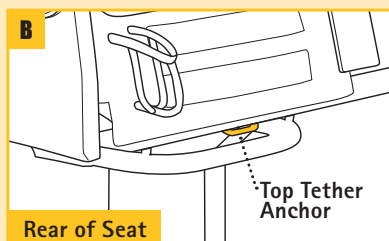
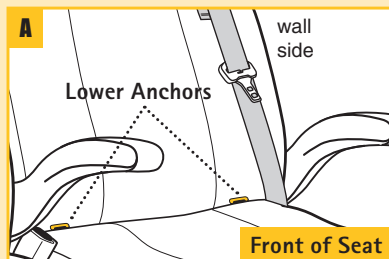



# Wheelchair Instructions

## **⚠ WARNINGS**

Follow these instructions as well as all instructions from the wheelchair manufacturer. Use anchorage locations designated by the wheelchair manufacturer. Failure to follow such instructions could result in serious injury or death.

- The pedestal handle keeper-pins must be installed with the handles in the secured position as shown in Figure B on pages 7 and 9 when the vehicle is moving.
- Do not alter any of the SafeGuard components.
- Wheelchair tiedown and passenger restraint system must be replaced if they are suspected of having been in use during an impact which caused the vehicle to be towed.
- Postural supports must not be used as passenger safety restraints.
- Auxiliary wheelchair equipment and other items attached to the wheelchair must be effectively secured to the wheelchair or removed and secured during transport. Unsecured items may cause injury or death to passengers in the event of an impact.
- Straps must be protected from contact with sharp corners and sharp edges.
- See page 14 for additional warnings.

# Wheelchair Instructions continued

## 1. Positioning motorcoach seats. **A-Left**, **A-Right** and **B**

### Left Hand Side of Bus

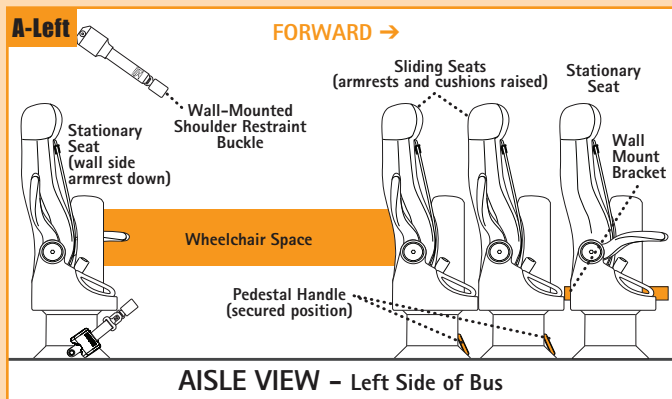

### Left 1A Move Front Sliding Seat to Forward Position

- Raise all three armrests.
- Under each seat cushion, find the spring latch, release the cushion and then raise it.
- Remove the two keeper-pins securing the pedestal handles. Lift both pedestal handles and then reinstall the wall side pedestal keeper-pin.
- Remove both floor channel covers forward of the seat and store.
- Slide the seat forward until it stops against the wall mount bracket on the front stationary seat.
- Fully depress the aisle side pedestal handle to secure the seat and reinstall the keeper-pin.

# Wheelchair Instructions continued

## Left 1B Move Rear Sliding Seat to Forward Position

- Raise all three armrests.
- Under each seat cushion, find the spring latch, release the cushion and then raise it.
- Remove the two keeper-pins securing the pedestal handles. Lift both pedestal handles and then reinstall the wall side pedestal keeper-pin.
- Remove both floor channel covers forward of the seat and store.
- Slide the seat forward until it stops against the front sliding seat.
- Fully depress the aisle side pedestal handle to secure the seat and reinstall the keeper-pin.

## Left 1C Rear Stationary Seat

- Raise the center and the aisle side armrests.
- Raise both seat cushions.

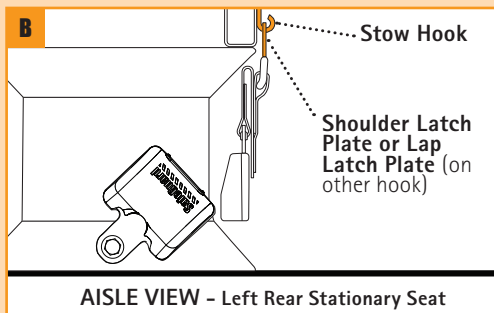

# Wheelchair Instructions continued

## 1. Positioning motorcoach seats. **A-Right** and **B**

### Right Hand Side of Bus

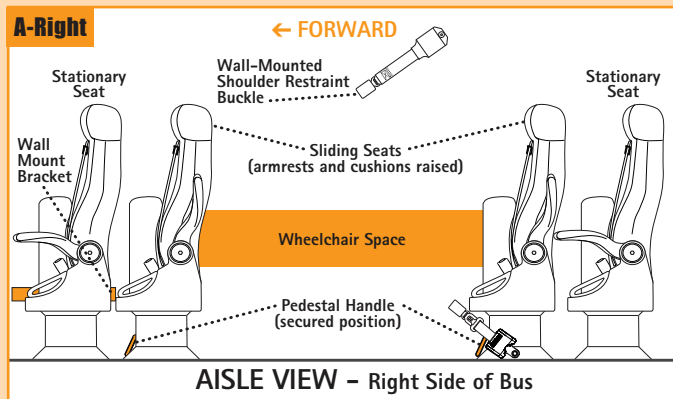

### **Right 1A** Move Front Sliding Seat to Forward Position

- Raise all three armrests.
- Under each seat cushion, find the spring latch, release the cushion and then raise it.
- Remove the two keeper-pins securing the pedestal handles. Lift both pedestal handles and then reinstall the wall side pedestal keeper-pin.
- Remove both floor channel covers forward of the seat and store.
- Slide the seat forward until it stops against the wall mount bracket on the front stationary seat.
- Fully depress the aisle side pedestal handle to secure the seat and reinstall the keeper-pin.



# Wheelchair Instructions continued

## **Right 1B** Rear Stationary Seat

- Raise both seat cushions.
- Lower all three armrests.

## **Right 1C** Move Rear Sliding Seat to Rearward Position

- Raise the seat cushions and armrests.
- Remove the two keeper-pins securing the pedestal handles. Lift both pedestal handles.
- Remove both floor channel covers behind the seat and store.
- Slide the seat rearward until it stops against the armrests of the rear stationary seat.
- Fully depress both pedestal handles to secure the seat and reinstall the keeper-pins.

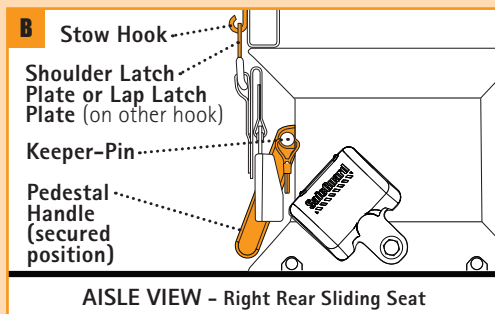

# Wheelchair Instructions continued

## 2. Secure the wheelchair. **C** and **D**

- Position the wheelchair facing forward, centered between the tiedown retractors and centered between the seats.
- Attach each front and rear tiedown to a designated attachment point. If an attachment point is not designated, attach tiedowns as high as possible, but below the wheelchair seat to a sturdy area of the wheelchair frame.
- Test the security of the tiedowns. Roll the wheelchair forward and backward until the tiedowns allow no more than two inches of movement.

**C**

Wheelchair Shown on Left Side of Bus

FORWARD →

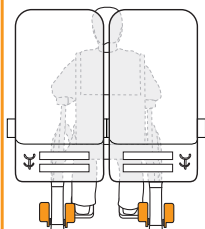

**REAR VIEW**

Wheelchair Centered  
Between Retractors

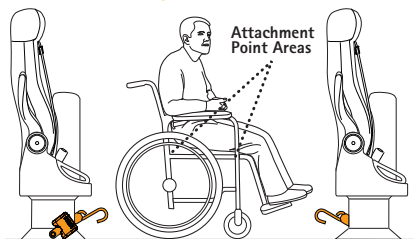

**AISLE VIEW**

Wheelchair Centered  
Between Sliding Seats

\*Do NOT attach a tiedown to a wheel or a footrest.

\*To release a tiedown, depress the tiedown release lever while unhooking from the chair. **D**

\*Guide straps into retractors. The tiedown straps must be fully withdrawn into the retractors.

**NOTE: Tiedown straps may be twisted up to 90 degrees.**



# Wheelchair Instructions continued

## 3. Secure the passenger.

- Remove the passenger restraint latch plates from the storage hooks and latch the passenger's lap restraint belt near his/her aisle-side hip. Typically, the strap will be placed under the wheelchair armrests. **E**
- If the latch plate from the wall side passenger restraint will not reach the aisle side hip, release the front tiedowns, reposition the wheelchair rearward, reattach the front tiedowns, and latch the passenger's lap restraint belt near the passenger's aisle-side hip.

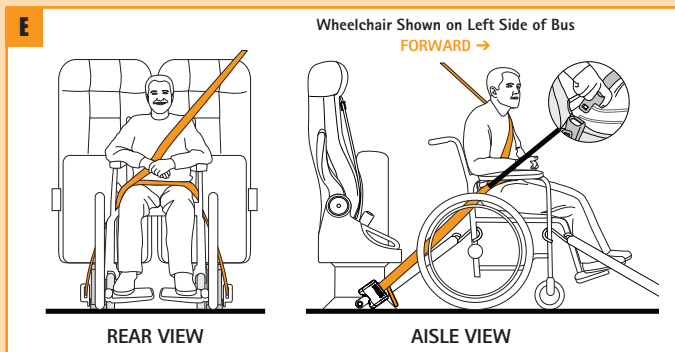

- The strap must NOT be held away from the body by the wheelchair. **F**
- The lap restraint belt must be positioned low across the front of the pelvis so that it presses against the bony structure of the body.
- Slowly, pull the wall-mounted shoulder restraint belt over the passenger's shoulder and across the passenger's chest to the aisle-side hip and latch the shoulder restraint buckle. **E**

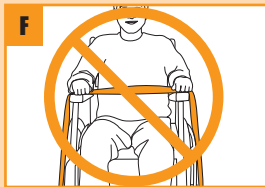

**NOTE:** Passenger restraint straps must NOT be twisted.



## 4. Latch plate stowage.

- Guide straps into retractors. The tiedown straps must be fully withdrawn into the retractors. The restraint straps must be withdrawn sufficiently so no strap contacts the floor when the latch plates are on the stow hooks.
- Stow each latch plate on the nearest hook after use.
- See Figure **B** on pages 7 and 9.

## 5. Resetting sliding seats.

- Reverse procedures on pages 6 and 7 for left hand side bus seats and procedures on pages 8 and 9 right hand side bus seats.
- Sliding seat occupied locations are set by first reinstalling floor channel covers and then sliding seat against the ends of the channel covers.
- Verify that all pedestal handles are fully depressed, all keeper pins are installed, and all latch plates are stowed.

## Wheelchair Restraint Maintenance

- When not in use, the passenger restraint latch plates must be stored on the hooks as shown in Figure B on pages 7 and 9.
- Care must be taken to prevent contamination of the straps. Avoid use of or contact with cleaners, polishes, oils, and chemicals - particularly battery acid. Damaged, cut, tattered, threadbare, frayed or contaminated straps and broken or malfunctioning parts must be replaced.
- Wheelchair tiedown and passenger restraint system must be inspected, cleaned and maintained regularly.
- Clean straps by hand washing with warm water and mild soap. Rinse thoroughly and allow to air dry.
- Clean buckles with warm water only. Use no soaps or lubricants.

*Wheelchair tiedown and passenger restraint system comply with applicable Canadian CSA / MVSR and USA ADA / FMVSS regulation.*

# Care and Maintenance

## **⚠ WARNINGS**

Follow these instructions. Failure to follow instructions below could result in damage to the products, and could result in serious injury or death.

- See page 14 for additional warnings.

## Cleaning

- Clean seat cushions and webbing with a damp sponge using mild soap solution and lukewarm water. Never use bleach or harsh cleansers.
- Clean buckles with warm water only. Use no soaps or lubricants.
- Never lubricate the seat belt buckle or webbing retractor.

## Seat Belt Inspection

- Inspect all lap-shoulder belts on the SafeGuard Premier seat to ensure that webbing or latch plates on the webbing face forward, are not twisted, and can slide freely along the webbing. Correct any lap-shoulder belt or latch plate where necessary.
- Pull out lap-shoulder belt and insert latch plate into buckle, listening for engagement "Click". Push release button on buckle. Latch plate should eject, and lap-shoulder belt should retract completely.
- Lap-shoulder belts should be regularly inspected for damage including cuts, fraying, extreme or unusual wear, significant discoloration due to ultraviolet exposure, extremely dusty or dirty conditions, abrasion to the seat belt webbing, damage to the buckle, latch plate, retractor, hardware or any other obvious problem.
- If any of these conditions develop or exist on the SafeGuard Premier seat belt system, it will require replacement of the seat belt(s) immediately regardless of the age of the seat.

## Seat Belt Reverse Lock-Up

If during the seat installation process the lap-shoulder belt becomes locked up and cannot be pulled out, perform the following steps.

1. Move the shoulder height adjuster down.
2. Grasp the top strap of the shoulder belt webbing between the shoulder height adjuster and the belt where it exits from the top of the seat.
3. Hold and pull the top strap tightly with a constant, even force.
4. Release the top strap. The seat belt will unlock and is now ready to use.

## Care and Maintenance

SafeGuard Premier seat with lap-shoulder belts

# General Warnings

## **⚠ WARNINGS**

Follow all instructions and warnings herein. Failure to follow these warnings can result in serious injury or death. Please read and follow all instructions carefully.

- Do not use this restraint until you read and understand the instructions in this manual.
- Follow all instructions on the bus seat and in this manual.
- Do not modify this restraint or use any accessories or parts supplied by other manufacturers. Use only SafeGuard replacement parts.
- Never use the restraint system if it is damaged or is missing parts. Do not use a cut, frayed, or damaged harness or seat belt.

**SafeGuard**   
**P R E M I E R™**