



Service Data

SD-13-4986

The Bendix® ESP® EC-80™ Controller

INTRODUCTION

The Bendix® ESP® EC-80™ Electronic Control Unit (ECU) is a member of a family of three Bendix®-brand electronic Antilock Braking System (ABS) devices used to help improve the braking characteristics of air-braked heavy- and medium-duty trucks, tractors, and buses:

1. The Bendix® ABS ESP® ECU uses wheel speed sensors to monitor four wheel-ends to detect wheel-slip or wheel lock-up during braking. The system intervenes when needed – using Pressure Modulator Valves (PMVs) to adjust and/or pulse the brake pressure – in order to optimize the contact between the tires and the road surface.
2. The Bendix® Automatic Traction Control (ATC) EC-80™ ECU provides standard ABS; improves vehicle traction during acceleration; and aid lateral stability while driving through curves. The Bendix® ATC ECU communicates with the engine's Controller to provide Engine Torque Limiting (ETL), and/or use Differential Braking (DB) to make brake applications at individual wheels.
3. The Bendix ESP EC-80 Controller provides – in addition to the ABS and ATC functions described above – advanced braking features referred to as the Bendix® ESP® Electronic Stability Program. The Bendix ESP EC-80 Controller analyzes the vehicle's motion compared to the driver's intended path and provides Yaw Control (YC) and Roll Stability Program (RSP) capabilities. When necessary, the system will intervene to reduce the engine throttle, and/or apply the brakes at one or more of the wheel ends – to help the vehicle return to the intended direction.



FIGURE 1 - THE BENDIX® ESP® EC-80™ CONTROLLER

⚠ WARNING

The driver is always responsible for the control and safe operation of the vehicle at all times. The Bendix® ABS system does not replace the need for a skilled, alert professional driver, reacting appropriately and in a timely manner, and using safe driving practices.

TABLE OF CONTENTS	Page
Components	3-4
Indicator Lamps and Power-Up Sequence	8-9
ABS Operation.	9-10
ATC Operation.	11-12
ESP ABS With Stability Control.	12-13
Important Safety Information About The ESP Stability System	13-14
Troubleshooting	17-62

See page 63 for the full Table of Contents

Bendix® EC-80™ System Name	Previous (Bendix® EC-60™ ECU) Designations	Key Components	Key System Features (ECU Designation Shown on the ECU Label)	ECU Connector Locations Provided	See Service Data Sheet
ABS	“Standard”	ECU; Pressure Modulator Valves (PMVs); Four Wheel Speed Sensors.	ABS [Antilock Braking] (EC-80 ABS)	Two	SD-13-4983
ATC	“Premium”	<i>Items above, plus:</i> Automatic Traction Control (ATC) Valve; Option of two more Wheel Speed Sensors and PMVs.	ABS plus ATC [Traction Control] (EC-80 ATC)	Three	SD-13-4983
ESP®	“Advanced”	<i>All items above, plus:</i> Yaw Rate Sensor; Steering Angle Sensor; Load Sensor; Steer-axle ATC valve; Brake Demand Sensor; and an Additional PMV	ABS plus ATC plus ESP [Yaw Control (YC) and Roll Stability Program (RSP®)]. (EC-80 ESP)	Four	SD-13-4986 (This Document)

ESP® is a registered trademark of DaimlerChrysler and is used by BCVS under license.

GENERAL SAFETY GUIDELINES



WARNING! PLEASE READ AND FOLLOW THESE INSTRUCTIONS



TO AVOID PERSONAL INJURY OR DEATH:

When working on or around a vehicle, the following guidelines should be observed **AT ALL TIMES**:

- ▲ Park the vehicle on a level surface, apply the parking brakes and always block the wheels. Always wear personal protection equipment.
- ▲ Stop the engine and remove the ignition key when working under or around the vehicle. When working in the engine compartment, the engine should be shut off and the ignition key should be removed. Where circumstances require that the engine be in operation, **EXTREME CAUTION** should be used to prevent personal injury resulting from contact with moving, rotating, leaking, heated or electrically-charged components.
- ▲ Do not attempt to install, remove, disassemble or assemble a component until you have read, and thoroughly understand, the recommended procedures. Use only the proper tools and observe all precautions pertaining to use of those tools.
- ▲ If the work is being performed on the vehicle's air brake system, or any auxiliary pressurized air systems, make certain to drain the air pressure from all reservoirs before beginning ANY work on the vehicle. If the vehicle is equipped with a Bendix® AD-IS® air dryer system, a Bendix® DRM™ dryer reservoir module, or a Bendix® AD-9si® air dryer, be sure to drain the purge reservoir.
- ▲ Following the vehicle manufacturer's recommended procedures, deactivate the electrical system in a manner that safely removes all electrical power from the vehicle.
- ▲ Never exceed manufacturer's recommended pressures.
- ▲ You should consult the vehicle manufacturer's operating and service manuals, and any related literature, in conjunction with the Guidelines above.
- ▲ Never connect or disconnect a hose or line containing pressure; it may whip and/or cause hazardous airborne dust and dirt particles. Wear eye protection. Slowly open connections with care, and verify that no pressure is present. Never remove a component or plug unless you are certain all system pressure has been depleted.
- ▲ Use only genuine Bendix® brand replacement parts, components and kits. Replacement hardware, tubing, hose, fittings, wiring, etc. must be of equivalent size, type and strength as original equipment and be designed specifically for such applications and systems.
- ▲ Components with stripped threads or damaged parts should be replaced rather than repaired. Do not attempt repairs requiring machining or welding unless specifically stated and approved by the vehicle and component manufacturer.
- ▲ Prior to returning the vehicle to service, make certain all components and systems are restored to their proper operating condition.
- ▲ For vehicles with Automatic Traction Control (ATC), the ATC function must be disabled (ATC indicator lamp should be ON) prior to performing any vehicle maintenance where one or more wheels on a drive axle are lifted off the ground and moving.
- ▲ The power **MUST** be temporarily disconnected from the radar sensor whenever any tests **USING A DYNAMOMETER** are conducted on a vehicle equipped with a Bendix® Wingman® system.



CAUTION

Even with the Bendix® ESP® system with the EC-80™ Controller, the driver remains responsible for ensuring vehicle stability during operation. The braking system can only function within the limits of physics. The system helps mitigate potential vehicle stability incidents, but cannot prevent them in all cases. Other factors such as driving too fast for road, traffic or weather conditions, oversteering, an excessively high vehicle Center of Gravity (CG), or poor road conditions can cause vehicle instability that is beyond the capability of any stability system to mitigate. In addition, the effectiveness of Bendix ESP system with the EC-80 Controller can be greatly reduced on vehicles towing multiple trailer combinations.



CAUTION

The Bendix ESP system with the EC-80 Controller (see page 12) may only be used on vehicles tested and approved by Bendix engineering. The tests produce a validated parameter data set for use by the vehicle's Bendix ESP EC-80 Electronic Control Unit (ECU). When replacing an ECU, only specific Controllers – with the correct parameter set – may be used. See “*Obtaining a New Bendix ESP EC-80 Controller*” on page 17 for further details.

Bendix ESP system with the EC-80 Controller-equipped vehicles should not be driven on high-banked roads – such as those found on high-speed test or race tracks. Test personnel must have the Bendix ESP system's stability features disabled prior to operating a vehicle on such tracks.

For vehicles with the (optional) Hill Start Aid (HSA) system (sometimes referred to as a “Hill Start Assist”, or simply “Hill Start”), this feature interfaces between the transmission and the braking system. HSA helps the driver prevent the vehicle from rolling downhill when moving up a steep incline from a stationary position. See page 6 for more information.

YAW CONTROL (YC)

A Bendix® EC-80™ ESP® Controller includes Yaw Control (YC) functionality. Yaw Control has the ability to apply brakes to individual wheel ends, as well as applying the trailer brakes, to counteract trailer “push” that – during certain maneuvers – could lead to a loss-of-control or a jackknife incident. See “Yaw Stability” on page 13 for further details.

ROLL STABILITY PROGRAM (RSP)

The Bendix® Roll Stability Program (RSP), is an all-axle ABS solution that helps decrease vehicle speed by reducing the engine's throttle and applying all vehicle brakes as needed, mitigating the vehicle's tendency to roll over. RSP focuses on reducing the vehicle's speed below the critical roll threshold during direction-changing maneuvers – such as driving on curved highway exit ramps or obstacle avoidance maneuvers on dry, high friction surfaces. See “ESP ABS with Stability Control” on page 12 for further details.

WARNING

During an RSP system intervention, the vehicle automatically decelerates. RSP can slow the vehicle with or without the operator applying the brake pedal, and even when the operator is applying the throttle.

COMPONENTS

The Bendix ESP EC-80 Controller's ABS function utilizes the following components:

- Bendix® WS-24™ Wheel Speed Sensors (four or six, depending on the configuration), each with a clamping sleeve. [Refer to SD-13-4860]
- Bendix® M-40QR™ or M-40-HF™ Pressure Modulator Valves (four, five, or six may be present) [refer to SD-13-4958]. For legacy systems where a Bendix® M-32™ or M-32QR™ Pressure Modulator Valve is used, refer to SD-13-4870.
- A dash-mounted tractor ABS Indicator Lamp
- A service brake Relay Valve
- A dash-mounted trailer ABS Indicator Lamp
- An optional blink code Activation Switch
- An optional ABS Off-road Switch

The Bendix ESP EC-80 Controller's ESP/RSP function utilizes the following additional components:

- A Steer Axle Traction Control Valve (may be integral to the service brake Relay Valve or a stand-alone device)

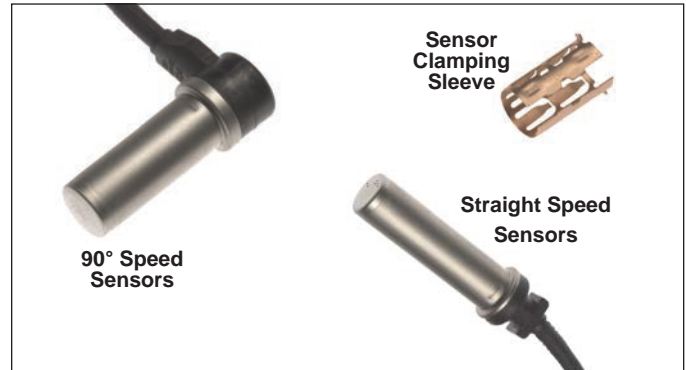

FIGURE 2 - BENDIX® WS-24™ WHEEL SPEED SENSORS

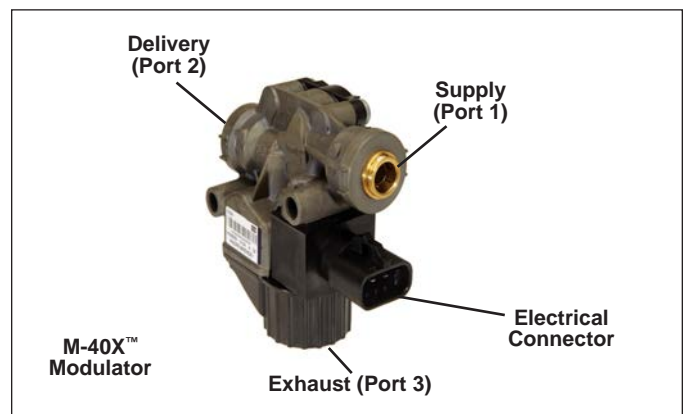

FIGURE 3 - EXAMPLE OF A BENDIX M-40X™ MODULATOR

- A dash-mounted ESP Status/Indicator Lamp (also serves as the ATC Status/Indicator Lamp)
- A Bendix® SAS-60™ Steering Angle Sensor (mounted to the steering column - See Figure 4)

CAUTION

When replacing a steering wheel, take care not to damage the Steering Angle Sensor or interfere with its operation, and the Steering Angle Sensor must be recalibrated (see Troubleshooting section.)



FIGURE 4 - EXAMPLES OF STEERING ANGLE SENSORS

- Bendix® YAS-60™ or YAS-70X™ Yaw Rate/Lateral Acceleration Sensors (typically mounted to a cross-member near the back of the vehicle cab). See *Figure 5*.
- Brake Demand Sensors (installed in the primary and secondary delivery circuits)
- A Load Sensor (typically installed in the suspension air bag)
- An additional Modulator Valve (Bendix® M-40QR™ or M-40HF™ Pressure Modulator Valve) that controls the pressure applied to the trailer brakes during a system intervention

The Bendix® ESP® EC-80™ Controller's ATC function utilizes the following additional components:

- A drive axle Traction Control Valve (may be integral to the service brake relay valve or a stand-alone device)
- A dash-mounted ATC Status/Indicator Lamp
- A J1939 serial communication Control Module
- A J1939- or ECU hardware-provided Stop Lamp Switch Input
- An optional ATC Mud/Snow Switch (sometimes referred to as an ATC off-road switch)

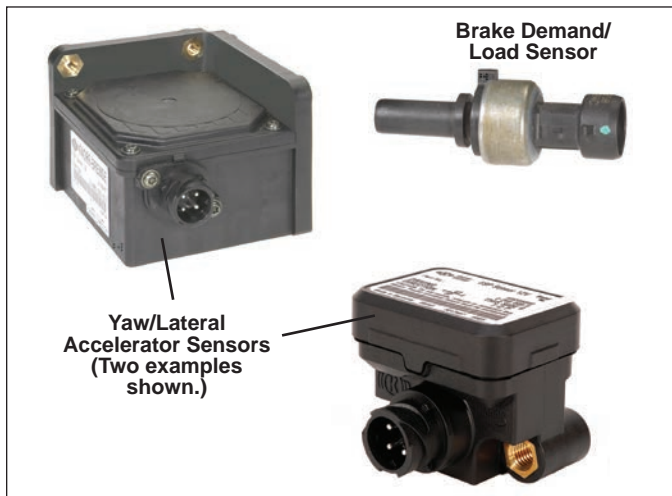

FIGURE 5 - YAW AND BRAKE DEMAND/LOAD SENSORS

The Bendix ESP EC-80 Controller's Hill Start Aid function utilizes the following additional components:

- A Bendix® AT-3™ Traction Control Valve
- A dash-mounted Hill Start Status/Indicator Lamp
- A dash-mounted Enable/Disable Switch
- A Bendix® RV-3™ Pressure Reducing Valve
- A Bendix® DC-4® Double Check Valve

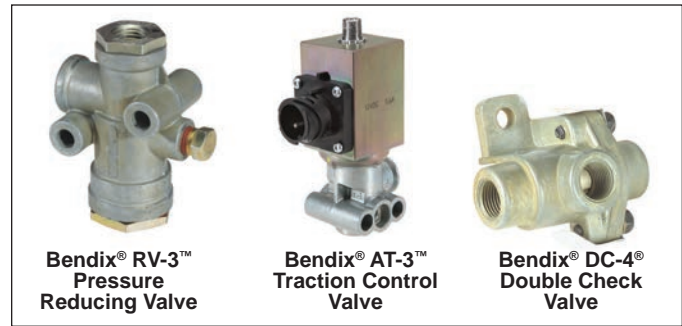

FIGURE 6 - ADDITIONAL VALVES NECESSARY FOR THE HILL START AID FEATURE

BENDIX® ETRAC™ AUTOMATED AIR SUSPENSION TRANSFER SYSTEM

The Bendix® eTrac™ automated air pressure transfer system is used on 6 x 2 semi-tractors that feature Bendix® ATC and ESP Antilock Brake Systems (ABS). This system complements the Bendix® SMART ATC™ traction control feature of our ABS system to provide improved traction at low speeds (e.g. pulling away on an inclined ramp, or in slippery conditions such as mud or snow-covered surfaces, etc.) When active, the Bendix eTrac system vents – or “dumps” – the air pressure of the tag axle suspension air bags, and increases the air pressure in the drive axle suspension air bags to a pre-determined maximum. This action helps the drive axle to gain more traction.

See *SD-13-21021* for more information about the Bendix® eTrac™ Automated Air Suspension Transfer System.

ECU MOUNTING

The Bendix ESP EC-80 Controller is not protected against moisture, and must be mounted in an environmentally protected area.

All wire harness connectors must be properly seated. The use of secondary locks is strongly recommended.

The Bendix ESP EC-80 Controller utilizes connectors from the AMP MCP 2.8 product family.

HARDWARE CONFIGURATIONS

Bendix ESP EC-80 Controllers support applications up to six sensor/six modulator (6S/6M) installations with ATC and drag torque control. They can also support Hill Start functions. All 12 volt models support Power Line Carrier (PLC). 24 volt models do not support PLC. See *Figure 7* for more details.

ABS Off-Road	ATC	ATC Mud/Snow	Blink Codes	ESP/RSP	HSA Hill Start Aid Feature	Bendix® eTrac™ system*	Input Voltage	PLC	Modulators (PMVs)	Retarder Relay	Sensors	Serial Communication
												J1939
✓	✓	Optional	✓	✓	Optional	Optional	12/24	✓	4/5/6	✓	4/6	✓

*For information about the Bendix® eTrac™ automated air suspension transfer system, see SD-13-21021

FIGURE 7 - BENDIX® ESP® EC-80™ CONTROLLER FEATURES

BENDIX® ESP® EC-80™ CONTROLLERS USE POWER LINE CARRIER (PLC)

All new towing vehicles built since March 1, 2001, have had an in-cab trailer ABS Indicator Lamp installed.

Trailers built since March 1, 2001, transmit the status of the trailer ABS over the power line (the blue wire of the J560 connector) to the tractor using a Power Line Carrier (PLC) signal. See Figures 8 and 9. Typically the signal is broadcast by the trailer ABS Electronic Control Unit (ECU).

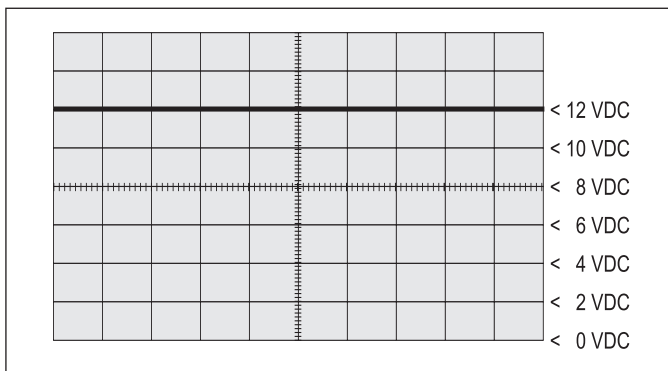

FIGURE 8 - POWER LINE WITHOUT PLC SIGNAL

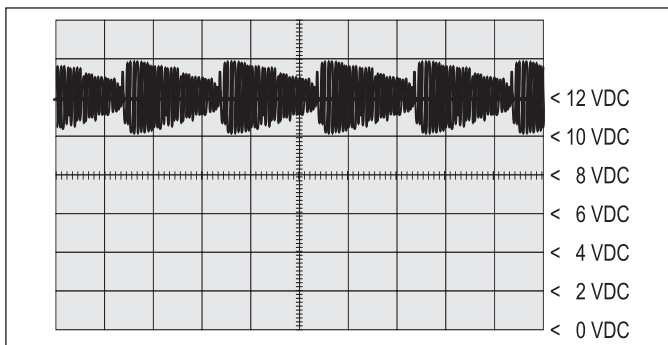

FIGURE 9 - POWER LINE WITH PLC SIGNAL

The application of PLC technology for the heavy vehicle industry in North America is known as “PLC4Trucks.”

The Bendix® ESP® EC-80™ Controller supports PLC communications in accordance with SAE J2497.

PLC SIGNAL

An oscilloscope can be used to measure or identify the presence of a PLC signal on the power line. The PLC signal is an amplitude and frequency-modulated signal. Depending on the filtering and load on the power line, the PLC signal amplitude can range from 5.0mVp-p to 7.05Vp-p.

Suggested oscilloscope settings are AC coupling, with one volt/div, 100 µsec/div. The signal should be measured at the ignition power input of the Bendix EC-80 Controller.

Note: An ABS trailer equipped with PLC, or a PLC diagnostic tool, must be connected to the vehicle in order to generate a PLC signal on the power line.

BENDIX ESP EC-80 CONTROLLER INPUTS

Battery and Ignition Inputs

The Bendix ESP EC-80 Controller operates at a nominal supply voltage of 12 (or 24 volts, if available), depending on the ECU. The battery input is connected through a 30 amp fuse directly to the battery.

The ignition input is applied by the ignition switch circuit through a 5 amp fuse.

Ground Input

The Bendix ESP EC-80 Controller supports one ground input. See pages 52 and 53 for wiring system schematics.

ABS Indicator Lamp Ground Input

The Bendix ESP EC-80 Controller requires a second ground input (X1-12) for the ABS indicator lamp. The X1 wire harness connector contains an ABS indicator lamp interlock (X1-15), which shorts the ABS indicator lamp circuit (X1-18) to ground if the connector is removed from the ECU.

Bendix® WS-24™ Wheel Speed Sensors

Wheel speed data is provided to the Bendix ESP EC-80 Controller from the Bendix® WS-24™ wheel speed sensor (see Figure 2). Vehicles have an exciter ring (or “tone ring”) as part of the wheel assembly. As the wheel turns, the teeth of the exciter ring pass the wheel speed sensor, generating an AC signal. The Bendix ESP EC-80 Controller receives the AC signal, which varies in voltage and frequency as the wheel speed changes.

Vehicle axle configurations determine the number of Bendix WS-24 wheel speed sensors that must be used. A vehicle with a single rear axle requires four wheel speed sensors. Vehicles with two rear axles can utilize six wheel speed sensors for optimal performance.

Diagnostic Blink Code Switch

A momentary switch that grounds the ABS Indicator Lamp output is used to place the ECU into the diagnostic blink code mode and is typically located on the vehicle's dash panel.

Optional ABS Off-Road Switch and Indicator Lamp Operation

Vehicle operators use an optional dash-mounted switch to place the Bendix® ESP® EC-80™ Controller into the ABS off-road mode. See "Optional ABS Off-Road Mode" on page 10 for further details. In some cases, ECUs may also be put into the ABS off-road mode by one of the other vehicle control modules, using a J1939 message to the Bendix ESP EC-80 Controller.

(If you need to know if a specific Bendix ESP EC-80 Controller uses a J1939 message to operate the lamp, contact the Bendix Tech Team. E-mail the Tech Team at ABS@bendix.com (be sure to specify the ECU part number), or call 1-800-AIR-BRAKE (1-800-245-2725).



WARNING

The ABS off-road mode should not be used on normal, paved road surfaces because vehicle stability and steerability may be adversely affected. When the ECU is placed in the ABS off-road mode, the ABS Indicator Lamp will flash constantly (at a rate of once per 2.5 seconds) to notify the vehicle operator that the off-road mode is active.

Optional ATC Mud/Snow (Off-Road) Switch and Indicator Lamp Operation (also see page 8.)

The Bendix ESP system uses a dash-mounted switch for the operator to place the ECU into the ATC Mud/Snow mode.

Optional Hill Start/Hill Start Assist Feature Switch and Lamp Operation (see also page 8.)

ESP Controllers use a dash-mounted switch for the operator to place the ECU into the hill start mode. This feature interfaces between the transmission and the braking system to help the driver prevent the vehicle from rolling downhill when moving up a steep incline from a stationary position.



WARNING

With Hill Start Aid Feature option you lose the ABS off-road function and the retarder relay output.

When the ECU is placed in the Hill Start Aid (HSA) feature mode, the HSA Indicator Lamp will flash constantly (at a rate of once per 2.5 seconds) to notify the vehicle operator that the HSA mode is active. The ECU receives J1939 messages from the transmission to engage the HS/HSA components. When engaged, the system applies 44 psi to the rear brakes for three (3) seconds then releases. This function is totally controlled by the automatic transmission.

Stop Lamp Switch (SLS)

The Bendix ESP EC-80 Controller monitors the vehicle stop lamp status. Certain vehicle functions, such as ATC and All-Wheel Drive (AWD), use the status of the stop lamp to determine when the driver makes a brake application. This can be provided to the ECU via J1939 communications, or hardware input.

Brake Demand Sensors

The brake demand sensors provide the Controller with an indication of driver-applied brake pressure. One is installed in the primary air brake circuit, and another is installed in the secondary air brake circuit.

Load Sensor

The load sensor provides the Controller with an indication of the vehicle load. It is typically installed in one of the suspension air bags.

Bendix® SAS-70X™ Steering Angle Sensor

Bendix® brand Steering Angle Sensors (SAS) are used to report the steering wheel position to the Controller, utilizing a dedicated serial communications link that is shared with the Yaw Rate Sensor. The Controller supplies the power and ground inputs to the Bendix® SAS-70X™ sensor.

The Bendix SAS-70X sensor is available with two different styles of wire harness connectors. (See Figure 4.)

Bendix® YAS-60™ or YAS-70X™ Yaw Rate/Lateral Acceleration Sensors

Bendix® brand yaw rate/lateral acceleration sensors are used to provide the Controller an indication of vehicle lateral acceleration and rotation around the vertical axis. This information is provided to the Controller, utilizing a dedicated serial communications link that is shared with the Bendix® SAS-60™ sensor. The Controller supplies the power and ground inputs to the yaw rate sensor.

BENDIX® ESP® EC-80™ CONTROLLER OUTPUTS

Bendix® M-40QR™ and M-40HF™ Pressure Modulator Valves (PMVs)

The Bendix ESP EC-80 Controller operates Bendix® M-40QR™ and M-40HF™ Pressure Modulator Valves (PMVs) to modify the driver-applied air pressure to the service brakes during ABS, ATC, RSP or YC activation (see pages 9-13). The PMV is an electropneumatic control valve and is the last valve that air passes through on its way to the brake chamber. The modulator hold and release solenoids are activated to "modulate" or "control" the brake pressure during an antilock braking event. The hold solenoid is normally open and the release solenoid is normally closed, such that the PMV nominally allows air to flow through. This design allows for air delivery to brake chambers in the event of electrical trouble.

The Bendix® ESP® EC-80™ Controller also utilizes an additional Pressure Modulator Valve (PMV) for control of the trailer service brakes during stability interventions.

Traction Control Valve (TCV)

Bendix ESP EC-80 Controllers use two TCVs, one on the steer axle and one on the drive axle. The TCV may be a separate valve or integrated into the rear axle relay valve.

The Controller will activate the drive axle TCV during differential braking ATC events.

During stability interventions, the Controller will activate both the steer axle and drive axle TCVs as required.

Stop Lamp Output

The Controller provides an output to control a relay that illuminates the vehicle stop lamps during stability interventions. This information is also available using the J1939 serial communications link.

ABS Indicator Lamp Control with Optional Diagnostic Blink Code Switch

The Bendix ESP EC-80 Controller has internal circuitry to control the ABS Indicator Lamp on the dash panel.

The ABS Lamp Illuminates:

1. During power up (e.g. when the vehicle is started) for approximately three (3) seconds and turns off after the self-test is completed, providing no **Diagnostic Trouble Codes (DTCs)** are present on the ECU;
2. When full ABS operation is not available due to the presence of a DTC on the ECU;
3. If the ECU is unplugged or has no power;
4. When the ECU is placed into the ABS off-road mode (the lamp flashes steadily at a rate of once per 2.5 sec.); or
5. To display blink codes for diagnostic purposes after the external diagnostic switch is activated.

The Bendix ESP EC-80 Controller may communicate with other vehicle control modules to operate the ABS Indicator Lamp using serial communications. (If you need to know if this Bendix ESP EC-80 Controller uses serial communications to operate the lamp; e-mail ABS@bendix.com, (be sure to specify the ECU part number), or call 1-800-AIR-BRAKE/1-800-247-2725 and speak to the Bendix Tech Team.)

Indicator Lamp Control Using Serial Communications Links

As mentioned above, depending on the vehicle manufacturer, the dash indicator lamps (ABS, ATC, ESP, and trailer ABS) may be controlled using serial communications links. In these cases, the Bendix ESP EC-80 Controller will send a serial communications message over the J1939 link, indicating the required status of the lamp(s). Another vehicle control module receives the message and controls the indicator lamp(s).

Dynamometer Mode Indicator Lamp Operation

When the Bendix ESP EC-80 Controller is put into the Dynamometer mode for testing purposes, the ATC Indicator Lamp will be illuminated.

Retarder Relay Disable Output

The retarder relay disable output may be used to control a retarder disable relay. When configured to use this output, the ECU will energize the retarder disable relay and inhibit the use of the retarder as needed.

If the ECU is configured for the Hill Start/ Hill Start Assist feature (HS/HSA), the retarder relay output pin is used to control the Hill Start status lamp. As a result, the vehicle loses the retarder relay function when it has the Hill Start feature.

SAE J1939 Serial Communications

A Controller Area Network (CAN) data link (SAE J1939) is provided for communication. This link is used for various functions, such as:

- Diagnostic purposes.
- To disable retarding devices during ABS operation.
- To request that the torque converter disable lock-up during ABS operation
- To share information such as wheel speed and ECU status with other vehicle control modules.

Bendix ESP EC-80 Controllers utilize the J1939 data link for:

- ATC and drag torque control functions.
- Vehicle stability functions.

Trailer ABS Indicator Lamp Control

The Bendix ESP EC-80 Controller will activate a trailer ABS Indicator Lamp (located on the dash panel) that indicates the status of the trailer ABS unit on one, or more trailers, or dollies that are equipped with PLC functionality. Typically, the Bendix ESP EC-80 Controller directly controls the trailer ABS Indicator Lamp based on the information it receives from the trailer ABS, via PLC.

Alternatively, some vehicles require the Bendix ESP EC-80 Controller to activate the trailer ABS Indicator Lamp by communicating with other vehicle Controllers using serial communications.

(If you need to know if this Bendix ESP EC-80 Controller uses a serial communications message to operate the lamp, e-mail ABS@bendix.com (be sure to specify the ECU part number), or call 1-800-AIR-BRAKE (1-800-245-2725) and speak to the Bendix Tech Team.)

Interaxle Differential Lock Control (AWD Transfer Case)

Bendix ESP EC-80 Controllers can control the interaxle differential lock (AWD transfer case). This is recommended on AWD vehicles, but the ECU must be specially configured to provide this feature. E-mail ABS@bendix.com for more details.

INDICATOR LAMPS AND POWER-UP SEQUENCE

NOTICE: The vehicle operator should Verify the proper operation of all installed indicator lamps (ABS, ATC/ESP, and trailer ABS) when applying ignition power and during vehicle operation. See Figure 10.

Lamps that do not illuminate as expected when ignition power is applied, or remain illuminated, indicate the need for maintenance.

Dash Lamp Behavior for the Bendix® ESP® EC-80™ Controller						
						
Mode		ABS Lamp	ATC/ESP Lamp	Trailer ABS Lamp	HSA Lamp	Comments
At Vehicle Startup	Ignition on - start up [trailer with Power Line Carrier (PLC)]	ON for three (3) seconds*	ON for 2.5 seconds*	ON for three (3) seconds**	ON for three (3) seconds*	* If any of the described lamp behaviors do not occur – or if the lamp remains on during operation – have the vehicle serviced by a qualified mechanic as soon as possible to restore full system functionality. ** Some vehicle manufacturers may illuminate the trailer ABS indicator lamp at power-up regardless of whether a PLC signal is detected from the trailer or not. Consult the vehicle manufacturer’s documentation for more details.
	3 seconds after ignition [with no Diagnostic Trouble Codes (DTCs)]	Lamp OFF*	Lamp OFF*	Lamp OFF**	Lamp OFF*	
Special Mode Operation	ABS Off-Road Mode	Normal	Lamp flashes slowly (every 2.5 seconds)	Lamp OFF	• Uses dash switch • Not for firm road surfaces • Allows more wheel lock-up (less ABS intervention) • Mode only applies under 25 mph (Over 25 mph, the system reverts to full ABS - including ATC/ESP – and upon exiting off-road mode, the ATC lamp extinguishes.)	
		During an ATC Event		Flashes quickly		
	-- OR, depending on vehicle options (a vehicle can have either ABS off-road or HSA) --					
	Vehicles with Hill Start Aid (HSA): During HSA Mode ("Hill Start" / "Hill Start Assist")			During HSA Event	Lamp OFF	• The HSA lamp is illuminated only at power-up, or if an HSA DTC is present
				HSA Manually Disabled	Flashes slowly	
Deep Mud/Snow/ Mode	Normal	OFF	Flashes slowly (every 2.5 seconds)	• Uses dash switch • Increases allowable wheel slip during ATC interventions • Not for firm road surfaces		
	During an ATC/ESP Event	OFF	Flashes quickly			
During an Automatic Traction Control (ATC) Event			Flashes quickly	• Reduces wheel slip during acceleration at low speeds		
During Dynamometer Mode			Lamp ON (ATC Disabled)	• Disables ATC monitoring functions • When not in Dynamometer Mode, an illuminated lamp indicates an ATC DTC is present		
During an ESP Event			Flashes quickly	• System intervenes to reduce the risk of rollovers, loss-of-control, etc.		

ABS System Status Indicators at Start-Up

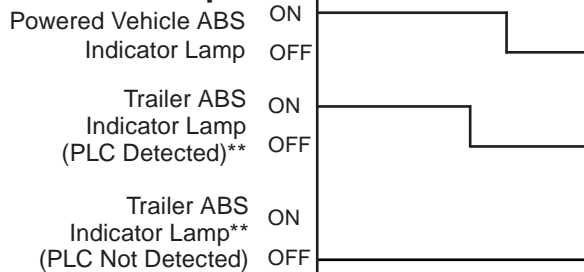

ATC/ESP System Status Indicator at Start-Up

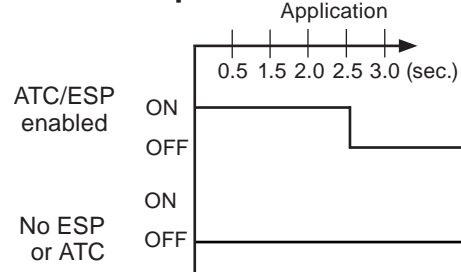

FIGURE 10 - BENDIX® ESP® EC-80™ CONTROLLER INDICATOR LAMP BEHAVIOR

ABS Indicator Lamp Operation (Bulb Check)

The Bendix® ESP® EC-80™ Controller will illuminate the ABS Indicator Lamp for approximately three seconds when ignition power is applied, after which the lamp will extinguish if no Diagnostic Trouble Codes (DTCs) are detected.

The Controller will illuminate the ABS Indicator Lamp whenever full ABS operation is not available due to a DTC. In most cases, partial ABS is still available.

ATC/ESP Status/Indicator Lamp Operation

The Bendix ESP EC-80 Controller will illuminate the ATC/ESP lamp for approximately 2.5 seconds when ignition power is applied, after which the lamp will extinguish if no DTCs are detected. The Controller will continuously illuminate the ATC/ESP Indicator Lamp whenever ESP or ATC is disabled due to a DTC.

During an ESP or ATC intervention, the lamp will flash rapidly (2.5 times per second). When the Controller is placed in the ATC Mud/Snow (off-road) mode, the lamp will flash slowly at a rate of once every 2.5 seconds.

Trailer ABS Indicator Lamp Operation

The Controller will control the Trailer ABS Indicator Lamp when a PLC signal (SAE J2497) from a trailer ABS ECU is detected.

Hill Start Assist (HSA) Indicator Lamp Operation

Vehicles with HSA enabled, will illuminate the HSA Indicator Lamp when ignition power is applied. The lamp will extinguish if there are no issues with the HSA system.

Pressure Modulator Valve (PMV) and Traction Control Valve (TCV) Chuff Test

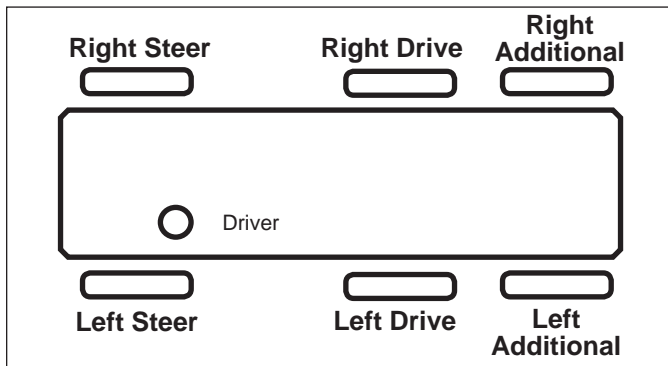

FIGURE 11 - VEHICLE ORIENTATION (TYPICAL)

After the performance of the configuration test, the Bendix ESP EC-80 Controller will perform a Bendix-patented PMV and TCV Chuff Test. The Chuff Test is an electrical and pneumatic PMV test that can assist maintenance personnel in verifying proper PMV wiring and installation.

When ignition power is applied, each modulator solenoid is briefly energized. If the air system is fully charged and the service brake pedal is depressed during ignition, the modulator creates a single, sharp audible “chuff” of air pressure. The modulators are energized in a certain pattern: right front; left front; right rear; then left rear.

This test is performed only when the vehicle is stationary (if the vehicle moves, the Chuff Test will not be performed).

The Bendix ESP EC-80 Controller will perform a PMV Chuff Test on all installed modulators in the following order:

- Steer Axle Right PMV;
- Steer Axle Left PMV;
- Drive Axle Right PMV;
- Drive Axle Left PMV;
- Additional Axle Right PMV;
- Additional Axle Left PMV; then
- Drive Axle TCV

The pattern will then repeat itself. See Figure 11.

Vehicles with a Bendix ESP EC-80 Controller – following the completion of the second round of PMV & TCV Chuff Tests – the Controller (if configured to do so) will perform a test to cross-check the trailer PMV operation with the vehicle stop lamps. If the trailer PMV circuit is mis-wired (including the steer axle TCV), the PMV will exhaust a large amount of air, or none at all.

NOTICE: If there are any active DTCs, the stop lamp cross-check portion of the Chuff Test will not be carried out until all DTCs are fully diagnosed and the corresponding repairs are successfully conducted. The ESP/ATC dash indicator will also illuminate when there are active ABS, ATC or ESP DTCs.

The ECU will not perform the PMV Chuff Test when wheel speed sensors show that the vehicle is in motion.

ABS OPERATION

Bendix® ABS uses wheel speed sensors, ABS pressure modulator valves, and an ECU to control either four or six wheels of a vehicle. The Bendix ESP EC-80 Controller monitors individual wheel turning motion during braking, and adjusts or modulates the brake pressure at the wheel end. When excessive wheel slip – or wheel lock-up – is detected, the Bendix ESP EC-80 Controller will activate the pressure modulator valves to automatically reduce the brake pressure at one or more of the wheel ends. By these actions, the ABS system helps to maintain the vehicle's lateral stability and steerability during heavy brake applications and during braking on slippery surfaces.

Steer Axle Control

Although both wheels of the steer axle have their own wheel speed sensor and pressure modulator valve, the Bendix ESP EC-80 Controller blends the applied braking force between the two steering axle brakes. This Bendix patented brake application control, called Modified Individual Regulation (MIR), is designed to help reduce steering wheel pull during an ABS event on road surfaces with poor traction, or areas of poor traction (e.g. asphalt road surfaces with patches of ice).

Single Drive Axle Control (4x2 Vehicle)

For vehicles with a single rear drive axle (4x2), the brakes are operated independently by the Bendix® ESP® EC-80™ Controller, based on the individual wheel behavior.

Dual Drive Axle Control (4S/4M Configuration)

For vehicles with dual drive axles (6x4) using a 4S/4M configuration, one ABS modulator controls both of the right-side rear wheels; the other modulator controls both of the left-side rear wheels. Both wheels on each side receive equal brake pressure during an ABS stop. The rear wheel speed sensors must be installed on the axle with the lightest load.

Dual Rear Axle Control (6S/6M Configuration)

For vehicles with dual rear axles (6x4, 6x2) using a 6S/6M configuration, the rear wheels are controlled independently. Therefore, brake application pressure at each wheel is adjusted according to the individual wheel behavior on the road surface.

6x2 Vehicles with 6S/5M Configuration

6x2 vehicles can utilize a 6S/5M configuration, with the additional axle (a non-driven rear axle) having two sensors, but only one Pressure Modulator Valve (PMV). In this case, the PMV controls both wheels on the additional axle. The additional axle wheels would receive equal brake pressure, based on the wheel that is currently experiencing the most wheel slip.

Normal Braking

During normal braking, brake pressure is delivered through the ABS PMV and into the brake chamber. If the ECU does not detect excessive wheel slip, it will not activate ABS control, and normal vehicle service braking is applied.

Retarder Brake System Control

On surfaces with low traction, application of the retarder can lead to high levels of wheel slip at the drive axle wheels, which can adversely affect vehicle stability.

To prevent this, the Bendix ESP EC-80 Controller switches off the retarder as soon as a lock-up is detected at one (or more) of the drive axle wheels.

When the ECU is placed in the ABS off-road mode (on vehicles equipped with this optional feature), it will switch off the retarder only when ABS is active on a steer axle wheel and a drive axle wheel.

Optional ABS Off-Road Mode

On some road conditions, particularly when the driving surface is soft, the stopping distance with conventional ABS may be longer than without ABS. This can occur when a locked wheel on soft ground or loose gravel plows up the road surface in front of the tire, changing the rolling friction value. Although vehicle stopping distance with a locked wheel (in the absence of ABS) may be shorter than

corresponding stopping distance with conventional ABS control, vehicle steerability and stability would be reduced.

Bendix ESP EC-80 Controllers have an optional dash switch that initiates a modified ABS control mode (known as "off-road ABS") that more effectively accommodates these soft road conditions to shorten stopping distance while maintaining optimal vehicle steerability and stability.

Note: Off-road mode is not available if the vehicle is equipped with Hill Start / Hill Start Assist (HS or HSA).



The ABS off-road mode should not be used on normal, paved road surfaces because vehicle stability and steerability may be reduced. The ABS Indicator Lamp will flash slowly to indicate to the driver that the ABS off-road mode is engaged.



When ABS off-road mode is engaged, stability functions are disabled at speeds below approximately 25mph/40kph. The ATC/ESP dash lamp will illuminate to indicate to the driver that the stability system is disabled.

The vehicle manufacturer should provide the optional ABS off-road function only for vehicles that operate on unpaved surfaces – or that are used in off-road applications – and is responsible for ensuring that vehicles equipped with the ABS off-road function meet all FMVSS-121 requirements and have adequate operator indicators and instructions.

The vehicle operator activates the off-road function with a switch on the dash panel. A flashing ABS Indicator Lamp indicates to the driver that the ABS off-road function is engaged. To exit the ABS off-road mode, depress and release the switch. A new ignition cycle will also cause the ECU to exit the ABS off-road mode.

All-Wheel Drive (AWD) Vehicles

AWD vehicles with an engaged interaxle differential (steer axle to rear axle) / AWD transfer case, may have negative effects on ABS performance. Optimum ABS performance is achieved when the lockable differentials are disengaged, allowing individual wheel control.

Bendix ESP EC-80 Controllers can be programmed specifically for this configuration to control the differential lock/unlock solenoid in the AWD transfer case. When programmed to do so, the ECU will disengage the locked interaxle/AWD transfer case during an ABS event and reengage it once the ABS event has ended.

ATC OPERATION

ATC Functional Overview

Just as ABS improves vehicle stability during braking, Automatic Traction Control (ATC) improves vehicle stability and traction during vehicle acceleration. The Bendix® ESP® EC-80™ Controller's ATC function uses the same wheel speed information and modulator control as the ABS function. The Bendix ESP EC-80 Controller detects excessive drive wheel speed; compares the speed to the front, non-driven wheels; and reacts to help bring the wheel spin under control. The Controller can be configured to use engine torque limiting and/or differential braking to control wheel spin. For optimal ATC performance, both methods are recommended.

ATC/ESP Lamp Output/ATC Mud/Snow Switch Input

Bendix ESP EC-80 Controllers operate the ATC/ESP dash lamp as follows.

The ATC/ESP dash lamp illuminates:

1. During power up (e.g. when the vehicle is started) for approximately 2.5 seconds and turns off after the self test is completed, providing no Diagnostic Trouble Codes (DTCs) are present.
2. When ESP or ATC is disabled for any reason.
3. During an ESP or ATC event (the lamp will flash rapidly at a rate of 2.5 times per second).
4. When the ECU is placed in the ATC off-road mode (the lamp will flash steadily at a rate of once every 2.5 seconds). This notifies the vehicle operator that the ATC Mud/Snow mode is active.
5. When the ECU is placed in the ABS off-road mode. When in this mode, ESP will be disabled below 25 mph and its inactive status will be indicated by a steadily illuminated ATC/ESP lamp.

Differential Braking

Differential braking within ATC is automatically activated when drive wheel(s) on one side of the vehicle are spinning excessively. This typically occurs on road surfaces with patches of ice. The traction system will then lightly apply the brake to the drive wheel(s) that are spinning excessively. The vehicle differential will then drive the wheels on the other side of the vehicle.

Differential braking (as part of ATC functionality) is available at vehicle speeds up to 25 mph/40 kph.

Disabling ATC Differential Braking

ATC differential braking is disabled under the following conditions:

1. During power up (e.g. when the vehicle is started), until the ECU detects a service brake application.
2. If the ECU receives a J1939 message indicating that the vehicle is parked.
3. When the dynamometer test mode is active. The Dynamometer test mode is entered using the diagnostic Blink Code Switch or by using a diagnostic tool (such as Bendix® ACom® Diagnostics).
4. In response to a serial communications request from a diagnostic tool.
5. If ATC Differential Braking function is activated for a long time period to avoid overheating of the brakes. It would take approximately three (3) continuous minutes of activation for the time-out to occur. Once timed-out, approximately two (2) minutes of "cool off" time would be required before ATC Differential Braking can be used again.
6. When certain DTC conditions are detected.

Traction Control with Engine Torque Limiting

The Bendix ESP EC-80 Controller uses Engine Torque Limiting to control drive-axle wheel slip. This is communicated to the engine control module (using J1939), and is available at all vehicle speeds.

Bendix® SMART ATC™ System

The Bendix ESP EC-80 Controller has an additional feature known as the Bendix® SMART ATC™ system. This system monitors the accelerator pedal position (using J1939) to help provide optimum traction and vehicle stability. By determining the driver's throttle input and adapting the target slip of the drive wheels to the driving situation, the Bendix SMART ATC system allows higher wheel slip when the accelerator pedal is applied above a preset level.

The wheel slip allowed by the Bendix SMART ATC system is decreased when driving through a curve for improved stability.

Disabling ATC Engine Control and the Bendix SMART ATC System

ATC Engine Control and the Bendix SMART ATC system will be disabled under the following conditions:

1. In response to a serial communications request from an off-board tool;
2. At power-up until the ECU detects a service brake application;
3. If the ECU receives a J1939 message indicating that the vehicle is parked;
4. If the dynamometer test mode is active. This may be accomplished via an off-board tool or the diagnostic Blink Code Switch; or
5. When certain DTC conditions are detected.

Optional ATC Mud/Snow (Off-Road) Mode

In some road conditions, the vehicle operator may desire additional drive wheel slip when ATC is active. The Bendix® ESP® EC-80™ Controller has an optional control mode to permit this desired performance.

The vehicle operator can activate the Mud/Snow function with a switch on the dash panel. Alternately, a J1939 message may be used to place the vehicle in this mode. The ATC/ESP Indicator Lamp will flash steadily at a rate of once every 2.5 seconds to confirm that the ATC mud/snow mode is engaged.

To exit the ATC Mud/Snow mode, depress and release the ATC Mud/Snow switch.

Drag Torque Control Functional Overview

Bendix ESP EC-80 Controllers have a feature referred to as drag torque control which reduces wheel slip on a driven axle due to driveline inertia. This condition is addressed by increasing the engine torque to overcome the inertia.

Drag torque control increases vehicle stability on low-traction road surfaces during down-shifting or retarder braking.

BENDIX ESP EC-80 ABS WITH STABILITY CONTROL

Overview

The Bendix ESP system with the EC-80 Controller reduces the risk of rollovers, jackknifing and other loss-of-control events. Bendix ESP EC-80 Controllers include Roll Stability Program (RSP®) and Yaw Control (YC) functions. During operation, the Bendix ESP EC-80 Controller constantly compares performance models to the vehicle's

actual movement, using wheel speed sensors; a lateral acceleration sensor, a yaw rate sensor, and a steering angle sensor. If the vehicle shows a tendency to leave an appropriate travel path, or if critical threshold values are approached, the system will intervene to assist the driver.

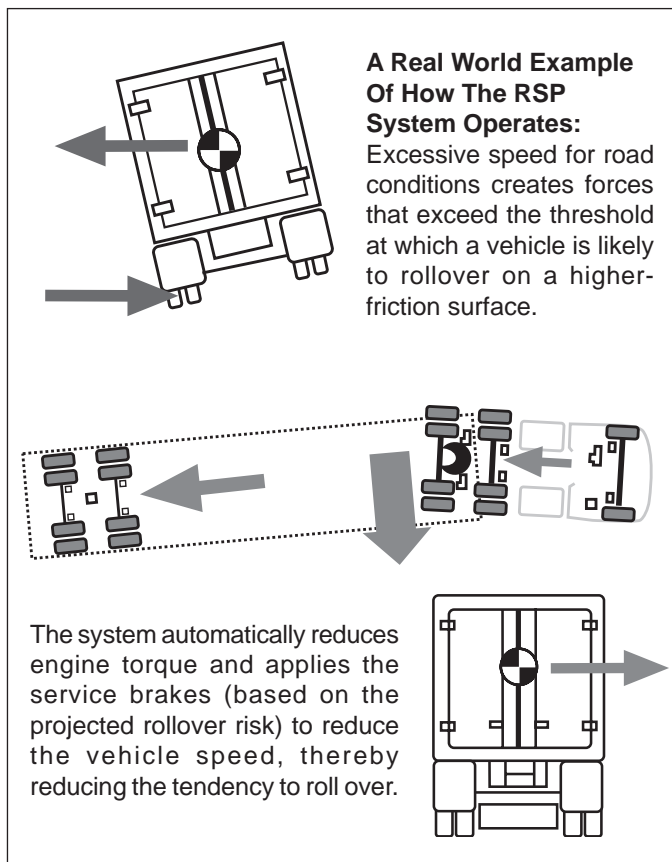

FIGURE 12 - RSP EXAMPLE

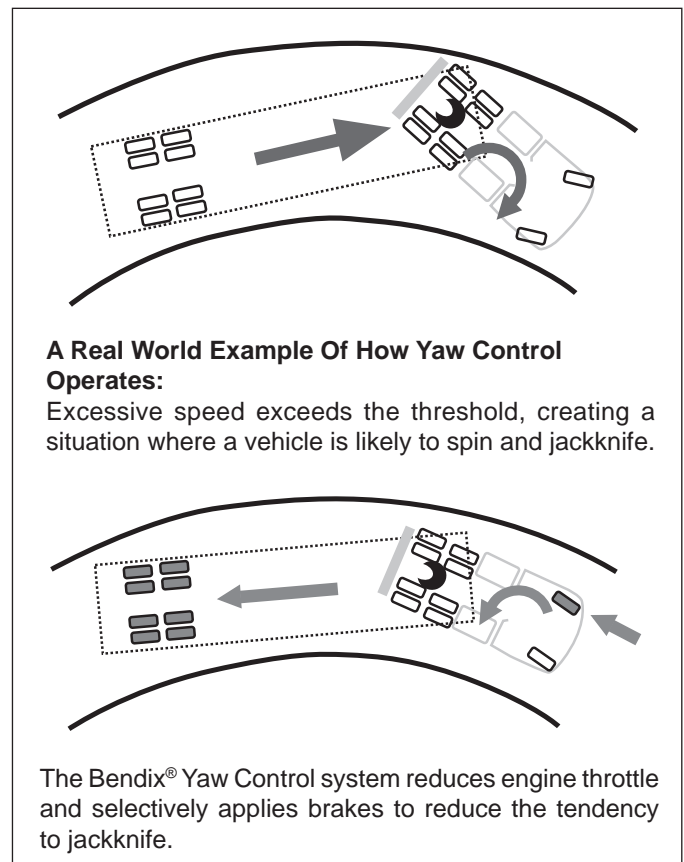

FIGURE 13 - YAW CONTROL EXAMPLE

Bendix® Roll Stability Program (RSP®)

Bendix RSP – an element of the overall Bendix® ESP® system with the EC-80™ Controller – addresses rollover conditions. In the case of a potential roll event, the ECU will override the throttle and quickly apply brake pressure at all wheel ends to slow the vehicle combination. The level of braking application during an RSP event will be proportional to roll risk. See *Figure 12*.

Yaw Stability

Yaw stability counteracts the tendency of a vehicle to spin about its vertical axis. During operation – if the friction between the road surface and the tires is not sufficient to oppose lateral (side) forces – one or more of the tires can slide, causing the truck/tractor to spin. These events are referred to as either an "under-steer" situation (where there is a lack of vehicle response to steering input due to tire slide on the steer axle), or an "over-steer" (where the tractor's rear end slides out due to tire slide on the rear axle) situation. Generally, shorter wheelbase vehicles (tractors, for instance) have less natural yaw stability, while longer wheelbase vehicles (straight trucks, for instance) have greater natural yaw stability. Factors that influence yaw stability are: wheelbase, suspension, steering geometry, weight distribution front to rear, and vehicle track width.

Yaw Control

Yaw control responds to a wide range of low- to high-friction surface scenarios including rollover, jackknife and loss-of-control. It is the recommended system for all power vehicles and especially critical for tractors pulling trailers. In the case of vehicle slide (over-steer or under-steer situations), the system will reduce the throttle and then brake one or more of the "four corners" of the vehicle (in addition to potentially applying the trailer brakes), thus applying a counter-force to better align the vehicle with an appropriate path of travel.

For example, in an over-steer situation, the system applies the "outside" front brake; while in an under-steer condition, the "inside" rear brake is applied. (See *Figure 13*)

IMPORTANT SAFETY INFORMATION ABOUT THE BENDIX® ESP® SYSTEM



The Bendix ESP EC-80 Controller may reduce the vehicle speed automatically.

The Bendix® ESP® system can make the vehicle decelerate automatically and can slow the vehicle with or without the operator applying the brake – and even when the throttle is being applied.



To minimize unexpected deceleration and reduce the risk of a collision, the operator must:

- **Avoid aggressive driving maneuvers, such as sharp turns or abrupt lane changes at high speeds, which might trigger the stability system; and**
- **Always operate the vehicle safely, drive defensively, anticipate obstacles and pay attention to road, weather and traffic conditions. Bendix ABS, ATC and ESP systems are no substitute for prudent, careful driving.**

Towing Doubles Or Triples May Reduce The Effectiveness Of Stability Systems



The Bendix ESP system with the EC-80 Controller is designed and optimized for trucks and for tractors that tow single trailers. If a tractor equipped with Bendix ESP is used to power multiple trailer combinations (known as "doubles" or "triples") the effectiveness of the Bendix ESP system may be greatly reduced. Extremely careful driving is always required when towing doubles or triples. Excessive speed and aggressive maneuvers – such as sharp turns, sudden steering inputs, or abrupt lane changes – should be avoided.

Limitations Of Stability Systems

The effectiveness of the Bendix ESP system with the EC-80 Controller may be greatly reduced if:

- The load shifts due to improper retention, accident damage, or the inherently mobile nature of some loads (for example, hanging meat, live animals or partially laden tankers),
- The vehicle has an unusually high – or off-set – center of gravity (CG),
- One side of the vehicle drops off the pavement at an angle that is too large to be counteracted by a reduction in speed,
- The vehicle is used to haul double or triple trailer combinations,
- If very rapid steering changes are attempted at high speeds,
- There are mechanical problems with suspension leveling of the tractor or trailer resulting in uneven loads,
- The vehicle is maneuvering on a high banked road creating either additional side forces due to the weight (mass) of the vehicle, or a deviation between expected & actual yaw rates,
- Gusty winds are strong enough to cause significant side forces on the vehicle and any towed vehicles.

To Maximize The Effectiveness Of The Bendix® ESP® System with the EC-80™ Controller:

- Loads must be properly secured at all times.
- Drivers need to exercise extreme caution at all times, plus avoid sharp turns, sudden steering adjustments or abrupt lane changes at high speeds, particularly if:
 - › the vehicle hauls loads that could shift;
 - › the vehicle or load has a high or off-set center of gravity (CG) when loaded; or
 - › the vehicle tows doubles or triples.

Truck Chassis Modifications

If the vehicle's chassis components are altered (for example, a wheel base extension or reduction; tag axle addition or removal; a major body change such as conversion of a tractor into a truck; or an axle, suspension, or steering system component modification) the Bendix® ESP® system must be disabled. Have a qualified mechanic replace the Bendix ESP EC-80 Controller with a Bendix® ESP® ATC EC-80™ Controller and secure the X4 connector (which will no longer be used). The ATC/ESP indicator lamp would continue to function as an ATC indicator lamp, and should be designated as ATC only.



If a modified vehicle does not have the Bendix® ESP® system disabled, serious vehicle braking and performance issues could result, including unnecessary ESP system interventions. This can lead to a loss-of-control of the vehicle.

In addition, remove all cab signage (e.g. visor labels, etc.) that were used to show that the Bendix ESP system was installed. Make any necessary notations in the vehicle manual(s), so that drivers do not misunderstand which ABS options are installed on the vehicle.

Sensor Location Modifications

The location and orientation of the Steering Angle Sensor and Yaw Rate Sensor must not be altered. When servicing, an identical component must be used in the same orientation (using OEM brackets & torque requirements). During installation follow the OEM leveling guidelines.

Steering Angle Sensor Re-Calibration

Whenever maintenance or repair work is performed to the steering mechanism, linkage, steering gear, adjustment of the wheel track, or if the steering angle sensor is replaced, a recalibration of the Steering Angle Sensor must be performed.



If the Steering Angle Sensor is not recalibrated, the yaw control system may not function properly, which can result in incidents leading to loss of vehicle control. See page 19 of this document for more details on this procedure.

DYNAMOMETER TEST MODE



Bendix ATC and ESP systems must be disabled prior to conducting any dynamometer testing. When the Dynamometer Test Mode is engaged, the Bendix ATC EC-80 Controller's brake control and engine control – along with drag torque control and Bendix ESP system functions – are disabled. This test mode is used to avoid torque reduction or torque increase and brake control activation when the vehicle is operated on a dynamometer for testing purposes.

The Dynamometer Test Mode may be activated by pressing and releasing the diagnostic Blink Code Switch five times or by using a hand-held or PC-based diagnostic tool.

During Dynamometer Test Mode the ATC lamp remains ON.

Bendix ESP EC-80 Controllers will remain engaged in the Dynamometer Test Mode even if power to the ECU is removed and re-applied. To exit the test mode, press and release the Blink Code Switch three times, or use a hand-held or PC-based diagnostic tool.

AUTOMATIC TIRE SIZE CALIBRATION

The ECU requires a precise rolling circumference ratio between steer axle and drive axle tires in order for the Bendix ABS, ATC, and ESP systems to perform in an optimal manner. For this reason, a continuously monitoring process takes place in which the precise ratio is calculated. This calculated value is stored in the ECU memory provided the following conditions are met:

1. Rolling-circumference ratio is within the permissible range;
2. Vehicle speed is greater than approximately 12mph/19kph;
3. No acceleration or deceleration is taking place; and
4. There are no active speed sensor Diagnostic Trouble Codes (DTCs).

The ECU is provided with a ratio value of 1.00 as a default setting. If the automatic tire size alignment calculates a different value, this is used to overwrite the original figure in the memory. This process adapts the ABS and ATC function to the vehicle.

Acceptable Tire Sizes

The speed calculation for an exciter ring with 100 teeth is based on a default tire size of 510 revolutions per mile. This figure is based on the actual rolling circumference of the tires, which varies with tire size, tire wear, tire pressure, vehicle loading, etc.

The ABS response sensitivity is reduced when the actual rolling circumference is excessive on all wheels. For a 100 tooth exciter ring, the minimum number of tire revolutions per mile is 376, and the maximum is 665. The ECU will set a Diagnostic Trouble Code (DTC) if the number of revolutions is out of this range.

In addition, the size of the steer axle tires compared to the drive axle tires also has to be within the ABS system design. To avoid DTCs, the ratio of the effective rolling circumference of the steer axle, divided by the effective rolling circumference of the drive axle, must be between 0.85 to 1.15.



The Bendix® ESP® system with the EC-80 Controller effectiveness relies on the accuracy of vehicle speed. If a major change on the tire sizes is made – such that the odometer setting needs to be changed to correct for the new tires – the Bendix ESP EC-80 Controller's setting of tire sizes must also be reprogrammed to revised values.

SYSTEM IMPACT DURING ACTIVE DIAGNOSTIC TROUBLE CODES (DTCs)

ABS PARTIAL SHUTDOWN

Depending on which component the DTC is detected, the Bendix ABS, ATC, and ESP system functions may be fully or partially disabled. Even with the ABS indicator lamp illuminated, the Bendix ESP EC-80 Controller may still provide ABS function on wheels that are not affected. The ABS system Controller should be serviced as soon as possible.

Steer Axle ABS Modulator DTC

ABS on the affected wheel is disabled. ABS and ATC on all other wheels remains active. The Bendix ESP system with the EC-80 Controller is disabled.

Drive Axle/Additional Axle ABS Modulator DTC

ATC is disabled. ABS on the affected wheel is disabled. ABS on all other wheels remains active. The Bendix ESP EC-80 system is disabled.

Steer Axle Wheel Speed Sensor DTC

The wheel with the DTC is still controlled by using input from the remaining wheel speed sensor on the steer axle. ABS remains active on the rear wheels. The Bendix ATC and ESP systems are disabled.

Drive Axle/Additional Axle Wheel Speed Sensor DTC

The Bendix ATC and ESP systems are disabled. In a four sensor system, ABS on the affected wheel is disabled, but ABS on all other wheels remains active.

In a six sensor system, ABS remains active by using input from the remaining rear wheel speed sensor on the same side.

ATC Modulator DTC

The Bendix ATC and ESP systems are disabled. ABS remains active.

J1939 Communication DTC

The Bendix ATC and ESP systems are disabled. ABS remains active.

ECU DTC

The Bendix ABS, ATC, and ESP systems are disabled. The system reverts to normal braking.

Voltage DTC

While voltage is out of range, Bendix ABS, ATC, and ESP systems are disabled. The system reverts to normal braking. When the correct voltage level is restored, full ABS and ATC function is available. The operating voltage range is 9.0 to 17.0 VDC for 12 volt systems, and 20 to 33.5 volts for 24 volt systems.

Steering Angle Sensor DTC

The Bendix ESP system is disabled. Bendix ABS and ATC systems remain active.

Yaw Rate/Lateral Acceleration Sensor DTC

The Bendix ESP system is disabled. Bendix ABS and ATC systems remain active.

Brake Demand Pressure Sensor DTC

The Bendix ESP system is disabled. Bendix ABS and ATC systems remain active.

Load Sensor DTC

The Bendix ESP system is disabled. Bendix ABS and ATC systems remain active.

Steer Axle Traction Control Valve (TCV) DTC

The Bendix ESP system is disabled. Bendix ABS and ATC systems remain active.

Trailer Pressure Modulator Valve (PMV) DTC

The Bendix ESP system is disabled. Bendix ABS and ATC systems remain active.

SYSTEM RECONFIGURATION

The Bendix® ESP® EC-80™ Controller is designed to allow the technician to change the default system settings (chosen by the vehicle OEM) to provide additional or customized features.

Depending on the model, the customizable features include ABS control settings, engine module communication etc. Many of these settings can be reconfigured using a hand-held or PC-based software, such as the Bendix® ACom® Diagnostic software.

ECU RECONFIGURATION

Reconfiguring a Bendix ESP EC-80 Controller may be carried out by using the Blink Code Switch or by using a hand-held or PC-based diagnostic tool.

Note: During the reconfiguration process – and independently from any reconfiguration being carried out by the technician – the Electronic Control Unit (ECU) will automatically check the J1939 serial link and communicate with other vehicle modules. In particular, if the serial link shows that the vehicle has a retarder device present, the ECU will configure itself to communicate with the retarder device for improved ABS performance. For example, if the ECU detects the presence of a retarder disable relay during a reconfiguration, it will configure itself to control the relay to disable the retarding device as needed.

Reconfiguration Using the Blink Code Switch

With ignition power removed from the Bendix ESP EC-80 Controller, depress the Blink Code Switch. After the ignition power is activated, depress and release the switch seven (7) times to initiate a reconfiguration event.

Diagnostic Tool

A reconfiguration event may be initiated using a hand-held or PC-based diagnostic tool to communicate with the ECU over the SAE J1939 diagnostic link.

6S/5M Configuration

A Bendix ESP EC-80 Controller will configure for 6S/5M operation when a reconfiguration event is initiated, and the ECU detects that an additional-axle Pressure Modulating Valve (PMV) is wired as follows:

PMV Connector	ECU Connector
Hold	Right Additional Axle Hold
Release	Left Additional Axle Release
Common	Right Additional Axle Common

DATA STORAGE

Depending on the product type and version, Bendix® brand ECUs may store data related to troubleshooting, diagnostics, service needs, vehicle system operating status, and vehicle operator inputs. No personally identifying data (e.g. name, gender or age) is recorded. Bendix will not access stored ECU data or share it with others except: with the consent of the vehicle owner; in response to an official request by law enforcement or other governmental agency; as part of Bendix's defense of litigation; or, as otherwise required by law. Data that Bendix receives may also be used for research purposes or made available to others for research purposes, where a need is shown and the data is not linked to a specific vehicle or owner.

Bendix brand antilock ECUs are not designed to store data for purposes of accident reconstruction and Bendix ACom Diagnostic Software is not intended to retrieve data for purposes of accident reconstruction. Bendix makes no representations as to the accuracy of data retrieved and interpreted from Bendix ECUs for purposes of accident reconstruction.

Troubleshooting: General

GENERAL SAFETY GUIDELINES

Read and follow the General Safety Guidelines shown on page two (2) of this document.

REMOVAL OF THE BENDIX® ESP® EC-80™ CONTROLLER ASSEMBLY

1. Turn vehicle ignition off.
2. Remove as much contamination as possible prior to disconnecting electrical connections.
3. Note the Bendix ESP EC-80 Controller assembly mounting position on the vehicle.
4. Disconnect the electrical connectors from the Controller.
5. Remove and retain the mounting bolts that secure the Controller.



The VIN of the vehicle is stored in the Bendix ESP EC-80 Controller's internal memory, and is cross-checked by the Electronic Control Unit (ECU) using information obtained from other vehicle Controller(s). If the VIN stored in the ECU does not match the VIN obtained from the other vehicle Controller(s), the ECU will generate an ECU Internal VIN Mismatch Diagnostic Trouble Code (DTC).

Accordingly, do not attempt to move a Bendix ESP EC-80 Controller from one vehicle to another.

OBTAINING A NEW BENDIX® ESP® EC-80™ CONTROLLER

Should the Bendix ESP EC-80 Controller require replacement, certain steps must be followed:

1. Record the vehicle model, VIN, year and date of manufacture from the vehicle.
2. Record the part number of the Bendix ESP EC-80 Controller.
3. Provide this information to your local OEM vehicle service department to obtain a new Bendix ESP EC-80 ECU. The OEM service department will install the same parameter set in the new Controller that was loaded into the original ECU at the vehicle OEM assembly facility.

INSTALLING A NEW BENDIX ESP EC-80 CONTROLLER



When replacing the Bendix ESP EC-80 Controller, verify with the OEM service department that the unit you are installing has the correct parameter set. Failure to do so could result in a loss of features or degraded ESP performance.

For further information, contact either the vehicle manufacturer, Bendix, or your local authorized Bendix distributor.

1. Position and secure the Bendix ESP EC-80 Controller in the original mounting orientation using the mounting bolts retained during removal. Use no more torque than is necessary to firmly secure the ECU into position. Over-tightening the mounting hardware can cause damage to the Bendix ESP EC-80 Controller.
2. Reconnect the electrical connectors to the Bendix EC-80 Controller.
3. Apply power and monitor the Bendix ESP EC-80 Controller power-up sequence to Verify the proper system operation.

See *Troubleshooting: Wiring section beginning on page 45* for more information on wire harnesses.



The Bendix ESP system with the EC-80 Controller is validated with specific Bendix® brand components. Always use Bendix brand replacement parts to prevent compromising system performance. Bendix is not able to validate the safe and reliable use of substitute or alternate components that may be available from other manufacturers, since suppliers of a non-Bendix brand ABS component may implement design changes in their component (without the knowledge or approval of Bendix) which could negatively affect antilock system reliability and braking performance issues.

STEERING ANGLE SENSOR MAINTENANCE

Service Checks:

1. Check all wiring and connectors. Some installations also include an intermediate connector from the steering angle sensor to the main vehicle wire harness. Make sure all connections are free from visible damage.
2. Examine the sensor. Make sure the sensor, its mounting screws, and the interface between the hub and the steering column are not damaged.

Diagnostics:

The Bendix® brand steering angle sensor is only operational in conjunction with a Bendix® ESP® EC-80™ Controller. No independent diagnostics can be performed on the sensor. See pages 38-39 for Diagnostic Trouble Codes (DTCs) associated with this device.

Removal:

1. Remove steering column sheathing.
2. Depending upon manufacturer, the steering angle sensor could be located either near the steering wheel, necessitating the removal of the steering wheel, or near the joint to the vehicle steering mechanism, necessitating the disconnection of this linkage.
3. Unplug sensor cable assembly from body of sensor. Squeeze the mounting tabs and pull gently on the connector until it disengages.
4. Unscrew all three of the mounting screws that hold the body of the sensor to the steering column body.
5. Slide the sensor over the column to remove. Take note if the sensor label is facing upward or downward.

Installation:

1. Obtain a new sensor. The sensor is not repairable in the field.
2. Slide the sensor over the column. The center hub of the sensor must be aligned with the corresponding notch in the column. Different column manufacturers may implement this hub alignment in different ways. The sensor label should be facing in the same direction as the removed sensor.

3. Assemble to column non-moving plate with three self-locking screws.
4. Tighten screws to steering column manufacturer's recommended torque specification.
5. Reconnect the connector. Ensure that there will be no force applied to the sensor because the connector is pulling on the sensor body.
6. If the wire harness leading to the sensor is being replaced, ensure that it is adequately tie wrapped so that the full motion of the steering column can be achieved without pulling apart the connectors.
7. Reinstall the column sheathing. The sensor is not protected against dirt or water intrusion, so care must be taken not to introduce these elements during installation.

STEERING ANGLE SENSOR CALIBRATION

The steering angle sensor calibration can only be achieved when the sensor is powered by the Bendix ESP EC-80 Controller. No stand-alone sensor calibration can be carried out. The calibration procedure is performed using Bendix® ACom® Diagnostic software V6.7.2.5 or higher. See "Troubleshooting Diagnostic Trouble Codes: Steering Angle Sensor (Bendix® SAS-60™)" for the calibration procedure using this tool. The sensor must be recalibrated using ACom Diagnostic Software after any of these situations:

- Replacement of the steering angle sensor;
- Any opening of the connector hub from the steering angle sensor to the column;
- Any maintenance or repair work on the steering linkage, steering gear or other related mechanism;
- Adjustment of the wheel alignment or wheel track; or
- After an accident that may have led to damage of the steering angle sensor or assembly



If the steering angle sensor is not properly recalibrated as needed, the yaw control system may not function properly, which can result in a loss of vehicle control.

YAW RATE/LATERAL ACCELERATION SENSOR MAINTENANCE



Different generations of yaw rate/lateral acceleration sensors are not compatible. Only replace these sensors with exactly the same device.

Service Checks:

1. Check all wiring and connectors. Make sure all connections are free from visible damage.
2. Examine the sensor. Make sure the sensor, its mounting bolts, and the mounting bracket are not damaged.
3. Check the vent hole in underbody of sensor housing. The vent hole should remain free from paint and debris at all times.

Diagnostics:

The yaw rate sensor is only operational in conjunction with a Bendix® ABS, ATC or ESP® system with the EC-80™ Controller. No independent diagnostics can be performed on the sensor. See pages 40-41 for Diagnostic Trouble Codes associated with this device.

Removal:

1. Unplug the sensor cable assembly from body of sensor. The connector must be twisted and pulled gently to release.
2. In some mounting configurations, the sensor can be removed independently from its mounting bracket. Otherwise, remove entire assembly, then remove sensor from bracket.
3. Take note of the direction in which the connector is pointed.

Installation:

1. Obtain a new sensor. The sensor is not repairable in the field.



The location of the Yaw Rate Sensor on the vehicle, the means of fastening the unit to the vehicle, and the sensor's orientation, MUST NOT BE ALTERED. When servicing, an identical component must be used in the same orientation (using OEM brackets & torque requirements). During installation, follow the OEM leveling guidelines. If any of these requirements are not followed, the Bendix ESP system may not function properly, which can result in incidents leading to loss of vehicle control.

2. Assembly yaw rate sensor housing to mounting bracket. The bracket must be the same design as used on the original vehicle configuration.
3. For Bendix® YAS-60™ Yaw Rate Sensors, the correct fasteners are three M8 size bolts, and the fixing torque should be 20 Nm (± 2 Nm). For Bendix® YAS-70X™ Yaw Rate Sensors, the correct fasteners are two M10 size bolts (1.5 mm pitch angle), or OEM-supplied hardware, and the fixing torque should be 46 Nm (± 9 Nm). Note that the Bendix YAS-70X sensor has two alternate designs, one with an aligning post – see the kit instruction sheet for more information. In all cases, the connector should be facing in the same direction as the removed sensor. The unit must not be installed upside-down where there is a pressure-balancing hole.
4. The sensor should be as level as possible and parallel to the road surface when installed on the vehicle.
5. Reconnect the connector. Ensure that there will be no force applied to the sensor because the connector is pulling on the sensor body.



When removing or installing the sensor, care must be used to prevent damage. Do not strike or pry the sensor. Do not use an impact tool to install the mounting hardware.

Sensor Location Modifications

The location and orientation of the Yaw Rate Sensor must not be altered. When servicing, an identical component must be used in the same orientation (using OEM brackets & torque requirements). During installation follow the OEM leveling guidelines.

Yaw Rate Sensor Calibration:

The yaw rate sensor calibration can only be achieved via the Bendix ESP system with the EC-80 Controller. The sensor must be recalibrated after any of these situations:

- Replacement of the sensor
- After an accident that may have led to damage of the yaw rate sensor

The calibration procedure is performed using Bendix® ACom® Diagnostic Software V6.7.2.5 or higher.

See “Troubleshooting Diagnostic Trouble Codes: Yaw Rate Sensor” for the calibration procedure.

BRAKE DEMAND SENSOR CALIBRATION

Calibration must be performed under the following conditions:

- After servicing any pressure sensor related Diagnostic Trouble Codes (DTCs)
- Replacement of any sensor

The calibration procedure is performed using Bendix® ACom® Diagnostic Software V6.7.2.5 (or higher).

See *“Troubleshooting Diagnostic Trouble Codes: Brake Demand Sensor/Load Sensor”* for the calibration procedure.

PRESSURE SENSOR INSTALLATION REQUIREMENTS

Service Checks:

1. Check all wiring and connectors. Make sure all connections are free from visible damage.
2. Examine the sensor. Make sure the sensor and its interface to the pressure location are not damaged.

Diagnostics:

See the test diagram supplied by the Bendix ACom Diagnostic Software. The pressure sensor can be independently diagnosed when supplied with a five volt voltage supply to the B location and ground to the A location shown in the test diagram. Signal output on the C location should read approximately 0.5V if there is no pressure applied. The signal output should increase proportionately as pressure is applied, up to a maximum of 4.5V at 150 psi.

Removal:

1. Unplug sensor cable assembly from body of sensor. Pull gently on the mounting tab and connector until it disengages.
2. Remove sensor from its pressure mounting using approved air brake push in fitting tools.

Installation:

1. Obtain a new sensor. The sensor is not repairable in the field.
2. Insert sensor into pressure fitting using approved tools.
3. Reconnect the connector. Ensure that there will be no force applied to the sensor because the connector is pulling on the sensor body.
4. If the wire harness leading to the sensor is being replaced, ensure that it is adequately tie wrapped.

Pressure Sensor Calibration:

There is no need for pressure sensor calibration as long as the part replaced is identical to the part removed and a component approved for use with the Bendix® ESP® system with EC-80™ Controllers. However, replacement of brake demand sensors or clearing of demand pressure sensor related DTCs require the following:

1. Use Bendix ACom Diagnostic Software V6.7.2.5 (or higher) to clear the active pressure sensor DTC.
2. Carrying out the demand pressure sensor initialization procedure which involves applying service brakes of 90 psi or greater for three (3) seconds (while stationary).

Once this procedure is carried out successfully, if there are no other active DTCs, the ATC/ESP indicator lamp will no longer be illuminated.

Troubleshooting: Blink Codes and Diagnostic Modes

ELECTRONIC CONTROL UNIT (ECU) DIAGNOSTICS

The Bendix® ESP® EC-80™ Controller contains self-testing diagnostic circuitry that continuously checks for the normal operation of internal components and circuitry, as well as external ABS components and wiring.

Active Diagnostic Trouble Codes (DTCs)

When an erroneous system condition is detected, the Bendix ESP EC-80 Controller:

1. Illuminates the appropriate indicator lamp(s) and disengages part or all of the Bendix ABS, ATC and ESP system functions. (See *ABS Partial Shutdown, on page 15.*);
2. Places the appropriate DTC information in the Electronic Control Unit (ECU) memory; and
3. Communicates the appropriate DTC information over the serial communications diagnostic link as required. Hand-held or PC-based diagnostic tools attach to the vehicle diagnostic connector, typically located on or under the dash (see Figure 14).



FIGURE 14 - TYPICAL VEHICLE DIAGNOSTIC CONNECTOR LOCATIONS (J1939)

BLINK CODES

Blink codes allow a technician to troubleshoot ABS problems without using a hand-held or PC-based diagnostic tool. Instead, information about the ABS system is communicated by the Bendix ESP EC-80 Controller using the ABS indicator lamp to display sequences of blinks.

Note: The Bendix ESP EC-80 Controller will not enter the diagnostic blink code mode if the wheel speed sensors show that the vehicle is in motion. If the ECU is in the diagnostic blink code mode and then detects vehicle motion, it will exit the blink code mode.

In addition, by operating the Blink Code Switch as described below, one of several diagnostic modes can be entered. See Diagnostic Modes below.

Blink Code Switch Activation

When activating the Blink Code Switch:

1. Wait at least two seconds after “ignition on.” (Except when entering Reconfiguration Mode - see *System Reconfiguration section on page 16.*)
2. For the Bendix ESP EC-80 Controller to recognize that the switch is activated “on,” the technician must press for at least 0.1 seconds, but less than five (5) seconds. (If the switch is held for more than five (5) seconds, the ECU will register a malfunctioning switch.)
3. Pauses between pressing the switch when a sequence is required, (e.g. when changing mode) must not be longer than two (2) seconds.
4. After a pause of three-and-a-half (3.5) seconds, the ECU will begin responding with output information blinks. See Figure 15 for an example.

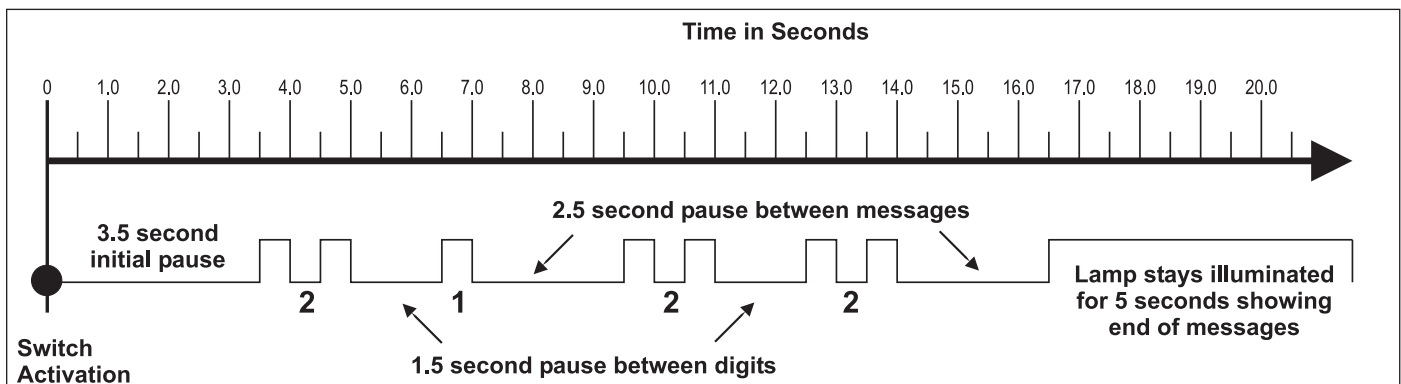

FIGURE 15 - EXAMPLE OF A BLINK CODE MESSAGE

Blink Code Timing

The Bendix® ESP® EC-80™ Controller responds with a sequence of blink codes. The overall blink code response from the Electronic Control Unit (ECU) is called a “message.” Each message includes, depending on the mode selected by the technician, a sequence of one or more groups of blinks. Simply record the number of blinks for each sequence and then use the troubleshooting index on page 26 for active or inactive Diagnostic Trouble Codes (DTCs) and you will be directed to the page that provides troubleshooting information.

NOTE:

1. Sequences of blinks illuminate the ABS indicator lamp for half a second, with half-second pauses between them.
2. Pauses between blink code digits are one-and-a-half (1.5) seconds.
3. Pauses between blink code messages are two-and-a-half (2.5) seconds.
4. The lamp remains on for five (5) seconds at the end of messages.

Once the ABS indicator lamp begins displaying a sequence of codes, it continues until all blink code messages have been displayed and then returns to the normal operating mode. During this time, the Bendix ESP EC-80 Controller will ignore any additional Blink Code Switch activation.

All DTCs, with the exception of voltage and J1939 DTCs, will remain in an active state for the remainder of the power cycle.

Voltage DTCs will clear automatically when the voltage returns within the required limits. All Bendix ABS functions will be re-engaged.

J1939 DTCs will clear automatically when communications are re-established.

DIAGNOSTIC MODES

In order to communicate with the Bendix ESP EC-80 Controller, there are several modes that the technician can select to allow information to be retrieved, or other ECU functions to be accessed.

Diagnostic Modes

To enter the various diagnostic modes:

No. of Times to Press the Blink Code Switch	System Mode Entered
1	Active Diagnostic Trouble Code (DTC) Retrieval
2	Inactive DTC Retrieval
3	Clear Active DTCs
4	System Configuration Check
5	Dynamometer Test
7*	Reconfigure ECU

* To enter the Reconfiguration Mode, the switch must be held in before the application of ignition power. Once the power is supplied, the switch is released and then pressed seven times.

FIGURE 16 - DIAGNOSTIC MODES

Active Diagnostic Trouble Code Mode

For troubleshooting, typically the Active and Inactive DTC Retrieval Modes are used. The technician presses the Blink Code Switch once and the ABS indicator lamp flashes a first group of two codes, and if there are more DTCs recorded, this is followed by a second set of codes, etc. (See page 26 for a directory of these codes.) All active DTCs may also be retrieved using a hand-held or PC-based diagnostic tool, such as the Bendix® ACom® Diagnostic Software.

To clear active DTCs (as problems are fixed), simply clear (or “self-heal”) by removing and re-applying ignition power. The only exception is for wheel speed sensor DTCs, which clear when power is removed, re-applied, and the ECU detects valid wheel speed from all wheel speed sensors. Alternately, codes may be cleared by pressing the diagnostic Blink Code Switch three (3) times (to enter the Clear Active Diagnostic Trouble Code Mode) or by using a hand-held or PC-based diagnostic tool. Hand-held or PC-based diagnostic tools are able to clear wheel speed sensor DTCs without the vehicle being driven.

Inactive Diagnostic Trouble Code Mode

The Bendix® ESP® EC-80™ Controller stores past Diagnostic Trouble Codes (DTCs) and comments (such as configuration changes) in its memory. This record is commonly referred to as “event history.” When an active DTC is cleared, the Electronic Control Unit (ECU) stores it in the event history memory as an inactive DTC.

Using blink codes, the technician may review all inactive DTCs stored on the ECU. The ABS indicator lamp will display inactive diagnostic blink codes when the diagnostic Blink Code Switch is depressed and released two times. *See page 26 for the index showing DTCs and the troubleshooting guide page to read.*

Inactive DTCs, and event history, may be retrieved and cleared by using a hand-held or PC-based diagnostic tool, such as the Bendix® ACom® Diagnostic Software.

Clearing Active DTCs

The ECU will clear active DTCs when the diagnostic Blink Code Switch is depressed and released three (3) times.

System Configuration Check Mode

The ABS indicator lamp will display system configuration information when the diagnostic Blink Code Switch is depressed and released four times. The lamp will blink out configuration information codes using the following patterns. *(See Figure 17).*

In this mode the ECU tells the technician – by means of a series of seven (7) blink codes – the type of ABS system that the ECU has been set up to expect. For example, if the fourth blink code is the number two (2), the technician knows that a 6S/4M sensor/modulator configuration has been set.

Dynamometer Test Mode

The Dynamometer Test Mode is used to disable Bendix® ESP® & ATC system functions when needed (e.g. when performing any vehicle maintenance where the wheels are lifted off the ground and moving, including dynamometer testing). **Note: For Bendix ESP and ABS EC-80 Controllers, this mode will remain engaged even if power to the ECU is removed and re-applied.** To exit the Dynamometer Test Mode, press and release the Blink Code Switch three (3) times, or use a hand-held or PC-based diagnostic tool.

1st Number	System Power
1	12 Volts
2nd Number	Wheel Speed Sensors
4	4 Sensors
6	6 Sensors
3rd Number	Pressure Modulator Valves
4	4 Modulators
5	5 Modulators
6	6 Modulators
4th Number	ABS Configuration
1	4S/4M or 6S/6M
2	6S/4M
3	6S/5M
5th Number	Traction Control Configuration
2	No ATC
3	ATC Engine Control Only
4	ATC Brake Control Only
5	Full ATC (Engine Control & Brake Control)
6th Number	Retarder Configuration
1	No Retarder
2	J1939 Retarder
3	Retarder Relay
4	J1939 Retarder, Retarder Relay
7th Number	Stability Configuration
1	No Stability Program
2	Electronic Stability Program (ESP)

FIGURE 17 - SYSTEM CONFIGURATION CHECK

Reconfigure ECU Mode

Controller reconfiguration is carried out by using the Reconfigure ECU Mode. *(See page 16.)*

Note: To enter the Reconfiguration Mode, the Blink Code Switch must be held in before the application of ignition power. Once the power is supplied, the switch is released and then pressed seven times.

Other Methods

Troubleshooting and DTC clearing (as well as reconfiguration) may also be carried out using hand-held or PC-based diagnostic tools such as the Bendix® Remote Diagnostic Unit (RDU™), Bendix ACom Diagnostic Software, or similar tools.

Troubleshooting: Using PC-Based or Hand-Held Diagnostic Tools

BENDIX® ACOM® DIAGNOSTIC SOFTWARE

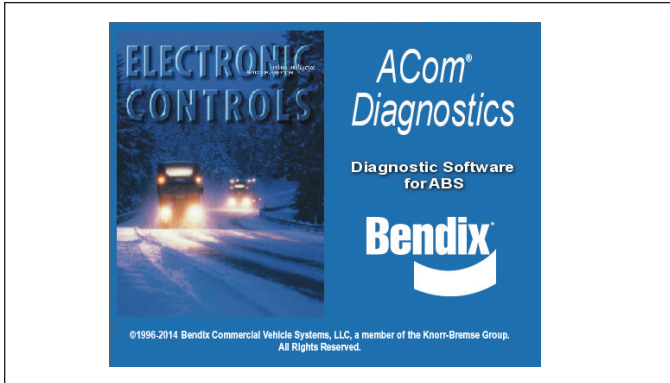

FIGURE 18 - BENDIX® ACOM® DIAGNOSTICS

Bendix® ACom® Diagnostic Software is a PC-based program and is designed to meet RP-1210 industry standards developed by the Truck Maintenance Council (TMC). This software provides the technician with access to all the available Bendix® EC-80™ ESP® Controller's diagnostic information and configuration capability, including:

- ECU information;
- Diagnostic Trouble Codes (DTCs) and repair information;
- Configuration (ABS, ATC, and more);
- Wheel speed information;
- Perform component tests; and
- Save and print information

Note: Bendix ACom Diagnostic Software V6.7.2.5 (or higher) is required to calibrate the Steering Angle Sensor, the Yaw Rate/Lateral Acceleration Sensor, the Brake Demand Sensors and the Load Sensor.

When using ACom Diagnostic Software V6.7.2.5 (or higher) to diagnose the Bendix ESP EC-80 Controller, the computer's serial or parallel port needs to be connected to the vehicle's diagnostic connector.

BENDIX® RDU™ (REMOTE DIAGNOSTIC UNIT)

The Bendix® RDU™ tool (Bendix part number K101596N001) provides the technician with a visual indication of Antilock Braking System (ABS) component Diagnostic Trouble Code (DTC) information. *Note: Previous versions of the RDU tool are not compatible with the Bendix ESP EC-80 Controller.* The Bendix RDU tool is specifically designed for use with Bendix® brand ABS systems and Bendix makes no claims for its operation and/or usability with other brands of ABS systems.

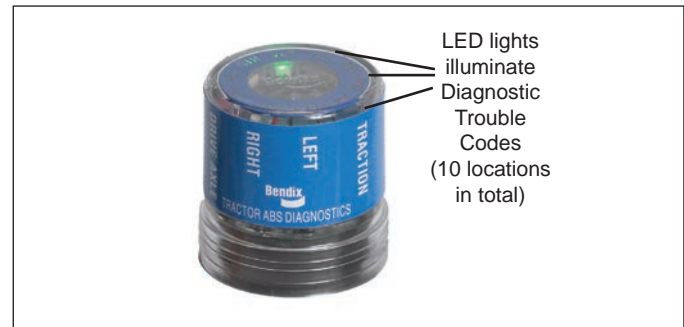

FIGURE 19 - THE BENDIX® REMOTE DIAGNOSTIC UNIT

Features of the Bendix RDU Tool

The Bendix RDU tool attaches to the 9-pin diagnostic connector in the cab of the vehicle.

The Bendix RDU tool allows the technician to:

- Troubleshoot ABS system component problems using DTC reporting via LEDs;
- Reset DTCs on Bendix ESP EC-80 Controllers by holding a magnet over the reset in the center of the RDU tool for less than six (6) seconds; and
- Enter the Self-Configuration Mode used by Bendix ESP EC-80 Controllers by holding a magnet over the reset area for greater than six (6) seconds but less than 30 seconds.

How the Bendix RDU Operates

See Figure 14 for typical vehicle connector locations.

When the Bendix RDU tool is plugged into the diagnostic connector, all the LEDs will illuminate, and the green LED will flash four (4) times to indicate communications have been established.

If the Bendix ESP EC-80 Controller has no active DTCs, only the green LED will remain illuminated.

If the Bendix ESP EC-80 Controller has at least one active DTC, the RDU tool displays the first DTC by illuminating the red LEDs, indicating the malfunctioning ABS component and its location on the vehicle (See Figure 20.) If there are multiple DTCs on the ABS system, the RDU tool will display one DTC first, then – once that DTC has been repaired and cleared – the next code will be displayed.

**Typical Combination
Diagnostic Trouble Codes (DTCs) are:**

- Right steer sensor
 - Left steer sensor
 - Right drive sensor
 - Left drive sensor
 - Right additional sensor
 - Left additional sensor
 - Right steer modulator
 - Left steer modulator
 - MOD red LED illuminated, shows the "Common" connection of one or more modulators is shorted to battery or ground
 - VLT (Flashing indicates either over- or under-voltage condition)
- Right drive modulator
 - Left drive modulator
 - Right additional modulator
 - Left additional modulator
 - Rear Axle Traction modulator
 - ECU
 - Engine serial communication

To pinpoint the root cause and to ensure the system Diagnostic Trouble Code is properly corrected the first time, additional troubleshooting may be necessary.

Note: The Bendix® RDU™ tool is not capable of diagnosing certain Bendix® ESP® EC-80™ system-specific DTCs including additional sensors: steering angle sensors, yaw sensors, pressure sensors, or modulator valves (trailer pressure modulating valves or front axle traction control valves.)

LED DIAGNOSTIC TROUBLE CODES

- | | |
|----------------------|--------------------------------|
| LFT - Left | SEN - Wheel Speed Sensor |
| RHT - Right | MOD - Pressure Modulator Valve |
| DRV - Drive Axle | TRC - Traction Control |
| ADD - Additional | |
| STR - Steer Axle | |
| VLT - Power | |
| ECU - ABS Controller | |

Example: If the Diagnostic Trouble Code is "Right Steer Axle Sensor", the Bendix RDU tool will display one green and three red LEDs



LEDs
Green
VLT
Red
SEN
STR
RHT

FIGURE 20 - DIAGNOSTIC TROUBLE CODES AS DISPLAYED ON THE BENDIX® RDU™ TOOL

Bendix® RDU™ Reset Function

The magnetic reset switch is located in the center top of the Bendix RDU tool. Activation requires a magnet with 30 gauss minimum.

The reset operations are:

1. If the magnet is held over the switch for less than 6 seconds the "clear current DTCs" command is sent.
2. If the magnet is held over the switch for more than 6 seconds, but less than 30 seconds, the Bendix ABS "self-configuration command" is sent.

Additionally, it is recommended at the end of any inspection that the user switches off and restores the power to the Bendix ESP EC-80 Controller, then check the ABS Indicator Lamp operation and Bendix RDU tool to see if they indicate any remaining DTCs.

Bendix RDU Communication Problems

If the Bendix ESP EC-80 Controller does not respond to the RDU tool's request for DTCs, the RDU tool will illuminate each red LED in a clockwise pattern. This pattern indicates the loss of communication and will continue until the Bendix ESP EC-80 Controller responds and communication has been established.

Possible sources of communication problems are:

1. A problem with the J1939 link at the in-cab off-board diagnostic connector (9 or 6 Pin);
2. The Bendix ESP EC-80 Controller does not support PID194;
3. No power is being supplied to the Bendix ESP EC-80 Controller and/or the diagnostic connector;
4. The J1939 bus is overloaded with information and the RDU can not arbitrate access; or
5. A malfunctioning Bendix RDU tool.

Other Information

For more information on Bendix® ACom® Diagnostics Software or RP-1210 compliant tools, go to www.bendix.com or visit your local authorized Bendix distributor.

See pages 56-62 for Appendices showing J1939 SID, FMI, codes and their Bendix blink code equivalents.

www.bendix.com

For the latest information, and for free downloads of the Bendix® ACom® Diagnostic Software, and its User Guide, visit the Bendix website at www.bendix.com.

Bendix Technical Assistance Team

For direct telephone technical support, call the Bendix technical assistance team at:

1-800-AIR-BRAKE (1-800-247-2725 option 2, then 1), Monday through Friday, 8:00 a.m. to 6:00 p.m. ET, and follow the instructions in the recorded message.

E-mail the Bendix Technical Assistance Team at: techteam@bendix.com.

Active or Inactive Diagnostic Trouble Codes (DTCs):

INDEX

How to interpret the first digit of messages received when Active or Inactive Diagnostic Trouble Code Mode is entered.

1st Blink Code Number	Troubleshooting Tests
1.....	No DTCs (1,1)
2.....	Wheel Speed Sensors - pages 27-28
3.....	Wheel Speed Sensors - pages 27-28
4.....	Wheel Speed Sensors - pages 27-28
5.....	Wheel Speed Sensors - pages 27-28
6.....	Power Supply - page 29
7.....	Pressure Modulator Valves - pages 30-31
8.....	Pressure Modulator Valves - pages 30-31
9.....	Pressure Modulator Valves - pages 30-31
10.....	Pressure Modulator Valves - pages 30-31
11.....	J1939 - pages 32-33
12.....	Miscellaneous - pages 34-35
13.....	ECU - page 36
14.....	Wheel Speed Sensors - pages 27-28
15.....	Wheel Speed Sensors - pages 27-28
16.....	Pressure Modulator Valves - pages 30-31
17.....	Pressure Modulator Valves - pages 30-31
18.....	Drive Axle Traction Control Valve - page 37
19.....	Steer Axle Traction Control Valve - page 37
20....	Trailer Pressure Modulator Valve - pages 30-31
21.....	Steering Angle Sensor - pages 38-39
22.....	Yaw Rate Sensor - pages 40-41
23.....	Lateral Acceleration Sensor - page 42
24.....	Brake Demand/Load Sensors - page 43
25.....	Valves Miscellaneous - page 44
26.....	J1939 ESP-Related - page 45-47

Example: For a message sequence of:

3, 2 12, 4

For the first sequence go to page 27 and
for the second sequence go to page 34.

See Page 56-62 for APPENDIX B: J1939 SPN and FMI Codes and their Bendix Blink Code Equivalents

Troubleshooting Diagnostic Trouble Codes (DTCs): Wheel Speed Sensors

1st. Blink Code	Location
2	Left Steer Axle Sensor
3	Right Steer Axle Sensor
4	Left Drive Axle Sensor
5	Right Drive Axle Sensor
14	Left Additional Axle Sensor
15	Right Additional Axle Sensor

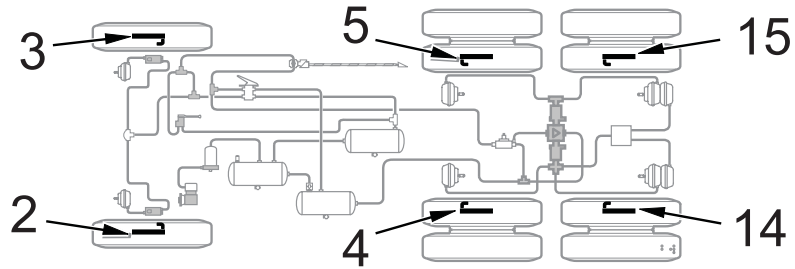

2nd. Blink Code	Diagnostic Trouble Code Description	Repair Information
1	Excessive Air Gap	Adjust the sensor to contact the exciter ring. Rotate the wheel and verify a minimum of 0.25 VAC sensor output at ~ 0.5 RPS. Verify the condition of the sensor head. Verify the mounting of the exciter ring and condition of the teeth. Verify the proper bearing end-play. Verify the condition and retention of the clamping sleeve. Verify the sensor lead routing and clamping.
2	Output Low at Drive-off	Adjust the sensor to contact the exciter ring. Rotate the wheel and verify a minimum of 0.25 VAC sensor output at ~ 0.5 RPS. Verify the condition of sensor head. Verify the mounting of the exciter ring and condition of the teeth. Verify the proper bearing end-play. Verify the condition and retention of the clamping sleeve. Verify the sensor lead routing and clamping. Check for corroded/damaged wiring or connectors between the ECU and the wheel speed sensor.
3	Open or Shorted	Verify 1500 – 2500 ohms is found across the sensor leads. Verify no continuity between the sensor leads and ground or voltage. Verify no continuity between the sensor leads and the other sensors. Check for corroded/damaged wiring or connectors between the Electronic Control Unit (ECU) and the wheel speed sensor.
4	Loss of Sensor Signal	Adjust the sensor to contact the exciter ring. Rotate the wheel and verify a minimum of 0.25 VAC sensor output at ~ 0.5 RPS. Verify the condition of sensor head. Verify the mounting of the exciter ring and condition of the teeth. Verify the proper bearing end-play. Verify the condition and retention of the clamping sleeve. Verify the sensor lead routing and clamping. Check for corroded/damaged wiring or connectors between the ECU and the wheel speed sensor.
5	Wheel End	Verify the mounting of exciter ring and the condition of teeth. Verify the proper bearing end-play. Verify the condition and retention of the clamping sleeve. Verify the sensor lead routing and clamping. Check the mechanical function of brake. Check for kinked or restricted air hoses.
6	Erratic Sensor Signal	Adjust the sensor to contact the exciter ring. Rotate the wheel and verify a minimum of 0.25 VAC sensor output at ~ 0.5 RPS. Verify the condition of sensor head. Verify the mounting of the exciter ring and condition of the teeth. Verify the proper bearing end-play. Verify the condition and retention of the clamping sleeve. Verify the sensor lead routing and clamping. Check for corroded/damaged wiring or connectors between the ECU and the wheel speed sensor.
7	Tire Size Calibration	Verify the correct tire size as desired. Verify the proper tire inflation. Verify the correct number of exciter ring teeth.
10	Configuration Error	The ECU is configured for four sensors, but it has detected the presence of additional sensors. Verify the sensor wiring and the ECU configuration.

Speed Sensor Repair Tests:

1. Take all measurements at the Electronic Control Unit (ECU) harness connector pins in order to check wire harness and sensor. Probe the connector carefully so that the terminals are not damaged.
2. The wheel speed sensor measurements should read:

Location	Measurement
Sensor	1500 - 2500 Ohms
Sensor to voltage or ground	Open Circuit (no continuity)
Sensor output voltage	>0.25 of VAC sensor output at ~ 0.5 revs/sec.

3. Clear the DTC after the issue is corrected. The sensor DTC will remain until the power is cycled to the ABS ECU and vehicle is driven above 15 MPH or the DTC was cleared using either the diagnostic Blink Code Switch or a diagnostic tool.

Cab-mount ECU: Looking into the wire harness connector

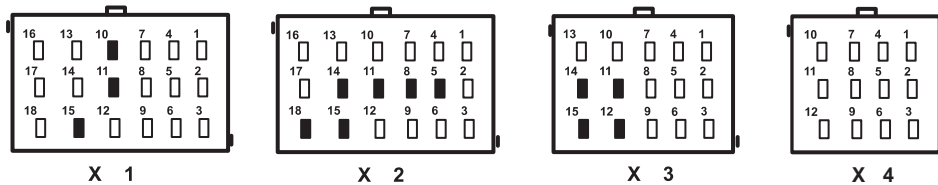

Connector	Pin	Wheel Speed Sensor Location
X1 18 Way	10	Right Drive Axle (+)
	11	Right Drive Axle (-)
X2 18 Way	5	Left Steer Axle (+)
	8	Left Steer Axle (-)
	11	Right Steer Axle (+)
	14	Right Steer Axle (-)
	15	Left Drive Axle (+)
X3 15 Way (if ECU is configured for 6 sensors)	11	Left Additional Axle (+)
	14	Left Additional Axle (-)
	12	Right Additional Axle (+)
	15	Right Additional Axle (-)

Troubleshooting Diagnostic Trouble Codes (DTCs): Power Supply

1st. Blink Code	Location
6	Power Supply

2nd. Blink Code	Diagnostic Trouble Code Description	Repair Information
1	Battery Voltage Too Low	Measure the battery voltage under load. Check the vehicle battery and associated components. Check for damaged wiring. Check for damaged or corroded connectors and connections.
2	Battery Voltage Too High	Measure the battery voltage under load. Ensure that battery voltage is correct for the Electronic Control Unit (ECU). Check the vehicle battery and associated components. Check for damaged wiring. Check for damaged or corroded connectors and connections.

Power Supply Tests:

1. Take all measurements at the ECU harness connector.
2. Place a load (e.g. an 1157 stop lamp) across the battery or ignition and ground connection, measure the ignition and battery voltage with the load. Ignition to Ground should measure between 9 to 17 VDC. Battery to Ground should also measure between 9 to 17 VDC.
3. Check for damaged wiring, damaged or corroded connectors and connections.
4. Check the condition of the vehicle battery and associated components, verify that the ground connection is good and tightened.
5. Check the alternator output for excessive noise.

**Cab-mount ECU:
Looking into wire harness connector**

Connector	Pin	Power Supply Test
X1 18 Way	1	Ground
	3	Ignition
	16	Battery

Troubleshooting Diagnostic Trouble Codes (DTCs): Pressure Modulator Valves (PMVs)

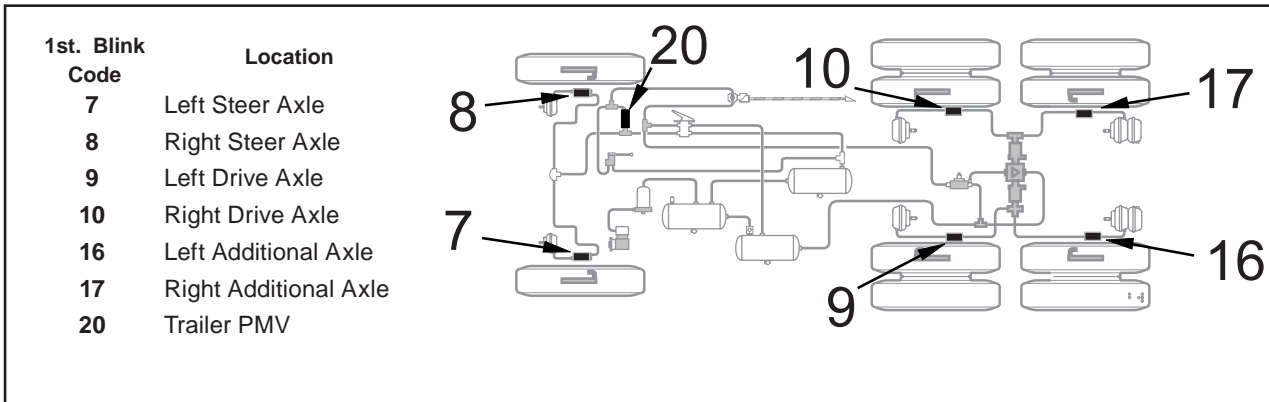

2nd. Blink Code	Diagnostic Trouble Code Description	Repair Information
1	Release Solenoid Shorted to Ground	Verify no continuity between the PMV leads and ground. Verify 4.9 to 5.5 ohms from REL to CMN & HLD to CMN, and 9.8 to 11 ohms from REL to HLD. Check for corroded/damaged wiring or connectors between the Electronic Control Unit (ECU) and PMV.
2	Release Solenoid Shorted to Voltage	Verify no continuity between the PMV leads and voltage. Verify 4.9 to 5.5 ohms from REL to CMN & HLD to CMN, and 9.8 to 11 ohms from REL to HLD. Check for corroded/damaged wiring or connectors between the ECU and PMV.
3	Release Solenoid Open Circuit	Verify 4.9 to 5.5 ohms from REL to CMN & HLD to CMN, and 9.8 to 11 ohms from REL to HLD. Check for corroded/damaged wiring or connectors between the ECU and PMV.
4	Hold Solenoid Shorted to Ground	Verify no continuity between the PMV leads and ground. Verify 4.9 to 5.5 ohms from REL to CMN & HLD to CMN, and 9.8 to 11 ohms from REL to HLD. Check for corroded/damaged wiring or connectors between the ECU and PMV.
5	Hold Solenoid Shorted to Voltage	Verify no continuity between the PMV leads and voltage. Verify 4.9 to 5.5 ohms from REL to CMN & HLD CMN, and 9.8 to 11 ohms from REL to HLD. Check for corroded/damaged wiring or connectors between the ECU and PMV.
6	Hold Solenoid Shorted to Open Circuit	Verify 4.9 to 5.5 ohms from REL to CMN & HLD to CMN, and 9.8 to 11 ohms from REL to HLD. Check for corroded/damaged wiring or connectors between the ECU and PMV.
7	CMN Open Circuit	Verify 4.9 to 5.5 ohms from REL to CMN & HLD to CMN, and 9.8 to 11 ohms from REL to HLD. Check for corroded/damaged wiring or connectors between the ECU and PMV. This is potentially a miswired or internal mechanical problem.
8	Configuration Error	A mis-match exists between the ECU configuration and the modulator installation and wiring. Verify the PMV wiring and installation. Verify the ECU configuration. Special Note regarding Trailer PMV: Pneumatic issues can result in this DTC being set. Verify that all lines are free from debris or other obstructions, kinks, etc.
12	Trailer PMV Hold Function Repair	Check the operation of the trailer stop lamps by observing them during the chuff test performed during start-up (See page 9). Verify that all lines are free from debris or other obstructions, kinks, etc.

Pressure Modulator Valve (PMV) Repair Tests:

1. Take all measurements at the Electronic Control Unit (ECU) harness connector pins in order to check wire harness and PMV. Probe the connector carefully so that the terminals are not damaged.
2. The pressure modulator resistance should read:

Location	Measurement
Release to Common	4.9 to 5.5 Ohms
Hold to Common	4.9 to 5.5 Ohms
Release to Hold	9.8 to 11.0 Ohms
Release, Hold, Common to Voltage or Ground	Open Circuit (no continuity)



When troubleshooting modulator Diagnostic Trouble Codes (DTCs), check inactive DTCs and the event history for over-voltage or excessive noise DTCs. If one of these is found, troubleshoot these DTCs first before the PMV.

Cab-mount ECU: Looking into the wire harness connector

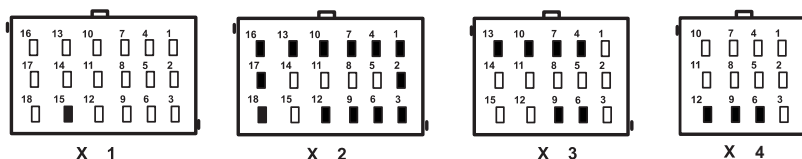

Connector	Pin	PMV Location
X2 18 Way	1	Left Steer Axle Hold
	2	Left Steer Axle Release
	3	Left Steer Axle Common
	4	Right Steer Axle Hold
	6	Right Steer Axle Common
	7	Right Steer Axle Release
	9	Right Drive Axle Common
	10	Right Drive Axle Hold
	13	Right Drive Axle Release
	12	Left Drive Axle Common
	16	Left Drive Axle Hold
X3 15 Way (if the ECU is configured for 6 modulators)	4	Left Additional Axle Hold
	6	Left Additional Axle Common
	7	Left Additional Axle Release
	9	Right Additional Axle Common
	10	Right Additional Axle Hold
X4 12 Way	13	Right Additional Axle Release
	6	Trailer PMV Hold
	9	Trailer PMV Release
	12	Trailer PMV Common

Troubleshooting Diagnostic Trouble Codes (DTCs): J1939 Serial Communications

1st. Blink Code	Location:		
11	J1939		
2nd. Blink Code	Diagnostic Trouble Code Description	Repair Information	
1	J1939 Serial Link	There is loss of communications between the Bendix® ESP® EC-80™ Controller and other devices connected to the J1939 link. Check for damaged or reversed J1939 wiring. Check for corroded or damaged connectors. Verify the Electronic Control Unit (ECU) configuration. Check for other devices inhibiting J1939 communications.	
2	J1939 Electronic Retarder Time-out or Invalid Signal	Check for damaged or reversed J1939 wiring. Check for corroded or damaged connectors. Verify the presence of a retarder on the J1939 link. Verify the ECU configuration. Verify that the retarder is configured to broadcast ERC1. Check for other devices inhibiting J1939 communications.	
3	J1939 Electronic Engine Controller 1 Time-out or Invalid Signal	Check for damaged or reversed J1939 wiring. Check for corroded or damaged connectors. Verify the presence of ECU on the J1939 link. Verify the ECU configuration. Verify the ECU is configured to broadcast EEC1. Check for other devices inhibiting J1939 communications.	
4	J1939 Electronic Engine Controller 2 Time-out or Invalid Signal	Check for damaged or reversed J1939 wiring. Check for corroded or damaged connectors. Verify the presence of Engine ECU on the J1939 link. Verify the ECU configuration. Verify that there is an EEC2 broadcast from the address configured in the ABS ECU. Check for other devices inhibiting J1939 communications.	
5	J1939 AIR Message Time-out or Invalid Signal	Invalid pressure signals received from a vehicle Controller. Verify the proper operation of brake demand sensors. Check wiring between brake demand sensors and the vehicle Controller. Verify the proper programming of vehicle Controller. Check for damaged or reversed J1939 wiring. Check for damaged or corroded connectors. Check for other device inhibiting J1939 communications.	
6	ESP J1939 CAN Message Time-out	Invalid ESP messages on the J1939 link. Check for damaged or reversed J1939 wiring. Check for damaged or corroded connectors. Verify the presence of engine and / or retarder on J1939. Verify the proper programming of engine and/or retarder. Check for other devices inhibiting J1939 communications.	
7	J1939 Transmission Communication for HSA	There is loss of communications between the EC-80 ECU and the transmission ECU over the J1939 link. Check for damaged or reversed J1939 wiring. Check for damaged or corroded connectors. Verify the presence of transmission ECU on J1939 link. Check for other devices inhibiting J1939 communications.	
8	Time-out or invalid data on XBR	Check for damaged or reversed J1939 wiring. Check for damaged or corroded connectors. Check for other devices inhibiting J1939 communications. Verify the ECU configuration. Verify XBR message being broadcast from address 42.	
10	J1939 Electronic Transmission Controller 1 Time-out or Invalid Signal	There is loss of communications between the Bendix EC-80 Controller and the transmission ECU over the J1939 link. Check for damaged or reversed J1939 wiring. Check for corroded or damaged connectors. Verify the presence of engine ECU on the J1939 link. Verify the ECU configuration. Check for other devices inhibiting J1939 communications.	
11	AUXIO CAN message Time-out	Check for damaged or reversed J1939 wiring. Check for damaged or corroded connectors. Check for other devices inhibiting J1939 communications. Verify the ECU configuration. Verify AUX IO broadcast from address configured in EC-80 ECU.	
12	J1939 Hill Start Feature Switch Signal Not Available	Check for damaged or reversed J1939 wiring. Check for damaged or corroded connectors. Verify the ECU configuration. Verify EBC1 being broadcast with a valid SPN 577 parameter. Check for other devices inhibiting J1939 communications.	
14	J1939 CAN Message related to ESP is incomplete	Check for damaged or reversed J1939 wiring. Check for damaged or corroded connectors. Check for other devices inhibiting J1939 communications. Verify the ECU configuration. Verify ESP messages.	

2nd. Blink Code	Diagnostic Trouble Code Description	Repair Information
15	J1939 Electronic Engine Controller 3 Time-out or Invalid Signal	There is loss of communications between the Bendix® ESP® EC-80™ Controller and the engine Electronic Control Unit (ECU) over the J1939 link. Check for damaged or reversed J1939 wiring. Check for corroded or damaged connectors. Verify the presence of engine ECU on the J1939 link. Verify the ECU configuration. Check for other devices inhibiting J1939 communications.
16	J1939 Electronic Transmission Controller 2 Time-out	There is loss of communications between the Bendix EC-80 Controller and the transmission ECU over the J1939 link. Check for damaged or reversed J1939 wiring. Check for corroded or damaged connectors. Verify the presence of engine ECU on the J1939 link. Verify the ECU configuration. Check for other devices inhibiting J1939 communications..
20	J1939 EAC1 Time-out or Invalid Signal	Verify 60 ohms of resistance between X1 pin 7 and X1 pin 8. Check for damaged or reversed J1939 wiring. Check for damaged or corroded connectors. Verify that the message is being transmitted. Verify data for Electronic Axle Controller 1 is correct. Verify the ECU configuration.
21	CAN Message CGW_C1 Time-out or invalid signal	Verify 60 ohms of resistance between X1 pin 7 and X1 pin 8. Check for damaged or reversed J1939 wiring. Check for damaged or corroded connectors. Verify that the message is being transmitted. Verify that the data for differential lock(s) is correct. Verify the ECU configuration.
22	CAN Message ASC1_CLCS Time-out or invalid signal	Verify 60 ohms of resistance between X1 pin 7 and X1 pin 8. Check for damaged or reversed J1939 wiring. Check for damaged or corroded connectors. Verify that the message is being transmitted. Verify that the data for Air Suspension Control 1 is correct. Verify the ECU configuration.
23	J1939 CCVS Time-out or Invalid Signal	Verify 60 ohms of resistance between X1 pin 7 and X1 pin 8. Check for damaged or reversed J1939 wiring. Check for damaged or corroded connectors. Verify message is being transmitted. Verify the ECU configuration.
24	J1939 TCO (Tachograph) Time-out	Verify 60 ohms of resistance between X1 pin 7 and X1 pin 8. Check for damaged or reversed J1939 wiring. Check for damaged or corroded connectors. Verify message is being transmitted. Verify the ECU configuration.
26	J1939 Address Conflict ABS Address	Verify only one ABS ECU is connected on J1939 bus, broadcasting OBh (equals 13 decimal).
27	J1939 Address Conflict TPMS Address	Verify only one TPMS ECU is connected on J1939 bus, broadcasting 33h.
28	J1939 Proprietary XBR Message Out of Range	Verify 60 ohms of resistance between X1 pin 7 and X1 pin 8. Check for damaged or reversed J1939 wiring. Check for damaged or corroded connectors. Check for messages being transmitted/received.
29	J1939 CAN Messages Are Not Being Transmitted/Received	Verify 60 ohms of resistance between X1 pin 7 and X1 pin 8. Check for damaged or reversed J1939 wiring. Check for damaged or corroded connectors. Check for messages being transmitted/received.

J1939 Troubleshooting Tests:

1. Take all measurements at ECU harness connector.
2. Check for damaged or reversed J1939 wiring.
3. Check for corroded or damaged wiring connector problems such as (opens or shorts to voltage or ground).
4. Check for other J1939 devices which may be loading down (inhibiting) J1939 communication.

Cab-mount ECU:

Looking into wire harness connector

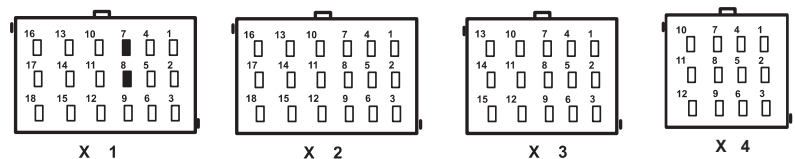

Connector	Pin	J1939
X1	7	J1939 Low
18 Way	8	J1939 High

Troubleshooting Diagnostic Trouble Codes (DTCs): Miscellaneous

1st. Blink Code 12	Location: Miscellaneous	
2nd. Blink Code	Diagnostic Trouble Code Description	Repair Information
1	Stop Lamp Switch Not Detected	The Electronic Control Unit (ECU) has not detected the presence of the stop lamp switch since ignition power was applied (note that stop lamp switch input may be applied to the Bendix® ESP® EC-80™ Controller using either hard-wire input or J1939). Apply and release service brake. Check for brake switch input into ECU (<i>see system wiring schematic</i>). With service brake released, check for presence of the stop lamp bulb. With service brake applied, verify system voltage is now present at the stop lamp switch input to the ECU. Check for damaged wiring between ECU, stop lamp switch and bulb. Check for corroded or damaged connectors. Check for damaged or reversed J1939 wiring. Check for corroded or damaged connectors on J1939 link. Verify the presence of engine ECU on the J1939 link. Verify the ECU configuration.
2	Stop Lamp Switch Defective	Apply and release service brake. Check for brake switch input into ECU (<i>see system wiring schematic</i>). With service brake released, check for presence of the stop lamp bulb. With service brake applied, verify system voltage is now present at the stop lamp switch input to the ECU. Check for damaged wiring between ECU, stop lamp switch and bulb. Check for corroded or damaged connectors. Check for damaged or reversed J1939 wiring. Check for corroded or damaged connectors on J1939 link. Verify the presence of engine ECU on the J1939 link. Verify the ECU configuration.
3	ATC or ESP Disabled or Dynamometer Test Mode Active	ATC or ESP is disabled. ECU has been placed in the Dynamometer Test Mode by either the diagnostic Blink Code Switch or a hand-held or PC-based diagnostic tool. Clear DTCs to exit Dynamometer Test Mode.
4	Retarder Relay Open Circuit or Shorted to Ground	Verify vehicle contains a retarder relay. Verify the ECU configuration. Check wiring between ECU and retarder relay. Verify no continuity between retarder disable output of Bendix ESP EC-80 Controller and ground. Verify condition and wiring of the retarder relay.
5	Retarder Relay Circuit Shorted to Voltage	Check wiring between ECU and retarder relay. Verify no continuity between retarder disable output of Bendix ESP EC-80 Controller and voltage. Verify condition and wiring of the retarder relay.
6	ABS Indicator Lamp Circuit DTC	Check operation of diagnostic Blink Code Switch. Check wiring of diagnostic Blink Code Switch (verify ABS wire is not grounded where used) and ABS Indicator Lamp. Verify ABS Indicator Lamp ground input. On some vehicles with multi-plex dashes, the ground wire may not be present - <i>see ECU 19 DTC</i> .
7	PMV Common Shorted to Ground	Verify no continuity between the Release, Hold and CMN of all Pressure Modulator Valves (PMVs), Traction Control Valve (TCV), HSA, Diff Lock Solenoid and ground. Check for corroded/damaged wiring or connectors between the ECU and CMN of all PMVs, TCV, and Diff Lock Solenoid. <i>See the extended troubleshooting for this code in Appendix A.</i>
8	PMV Common Shorted to Voltage	Verify no continuity between the Release, Hold and CMN of all PMVs, TCV, HSA, Diff Lock Solenoid and voltage. Check for corroded/damaged wiring or connectors between the ECU and CMN of all PMVs, TCV, and Diff Lock Solenoid.
9	ATC Disabled to Prevent Brake Fade	The Bendix® ATC (Automatic Traction Control) system is temporarily disabled to prevent excessive heating of the foundation brakes.
11	Wheel Speed Sensors Reversed on an Axle	Sensors are reversed (left to right) on one of the axles. Verify the proper installation, connection, and wiring of the sensors.
14	Sensor CAN Supply Voltage Error	Incorrect supply voltage for the Steering Angle Sensor (SAS) and the Yaw Rate sensor. Verify the proper voltage at the sensor connectors. Verify the wiring between the ECU and the sensors. Verify the proper output voltage from ECU. <i>Note: When checking for voltage at YAW/LAS & SAS, the voltage will only be present momentarily at key ON.</i>
17	ABS disabled due to off-road mode	The ABS indicator lamp will be flashing, indicating the ECU is in the off-road ABS mode. Remove and re-apply ignition power.
19	Maximum number of PMV cycles exceeded	Replace all PMV valves and clear the DTC.

2nd. Blink Code	Diagnostic Trouble Code Description	Repair Information
20	Maximum Number of TCV Cycles Exceeded	Replace all Traction Control Valve (TCV) valves and clear the Diagnostic Trouble Code (DTC).
22	ESP Sensor Voltage Out of Range	Incorrect supply voltage is detected for the Bendix® SAS-60™ and the Yaw Rate sensor. Verify the proper voltage at sensor connectors. Verify wiring between the Electronic Control Unit (ECU) and the sensors. Verify the proper output voltage from ECU. <i>Note: When checking for voltage at YAW/LAS & SAS, the voltage will only be present momentarily at key ON.</i>
24	HS Feature Lamp Open or Shorted to Ground	Verify no continuity between the Hill Start / Hill Start Assist lamp and ground. Verify continuity between the lamp and the ECU. Check the wiring between the lamp and the ECU. Check the lamp and the condition of its wiring.
25	HS Feature Solenoid Open or Shorted to Ground	The Hill Start / Hill Start Assist solenoid is shorted to ground or has a broken wire. Verify no continuity between the solenoid and ground. Check for corroded/damaged wiring or connectors between the ECU and the solenoid.
26	HS Feature Solenoid Shorted to Voltage	Verify no continuity between the Hill Start / Hill Start Assist Solenoid and voltage. Check for corroded/damaged wiring or connectors between the ECU and Solenoid.
27	Brake Lamp Input Mismatch With Brake Lamp Output	There is a brake lamp input mismatch with the brake lamp output.
28	Air system/ Mechanical Component	Verify brakes are operating correctly. Verify that there is not over-braking at one or more wheel end(s). Check the pneumatic plumbing and the exhaust port of the PCVs, TCVs, and relay valves and confirm that the air is being exhausted from all brake chambers. Verify tire sizes on the vehicle match the ABS ECU configuration. Verify wheel speed sensors and tone ring are properly adjusted and in good condition.
29	Air system/ Mechanical Component	Verify that the tires are in good condition. Verify that no pneumatic hoses are twisted or kinked. Verify that the brakes are operating correctly. Verify that the wheel speed sensor and tone ring are properly adjusted. Verify tire size.
30	ESP Disabled due to Off Road Mode	Electronic Stability has been disabled due to the vehicle being in the ABS or ATC off road mode. Cycle ABS Off Road or ATC Mud snow switch.
31	HS Feature Lamp Shorted to Voltage	Verify that there is no resistance measured between the battery and HSA lamp output of the ECU. Check the wiring between the ECU and the Hill Start / Hill Start Assist lamp. Check the lamp and condition of its wiring.
32	I/O 2 or 3 Shorted High (EC-80-ATC) OR I/O 2 or 3 shorted High or Stop Lamp Output error (ESP EC-80)	Check for a short-circuit condition between voltage and the I/O 2 and I/O 3 circuits.
33	HS Feature Solenoid Open Circuit	Verify resistance across the Hill Start / Hill Start Assist solenoid. Check the ECU and HSA solenoid for corroded or damaged wiring and/or connectors.
34	eTrac Valve Solenoid Shorted to Voltage	Verify the resistance between voltage and the Bendix® eTrac™ solenoid is open. Check for corroded or damaged wiring or connectors between the ECU and the eTrac solenoid.
35	eTrac Valve Solenoid Shorted to Ground	Verify the resistance between ground and the Bendix eTrac solenoid is open. Check for corroded or damaged wiring or connectors between the ECU and the eTrac solenoid.
36	Reserved	Reserved
38	Invalid ABS Warning Lamp Configuration	Check X1-12 if pin/wire installed. X2-12 should have no terminal or connection. ABS Warning Lamp is controlled via J1939.

Troubleshooting Diagnostic Trouble Codes (DTCs): ECU

1st. Blink Code 13		Location: ECU	
2nd Blink Code	Diagnostic Trouble Code Description (With HEX designation)	Repair Information	
1	ECU DTC (5FC)	Check for damaged or corroded connectors. Check for damaged wiring. Clear Diagnostic Trouble Codes (DTCs). If DTCs return, contact the Bendix Tech Team at 1-800-AIR-BRAKE (1-800-247-2725, option 2, then 1) for further troubleshooting assistance.	
2	ECU DTC (5CD)		
3	ECU DTC (10)		
4	ECU DTC (2678C)		
5	ECU DTC (1C)		
6	ECU DTC (6CD)		
7	Configuration mismatch	Verify components installed match the Electronic Control Unit (ECU) configuration.	
8	ECU DTC (56)	Check for damaged or corroded connectors. Check for damaged wiring. Clear DTCs. If DTCs return, contact the Bendix Tech Team at 1-800-AIR-BRAKE (1-800-247-2725, option 2, then 1) for further troubleshooting assistance.	
9	ECU DTC (CAC3)		
10	ECU DTC (5F3)		
11	ECU DTC (F1A)		
12	ECU DTC (F14)		
13	Configuration mismatch	Verify components installed match ECU configuration.	
14	ECU DTC (C6)	Check for damaged or corroded connectors. Check for damaged wiring. Clear DTCs. If DTCs return, contact the Bendix Tech Team at 1-800-AIR-BRAKE (1-800-247-2725, option 2, then 1) for further troubleshooting assistance.	
15	ECU DTC (CF)		
16	ECU DTC (C0)		
17	ECU DTC (C8C)		
18	ECU DTC (CC)	Parameter file was not downloaded. To verify that the vehicle specific parameters have been loaded, contact Bendix for more information at 1-800-AIR-BRAKE (1-800-247-2725).	
19	ECU DTC (63)	Check for damaged or corroded connectors. Check for damaged wiring. Clear DTCs. If DTCs return, contact the Bendix Tech Team at 1-800-AIR-BRAKE (1-800-247-2725, option 2, then 1) for further troubleshooting assistance.	
20	ECU DTC (6E)		
21	ECU DTC (6C)		
22	ECU DTC (63C)		
25	ECU Internal VIN Mismatch	The ECU internally-stored VIN does not match the VIN of the vehicle. Ensure that the ECU is installed on the correct vehicle. Verify the ECU programming. Verify engine programming.	
26	Valve Configuration Mismatch	Check for damaged or corroded connectors. Check for damaged wiring. Clear DTCs. If DTCs return, contact the Bendix Tech Team at 1-800-AIR-BRAKE (1-800-247-2725, option 2, then 1) for further troubleshooting assistance.	
28	ECU DTC (7CD)	Check for damaged or corroded connectors. Check for damaged wiring including power and ground wiring. Clear DTCs. If DTCs return, contact the Bendix Tech Team at 1-800-AIR-BRAKE (1-800-247-2725, option 2, then 1) for further troubleshooting assistance.	
29	ECU DTC (5D)		

Troubleshooting Diagnostic Trouble Codes (DTCs): Traction Control Valves (TCV)

1st. Blink Code	Location
18	Drive Axle Traction Control Valve
19	Steer Axle Traction Control Valve

NOTE: When troubleshooting Traction Control Valve DTCs, it may be useful to look for a potential connection between them and ECU DTCs (in particular, DTCs 13-8 and 13-18 shown on page 36).

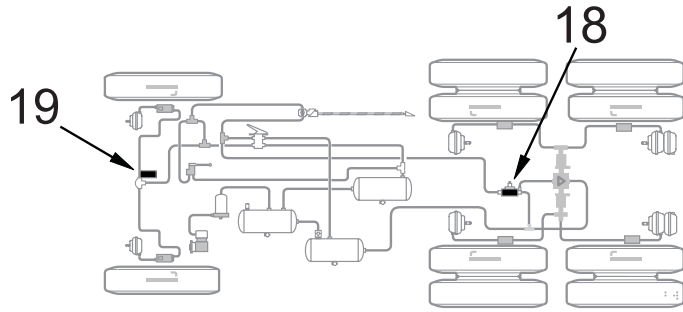

2nd. Blink Code	Diagnostic Trouble Code Description	Repair Information
1	TCV Solenoid Shorted to Ground	Verify 7 to 19 ohms between Traction Control Valve (TCV) and TCV common. Verify no continuity between TCV leads and ground. Check for corroded/damaged wiring or connectors between the ECU and TCV.
2	TCV Solenoid Shorted to Voltage	Verify 7 to 19 ohms between TCV and TCV common. Verify no continuity between TCV leads and voltage. Check for corroded/damaged wiring or connectors between ECU and TCV.
3	TCV Solenoid Open Circuit	Verify 7 to 19 ohms between TCV and TCV common. Check for corroded/damaged wiring or connectors between ECU and TCV.
4	TCV Configuration Error	The ECU is not configured for ESP or ATC, but has detected the presence of a TCV. Verify TCV wiring. Inspect for the presence of a TCV. Verify the ECU configuration.

ATR valve inspections should include: looking for kinked air hoses; inside the harness socket on the valve for removed or corroded connector pins; and a test to verify that the ATC valve solenoids are functioning correctly.

Traction Control Valve (TCV) Repair Tests:

- Take all measurements at ECU harness connector pins in order to check wire harness and traction control valve. Probe the connector carefully so that the terminals are not damaged.
- Traction Control Valve resistance measurements should read:

Location	Measurement
TCV to TCV Common	7 to 19 Ohms
Release, Hold, Common to Voltage or Ground	Open Circuit (no continuity)

Cab-mount ECU: Looking into wire harness connector

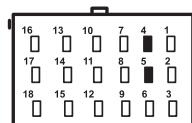

X 1

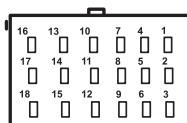

X 2

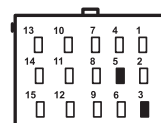

X 3

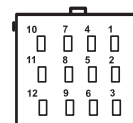

X 4

Connector	Pin	Traction Control Test
X1 18 Way	4	Drive Axle Traction Control Valve Common
	5	Drive Axle Traction Control Valve

Connector	Pin	Traction Control Test
X3 15 Way	3	Steer Axle Traction Control Valve Common
	5	Steer Axle Traction Control Valve

Troubleshooting Diagnostic Trouble Codes (DTCs): Steering Angle Sensor (SAS) [Bendix® SAS-60™ Sensor]

1st. Blink Code 21	Location: Steering Angle Sensor
------------------------------	---

2nd. Blink Code	Diagnostic Trouble Code Description	Repair Information
1	SAS Not Calibrated	Steering Angle Sensor (SAS) has not been calibrated. Perform SAS calibration procedure.
2	SAS Calibration in Progress	SAS calibration procedure is underway.
3	SAS Static Signal	SAS signal incorrect. Verify the proper installation of the SAS. Verify proper wiring between the Electronic Control Unit (ECU) and the SAS. Check SAS output.
4	SAS Signal Out of Range	SAS signal incorrect. Verify the proper installation of the SAS. Verify proper wiring between the ECU and the SAS. Check SAS output. Perform SAS calibration procedure.
5	SAS Signal Reversed	SAS signal is reversed. Verify the proper installation of the SAS. Verify proper wiring between the ECU and the SAS. Check SAS output.
6	SAS Invalid Signal	SAS signal is invalid. Verify the proper installation of the SAS. Verify proper wiring between the ECU and the SAS. Check SAS output. Verify that correct SAS is being used.
7	SAS Gradient Error	SAS signal is invalid. Verify the proper installation of the SAS. Verify proper wiring between the ECU and the SAS. Check SAS output. Verify that correct SAS is being used.
8	SAS CAN Time-out	Loss of CAN communications between the ECU and the SAS. Verify proper wiring between the ECU and the SAS. Check SAS output.
9	SAS Long Term Calibration Error	SAS calibration error. Verify the proper installation of the SAS. Verify proper wiring between the ECU and the SAS. Check SAS output. Verify that correct SAS is being used. Verify proper ECU programming. Perform SAS calibration procedure.
10	SAS Plausibility Check	ECU has detected incorrect SAS signal as compared to the Yaw Rate sensor signal. Verify the proper installation of the SAS. Verify proper wiring between the ECU and the SAS. Check SAS output. Verify that correct SAS is being used. Verify proper ECU programming. Perform SAS calibration procedure.
11	SAS detected but not configured	Verify the ECU is configured for ESP.

Troubleshooting Diagnostic Trouble Codes (DTCs): Steering Angle Sensor (SAS) [Bendix® SAS-60™ Sensor] (continued)

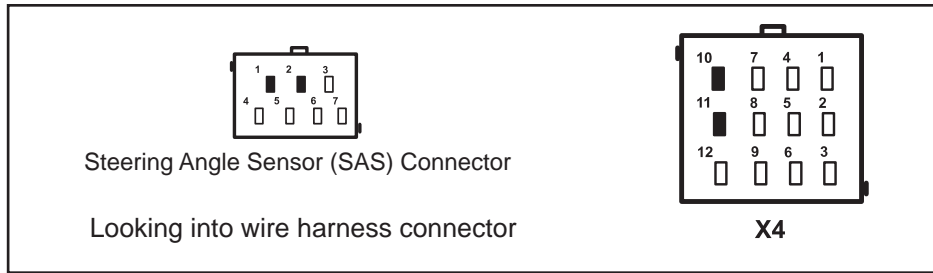

(Note: When checking for voltage at YAW/LAS & SAS, the voltage will only be present momentarily at key ON).

Steering Angle Sensor Tests

1. Measure resistance between input voltage and ground at the sensor wiring harness connector.

Verify continuity between the Electronic Control Unit (ECU) and SAS-60 and Yaw Rate Sensor (typically YAS-70 or YAS-60).

Connector	Pin	Function	
SAS	2	Voltage Input	
	1	Ground Input	
ECU 12 Way	X4	11	Power
		10	Common

2. Verify wiring between the Steering Angle Sensor and the ECU.

SAS Wire Harness Terminal	ECU Wire Harness Terminal	Measurement
4	7	Verify Continuity
3	8	Verify Continuity

3. Verify wiring between the Steering Angle Sensor and power/ground.

SAS Wire Harness Terminal	Measurement
4 to Voltage & Ground	Verify open circuit (no continuity)
3 to Voltage & Ground	Verify open circuit (no continuity)

4. To perform a calibration procedure of the Steering Angle Sensor, Bendix® ACom® Diagnostic Software V6.7.2.5 or higher is required. Using the program, select the “Configuration” option, followed by the “Calibrate” option. The following screen should be displayed.

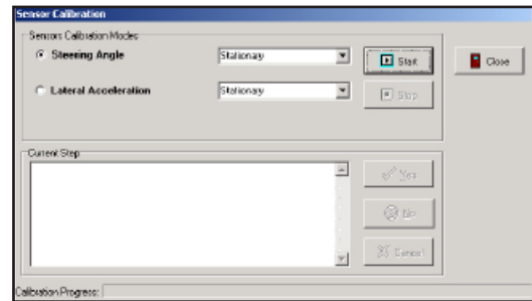

5. Follow the prompts to perform a calibration of the Steering Angle Sensor.
6. To test the Steering Angle Sensor, ACom V6.7.2.5, or higher, is required. Using Bendix ACom V6.7.2.5 or higher, select the “Component Test” option, followed by the “ESP Test” option. The following screen should be displayed.

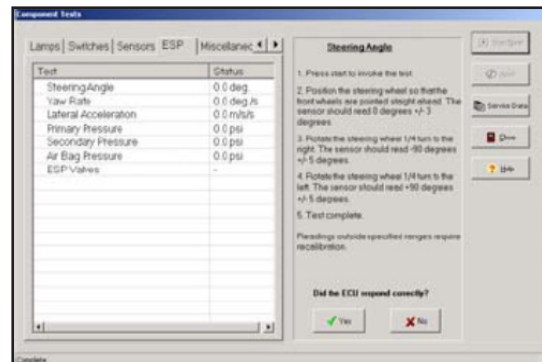

7. Follow the prompts to perform a test of the Steering Angle Sensor.

Troubleshooting Diagnostic Trouble Codes (DTCs): Yaw Rate Sensor (YRS)

1st. Blink Code 22	Location: Yaw Rate Sensor		
2nd. Blink Code	Diagnostic Trouble Code Description	Repair Information	
1	YRS Signal Out of Range	The YRS signal is incorrect. Verify the proper installation of the YRS. Verify proper wiring between the Electronic Control Unit (ECU) and the YRS. Check the YRS output. Perform the YRS calibration procedure.	
2	YRS Sensor Reversed Signal	The YRS signal is reversed. Verify the proper installation of the YRS. Verify the wiring between the ECU and the YRS. Check the YRS output.	
3	YRS Invalid Signal	The YRS signal is invalid. Verify the proper installation of the YRS. Verify proper wiring between the ECU and the YRS. Check the YRS output. Verify that correct YRS is being used.	
4	YRS Gradient Error		
5	YRS CAN Time-out	Loss of CAN communications between the ECU and the YRS. Verify proper wiring between the ECU and the YRS. Check the YRS output.	
6	YRS Static BITE Error	The YRS signal fails static self-test. Verify the proper installation of the YRS. Verify proper wiring between the ECU and the YRS. Check the YRS output. Verify that correct YRS is being used. Verify proper ECU programming. Perform the YRS calibration procedure.	
7	YRS Dynamic BITE Error	The YRS signal fails self-test conducted while vehicle is in motion. Verify the proper installation of the YRS. Verify proper wiring between the ECU and the YRS. Check the YRS output. Verify that correct YRS is being used. Verify proper ECU programming. Perform the YRS calibration procedure.	
8	YRS Fast Calibration Error	There is a YRS calibration error. Verify the proper installation of the YRS. Verify proper wiring between the ECU and the YRS. Check the YRS output. Verify that correct YRS is being used. Verify proper ECU programming. Perform the YRS calibration procedure..	
9	YRS Static Calibration Error		
10	YRS Normal Calibration Error	There is a YRS calibration error. Verify the proper installation of the YRS. Verify proper wiring between the ECU and the YRS. Check the YRS output. Verify that correct YRS is being used. Verify proper ECU programming. Perform the YRS calibration procedure.	
12	YRS Plausibility Check (Ref Yaw Rate)	The ECU has detected an incorrect YRS signal. Verify the proper installation of the YRS. Verify proper wiring between the ECU and the YRS. Check the YRS output. Verify that correct YRS is being used. Verify proper ECU programming. Perform the YRS calibration procedure.	
13	YRS Plausibility Error (Inside Model Based Limits)		
14	YRS Plausibility Error (Outside Model Based Limits)		
15	YRS - SAS Signal Cross-check Incomplete	The ECU (if configured) must confirm that YRS and SAS signals match. The vehicle must be exposed to an S-shaped driving maneuver for this DTC to automatically clear. If the DTC does not clear even after the S-shaped driving maneuver, check and correct the orientation of the YRS and then repeat the maneuver.	
16	YRS - Vibration Detected	Inspect the YRS mounting and verify it is securely mounted. Note that the YRS may not be relocated from the OEM-installed position on vehicle without written Bendix Engineering approval.	
17	YRS Detected But Not Configured	Verify that the ECU is configured for ESP.	

Troubleshooting Diagnostic Trouble Codes (DTCs): Yaw Rate Sensor (YRS) (continued)

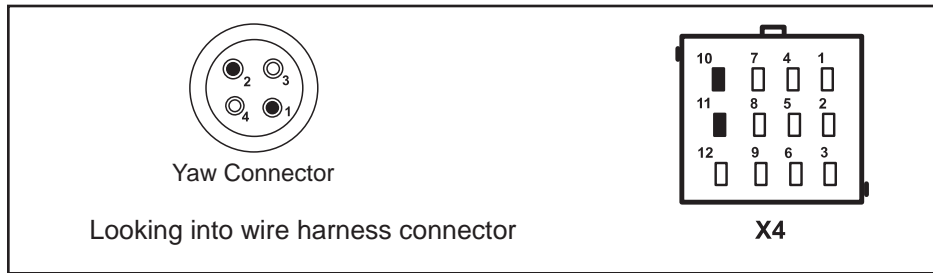

(Note: When checking for voltage at YAW/LAS & SAS, the voltage will only be present momentarily at key ON.)

Yaw Rate Sensor Tests

1. Verify continuity between the Electronic Control Unit (ECU) and the Yaw Rate Sensor (typically YAS-70 or YAS-60).

Connector	Pin	Function	
YRS	2	Voltage Input	
	1	Ground Input	
ECU 12 Way	X4	11	Power
		10	Common

2. Verify wiring between the Yaw Rate Sensor and the ECU.

YRS Wire Harness Terminal	ECU Wire Harness Terminal	Measurement
4	7	Verify Continuity
3	8	Verify Continuity

3. Verify wiring between the Yaw Rate Sensor and power/ground.

YRS Wire Harness Terminal	Measurement
4 to Voltage & Ground	Verify open circuit (no continuity)
3 to Voltage & Ground	Verify open circuit (no continuity)

4. To perform a calibration procedure of the Yaw Rate Sensor, ACom® Diagnostic Software V6.7.2.5 (or higher) is required. Using the program, select the “Configuration” option, followed by the “Calibrate” option. The following screen should be displayed.

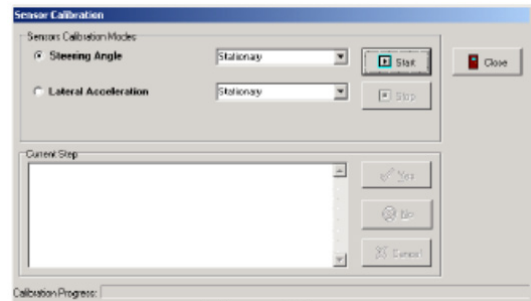

5. Follow the prompts to perform a calibration of the Yaw Rate Sensor.
6. To test the Yaw Rate Sensor, ACom V6.7.2.5, or higher, is required. Using Bendix ACom V6.7.2.5 or higher, select the “Component Test” option, followed by the “ESP Test” option. The following screen should be displayed.
7. Follow the prompts to perform a test of the Yaw Rate Sensor.

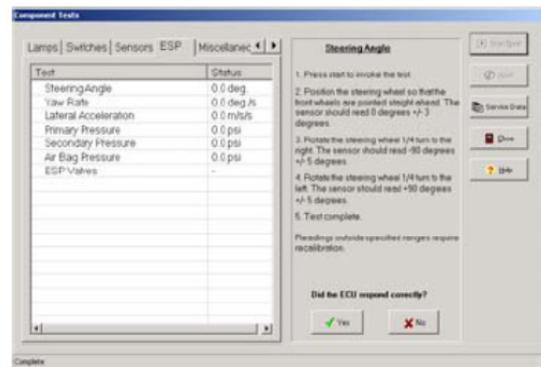

Troubleshooting Diagnostic Trouble Codes (DTCs): Lateral Acceleration Sensor (LAS)

1st. Blink Code 23	Location: Lateral Acceleration Sensor	2nd. Blink Code	Diagnostic Trouble Code Description	Repair Information
		1	LAS Signal Out of Range	LAS signal incorrect. Verify the proper installation of the YRS/LAS. Verify proper wiring between the Electronic Control Unit (ECU) and the YRS/LAS. Check YRS/LAS output. Perform LAS calibration procedure.
		2	LAS Calibration in Progress	LAS calibration procedure is underway.
		3	LAS Static Calibration Error	LAS calibration error. Verify the proper installation of the YRS/LAS. Verify proper wiring between the ECU and the YRS/LAS. Check YRS/LAS output. Verify that correct YRS/LAS is being used. Verify proper ECU programming. Perform LAS calibration procedure.
		4	LAS Long Term Calibration Error	LAS calibration error. Verify the proper installation of the YRS/LAS. Verify proper wiring between the ECU and the YRS/LAS. Check YRS/LAS output. Verify that correct YRS/LAS is being used. Verify proper ECU programming. Perform LAS calibration procedure.
		5	LAS Plausibility Error (Inside ECU-specific Limits)	ECU has detected an incorrect LAS signal. Verify the proper installation of the YRS/LAS. Verify proper wiring between the ECU and the YRS/LAS. Check YRS/LAS output. Verify that correct YRS/LAS is being used. Verify proper ECU programming. Perform LAS calibration procedure.
		6	LAS Plausibility Error (Outside ECU-specific Limits)	ECU has detected an incorrect LAS signal. Verify the proper installation of the YRS/LAS. Verify proper wiring between the ECU and the YRS/LAS. Check YRS/LAS output. Verify that correct YRS/LAS is being used. Verify proper ECU programming. Perform LAS calibration procedure.
		7	Erratic ESP Sensor Signal	ECU has detected an erratic signal. Verify the proper installation of the YRS/LAS. Verify proper wiring between the ECU and the YRS/LAS. Check YRS/LAS output. Verify that correct YRS/LAS is being used. Verify proper ECU programming. Perform LAS calibration procedure.

(Note: When checking for voltage at YRS/LAS & SAS, the voltage will only be present momentarily at key ON.)

1. Follow the steps shown in the Yaw Rate Sensor troubleshooting section for calibration and troubleshooting of the Lateral Acceleration Sensors (previous page).

Troubleshooting Diagnostic Trouble Codes (DTCs): Brake Demand/Load Sensors

1st. Blink Code	Location: Brake Demand/ Load Sensor	2nd. Blink Code	Diagnostic Trouble Code Description	Repair Information
24		1	PS1 Open or Shorted	Check wiring between Brake Demand Sensor (primary brake circuit) and Electronic Control Unit (ECU). Verify operation of pressure sensor.
		2	PS2 Open or Shorted	Check wiring between Brake Demand Sensor (secondary brake circuit) and ECU. Verify operation of pressure sensor.
		3	PS3 Open or Shorted	Check wiring between Load Sensor and ECU. Verify operation of pressure sensor.
		4	PS1/2 Plausibility Error	ECU has detected an invalid pressure sensor signal from one of the Brake Demand Sensors.
		5	PS Supply Voltage Error	Incorrect supply voltage to the sensors. Verify the proper voltage at sensor connectors. Verify wiring between the ECU and the sensors. Verify the proper output voltage from the ECU (Specifically, ensure that X4-4 PS_SPL is not shorted to ground).
		6	PS Not Calibrated	Perform static sensor calibration procedure. <i>(NOTE: When replacing an ECU, this DTC may occur.)</i>
		7	PS Error	Verify operation of pressure sensor.
		8	PS Supply Voltage Error	Incorrect supply voltage to sensors. Verify the proper voltage at sensor connectors. Verify wiring between ECU and the sensors. Verify the proper output voltage from ECU.
		9	PS Not Configured	Check for presence of pressure sensors. Make sure ESP is enabled.

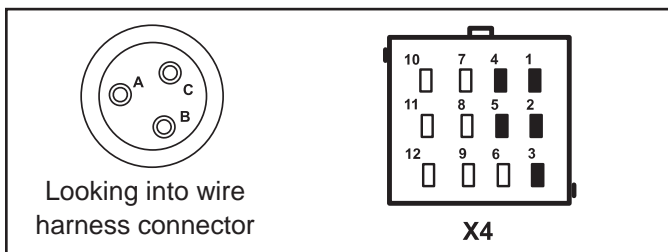

Brake Demand/Load Sensor Tests

1. Verify continuity between the ECU and the pressure sensor power and ground.

Power and Ground Input Test	Measurement
B = Power Input	X4 - 4 Power
A = Ground Input	X4 - 1 Common

2. Verify wiring between the Load Sensor and the ECU.

Load Sensor Wire Harness Terminal	ECU Wire Harness Terminal	Measurement
C	X4 - 2 Brake Demand Sensor (primary brake circuit)	Verify Continuity
	X4 - 5 Brake Demand Sensor (secondary brake circuit)	Verify Continuity
	X4 - 3 Load Sensor	Verify Continuity

3. Verify wiring between the Load Sensor and power/ground.

Load Sensor Harness Terminal	Measurement
C to Voltage & Ground	Verify open circuit (no continuity)

4. To perform a calibration procedure of the Brake Demand Sensor(s), ensure that the air system is fully charged. Apply ignition power, and wait 30 seconds. Perform a full application of the service brake and hold for 5 seconds. Release the service brake.
5. To test the Brake Demand Sensor and/or the Load Sensor, Bendix® ACom® Diagnostic Software V6.7.2.5 or higher is required. Using the program, select the "Component Test" option, followed by the "ESP Test" option. The following screen should be displayed.

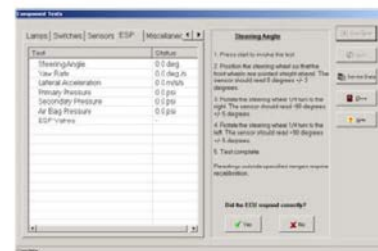

6. Follow the prompts to test the Brake Demand Sensor(s) and/or the Load Sensor.

Troubleshooting Diagnostic Trouble Codes (DTCs): Valves Miscellaneous

1st. Blink Code 25	Location: Valves		
2nd. Blink Code	Diagnostic Trouble Code Description	Repair Information	
1	Differential Lock Solenoid Open	Verify resistance between Diff solenoid and Diff common. Check for corroded /damaged wiring or connectors between the Electronic Control Unit (ECU) and the Diff solenoid.	
2	Differential Lock Solenoid Shorted to Ground	Verify no continuity between the Diff Lock Solenoid and ground. Check for corroded/damaged wiring or connectors between the ECU and Diff Lock Solenoid.	
3	Differential Lock Solenoid Shorted to Voltage	Verify no continuity between the Diff Lock Solenoid and voltage. Check for corroded/damaged wiring or connectors between the ECU and Diff Lock Solenoid.	
4	I/O 3 Open Circuit	Verify resistance for I/O3 circuit. Check for corroded / damaged wiring or connector between ECU and I/O.	
5	I/O 3 shorted to Ground	Check for a short circuit condition between ground and the I/O 3 circuit Verify resistance between Input /Output and ground is open	
6	I/O 3 Shorted to Battery	Check for a short circuit condition between voltage and the I/O 3 circuit Verify resistance between Input /Output and voltage is open	
7	Output Configuration Error - Diff	Mismatch between ECU configuration and Diff valve	
8	Output Configuration Error - I/O 3	Mismatch between ECU configuration and I/O3	

Troubleshooting Diagnostic Trouble Codes (DTCs): Bendix® ESP® system-related

1st. Blink Code	Location:		
26	J1939 Bendix® ESP® system-related	2nd. Blink Code	Diagnostic Trouble Code Description
		Repair Information	
1	J1939 CAN Time-out of ESP Message	Check for damaged or reversed J1939 wiring. Check for damaged or corroded connectors. Verify message is being transmitted on J1939 link. Verify the Electronic Control Unit (ECU) configuration	
2	Time-out or Invalid CAN data –CCVS 2 ESP Message	Check for damaged or reversed J1939 wiring. Check for damaged or corroded connectors. Verify message is being transmitted on J1939 link. Verify the ECU configuration	
3	Time-out or Invalid CAN data –Electronic Engine Controller 1 ESP Message	Check for damaged or reversed J1939 wiring. Check for damaged or corroded connectors. Verify the presence of engine ECU on J1939 link. Verify message is being transmitted on J1939 link. Verify data for driver's demand torque, actual engine torque, engine speed is correct. Verify the ECU configuration	
4	Time-out or Invalid CAN data –EEC2 ESP Message	Check for damaged or reversed J1939 wiring. Check for damaged or corroded connectors. Verify the presence of engine ECU on J1939 link. Verify message is being transmitted on J1939 link. Verify acceleration pedal position and acceleration pedal status is correct. Verify the ECU configuration	
5	Time-out or Invalid CAN data – Driveline Line Retarder ESP Message	Check for damaged or reversed J1939 wiring. Check for damaged or corroded connectors. Verify the presence of a retarder on J1939 Link. Verify that the message is being transmitted. Verify that the data is correct for torque / speed control. Verify the ECU configuration	
6	Time-out or Invalid CAN data – Engine Retarder ESP Message	Check for damaged or reversed J1939 wiring. Check for damaged or corroded connectors. Verify the presence of a retarder on J1939 Link. Verify that the message is being transmitted. Verify that the data is correct for torque / speed control. Verify the ECU configuration	
7	Time-out or Invalid CAN data – Exhaust Retarder ESP Message	Check for damaged or reversed J1939 wiring. Check for damaged or corroded connectors. Verify the presence of a retarder on J1939 Link. Verify that the message is being transmitted. Verify that the data is correct for torque / speed control. Verify the ECU configuration	
8	Time-out or Invalid CAN data – PROP XBR ESP Message	Check for damaged or reversed J1939 wiring. Check for damaged or corroded connectors. Verify the presence of Radar on J1939 link. Verify message is being transmitted. Verify the ECU configuration	
9	Time-out or Invalid CAN data – Transmission Retarder ESP Message	Check for damaged or reversed J1939 wiring. Check for damaged or corroded connectors. Verify the presence of a retarder on J1939 Link. Verify that the message is being transmitted. Verify that the data in torque/speed control. Verify the ECU configuration	
10	Time-out or Invalid CAN data –Electronic Transmission Controller 1 ESP Message	Check for damaged or reversed J1939 wiring. Check for damaged or corroded connectors. Verify the presence of transmission ECU on J1939 link. Verify that the message is being transmitted. Verify that the data for shift in process, torque configuration lock , driveline engaged is correct. Verify the ECU configuration	
11	Time-out or Invalid AUXI/O – ESP Message	Check for damaged or reversed J1939 wiring. Check for damaged or corroded connectors. Verify that the message is being transmitted. Verify that the data for reference torque is correct. Verify the ECU configuration	

Troubleshooting Diagnostic Trouble Codes (DTCs): J1939 Bendix® ESP® system-related (continued)

1st. Blink Code 26	Location: J1939 Bendix® ESP® system-related		
2nd. Blink Code	Diagnostic Trouble Code Description	Repair Information	
12	Time-out or invalid data for Configuration of Electronic Engine Controller 1 ESP Message	Check for damaged or reversed J1939 wiring. Check for damaged or corroded connectors. Verify the presence of engine on J1939 link. Verify that the message is being transmitted. Verify that the data for reference torque is correct. Verify the Electronic Control Unit (ECU) configuration	
13	Invalid Data Transfer Time-out of EC1 ESP Message	Check for damaged or reversed J1939 wiring. Check for damaged or corroded connectors. Verify the presence of engine on J1939 link. Verify that the message is being transmitted. Verify that the data for reference torque is correct. Verify the ECU configuration	
14	Time-out or invalid data for Configuration of Driveline Line Retarder ESP Message	Check for damaged or reversed J1939 wiring. Check for damaged or corroded connectors. Verify the presence of a retarder on J1939 link. Verify that the message is being transmitted. Verify that the data for reference torque is correct. Verify the ECU configuration	
15	Time-out or invalid CAN data –Electronic Engine Controller ESP Message	Check for damaged or reversed J1939 wiring. Check for damaged or corroded connectors. Verify the presence of engine ECU on J1939 link. Verify the presence of engine ECU on J1939 link. Verify the ECU configuration	
16	Time-out or invalid CAN data –Electronic Transmission Controller 2- message required for ESP	Check for damaged or reversed J1939 wiring. Check for damaged or corroded connectors. Verify the presence of transmission ECU on J1939 link. Verify that the message is being transmitted. Verify that the data for current gear is correct. Verify the ECU configuration	
17	Time-out or invalid data for Configuration of Engine Retarder ESP Message	Check for damaged or reversed J1939 wiring. Check for damaged or corroded connectors. Verify the presence of a retarder on J1939 link. Verify message is being transmitted. Verify the ECU configuration	
18	Time-out or invalid data for Configuration of Exhaust Retarder ESP Message	Check for damaged or reversed J1939 wiring. Check for damaged or corroded connectors. Verify the presence of a retarder on J1939 link. Verify message is being transmitted. Verify the ECU configuration	
19	Time-out or invalid data for Configuration of Transmission Retarder ESP Message	Check for damaged or reversed J1939 wiring. Check for damaged or corroded connectors. Verify the presence of Radar on J1939 link. Verify the ECU configuration	
20	Invalid Data Transfer Time-out of Driveline Line Retarder ESP Message	Check for damaged or reversed J1939 wiring. Check for damaged or corroded connectors. Verify the presence of a retarder on J1939 link. Verify message is being transmitted. Verify the ECU configuration	
21	Invalid Data Transfer Time-out of Engine Retarder ESP Message	Check for damaged or reversed J1939 wiring. Check for damaged or corroded connectors. Verify the presence of a retarder on J1939 link. Verify message is being transmitted. Verify the ECU configuration	
22	Invalid Data Transfer Time-out of Exhaust Retarder ESP Message	Check for damaged or reversed J1939 wiring. Check for damaged or corroded connectors. Verify the presence of a retarder on J1939 link. Verify the presence of a retarder on J1939 link. Verify message is being transmitted. Verify the ECU configuration	

Troubleshooting Diagnostic Trouble Codes (DTCs): J1939 Bendix® ESP® system-related (continued)

1st. Blink Code 26	Location: J1939 ESP-related	
2nd. Blink Code	Diagnostic Trouble Code Description	Repair Information
23	Time-out or invalid CAN data – CCVS ESP Message	Check for damaged or reversed J1939 wiring. Check for damaged or corroded connectors. Verify message is being transmitted on J1939 link. Verify data for park brake, brake lamp switch, clutch and tachograph. Verify the Electronic Control Unit (ECU) configuration
24	Time-out or invalid CAN data – TCO ESP Message	Check for damaged or reversed J1939 wiring. Check for damaged or corroded connectors. Verify message is being transmitted. Verify the ECU configuration
25	Invalid Data Transfer Time-out of Driveline Line Retarder ESP Message	Check for damaged or reversed J1939 wiring. Check for damaged or corroded connectors. Verify the presence of a retarder on J1939 link. Verify message is being transmitted. Verify the ECU configuration
26	ESP-related CM3 Time-out at J1939	Check for damaged or reversed J1939 wiring. Check for damaged or corroded connectors. Verify message is being transmitted. Verify the ECU configuration
27	Time-out of message or invalid data received from transmission transfer information on J1939 - message required for ESP	Check for damaged or reversed J1939 wiring. Check for damaged or corroded connectors. Verify message is being transmitted. Verify the ECU configuration
28	Time-out or invalid CAN data – Electronic Axle Controller 1ESP Message	Check for damaged or reversed J1939 wiring. Check for damaged or corroded connectors. Verify message is being transmitted. Verify the ECU configuration

Troubleshooting: Connectors

Bendix® ESP® EC-80™ Controller Wire Harness Connector Part Numbers and Pin Assignments:

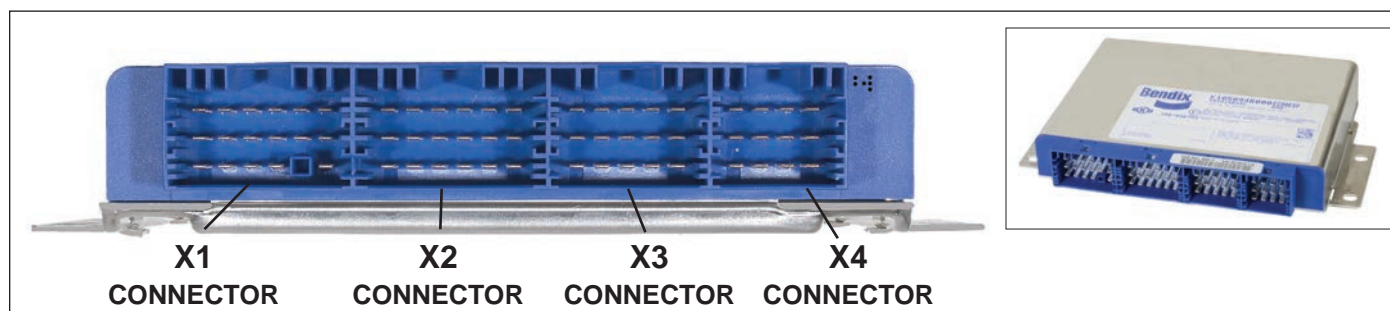

Bendix ESP EC-80 Controller

Controllers utilize four (4) AMP connectors for wire harness connections.

X1 Connector Pin Assignments Vary by Part Number:		X2 Connector Pin Assignments	X3 Connector Pin Assignments	X4 Connector Pin Assignments	
K098920R000 K098921R000 K103428R000 K103429R000 K105094R000 K105095R000 K105096R000 K105097R000	K105303R000				
Pin	Designation	Designation	Designation	Designation	
1	Ground		PMV SA Left HLD	ABS ORS	Pressure Sensor CMN
2	Trailer ABS Indicator	HSA Disable Switch	PMV SA Left REL	Diff. Lock Solenoid*	Brake Demand Primary Circuit Signal
3	Ignition		PMV SA Left CMN	TCV CMN (SA)	Load Sensor Signal
4	TCV CMN (DA)	TCV CMN (DA)	PMV SA Right HLD	PMV AA Left HLD	Pressure Sensor Supply
5	TCV (DA)	TCV (DA)	WSS SA Left (+)	TCV (SA)	Brake Demand Secondary Circuit Signal
6	ATC/ESP Indicator and ATC ORS	TPMS Ground	PMV SA Right CMN	PMV AA Left CMN	PMV Trailer HLD
7	J1939 Low		PMV SA Right REL	PMV AA Left REL	Sensor CAN Low
8	J1939 High		WSS SA Left (-)	Stop Lamp Output	Sensor CAN High
9	SLS Input	TPMS Communications	PMV DA Right CMN	PMV AA Right CMN	PMV Trailer REL
10	WSS DA Right (+)		PMV DA Right HLD	PMV AA Right HLD	Sensor CAN Common
11	WSS DA Right (-)		WSS SA Right (+)	WSS AA Left (+)	Sensor CAN Supply
12	ABS Indicator Ground	Reserved	PMV DA Left CMN	WSS AA Right (+)	PMV Trailer CMN
13	No Connection	J1939 High 2	PMV DA Right REL	PMV AA Right REL	
14	No Connection	J1939 Low 2	WSS SA Right (-)	WSS AA Left (-)	
15	ABS Indicator Interlock		WSS DA Left (+)	WSS AA Right (-)	
16	Battery		PMV DA Left HLD		
17	Retarder	ATC/ESP Indicator	PMV DA Left REL		
18	ABS Dash Indicator	ATC Disable Switch or Diagnostic Switch	WSS DA Left (-)		

Troubleshooting: Wiring

ABS/ATC WIRING

Electronic Control Unit (ECU) Wiring Harness Connectors

The Bendix® ESP® EC-80™ Controller is designed to interface with AMP MCP 2.8 connectors as referenced in Figure 21. Follow all AMP requirements for the repair of wire harnesses.

All wire harness connectors must be properly seated. The use of secondary locks is strongly advised.



All unused ECU connectors must be covered and receive proper environmental protection.

ABS Wiring Requirements

As a matter of good practice and to ensure maximum system robustness, always use the maximum size wire supported by the wire harness connectors for battery, ignition, ground, Pressure Modulator Valve (PMV), Traction Control Valve (TCV), Interaxle Differential Lock and indicator lamp circuits.

All sensor and serial communications circuits (J1939) must use twisted pair wiring (one to two twists per inch). See the appropriate Society of Automotive Engineers (SAE) document for additional details.



All wires must be carefully routed to avoid contact with rotating elements. Wiring must be properly secured approximately every 6 to 12 inches using UV stabilized, non-metallic hose clamps or bow-tie cable ties to prevent pinching, binding or fraying.

It is recommended that wires be routed straight out of a connector for a minimum of three inches before the wire is allowed to bend.

Battery and ground wires should be kept to a minimum length.

If convoluted tubing is used, its I.D. must match the size of the wire bundle as closely as possible.



Wire harness lengths must be carefully selected for the vehicle. Excess lengths of wire are not to be wound to form coils, instead re-route, repair or replace wire harness to avoid the possibility of electrical interference and wire damage. Do not attempt to stretch harnesses that are too short, since mechanical strain can result in wire breakage.

Bendix® SAS-60™ Sensors and YAS-60™, or YAS-70X™, Sensor Wiring

If it is necessary to replace the wiring that connects the Bendix SAS-60 or the Yaw Rate sensor to the ECU, it is important to use the same wiring as that used by the vehicle OEM.





ABS Component	Connector	Wire Terminal	Wire Seal/ Plug	Terminal Lock	Terminal Crimp Tool	
In-Cab Controller Harness 17-Way AMP MCP 2.8 (X1)	 1718091-1	 927768-9 1 - 2.5 mm ² X1-12 & 18	N/A	 967634	 539723-2	
In-Cab Controller Harness 18-Way AMP MCP 2.8 (X2)	 8-968974-1		N/A	N/A		
In-Cab Controller Harness 15-Way AMP MCP 2.8 (X3)	 8-968973-1	968874 2.5 - 4 mm ²				
Controller Harness 12-Way AMP MCP 2.8 (X4)	 8-968972-1	 968873 1.0 - 2.5 mm ²				
ABS Modulator Harness AMP Twist-Lock (Bayonet)	 1-967325-2	 929975-1			N/A	 539635-1
ATC Modulator Harness AMP Twist-Lock (Bayonet)	 1-967325-3					
ABS Modulator Harness 3-pin Packard Metri-Pack 280 Series	 12040977	 12077411	 12015323	 12034145	 12155975	
TE® Connectivity / AMP Terminal Removal Tool. Newark® Part No. 78H0240. Manufacturer Part Number 1-1579007-6						
Bendix® WS-24™ Wheel Speed Sensor Connectors						
						
Packard® GT 150 series	Packard Metripack 150.2 series	Deutsch® DTM06 series	Packard Metripack 280 series (female)	Packard Metripack 280 series (male)	Deutsch DT04 series	Standard round two pin
Yaw Rate Sensor Wire Harness Connectors (4 contact):			Yaw Rate Sensor Wire Harness Contact Pin Terminals:			
Straight Connector: Schlemmer® 9800 351 (shown) AMP® Connector 2-967325-1 ITT® Cannon® Connector 121583-001				Schlemmer 7814 125		
90 degree Connector: Schlemmer 9800 331				AMP 0-962981-1 ITT Cannon 031-8717-120		
Brake Demand Sensor/Load Sensor Wire Harness Connectors:			Bendix® SAS-60™ Sensor Connectors:			
Metri-Pack® (Packard) 1206 5287			Robert Bosch® 1 928 404 025, Robert Bosch 1 928 498 001			
Contact Pins: Packard 1210 3881			One Meter Adapter to Connector: Bendix 5015242 (shown) Packard 12092162, pins 12064971			
						

FIGURE 21 - BENDIX ESP® EC-80™ CONTROLLER COMPONENT CONNECTORS

Troubleshooting: Wiring (Continued)

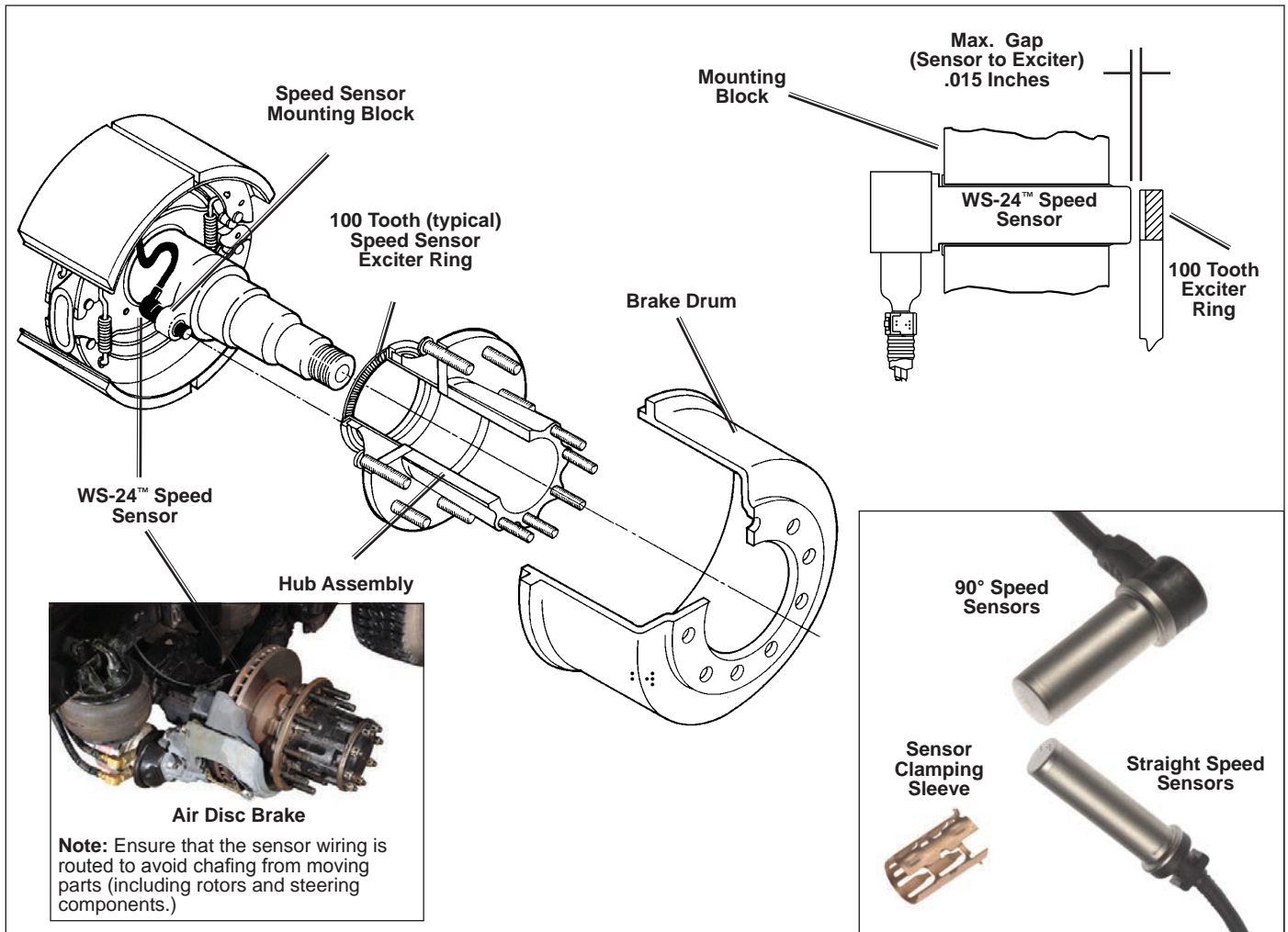

FIGURE 22 - BENDIX® WS-24™ WHEEL SPEED SENSOR INSTALLATION (S-CAM AND AIR DISC BRAKE)

Wheel Speed Sensor Wiring

Route sensor wiring coming out of the wheel ends away from moving brake components. Sensor wiring needs to be secured to the axle to prevent excess cable length and wiring damage. It is required that cable ties be installed to the sensor wire within 3 inches (76.2 mm) of the sensor head to provide strain relief.

Following the axle, the sensor wires must be attached along the length of the service brake hoses using cable ties with ultraviolet protection and secured every 6 to 8 inches (152 to 203 mm). Sufficient – but not excessive – cable length must be provided to permit full suspension travel and steering axle movement. Install wires so that they cannot touch rotating elements such as wheels, brake discs or drive shafts. Radiation protection may be necessary in the area of brake discs.

Bendix does not recommend using standard tie-wraps to secure wiring harnesses directly to rubber air lines. This may cause premature wiring failure from the pressure exerted on the wiring when air pressure is applied through the air line. Non-metallic hose clamps or bow-tie tie-wraps are preferred.

The use of grommets or other suitable protection is required whenever the cable must pass through metallic frame members.

All sensor wiring must utilize twisted pair wire, with approximately one to two twists per inch.

It is recommended that wires be routed straight out of a connector for a minimum of three inches before the wire is allowed to bend.

Troubleshooting: Wiring Schematic A

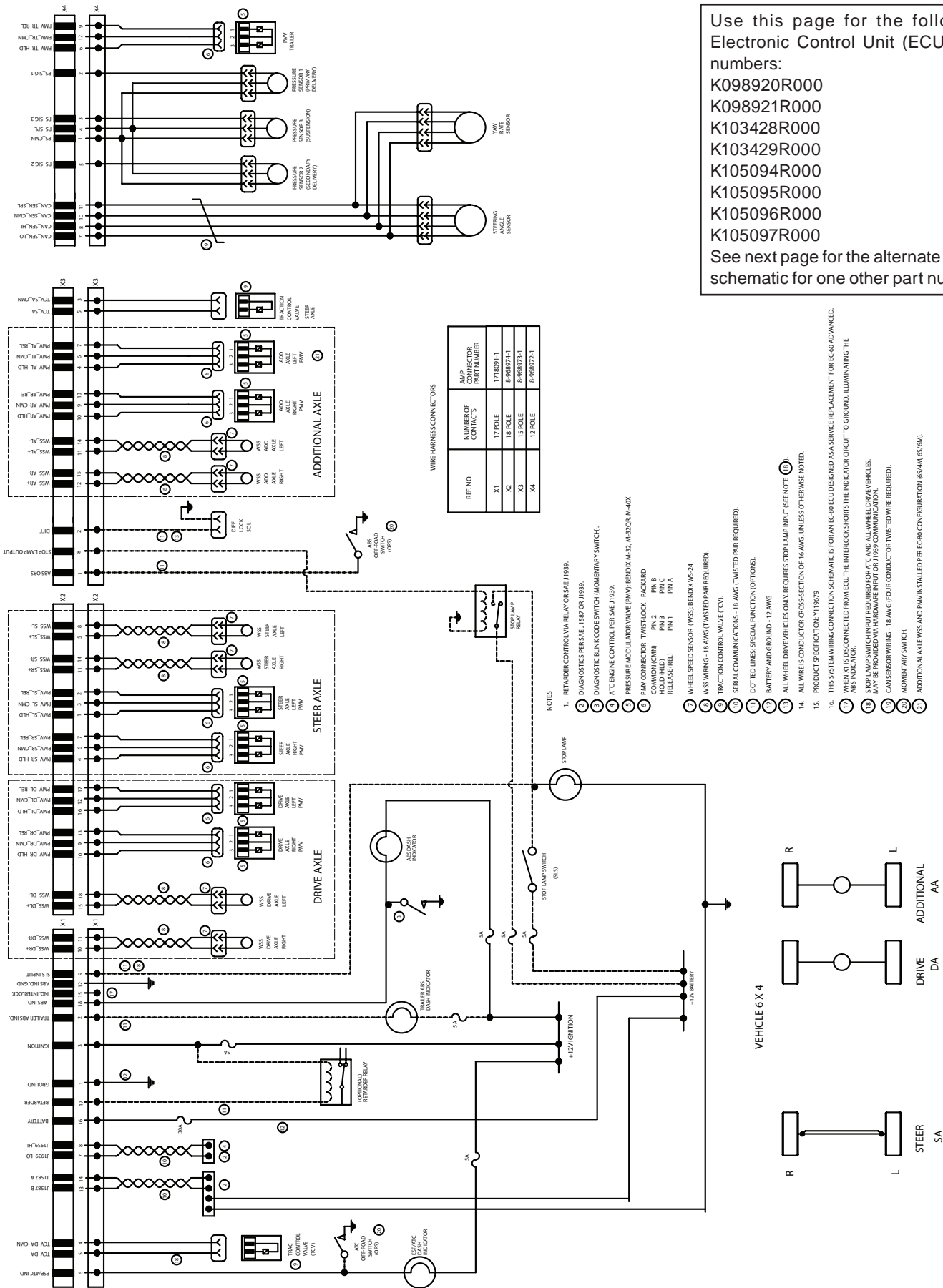

Use this page for the following Electronic Control Unit (ECU) part numbers:
 K098920R000
 K098921R000
 K103428R000
 K103429R000
 K105094R000
 K105095R000
 K105096R000
 K105097R000
 See next page for the alternate wiring schematic for one other part number.

FIGURE 23 - STANDARD WIRING SCHEMATIC FOR ECUs LISTED ABOVE

Troubleshooting: Wiring Schematic B (Alternate)

Use the wiring schematic on this page for the following Electronic Control Unit (ECU) part number: K105303R000

See the previous page for a second list of ECU part numbers.

If your ECU part number does not appear on either list, please call 1-800-AIR-BRAKE, option 2, and speak with the Tech Team.

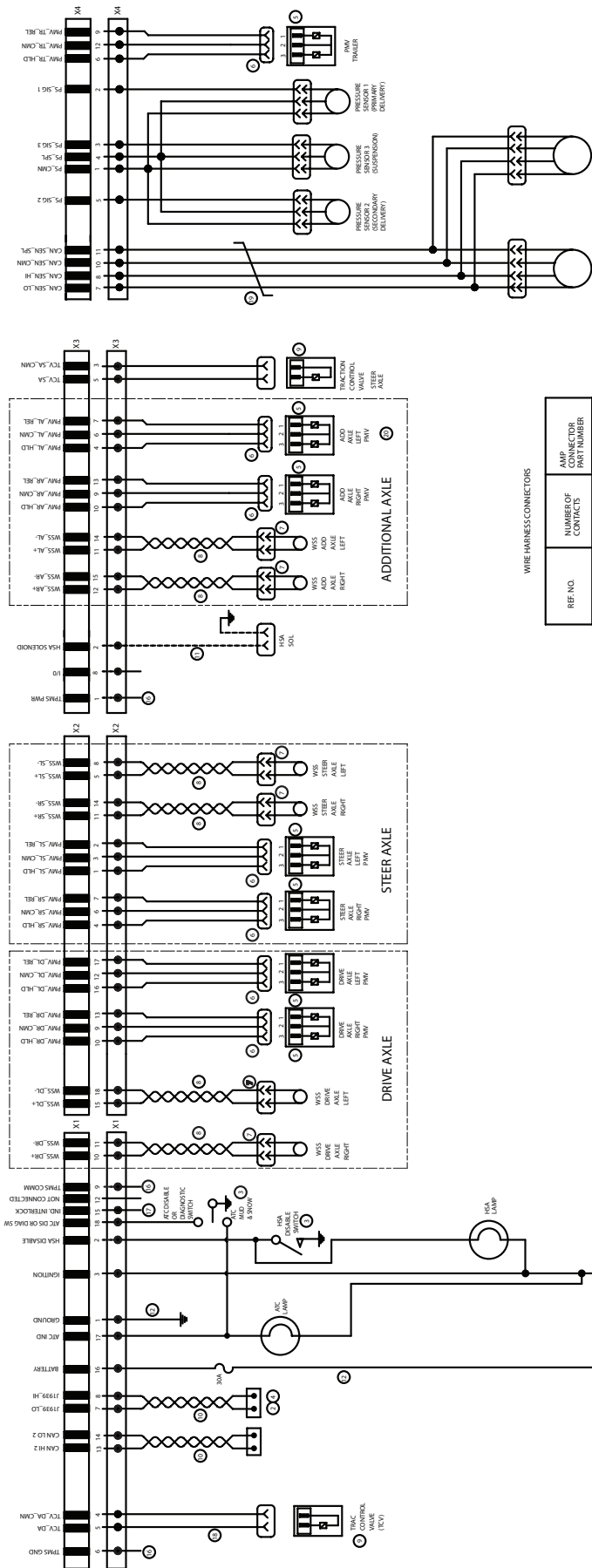

WIRE HARNESS CONNECTORS

REF. NO.	NUMBER OF CONTACTS	AMP CONNECTOR PART NUMBER
X1	17 POLE	1718091-1
X2	18 POLE	8-968974-1
X3	15 POLE	8-968973-1
X4	12 POLE	8-968972-1

- NOTES:
- RETARDER CONTROL VIA SAE J1939.
 - DIAGNOSTICS VIA SAE J1939.
 - MOMENTARY SWITCH.
 - ATC ENGINE CONTROL PER SAE J1939.
 - PRESSURE MODULATOR VALVE (PMV): BENDIX M-32, M-32OR, M-40X.
 - PMV CONNECTOR TWIST-LOCK PACKARD COMMON (CMN) PIN 2 PIN B PIN 3 PIN C PIN 4 PIN A
 - WHEEL SPEED SENSOR (WSS): BENDIX WS-24.
 - WSS WIRING - 18 AWG (TWISTED PAIR REQUIRED).
 - TRACTION CONTROL VALVE (TCV).
 - SERIAL COMMUNICATIONS - 18 AWG (TWISTED PAIR REQUIRED).
 - DOTTED LINES: SPECIAL FUNCTION (OPTIONS).
 - BATTERY AND GROUND - 12 AWG.
 - ALL WHEEL DRIVE VEHICLES ONLY. REQUIRES STOP LAMP INPUT (SEE NOTE 19).
 - ALL WIRE IS CONDUCTOR CROSS-SECTION OF 16 AWG, UNLESS OTHERWISE NOTED.
 - PRODUCT SPECIFICATION: Y119679 AND Y173755.
 - TPMS WIRING - 3 WIRES.
 - WHEN X1 IS DISCONNECTED FROM ECU, BODY CONTROLLER NEEDS TO ILLUMINATE ABS INDICATOR.
 - STOP LAMP SWITCH INPUT REQUIRED FOR ATC AND ALL WHEEL DRIVE VEHICLES. IS PROVIDED VIA STOP LAMP SWITCH VIA J1939 COMMUNICATION.
 - CAN SENSOR WIRING - 18 AWG (FOUR CONDUCTOR TWISTED WIRE REQUIRED).
 - ADDITIONAL AXLE WSS AND PMV INSTALLED PER EC-80 CONFIGURATION (6S/4M, 6S/6M).
 - ABS ESP/TRAILER LAMP VIA J1939.
 - NO ABS OFF ROAD SWITCH. ABS OFF ROAD ACTIVATED WITH ATC MUD AND SNOW.

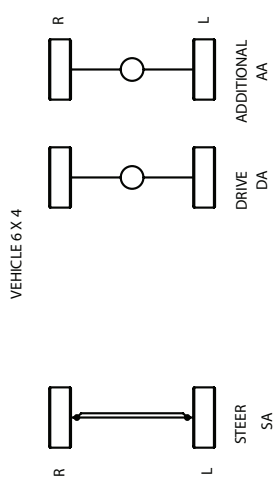

FIGURE 24 - CAB WIRING SCHEMATIC FOR ECU LISTED ABOVE

GLOSSARY

ABS – Antilock Brake System.

ABS Event – Impending wheel lock situation that causes the ABS Controller to activate the modulator valve(s).

ABS Indicator Lamp – An amber lamp which indicates the operating status of an antilock system. When the indicator lamp is on, ABS is disabled and the vehicle reverts to normal brake operation.

Air Gap – Distance between the Sensor and tone ring.

ASR – Automatic Slip Regulation. Another name for traction control.

ATC – Automatic Traction Control. An additional ABS function in which engine torque is controlled and brakes are applied differentially to enhance vehicle traction.

ATC/ESP Lamp – A lamp that indicates when stability functions, including traction control, roll stability program or yaw control are operating.

Channel – A controlled wheel site.

CAN – Controller Area Network. J1939 is an SAE version of the CAN link.

Clear Codes – System to erase historical Diagnostic Trouble Codes (DTCs) from the ECU, from either the Diagnostic Switch or from a hand-held diagnostic tool (only repaired DTCs may be cleared).

Configuration – The primary objective is to identify a “normal” set of sensors and modulators for the Electronic Control Unit, so that it will identify future missing sensors and modulators.

Diagnostic Connector – Diagnostic receptacle in vehicle cab for connection of J1939 hand-held or PC based test equipment. The tester can initiate test sequences, and can also read system parameters.

Diagnostic Switch – A switch used to activate blinks codes.

Differential Braking – Application of brake force to a spinning wheel so that torque can be applied to wheels which are not slipping.

ECU – Electronic Control Unit.

ESP – Electronic Stability Program. Full stability function that includes RSP & YC subfunctions.

Diagnostic Trouble Code – A condition that interferes with the generation or transmission of response or control signals in the vehicle's ABS system that could lead to the functionality of the ABS system becoming inoperable in whole or in part.

FMVSS-121 – Federal Motor Vehicle Safety Standard which regulates air brake systems.

Hill Start (or “**Hill Start Assist**”) **HS/HSA** – This feature interfaces between the transmission and braking system to help the driver prevent the vehicle from rolling downhill when moving up a steep incline from a stationary position.

IR – Independent Regulation. A control method in which a wheel is controlled at optimum slip, a point where retardation and stability are maximized. The brake pressure that is best for the wheel in question is directed individually into each brake chamber.

J1939 – A high speed data link used for communications between the ABS ECU engine, transmission and retarders.

LAS – Lateral Acceleration Sensor.

MIR – Modified Independent Regulation. A method of controlling the opposite sides of a steer axle during ABS operation so that torque steer and stopping distance are minimized.

PLC – Power Line Carrier. The serial communication protocol used to communicate with the trailer over the blue full time power wire.

PMV – Pressure Modulator Valve. An air valve which is used to vent or block air to the brake chambers to limit or reduce brake torque.

QR – Quick Release. Quick release valves allow faster release of air from the brake chamber after a brake application. To balance the system, quick release valves have hold off springs that produce higher crack pressures (when the valves open).

Relay Valve – Increases the application speed of the service brake. Installed near brakes with larger air chambers (type 24 or 30). The treadle valve activates the relay valve with an air signal. The relay valve then connects its supply port to its delivery ports. Equal length air hose must connect the delivery ports of the relay valve to the brake chambers.

Retarder Relay – A relay which is used to disable a retarder when ABS is triggered.

RSP – Roll Stability Program. An all-axle ABS solution that helps reduce vehicle speed by applying all vehicle brakes as needed, reducing the tendency to roll over.

SAS – Steering Angle Sensor.

Sensor Clamping Sleeve – A beryllium copper sleeve which has fingers cut into it. It is pressed between an ABS sensor and mounting hole to hold the sensor in place.

Stored Diagnostic Trouble Codes – A DTC that occurred in the past.

TCS – Traction Control System, another name for ATC or ASR.

TCV – Traction Control Valve.

Tone Ring – A ring that is usually pressed into a wheel hub that has a series of teeth (usually 100) and provides actuation for the speed sensor. Note maximum run out is .008.

YC – Yaw Control. Helps stabilize rotational dynamics of vehicle.

YRS – Yaw Rate Sensor.

APPENDIX A: TROUBLESHOOTING A 12-7 BLINK CODE, EQUIVALENT TO A (SID-93 FMI-4) (SPN-0802 FMI-04) DIAGNOSTIC TROUBLE CODE (DTC)

Bendix® EC-80™ ESP® Electronic Control Unit (ECU)

- 1) Remove the X1, X2, X3 and X4 connectors from the ECU.
- 2) Using X1-1 as the ground connection, check for resistance for the entire X2 connector. There should be no resistance to ground found. Please fill out worksheet on this page.
- 3) Using X1-1 as the ground connection, check for resistance for X1-4 and X1-5. There should be no resistance to ground.
- 4) Using X1-1 as the ground connection, check for resistance for X3-4, X3-6, X3-7, X3-9, X3-10, X3-13, X3-3 and X3-5. There should be no resistance to ground. (Even if the vehicle is not configured for 6S/6M).
- 5) Using X1-1 as the ground connection, check for resistance for X4-6, X4-9 and X4-12. There should be no resistance to ground.
- 6) Troubleshoot any pin that has resistance to ground. If no issues are found continue to step 7.
- 7) Reconnect the X1 connector only and apply IGN power to the ECU and using the DTC screen of Bendix® ACom® Diagnostic Software, clear all DTCs. Re-check for any DTCs. If the 12-7 DTC is still present, the problem is the Traction Solenoid Wiring or Solenoid.
- 8) If the 12-7 DTC does not reappear, remove power and connect the X2 connector, reapply power, then clear all DTCs. If the 12-7 DTC is no longer present, connect the X3 connector and clear all DTCs.
- 9) If at this point the 12-7 DTC is not present, the problem is with the X4 connector.

For Peterbilt® & Kenworth® Trucks Only:	
10)	Clear all DTCs. If the 12-7 DTC reappears, the issue is on the X4 connector. Otherwise, proceed to the next step.
11)	Disconnect all modulators and the traction solenoid. Clear all DTCs. If the DTC does not reappear, connect one modulator and Traction Solenoid at a time, until the DTC reappears. Otherwise, continue to the next step.
12)	Make sure all modulators and the traction solenoid are connected. Disconnect the ABS bulkhead connector at the engine (top-left side) and remove Pins 1, 2, 11 & 12. Reconnect the connector and apply IGN power to the ECU. Using Bendix ACom Diagnostics, clear all DTCs. If the 12-7 DTC returns, the problem is either the wiring harness inside the cab or the ECU.

Record Resistances Below: X1-1 for ground point

X1 Pin	Resistance
X1-4	
X1-5	

X2 Pin	Resistance
X2-1	
X2-2	
X2-3	
X2-4	
X2-5	
X2-6	
X2-7	
X2-8	
X2-9	
X2-10	
X2-11	
X2-12	
X2-13	
X2-14	
X2-15	
X2-16	
X2-17	
X2-18	

X3 Pin	Resistance
X3-4	
X3-5	
X3-6	
X3-7	
X3-8	
X3-9	
X3-10	
X3-13	

X4 Pin	Resistance
X4-6	
X4-9	
X4-12	

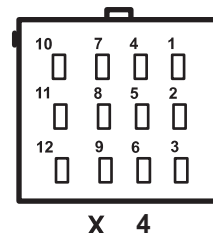
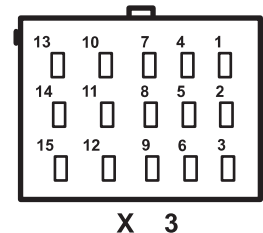
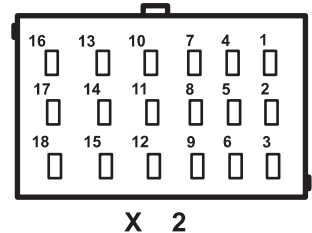
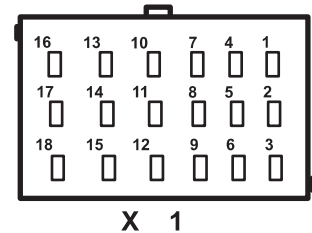

APPENDIX B: J1939 SPN AND FMI CODES AND THEIR BENDIX® BLINK CODE EQUIVALENTS

SPN (J1939)	FMI (J1939)	Bendix® Blink Code Equivalent(s)		Diagnostic Trouble Code (DTC) Description	Lamp Status	
		(1st Digit)	(2nd Digit)		ABS	ATC/ ESP
	-	1	1	No DTCs	-	-
Power Supply DTCs						
168	3	6	2	Battery Voltage Too High	ON	ON
168	4	6	1	Battery Voltage Too Low	ON	ON
Miscellaneous DTCs						
564	3	25	3	Differential Lock Solenoid Shorted To Voltage	ON	ON
564	4	25	2	Differential Lock Solenoid Shorted To Ground	ON	-
564	5	25	1	Differential Lock Solenoid Open	ON	-
564	13	25	7	Output Configuration Error - Differential	ON	-
575	14	12	17	ABS Disabled Due To Special Mode Or Off-Road ABS Active. <i>Note: The ABS warning lamp will be flashing indicating the is in ABS off-road mode</i>	-	ON
576	14	12	3	ATC or ESP Disabled or Dynamometer Test Mode Active	ON	-
614	3	12	32	I/O 2 or 3 Shorted High (EC-80 ATC) OR I/O 2 or 3 Shorted High or Stop Lamp Output Error (ESP EC-80)	-	ON
614	3	25	6	I/O 3 Shorted to Voltage	-	ON
614	4	25	5	I/O 3 Shorted to Ground	-	ON
614	5	25	4	I/O 3 Open Circuit	-	ON
614	13	25	8	Output Configuration Error - I/O 3	-	ON
615	14	12	19	Maximum Number of Pressure Modulator Valve (PMV) Cycles Exceeded	-	-
615	14	12	20	Maximum Number of Traction Control Valve (TCV) Cycles Exceeded	-	-
614	3	12	32	I/O 2 or 3 Shorted High (EC-80 ATC) OR I/O 2 or 3 Shorted High or Stop Lamp Output Error (ESP EC-80)	-	ON
614	3	25	6	I/O 3 Shorted to Voltage	-	ON
614	4	25	5	I/O 3 Shorted to Ground	-	ON
614	5	25	4	I/O 3 Open Circuit	-	ON
614	13	25	8	Output Configuration Error - I/O 3	-	ON
615	14	12	19	Maximum Number of PMV Cycles Exceeded	-	-
615	14	12	20	Maximum Number of TCV Cycles Exceeded	-	-
ECU DTCs (Also see other 629 codes)						
629	2	13	4	ECU DTC (2678C)	ON	ON
629	2	13	5	ECU DTC (1C)	ON	ON
629	2	13	7	Configuration Mismatch	ON	ON
629	2	13	17	ECU DTC (C8C)	ON	ON
Miscellaneous DTCs						
629	8	12	29	Air System / Mechanical Component	ON	ON
ECU DTCs (Also see other 629 codes)						
629	12	13	3	ECU DTC (10)	ON	ON
629	12	13	14	ECU DTC (C6)	ON	ON
629	12	13	15	ECU DTC (CF)	ON	ON
629	12	13	16	ECU DTC (C0)	ON	ON
Miscellaneous DTCs						
629	14	12	28	Air System / Mechanical Component	ON	ON
629	14	12	30	ESP Disabled Due to Off-Road Mode	-	ON

APPENDIX B: J1939 SPN AND FMI CODES AND THEIR BENDIX® BLINK CODE EQUIVALENTS

SPN (J1939)	FMI (J1939)	Bendix® Blink Code Equivalent(s)		Diagnostic Trouble Code (DTC) Description	Lamp Status	
		(1st Digit)	(2nd Digit)		ABS	ATC/ ESP
ECU DTCs (Also see other 629 codes)						
629	14	13	1	ECU DTC (5FC)	ON	ON
630	12	13	6	ECU DTC(6CD)	ON	ON
630	12	13	10	ECU DTC (5F3)	ON	ON
630	12	13	19	ECU DTC (63)	-	-
630	12	13	20	ECU DTC (6E)	ON	ON
630	12	13	28	ECU DTC (7CD)	ON	ON
630	13	13	2	ECU DTC (5CD)	ON	ON
630	13	13	8	ECU DTC (56)	ON	ON
630	13	13	9	ECU DTC (CA3C)	ON	ON
630	13	13	18	ECU DTC (CC)	ON	ON
630	13	13	21	ECU DTC (6C)	ON	ON
630	13	13	22	ECU DTC (63C)	ON	ON
630	13	13	25	VIN Mismatch	-	ON
630	13	13	26	Valve Configuration Mismatch	-	ON
630	13	13	29	ECU DTC (5D)	ON	ON
630	14	13	13	Configuration Mismatch	ON	ON
J1939 DTCs						
639	2	11	2	J1939 Electronic Retarder Time-out or Invalid Signal	ON	ON
639	2	11	3	J1939 Electronic Engine Controller 1 Time-out or Invalid Signal	-	ON
639	2	11	4	J1939 Electronic Engine Controller 2 Time-out or Invalid Signal	-	ON
639	2	11	5	J1939 AIR Message Time-out or Invalid Signal	-	ON
639	2	11	6	ESP J1939 CAN Message Time-out	-	ON
639	2	11	7	Time-out or Invalid CAN Data for ETC7/VP15	-	-
639	2	11	8	Time-out or Invalid Data on XBR	-	-
639	2	11	10	J1939 Electronic Transmission Controller 1 Time-out or Invalid Signal	ON	-
639	2	11	11	AUXIO CAN Message Time-out	-	-
639	2	11	12	J1939 Hill Start Aid Switch Signal Not Available - HSA LAMP ON	-	-
639	2	11	14	J1939 CAN Message Related to ESP is Incomplete	-	ON
639	2	11	15	J1939 Electronic Engine Controller 3 Time-out or Invalid Signal	-	ON
639	2	11	16	J1939 Electronic Transmission Controller 2 Time-out	-	ON
639	2	11	20	J1939 EAC1 Time-out or Invalid Signal	-	ON
639	2	11	21	CAN Message CGW_C1 Time-out or Invalid Signal	-	ON
639	2	11	22	CAN Message ASC1_CLCS Time-out or Invalid Signal	-	ON
639	2	11	23	J1939 CCVS Time-out or Invalid Signal	-	ON
639	2	11	24	J1939 TCO(Tachograph) Time-out	-	ON
639	2	11	28	J1939 Proprietary XBR Message Out-of-Range	-	ON
639	2	26	1	J1939 CAN Time-out of ESP Message	-	ON
639	2	26	2	Time-out or Invalid CAN Data – CCVS 2 ESP Message	-	ON
639	2	26	3	Time-out or Invalid CAN Data – Electronic Engine Controller 1 ESP Message	-	ON
639	2	26	4	Time-out or Invalid CAN Data – EEC2 ESP Message	-	ON
639	2	26	5	Time-out or Invalid CAN Data – Driveline Line Retarder ESP Message	-	ON
639	2	26	6	Time-out or Invalid CAN Data – Engine Retarder ESP Message	-	ON
639	2	26	7	Time-out or Invalid CAN Data – Exhaust Retarder ESP Message	-	ON
639	2	26	8	Time-out or Invalid CAN Data – PROP XBR ESP Message	-	ON
639	2	26	9	Time-out or Invalid CAN Data – Transmission Retarder ESP Message	-	ON
639	2	26	10	Time-out or Invalid CAN Data – Electronic Transmission Controller 1 ESP Message	-	ON
639	2	26	11	Time-out or Invalid AUX I/O – ESP Message	-	ON
639	2	26	12	Time-out or Invalid Data for Configuration of Electronic Engine Controller 1 ESP Message	-	ON

APPENDIX B: J1939 SPN AND FMI CODES AND THEIR BENDIX® BLINK CODE EQUIVALENTS

SPN (J1939)	FMI (J1939)	Bendix® Blink Code Equivalent(s)		Diagnostic Trouble Code (DTC) Description	Lamp Status	
		(1st Digit)	(2nd Digit)		ABS	ATC/ ESP
639	2	26	13	Invalid Data Transfer Time-out of EC1 ESP Message	-	ON
639	2	26	14	Time-out or Invalid Data for Configuration of Driveline Line Retarder ESP Message	-	ON
639	2	26	15	Time-out or Invalid CAN Data – Electronic Engine Controller 3 ESP Message	-	ON
639	2	26	16	Time-out or Invalid CAN Data – Electronic Transmission Controller 2-Message Required for ESP	-	ON
639	2	26	17	Time-out or Invalid Data for Configuration of Engine Retarder ESP Message	-	ON
639	2	26	18	Time-out or Invalid Data for Configuration of Exhaust Retarder ESP Message	-	ON
639	2	26	19	Time-out or Invalid Data for Configuration of Transmission Retarder ESP Message	-	ON
639	2	26	20	Invalid Data Transfer Time-out of Driveline Line Retarder ESP Message	-	ON
639	2	26	21	Invalid Data Transfer Time-out of Engine Retarder ESP Message	-	ON
639	2	26	22	Invalid Data Transfer Time-out of Exhaust Retarder ESP Message	-	ON
639	2	26	23	Time-out or Invalid CAN Data – CCVS ESP Message	-	ON
639	2	26	24	Time-out or Invalid CAN Data – TCO ESP Message	-	ON
639	2	26	25	Invalid Data Transfer Time-out of Driveline Line Retarder ESP Message	-	ON
639	2	26	26	ESP Related CM3 Time-out at J1939	-	ON
639	2	26	27	Time-out of message or Invalid Data Received from Transmission Transfer information on J1939 - Message Required for ESP	-	ON
639	2	26	28	Time-out or Invalid CAN Data – Electronic Axle Controller 1ESP Message	-	ON
639	5	11	29	J1939 CAN Messages Are Not Being Transmitted / Received	ON	ON
639	12	11	1	J1939 Serial Link	ON	ON
Wheel Speed Sensor DTCs						
789	1	2	1	Steer Axle Left WSS Excessive Air Gap	ON	ON
789	2	2	3	Steer Axle Left WSS Open or Shorted	ON	ON
789	7	2	5	Steer Axle Left WSS Wheel End	ON	ON
789	8	2	6	Steer Axle Left Erratic Sensor Signal	ON	ON
789	9	2	2	Steer Axle Left WSS Signal Low at Drive Off	ON	ON
789	10	2	4	Steer Axle Left WSS Loss of Sensor Signal	ON	ON
789	13	2	7	Steer Axle Left WSS Tire Size Calibration	ON	ON
790	1	3	1	Steer Axle Right WSS Excessive Air Gap	ON	ON
790	2	3	3	Steer Axle Right WSS Open or Shorted	ON	ON
790	7	3	5	Steer Axle Right WSS Wheel End	ON	ON
790	8	3	6	Steer Axle Right Erratic Sensor Signal	ON	ON
790	9	3	2	Steer Axle Right WSS Signal Low at Drive Off	ON	ON
790	10	3	4	Steer Axle Right WSS Loss of Sensor Signal	ON	ON
790	13	3	7	Steer Axle Right WSS Tire Size Calibration	ON	ON
791	1	4	1	Drive Axle Left WSS Excessive Air Gap	ON	ON
791	2	4	3	Drive Axle Left WSS Open or Shorted	ON	ON
791	7	4	5	Drive Axle Left WSS Wheel End	ON	ON
791	8	4	6	Drive Axle Left Erratic Sensor Signal	ON	ON
791	9	4	2	Drive Axle Left WSS Signal Low at Drive Off	ON	ON
791	10	4	4	Drive Axle Left WSS Loss of Sensor Signal	ON	ON
791	13	4	7	Drive Axle Left Tire Size Calibration	ON	ON
792	1	5	1	Drive Axle Right WSS Excessive Air Gap	ON	ON
792	2	5	3	Drive Axle Right WSS Open or Shorted	ON	ON
792	7	5	5	Drive Axle Right WSS Wheel End	ON	ON
792	8	5	6	Drive Axle Right Erratic Sensor Signal	ON	ON
792	9	5	2	Drive Axle Right WSS Signal Low at Drive Off	ON	ON
792	10	5	4	Drive Axle Right WSS Loss of Sensor Signal	ON	ON
792	13	5	7	Drive Axle Right Tire Size Calibration	ON	ON
793	1	14	1	Additional Axle Left WSS Excessive Air Gap	ON	ON

APPENDIX B: J1939 SPN AND FMI CODES AND THEIR BENDIX® BLINK CODE EQUIVALENTS

SPN (J1939)	FMI (J1939)	Bendix® Blink Code Equivalent(s)		Diagnostic Trouble Code (DTC) Description	Lamp Status	
		(1st Digit)	(2nd Digit)		ABS	ATC/ ESP
793	2	14	3	Additional Axle Left WSS Open or Shorted	ON	ON
793	7	14	5	Additional Axle Left WSS Wheel End	ON	ON
793	8	14	6	Additional Axle Left Erratic Sensor Signal	ON	ON
793	9	14	2	Additional Axle Left WSS Signal Low at Drive Off	ON	ON
793	10	14	4	Additional Axle Left WSS Loss of Sensor Signal	ON	ON
793	13	14	7	Additional Axle Left Tire Size Calibration	ON	ON
794	1	15	1	Additional Axle Right WSS Excessive Air Gap	ON	ON
794	2	15	3	Additional Axle Right WSS Open or Shorted	ON	ON
794	7	15	5	Additional Axle Right WSS Wheel End	ON	ON
794	8	15	6	Additional Axle Right Erratic Sensor Signal	ON	ON
794	9	15	2	Additional Axle Right WSS Signal Low at Drive Off	ON	ON
794	10	15	4	Additional Axle Right WSS Loss of Sensor Signal	ON	ON
794	13	15	7	Additional Axle Right Tire Size Calibration	ON	ON
Pressure Modulator Valve (PMV) DTCs						
795	5	7	7	Steer Axle Left PMV Common Open Circuit	ON	ON
795	13	7	8	Steer Axle Left PMV Configuration Error	ON	ON
796	5	8	7	Steer Axle Right PMV Common Open	ON	ON
796	13	8	8	Steer Axle Right PMV Configuration Error	ON	ON
797	5	9	7	Drive Axle Left PMV Common Open Circuit	ON	ON
797	13	9	8	Drive Axle Left PMV Configuration Error	ON	ON
798	5	10	7	Drive Axle Right PMV Common Open Circuit	ON	ON
798	13	10	8	Drive Axle Right PMV Configuration Error	ON	ON
799	5	16	7	AA Left PMV Common Open Circuit	ON	ON
799	13	16	8	AA Left PMV Configuration Error	ON	ON
800	5	17	7	Additional Axle Right PMV Common Open Circuit	ON	ON
800	13	17	8	AA Right PMV Configuration Error	ON	ON
Miscellaneous DTCs						
801	2	12	4	Retarder Relay Open Circuit or Shorted to Ground	ON	-
801	3	12	5	Retarder Relay Open Circuit or Shorted to Voltage	ON	-
Pressure Modulator Valve (PMV) DTCs						
802	3	12	8	PMV Common Shorted to Voltage	ON	ON
802	4	12	7	PMV Commons Shorted to Ground	ON	ON
Miscellaneous DTCs						
802	12	13	11	ECU DTC (F1A)	ON	ON
802	12	13	12	ECU DTC (F14)	ON	-
805	14	12	9	ATC Disabled to Prevent Brake Fade	-	-
Traction Control Valve (TCV) DTCs						
806	3	18	2	TCV DA Solenoid Shorted to Voltage	ON	ON
806	4	18	1	TCV DA Solenoid Shorted to Ground	-	ON
806	5	18	3	TCV DA Solenoid Open Circuit	-	ON
806	13	18	4	TCV DA Valve Configuration Error	ON	ON
807	3	19	2	TCV SA Solenoid Shorted to Voltage	-	ON
807	4	19	1	TCV SA Solenoid Shorted to Ground	-	ON
807	5	19	3	TCV SA Solenoid Open Circuit	ON	ON
807	13	19	4	TCV SA Valve Configuration Error	ON	ON
Miscellaneous DTCs						
810	7	12	11	Wheel Speed Sensors Reversed on an Axle	ON	ON
811	2	12	6	ABS Dash Indicator Circuit DTC	ON	-
811	13	12	38	Warning Lamp Ground Pin Connected to GND in Conflict with Configuration Settings	ON	-
815	13	14	10	Additional Axle WSS Configuration Error	ON	ON

APPENDIX B: J1939 SPN AND FMI CODES AND THEIR BENDIX® BLINK CODE EQUIVALENTS

SPN (J1939)	FMI (J1939)	Bendix® Blink Code Equivalent(s)		Diagnostic Trouble Code (DTC) Description	Lamp Status	
		(1st Digit)	(2nd Digit)		ABS	ATC/ ESP
Pressure Modulator Valve (PMV) DTCs						
932	3	7	5	Steer Axle Left PMV Hold Solenoid Shorted to Voltage	ON	ON
932	4	7	4	Steer Axle Left PMV Hold Solenoid Shorted to Ground	ON	ON
932	5	7	6	Steer Axle Left PMV Hold Solenoid Open Circuit	ON	ON
933	3	8	5	Steer Axle Right PMV Hold Solenoid Shorted to Voltage	ON	ON
933	4	8	4	Steer Axle Right PMV Hold Solenoid Shorted to Ground	ON	ON
933	5	8	6	Steer Axle Right PMV Hold Solenoid Open Circuit	ON	ON
934	3	9	5	Drive Axle Left PMV Hold Solenoid Shorted to Voltage	ON	ON
934	4	9	4	Drive Axle Left PMV Hold Solenoid Shorted to Ground	ON	ON
934	5	9	6	Drive Axle Left PMV Hold Solenoid Open Circuit	ON	ON
935	3	10	5	Drive Axle Right PMV Hold Solenoid Shorted to Voltage	ON	ON
935	4	10	4	Drive Axle Right PMV Hold Solenoid Shorted to Ground	ON	ON
935	5	10	6	Drive Axle Right PMV Hold Solenoid Open Circuit	ON	ON
936	3	16	5	AA Left PMV Hold Solenoid Shorted to Voltage	ON	ON
936	4	16	4	AA Left PMV Hold Solenoid Shorted to Ground	ON	ON
936	5	16	6	AA Left PMV Hold Solenoid Open Circuit	ON	ON
936	13	16	11	Output Configuration Error - Left Additional Axle Hold	ON	ON
937	3	17	5	AA Right PMV Hold Solenoid Shorted to Voltage	ON	ON
937	4	17	4	AA Right PMV Hold Solenoid Shorted to Ground	ON	ON
937	5	17	6	AA Right PMV Hold Solenoid Open Circuit	ON	ON
937	13	17	11	Output Configuration Error - Additional Axle Right Hold	ON	ON
938	3	7	2	Steer Axle Left PMV Release Solenoid Shorted to Voltage	ON	ON
938	4	7	1	Steer Axle Left PMV Release Solenoid Shorted to Ground	ON	ON
938	5	7	3	Steer Axle Left PMV Release Solenoid Open Circuit	ON	ON
939	3	8	2	Steer Axle Right PMV Release Solenoid Shorted to Voltage	ON	ON
939	4	8	1	Steer Axle Right PMV Release Solenoid Shorted to Ground	ON	ON
939	5	8	3	Steer Axle Right PMV Release Solenoid Open	ON	ON
940	3	9	2	Drive Axle Left PMV Release Solenoid Shorted to Voltage	ON	ON
940	4	9	1	Drive Axle Left PMV Release Solenoid Shorted to Ground	ON	ON
940	5	9	3	Drive Axle Left PMV Release Solenoid Open Circuit	ON	ON
941	3	10	2	Drive Axle Right PMV Release Solenoid Shorted to Voltage	ON	ON
941	4	10	1	Drive Axle Right PMV Release Solenoid Shorted to Ground	ON	ON
941	5	10	3	Drive Axle Right PMV Release Solenoid Open Circuit	ON	ON
942	3	16	2	AA Left PMV Release Solenoid Shorted to Voltage	ON	ON
942	4	16	1	AA Left PMV Release Solenoid Shorted to Ground	ON	ON
942	5	16	3	AA Left PMV Release Solenoid Open Circuit	ON	ON
942	13	16	10	Output Configuration Error - Additional Axle Left Release	ON	ON
943	3	17	2	AA Right PMV Release Solenoid Shorted to Voltage	ON	ON
943	4	17	1	AA Right PMV Release Solenoid Shorted to Ground	ON	ON
943	5	17	3	AA Right PMV Release Solenoid Open Circuit	ON	ON
943	13	17	10	Output Configuration Error - Additional Axle Right Release	ON	ON
Miscellaneous DTCs						
1043	2	12	14	ESP sensor supply too high or too Low	-	ON
1043	2	12	22	U- Bat too high or too Low for ESP sensor	-	ON
1045	2	12	2	Stop Light Switch Defective	ON	ON
1045	2	12	27	Brake Lamp Input Mismatch With Brake Lamp Output	ON	ON
1045	7	12	1	Stop Lamp Switch Not Detected	-	ON

APPENDIX B: J1939 SPN AND FMI CODES AND THEIR BENDIX® BLINK CODE EQUIVALENTS

SPN (J1939)	FMI (J1939)	Bendix® Blink Code Equivalent(s)		Diagnostic Trouble Code (DTC) Description	Lamp Status	
		(1st Digit)	(2nd Digit)		ABS	ATC/ ESP
Pressure Modulator Valve (PMV) DTCs						
1056	2	20	12	Trailer PMV: Hold Function	OFF	ON
1056	3	20	2	Trailer PMV: Release Solenoid Shorted to Voltage	ON	ON
1056	3	20	5	Trailer PMV: hold Solenoid Shorted to Voltage	ON	ON
1056	4	20	1	Trailer PMV: Release Solenoid Shorted to Ground	-	ON
1056	4	20	4	Trailer PMV: hold Solenoid Shorted to Ground	-	ON
1056	5	20	3	Trailer PMV: Release Solenoid Open Circuit	-	ON
1056	5	20	6	Trailer PMV: hold Solenoid Open Circuit	-	ON
1056	5	20	7	Trailer PMV: Common Open Circuit	-	ON
1056	13	20	8	Trailer PMV: Configuration Error	-	ON
Brake Demand/Load Sensor DTCs						
1059	2	24	3	PS3 Open or Shorted	-	ON
1067	2	24	1	PS1 Open or Shorted	-	ON
1067	3	24	5	PS Supply Voltage High Error	-	ON
1067	4	24	7	PS Supply Voltage Low Error	-	ON
1067	6	24	8	PS Supply Voltage Error	-	ON
1067	7	24	6	PS Not Calibrated	-	ON
1067	11	24	4	Primary and Secondary Circuit PS (PS1/PS2 Plausibility Error) Brake Demand	-	ON
1067	14	24	9	Pressure Sensor not configured.	-	ON
1068	2	24	2	PS2 Open or Shorted	-	ON
Miscellaneous DTCs						
1238	14	12	37	ATC disable by switch	-	-
Steering Angle Sensor DTCs						
1807	2	21	3	SAS Static Signal	-	ON
1807	2	21	4	SAS Signal Out of Range	-	ON
1807	2	21	5	SAS Signal Reversed	-	ON
1807	2	21	7	SAS Gradient Error	-	ON
1807	2	21	9	SAS Long Term Calibration Error	-	ON
1807	2	21	10	SAS Plausibility Check (Ref YAW Rate)	-	ON
1807	9	21	8	SAS CAN Time-out	-	ON
1807	12	21	6	SAS Signal Invalid	-	ON
1807	13	21	1	SAS Not Calibrated	-	ON
1807	13	21	2	SAS Calibration in Progress	-	ON
1807	13	21	11	SAS Detected But Not Configured	-	ON
Yaw Rate Sensor DTCs						
1808	2	22	1	YRS Signal Out of Range	-	ON
1808	2	22	2	YRS Reversed Signal	-	ON
1808	2	22	3	YRS Invalid Signal	-	ON
1808	2	22	4	YRS Gradient Error	-	ON
1808	2	22	6	YRS Static BITE Error	-	ON
1808	2	22	7	YRS Dynamic BITE Error	-	ON
1808	2	22	8	YRS Fast Calibration Error	-	ON
1808	2	22	9	YRS Static Calibration Error	-	ON
1808	2	22	10	YRS Normal Calibration Error	-	ON
1808	2	22	12	YRS Plausibility Check (Ref Yaw Rate)	-	ON
1808	2	22	13	YRS Plausibility Error (Inside Model Based Limits)	-	ON
1808	2	22	14	YRS Plausibility Error (Outside Model Based Limits)	-	ON
1808	2	22	16	YRS Vibration Detected	-	ON
1808	9	22	5	YRS CAN Time-out	-	ON
1808	13	22	17	YRS Detected But Not Configured	-	ON
1808	14	23	7	Erratic ESP Signal	-	ON

APPENDIX B: J1939 SPN AND FMI CODES AND THEIR BENDIX® BLINK CODE EQUIVALENTS

SPN (J1939)	FMI (J1939)	Bendix® Blink Code Equivalent(s)		Diagnostic Trouble Code (DTC) Description	Lamp Status	
		(1st Digit)	(2nd Digit)		ABS	ATC/ ESP
Lateral Acceleration Sensor DTCs						
1809	2	23	1	LAS Signal of Range	-	ON
1809	2	23	3	LAS Static Calibration Error	-	ON
1809	2	23	4	LAS Long Term Calibration Error	-	ON
1809	2	23	5	LAS Plausibility Error (Inside Model Based Limits)	-	ON
1809	2	23	6	LAS Plausibility Error (Outside Model Based Limits)	-	ON
1809	13	22	15	YRS- SAS Signal Cross-Check Incomplete	-	ON
1809	13	23	2	LAS Calibration in Progress	-	ON
Miscellaneous						
2011	31	11	26	ABS ECU CAN Address Conflict	ON	-
2051	31	11	27	TPMS ECU CAN Address Conflict - TPMS INDICATOR LAMP ON	-	-
HS/HSA Hill Start Feature DTCs						
2622	2	12	24	HSA lamp Open Circuit or Shorted to GND	ON	-
2622	3	12	26	HSA valve: Solenoid Shorted to Voltage	ON	-
2622	3	12	31	HSA lamp Shorted to Voltage	ON	ON
2622	4	12	25	HSA valve: Solenoid Shorted to Ground	-	-
2622	5	12	33	HSA valve: Solenoid Open Circuit	-	-
Bendix® eTrac™ DTCs						
2984	3	12	34	Bendix® eTrac™ Solenoid Shorted to Voltage	-	ON
2984	4	12	35	Bendix eTrac Solenoid Shorted to Ground	-	ON

Figures Used

Figure 1 - Bendix® ESP® EC-80™ Controller.....	1
Figure 2 - Bendix® WS-24™ Wheel Speed Sensors.....	3
Figure 3 - Example Of A Bendix® M-40X™ Modulator	3
Figure 4 - Examples Of Steering Angle Sensors	3
Figure 5 - Yaw And Brake Demand/Load Sensors.....	4
Figure 6 - Additional Valves Necessary For The Hill Start Feature.....	4
Figure 7 - Bendix ESP EC-80 Controller Features.....	5
Figure 8 - Power Line Without PLC Signal	5
Figure 9 - Power Line With PLC Signal	5
Figure 10 - Bendix ESP EC-80 Controller Indicator Lamp Behavior.....	8
Figure 11 - Vehicle Orientation (Typical)	9
Figure 12 - RSP Example	12
Figure 13 - Yaw Control Example	12
Figure 14 - Typical Vehicle Diagnostic Connector Locations (J1939)	21
Figure 15 - Example Of Blink Code Message	21
Figure 16 - Diagnostic Modes.....	22
Figure 17 - System Configuration Check.....	23
Figure 18 - Bendix® ACom® Diagnostics	24
Figure 19 - The Bendix® Remote Diagnostic Unit.....	24
Figure 20 - Diagnostic Trouble Codes.....	25
Figure 21 - Bendix EC-80 Controller Component Connectors.....	50
Figure 22 - WS-24 Wheel Speed Sensor Installation (S-Cam And Air Disc Brake).....	51
Figures 23 & 24 - Troubleshooting: Wiring Schematics	52-53

Full Table of Contents

Introduction.....	1
Yaw Control (YC).....	3
Roll Stability Program (RSP).....	3
Components.....	3-4
Bendix® eTrac™ Automated Air Suspension Transfer System.....	4
ECU Mounting.....	4
Hardware Configurations.....	4
Bendix® ESP® EC-80™ Controllers USE Power Line Carrier (PLC).....	5
Bendix ESP EC-80 Controller Inputs.....	5
Bendix ESP EC-80 Controller Outputs.....	6-7
Indicator Lamps And Power-Up Sequence.....	8-9
ABS Operation.....	9-10
ATC Operation.....	11-12
Bendix® ESP® ABS With Stability Control.....	12-13
Important Safety Information About The Bendix ESP System.....	13-14
Dynamometer Test Mode.....	14
Automatic Tire Size Calibration.....	14
System Impact During Active Trouble Codes.....	15
ABS Partial Shutdown.....	15
System Reconfiguration.....	16
Electronic Control Unit (ECU) Reconfiguration.....	16
Data Storage.....	16
Troubleshooting.....	17-53
Removal Of The Bendix ESP EC-80 Controller Assembly.....	17
Obtaining A New Bendix ESP EC-80 Controller.....	17
Installing A New Bendix ESP EC-80 Controller.....	17
Steering Angle Sensor Maintenance.....	18
Steering Angle Sensor Calibration.....	18
Removal Of The Yaw Rate/Lateral Acceleration Sensor.....	19
Brake Demand Sensor Calibration.....	20
Pressure Sensor Installation Requirements.....	20
Troubleshooting: Blink Codes and Diagnostic Modes.....	21-23
ECU Diagnostics.....	21
Blink Codes.....	21
Diagnostic Modes.....	22
Troubleshooting: Using PC-Based or Hand-Held Diagnostic Tools.....	24-25
Bendix® ACom® Diagnostic Software.....	24
Bendix® RDU™ (Remote Diagnostic Unit).....	24
Active or Inactive Diagnostic Trouble Codes: Index and Troubleshooting Tests.....	26-47
Troubleshooting: Connectors.....	48
Troubleshooting: Wiring.....	49-53
Glossary.....	54
APPENDIX A: Troubleshooting a 12-7 Blink Code DTC (SID-93 FMI-4) (SPN-0802 FMI-04).....	55
APPENDIX B: J1939 SPN and FMI Codes and their Bendix Blink Code Equivalents.....	56-62

Log-on and Learn from the Best

On-line training that's available when you are – 24/7/365.
Visit www.brake-school.com.



Any references in this document to AMP, DEUTSCH, ITT, METRI-PACK, NEWARK, PACKARD, ROBERT BOSCH, SCHLEMMER, TE, and any other company or trademark are solely for identification and cross reference purposes. The trademarks are the property of their respective companies.