



Service Data

SD-13-4869

Bendix® EC-60™ ABS / ATC / ESP Controllers (Advanced)

See SD-13-4863 for Standard and Premium Controllers

See SD-13-21021 for the Bendix® eTrac™ Automated Air Suspension Transfer System



FIGURE 1 - EC-60™ ADVANCED CONTROLLER

INTRODUCTION

The Bendix® EC-60™ advanced controller is a member of a family of electronic **Antilock Braking System (ABS)** devices designed to help improve the braking characteristics of air braked vehicles - including heavy- and medium-duty buses, trucks, and tractors. ABS controllers are also known as **Electronic Control Units (ECUs)**.

Bendix® ABS uses wheel speed sensors, ABS pressure modulator valves, and an ECU to control either four or six wheels of a vehicle. The Bendix EC-60 controller monitors individual wheel turning motion during braking and adjusts or modulates the brake pressure at the wheel end. When excessive wheel slip, or wheel lock-up is detected, the Bendix EC-60 controller will activate the pressure modulator valves to automatically reduce the brake pressure at one or more of the wheel ends. By these actions, the ABS system helps to maintain the vehicle's lateral stability and steerability during heavy brake applications and during braking on slippery surfaces.

In addition to the ABS function, advanced models of the EC-60™ controller provide ABS-based stability features referred to as **ESP® Electronic Stability Program**. The Bendix ESP system is an ABS-based stability system that enhances vehicle stability by both reducing engine throttle and by applying vehicle braking based on actual vehicle dynamics. Accordingly, the ESP system is available only on specific approved vehicle platforms after vehicle application and development efforts and validation testing. Only certain limited variations of an approved vehicle platform are permitted without further validation of the ESP system application.

ESP stability system consists of Yaw Control (YC) and Roll Stability Program (RSP) features.

ESP® is a registered trademark of DaimlerChrysler and is used by BCVS under license from DaimlerChrysler.

The driver is always responsible for the control and safe operation of the vehicle at all times. The Bendix® ESP® stability system does not replace the need for a skilled, alert professional driver, reacting appropriately and in a timely manner, and using safe driving practices.

TABLE OF CONTENTS	PAGE
General System Information	
Introduction	1
Components	3-4
Hardware Configurations	4
Bendix EC-60 Controller Inputs & Outputs	5-7
Indicator Lamps and Power-Up Sequence	8-9
ABS Operation	9
ATC Operation	11-12
Advanced ABS With Stability	12-13
Important Safety Information About	
The ESP Stability System	13-14
Dynamometer Test Mode	14
System Impact During Active Trouble Codes	15
System Reconfiguration	16
Troubleshooting	17-48
Sensor Calibration	17-19
Blink Codes and Diagnostic Trouble Codes	21-23
Wiring Schematic	48
Glossary	49
J1587 SID and FMI Codes	51-55
UDS Codes	56-60

Additional features include **Automatic Traction Control (ATC)**. Bendix ATC can improve vehicle traction during acceleration, and lateral stability while accelerating through curves. ATC utilizes **Engine Torque Limiting (ETL)** where the ECU communicates with the engine's controller and/or **Differential Braking (DB)** where individual wheel brake applications are used to improve vehicle traction. Advanced Bendix EC-60 controllers have a drag torque control feature which reduces driven-axle wheel slip (due to driveline inertia) by communicating with the engine's controller and increasing the engine torque.

For vehicles with the **Hill Start Feature** optional feature, this system interfaces between the transmission and braking system to help the driver prevent the vehicle from rolling downhill when moving up a steep incline from a stationary position.

GENERAL SAFETY GUIDELINES



WARNING! PLEASE READ AND FOLLOW THESE INSTRUCTIONS



TO AVOID PERSONAL INJURY OR DEATH:

When working on or around a vehicle, the following guidelines should be observed **AT ALL TIMES**:

- ▲ Park the vehicle on a level surface, apply the parking brakes and always block the wheels. Always wear personal protection equipment.
- ▲ Stop the engine and remove the ignition key when working under or around the vehicle. When working in the engine compartment, the engine should be shut off and the ignition key should be removed. Where circumstances require that the engine be in operation, **EXTREME CAUTION** should be used to prevent personal injury resulting from contact with moving, rotating, leaking, heated or electrically-charged components.
- ▲ Do not attempt to install, remove, disassemble or assemble a component until you have read, and thoroughly understand, the recommended procedures. Use only the proper tools and observe all precautions pertaining to use of those tools.
- ▲ If the work is being performed on the vehicle's air brake system, or any auxiliary pressurized air systems, make certain to drain the air pressure from all reservoirs before beginning ANY work on the vehicle. If the vehicle is equipped with a Bendix® AD-IS® air dryer system, a Bendix® DRM™ dryer reservoir module, or a Bendix® AD-9si® air dryer, be sure to drain the purge reservoir.
- ▲ Following the vehicle manufacturer's recommended procedures, deactivate the electrical system in a manner that safely removes all electrical power from the vehicle.
- ▲ Never exceed manufacturer's recommended pressures.
- ▲ You should consult the vehicle manufacturer's operating and service manuals, and any related literature, in conjunction with the Guidelines above.
- ▲ Never connect or disconnect a hose or line containing pressure; it may whip and/or cause hazardous airborne dust and dirt particles. Wear eye protection. Slowly open connections with care, and verify that no pressure is present. Never remove a component or plug unless you are certain all system pressure has been depleted.
- ▲ Use only genuine Bendix® brand replacement parts, components and kits. Replacement hardware, tubing, hose, fittings, wiring, etc. must be of equivalent size, type and strength as original equipment and be designed specifically for such applications and systems.
- ▲ Components with stripped threads or damaged parts should be replaced rather than repaired. Do not attempt repairs requiring machining or welding unless specifically stated and approved by the vehicle and component manufacturer.
- ▲ Prior to returning the vehicle to service, make certain all components and systems are restored to their proper operating condition.
- ▲ For vehicles with Automatic Traction Control (ATC), the ATC function must be disabled (ATC indicator lamp should be ON) prior to performing any vehicle maintenance where one or more wheels on a drive axle are lifted off the ground and moving.
- ▲ The power **MUST** be temporarily disconnected from the radar sensor whenever any tests **USING A DYNAMOMETER** are conducted on a vehicle equipped with a Bendix® Wingman® system.

CAUTION

Even with ESP-equipped vehicles, the driver remains responsible for ensuring vehicle stability during operation. The ESP system can only function within the limits of physics. ESP functionality mitigates potential vehicle stability incidents, but cannot prevent them in all cases. Other factors such as driving too fast for road, traffic or weather conditions, oversteering, an excessively high vehicle Center of Gravity (CG), or poor road conditions can cause vehicle instability that is beyond the capability of any stability system to mitigate. In addition, the effectiveness of ESP can be greatly reduced on vehicles towing multiple trailer combinations.

CAUTION

The ESP stability system may only be used on vehicles tested and approved by Bendix engineering. ESP installations require on-vehicle testing and Bendix® EC-60™ parameter tuning. See "Advanced ABS with Stability Control" on page 12 for further details.

Accordingly, the Bendix EC-60 controller is provided with a corresponding parameter data set that is validated for a specific vehicle platform. Therefore, specific steps are necessary should a replacement ECU be required. See "Obtaining a New Bendix EC-60 Advanced Controller" on page 18 for further details.

ESP-equipped vehicles should not be driven on high-banked roads – such as those found on high-speed test or race tracks. Test personnel must have ESP functionality disabled prior to operating an ESP vehicle on such tracks.

YAW CONTROL (YC)

Advanced ECU can include Yaw Control (YC) functionality, which has the ability to apply brakes to individual wheel ends, as well as applying the trailer brakes, to counteract trailer “push” that, during certain maneuvers, could lead to a loss-of-control or a jackknife incident. See "Yaw Stability" on page 9 for further details.

ROLL STABILITY PROGRAM (RSP)

The Bendix Roll Stability Program (RSP), is an all-axle ABS solution that helps reduce vehicle speed by reducing the engine's throttle and applying all vehicle brakes as needed, reducing the vehicle's tendency to roll over. RSP focuses on reducing the vehicle's speed below the critical roll threshold during direction-changing maneuvers such as driving on curved highway exit ramps or obstacle avoidance maneuvers on dry, high friction surfaces. See "Advanced ABS with Stability Control" on page 12 for further details.

⚠ WARNING

During an RSP system intervention, the vehicle **automatically decelerates**. RSP can slow the vehicle with or **without the operator applying the brake pedal**, and **even when the operator is applying the throttle**.

COMPONENTS

The Bendix EC-60 controller's ABS function utilizes the following components:

- Bendix® WS-24™ wheel speed sensors (4 or 6, depending on configuration). Each sensor is installed with a Bendix Sensor Clamping Sleeve
- Bendix® M-32™ or M-32QR™ Pressure Modulator Valves (4, 5, or 6 depending on configuration)
- Dash-mounted tractor ABS Indicator Lamp
- Service brake relay valve
- Dash-mounted trailer ABS Indicator Lamp
- Optional blink code activation switch
- Optional ABS off-road switch



FIGURE 2 - BENDIX® WS-24™ WHEEL SPEED SENSORS

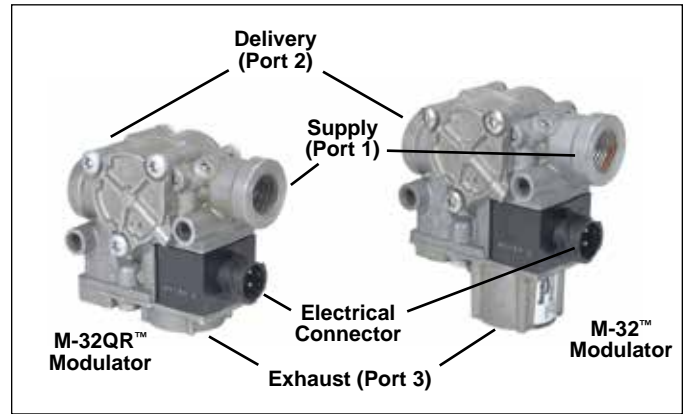

FIGURE 3 - M-32™ AND M-32QR™ MODULATORS

The Bendix EC-60 controller ESP/RSP function utilizes the following additional components:

- Steer Axle Traction Control Valve (may be integral to the service brake relay valve or a stand-alone device)
- Dash-mounted ESP status/indicator lamp (also serves as the ATC status/indicator lamp)
- Bendix SAS-60™ Steering Angle Sensor (mounted to the steering column - See Figure 4)

⚠ CAUTION: When replacing a steering wheel, take care not to damage the Steering Angle Sensor or interfere with its operation, and the Steering Angle Sensor must be recalibrated (see *Troubleshooting section*)

- Bendix® YAS-60™ or YAS-70X™ Yaw Rate/Lateral Acceleration Sensors (typically mounted to a cross-member near the back of the vehicle cab)
- Brake Demand Sensors (installed in the primary and secondary delivery circuits)
- Load Sensor (typically installed in the suspension air bag)
- An additional Modulator Valve (Bendix® M-32™ or M-32QR™ Pressure Modulator Valve) that controls pressure apply to trailer brakes during system intervention



FIGURE 4 - STEERING ANGLE SENSORS

The Bendix® EC-60™ controller ATC function utilizes the following additional components:

- Drive axle traction control valve (may be integral to the service brake relay valve or a stand-alone device)
- Dash-mounted ATC status/indicator lamp
- J1939 serial communication to engine control module
- Stop lamp switch input (may be provided using the ECU hardware input or J1939)
- Optional ATC mud/snow switch (sometimes referred to as an ATC off-road switch)

The EC-60 controller Hill Start Feature utilizes the following additional components:

- Bendix® AT-3™ Traction control valve
- Dash-mounted HSA Status/indicator lamp
- Dash-mounted enable/disable Switch
- Bendix® RV-3™ Pressure reducing valve
- Bendix® DC-4® Double check valve

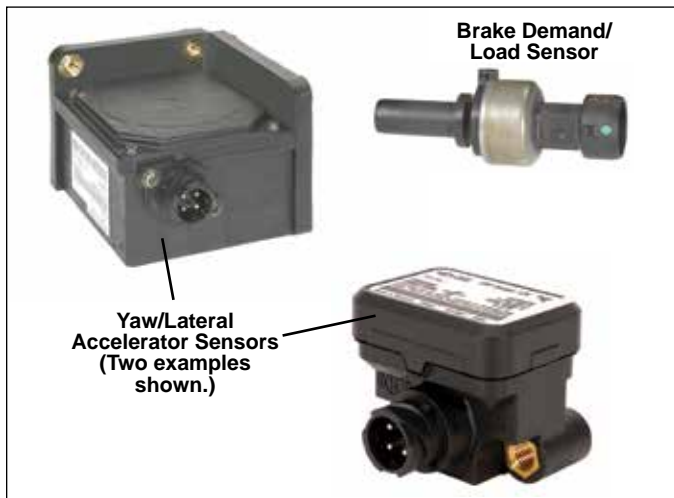

FIGURE 5 - YAW AND BRAKE DEMAND/LOAD SENSORS

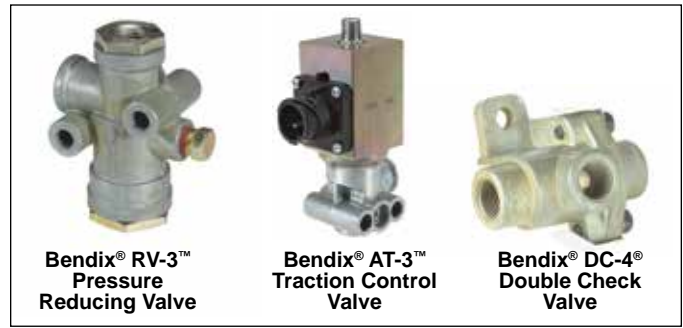

FIGURE 6 - ADDITIONAL VALVES NECESSARY FOR THE HILL START FEATURE

BENDIX® ETRAC™ AUTOMATED AIR SUSPENSION TRANSFER SYSTEM

The Bendix® eTrac™ automated air pressure transfer system is used on 6 x 2 semi-tractors that feature Bendix® premium and advanced Antilock Brake Systems (ABS). This system complements the Bendix® Smart Automatic Traction Control (ATC™) feature of our ABS system to provide improved traction at low speeds (e.g. pulling away on an inclined ramp, or in slippery conditions such as mud or snow-covered surfaces, etc.) When active, the Bendix eTrac system vents — or “dumps” — the air pressure of the tag axle suspension air bags, and increases the air pressure in the drive axle suspension air bags to a pre-determined maximum. This action helps the drive axle to gain more traction.

See SD-13-21021 for more information.

ECU MOUNTING

The Bendix® EC-60™ advanced cab-mounted controller is not protected against moisture, and must be mounted in an environmentally protected area.

All wire harness connectors must be properly seated. The use of secondary locks is strongly recommended.

Cab ECUs utilize connectors from the AMP MCP 2.8 product family.

HARDWARE CONFIGURATIONS

Advanced Bendix® EC-60™ controllers support applications up to six sensor/six modulator (6S/6M) installations with ATC and drag torque control. They can support HSA functions. All 12 volt models support PLC. 24 volt models do not support PLC. See Chart 1 for more details.

ABS Off-Road	ATC	ATC Mud/Snow	Blink Codes	ESP/RSP	HSA	Bendix® eTrac™ system*	Input Voltage	PLC	PMVs	Retarder Relay	Sensors	Serial Communication	
												J1587	J1939
✓	✓	Optional	✓	✓	Optional	Optional	12/24	✓	4/5/6	✓	4/6	✓	✓

*For information about the Bendix® eTrac™ automated air suspension transfer system, see SD-13-21021

CHART 1 - BENDIX® EC-60™ ADVANCED CONTROLLER FEATURES

ADVANCED BENDIX EC-60 CONTROLLERS USE POWER LINE CARRIER (PLC)

All new towing vehicles built since March 1, 2001 have had an in-cab trailer ABS Indicator Lamp installed.

Trailers built since March 1, 2001 transmit the status of the trailer ABS over the power line (the blue wire of the J560 connector) to the tractor using a Power Line Carrier (PLC) signal. See Figures 7 and 8. Typically the signal is broadcast by the trailer ABS ECU.

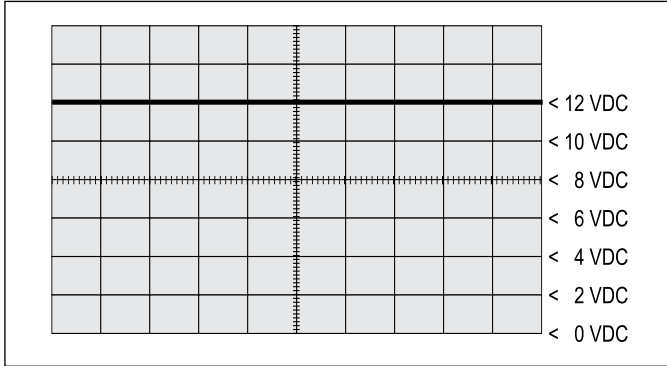

FIGURE 7 - POWER LINE WITHOUT PLC SIGNAL

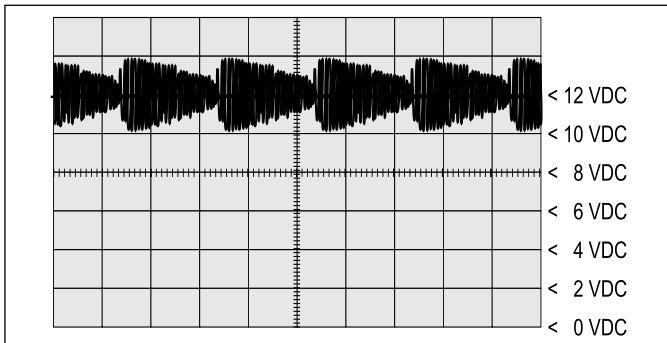

FIGURE 8 - POWER LINE WITH PLC SIGNAL

The application of PLC technology for the heavy vehicle industry in North America is known as “PLC4Trucks.”

The Advanced Bendix EC-60 controller supports PLC communications in accordance with SAE J2497.

PLC SIGNAL

An oscilloscope can be used to measure or identify the presence of a PLC signal on the power line. The PLC signal is an amplitude and frequency modulated signal. Depending on the filtering and load on the power line, the PLC signal amplitude can range from 5.0mVp-p to 7.0 Vp-p. Suggested oscilloscope settings are AC coupling, 1 volt/div, 100 μ sec/div. The signal should be measured at the ignition power input of the Bendix EC-60 controller.

Note: An ABS trailer equipped with PLC, or a PLC diagnostic tool, must be connected to the vehicle in order to generate a PLC signal on the power line.

BENDIX EC-60 CONTROLLER INPUTS

Battery and Ignition Inputs

The ECU operates at a nominal supply voltage of 12 or 24 volts, depending on the ECU. The battery input is connected through a 30 amp fuse directly to the battery.

The ignition input is applied by the ignition switch circuit through a 5 amp fuse.

Ground Input

The Bendix EC-60 controller supports one ground input. See page 48 for a system schematic.

ABS Indicator Lamp Ground Input

Advanced Bendix EC-60 cab ECUs require a second ground input (X1-12) for the ABS indicator lamp. The X1 wire harness connector contains an ABS indicator lamp interlock (X1-15), which shorts the ABS indicator lamp circuit (X1-18) to ground if the connector is removed from the ECU.

Bendix® WS-24™ Wheel Speed Sensors

Wheel speed data is provided to the Bendix EC-60 controller from the WS-24™ wheel speed sensor (see Figure 2). Vehicles have an exciter ring (or “tone ring”) as part of the wheel assembly, and as the wheel turns, the teeth of the exciter ring pass the wheel speed sensor, generating an AC signal. The Bendix EC-60 controller receives the AC signal, which varies in voltage and frequency as the wheel speed changes.

Vehicle axle configurations determine the number of WS-24™ wheel speed sensors that must be used. A vehicle with a single rear axle requires four wheel speed sensors. Vehicles with two rear axles can utilize six wheel speed sensors for optimal performance.

Diagnostic Blink Code Switch

A momentary switch that grounds the ABS Indicator Lamp output is used to place the ECU into the diagnostic blink code mode and is typically located on the vehicle’s dash panel.

Optional ABS Off-Road Switch and Indicator Lamp Operation

Advanced Bendix EC-60 controllers use an optional dash-mounted switch for the operator to place the ECU into the ABS off-road mode. See "Optional ABS Off-Road Mode" on page 10 for further details. In some cases, ECUs may also be put into the ABS off-road mode by one of the other vehicle control modules, using a J1939 message to the Bendix EC-60 controller.

(If you need to know if this Bendix EC-60 controller uses a J1939 message to operate the lamp, e-mail ABS@bendix.com, specifying the ECU part number, or call 1-800-AIR-BRAKE and speak to the Bendix TechTeam.)

⚠ WARNING: The ABS off-road mode should not be used on normal, paved road surfaces because vehicle stability and steerability may be adversely affected. When the ECU is placed in the ABS off-road mode, the ABS Indicator Lamp will flash constantly (at a rate of once per 2.5 seconds) to notify the vehicle operator that the off-road mode is active.

Optional ATC Mud/Snow (Off-Road) Switch and Indicator Lamp Operation (see also page 8.)

Advanced controllers use a dash-mounted switch for the operator to place the ECU into the ATC Mud/Snow mode.

Optional Hill Start Feature Switch and Indicator Lamp Operation (see also page 8.)

Advanced controllers use a dash-mounted switch for the operator to place the ECU into the Hill Start Assist (HSA) mode. HSA interfaces between the transmission and braking system to help the driver prevent the vehicle from rolling downhill when moving up a steep incline from a stationary position.

⚠ WARNING: With HSA option you lose the ABS off-road function and the retarder relay output.

When the ECU is placed in the HSA off-road mode, the HSA Indicator Lamp will flash constantly (at a rate of once per 2.5 seconds) to notify the vehicle operator that the HSA mode is active. The ECU receives J1939 messages from the transmission to engage the HSA components. When engaged, the HSA system applies 44 psi to the rear brakes for three (3) seconds then releases. This function is totally controlled by the automatic transmission.

Stop Lamp Switch (SLS)

The Advanced Bendix EC-60 controller monitors the vehicle stop lamp status. Certain vehicle functions, such as ATC and All-Wheel Drive (AWD), use the status of the stop lamp to determine when the driver makes a brake application. This can be provided to the ECU via J1939 communications, or hardware input.

Brake Demand Sensors

The brake demand sensors provide the controller with an indication of driver-applied brake pressure. One is installed in the primary air brake circuit, and another is installed in the secondary air brake circuit.

Load Sensor

The load sensor provides the controller with an indication of the vehicle load. It is typically installed in one of the suspension air bags.

Bendix® SAS-60™ Steering Angle Sensor

The Steering Angle Sensor (SAS) is used to provide driver steering input to the controller. It reports the steering wheel position to the controller utilizing a dedicated serial communications link that is shared with the Yaw Rate sensor. The controller supplies the power and ground inputs to the Bendix SAS-60 sensor.

The Bendix SAS-60 sensor is available with two different styles of wire harness connectors. (See Figure 4.)

Bendix® YAS-60™ or YAS-70X™ Yaw Rate/Lateral Acceleration Sensors

Bendix yaw rate/lateral acceleration sensors are used to provide the controller an indication of vehicle lateral acceleration and rotation around the vertical axis. This information is provided to the controller utilizing a dedicated serial communications link that is shared with the Bendix SAS-60 sensor. The controller supplies the power and ground inputs to the yaw rate sensor.

BENDIX® EC-60™ CONTROLLER OUTPUTS

Bendix® M-32™ and M-32QR™ Pressure Modulator Valves (PMV)

The Bendix M-32 and M-32QR pressure modulator valves (PMV) are operated by the Bendix EC-60 controller to modify driver applied air pressure to the service brakes during ABS, ATC, RSP or YC activation (See page 3). The PMV is an electropneumatic control valve and is the last valve that air passes through on its way to the brake chamber. The modulator hold and release solenoids are activated to "modulate" or "control" the brake pressure during an antilock braking event. The hold solenoid is normally open and the release solenoid is normally closed, such that the PMV nominally allows air to flow through. This design allows for air delivery to brake chambers in the event of electrical trouble.

The Advanced Bendix EC-60 controller also utilizes an additional PMV for control of the trailer service brakes during stability interventions.

Traction Control Valve (TCV)

Advanced Bendix EC-60 controllers use two TCVs, one on the steer axle and one on the drive axle. The TCV may be a separate valve or integrated into the rear axle relay valve.

The controller will activate the drive axle TCV during differential braking ATC events.

During stability interventions, the ECU will activate both the steer axle and drive axle TCVs as required.

Stop Lamp Output

The controller provides an output to control a relay that illuminates the vehicle stop lamps during stability interventions. This information is also available using the J1939 serial communications link.

ABS Indicator Lamp Control with Optional Diagnostic Blink Code Switch

The Advanced Bendix EC-60 controller has internal circuitry to control the ABS Indicator Lamp on the dash panel.

The ABS Lamp Illuminates:

1. During power up (e.g. when the vehicle is started) for approximately 3 seconds and turns off after the self test is completed, providing no **Diagnostic Trouble Codes (DTCs)** are present on the ECU.
2. When full ABS operation is not available due to presence of a DTC on the ECU.
3. If the ECU is unplugged or has no power.
4. When the ECU is placed into the ABS off-road mode (the lamp flashes steadily at a rate of once per 2.5 sec.).
5. To display blink codes for diagnostic purposes after the external diagnostic switch is activated.

The Bendix EC-60 controller may communicate with other vehicle control modules to operate the ABS Indicator Lamp using serial communications. (If you need to know if this Bendix® EC-60™ controller uses serial communications to operate the lamp, e-mail ABS@bendix.com, specifying the ECU part number, or call 1-800-AIR-BRAKE and speak to the Bendix Tech Team.)

Indicator Lamp Control Using Serial Communications Links

As mentioned above, depending on the vehicle manufacturer, the dash indicator lamps (ABS, ATC, ESP and trailer ABS) may be controlled using serial communications links. In these cases, the EC-60™ controller will send a serial communications message over the J1939 or J1587 links indicating the required status of the lamp(s). Another vehicle control module receives the message and controls the indicator lamp(s).

Dynamometer Mode Indicator Lamp Operation

When the Bendix® EC-60™ controller is put into the Dynamometer mode for testing purposes, the ATC Indicator Lamp will be illuminated.

Retarder Relay Disable Output

The retarder relay disable output may be used to control a retarder disable relay. When configured to use this output, the ECU will energize the retarder disable relay and inhibit the use of the retarder as needed.

If the ECU is configured for Hill Start Assist (HSA), the retarder relay output pin is used to control the HSA status lamp. The vehicle loses the retarder relay function.

SAE J1939 Serial Communications

A Controller Area Network (CAN) data link (SAE J1939) is provided for communication. This link is used for various functions, such as:

- To disable retarding devices during ABS operation.
- To request that the torque converter disable lock-up during ABS operation
- To share information such as wheel speed and ECU status with other vehicle control modules.

Advanced Bendix EC-60 controllers utilize the J1939 data link for:

- ATC and drag torque control functions.
- Vehicle stability functions.

Trailer ABS Indicator Lamp Control

The Advanced Bendix EC-60 controller will activate a trailer ABS Indicator Lamp (located on the dash panel) that indicates the status of the trailer ABS unit on one, or more trailers, or dollies that are equipped with PLC functionality. Typically, the Bendix EC-60 controller directly controls the trailer ABS Indicator Lamp based on the information it receives from the trailer ABS, via PLC.

Alternatively, some vehicles require the Bendix EC-60 controller to activate the trailer ABS Indicator Lamp by communicating with other vehicle controllers using serial communications.

(If you need to know if this Bendix EC-60 controller uses a serial communications message to operate the lamp, e-mail ABS@bendix.com, specifying the ECU part number, or call 1-800-AIR-BRAKE and speak to the Bendix TechTeam.)

SAE J1708/J1587 Serial Communications

An SAE J1708 data link, implemented according to SAE J1587 recommended practice, is available for diagnostic purposes, as well as ECU status messages.

Interaxle Differential Lock Control (AWD Transfer Case)

Advanced ECUs can control the interaxle differential lock (AWD transfer case). This is recommended on AWD vehicles, but the ECU must be specially configured to provide this feature. E-mail ABS@bendix.com for more details.

INDICATOR LAMPS AND POWER-UP SEQUENCE

NOTICE: The vehicle operator should verify proper operation of all installed indicator lamps (ABS, ATC/ESP, and trailer ABS) when applying ignition power and during vehicle operation. See Chart 2.

Lamps that do not illuminate as expected when ignition power is applied, or remain illuminated, indicate the need for maintenance.

Dash Lamps

		Mode	ABS Lamp	ATC/ESP Lamp	Trailer ABS Lamp	HSA Lamp	Comments	
At Vehicle Start Up	Ignition on - start up (trailer with PLC)		On for 3 seconds*	On for 2.5 seconds*	On for 3 seconds**	On for 3 seconds	*If any of the described lamp behaviors do not occur — or if the lamp remains on during operation — have the vehicle serviced by a qualified mechanic as soon as possible to restore full system functionality.	
	3 seconds after ignition (with no Diagnostic Trouble Codes)		Lamp Off*	Lamp Off*	Lamp Off*	Lamp Off*		
Special Mode Operation	ABS Off-Road Mode	Normal	Lamp flashes slowly (every 2.5 seconds)	Lamp OFF	<ul style="list-style-type: none"> • Uses dash switch • Not for firm road surfaces • Allows more wheel lock-up (less ABS intervention) • Mode only applies under 25 mph (Over 25 mph, the system reverts to full ABS — including ATC/ESP — and lamp goes off.) 			
		During an ATC Event		Flashes quickly				
	Vehicles with the Hill Start Feature ("Hill Start Assist")		During HSA Event	Lamp OFF				Lamp remains ON if HSA DTC is present
			HSA Manually Disabled	Flashes slowly				
Deep Mud/Snow/Mode	Normal	Off	Flashes slowly (every 2.5 seconds)	<ul style="list-style-type: none"> • Uses dash switch • Increases allowable wheel slip during ATC interventions • Not for firm road surfaces 				
	During an ATC/ESP Event	Off	Flashes quickly					
During an Automatic Traction Control (ATC) Event				Flashes quickly	• Reduces wheel slip during acceleration at low speeds			
During Dynamometer Mode				Lamp ON (ATC Disabled)	<ul style="list-style-type: none"> • Disables ATC monitoring functions • When not in Dynamometer Mode, an illuminated lamp indicates an ATC trouble code is present 			
During an ESP Event				Flashes quickly	• System intervenes to reduce the risk of rollovers, loss-of-control, etc.			

ABS System Status Indicators at Start-Up

Powered Vehicle ABS Indicator Lamp: ON from 0 to 3.0s, OFF after 3.0s.

Trailer ABS Indicator Lamp (PLC Detected):** ON from 0 to 2.5s, OFF after 2.5s.

Trailer ABS Indicator Lamp (PLC Not Detected):** ON from 0 to 3.0s, OFF after 3.0s.

ATC/ESP System Status Indicator at Start-Up

ATC/ESP enabled: ON from 0 to 2.5s, OFF after 2.5s.

No ESP or ATC: ON from 0 to 3.0s, OFF after 3.0s.

*Some vehicle manufacturers may illuminate the trailer ABS indicator lamp at power-up regardless of whether a PLC signal is detected from the trailer or not. Consult the vehicle manufacturer's documentation for more details.

CHART 2 - BENDIX® EC-60™ INDICATOR LAMP BEHAVIOR

ABS Indicator Lamp Operation (Bulb Check)

The ECU will illuminate the ABS Indicator Lamp for approximately three seconds when ignition power is applied, after which the lamp will extinguish if no diagnostic trouble codes are detected.

The ECU will illuminate the ABS Indicator Lamp whenever full ABS operation is not available due to a diagnostic trouble code. In most cases, partial ABS is still available.

ATC/ESP Status/Indicator Lamp Operation

The ECU will illuminate the ATC/ESP lamp for approximately 2.5 seconds when ignition power is applied, after which the lamp will extinguish, if no diagnostic trouble codes are detected. The ECU will continuously illuminate the ATC/ESP Indicator Lamp whenever ESP or ATC is disabled due to a diagnostic trouble code.

During an ESP or ATC intervention, the lamp will flash rapidly (2.5 times per second). When the ECU is placed in the ATC Mud/Snow (off-road) mode, the lamp will flash slowly at a rate of once every 2.5 seconds.

Trailer ABS Indicator Lamp Operation

The ECU will control the Trailer ABS Indicator Lamp when a PLC signal (SAE J2497) from a trailer ABS ECU is detected.

Hill Start Assist (HSA) Indicator Lamp Operation

Vehicles with HSA enabled, will illuminate the HSA Indicator Lamp when ignition power is applied, after which the lamp will extinguish if there are no issues with the HSA system.

ECU Configuration Test

Within two seconds of the application of ignition power, the ECU will perform a test to detect system configuration with regards to the number of wheel speed sensors and PMVs. This can be audibly detected by a rapid cycling of the PMVs.

(Note: The ECU will not perform the configuration test when wheel speed sensors show that the vehicle is in motion.)

Pressure Modulator Valve and Traction Control Valve Chuff Test

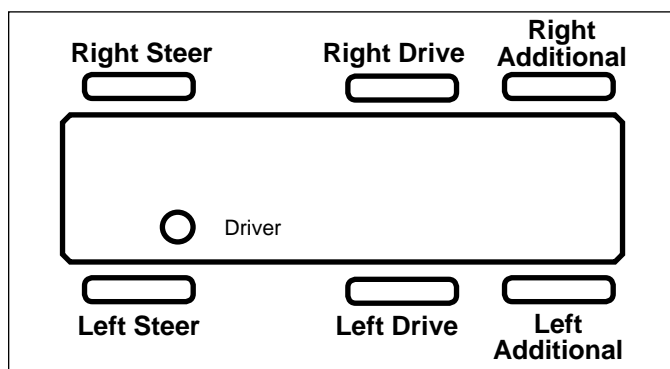

FIGURE 9 - VEHICLE ORIENTATION (TYPICAL)

After the performance of the configuration test, the Bendix® EC-60™ controller will perform a Bendix-patented PMV and TCV Chuff Test. The Chuff Test is an electrical and

pneumatic PMV test that can assist maintenance personnel in verifying proper PMV wiring and installation.

When ignition power is applied, each modulator solenoid is briefly energized. If the air system is fully charged and the service brake pedal is depressed during ignition, the modulator creates a single, sharp audible “chuff” of air pressure. The modulators are energized in a certain pattern, as follows: right front, left front, right rear, left rear.

This test is performed only when the vehicle is stationary (if the vehicle moves the chuff test will not be performed).

The Bendix EC-60 controller will perform a PMV chuff test on all installed modulators in the following order:

- Steer Axle Right PMV
- Steer Axle Left PMV
- Drive Axle Right PMV
- Drive Axle Left PMV
- Additional Axle Right PMV
- Additional Axle Left PMV
- Drive Axle TCV

The pattern will then repeat itself.

If equipped with a Bendix EC-60 advanced controller, following the completion of the second round of PMV & TCV chuff tests, the controller (if configured to do so) will perform a test to cross-check the trailer PMV operation with the vehicle stop lamps. If the trailer PMV circuit is mis-wired (including the steer axle TCV), the PMV will exhaust a large amount of air, or none at all.

NOTICE: If there are any active Diagnostic Trouble Codes, the stop lamp cross-check portion of the chuff test will not be carried out until all DTCs are fully diagnosed and corresponding repairs are successfully conducted. The ESP/ATC dash indicator will also be illuminated when there are active ABS, ATC or ESP DTCs.

The ECU will not perform the PMV Chuff Test when wheel speed sensors show that the vehicle is in motion.

ABS OPERATION

Bendix® ABS uses wheel speed sensors, ABS pressure modulator valves, and an ECU to control either four or six wheels of a vehicle. The Bendix EC-60 controller monitors individual wheel turning motion during braking and adjusts or modulates the brake pressure at the wheel end. When excessive wheel slip, or wheel lock-up is detected, the Bendix EC-60 controller will activate the pressure modulator valves to automatically reduce the brake pressure at one or more of the wheel ends. By these actions, the ABS system helps to maintain the vehicle's lateral stability and steerability during heavy brake applications and during braking on slippery surfaces.

Steer Axle Control

Although both wheels of the steer axle have their own wheel speed sensor and pressure modulator valve, the Bendix EC-60 controller blends the applied braking force between the two steering axle brakes. This Bendix patented brake application control, called Modified Individual Regulation (MIR), is designed to help reduce steering wheel pull during an ABS event on road surfaces with poor traction (or areas of poor traction, e.g. asphalt road surfaces with patches of ice).

Single Drive Axle Control (4x2 Vehicle)

For vehicles with a single rear drive axle (4x2), the brakes are operated independently by the Bendix EC-60 controller, based on the individual wheel behavior.

Dual Drive Axle Control (4S/4M Configuration)

For vehicles with dual drive axles (6x4) using a 4S/4M configuration, one ABS modulator controls both right-side rear wheels and the other modulator controls both left-side rear wheels. Both wheels on each side receive equal brake pressure during an ABS stop. The rear wheel speed sensors must be installed on the axle with the lightest load.

Dual Rear Axle Control (6S/6M Configuration)

For vehicles with dual rear axles (6x4, 6x2) using a 6S/6M configuration, the rear wheels are controlled independently. Therefore, brake application pressure at each wheel is adjusted according to the individual wheel behavior on the road surface.

6x2 Vehicles with 6S/5M Configuration

6x2 vehicles can utilize a 6S/5M configuration, with the additional axle (a non-driven rear axle) having two sensors, but only one Pressure Modulator Valve. In this case, the PMV controls both wheels on the additional axle. The additional axle wheels would receive equal brake pressure, based on the wheel that is currently experiencing the most wheel slip.

Normal Braking

During normal braking, brake pressure is delivered through the ABS PMV and into the brake chamber. If the ECU does not detect excessive wheel slip, it will not activate ABS control, and normal vehicle service braking is applied.

Retarder Brake System Control

On surfaces with low traction, application of the retarder can lead to high levels of wheel slip at the drive axle wheels, which can adversely affect vehicle stability.

To prevent this, the Bendix® EC-60™ controller switches off the retarder as soon as a lock-up is detected at one (or more) of the drive axle wheels.

When the ECU is placed in the ABS off-road mode (on vehicles equipped with this optional feature), it will switch off the retarder only when ABS is active on a steer axle wheel and a drive axle wheel.

Optional ABS Off-Road Mode

On some road conditions, particularly when the driving surface is soft, the stopping distance with conventional ABS may be longer than without ABS. This can occur when a locked wheel on soft ground or loose gravel plows up the road surface in front of the tire, changing the rolling friction value. Although vehicle stopping distance with a locked wheel (in the absence of ABS) may be shorter than corresponding stopping distance with conventional ABS control, vehicle steerability and stability would be reduced.

Advanced Bendix EC-60 controllers have an optional dash switch that initiates a modified ABS control mode (known as "off-road ABS") that more effectively accommodates these soft road conditions to shorten stopping distance while maintaining optimal vehicle steerability and stability.

Note: Off-road mode is not available if the vehicle is equipped with Hill Start Assist (HSA).

⚠ WARNING: The ABS off-road mode should not be used on normal, paved road surfaces because vehicle stability and steerability may be reduced. The ABS Indicator Lamp will flash slowly to indicate to the driver that the ABS off-road mode is engaged.

⚠ CAUTION: When ABS off-road mode is engaged, stability functions are disabled at speeds below approximately 25 mph. The ATC/ESP dash lamp will illuminate to indicate to the driver that the stability system is disabled.

The vehicle manufacturer should provide the optional ABS off-road function only for vehicles that operate on unpaved surfaces or that are used in off-road applications, and is responsible for ensuring that vehicles equipped with the ABS off-road function meet all FMVSS-121 requirements and have adequate operator indicators and instructions.

The vehicle operator activates the off-road function with a switch on the dash panel. A flashing ABS Indicator Lamp indicates to the driver that the ABS off-road function is engaged. To exit the ABS off-road mode, depress and release the switch. A new ignition cycle will also cause the ECU to exit the ABS off-road mode.

All-Wheel Drive (AWD) Vehicles

AWD vehicles with an engaged interaxle differential (steer axle to rear axle)/AWD transfer case may have negative effects on ABS performance. Optimum ABS performance is achieved when the lockable differentials are disengaged, allowing individual wheel control.

Advanced Bendix EC-60 controllers can be programmed specifically for this configuration to control the differential lock/unlock solenoid in the AWD transfer case. When programmed to do so, the ECU will disengage the locked interaxle/AWD transfer case during an ABS event and reengage it once the ABS event has ended.

ATC OPERATION

ATC Functional Overview

Just as ABS improves vehicle stability during braking, ATC improves vehicle stability and traction during vehicle acceleration. The Bendix EC-60 controller ATC function uses the same wheel speed information and modulator control as the ABS function. The Bendix EC-60 controller detects excessive drive wheel speed, compares the speed to the front, non-driven wheels, and reacts to help bring the wheel spin under control. The controller can be configured to use engine torque limiting and/or differential braking to control wheel spin. For optimal ATC performance, both methods are recommended.

ATC/ESP Lamp Output/ATC Mud/Snow Switch Input

Advanced ECUs control the ATC/ESP dash lamp as follows.

The ATC/ESP dash lamp illuminates:

1. During power up (e.g. when the vehicle is started) for approximately 2.5 seconds and turns off after the self test is completed, providing no diagnostic trouble codes are present.
2. When ESP or ATC is disabled for any reason.
3. During an ESP or ATC event (the lamp will flash rapidly at a rate of 2.5 times per second).
4. When the ECU is placed in the ATC off-road mode (the lamp will flash steadily at a rate of once per 2.5 seconds). This notifies the vehicle operator that the ATC Mud/Snow mode is active.
5. When the ECU is placed in the ABS off-road mode. When in this mode, ESP will be disabled below 25 mph and its inactive status will be indicated by a steadily illuminated ATC/ESP lamp.

Differential Braking

Differential braking within ATC is automatically activated when drive wheel(s) on one side of the vehicle are spinning excessively, which typically occurs on road surfaces with patches of ice. The traction system will then lightly apply the brake to the drive wheel(s) that are spinning excessively. The vehicle differential will then drive the wheels on the other side of the vehicle.

Differential braking (as part of ATC functionality) is available at vehicle speeds up to 25 MPH.

Disabling ATC Differential Braking

ATC differential braking is disabled under the following conditions:

1. During power up (e.g. when the vehicle is started), until the ECU detects a service brake application.
2. If the ECU receives a J1939 message indicating that the vehicle is parked.

3. When the dynamometer test mode is active. The dynamometer test mode is entered using the diagnostic blink code switch or by using a diagnostic tool (such as Bendix® ACom® Diagnostics).
4. In response to a serial communications request from a diagnostic tool.
5. If ATC Differential Braking function is activated for a long time period to avoid overheating of the brakes. It would take approximately 3 continuous minutes of activation for the timeout to occur. Once timed out, approximately 2 minutes of "cool off" time would be required before ATC Differential Braking can be used again.
6. When certain diagnostic trouble code conditions are detected.

Engine Torque Limiting with Smart ATC™

Traction Control

The Bendix EC-60 controller uses Engine Torque Limiting to control drive axle wheel slip. This is communicated to the engine control module (using J1939), and is available at all vehicle speeds.

Bendix® Smart ATC™ Traction Control

The Bendix EC-60 controller has an additional feature known as Smart ATC™ traction control. Smart ATC™ traction control monitors the accelerator pedal position (using J1939) to help provide optimum traction and vehicle stability. By determining the driver's throttle input and adapting the target slip of the drive wheels to the driving situation, the Smart ATC™ traction control allows higher wheel slip when the accelerator pedal is applied above a preset level.

The wheel slip allowed by Smart ATC™ is decreased when driving through a curve for improved stability.

Disabling ATC Engine Control and Smart ATC™ Traction Control

ATC Engine Control and Smart ATC™ traction control will be disabled under the following conditions:

1. In response to a serial communications request from an off-board tool.
2. At power-up until the ECU detects a service brake application.
3. If the ECU receives a J1939 message indicating that the vehicle is parked.
4. If the dynamometer test mode is active. This may be accomplished via an off-board tool or the diagnostic blink code switch.
5. When certain diagnostic trouble code conditions are detected.

Optional ATC Mud/Snow (Off-Road) Mode

In some road conditions, the vehicle operator may desire additional drive wheel slip when ATC is active. The Advanced Bendix EC-60 controller has an optional control mode to permit this desired performance.

The vehicle operator can activate the Mud/Snow function with a switch on the dash panel. Alternately, a J1939 message may be used to place the vehicle in this mode. The ATC/ESP Indicator Lamp will flash steadily at a rate of once every 2.5 seconds to confirm that the ATC mud/snow mode is engaged.

To exit the ATC Mud/Snow mode, depress and release the ATC Mud/Snow switch.

Drag Torque Control Functional Overview

Advanced Bendix® EC-60™ controllers have a feature referred to as drag torque control which reduces wheel slip on a driven axle due to driveline inertia. This condition is addressed by increasing the engine torque to overcome the inertia.

Drag torque control increases vehicle stability on low-traction road surfaces during down-shifting or retarder braking.

ADVANCED ABS WITH STABILITY CONTROL

Overview

ESP stability system reduces the risk of rollovers, jackknifing and other loss-of-control events. ESP features include Roll Stability Program (RSP) and Yaw Control. During operation, the ECU of the Bendix Advanced ABS system constantly compares performance models to the

vehicle's actual movement, using the wheel speed sensors of the ABS system, as well as lateral, yaw, and steering angle sensors. If the vehicle shows a tendency to leave an appropriate travel path, or if critical threshold values are approached, the system will intervene to assist the driver.

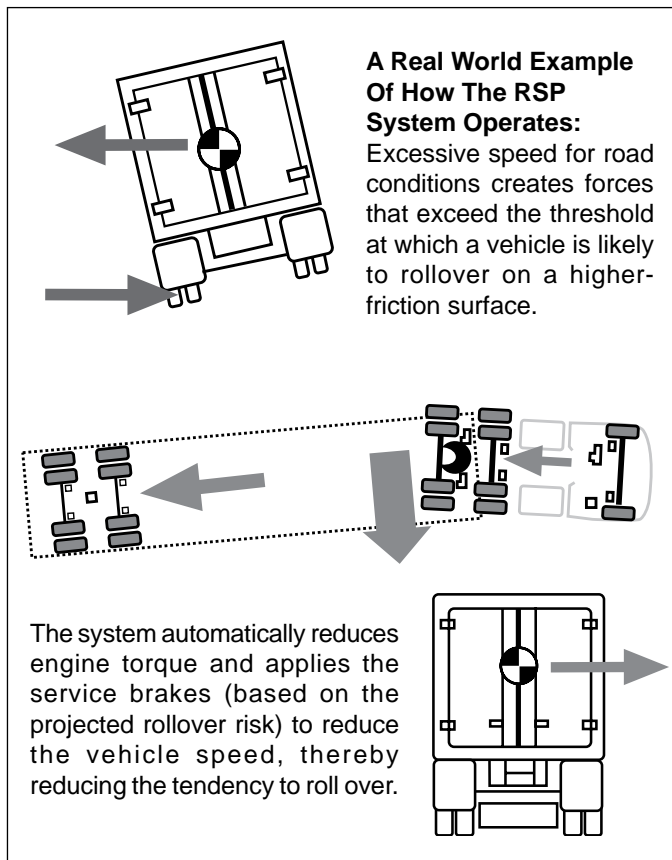

FIGURE 11 - RSP EXAMPLE

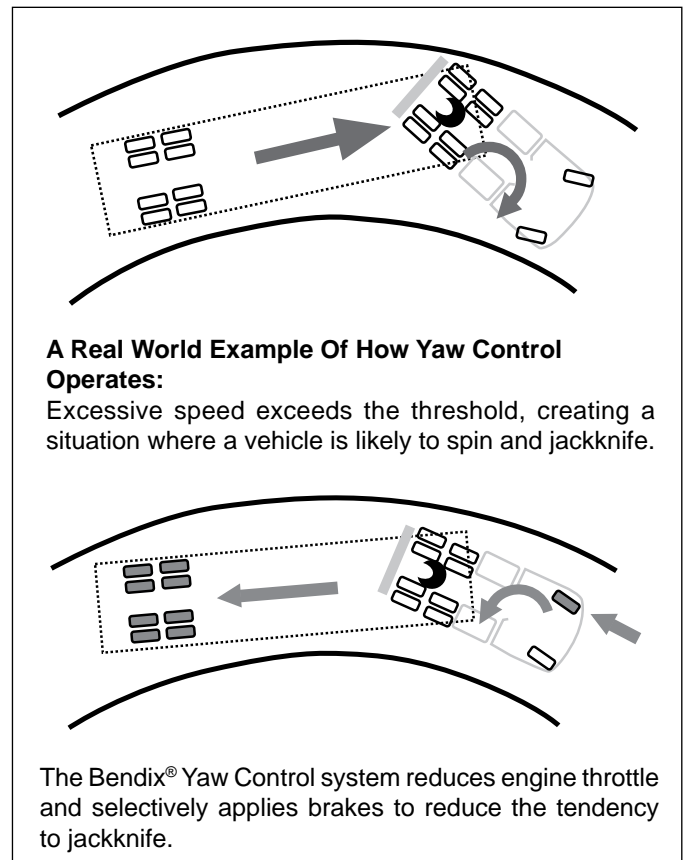

FIGURE 12 - YAW CONTROL EXAMPLE

Roll Stability Program

Bendix RSP, an element of the overall ESP system, addresses rollover conditions. In the case of a potential roll event, the ECU will override the throttle and quickly apply brake pressure at all wheel ends to slow the vehicle combination. The level of braking application during an RSP event will be proportional to roll risk. See Figure 11.

Yaw Stability

Yaw stability counteracts the tendency of a vehicle to spin about its vertical axis. During operation, if the friction between the road surface and the tires is not sufficient to oppose lateral (side) forces, one or more of the tires can slide, causing the truck/tractor to spin. These events are referred to as either an "under-steer" situation (where there is a lack of vehicle response to steering input due to tire slide on the steer axle) or an "over-steer" (where the tractor's rear end slides out due to tire slide on the rear axle) situation. Generally, shorter wheelbase vehicles (tractors, for instance) have less natural yaw stability, while longer wheelbase vehicles (straight trucks, for instance) have greater natural yaw stability. Factors that influence yaw stability are: wheelbase, suspension, steering geometry, weight distribution front to rear, and vehicle track width.

Yaw Control

Yaw Control responds to a wide range of low- to high-friction surface scenarios including rollover, jackknife and loss-of-control. It is the recommended system for all power vehicles and especially critical for tractors pulling trailers. In the case of vehicle slide (over-steer or under-steer situations), the system will reduce the throttle and then brake one or more of the "four corners" of the vehicle (in addition to potentially applying the trailer brakes), thus applying a counter-force to better align the vehicle with an appropriate path of travel.

For example, in an over-steer situation, the system applies the "outside" front brake; while in an under-steer condition, the "inside" rear brake is applied. (See Figure 12)

IMPORTANT SAFETY INFORMATION ABOUT THE BENDIX® ESP® STABILITY SYSTEM

ESP May Reduce The Vehicle Speed Automatically

ESP can make the vehicle **decelerate automatically**. ESP can slow the vehicle with or **without the operator applying the brake**, and **even when the throttle is being applied**.

CAUTION

To minimize unexpected deceleration and reduce the risk of a collision the operator must:

- Avoid aggressive driving maneuvers, such as sharp turns or abrupt lane changes at high speeds, which might trigger the stability system.

- Always operate the vehicle safely, drive defensively, anticipate obstacles and pay attention to road, weather and traffic conditions. ABS, ATC and ESP stability systems are no substitute for prudent, careful driving.

Towing Doubles Or Triples May Reduce The Effectiveness Of Stability Systems

ESP is designed and optimized for trucks and for tractors that tow single trailers. If a tractor equipped with ESP is used to power multiple trailer combinations (known as "doubles" or "triples") **the effectiveness of the ESP system may be greatly reduced**. Extremely careful driving is always required when towing doubles or triples. Excessive speed and aggressive maneuvers, such as sharp turns, sudden steering inputs or abrupt lane changes should be avoided.

Limitations Of Stability Systems

The ESP stability system's effectiveness may be greatly reduced if:

- The load shifts due to improper retention, accident damage or the inherently mobile nature of some loads (for example, hanging meat, live animals or partially laden tankers),
- The vehicle has an unusually high or off-set center of gravity (CG),
- One side of the vehicle drops off the pavement at an angle that is too large to be counteracted by a reduction in speed,
- The vehicle is used to haul double or triple trailer combinations,
- If very rapidly winding steering inputs are inputted at high speeds,
- There are mechanical problems with suspension leveling of the tractor or trailer resulting in uneven loads,
- The vehicle is maneuvering on a high banked road creating either additional side forces due to the weight (mass) of the vehicle or a deviation between expected & actual yaw rates,
- Gusty winds are strong enough to cause significant side forces on the vehicle and any towed vehicles.

To Maximize The Effectiveness Of ESP:

- Loads must be properly secured at all times.
- Drivers need to exercise extreme caution at all times, and avoid sharp turns, sudden steering inputs or abrupt lane changes at high speeds, particularly if:
 - › the vehicle hauls loads that could shift,
 - › the vehicle or load has a high or off-set center of gravity (CG) when loaded, or
 - › the vehicle tows doubles or triples.

Truck Chassis Modifications

If the vehicle's chassis components are altered (for example, a wheel base extension or reduction, tag axle addition or removal, a major body change such as conversion of a tractor into a truck, or an axle, suspension, or steering system component modification) the Bendix® ESP® system must be disabled. Have a qualified mechanic replace the Advanced EC-60 ECU with a Premium EC-60 ECU and secure the X4 connector which will no longer be used. The ATC/ESP indicator lamp would continue to function as an ATC indicator lamp, and should be designated as ATC only.

⚠ WARNING: If a modified vehicle does not have the ESP system disabled, serious vehicle braking and performance issues could result, including unnecessary ESP system interventions. This can lead to a loss-of-control of the vehicle. In addition, remove all cab signage (e.g. visor labels, etc.) used to show that Bendix ESP was installed and make any necessary notations in the vehicle manual(s), so that drivers do not misunderstand which ABS options are installed on the vehicle.

Sensor Location Modifications

The location and orientation of the Steering Angle Sensor and Yaw Rate Sensor must not be altered. When servicing, an identical component must be used in the same orientation (using OEM brackets & torque requirements). During installation follow the OEM leveling guidelines.

Steering Angle Sensor Re-Calibration

Whenever maintenance or repair work is performed to the steering mechanism, linkage, steering gear, adjustment of the wheel track, or if the steering angle sensor is replaced, a recalibration of the Steering Angle Sensor must be performed.

⚠ WARNING! If the Steering Angle Sensor is not recalibrated, the yaw control system may not function properly, which can result in incidents leading to loss of vehicle control. See page 19 of this document for more details on this procedure.

DYNAMOMETER TEST MODE

⚠ CAUTION: ATC and ESP must be disabled prior to conducting any dynamometer testing. When the Dynamometer Test Mode is engaged, ATC brake control and engine control along with drag torque control and ESP are turned off. This test mode is used to avoid torque reduction or torque increase and brake control activation when the vehicle is operated on a dynamometer for testing purposes.

The Dynamometer Test Mode may be activated by pressing and releasing the diagnostic blink code switch five times or by using a hand-held or PC-based diagnostic tool.

During Dynamometer Test Mode the ATC lamp remains ON.

Advanced Bendix® EC-60™ Controllers will remain engaged in the Dynamometer Test Mode even if power to the ECU is removed and re-applied. To exit the test mode, press and release the blink code switch three times, or use a hand-held or PC-based diagnostic tool.

AUTOMATIC TIRE SIZE CALIBRATION

The ECU requires a precise rolling circumference ratio between steer axle and drive axle tires in order for ABS, ATC, and ESP to perform in an optimal manner. For this reason, a continuously monitoring process takes place in which the precise ratio is calculated. This calculated value is stored in the ECU memory provided the following conditions are met:

1. Rolling-circumference ratio is within the permissible range.
2. Vehicle speed is greater than approximately 12 MPH.
3. No acceleration or deceleration is taking place.
4. There are no active speed sensor diagnostic trouble codes.

The ECU is provided with a ratio value of 1.00 as a default setting. If the automatic tire size alignment calculates a different value, this is used to overwrite the original figure in the memory. This process adapts the ABS and ATC function to the vehicle.

Acceptable Tire Sizes

The speed calculation for an exciter ring with 100 teeth is based on a default tire size of 510 revolutions per mile. This figure is based on the actual rolling circumference of the tires, which varies with tire size, tire wear, tire pressure, vehicle loading, etc.

The ABS response sensitivity is reduced when the actual rolling circumference is excessive on all wheels. For a 100 tooth exciter ring, the minimum number of tire revolutions per mile is 426, and the maximum is 567. The ECU will set diagnostic trouble codes if the number of revolutions is out of this range.

In addition, the size of the steer axle tires compared to the drive axle tires also has to be within the ABS system design. To avoid diagnostic trouble codes, the ratio of the effective rolling circumference of the steer axle, divided by the effective rolling circumference of the drive axle, must be between 0.85 to 1.15.

⚠ CAUTION: The ESP system effectiveness relies on the accuracy of vehicle speed. If a major change on the tire sizes occurs such that the odometer setting needs to be changed, the Advanced ABS controller's setting of tire sizes must be reprogrammed to new values at the same time by a certified mechanic.

SYSTEM IMPACT DURING ACTIVE TROUBLE CODES

ABS PARTIAL SHUTDOWN

Depending on which component the trouble code is detected, the ABS, ATC, and ESP functions may be fully or partially disabled. Even with the ABS indicator lamp illuminated, the Bendix EC-60 controller may still provide ABS function on wheels that are not affected. The ABS system controller should be serviced as soon as possible.

Steer Axle ABS Modulator Diagnostic Trouble Code

ABS on the affected wheel is disabled. ABS and ATC on all other wheels remains active. ESP is disabled.

Drive Axle/Additional Axle ABS Modulator Diagnostic Trouble Code

ATC is disabled. ABS on the affected wheel is disabled. ABS on all other wheels remains active. ESP is disabled.

Steer Axle Wheel Speed Sensor Diagnostic Trouble Code

The wheel with the diagnostic trouble code is still controlled by using input from the remaining wheel speed sensor on the steer axle. ABS remains active on the rear wheels. ATC and ESP are disabled.

Drive Axle/Additional Axle Wheel Speed Sensor Diagnostic Trouble Code

ATC and ESP are disabled. In a four sensor system, ABS on the affected wheel is disabled, but ABS on all other wheels remains active.

In a six sensor system, ABS remains active by using input from the remaining rear wheel speed sensor on the same side.

ATC Modulator Diagnostic Trouble Code

ATC and ESP are disabled. ABS remains active.

J1939 Communication Diagnostic Trouble Code

ATC and ESP are disabled. ABS remains active.

ECU Diagnostic Trouble Code

ABS, ATC, and ESP are disabled. The system reverts to normal braking.

Voltage Diagnostic Trouble Code

While voltage is out of range, ABS, ATC, and ESP are disabled. The system reverts to normal braking. When the correct voltage level is restored, full ABS and ATC function is available. The operating voltage range is 9.0 to 17.0 VDC for 12 volt systems, and 20 to 33.5 volts for 24 volt systems.

Steering Angle Sensor Diagnostic Trouble Code

ESP is disabled. ABS and ATC remain active.

Yaw Rate/Lateral Acceleration Sensor Diagnostic Trouble Code

ESP is disabled. ABS and ATC remain active.

Brake Demand Pressure Sensor Diagnostic Trouble Code

ESP is disabled. ABS and ATC remain active.

Load Sensor Diagnostic Trouble Code

ESP is disabled. ABS and ATC remain active.

Steer Axle TCV Diagnostic Trouble Code

ESP is disabled. ABS and ATC remain active.

Trailer PMV Diagnostic Trouble Code

ESP is disabled. ABS and ATC remain active.

SYSTEM RECONFIGURATION

The Bendix® EC-60™ controller is designed to allow the technician to change the default system settings (chosen by the vehicle OEM) to provide additional or customized features.

Depending on the model, the customizable features include ABS control settings, engine module communication etc. Many of these settings can be reconfigured using a hand-held or PC-based software, such as the Bendix® ACom® Diagnostics program.

ECU RECONFIGURATION

Reconfiguring a Bendix EC-60 controller may be carried out by using the Blink Code Switch or by using a hand-held or PC-based diagnostic tool.

Note: During the reconfiguration process, and independently from any reconfiguration being carried out by the technician, the ECU will automatically check the J1939 serial link and communicate with other vehicle modules. In particular, if the serial link shows that the vehicle has a retarder device present, the ECU will configure itself to communicate with the retarder device for improved ABS performance. For example, if the ECU detects the presence of a retarder disable relay during a reconfiguration, it will configure itself to control the relay to disable the retarding device as needed.

Reconfiguration Using the Blink Code Switch

With ignition power removed from the Bendix EC-60 controller, depress the blink code switch. After the ignition power is activated, depress and release the switch seven times to initiate a reconfiguration event.

Diagnostic Tool

A reconfiguration event may be initiated using a hand-held or PC-based diagnostic tool to communicate with the ECU over the SAE J1587 diagnostic link.

6S/5M Configuration

Advanced Bendix® EC-60™ controllers will configure for 6S/5M operation when a reconfiguration event is initiated and the ECU detects that an additional axle PMV is wired as follows:

PMV Connector

Hold
Release
Common

ECU Connector

Right Additional Axle Hold
Left Additional Axle Release
Right Additional Axle Common

Troubleshooting: General

GENERAL SAFETY GUIDELINES



WARNING! PLEASE READ AND FOLLOW THESE INSTRUCTIONS TO AVOID PERSONAL INJURY OR DEATH:



When working on or around a vehicle, the following guidelines should be observed AT ALL TIMES:

- ▲ Park the vehicle on a level surface, apply the parking brakes and always block the wheels. Always wear personal protection equipment.
- ▲ Stop the engine and remove the ignition key when working under or around the vehicle. When working in the engine compartment, the engine should be shut off and the ignition key should be removed. Where circumstances require that the engine be in operation, EXTREME CAUTION should be used to prevent personal injury resulting from contact with moving, rotating, leaking, heated or electrically-charged components.
- ▲ Do not attempt to install, remove, disassemble or assemble a component until you have read, and thoroughly understand, the recommended procedures. Use only the proper tools and observe all precautions pertaining to use of those tools.
- ▲ If the work is being performed on the vehicle's air brake system, or any auxiliary pressurized air systems, make certain to drain the air pressure from all reservoirs before beginning ANY work on the vehicle. If the vehicle is equipped with a Bendix® AD-IS® air dryer system, a Bendix® DRM™ dryer reservoir module, or a Bendix® AD-9si® air dryer, be sure to drain the purge reservoir.
- ▲ Following the vehicle manufacturer's recommended procedures, deactivate the electrical system in a manner that safely removes all electrical power from the vehicle.
- ▲ Never exceed manufacturer's recommended pressures.
- ▲ You should consult the vehicle manufacturer's operating and service manuals, and any related literature, in conjunction with the Guidelines above.
- ▲ Never connect or disconnect a hose or line containing pressure; it may whip and/or cause hazardous airborne dust and dirt particles. Wear eye protection. Slowly open connections with care, and verify that no pressure is present. Never remove a component or plug unless you are certain all system pressure has been depleted.
- ▲ Use only genuine Bendix® brand replacement parts, components and kits. Replacement hardware, tubing, hose, fittings, wiring, etc. must be of equivalent size, type and strength as original equipment and be designed specifically for such applications and systems.
- ▲ Components with stripped threads or damaged parts should be replaced rather than repaired. Do not attempt repairs requiring machining or welding unless specifically stated and approved by the vehicle and component manufacturer.
- ▲ Prior to returning the vehicle to service, make certain all components and systems are restored to their proper operating condition.
- ▲ For vehicles with Automatic Traction Control (ATC), the ATC function must be disabled (ATC indicator lamp should be ON) prior to performing any vehicle maintenance where one or more wheels on a drive axle are lifted off the ground and moving.
- ▲ The power MUST be temporarily disconnected from the radar sensor whenever any tests USING A DYNAMOMETER are conducted on a vehicle equipped with a Bendix® Wingman® system.

REMOVING THE BENDIX® EC-60™ CONTROLLER ASSEMBLY

1. Turn vehicle ignition off.
2. Remove as much contamination as possible prior to disconnecting electrical connections.
3. Note the Bendix EC-60 controller assembly mounting position on the vehicle.
4. Disconnect the electrical connectors from the Bendix EC-60 controller.
5. Remove and retain the mounting bolts that secure the Bendix EC-60 controller.

CAUTION

The VIN of the vehicle is stored in the ECU internal memory, and is cross-checked by the ECU using information obtained from other vehicle controllers. If the VIN stored in the ECU does not match the VIN obtained from the other vehicle controller, the ECU will generate an ECU Internal VIN Mismatch DTC.

Accordingly, do not switch Advanced controllers from one vehicle to another.

OBTAINING A NEW BENDIX EC-60 ADVANCED CONTROLLER

Should the Advanced Bendix EC-60 controller require replacement, certain steps must be followed:

1. Record the vehicle model, VIN, year and date of manufacture from the vehicle.
2. Record the part number of the Bendix EC-60 Advanced Controller.
3. Provide this information to your local OEM vehicle service department to obtain a new ECU. The OEM service department will install the same parameter set in the new controller that was loaded into the original ECU at the vehicle OEM assembly facility.

INSTALLING A NEW BENDIX® EC-60™ CONTROLLER

⚠ CAUTION When replacing the Bendix EC-60 controller, verify with the OEM service department that the unit you are installing has the correct parameter set. Failure to do so could result in a loss of features or degraded ESP performance.

For further information, contact either the vehicle manufacturer, Bendix or your local authorized Bendix dealer.

1. Position and secure the Bendix® EC-60™ controller in the original mounting orientation using the mounting bolts retained during removal. Use no more torque than is necessary to firmly secure the ECU into position. Over-tightening the mounting hardware can cause damage to the EC-60™ controller.
2. Reconnect the electrical connectors to the EC-60™ controller.
3. Apply power and monitor the Bendix EC-60 controller power-up sequence to verify proper system operation.

See Troubleshooting: Wiring section beginning on page 45 for more information on wire harnesses.

⚠ WARNING: Bendix ESP stability system is validated with specific Bendix® brand components. Always use Bendix® brand replacement parts to prevent compromising system performance. Bendix is not able to validate the safe and reliable use of substitute or alternate components that may be available from other manufacturers. Further, suppliers of a non-Bendix® brand ABS component may implement design changes in their component (without the knowledge or approval of Bendix) which could negatively affect antilock system reliability and braking performance issues.

REMOVAL OF THE STEERING ANGLE SENSOR

Service Checks:

1. Check all wiring and connectors. Some installations also include an intermediate connector from the steering angle sensor to the main vehicle wire harness. Make sure all connections are free from visible damage.
2. Examine the sensor. Make sure the sensor, its mounting screws, and the interface between the hub and the steering column are not damaged.

Diagnostics:

The steering angle sensor is only operational in conjunction with an Advanced ABS ECU. No independent diagnostics can be performed on the sensor.

Removal:

1. Remove steering column sheathing.
2. Depending upon manufacturer, the steering angle sensor could be located either near the steering wheel, necessitating the removal of the steering wheel, or near the joint to the vehicle steering mechanism, necessitating the disconnection of this linkage.
3. Unplug sensor cable assembly from body of sensor. Squeeze the mounting tabs and pull gently on the connector until it disengages.
4. Unscrew all three of the mounting screws that hold the body of the sensor to the steering column body.
5. Slide the sensor over the column to remove. Take note if the sensor label is facing upward or downward.

Installation:

1. Obtain a new sensor. The sensor is not repairable in the field.
2. Slide the sensor over the column. The center hub of the sensor must be aligned with the corresponding notch in the column. Different column manufacturers may implement this hub alignment in different ways. The sensor label should be facing in the same direction as the removed sensor.
3. Assemble to column non-moving plate with three self-locking screws.
4. Tighten screws to steering column manufacturer's recommended torque specification.
5. Reconnect the connector. Ensure that there will be no force applied to the sensor because the connector is pulling on the sensor body.
6. If the wire harness leading to the sensor is being replaced, ensure that it is adequately tie wrapped so that the full motion of the steering column can be achieved without pulling apart the connectors.
7. Reinstall the column sheathing. The sensor is not protected against dirt or water intrusion, so care must be taken not to introduce these elements during installation.

STEERING ANGLE SENSOR CALIBRATION

The steering angle sensor calibration can only be achieved when the sensor is powered by the Advanced ABS ECU. No stand-alone sensor calibration can be carried out. The calibration procedure is performed using Bendix® ACom® Diagnostic V4.0 or higher. See “Troubleshooting Diagnostic Trouble Codes: Steering Angle Sensor (SAS-60)” for the calibration procedure using this tool. The sensor must be recalibrated using ACom Diagnostics after any of these situations:

- Replacement of the steering angle sensor
- Any opening of the connector hub from the steering angle sensor to the column
- Any maintenance or repair work on the steering linkage, steering gear or other related mechanism
- Adjustment of the wheel alignment or wheel track
- After an accident that may have led to damage of the steering angle sensor or assembly

⚠ WARNING: If the steering angle sensor is not properly recalibrated as needed, the yaw control system may not function properly, which can result in a loss of vehicle control.

REMOVAL OF THE YAW RATE/LATERAL ACCELERATION SENSOR

⚠ WARNING: Different generations of yaw rate/lateral acceleration sensors are not compatible. Only replace these sensors with exactly the same device.

Service Checks:

1. Check all wiring and connectors. Make sure all connections are free from visible damage.
2. Examine the sensor. Make sure the sensor, its mounting bolts, and the mounting bracket are not damaged.
3. Check the vent hole in underbody of sensor housing. The vent hole should remain free from paint and debris at all times.

Diagnostics:

The yaw rate sensor is only operational in conjunction with an Advanced ABS ECU. No independent diagnostics can be performed on the sensor.

Removal:

1. Unplug sensor cable assembly from body of sensor. The connector must be twisted and pulled gently to release.
2. In some mounting configurations, the sensor can be removed independently from its mounting bracket. Otherwise, remove entire assembly, then remove sensor from bracket.
3. Take note of the direction in which the connector is pointed.

Installation:

1. Obtain a new sensor. The sensor is not repairable in the field.

⚠ WARNING: The location of the Yaw Rate Sensor on the vehicle, the means of fastening the unit to the vehicle, and the sensor's orientation, **MUST NOT BE ALTERED**. When servicing, an identical component must be used in the same orientation (using OEM brackets & torque requirements). During installation, follow the OEM leveling guidelines. If any of these requirements are not followed, the advanced ABS control system may not function properly, which can result in incidents leading to loss of vehicle control.

2. Assemble yaw rate sensor housing to mounting bracket. The bracket must be the same design as used on the original vehicle configuration.
3. For Bendix® YAS-60™ Yaw Rate Sensors, the correct fasteners are three M8 size bolts, and the fixing torque should be 20Nm (± 2 Nm). For Bendix® YAS-70X™ Yaw Rate Sensors, the correct fasteners are two M10 size bolts (1.5 mm pitch angle), or OEM-supplied hardware, and the fixing torque should be 46Nm (± 9 Nm). Note that the Bendix YAS-70X sensor has two alternate designs, one with an aligning post — see the kit instruction sheet for more information. In all cases, the connector should be facing in the same direction as the removed sensor. The unit must not be installed upside-down where there is a pressure-balancing hole.
4. The sensor should be as level as possible and parallel to the road surface when installed on the vehicle.
5. Reconnect the connector. Ensure that there will be no force applied to the sensor because the connector is pulling on the sensor body.

⚠ CAUTION: When removing or installing the sensor, care must be used to prevent damage. Do not strike or pry the sensor. Do not use an impact tool to install the mounting hardware.

Sensor Location Modifications

The location and orientation of the Yaw Rate Sensor must not be altered. When servicing, an identical component must be used in the same orientation (using OEM brackets & torque requirements). During installation follow the OEM leveling guidelines.

Yaw Rate Sensor Calibration:

The yaw rate sensor calibration can only be achieved via the Advanced ABS ECU. The sensor must be recalibrated after any of these situations:

- Replacement of the sensor
- After an accident that may have led to damage of the yaw rate sensor

The calibration procedure is performed using Bendix® ACom® Diagnostics V4.0 or higher.

See “Troubleshooting Diagnostic Trouble Codes: Yaw Rate Sensor” for the calibration procedure.

BRAKE DEMAND SENSOR CALIBRATION

Calibration must be performed under the following conditions:

- After servicing any pressure sensor related DTCs
- Replacement of any sensor

The calibration procedure is performed using Bendix ACom Diagnostics V4.0 or newer versions.

See “Troubleshooting Diagnostic Trouble Codes: Brake Demand Sensor/Load Sensor” for the calibration procedure.

PRESSURE SENSOR INSTALLATION REQUIREMENTS

Service Checks:

1. Check all wiring and connectors. Make sure all connections are free from visible damage.
2. Examine the sensor. Make sure the sensor and its interface to the pressure location are not damaged.

Diagnostics:

The pressure sensor can be independently diagnosed when supplied with a five volt voltage supply to the B location and ground to the A location. Signal output on the C location should read approximately 0.5V if there is no pressure applied. The signal output should increase proportionately as pressure is applied, up to a maximum of 4.5V at 150 psi.

Removal:

1. Unplug sensor cable assembly from body of sensor. Pull gently on the mounting tab and connector until it disengages.
2. Remove sensor from its pressure mounting using approved air brake push in fitting tools.

Installation:

1. Obtain a new sensor. The sensor is not repairable in the field.
2. Insert sensor into pressure fitting using approved tools.
3. Reconnect the connector. Ensure that there will be no force applied to the sensor because the connector is pulling on the sensor body.
4. If the wire harness leading to the sensor is being replaced, ensure that it is adequately tie wrapped.

Pressure Sensor Calibration:

There is no need for pressure sensor calibration as long as the part replaced is identical to the part removed and a component approved for use with the Bendix Advanced ABS system. However, replacement of brake demand sensors or clearing of demand pressure sensor related DTCs require the following:

1. Use of ACom V4 or newer to clear the active p-sensor fault.
2. Carrying out the demand p-sensor initialization procedure which involves applying service brakes of 90 psi or greater for 3 sec (while stationary).

Once this procedure is carried out successfully, if there are no other active DTCs, ATC/ESP indicator will no longer illuminate.

Troubleshooting: Blink Codes and Diagnostic Modes

ECU DIAGNOSTICS

The Bendix® EC-60™ controller contains self-testing diagnostic circuitry that continuously checks for the normal operation of internal components and circuitry, as well as external ABS components and wiring.

Active Diagnostic Trouble Codes

When an erroneous system condition is detected, the EC-60™ controller:

1. Illuminates the appropriate indicator lamp(s) and disengages part or all of the ABS, ATC and ESP functions. (See *ABS Partial Shutdown*, on page 15.)
2. Places the appropriate trouble code information in the ECU memory.
3. Communicates the appropriate trouble code information over the serial communications diagnostic link as required. Hand-held or PC-based diagnostic tools attach to the vehicle diagnostic connector, typically located on or under the dash (see Figure 13).

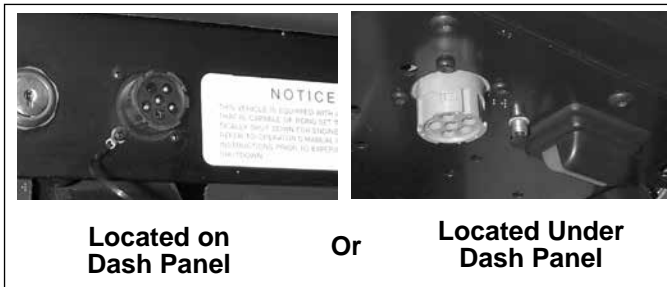

FIGURE 13 - TYPICAL VEHICLE DIAGNOSTIC CONNECTOR LOCATIONS (J1708/J1587, J1939)

BLINK CODES

Blink codes allow a technician to troubleshoot ABS problems without using a hand-held or PC-based diagnostic tool. Instead, information about the ABS system is communicated by the ECU using the ABS indicator lamp to display sequences of blinks.

Note: The ECU will not enter the diagnostic blink code mode if the wheel speed sensors show that the vehicle is in motion. If the ECU is in the diagnostic blink code mode and then detects vehicle motion, it will exit the blink code mode.

In addition, by operating the blink code switch as described below, one of several diagnostic modes can be entered. See Diagnostic Modes below.

Blink Code Switch Activation

When activating the blink code switch:

1. Wait at least two seconds after “ignition on.” (Except when entering Reconfiguration Mode - see *Reconfiguration section* on page 16.)
2. For the ECU to recognize that the switch is activated “on,” the technician must press for at least 0.1 seconds, but less than 5 seconds. (If the switch is held for more than 5 seconds, the ECU will register a malfunctioning switch.)
3. Pauses between pressing the switch when a sequence is required, (e.g. when changing mode) must not be longer than 2 seconds.
4. After a pause of 3.5 seconds, the ECU will begin responding with output information blinks. See *Figure 14* for an example.

Blink Code Timing

The ECU responds with a sequence of blink codes. The overall blink code response from the ECU is called a “message.” Each message includes, depending on the mode selected by the technician, a sequence of one or more groups of blinks. Simply record the number of blinks for each sequence and then use the troubleshooting index on page 26 for active or inactive trouble codes and you will be directed to the page that provides troubleshooting information.

NOTE:

1. Sequences of blinks illuminate the ABS indicator lamp for half a second, with half-second pauses between them.
2. Pauses between blink code digits are 1.5 seconds.
3. Pauses between blink code messages are 2.5 seconds.
4. The lamp remains on for 5 seconds at the end of messages.

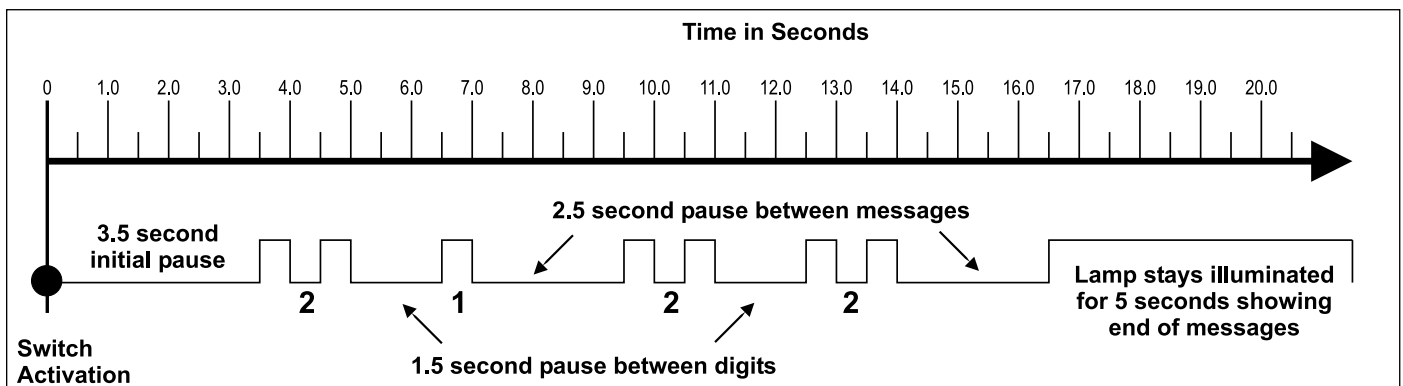

FIGURE 14 - EXAMPLE OF BLINK CODE MESSAGE

Once the ABS indicator lamp begins displaying a sequence of codes, it continues until all blink code messages have been displayed and then returns to the normal operating mode. During this time, the ECU will ignore any additional blink code switch activation.

All trouble codes, with the exception of voltage and J1939 trouble codes, will remain in an active state for the remainder of the power cycle.

Voltage trouble codes will clear automatically when the voltage returns within the required limits. All ABS functions will be re-engaged.

J1939 trouble codes will clear automatically when communications are re-established.

DIAGNOSTIC MODES

In order to communicate with the ECU, the controller has several modes that the technician can select, allowing information to be retrieved, or other ECU functions to be accessed.

Diagnostic Modes

To enter the various diagnostic modes:

No. of Times to Press the Blink Code Switch	System Mode Entered
1	Active diagnostic trouble code retrieval
2	Inactive diagnostic trouble code retrieval
3	Clear active diagnostic trouble codes
4	System configuration check
5	Dynamometer Test Mode
7*	Reconfigure ECU
* To enter the Reconfiguration Mode, the switch must be held in before the application of ignition power. Once the power is supplied, the switch is released and then pressed seven times.	

CHART 2 - DIAGNOSTIC MODES

Active Diagnostic Trouble Code Mode

For troubleshooting, typically the Active and Inactive Diagnostic Trouble Retrieval Modes are used. The technician presses the blink code switch once and the ABS indicator lamp flashes a first group of two codes, and if there are more trouble codes recorded, this is followed by a second set of codes, etc. (See page 26 for a directory of these codes.) All active trouble codes may also be retrieved using a hand-held or PC-based diagnostic tool, such as the Bendix® ACom® Diagnostics software.

To clear active diagnostic trouble codes (as problems are fixed), simply clear (or “self-heal”) by removing and re-applying ignition power. The only exception is for wheel speed sensor trouble codes, which clear when power is removed, re-applied, and the ECU detects valid wheel speed from all wheel speed sensors. Alternately, codes may be cleared by pressing the diagnostic blink code switch 3 times (to enter the Clear Active Diagnostic Trouble Code Mode) or by using a hand-held or PC-based diagnostic tool. Hand-held or PC-based diagnostic tools are able to clear wheel speed sensor trouble codes without the vehicle being driven.

Inactive Diagnostic Trouble Code Mode

The ECU stores past trouble codes and comments (such as configuration changes) in its memory. This record is commonly referred to as “event history.” When an active trouble code is cleared, the ECU stores it in the event history memory as an inactive trouble code.

Using blink codes, the technician may review all inactive trouble codes stored on the ECU. The ABS indicator lamp will display inactive diagnostic blink codes when the diagnostic blink code switch is depressed and released two times. See page 26 for the index showing trouble codes and the troubleshooting guide page to read for help.

Inactive trouble codes, and event history, may be retrieved and cleared by using a hand-held or PC-based diagnostic tool, such as the Bendix® ACom® Diagnostics software.

Clearing Active Diagnostic Trouble Codes

The ECU will clear active trouble codes when the diagnostic blink code switch is depressed and released three times.

System Configuration Check Mode

The ABS indicator lamp will display system configuration information when the diagnostic blink code switch is depressed and released four times. The lamp will blink out configuration information codes using the following patterns. (See Chart 3).

In this mode the ECU tells the technician, by means of a series of seven blink codes, the type of ABS system that the ECU has been set up to expect. For example, if the fourth blink code is a two, the technician knows that a 6S/4M sensor/modulator configuration has been set.

Dynamometer Test Mode

The Dynamometer Test Mode is used to disable ESP & ATC when needed (e.g. when performing any vehicle maintenance where the wheels are lifted off the ground and moving, including dyno testing). **For Advanced ABS controllers this mode will remain engaged even if power to the ECU is removed and re-applied.**

To exit the Dynamometer Test Mode, press and release the blink code switch three times, or use a hand-held or PC-based diagnostic tool.

1st Number	System Power
1	12 Volts
2nd Number	Wheel Speed Sensors
4	4 Sensors
6	6 Sensors
3rd Number	Pressure Modulator Valves
4	4 Modulators
5	5 Modulators
6	6 Modulators
4th Number	ABS Configuration
1	4S/4M or 6S/6M
2	6S/4M
3	6S/5M
5th Number	Traction Control Configuration
2	No ATC
3	ATC Engine Control Only
4	ATC Brake Control Only
5	Full ATC (Engine Control & Brake Control)
6th Number	Retarder Configuration
1	No Retarder
2	J1939 Retarder
3	Retarder Relay
4	J1939 Retarder, Retarder Relay
7th Number	Stability Configuration
1	No Stability Program
2	Electronic Stability Program (ESP), which includes RSP
3	Roll Stability Program (RSP) Only

CHART 3 - SYSTEM CONFIGURATION CHECK

Reconfigure ECU Mode

Controller reconfiguration is carried out by using the Reconfigure ECU Mode. (See page 16.)

Note: To enter the Reconfiguration Mode, the blink code switch must be held in before the application of ignition power. Once the power is supplied, the switch is released and then pressed seven times.

Troubleshooting and diagnostic trouble code clearing (as well as reconfiguration) may also be carried out using hand-held or PC-based diagnostic tools such as the Bendix® Remote Diagnostic Unit (RDU™), Bendix® ACom® Diagnostics software, or the ProLink tool.

Troubleshooting: Using Hand-Held or PC-Based Diagnostic Tools

Bendix® RDU™ (Remote Diagnostic Unit)

The Bendix® RDU™ tool provides the technician with a visual indication of Antilock Braking System (ABS) component **Diagnostic Trouble Code (DTC)** information. The RDU™ tool is specifically designed for use with Bendix® ABS systems and Bendix makes no claims for its operation and/or usability with other brands of ABS systems.

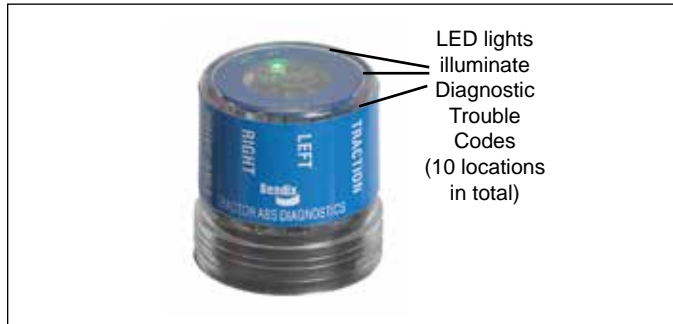

FIGURE 15 - THE BENDIX® REMOTE DIAGNOSTIC UNIT

Features of the Bendix® RDU™ Tool

The RDU™ tool attaches to the 9 pin diagnostic connector in the cab of the vehicle. An adapter cable (Bendix part number 801872) is available to connect the RDU to vehicles with a 6-pin diagnostic connector.

The RDU™ tool allows the technician to:

- Troubleshoot ABS system component problems using Diagnostic Trouble Code reporting via LEDs.
- Reset Diagnostic Trouble Codes on Bendix® ABS ECUs by holding a magnet over the reset in the center of the RDU™ tool for less than 6 seconds.
- Enter the Self-Configuration Mode used by Bendix® ABS ECUs by holding a magnet over the reset area for greater than 6 seconds but less than 30 seconds.

How the Bendix® RDU™ Operates

See Figure 13 for typical vehicle connector locations.

When the RDU™ tool is plugged into the diagnostic connector, all the LEDs will illuminate, and the green LED will flash 4 times to indicate communications have been established.

If the ABS ECU has no active Diagnostic Trouble Codes, only the green LED will remain illuminated.

If the ABS ECU has at least one active Diagnostic Trouble Code the RDU™ tool displays the first diagnostic trouble code by illuminating the red LEDs, indicating the malfunctioning ABS component and its location on the vehicle. (See Figure 15.) If there are multiple diagnostic trouble codes on the ABS system, the RDU™ tool will display one diagnostic trouble code first, then once that Diagnostic Trouble Code has been repaired and cleared, the next code will be displayed.

Typical Combination Diagnostic Trouble Codes are:

- Right steer sensor
- Left steer sensor
- Right drive sensor
- Left drive sensor
- Right additional sensor
- Left additional sensor
- Right steer modulator
- Left steer modulator
- Right drive modulator
- Left drive modulator
- Right additional modulator
- Left additional modulator
- Rear Axle Traction modulator
- ECU
- Engine serial communication
- MOD red LED illuminated, shows the "Common" connection of one or more modulators is shorted to battery or ground
- VLT (Flashing indicates either over- or under-voltage condition)

To pinpoint the root cause and to ensure the system diagnostic trouble code is properly corrected the first time, additional troubleshooting may be necessary. Note: The RDU is not capable of diagnosing ESP-specific diagnostic trouble codes including additional sensors: steering angle sensors, yaw sensors, pressure sensors, or modulator valves (trailer pressure modulating valves or front axle traction control valves.)

LED DIAGNOSTIC TROUBLE CODES			
LFT -	Left	SEN -	Wheel Speed Sensor
RHT -	Right	MOD -	Pressure Modulator Valve
DRV -	Drive Axle	TRC -	Traction Control
ADD -	Additional		
STR -	Steer Axle		
VLT -	Power		
ECU -	ABS Controller		

Example: If the Diagnostic Trouble Code is "Right Steer Axle Sensor", the RDU™ unit will display one green and three red LEDs

FIGURE 16 - DIAGNOSTIC TROUBLE CODES

Bendix® RDU™ Reset Function

The magnetic reset switch is located in the center top of the RDU™ tool. Activation requires a magnet with 30 gauss minimum.

The reset operations are:

1. If the magnet is held over the switch for less than 6 seconds the "clear current diagnostic trouble codes" command is sent.
2. If the magnet is held over the switch for more than 6 seconds, but less than 30 seconds, the Bendix® ABS "self-configuration command" is sent.

Additionally, it is recommended at the end of any inspection that the user switches off and restores the power to the ABS ECU, then check the ABS Indicator Lamp operation and RDU™ tool to see if they indicate any remaining Diagnostic Trouble Codes.

Bendix® RDU™ Communication Problems

If the ABS ECU does not respond to the RDU™ tool's request for diagnostic trouble codes, the RDU™ tool will illuminate each red LED in a clockwise pattern. This pattern indicates the loss of communication and will continue until the ABS ECU responds and communication has been established.

Possible sources of communication problems are:

1. A problem with the J1587 link at the in-cab off-board diagnostic connector (9 or 6 Pin).
2. The ECU does not support PID194.
3. No power is being supplied to the ECU and/or the diagnostic connector.
4. The J1587 bus is overloaded with information and the RDU can not arbitrate access.
5. A malfunctioning RDU™ tool.

Nexiq Bendix Application Card

Nexiq provides a Bendix application card for use with the ProLink tool. It can also be used to diagnose the EC-30™, EC-17™, Gen 4™, Gen 5™, and MC-30™ ABS Controllers.

For more information on the Bendix application card visit www.bendix.com, Nexiq at www.nexiq.com, or your local authorized Bendix parts outlet.

Bendix® ACom® Diagnostics Software

Bendix® ACom® Diagnostics is a PC-based software program and is designed to meet RP-1210 industry standards developed by the Truck Maintenance Council (TMC). This software provides the technician with access to all the available ECU diagnostic information and configuration capability, including:

- ECU information
- Diagnostic trouble codes and repair information
- Configuration (ABS, ATC, and more)
- Wheel speed information
- Perform component tests
- Save and print information



FIGURE 17 - NEXIQ (MPSI) PRO-LINK TOOL

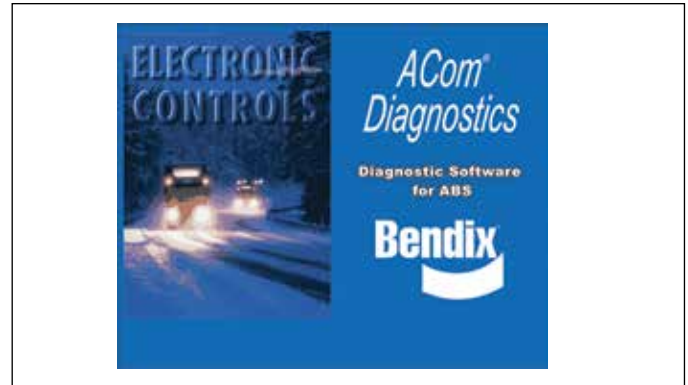

FIGURE 18 - BENDIX® ACOM® DIAGNOSTICS

ACom® Diagnostics V4.0 software is required to calibrate the Steering Angle Sensor, the Yaw Rate/Lateral Acceleration Sensor, the Brake Demand Sensors and the Load Sensor.

When using ACom® Diagnostics V4.0 (or higher) software to diagnose the Bendix EC-60 ABS ECU, the computer's serial or parallel port needs to be connected to the vehicle's diagnostic connector.

For more information on ACom® Diagnostics software or RP1210 compliant tools, go to www.bendix.com or visit your local authorized Bendix parts outlet.

See pages 51-60 for Appendices showing J1587 SID, FMI, and UDS codes and their Bendix blink code equivalents.

www.bendix.com

For the latest information, and for free downloads of the Bendix® ACom® Diagnostics software, and its User Guide, visit the Bendix website at www.bendix.com.

Bendix Technical Assistance Team

For direct telephone technical support, call the Bendix technical assistance team at:

1-800-AIR-BRAKE (1-800-247-2725),

Monday through Friday, 8:00 A.M. to 6:00 P.M. EST, and follow the instructions in the recorded message.

Or, you may e-mail the Bendix technical assistance team at: techteam@bendix.com.

Active or Inactive Diagnostic Trouble Codes:

INDEX

How to interpret the first digit of messages received when Active or Inactive Diagnostic Trouble Code Mode is entered.

1st Blink Code Number	Go Here for Troubleshooting Tests
1.....	No DTCs (1,1)
2.....	Wheel Speed Sensors - pages 27-28
3.....	Wheel Speed Sensors - pages 27-28
4.....	Wheel Speed Sensors - pages 27-28
5.....	Wheel Speed Sensors - pages 27-28
6.....	Power Supply - page 29
7.....	Pressure Modulator Valves - pages 30-31
8.....	Pressure Modulator Valves - pages 30-31
9.....	Pressure Modulator Valves - pages 30-31
10.....	Pressure Modulator Valves - pages 30-31
11.....	J1939 - pages 32-33
12.....	Miscellaneous - pages 34-35
13.....	ECU - page 36
14.....	Wheel Speed Sensors - pages 27-28
15.....	Wheel Speed Sensors - pages 27-28
16.....	Pressure Modulator Valves - pages 30-31
17.....	Pressure Modulator Valves - pages 30-31
18.....	Drive Axle Traction Control Valve - page 37
19.....	Steer Axle Traction Control Valve - page 37
20.....	Trailer Pressure Modulator Valve - pages 30-31
21.....	Steering Angle Sensor - pages 38-39
22.....	Yaw Rate Sensor - pages 40-41
23.....	Lateral Acceleration Sensor - page 42
24.....	Brake Demand/Load Sensors - page 43

Example: For a message sequence of:

3, 2 12, 4

For the first sequence go to page 27 and
for the second sequence go to page 34.

See Page 51 for APPENDIX B: J1587 SID and FMI Codes and their Bendix Blink Code Equivalents

See Page 56 for APPENDIX C: UDS Codes and their Bendix Blink Code Equivalents

Troubleshooting Diagnostic Trouble Codes: Wheel Speed Sensors

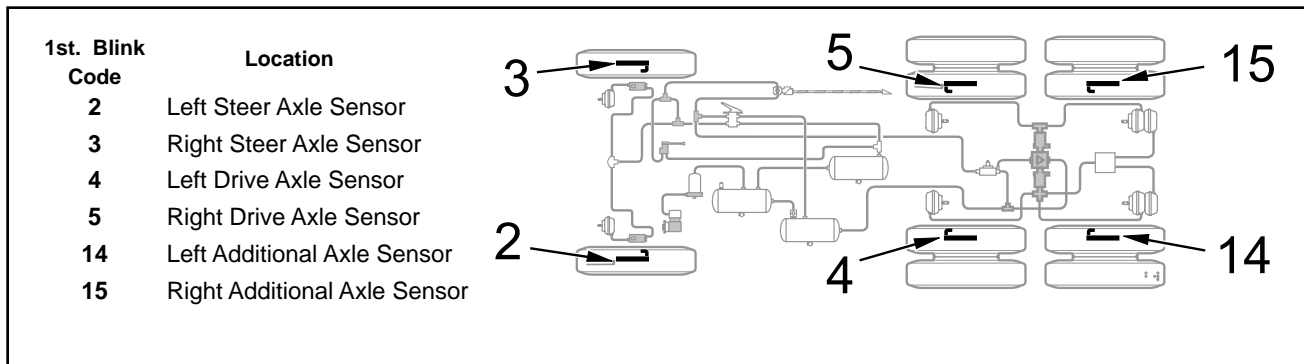

2nd. Blink Code	Diagnostic Trouble Code Description	Repair Information
1	Excessive Air Gap	Adjust sensor to contact exciter ring. Rotate wheel and verify a minimum of 0.25 VAC sensor output at ~ 0.5 RPS. Verify condition of sensor head. Verify mounting of exciter ring and condition of teeth. Verify proper bearing end-play. Verify condition and retention of clamping sleeve. Verify sensor lead routing and clamping.
2	Output Low at Drive-off	Adjust sensor to contact exciter ring. Rotate wheel and verify a minimum of 0.25 VAC sensor output at ~ 0.5 RPS. Verify condition of sensor head. Verify mounting of exciter ring and condition of teeth. Verify proper bearing end-play. Verify condition and retention of clamping sleeve. Verify sensor lead routing and clamping.
3	Open or Shorted	Verify 1500 – 2500 ohms across sensor leads. Verify no continuity between sensor leads and ground or voltage. Verify no continuity between sensor leads and other sensors. Check for corroded/damaged wiring or connectors between the ECU and the wheel speed sensor.
4	Loss of Sensor Signal	Adjust sensor to contact exciter ring. Rotate wheel and verify a minimum of 0.25 VAC sensor output at ~ 0.5 RPS. Verify condition of sensor head. Verify mounting of exciter ring and condition of teeth. Verify proper bearing end-play. Verify condition and retention of clamping sleeve. Verify sensor lead routing and clamping. Check for corroded/damaged wiring or connectors between the ECU and the wheel speed sensor.
5	Wheel End	Verify mounting of exciter ring and condition of teeth. Verify proper bearing end-play. Verify condition and retention of clamping sleeve. Verify sensor lead routing and clamping. Check mechanical function of brake. Check for kinked or restricted air lines.
6	Erratic Sensor Signal	Adjust sensor to contact exciter ring. Rotate wheel and verify a minimum of 0.25 VAC sensor output at ~ 0.5 RPS. Verify condition of sensor head. Verify mounting of exciter ring and condition of teeth. Verify proper bearing end-play. Verify condition and retention of clamping sleeve. Verify sensor lead routing and clamping. Check for corroded/damaged wiring or connectors between the ECU and the wheel speed sensor.
7	Tire Size Calibration	Verify correct tire size as desired. Verify proper tire inflation. Verify correct number of exciter ring teeth.
10	Configuration Error	ECU is configured for four sensors, but has detected the presence of additional sensors. Verify sensor wiring and ECU configuration.

Speed Sensor Repair Tests:

1. Take all measurements at ECU harness connector pins in order to check wire harness and sensor. Probe the connector carefully so that the terminals are not damaged.
2. Wheel speed sensor measurements should read:

Location	Measurement
Sensor	1500 - 2500 Ohms
Sensor to voltage or ground	Open Circuit (no continuity)
Sensor output voltage	>0.25 of VAC sensor output at ~ 0.5 revs/sec.

3. Clear DTC after issue is corrected. The sensor DTC will remain until the power is cycled to the ABS ECU and vehicle is driven above 15 MPH or DTC was cleared using either the diagnostic blink code switch or diagnostic tool.

Cab-mount ECU: Looking into wire harness connector

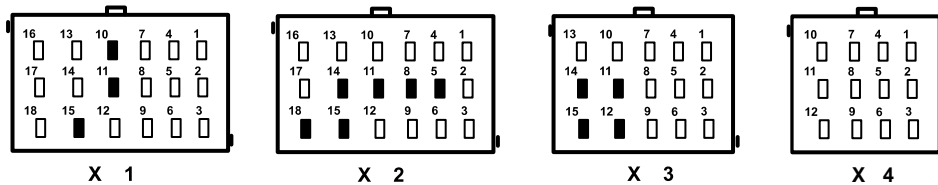

Connector	Pin	Wheel Speed Sensor Location
X1 18 Way	10	Right Drive Axle (+)
	11	Right Drive Axle (-)
X2 18 Way	5	Left Steer Axle (+)
	8	Left Steer Axle (-)
	11	Right Steer Axle (+)
	14	Right Steer Axle (-)
	15	Left Drive Axle (+)
X3 15 Way (if ECU is configured for 6 sensors)	11	Left Additional Axle (+)
	14	Left Additional Axle (-)
	12	Right Additional Axle (+)
	15	Right Additional Axle (-)

Troubleshooting Diagnostic Trouble Codes: Power Supply

1st. Blink Code	Location	2nd. Blink Code	Diagnostic Trouble Code Description	Repair Information
6	Power Supply			
		1	Battery Voltage Too Low	Measure battery voltage under load. Check vehicle battery and associated components. Check for damaged wiring. Check for damaged or corroded connectors and connections.
		2	Battery Voltage Too High	Measure battery voltage under load. Ensure that battery voltage is correct for the ECU. Check vehicle battery and associated components. Check for damaged wiring. Check for damaged or corroded connectors and connections.
		3	Battery Voltage Too Low During ABS	Measure battery voltage under load. Check vehicle battery and associated components. Check for damaged wiring. Check for damaged or corroded connectors and connections.
		4	Battery Voltage Open Circuit	Measure battery voltage under load. Check condition of fuse. Check vehicle battery and associated components. Check for damaged wiring. Check for damaged or corroded connectors and connections.
		5	Ignition Voltage Too Low	Measure ignition voltage under load. Check vehicle battery and associated components. Check for damaged wiring. Check for damaged or corroded connectors and connections. Check condition of fuse.
		6	Ignition Voltage Too High	Measure ignition voltage. Ensure that ignition voltage is correct for the ECU. Check vehicle battery and associated components. Check for damaged wiring. Check for damaged or corroded connectors and connections.
		7	Ignition Voltage Too Low During ABS	Measure ignition voltage under load. Check vehicle battery and associated components. Check for damaged wiring. Check for damaged or corroded connectors and connections.
		8	Input Voltage Has Excessive Noise (Temporary)	Check alternator output for excessive noise. Check for other devices causing excessive noise.
		9	Input Voltage Has Excessive Noise	Check alternator output for excessive noise. Check for other devices causing excessive noise.

Power Supply Tests:

1. Take all measurements at ECU harness connector.
2. Place a load (e.g. an 1157 stop lamp) across battery or ignition and ground connection, measure ignition and battery voltage with the load. Ignition to Ground should measure between 9 to 17 VDC. Battery to Ground should also measure between 9 to 17 VDC.
3. Check for damaged wiring, damaged or corroded connectors and connections.
4. Check condition of vehicle battery and associated components, ground connection good and tight.
5. Check alternator output for excessive noise.

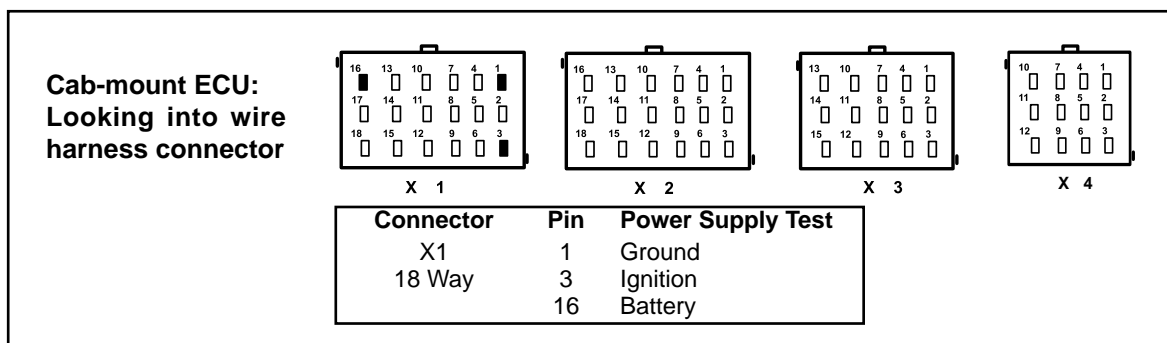

Troubleshooting Diagnostic Trouble Codes: Pressure Modulator Valves

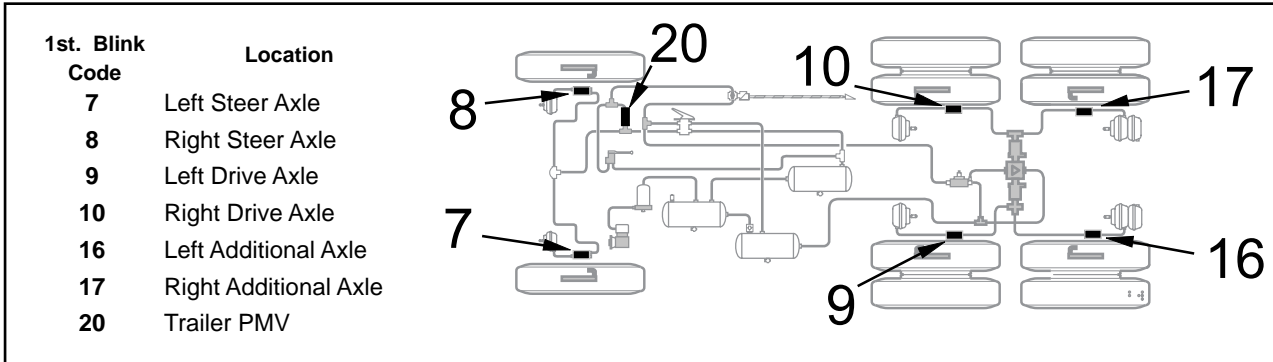

2nd. Blink Code	Diagnostic Trouble Code Description	Repair Information
1	Release Solenoid Shorted to Ground	Verify no continuity between PMV leads and ground. Verify 4.9 to 5.5 ohms from REL to CMN & HLD to CMN, and 9.8 to 11 ohms from REL to HLD. Check for corroded/damaged wiring or connectors between ECU and PMV.
2	Release Solenoid Shorted to Voltage	Verify no continuity between PMV leads and voltage. Verify 4.9 to 5.5 ohms from REL to CMN & HLD to CMN, and 9.8 to 11 ohms from REL to HLD. Check for corroded/damaged wiring or connectors between ECU and PMV.
3	Release Solenoid Open Circuit	Verify 4.9 to 5.5 ohms from REL to CMN & HLD to CMN, and 9.8 to 11 ohms from REL to HLD. Check for corroded/damaged wiring or connectors between ECU and PMV.
4	Hold Solenoid Shorted to Ground	Verify no continuity between PMV leads and ground. Verify 4.9 to 5.5 ohms from REL to CMN & HLD to CMN, and 9.8 to 11 ohms from REL to HLD. Check for corroded/damaged wiring or connectors between ECU and PMV.
5	Hold Solenoid Shorted to Voltage	Verify no continuity between PMV leads and voltage. Verify 4.9 to 5.5 ohms from REL to CMN & HLD CMN, and 9.8 to 11 ohms from REL to HLD. Check for corroded/damaged wiring or connectors between ECU and PMV.
6	Hold Solenoid Shorted to Open Circuit	Verify 4.9 to 5.5 ohms from REL to CMN & HLD to CMN, and 9.8 to 11 ohms from REL to HLD. Check for corroded/damaged wiring or connectors between the ECU and PMV.
7	CMN Open Circuit	Verify 4.9 to 5.5 ohms from REL to CMN & HLD to CMN, and 9.8 to 11 ohms from REL to HLD. Check for corroded/damaged wiring or connectors between the ECU and PMV. Potentially a miswired or internal mechanical problem.
8	Configuration Error	A mis-match exists between the ECU configuration and the modulator installation and wiring. Verify PMV wiring and installation. Verify ECU configuration. Special Note regarding Trailer PMV: Pneumatic issues can result in this DTC being set. Verify all lines are free from debris or other obstructions, kinks, etc.

Pressure Modulator Valve Repair Tests:

1. Take all measurements at ECU harness connector pins in order to check wire harness and PMV. Probe the connector carefully so that the terminals are not damaged.
2. Pressure modulator resistance should read:

Location	Measurement
Release to Common	4.9 to 5.5 Ohms
Hold to Common	4.9 to 5.5 Ohms
Release to Hold	9.8 to 11.0 Ohms
Release, Hold, Common to Voltage or Ground	Open Circuit (no continuity)

⚠ CAUTION: When troubleshooting modulator trouble codes, check inactive trouble codes and event history for over-voltage or excessive noise trouble codes. If one of these is found, troubleshoot these trouble codes first before the PMV.

Cab-mount ECU: Looking into wire harness connector

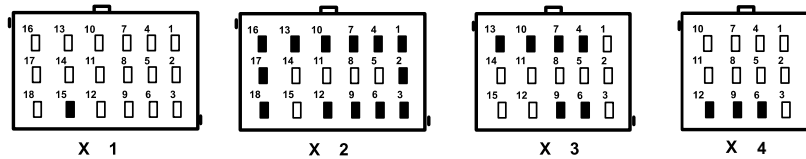

Connector	Pin	PMV Location
X2 18 Way	1	Left Steer Axle Hold
	2	Left Steer Axle Release
	3	Left Steer Axle Common
	4	Right Steer Axle Hold
	6	Right Steer Axle Common
	7	Right Steer Axle Release
	9	Right Drive Axle Common
	10	Right Drive Axle Hold
	13	Right Drive Axle Release
	12	Left Drive Axle Common
X3 15 Way (if ECU is configured for 6 modulators)	4	Left Additional Axle Hold
	6	Left Additional Axle Common
	7	Left Additional Axle Release
	9	Right Additional Axle Common
	10	Right Additional Axle Hold
X4 12 Way	13	Right Additional Axle Release
	6	Trailer PMV Hold
	9	Trailer PMV Release
	12	Trailer PMV Common

Troubleshooting Diagnostic Trouble Codes: J1939 Serial Communications

1st. Blink Code 11	Location: J1939	2nd. Blink Code	Diagnostic Trouble Code Description	Repair Information
		1	J1939 Serial Link	Loss of communications between the Bendix® EC-60™ controller and other devices connected to the J1939 link. Check for damaged or reversed J1939 wiring. Check for corroded or damaged connectors. Verify ECU Configuration. Check for other devices inhibiting J1939 communications.
		2	J1939 Retarder	Loss of communications between the Bendix EC-60 controller and other devices connected to the J1939 link. Check for damaged or reversed J1939 wiring. Check for corroded or damaged connectors. Verify presence of retarder on the J1939 link. Verify ECU Configuration. Check for other devices inhibiting J1939 communications.
		3	J1939 Engine Communications	Loss of communications between the Bendix EC-60 controller and the engine ECU over the J1939 link. Check for damaged or reversed J1939 wiring. Check for corroded or damaged connectors. Verify presence of engine ECU on the J1939 link. Verify ECU Configuration. Check for other devices inhibiting J1939 communications.
		4	J1939 Invalid Data (Engine Retarder)	Invalid data received from the engine or retarder. Check for damaged or reversed J1939 wiring. Check for damaged or corroded connectors. Verify presence of engine and/or retarder on J1939. Verify proper programming of engine and/or retarder. Check for other devices inhibiting J1939 communications.
		5	J1939 Supply Pressure	Invalid pressure signals received from a vehicle controller. Verify proper operation of brake demand sensors. Check wiring between brake demand sensors and the vehicle controller. Verify proper programming of vehicle controller. Check for damaged or reversed J1939 wiring. Check for damaged or corroded connectors. Check for other devices inhibiting J1939 communications.
		6	J1939 ESP Messages Invalid Data	Invalid ESP messages on the J1939 link. Check for damaged or reversed J1939 wiring. Check for damaged or corroded connectors. Verify presence of engine and/or retarder on J1939. Verify proper programming of engine and/or retarder. Check for other devices inhibiting J1939 communications.
		7	J1939 Transmission Communication for HSA	Loss of communications between the EC-60 ECU and the transmission ECU over the J1939 link. Check for damaged or reversed J1939 wiring. Check for damaged or corroded connectors. Verify presence of transmission ECU on J1939 link. Check for other devices inhibiting J1939 communications.
		8	J1939 Invalid Data	Invalid ESP messages on the J1939 link indicating the additional axle left is not valid. Check for damaged or reversed J1939 wiring. Check for damaged or corroded connectors. Check for other devices inhibiting J1939 communications.
		10	J1939 Invalid Data from Transmission	Invalid data from transmission message on the J1939 link. Check for damaged or reversed J1939 wiring. Check for damaged or corroded connectors. Verify presence of transmission on J1939. Verify proper programming of transmission. Check for other devices inhibiting J1939 communications.
		12	J1939 HSA Switch Error	Invalid HSA messages on the J1939 link indicating an HSA switch error or unavailable. Check for damaged or reversed J1939 wiring. Check for damaged or corroded connectors. Verify presence of HSA switch on J1939. Check for other devices inhibiting J1939 communications.
		13	J1939 Invalid Data	Invalid ESP messages on the J1939 link indicating error for ESP AWD function. Check for damaged or reversed J1939 wiring. Check for damaged or corroded connectors. Check for other devices inhibiting J1939 communications.

J1939 Troubleshooting Tests:

1. Take all measurements at ECU harness connector
2. Check for damaged or reversed J1939 wiring
3. Check for corroded or damaged wiring connector problems such as (opens or shorts to voltage or ground)
4. Check for other J1939 devices which may be loading down (inhibiting) J1939 communication

Cab-mount ECU:

Looking into wire harness connector

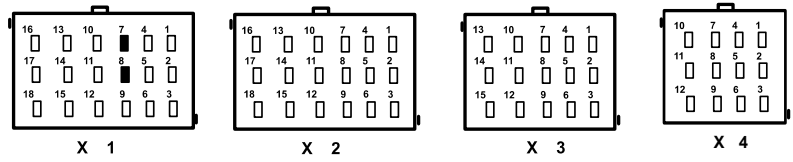

Connector	Pin	J1939
X1	7	J1939 Low
18 Way	8	J1939 High

Troubleshooting Diagnostic Trouble Codes: Miscellaneous

1st. Blink Code	Location: Miscellaneous	
12		
2nd. Blink Code	Diagnostic Trouble Code Description	Repair Information
1	Stop Lamp Switch Not Detected	ECU has not detected the presence of the stop lamp switch since ignition power was applied (note that stop lamp switch input may be applied to the Bendix® EC-60™ controller using either hardwire input or J1939). Apply and release service brake. Check for brake switch input into ECU (see system wiring schematic). With service brake released, check for presence of the stop lamp bulb. With service brake applied, verify system voltage is now present at the stop lamp switch input to the ECU. Check for damaged wiring between ECU, stop lamp switch and bulb. Check for corroded or damaged connectors. Check for damaged or reversed J1939 wiring. Check for corroded or damaged connectors on J1939 link. Verify presence of engine ECU on the J1939 link. Verify ECU configuration.
2	Stop Lamp Switch Defective	Apply and release service brake. Check for brake switch input into ECU (see system wiring schematic). With service brake released, check for presence of the stop lamp bulb. With service brake applied, verify system voltage is now present at the stop lamp switch input to the ECU. Check for damaged wiring between ECU, stop lamp switch and bulb. Check for corroded or damaged connectors. Check for damaged or reversed J1939 wiring. Check for corroded or damaged connectors on J1939 link. Verify presence of engine ECU on the J1939 link. Verify ECU configuration.
3	ATC Disabled or Dynamometer Test Mode Active	ATC is disabled. ECU has been placed in the Dynamometer Test Mode by either the diagnostic blink code switch or a hand-held or PC-based diagnostic tool. Clear DTCs to exit Dynamometer Test Mode.
4	Retarder Relay or HSA Lamp Open Circuit or Shorted to Ground	Verify vehicle contains a retarder relay or Hill Start Assist (HSA) lamp. Verify ECU configuration. Check wiring between ECU and retarder relay or HSA lamp. Verify no continuity between retarder disable output or HSA lamp output of Bendix EC-60 controller and ground. Verify condition and wiring of the retarder relay or HSA lamp.
5	Retarder Relay or HSA Lamp Circuit Shorted to Voltage	Check wiring between ECU and retarder relay or HSA lamp. Verify no continuity between retarder disable output or HSA lamp output of Bendix EC-60 controller and voltage. Verify condition and wiring of the retarder relay or HSA lamp.
6	ABS Indicator Lamp Circuit DTC	Check operation of diagnostic blink code switch. Check wiring of diagnostic blink code switch (verify ABS wire is not grounded where used) and ABS Indicator Lamp. Verify ABS Indicator Lamp ground input. On some vehicles with multi-plex dashes, the ground wire may not be present - see <i>ECU 19 DTC</i> .
7	PMV Common Shorted to Ground	Verify no continuity between the Release, Hold and CMN of all PMVs, TCV, HSA, Diff Lock Solenoid and ground. Check for corroded/damaged wiring or connectors between the ECU and CMN of all PMVs, TCV, and Diff Lock Solenoid. See extended troubleshooting for this code in Appendix A.
8	PMV Common Shorted to Voltage	Verify no continuity between the Release, Hold and CMN of all PMVs, TCV, HSA, Diff Lock Solenoid and voltage. Check for corroded/damaged wiring or connectors between the ECU and CMN of all PMVs, TCV, and Diff Lock Solenoid.
9	ATC Disabled to Prevent Brake Fade	ATC is temporarily disabled to prevent excessive heating of the foundation brakes.
10	Tire Size Out of Range (Front to Rear)	Verify correct tire size as desired. Verify proper tire inflation. Verify correct number of exciter ring teeth. Verify that the ECU has the proper tire size settings.
11	Wheel Speed Sensors Reversed on an Axle	Sensors are reversed (left to right) on one of the axles. Verify proper installation, connection, and wiring of the sensors.

Troubleshooting Diagnostic Trouble Codes: Miscellaneous Continued

1st. Blink Code	Location: Miscellaneous	
12		
2nd. Blink Code	Diagnostic Trouble Code Description	Repair Information
12	Diff. Lock Solenoid Shorted to Ground or Open Circuit	Verify no continuity between the Diff Lock Solenoid and ground. Check for corroded/damaged wiring or connectors between the ECU and Diff Lock Solenoid.
13	Diff. Lock Solenoid Shorted to Voltage	Verify no continuity between the Diff Lock Solenoid and voltage. Check for corroded/damaged wiring or connectors between the ECU and Diff Lock Solenoid. Issue a "Clear DTC" command to exit Dynamometer Test Mode.
14	Sensor CAN Supply Voltage Error	Incorrect supply voltage for the SAS-60 and the Yaw Rate sensor. Verify proper voltage at sensor connectors. Verify wiring between the ECU and the sensors. Verify proper output voltage from ECU. <i>Note: When checking for voltage at YAW/LAS & SAS, the voltage will only be present momentarily at key ON.</i>
15-21	Reserved	
22	ESP Sensor Voltage Out of Range	Incorrect supply voltage for the SAS-60 and the Yaw Rate sensor. Verify proper voltage at sensor connectors. Verify wiring between the ECU and the sensors. Verify proper output voltage from ECU. <i>Note: When checking for voltage at YAW/LAS & SAS, the voltage will only be present momentarily at key ON.</i>
23	Short to Voltage	I/O 2 or I/O 3 Shorted to Voltage. <i>(A good location to check first, is the ECU Stop Lamp Relay wiring output X3-8.)</i>
24	HSA Solenoid Shorted to Voltage	Verify no continuity between the HSA Solenoid and voltage. Check for corroded/damaged wiring or connectors between the ECU and HSA solenoid.
25	HSA Solenoid Open or Shorted to Ground	HSA solenoid is shorted to ground or has a broken wire. Verify no continuity between the HSA solenoid and ground. Check for corroded/damaged wiring or connectors between the ECU and the HSA solenoid.
26	HSA Solenoid Shorted to Voltage	Verify no continuity between the HSA Solenoid and voltage. Check for corroded/damaged wiring or connectors between the ECU and HSA Solenoid.
27	Brake Lamp	Brake lamp input mismatch with brake lamp output

Troubleshooting Diagnostic Trouble Codes: ECU

1st. Blink Code 13	Location: ECU	2nd Blink Code	Bendix® ACom® Software Description	Repair Information
		1	ECU DTC '02'	13-1 through 13-7: Check for damaged or corroded connectors. Check for damaged wiring including power and ground wiring. Clear the trouble codes. If Diagnostic Trouble Codes (DTCs) return, contact the Bendix Tech Team at 1-800-AIR-BRAKE (1-800-247-2725) for further troubleshooting assistance.
		2	ECU DTC '10'	
		3	ECU DTC '11'	
		4	ECU DTC '12'	
		5	ECU DTC '13'	
		6	ECU DTC '14'	
		7	ECU DTC '15'	
		8	Invalid ABS Configuration ECU DTC '16'	<p>Codes 13-8 and 13-18: Check the ECU for damaged or corroded connectors. Check for damaged wiring including power and ground wiring. Clear the trouble codes. If one of these DTCs return, contact the Bendix Tech Team at 1-800-AIR-BRAKE (1-800-247-2725) for further troubleshooting assistance.</p> <div style="border: 1px solid black; padding: 5px;"> <p>When troubleshooting either of these DTCs, it is important to inspect the ATR valves used for full stability and — if they have a DTC — repair them first. <i>Note: Never run an ECU self-configuration before completing the ATC repair and clearing its DTC, or a misleading 13-8 or 13-18 DTC may result.</i></p> </div>
		9	ECU DTC '17'	13-9 through 13-17: Check for damaged or corroded connectors. Check for damaged wiring including power and ground wiring. Clear the trouble codes. If Diagnostic Trouble Codes (DTCs) return, contact the Bendix Tech Team at 1-800-AIR-BRAKE (1-800-247-2725) for further troubleshooting assistance.
		10	ECU DTC '18'	
		11	ECU DTC '1A'	
		12	ECU DTC '1B'	
		13	ECU DTC '80'	
		14	ECU DTC '04'	
		15	ECU DTC '06'	
		16	ECU DTC '0E'	
		17	ECU DTC '0D'	
		18	Invalid ESP Configuration ECU DTC '19'	See 13-8 above... Additionally, a 13-19 DTC can be the result of a parameter file not having been downloaded. To verify that vehicle-specific parameters have been loaded, contact Bendix for more information at 1-800-AIR-BRAKE (1-800-247-2725).
		19	ECU DTC '1C'	13-19 through 13-24: Check for damaged or corroded connectors. Check for damaged wiring including power and ground wiring. Clear the trouble codes. If DTCs return, contact the Bendix Tech Team at 1-800-AIR-BRAKE (1-800-247-2725) for further troubleshooting assistance.
		20	ECU DTC '27'	
		21	ECU DTC '1D'	
		22	ECU DTC '1E'	
		23	ECU DTC '28'	
		24	ECU DTC '37'	
		25	ECU Internal VIN Mismatch	The ECU internally-stored VIN does not match the VIN of the vehicle. Ensure that the ECU is installed on the correct vehicle. Verify ECU programming. Verify engine programming.

Troubleshooting Diagnostic Trouble Codes: Traction Control Valves

1st. Blink Code	Location
18	Drive Axle Traction Control Valve
19	Steer Axle Traction Control Valve

NOTE: Also see ECU 13-8 and 13-18 DTC repair information on page 36, for a potential connection between these TCV DTCs and ECU DTCs.

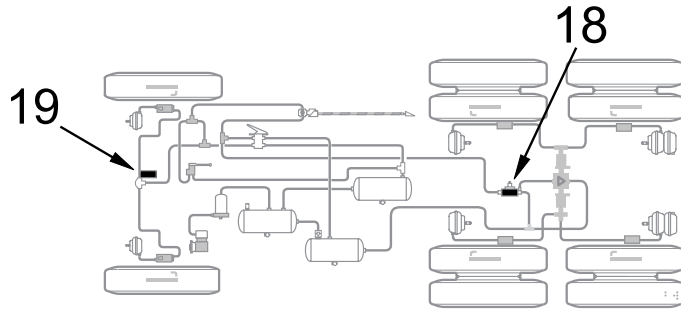

2nd. Blink Code	Diagnostic Trouble Code Description	Repair Information
1	TCV Solenoid Shorted to Ground	Verify 7 to 19 ohms between TCV and TCV common. Verify no continuity between TCV leads and ground. Check for corroded/damaged wiring or connectors between ECU and TCV.
2	TCV Solenoid Shorted to Voltage	Verify 7 to 19 ohms between TCV and TCV common. Verify no continuity between TCV leads and voltage. Check for corroded/damaged wiring or connectors between ECU and TCV.
3	TCV Solenoid Open Circuit	Verify 7 to 19 ohms between TCV and TCV common. Check for corroded/damaged wiring or connectors between ECU and TCV.
4	TCV Configuration Error	The ECU is not configured for ESP or ATC, but has detected the presence of a TCV. Verify TCV wiring. Inspect for the presence of a TCV. Verify ECU configuration.

ATR valve inspections should include: looking for kinked air hoses; inside the harness socket on the valve for removed or corroded connector pins; and a test to verify that the ATC valve solenoids are functioning correctly.

Traction Control Valve Repair Tests:

1. Take all measurements at ECU harness connector pins in order to check wire harness and traction control valve. Probe the connector carefully so that the terminals are not damaged.
2. Tractor Control Valve resistance measurements should read:

Location	Measurement
TCV to TCV Common	7 to 19 Ohms
Release, Hold, Common to Voltage or Ground	Open Circuit (no continuity)

Cab-mount ECU:

Looking into wire harness connector

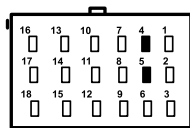

X 1

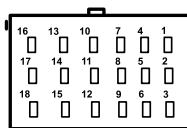

X 2

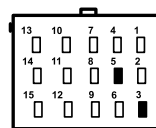

X 3

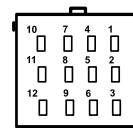

X 4

Connector	Pin	Traction Control Test	Connector	Pin	Traction Control Test
X1	4	Drive Axle Traction Control Valve Common	X3	3	Steer Axle Traction Control Valve Common
18 Way	5	Drive Axle Traction Control Valve	15 Way	5	Steer Axle Traction Control Valve

Troubleshooting Diagnostic Trouble Codes: Steering Angle Sensor (SAS-60™ sensor)

1st. Blink Code 21	Location: Steering Angle Sensor
------------------------------	---

2nd. Blink Code	Diagnostic Trouble Code Description	Repair Information
1	SAS Not Calibrated	SAS has not been calibrated. Perform SAS calibration procedure.
2	SAS Calibration in Progress	SAS calibration procedure is underway.
3	SAS Static Signal	SAS signal incorrect. Verify proper installation of the SAS. Verify proper wiring between the ECU and the SAS. Check SAS output.
4	SAS Signal Out of Range	SAS signal incorrect. Verify proper installation of the SAS. Verify proper wiring between the ECU and the SAS. Check SAS output. Perform SAS calibration procedure.
5	SAS Signal Reversed	SAS signal is reversed. Verify proper installation of the SAS. Verify proper wiring between the ECU and the SAS. Check SAS output.
6	SAS Invalid Signal	SAS signal is invalid. Verify proper installation of the SAS. Verify proper wiring between the ECU and the SAS. Check SAS output. Verify that correct SAS is being used.
7	SAS Gradient Error	SAS signal is invalid. Verify proper installation of the SAS. Verify proper wiring between the ECU and the SAS. Check SAS output. Verify that correct SAS is being used.
8	SAS CAN Timeout	Loss of CAN communications between the ECU and the SAS. Verify proper wiring between the ECU and the SAS. Check SAS output.
9	SAS Long Term Calibration Error	SAS calibration error. Verify proper installation of the SAS. Verify proper wiring between the ECU and the SAS. Check SAS output. Verify that correct SAS is being used. Verify proper ECU programming. Perform SAS calibration procedure.
10	SAS Plausibility Check	ECU has detected incorrect SAS signal as compared to the Yaw Rate sensor signal. Verify proper installation of the SAS. Verify proper wiring between the ECU and the SAS. Check SAS output. Verify that correct SAS is being used. Verify proper ECU programming. Perform SAS calibration procedure.

Troubleshooting Diagnostic Trouble Codes: Steering Angle Sensor (SAS-60™ sensor) (continued)

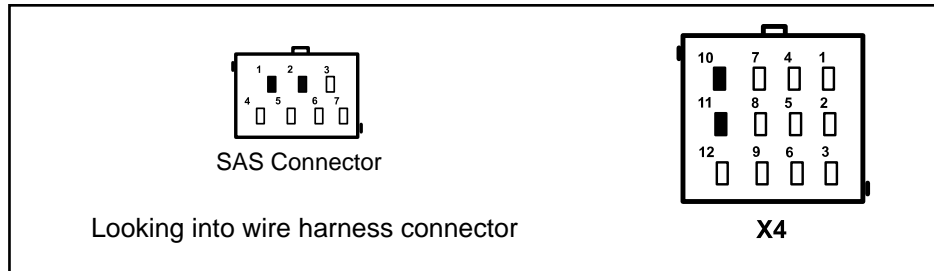

(Note: When checking for voltage at YAW/LAS & SAS, the voltage will only be present momentarily at key ON.)

Steering Angle Sensor Tests

1. Measure resistance between input voltage and ground at the sensor wiring harness connector.
Verify continuity between ECU and SAS-60 and YAS-60.

Connector	Pin	Function	
SAS	2	Voltage Input	
	1	Ground Input	
ECU	X4	11	Power
	12 Way	10	Common

2. Verify wiring between the Steering Angle Sensor and the ECU.

SAS Wire Harness Terminal	ECU Wire Harness Terminal	Measurement
4	7	Verify Continuity
3	8	Verify Continuity

3. Verify wiring between the Steering Angle Sensor and power/ground.

SAS Wire Harness Terminal	Measurement
4 to Voltage & Ground	Verify open circuit (no continuity)
3 to Voltage & Ground	Verify open circuit (no continuity)

4. To perform a calibration procedure of the Steering Angle Sensor, ACom® Diagnostics V4.0 or higher is required. Using the program, select the “Configuration” option, followed by the “Calibrate” option. The following screen should be displayed.



5. Follow the prompts to perform a calibration of the Steering Angle Sensor.
6. To test the Steering Angle Sensor, ACom V4.0, or higher, is required. Using Bendix ACom V4.0 or higher, select the “Component Test” option, followed by the “ESP Test” option. The following screen should be displayed.

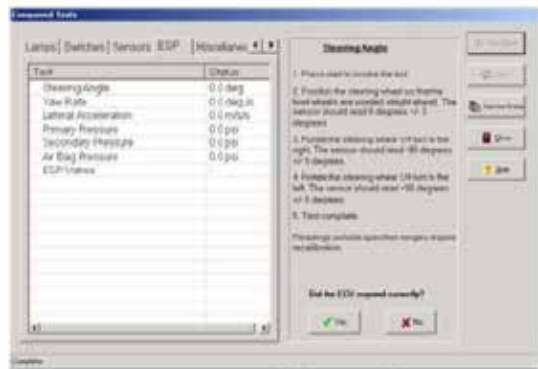

7. Follow the prompts to perform a test of the Steering Angle Sensor.

Troubleshooting Diagnostic Trouble Codes: Yaw Rate Sensor (YRS)

**1st. Blink
Code**
22

Location:
Yaw Rate Sensor

2nd. Blink Code	Diagnostic Trouble Code Description	Repair Information
1	YRS Signal Out of Range	YRS signal incorrect. Verify proper installation of the YRS. Verify proper wiring between the ECU and the YRS. Check YRS output. Perform YRS calibration procedure.
2	YRS Sensor Reversed Signal	YRS signal is reversed. Verify proper installation of the YRS. Verify proper wiring between the ECU and the YRS. Check YRS output.
3	YRS Invalid Signal	YRS signal is invalid. Verify proper installation of the YRS. Verify proper wiring between the ECU and the YRS. Check YRS output. Verify that correct YRS is being used.
4	YRS Gradient Error	YRS signal is invalid. Verify proper installation of the YRS. Verify proper wiring between the ECU and the YRS. Check YRS output. Verify that correct YRS is being used.
5	YRS CAN Timeout	Loss of CAN communications between the ECU and the YRS. Verify proper wiring between the ECU and the YRS. Check YRS output.
6	YRS Static BITE Error	YRS signal fails static self-test. Verify proper installation of the YRS. Verify proper wiring between the ECU and the YRS. Check YRS output. Verify that correct YRS is being used. Verify proper ECU programming. Perform YRS calibration procedure.
7	YRS Dynamic BITE Error	YRS signal fails self-test conducted while vehicle is in motion. Verify proper installation of the YRS. Verify proper wiring between the ECU and the YRS. Check YRS output. Verify that correct YRS is being used. Verify proper ECU programming. Perform YRS calibration procedure.
8	YRS Fast Calibration Error	YRS calibration error. Verify proper installation of the YRS. Verify proper wiring between the ECU and the YRS. Check YRS output. Verify that correct YRS is being used. Verify proper ECU programming. Perform YRS calibration procedure.
9	YRS Static Calibration Error	YRS calibration error. Verify proper installation of the YRS. Verify proper wiring between the ECU and the YRS. Check YRS output. Verify that correct YRS is being used. Verify proper ECU programming. Perform YRS calibration procedure.
10	YRS Normal Calibration Error	YRS calibration error. Verify proper installation of the YRS. Verify proper wiring between the ECU and the YRS. Check YRS output. Verify that correct YRS is being used. Verify proper ECU programming. Perform YRS calibration procedure.
11	YRS Sensitivity Calibration Error	YRS calibration error. Verify proper installation of the YRS. Verify proper wiring between the ECU and the YRS. Check YRS output. Verify that correct YRS is being used. Verify proper ECU programming. Perform YRS calibration procedure.
12	YRS Plausibility Check (Ref Yaw Rate)	ECU has detected an incorrect YRS signal. Verify proper installation of the YRS. Verify proper wiring between the ECU and the YRS. Check YRS output. Verify that correct YRS is being used. Verify proper ECU programming. Perform YRS calibration procedure.
13	YRS Plausibility Error (Inside Model Based Limits)	ECU has detected an incorrect YRS signal. Verify proper installation of the YRS. Verify proper wiring between the ECU and the YRS. Check YRS output. Verify that correct YRS is being used. Verify proper ECU programming. Perform YRS calibration procedure.
14	YRS Plausibility Error (Outside Model Based Limits)	ECU has detected an incorrect YRS signal. Verify proper installation of the YRS. Verify proper wiring between the ECU and the YRS. Check YRS output. Verify that correct YRS is being used. Verify proper ECU programming. Perform YRS calibration procedure.
15	YRS - SAS Signal Cross-check Incomplete	ECU (if configured) must confirm that YRS and SAS signals match. The vehicle must be exposed to an S-shaped driving maneuver for this DTC to automatically clear. If the DTC does not clear even after the S-shaped driving maneuver, check and correct the orientation of the YRS and repeat maneuver.
16	YRS - Vibration Detected	Inspect YRS mounting and verify it is securely mounted. Note that YRS may not be relocated from OEM-installed position on vehicle without written Bendix Engineering approval.

Troubleshooting Diagnostic Trouble Codes: Yaw Rate Sensor (YRS) (continued)

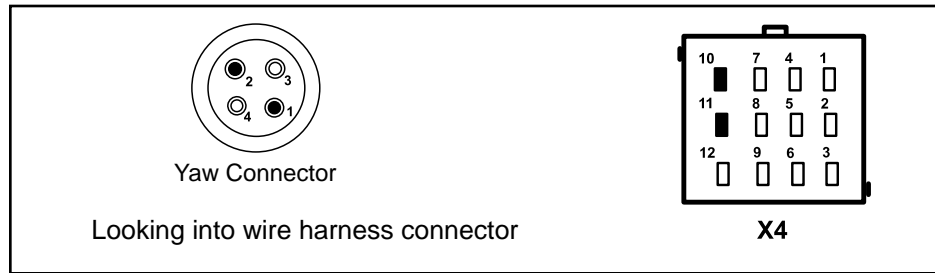

(Note: When checking for voltage at YAW/LAS & SAS, the voltage will only be present momentarily at key ON.)

Yaw Rate Sensor Tests

1. Verify continuity between ECU and YAS-60.

Connector	Pin	Function	
YAS	1	Power	
	2	Ground	
ECU	X4	11	Power
	12 Way	10	Common

2. Verify wiring between the Yaw Rate Sensor and the ECU.

YRS Wire Harness Terminal	ECU Wire Harness Terminal	Measurement
4	7	Verify Continuity
3	8	Verify Continuity

3. Verify wiring between the Yaw Rate Sensor and power/ground.

YRS Wire Harness Terminal	Measurement
4 to Voltage & Ground	Verify open circuit (no continuity)
3 to Voltage & Ground	Verify open circuit (no continuity)

4. To perform a calibration procedure of the Yaw Rate Sensor, ACom® Diagnostics V4.0 or higher is required. Using the program, select the “Configuration” option, followed by the “Calibrate” option. The following screen should be displayed.



5. Follow the prompts to perform a calibration of the Yaw Rate Sensor.
6. To test the Yaw Rate Sensor, ACom V4.0, or higher, is required. Using Bendix ACom V4.0 or higher, select the “Component Test” option, followed by the “ESP Test” option. The following screen should be displayed.

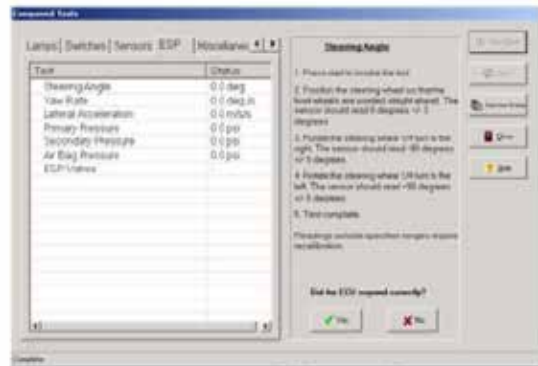

7. Follow the prompts to perform a test of the Yaw Rate Sensor.

Troubleshooting Diagnostic Trouble Codes: Lateral Acceleration Sensor (LAS)

1st. Blink Code 23	Location: Lateral Acceleration Sensor		
2nd. Blink Code	Diagnostic Trouble Code Description	Repair Information	
1	LAS Signal Out of Range	LAS signal incorrect. Verify proper installation of the YRS/LAS. Verify proper wiring between the ECU and the YRS/LAS. Check YRS/LAS output. Perform LAS calibration procedure.	
2	LAS Calibration in Progress	LAS calibration procedure is underway.	
3	LAS Static Calibration Error	LAS calibration error. Verify proper installation of the YRS/LAS. Verify proper wiring between the ECU and the YRS/LAS. Check YRS/LAS output. Verify that correct YRS/LAS is being used. Verify proper ECU programming. Perform LAS calibration procedure.	
4	LAS Long Term Calibration Error	LAS calibration error. Verify proper installation of the YRS/LAS. Verify proper wiring between the ECU and the YRS/LAS. Check YRS/LAS output. Verify that correct YRS/LAS is being used. Verify proper ECU programming. Perform LAS calibration procedure.	
5	LAS Plausibility Error (Inside ECU-specific Limits)	ECU has detected an incorrect LAS signal. Verify proper installation of the YRS/LAS. Verify proper wiring between the ECU and the YRS/LAS. Check YRS/LAS output. Verify that correct YRS/LAS is being used. Verify proper ECU programming. Perform LAS calibration procedure.	
6	LAS Plausibility Error (Outside ECU-specific Limits)	ECU has detected an incorrect LAS signal. Verify proper installation of the YRS/LAS. Verify proper wiring between the ECU and the YRS/LAS. Check YRS/LAS output. Verify that correct YRS/LAS is being used. Verify proper ECU programming. Perform LAS calibration procedure.	
7	Erratic ESP Sensor Signal	ECU has detected an erratic signal. Verify proper installation of the YRS/LAS. Verify proper wiring between the ECU and the YRS/LAS. Check YRS/LAS output. Verify that correct YRS/LAS is being used. Verify proper ECU programming. Perform LAS calibration procedure.	

(Note: When checking for voltage at YRS/LAS & SAS, the voltage will only be present momentarily at key ON.)

1. Follow the steps shown in the Yaw Rate Sensor troubleshooting section for calibration and troubleshooting of the Lateral Acceleration Sensors.

Troubleshooting Diagnostic Trouble Codes Brake Demand/Load Sensors

1st. Blink Code	Location:	
24	Brake Demand/ Load Sensor	

2nd. Blink Code	Diagnostic Trouble Code Description	Repair Information
1	PS1 Open or Shorted	Check wiring between Brake Demand Sensor (primary brake circuit) and ECU. Verify operation of pressure sensor.
2	PS2 Open or Shorted	Check wiring between Brake Demand Sensor (secondary brake circuit) and ECU. Verify operation of pressure sensor.
3	PS3 Open or Shorted	Check wiring between Load Sensor and ECU. Verify operation of pressure sensor.
4	PS1/2 Plausibility Error	ECU has detected an invalid pressure sensor signal from one of the Brake Demand Sensors.
5	PS Supply Voltage Error	Incorrect supply voltage to the sensors. Verify proper voltage at sensor connectors. Verify wiring between the ECU and the sensors. Verify proper output voltage from the ECU (Specifically, ensure that X4-4 PS_SPL is not shorted to ground).
6	PS Not Calibrated	Perform static sensor calibration procedure. <i>(NOTE: When replacing an ECU, this DTC may occur.)</i>
7	PS Error	Verify operation of pressure sensor.

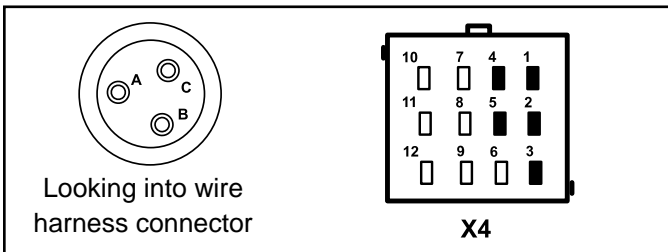

Brake Demand/Load Sensor Tests

1. Verify continuity between the ECU and the pressure sensor power and ground.

Test	Measurement
Power and Ground Input	X4 - 4 Power
B = Power Input	X4 - 1 Common
A = Ground Input	

2. Verify wiring between the Load Sensor and the ECU.

Load Sensor Wire Harness Terminal	ECU Wire Harness Terminal	Measurement
C	X4 - 2 Brake Demand Sensor (primary brake circuit)	Verify Continuity
	X4 - 5 Brake Demand Sensor (secondary brake circuit)	Verify Continuity
	X4 - 3 Load Sensor	Verify Continuity

3. Verify wiring between the Load Sensor and power/ground.

Load Sensor Harness Terminal	Measurement
C to Voltage & Ground	Verify open circuit (no continuity)

4. To perform a calibration procedure of the Brake Demand Sensor(s), ensure that the air system is fully charged. Apply ignition power, and wait 30 seconds. Perform a full application of the service brake and hold for 5 seconds. Release the service brake.
5. To test the Brake Demand Sensor and/or the Load Sensor, ACom V4.0 or higher is required. Using the program, select the "Component Test" option, followed by the "ESP Test" option. The following screen should be displayed.

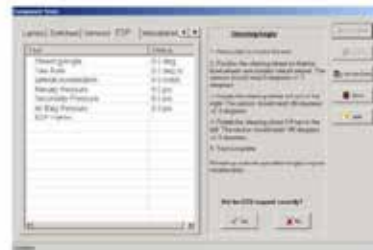

6. Follow the prompts to test the Brake Demand Sensor(s) and/or the Load Sensor.

Troubleshooting: Connectors

Bendix® EC-60™ Controller Wire Harness

Connector Part Numbers and Pin Assignments:

ADVANCED CAB

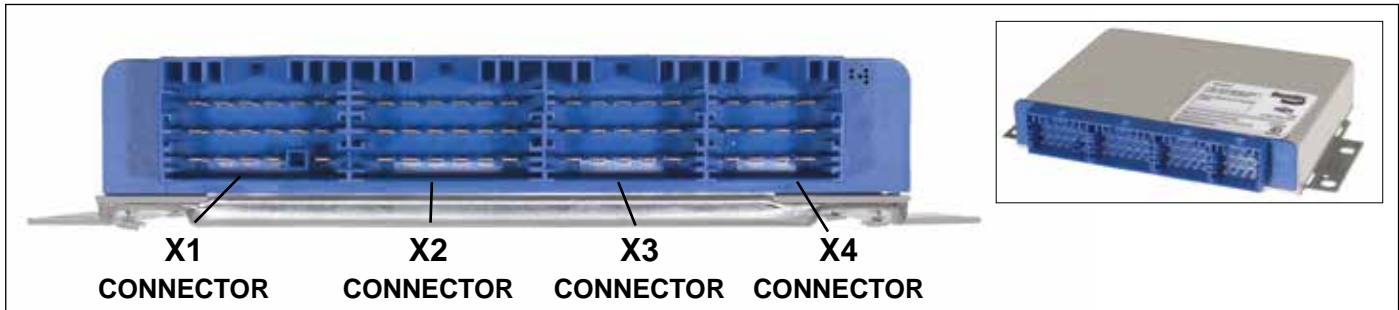

Advanced Cab Bendix EC-60 Controller

Advanced cab models utilize four AMP connectors for wire harness connections.

	X1 Connector Pin Assignments	X2 Connector Pin Assignments	X3 Connector Pin Assignments	X4 Connector Pin Assignments
Pin	Designation	Designation	Designation	Designation
1	Ground	PMV SA Left HLD	ABS ORS	Pressure Sensor CMN
2	Trailer ABS Indicator	PMV SA Left REL	Diff. Lock SOL*	Brake Demand Primary CKT Signal
3	Ignition	PMV SA Left CMN	TCV CMN (SA)	Load Sensor Signal
4	TCV CMN (DA)	PMV SA Right HLD	PMV AA Left HLD	Pressure Sensor Supply
5	TCV (DA)	WSS SA Left (+)	TCV (SA)	Brake Demand Secondary CKT Signal
6	ATC/ESP Indicator and ATC ORS	PMV SA Right CMN	PMV AA Left CMN	PMV Trailer HLD
7	J1939 Low	PMV SA Right REL	PMV AA Left REL	Sensor CAN Low
8	J1939 High	WSS SA Left (-)	Stop Lamp Output	Sensor CAN High
9	SLS Input	PMV DA Right CMN	PMV AA Right CMN	PMV Trailer REL
10	WSS DA Right (+)	PMV DA Right HLD	PMV AA Right HLD	Sensor CAN Common
11	WSS DA Right (-)	WSS SA Right (+)	WSS AA Left (+)	Sensor CAN Supply
12	ABS Indicator Ground	PMV DA Left CMN	WSS AA Right (+)	PMV Trailer CMN
13	J1587 (B)	PMV DA Right REL	PMV AA Right REL	
14	J1587 (A)	WSS SA Right (-)	WSS AA Left (-)	
15	ABS Indicator Interlock	WSS DA Left (+)	WSS AA Right (-)	
16	Battery	PMV DA Left HLD		
17	Retarder	PMV DA Left REL		
18	ABS Dash Indicator	WSS DA Left (-)		

*AWD vehicles only. (AWD Transfer Case)

Troubleshooting: Wiring

ABS/ATC WIRING

ECU Wiring Harness Connectors

The Advanced Bendix® EC-60™ controller is designed to interface with AMP MCP 2.8 connectors as referenced in Chart 4. Follow all AMP requirements for the repair of wire harnesses.

All wire harness connectors must be properly seated. The use of secondary locks is strongly advised.

⚠ CAUTION: All unused ECU connectors must be covered and receive proper environmental protection.

ABS Wiring Requirements

As a matter of good practice and to ensure maximum system robustness, always use the maximum size wire supported by the wire harness connectors for battery, ignition, ground, PMV, TCV, Interaxle Differential Lock and indicator lamp circuits.

All sensor and serial communications circuits (J1587 and J1939) must use twisted pair wiring (one to two twists per inch). See the appropriate SAE document for additional details.

⚠ CAUTION: All wires must be carefully routed to avoid contact with rotating elements. Wiring must be properly secured approximately every 6 to 12 inches using UV stabilized, non-metallic hose clamps or bow-tie cable ties to prevent pinching, binding or fraying.

It is recommended that wires be routed straight out of a connector for a minimum of three inches before the wire is allowed to bend.



Battery and ground wires should be kept to a minimum length.

If convoluted tubing is used, its I.D. must match the size of the wire bundle as closely as possible.

⚠ CAUTION: Wire harness lengths must be carefully selected for the vehicle. Excess lengths of wire are **not** to be wound to form coils, instead re-route, repair or replace wire harness to avoid the possibility of electrical interference and wire damage. Do not attempt to stretch harnesses that are too short, since mechanical strain can result in wire breakage.

SAS-60™ Sensors and YAS-60™, or YAS-70X™, Sensor Wiring

If it is necessary to replace the wiring that connects the SAS-60™ or the Yaw Rate sensor to the ECU, it is important to use the same wiring as that used by the vehicle OEM.

ABS Component	Connector	Wire Terminal	Wire Seal/ Plug	Terminal Lock	Terminal Crimp Tool
In-Cab Controller Harness 17-Way AMP MCP 2.8 (X1)	 1718091-1	 927768-9 1 - 2.5 mm ² X1-12 & 18	N/A	 967634	 539723-2
In-Cab Controller Harness 18-Way AMP MCP 2.8 (X2)	 8-968974-1		N/A	N/A	
In-Cab Controller Harness 15-Way AMP MCP 2.8 (X3)	 8-968973-1	 968874 2.5 - 4 mm ²	N/A	N/A	
Controller Harness 12-Way AMP MCP 2.8 (X4)	 8-968972-1	 968873 1.0 - 2.5 mm ²	N/A	N/A	
ABS Modulator Harness AMP Twist-Lock (Bayonet)	 1-967325-2	 929975-1	N/A	N/A	 539635-1
ATC Modulator Harness AMP Twist-Lock (Bayonet)	 1-967325-3		N/A	N/A	
ABS Modulator Harness 3-pin Packard Metri-Pack 280 Series	 12040977	 12077411	 12015323	 12034145	 12155975

WS-24™ Wheel Speed Sensor Connectors



Packard GT
150 series



Packard
Metri-pack 150.2
series



Deutsch DTM06
series



Packard
Metri-pack 280
series (female)



Packard
Metri-pack 280
series (male)



Deutsch DT04
series



Standard round
two pin

Yaw Rate Sensor Wire Harness Connectors (4 contact):

Straight Connector: Schlemmer 9800 351 (shown)

AMP Connector 2-967325-1

ITT Cannon Connector 121583-001

90 degree Connector: Schlemmer 9800 331



Yaw Rate Sensor Wire Harness

Contact Pin Terminals:

Schlemmer 7814 125

AMP 0-962981-1

ITT Cannon 031-8717-120

Brake Demand Sensor/Load Sensor

Wire Harness Connectors:

Metri-Pack (Packard) 1206 5287

Contact Pins:

Packard 1210 3881



SAS-60™ Sensor Connectors:

Robert Bosch 1 928 404 025,

Robert Bosch 1 928 498 001

One Meter Adapter to Connector:

Bendix 5015242 (shown)

Packard 12092162, pins 12064971



CHART 4 - EC-60™ CONTROLLER COMPONENT CONNECTORS

Troubleshooting: Wiring (Continued)

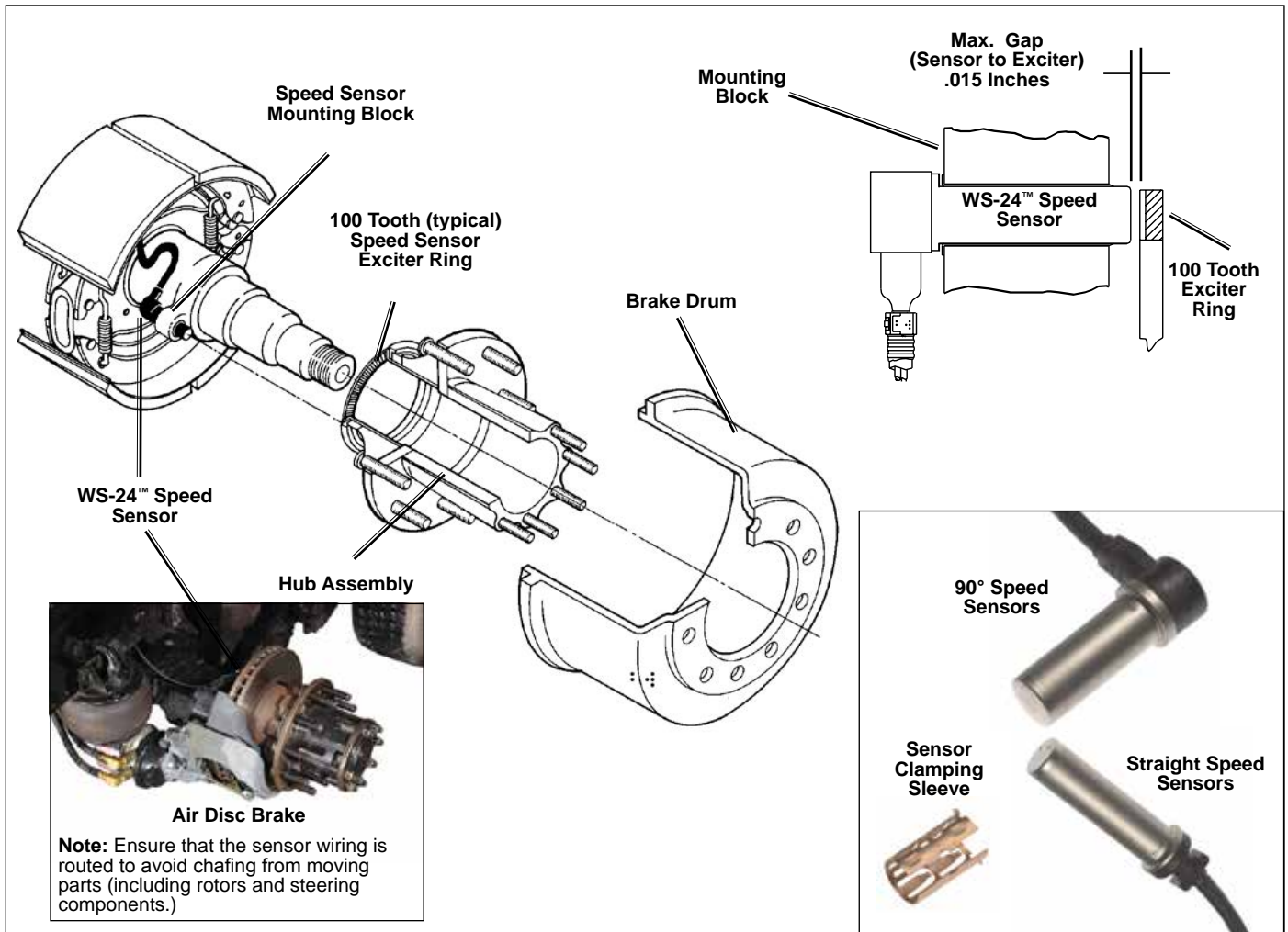

FIGURE 19 - WS-24™ WHEEL SPEED SENSOR INSTALLATION (S-CAM AND AIR DISC BRAKE)

Wheel Speed Sensor Wiring

Route sensor wiring coming out of the wheel ends away from moving brake components. Sensor wiring needs to be secured to the axle to prevent excess cable length and wiring damage. It is required that cable ties be installed to the sensor wire within 3 inches (76.2 mm) of the sensor head to provide strain relief.

Following the axle, the sensor wires must be attached along the length of the service brake hoses using cable ties with ultraviolet protection and secured every 6 to 8 inches (152 to 203 mm). Sufficient – but not excessive – cable length must be provided to permit full suspension travel and steering axle movement. Install wires so that they cannot touch rotating elements such as wheels, brake discs or drive shafts. Radiation protection may be necessary in the area of brake discs.

Bendix does not recommend using standard tie-wraps to secure wiring harnesses directly to rubber air lines. This may cause premature wiring failure from the pressure exerted on the wiring when air pressure is applied through the air line. Non-metallic hose clamps or bow-tie tie-wraps are preferred.

The use of grommets or other suitable protection is required whenever the cable must pass through metallic frame members.

All sensor wiring must utilize twisted pair wire, with approximately one to two twists per inch.

It is recommended that wires be routed straight out of a connector for a minimum of three inches before the wire is allowed to bend.

Troubleshooting: Wiring Schematic

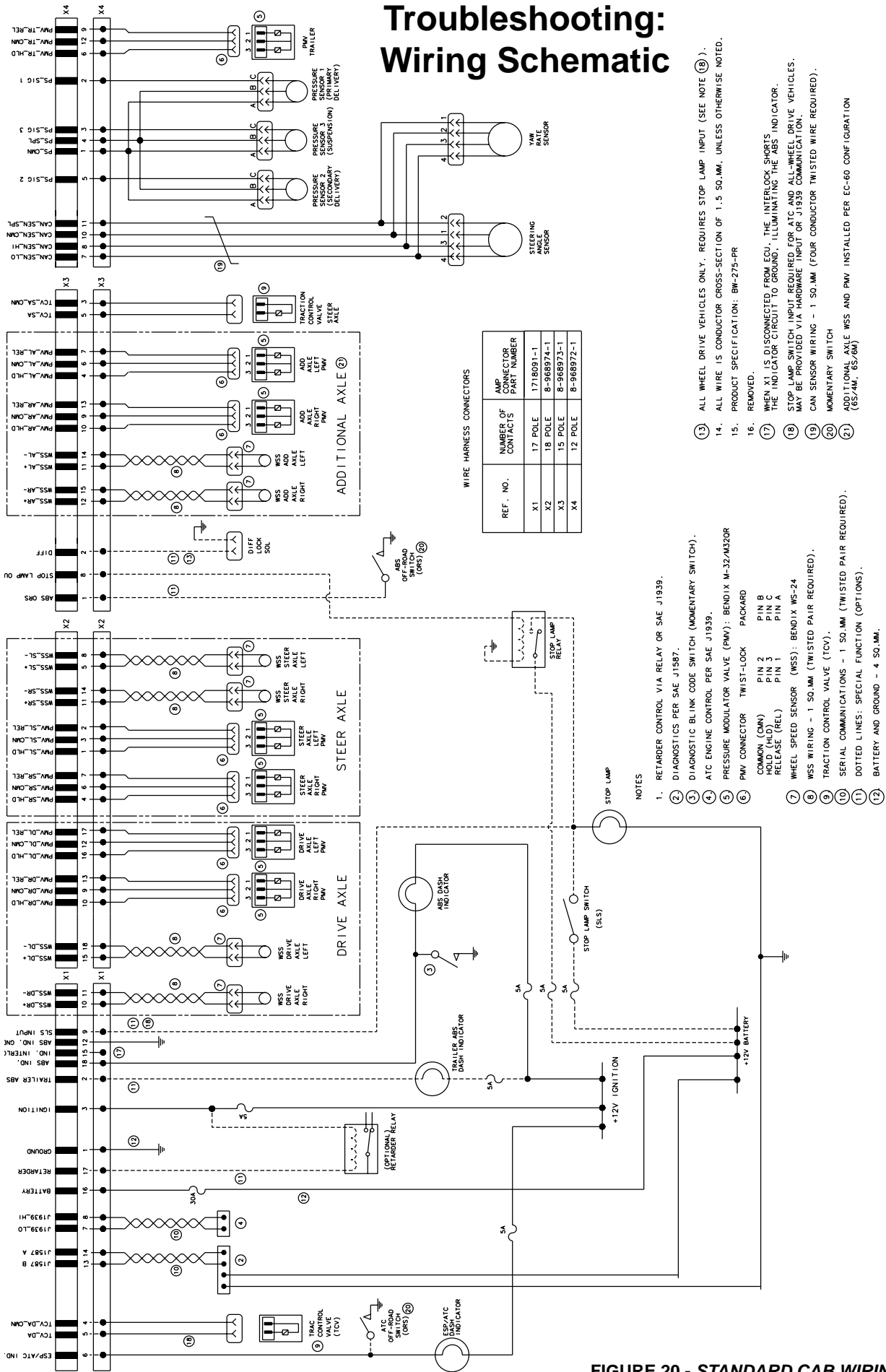

FIGURE 20 - STANDARD CAB WIRING SCHEMATIC

Glossary

ABS — Antilock Brake System.

ABS Event — Impending wheel lock situation that causes the ABS controller to activate the modulator valve(s).

ABS Indicator Lamp — An amber lamp which indicates the operating status of an antilock system. When the indicator lamp is on, ABS is disabled and the vehicle reverts to normal brake operation.

Air Gap — Distance between the Sensor and tone ring.

ASR — Automatic Slip Regulation. Another name for traction control.

ATC — Automatic Traction Control. An additional ABS function in which engine torque is controlled and brakes are applied differentially to enhance vehicle traction.

ATC/ESP Lamp — A lamp that indicates when stability functions, including traction control, roll stability program or yaw control are operating.

Channel — A controlled wheel site.

CAN — Controller Area Network. J1939 is an SAE version of the CAN link.

Clear Codes — System to erase historical diagnostic trouble codes from the ECU, from either the Diagnostic Switch or from a hand-held diagnostic tool (only repaired diagnostic trouble codes may be cleared).

Configuration — The primary objective is to identify a “normal” set of sensors and modulators for the Electronic Control Unit, so that it will identify future missing sensors and modulators.

Diagnostic Connector — Diagnostic receptacle in vehicle cab for connection of J1587 hand-held or PC based test equipment. The tester can initiate test sequences, and can also read system parameters.

Diagnostic Switch — A switch used to activate blinks codes.

Differential Braking — Application of brake force to a spinning wheel so that torque can be applied to wheels which are not slipping.

ECU — Electronic Control Unit.

ESP — Electronic Stability Program. Full stability function that includes RSP & YC subfunctions.

Diagnostic Trouble Code — A condition that interferes with the generation or transmission of response or control signals in the vehicle's ABS system that could lead to the functionality of the ABS system becoming inoperable in whole or in part.

FMVSS-121 — Federal Motor Vehicle Safety Standard which regulates air brake systems.

HSA — Hill Start Assist. HSA interfaces between the transmission and braking system to help the driver prevent the vehicle from rolling downhill when moving up a steep incline from a stationary position.

IR — Independent Regulation. A control method in which a wheel is controlled at optimum slip, a point where retardation and stability are maximized. The brake pressure that is best for the wheel in question is directed individually into each brake chamber.

J1587 — The SAE heavy duty standard diagnostic data link.

J1708 — An SAE standard which defines the hardware and software protocol for implementing 9600 baud heavy vehicle data links. J1587 version of a J1708 data link.

J1939 — A high speed data link used for communications between the ABS ECU engine, transmission and retarders.

LAS — Lateral Acceleration Sensor.

MIR — Modified Independent Regulation. A method of controlling the opposite sides of a steer axle during ABS operation so that torque steer and stopping distance are minimized.

PLC — Power Line Carrier. The serial communication protocol used to communicate with the trailer over the blue full time power wire.

PMV — Pressure Modulator Valve. An air valve which is used to vent or block air to the brake chambers to limit or reduce brake torque.

QR — Quick Release. Quick release valves allow faster release of air from the brake chamber after a brake application. To balance the system, quick release valves have hold off springs that produce higher crack pressures (when the valves open).

Relay Valve — Increases the application speed of the service brake. Installed near brakes with larger air chambers (type 24 or 30). The treadle valve activates the relay valve with an air signal. The relay valve then connects its supply port to its delivery ports. Equal length air hose must connect the delivery ports of the relay valve to the brake chambers.

Retarder Relay — A relay which is used to disable a retarder when ABS is triggered.

RSP — Roll Stability Program. An all-axle ABS solution that helps reduce vehicle speed by applying all vehicle brakes as needed, reducing the tendency to roll over.

SAS — Steering Angle Sensor.

Sensor Clamping Sleeve — A beryllium copper sleeve which has fingers cut into it. It is pressed between an ABS sensor and mounting hole to hold the sensor in place.

Stored Diagnostic Trouble Codes — A diagnostic trouble code that occurred.

TCS — Traction Control System, another name for ATC or ASR.

Tone Ring — A ring that is usually pressed into a wheel hub that has a series of teeth (usually 100) and provides actuation for the speed sensor. Note maximum run out is .008.

YC — Yaw Control. Helps stabilize rotational dynamics of vehicle.

YRS — Yaw Rate Sensor.

APPENDIX A: Troubleshooting a 12-7 Blink Code fault (SID-93 FMI-4) (SPN-0802 FMI-04)

Advanced In-Cab ECU

- 1) Remove X1, X2, X3 and X4 connector from the ECU.
- 2) Using X1-1 as the ground connection, check for resistance for the entire X2 connector. There should be no resistance to ground found. Please fill out attached worksheet.
- 3) Using X1-1 as the ground connection, check for resistance for X1-4 and X1-5. There should be no resistance to ground.
- 4) Using X1-1 as the ground connection, check for resistance for X3-4, X3-6, X3-7, X3-9, X3-10, X3-13, X3-3 and X3-5. There should be no resistance to ground. (Even if the vehicle is not configured for 6S/6M).
- 5) Using X1-1 as the ground connection, check for resistance for X4-6, X4-9 and X4-12. There should be no resistance to ground.
- 6) Troubleshoot any pin that has resistance to ground. If no issues are found continue to step 7.
- 7) Reconnect the X1 connector only and apply IGN power to the ECU and using the DTC screen of Bendix® ACom® Diagnostics, clear all DTCs. Re-check for any DTCs. If the 12-7 DTC is still present, the problem is the Traction Solenoid Wiring or Solenoid.
- 8) If the 12-7 DTC does not reappear, remove power and connect the X2 connector, reapply power, then clear all DTCs. If the 12-7 DTC is no longer present, connect the X3 connector and clear all DTCs.
- 9) If at this point the 12-7 DTC is not present, the problem is with the X4 connector.

For Peterbilt® & Kenworth® Trucks Only:	
10)	Clear all DTCs. If the 12-7 DTC reappears, the issue is on the X4 connector. Otherwise, proceed to the next step.
11)	Disconnect all modulators and the traction solenoid. Clear all DTCs. If the DTC does not reappear, connect one modulator and Traction Solenoid at a time, until the DTC reappears. Otherwise, continue to the next step.
12)	Make sure all modulators and the traction solenoid are connected. Disconnect the ABS bulkhead connector at the engine (top-left side) and remove Pins 1, 2, 11 & 12. Reconnect the connector and apply IGN power to the ECU. Using Bendix ACom Diagnostics, clear all DTCs. If the 12-7 DTC returns, the problem is either the wiring harness inside the cab or the ECU.

Record Resistances

Below:

X1-1 for ground point

X1 Pin	Resistance
X1-4	
X1-5	

X2 Pin	Resistance
X2-1	
X2-2	
X2-3	
X2-4	
X2-5	
X2-6	
X2-7	
X2-8	
X2-9	
X2-10	
X2-11	
X2-12	
X2-13	
X2-14	
X2-15	
X2-16	
X2-17	
X2-18	

X3 Pin	Resistance
X3-4	
X3-5	
X3-6	
X3-7	
X3-8	
X3-9	
X3-10	
X3-13	

X4 Pin	Resistance
X4-6	
X4-9	
X4-12	

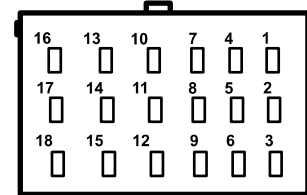

X 1

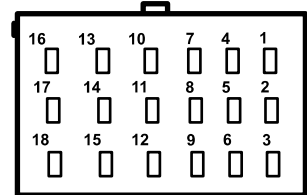

X 2

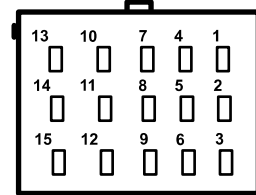

X 3

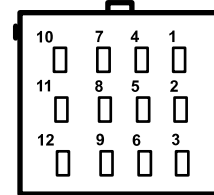

X 4

APPENDIX B: J1587 SID and FMI Codes and their Bendix Blink Code Equivalents					
SID (J1587)	SPN (J1939)	FMI (J1587/J1939)	Bendix Blink Code Equivalent(s)		Diagnostic Trouble Code Description
			(1st Digit)	(2nd Digit)	
-		-	1	1	No DTCs
Wheel Speed Sensor DTCs					
1	789	1	2	1	SA Left WSS Excessive Air Gap
1	789	2	2	3	SA Left WSS Open or Shorted
1	789	7	2	5	SA Left WSS Wheel End
1	789	8	2	6	SA Left WSS Erratic Sensor Signal
1	789	10	2	4	SA Left WSS Loss of Sensor Signal
1	789	13	2	7	SA Left WSS Tire Size Calibration
1	789	14	2	2	SA Left WSS Output Low @ Drive-Off
2	790	1	3	1	SA Right WSS Excessive Air Gap
2	790	2	3	3	SA Right WSS Open or Shorted
2	790	7	3	5	SA Right WSS Wheel End
2	790	8	3	6	SA Right WSS Erratic Sensor Signal
2	790	10	3	4	SA Right WSS Loss of Sensor Signal
2	790	13	3	7	SA Right WSS Tire Size Calibration
2	790	14	3	2	SA Right WSS Output Low @ Drive-Off
3	791	1	4	1	DA Left WSS Excessive Air Gap
3	791	2	4	3	DA Left WSS Open or Shorted
3	791	7	4	5	DA Left WSS Wheel End
3	791	8	4	6	DA Left WSS Erratic Sensor Signal
3	791	10	4	4	DA Left WSS Loss of Sensor Signal
3	791	13	4	7	DA Left WSS Tire Size Calibration
3	791	14	4	2	DA Left WSS Output Low @ Drive-Off
4	792	1	5	1	DA Right WSS Excessive Air Gap
4	792	2	5	3	DA Right WSS Open or Shorted
4	792	7	5	5	DA Right WSS Wheel End
4	792	8	5	6	DA Right WSS Erratic Sensor Signal
4	792	10	5	4	DA Right WSS Loss of Sensor Signal
4	792	13	5	7	DA Right WSS Tire Size Calibration
4	792	14	5	2	DA Right WSS Output Low @ Drive-Off
5	793	1	14	1	AA Left WSS Excessive Air Gap
5	793	2	14	3	AA Left WSS Open or Shorted
5	793	7	14	5	AA Left WSS Wheel End
5	793	8	14	6	AA Left WSS Erratic Sensor Signal
5	793	10	14	4	AA Left WSS Loss of Sensor Signal
5	793	13	14	7	AA Left WSS Tire Size Calibration
5	793	13	14	10	AA Left WSS Configuration Error
5	793	14	14	2	AA Left WSS Output Low @ Drive-Off
6	794	1	15	1	AA Right WSS Excessive Air Gap
6	794	2	15	3	AA Right WSS Open or Shorted
6	794	7	15	5	AA Right WSS Wheel End
6	794	8	15	6	AA Right WSS Erratic Sensor Signal
6	794	10	15	4	AA Right WSS Loss of Sensor Signal
6	794	13	15	7	AA Right WSS Tire Size Calibration
6	794	13	15	10	AA Right WSS Configuration Error
6	794	14	15	2	AA Right WSS Output Low @ Drive-Off
Pressure Modulator Valve DTCs					
7	795	5	7	7	SA Left PMV CMN Open Circuit
7	795	13	7	8	SA Left PMV Configuration Error
8	796	5	8	7	SA Right PMV CMN Open Circuit
8	796	13	8	8	SA Right PMV Configuration Error
9	797	5	9	7	DA Left PMV CMN Open Circuit
9	797	13	9	8	DA Left PMV Configuration Error
10	798	5	10	7	DA Right PMV CMN Open Circuit
10	798	13	10	8	DA Right PMV Configuration Error
11	799	5	16	7	AA Left PMV CMN Open Circuit
11	799	13	16	8	AA Left PMV Configuration Error
12	800	5	17	7	AA Right PMV CMN Open Circuit
12	800	13	17	8	AA Right PMV Configuration Error

APPENDIX B: J1587 SID and FMI Codes and their Bendix Blink Code Equivalents

SID (J1587)	SPN (J1939)	FMI (J1587/ J1939)	Bendix Blink Code Equivalent(s)		Diagnostic Trouble Code Description
			(1st Digit)	(2nd Digit)	
Miscellaneous DTCs					
13	801	2	12	4	Retarder Relay or HSA Lamp Open Circuit or Shorted to Ground
13	801	3	12	5	Retarder Relay Circuit or HSA Lamp Shorted to Voltage Dynamometer Test Mode
17	576	14	12	3	
17	614	14	12	9	ATC Disabled to Prevent Brake Fade
TCV DTCs					
18	806	3	18	2	TCV DA Solenoid Shorted to Voltage
18	806	4	18	1	TCV DA Solenoid Shorted to Ground
18	806	5	18	3	TCV DA Solenoid Open Circuit
18	806	13	18	4	TCV DA Configuration Error
19	807	3	19	3	TCV SA Solenoid Shorted to Voltage
19	807	4	19	1	TCV SA Solenoid Shorted to Ground
19	807	5	19	2	TCV SA Solenoid Open Circuit
19	807	13	19	4	TCV SA Configuration Error
Miscellaneous DTCs					
22	810	7	12	11	Wheel Speed Sensors Reversed on an Axle
23	811	2	12	6	ABS Dash Indicator Circuit DTC
Pressure Modulator Valve DTCs					
42	795	3	7	5	SA Left PMV HLD Solenoid Shorted to Voltage
42	795	4	7	4	SA Left PMV HLD Solenoid Shorted to Ground
42	795	5	7	6	SA Left PMV HLD Solenoid Open Circuit
43	796	3	8	5	SA Right PMV HLD Solenoid Shorted to Voltage
43	796	4	8	4	SA Right PMV HLD Solenoid Shorted to Ground
43	796	5	8	6	SA Right PMV HLD Solenoid Open Circuit
44	797	3	9	5	DA Left PMV HLD Solenoid Shorted to Voltage
44	797	4	9	4	DA Left PMV HLD Solenoid Shorted to Ground
44	797	5	9	6	DA Left PMV HLD Solenoid Open Circuit
45	798	3	10	5	DA Right PMV HLD Solenoid Shorted to Voltage
45	798	4	10	4	DA Right PMV HLD Solenoid Shorted to Ground
45	798	5	10	6	DA Right PMV HLD Solenoid Open Circuit
46	799	3	16	5	AA Left PMV HLD Solenoid Shorted to Voltage
46	799	4	16	4	AA Left PMV HLD Solenoid Shorted to Ground
46	799	5	16	6	AA Left PMV HLD Solenoid Open Circuit
47	800	3	17	5	AA Right PMV HLD Solenoid Shorted to Voltage
47	800	4	17	4	AA Right PMV HLD Solenoid Shorted to Ground
47	800	5	17	6	AA Right PMV HLD Solenoid Open Circuit
48	800	3	7	2	SA Left PMV REL Solenoid Shorted to Voltage
48	795	4	7	1	SA Left PMV REL Solenoid Shorted to Ground
48	795	5	7	3	SA Left PMV REL Solenoid Open Circuit
49	795	3	8	2	SA Right PMV REL Solenoid Shorted to Voltage
49	796	4	8	1	SA Right PMV REL Solenoid Shorted to Ground
49	796	5	8	3	SA Right PMV REL Solenoid Open Circuit
50	796	3	9	2	DA Left PMV REL Solenoid Shorted to Voltage
50	797	4	9	1	DA Left PMV REL Solenoid Shorted to Ground
50	797	5	9	3	DA Left PMV REL Solenoid Open Circuit
51	797	3	10	2	DA Right PMV REL Solenoid Shorted to Voltage
51	798	4	10	1	DA Right PMV REL Solenoid Shorted to Ground
51	798	5	10	3	DA Right PMV REL Solenoid Open Circuit
52	798	3	16	2	AA Left PMV REL Solenoid Shorted to Voltage
52	799	4	16	1	AA Left PMV REL Solenoid Shorted to Ground
52	799	5	16	3	AA Left PMV REL Solenoid Open Circuit
53	799	3	17	2	AA Right PMV REL Solenoid Shorted to Voltage
53	800	4	17	1	AA Right PMV REL Solenoid Shorted to Ground
53	800	5	17	3	AA Right PMV REL Solenoid Open Circuit

For more Pressure Modulator Valve DTCs - see SIDs 66 and 93 below...

APPENDIX B: J1587 SID and FMI Codes and their Bendix Blink Code Equivalents					
SID (J1587)	SPN (J1939)	FMI (J1587/ J1939)	Bendix Blink Code Equivalent(s)		Diagnostic Trouble Code Description
			(1st Digit)	(2nd Digit)	
Miscellaneous DTCs					
55	1045	2	12	2	Stop Lamp Switch Defective
55	1045	4	12	27	Brake Lamp Input Mismatch with Brake Lamp Output
55	1045	7	12	1	Stop Lamp Switch Not Detected
Pressure Modulator Valve DTCs					
66	1056	3	20	2	Trailer PMV REL Solenoid Shorted to Voltage
66	1056	3	20	5	Trailer PMV HLD Solenoid Shorted to Voltage
66	1056	4	20	1	Trailer PMV REL Solenoid Shorted to Ground
66	1056	4	20	4	Trailer PMV HLD Solenoid Shorted to Ground
66	1056	5	20	3	Trailer PMV REL Solenoid Open Circuit
66	1056	5	20	6	Trailer PMV HLD Solenoid Open Circuit
66	1056	5	20	7	Trailer PMV CMN Open Circuit
66	1056	7	20	8	PMV Configuration Error
<i>For more Pressure Modulator Valve DTCs - see SID 93 below...</i>					
Brake Demand/Load Sensor DTCs					
69	1059	2	24	3	Open or Shorted Load Sensor
77	1067	2	24	1	Shorted Brake Demand Sensor (Primary CKT) Open
77	1067	2	24	5	PS Supply Voltage Error
77	1067	7	24	6	PS Not Calibrated
77	1067	11	24	4	Plausibility Error Brake Demand Sensor
78	1068	2	24	2	Shorted Brake Demand Sensor (Secondary CKT) Open
Miscellaneous DTCs					
79	1069	13	12	10	Tire Size Out of Range (Front to Rear)
Steering Angle Sensor DTCs					
89	1807	2	21	3	SAS Static Signal
89	1807	2	21	4	SAS Signal Out of Range
89	1807	2	21	5	SAS Signal Reversed
89	1807	2	21	7	SAS Gradient Error
89	1807	2	21	9	SAS Long Term Calibration Error
89	1807	2	21	10	SAS Plausibility Check (Ref Yaw Rate)
89	1807	9	21	8	SAS CAN Timeout
89	1807	12	21	6	SAS Invalid Signal
89	1807	13	21	1	SAS Not Calibrated
89	1807	13	21	2	Steering Angle Sensor Calibration Not Finished
89	1808	13	22	15	YRS Sign Check Not Finished
Pressure Modulator Valve DTCs					
93	802	3	12	8	PMV Common Shorted to Voltage
93	802	4	12	7	PMV Common Shorted to Ground
HSA DTCs					
94	2622	2	12	4	HSA lamp shorted to ground or broken wire
94	2622	3	12	5	HSA lamp shorted to Voltage
94	2622	3	12	24	HSA solenoid shorted to Voltage (total shutdown)
94	2622	3	12	26	HSA solenoid shorted to Voltage (ATC & ESP shutdown)
94	2622	5	12	25	HSA solenoid shorted to ground or broken wire
94	2622	13	12	24	HSA solenoid shorted to Voltage
Lateral Acceleration Sensor DTCs					
99	1809	2	23	1	LAS Signal Out of Range
99	1809	2	23	3	LAS Static Calibration Error
99	1809	2	23	4	LAS Long Term Calibration Error
99	1809	2	23	5	LAS Plausibility Error (Inside ECU-Specific Limits)
99	1809	2	23	6	LAS Plausibility Error (Outside ECU-Specific Limits)
99	1809	13	23	2	LAS Calibration in Progress
99	1808	14	23	7	Erratic ESP Sensor Signal

APPENDIX B: J1587 SID and FMI Codes and their Bendix Blink Code Equivalents

SID (J1587)	SPN (J1939)	FMI (J1587/ J1939)	Bendix Blink Code Equivalent(s)		Diagnostic Trouble Code Description
			(1st Digit)	(2nd Digit)	
Miscellaneous DTCs					
102	564	3	12	13	HSA Solenoid Shorted to Voltage (high)
102	564	5	12	12	HSA Solenoid Shorted to Ground (Low) or Open circuit
103	1808	2	12	14	Sensor CAN Supply Voltage Error
103	1808	2	12	22	ESP Sensor Voltage Out of Range
Yaw Rate Sensor DTCs					
103	1808	2	22	1	YRS Signal Out of Range
103	1808	2	22	2	YRS Sensor Reversed Signal
103	1808	2	22	3	YRS Invalid Signal
103	1808	2	22	4	YRS Gradient Error
103	1808	2	22	6	YRS Static BITE Error
103	1808	2	22	7	YRS Dynamic BITE Error
103	1808	2	22	8	YRS Fast Calibration Error
103	1808	2	22	9	YRS Static Calibration Error
103	1808	2	22	10	YRS Normal Calibration Error
103	1808	2	22	11	YRS Sensitivity Calibration Error
103	1808	2	22	12	YRS Plausibility Check (Ref Yaw Rate)
103	1808	2	22	13	YRS Plausibility Error (Inside ECU-Specific Limits)
103	1808	2	22	14	YRS Plausibility Error (Outside ECU-Specific Limits)
103	1808	2	22	16	Yaw Rate Sensor Vibration Detected
103	1808	9	22	5	YRS CAN Timeout
Miscellaneous					
151	611	14	12	18	wheel speed sensor failure in previous power on cycle
154	614	3	12	23	i/o 2 or i/o 3 Shorted to Voltage
J1939 DTCs					
231	639	2	11	3	J1939 Engine Communications
231	639	2	11	4	J1939 Invalid Data (Engine/Retarder)
231	639	2	11	5	J1939 Supply Pressure
231	639	2	11	6	J1939 ESP Messages Invalid Data
231	639	2	11	7	Timeout or invalid data on ETC7/VP15 (for HSA-function)
231	639	2	11	8	timeout or invalid data on XBR
231	639	2	11	10	Invalid Data From Transmisson
231	639	2	11	12	J1939 HSA switch error or unavailable
231	639	2	11	13	timeout or invalid data for ESP AWD operation
231	639	12	11	1	J1939 Serial Link
231	639	14	11	2	J1939 Retarder
Power Supply DTCs					
251	627	2	6	8	Input Voltage Excessive Noise (Temp.)
251	627	3	6	2	Battery Voltage Too High
251	627	3	6	6	Ignition Voltage Too High
251	627	4	6	1	Battery Voltage Too Low
251	627	4	6	3	Battery Voltage Too Low During ABS
251	627	4	6	5	Ignition Voltage Too Low
251	627	4	6	7	Ignition Voltage Too Low During ABS
251	627	5	6	4	Battery Voltage Input Open Circuit
251	627	14	6	9	Input Voltage Excessive Noise (Latched)

APPENDIX B: J1587 SID and FMI Codes and their Bendix Blink Code Equivalents

SID (J1587)	SPN (J1939)	FMI (J1587/ J1939)	Bendix Blink Code Equivalent(s)		Diagnostic Trouble Code Description
			(1st Digit)	(2nd Digit)	
ECU DTCs					
253	630	12	13	19	ECU (1C)
253	630	12	13	20	ECU (27)
253	630	13	13	21	ECU (1D)
253	630	13	13	22	ECU (1E)
253	630	13	13	23	ECU (28)
254	629	2	13	4	ECU (12)
254	629	2	13	5	ECU (13)
254	629	2	13	7	ECU (15)
254	629	2	13	17	ECU (0D)
254	629	2	13	18	Invalid ESP Configuration
254	629	12	13	1	ECU (02)
254	629	12	13	2	ECU (10)
254	629	12	13	3	ECU (11)
254	629	12	13	6	ECU (14)
254	629	12	13	10	ECU (18)
254	629	12	13	11	ECU (1A)
254	629	12	13	12	ECU (1B)
254	629	12	13	13	ECU (80)
254	629	12	13	14	ECU (04)
254	629	12	13	15	ECU (06)
254	629	12	13	16	ECU (0E)
254	629	12	13	24	ECU (37)
254	629	12	13	25	ECU Internal VIN Mismatch
254	629	13	13	8	Invalid ABS Configuration
254	630	13	13	9	ECU (17)

APPENDIX C: UDS Codes and their Bendix Blink Code Equivalents

UDS Code	US-Spec. Blink Code	J1587 PID194 (SID/FMI)	J1939/73 DM1/2 SPN/FMI	DTC Description	Lamp Status	
					ABS	ATC/ESP
0	01-01	000-00	---	no DTC	-	-
1	14-03	005-02	0793-02	AA Left WSS Open or Shorted	ON	ON
3	14-10	005-13	0793-13	AA Left WSS Configuration Error	ON	ON
4	13-14	254-12	0629-12	ECU (04)	ON	ON
5	14-05	005-07	0793-07	AA Left WSS Wheel End	ON	ON
6	13-15	254-12	0629-12	ECU (06)	ON	ON
7	14-01	005-01	0793-01	AA Left WSS Excessive Air Gap	ON	ON
8	14-02	005-14	0793-14	AA Left WSS Output Low @ Drive-Off	ON	ON
9	14-06	005-08	0793-08	AA Left WSS Erratic Sensor Signal	ON	ON
10	14-04	005-10	0793-10	AA Left WSS Loss of Sensor Signal	ON	ON
13	13-17	254-02	0629-02	ECU (0D)	ON	ON
14	13-16	254-12	0629-12	ECU (0E)	ON	ON
15	12-14	103-02	1808-02	Sensor CAN Supply Voltage Error	-	ON
16	13-02	254-12	0629-12	ECU (10)	ON	ON
17	13-03	254-12	0629-12	ECU (11)	ON	ON
18	13-04	254-02	0629-02	ECU (12)	ON	ON
19	13-05	254-02	0629-02	ECU (13)	ON	ON
20	13-06	254-12	0629-12	ECU (14)	ON	ON
21	13-07	254-02	0629-02	ECU (15)	ON	ON
22	13-08	254-13	0630-13	ECU (16)	ON	ON
23	13-09	254-13	0630-13	ECU (17)	ON	ON
24	13-10	254-12	0630-12	ECU (18)	ON	ON
25	13-18	254-02	0629-02	ECU (19)	ON	ON
26	13-11	254-12	0802-12	ECU (1A)	ON	ON
27	13-12	254-12	0802-12	ECU (1B)	ON	-
28	13-19	253-12	0630-12	ECU (1C)	-	-
29	13-21	253-13	0630-13	ECU (1D)	ON	ON
30	13-22	253-13	0630-13	ECU (1E)	ON	ON
32	06-06	251-03	0627-03	Ignition Voltage Too High	ON	ON
33	06-05	251-04	0627-04	Ignition Voltage Too Low	ON	ON
34	06-07	251-04	0627-04	Ignition Voltage Too Low During ABS	ON	ON
35	06-02	251-03	0627-03	Battery Voltage Too High	ON	ON
36	06-01	251-04	0627-04	Battery Voltage Too Low	ON	ON
37	06-03	251-04	0627-04	Battery Voltage Too Low During ABS	ON	ON
38	06-04	251-05	0627-05	Battery Voltage Input Open Circuit	ON	ON
39	13-20	253-12	0630-12	ECU (27)	ON	ON
40	13-23	253-13	0630-13	ECU (28)	ON	ON
41	12-08	093-03	0802-03	PMV Common Shorted to Voltage	ON	ON
42	12-07	093-04	0802-04	PMV Common Shorted to Ground	ON	ON
43	11-07	231-02	0639-02	Timeout or invalid CAN data for ETC7/VP15	-	-
44	11-04	231-02	0639-02	J1939 Invalid Data (Engine/Retarder)	-	ON
45	11-05	231-02	0639-02	J1939 Supply Pressure	-	ON
46	11-08	231-02	0639-02	Timeout or invalid CAN data - XBR	-	-

APPENDIX C: UDS Codes and their Bendix Blink Code Equivalents

UDS Code	US-Spec. Blink Code	J1587 PID194 (SID/FMI)	J1939/73 DM1/2 SPN/FMI	DTC Description	Lamp Status	
					ABS	ATC/ESP
48	12-05	013-03	0801-03	Retarder Relay Circuit Shorted to Voltage	ON	-
48	12-05	094-03	2622-03	Retarder Relay Circuit or Hill Start Assist Lamp Shorted to Voltage	ON	-
49	12-04	013-02	0801-02	Retarder Relay Open Circuit or Shorted to Ground	ON	-
49	12-04	094-02	2622-02	Retarder Relay Circuit or Hill Start Assist Lamp open or Shorted to Ground	ON	-
50	19-02	019-05	0807-05	TCV SA Solenoid Open Circuit	ON	ON
51	11-01	231-12	0639-12	J1939 Serial Link	ON	ON
52	11-02	231-14	0639-14	J1939 Retarder	ON	ON
53	11-03	231-02	0639-02	J1939 Engine Communications	-	ON
54	11-10	231-02	0639-02	Invalid Data from Transmission	ON	-
55	13-24	254-12	0629-12	ECU (37)	-	ON
56	19-01	019-04	0807-04	TCV SA Solenoid Shorted to Ground	-	ON
57	19-03	019-03	0807-03	TCV SA Solenoid Shorted to Voltage	-	ON
58	18-03	018-05	0806-05	TCV DA Solenoid Open Circuit	-	ON
59	18-01	018-04	0806-04	TCV DA Solenoid Shorted to Ground	-	ON
60	18-02	018-03	0806-03	TCV DA Solenoid Shorted to Voltage	ON	ON
61	18-04	018-13	0806-13	TCV DA Configuration Error	ON	ON
62	19-04	019-13	0807-13	TCV SA Configuration Error	ON	ON
63	11-11	231-02	0639-02	Timeout or invalid CAN data - AUX I/O	-	-
64	24-03	069-02	1059-02	Open or Shorted Load Sensor	-	ON
65	02-03	001-02	0789-02	SA Left WSS Open or Shorted	ON	ON
66	24-01	077-02	1067-02	Shorted Brake Demand Sensor (Primary CKT) Open	-	ON
67	24-02	078-02	1068-02	Shorted Brake Demand Sensor (Secondary CKT) Open	-	ON
68	24-04	077-11	1067-11	Plausibility Error Brake Demand Sensor	-	ON
69	02-05	001-07	0789-07	SA Left WSS Wheel End	ON	ON
70	24-05	077-02	1067-02	PS Supply Voltage Error	-	ON
71	02-01	001-01	0789-01	SA Left WSS Excessive Air Gap	ON	ON
72	02-02	001-14	0789-14	SA Left WSS Output Low @ Drive-Off	ON	ON
73	02-06	001-08	0789-08	SA Left WSS Erratic Sensor Signal	ON	ON
74	02-04	001-10	0789-10	SA Left WSS Loss of Sensor Signal	ON	ON
77	23-02	099-13	1809-13	LAS Calibration in Progress	-	ON
78	23-07	099-14	1808-14	Erratic ESP Sensor Signal	-	ON
79	21-02	089-13	1807-13	SAS Calibration in Progress	-	ON
80	21-01	089-13	1807-13	SAS Not Calibrated	-	ON
81	07-06	042-05	0795-05	SA Left PMV HLD Solenoid Open Circuit	ON	ON
82	07-04	042-04	0795-04	SA Left PMV HLD Solenoid Shorted to Ground	ON	ON
83	07-05	042-03	0795-03	SA Left PMV HLD Solenoid Shorted to Voltage	ON	ON
84	07-07	007-05	0795-05	SA Left PMV CMN Open Circuit	ON	ON
85	07-03	048-05	0795-05	SA Left PMV REL Solenoid Open Circuit	ON	ON
86	07-01	048-04	0795-04	SA Left PMV REL Solenoid Shorted to Ground	ON	ON
87	07-02	048-03	0795-03	SA Left PMV REL Solenoid Shorted to Voltage	ON	ON
88	21-08	089-09	1807-09	SAS CAN Timeout	-	ON
89	21-04	089-02	1807-02	SAS Signal Out of Range	-	ON
90	21-06	089-12	1807-12	SAS Invalid Signal	-	ON

APPENDIX C: UDS Codes and their Bendix Blink Code Equivalents

UDS Code	US-Spec. Blink Code	J1587 PID194 (SID/FMI)	J1939/73 DM1/2 SPN/FMI	DTC Description	Lamp Status	
					ABS	ATC/ESP
91	21-07	089-02	1807-02	SAS Gradient Error	-	ON
92	21-09	089-02	1807-02	SAS Long Term Calibration Error	-	ON
93	07-08	007-13	0795-13	SA Left PMV Configuration Error	ON	ON
94	21-03	089-02	1807-02	SAS Static Signal	-	ON
95	21-05	089-02	1807-02	SAS Signal Reversed	-	ON
96	21-10	089-02	1807-02	SAS Plausibility Check (Ref Yaw Rate)	-	ON
97	05-03	004-02	0792-02	DA Right WSS Open or Shorted	ON	ON
98	22-05	103-09	1808-09	YRS CAN Timeout	-	ON
99	22-01	103-02	1808-02	YRS Signal Out of Range	-	ON
100	22-03	103-02	1808-02	YRS Invalid Signal	-	ON
101	05-05	004-07	0792-07	DA Right WSS Wheel End	ON	ON
102	22-06	103-02	1808-02	YRS Static BITE Error	-	ON
103	05-01	004-01	0792-01	DA Right WSS Excessive Air Gap	ON	ON
104	05-02	004-14	0792-14	DA Right WSS Output Low @ Drive-Off	ON	ON
105	05-06	004-08	0792-08	DA Right WSS Erratic Sensor Signal	ON	ON
106	05-04	004-10	0792-10	DA Right WSS Loss of Sensor Signal	ON	ON
109	22-07	103-02	1808-02	YRS Dynamic BITE Error	-	ON
110	22-04	103-02	1808-02	YRS Gradient Error	-	ON
111	22-08	103-02	1808-02	YRS Fast Calibration Error	-	ON
112	22-09	103-02	1808-02	YRS Static Calibration Error	-	ON
113	10-06	045-05	0798-05	DA Right PMV HLD Solenoid Open Circuit	ON	ON
114	10-04	045-04	0798-04	DA Right PMV HLD Solenoid Shorted to Ground	ON	ON
115	10-05	045-03	0798-03	DA Right PMV HLD Solenoid Shorted to Voltage	ON	ON
116	10-07	010-05	0798-05	DA Right PMV CMN Open Circuit	ON	ON
117	10-03	051-05	0798-05	DA Right PMV REL Solenoid Open Circuit	ON	ON
118	10-01	051-04	0798-04	DA Right PMV REL Solenoid Shorted to Ground	ON	ON
119	10-02	051-03	0798-03	DA Right PMV REL Solenoid Shorted to Voltage	ON	ON
120	22-10	103-02	1808-02	YRS Normal Calibration Error	-	ON
121	22-11	103-02	1808-02	YRS Sensitivity Calibration Error	-	ON
122	22-12	103-02	1808-02	YRS Plausibility Check (Ref Yaw Rate)	-	ON
123	22-02	103-02	1808-02	YRS Sensor Reversed Signal	-	ON
124	22-13	103-02	1808-02	YRS Plausibility Error (Inside Model Based Limits)	-	ON
125	10-08	010-13	0798-13	DA Right PMV Configuration Error	ON	ON
126	22-14	103-02	1808-02	YRS Plausibility Error (Outside Model Based Limits)	-	ON
127	11-06	231-02	0639-02	J1939 ESP Messages Invalid Data	-	ON
128	13-13	254-12	0629-12	ECU (80)	ON	ON
129	03-03	002-02	0790-02	SA Right WSS Open or Shorted	ON	ON
130	06-08	251-02	0627-02	Input Voltage Excessive Noise (Temp.)	ON	ON
131	06-09	251-14	0627-14	Input Voltage Excessive Noise (Latched)	ON	ON
132	12-22	103-02	1808-02	ESP Sensor Voltage Out of Range	-	ON
133	03-05	002-07	0790-07	SA Right WSS Wheel End	ON	ON
134	24-06	077-07	1067-07	PS Not Calibrated	-	ON
135	03-01	002-01	0790-01	SA Right WSS Excessive Air Gap	ON	ON

APPENDIX C: UDS Codes and their Bendix Blink Code Equivalents

UDS Code	US-Spec. Blink Code	J1587 PID194 (SID/FMI)	J1939/73 DM1/2 SPN/FMI	DTC Description	Lamp Status	
					ABS	ATC/ESP
136	03-02	002-14	0790-14	SA Right WSS Output Low @ Drive-Off	ON	ON
137	03-06	002-08	0790-08	SA Right WSS Erratic Sensor Signal	ON	ON
138	03-04	002-10	0790-10	SA Right WSS Loss of Sensor Signal	ON	ON
141	13-25	254-12	0629-12	ECU Internal VIN Mismatch	-	ON
142	20-08	066-07	1056-07	Trailer PMV potentially miswired or internal mechanical problem	-	ON
143	22-15	089-13	1808-13	YRS Sign Check Not Finished	-	ON
144	12-23	154-03	0614-03	i/o 2 or i/o 3 shorted high or Stop Lamp Output Error	-	ON
145	08-06	043-05	0796-05	SA Right PMV HLD Solenoid Open Circuit	ON	ON
146	08-04	043-04	0796-04	SA Right PMV HLD Solenoid Shorted to Ground	ON	ON
147	08-05	043-03	0796-03	SA Right PMV HLD Solenoid Shorted to Voltage	ON	ON
148	08-07	008-05	0796-05	SA Right PMV CMN Open Circuit	ON	ON
149	08-03	049-05	0796-05	SA Right PMV REL Solenoid Open Circuit	ON	ON
150	08-01	049-04	0796-04	SA Right PMV REL Solenoid Shorted to Ground	ON	ON
151	08-02	049-03	0796-03	SA Right PMV REL Solenoid Shorted to Voltage	ON	ON
155	11-12	231-02	0639-02	J1939 HSA switch error or unavailable	-	-
156	12-24	094-03	2622-03	Hill Start Assist solenoid shorted to voltage	ON	ON
157	08-08	008-13	0796-13	SA Right PMV Configuration Error	ON	ON
158	12-25	094-05	2622-05	Hill Start Assist solenoid shorted to ground or open circuit	-	-
161	04-03	003-02	0791-02	DA Left WSS Open or Shorted	ON	ON
165	04-05	003-07	0791-07	DA Left WSS Wheel End	ON	ON
167	04-01	003-01	0791-01	DA Left WSS Excessive Air Gap	ON	ON
168	04-02	003-14	0791-14	DA Left WSS Output Low @ Drive-Off	ON	ON
169	04-06	003-08	0791-08	DA Left WSS Erratic Sensor Signal	ON	ON
170	04-04	003-10	0791-10	DA Left WSS Loss of Sensor Signal	ON	ON
174	22-16	103-02	1808-02	Yaw Rate Sensor Vibration Detected	-	ON
175	12-09	017-14	0614-14	ATC Disabled to Prevent Brake Fade	-	ON
177	09-06	044-05	0797-05	DA Left PMV HLD Solenoid Open Circuit	ON	ON
178	09-04	044-04	0797-04	DA Left PMV HLD Solenoid Shorted to Ground	ON	ON
179	09-05	044-03	0797-03	DA Left PMV HLD Solenoid Shorted to Voltage	ON	ON
180	09-07	009-05	0797-05	DA Left PMV CMN Open Circuit	ON	ON
181	09-03	050-05	0797-05	DA Left PMV REL Solenoid Open Circuit	ON	ON
182	09-01	050-04	0797-04	DA Left PMV REL Solenoid Shorted to Ground	ON	ON
183	09-02	050-03	0797-03	DA Left PMV REL Solenoid Shorted to Voltage	ON	ON
189	09-08	009-13	0797-13	DA Left PMV Configuration Error	ON	ON
192	20-06	066-05	1056-05	Trailer PMV HLD Solenoid Open Circuit	-	ON
193	15-03	006-02	0794-02	AA Right WSS Open or Shorted	ON	ON
194	20-04	066-04	1056-04	Trailer PMV HLD Solenoid Shorted to Ground	-	ON
195	15-10	006-13	0794-13	AA Right WSS Configuration Error	ON	ON
196	20-05	066-03	1056-03	Trailer PMV HLD Solenoid Shorted to Voltage	ON	ON
197	15-05	006-07	0794-07	AA Right WSS Wheel End	ON	ON
198	20-07	066-05	1056-05	Trailer PMV CMN Open Circuit	-	ON
199	15-01	006-01	0794-01	AA Right WSS Excessive Air Gap	ON	ON
200	15-02	006-14	0794-14	AA Right WSS Output Low @ Drive-Off	ON	ON

APPENDIX C: UDS Codes and their Bendix Blink Code Equivalents

UDS Code	US-Spec. Blink Code	J1587 PID194 (SID/FMI)	J1939/73 DM1/2 SPN/FMI	DTC Description	Lamp Status	
					ABS	ATC/ESP
201	15-06	006-08	0794-08	AA Right WSS Erratic Sensor Signal	ON	ON
202	15-04	006-10	0794-10	AA Right WSS Loss of Sensor Signal	ON	ON
205	20-03	066-05	1056-05	Trailer PMV REL Solenoid Open Circuit	-	ON
206	20-01	066-04	1056-04	Trailer PMV REL Solenoid Shorted to Ground	-	ON
207	20-02	066-03	1056-03	Trailer PMV REL Solenoid Shorted to Voltage	ON	ON
209	12-06	023-02	0811-02	ABS Indicator Lamp Circuit	ON	-
210	12-10	079-13	1069-13	Tire Size Out of Range (Front to Rear)	ON	ON
212	12-11	022-07	0810-07	Wheel Speed Sensors Reversed on an Axle	ON	ON
213	12-01	055-07	1045-07	Stop Lamp Switch Not Detected	-	ON
214	12-03	017-14	0576-14	ATC Disabled or Dynamometer Test Mode Active	-	ON
216	12-02	055-02	1045-02	Stop Lamp Switch Defective	ON	ON
220	12-13	102-03	0564-03	Diff Lock Solenoid Shorted to Voltage (total shutdown)	ON	ON
221	12-12	102-05	0564-05	Diff Lock Shorted to Ground or Open Circuit	ON	-
225	16-06	046-05	0799-05	AA Left PMV HLD Solenoid Open Circuit	ON	ON
226	16-04	046-04	0799-04	AA Left PMV HLD Solenoid Shorted to Ground	ON	ON
227	16-05	046-03	0799-03	AA Left PMV HLD Solenoid Shorted to Voltage	ON	ON
228	16-07	011-05	0799-05	AA Left PMV CMN Open Circuit	ON	ON
229	16-03	052-05	0799-05	AA Left PMV REL Solenoid Open Circuit	ON	ON
230	16-01	052-04	0799-04	AA Left PMV REL Solenoid Shorted to Ground	ON	ON
231	16-02	052-03	0799-03	AA Left PMV REL Solenoid Shorted to Voltage	ON	ON
232	11-13	231-02	0639-02	timeout or invalid data on J1939 AWD params for ESP AWD operation	-	ON
237	16-08	011-13	0799-13	AA Left PMV Configuration Error	ON	ON
238	13-26	155-14	0615-14	Maximum number of PCV cycles reached	-	-
239	13-27	155-14	0615-14	Maximum number of TCV cycles reached	-	-
240	23-01	099-02	1809-02	LAS Signal Out of Range	-	ON
241	17-06	047-05	0800-05	AA Right PMV HLD Solenoid Open Circuit	ON	ON
242	17-04	047-04	0800-04	AA Right PMV HLD Solenoid Shorted to Ground	ON	ON
243	17-05	047-03	0800-03	AA Right PMV HLD Solenoid Shorted to Voltage	ON	ON
244	17-07	012-05	0800-05	AA Right PMV CMN Open Circuit	ON	ON
245	17-03	053-05	0800-05	AA Right PMV REL Solenoid Open Circuit	ON	ON
246	17-01	053-04	0800-04	AA Right PMV REL Solenoid Shorted to Ground	ON	ON
247	17-02	053-03	0800-03	AA Right PMV REL Solenoid Shorted to Voltage	ON	ON
248	23-04	099-02	1809-02	LAS Long Term Calibration Error	-	ON
249	23-03	099-02	1809-02	LAS Static Calibration Error	-	ON
250	23-05	099-02	1809-02	LAS Plausibility Error (Inside Model Based Limits)	-	ON
251	23-06	099-02	1809-02	LAS Plausibility Error (Outside Model Based Limits)	-	ON
253	17-08	012-13	0800-13	AA Right PMV Configuration Error	ON	ON

Log-on and Learn from the Best
 On-line training that's available when you are –24/7/365.
 Visit www.brake-school.com.

