

CABIN AREA

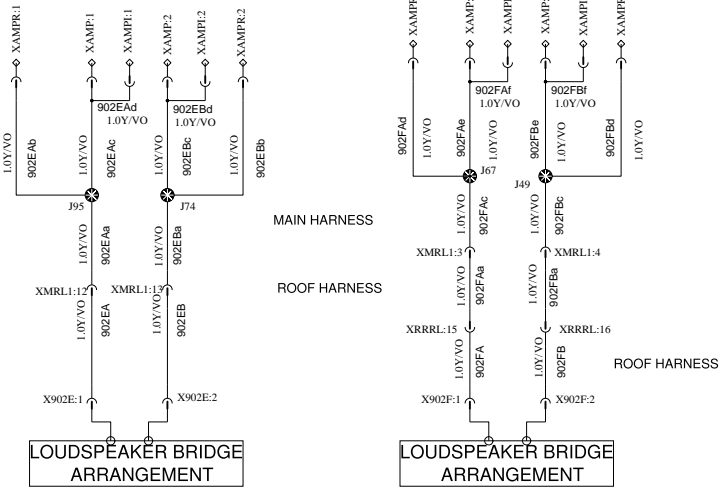

LOUDSPEAKER'S BRIDGES BY ENVIRONMENTAL SOUND

ARRANGEMENT TYPE 1

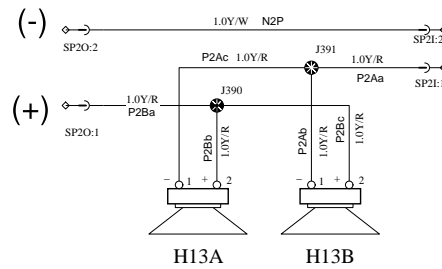

ARRANGEMENT TYPE 2

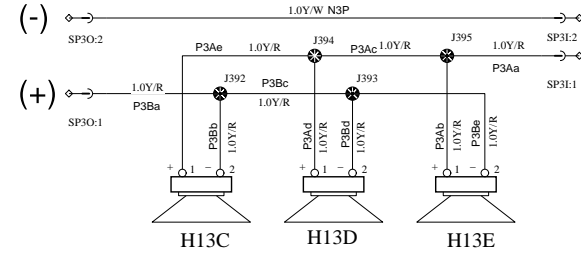

ARRANGEMENT TYPE 3

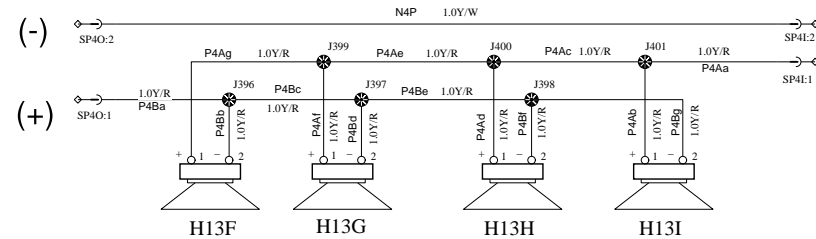

DRIVER'S SPEAKERS

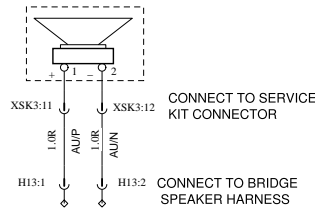
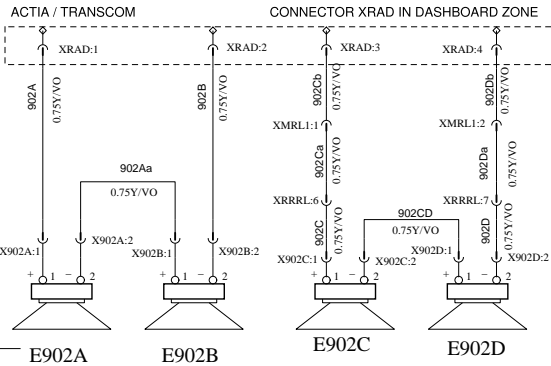
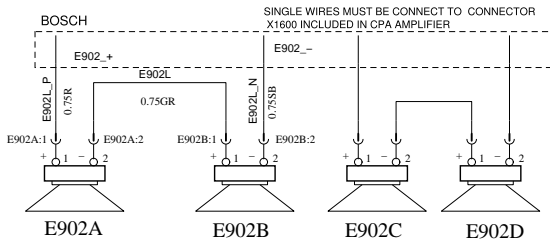

BRIDGE A

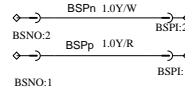

BRIDGE B (WCL & DL-110)



BRIDGE END JOINT

