

PREVOST[®]

COACH MANUFACTURER

OPERATOR'S MANUAL

X3-45 COACH

DOB Bus Number Series 2400-2489



July 2012

PA1592 July 2012

Featuring:

- EPA2010 regulations engine with selective catalytic reduction SCR system

First edition: October 2011

REVISION	DESCRIPTION
----------	-------------

July 2012	Introduction of 3-position ignition switch
-----------	--------------------------------------------

This PREVOST X3-45 coach **Operator's Manual** conforms to the new EPA 2010 regulations, featuring an engine with selective catalytic reduction SCR system. This manual has been prepared for the Metropolitan Transportation Authority (MTA) to thoroughly acquaint the driver, with the equipment and features of the coach in order to fully appreciate and safely enjoy this vehicle. Prevost is committed to the continuous improvement of coach quality, reliability, durability and safety. With innovative features, the X3 series coach was designed with passenger and driver safety and comfort in mind.

This manual contains information available at the time of publication.

Driver's controls and instruments incorporate advanced technology for enhanced driving ease and security. This manual describes the main features, instruments and controls, and servicing requirements for the equipment. Read this manual carefully to take advantage of the coach's advanced features and to ensure optimum safety and passenger comfort.

Keep this manual in the coach at all times. Make sure this manual is kept with the coach when ownership is transferred. Please use the appropriate card at the end of this manual to promptly notify Prevost of any change of address or transfer of ownership. This will ensure we provide fast and reliable coach service to all coach operators.

DANGER, WARNING, CAUTION and *NOTE*. are used throughout this manual to emphasize important points when necessary:



DANGER

Directs the operator's attention to unsafe practices which could result in serious personal injury or death.



WARNING

Directs the operator's attention to unsafe practices which could result in serious personal injury or severe damage to the vehicle.



CAUTION

Directs the operator's attention to unsafe practices where personal injury is not likely but damage to vehicle components could occur.

NOTE

Indicates supplementary information essential to the proper operation of the vehicle.

The service life of the coach depends on the kind of attention it receives. Pay close attention to the **DANGER, WARNING, CAUTION** and *NOTE*. Read the various notices and instructions posted throughout the coach and attached to equipment.

Since continuous improvement is a primary focus at Prevost, we reserve the right to make changes anytime, without notice, and without incurring any obligation.

Before reproducing or copying this manual, in whole or in part, written consent must be obtained from Prevost.

SAFETY PRECAUTIONS 1

COACH EXTERIOR..... 5

COACH INTERIOR 17

CONTROLS AND INSTRUMENTS 23

OTHER FEATURES 57

STARTING AND STOPPING PROCEDURE..... 83

SAFETY FEATURES AND EQUIPMENT..... 89

CARE AND MAINTENANCE..... 99

TECHNICAL INFORMATION 115

ABBREVIATIONS 123

APPENDIX A – SERVICE LITERATURE..... 125

APPENDIX B – TROUBLESHOOTING GUIDE FOR MULTIPLEX VEHICLES 129

APPENDIX C – ALLISON DIAGNOSTIC TROUBLESHOOTING CODES 135

INDEX 147

Safety Precautions 1

SAFE OPERATING PRACTICES	2
DEFENSIVE DRIVING PRACTICES.....	2
OTHER PRECAUTIONS	3

2 Safety Precautions

SAFE OPERATING PRACTICES

To ensure safe and reliable operation, heed the following safety precautions.

- Operation and maintenance of the vehicle must be performed only by qualified personnel.
- Before driving, conduct a walk around inspection and check that all baggage compartment doors and equipment access doors are securely shut.
- Make sure good visibility is maintained at all times. Keep windshields clean and free of obstructions.
- Adjust the driver's seat so that all controls can be reached easily.
- Always wear your safety belt when driving.
- Check the instrument panel frequently. Do not operate the vehicle when dials or indicators do not indicate normal operating conditions.
- Always pay attention to pedestrians passing in front and behind the vehicle. Always yield to pedestrians at pedestrian walkways.
- Do not drive over obstacles on the road. Empty boxes, piles of leaves, and snowdrifts could conceal hidden dangers that could damage the vehicle suspension and underbody.
- When turning or changing lanes, signal your intention well in advance.
- When approaching to make a right turn, reduce the space between the vehicle and the curb to make sure another vehicle cannot pass on the right. Since the vehicle makes wide turns, allow enough space to make safe turns.
- Switch from high beams to low beams when meeting or following other vehicles within 500 feet (150 meters).
- Never leave the vehicle unattended with the engine running or with the key in the ignition. Turn off the engine, remove keys and apply the parking brake before leaving the vehicle.
- Shut-off the engine before refueling, adding oil, performing maintenance or servicing tasks, unless stated otherwise.
- Fuel is highly flammable and explosive. Do not smoke when refueling. Keep away from open flames or sparks.

- Do not run the engine or HVAC system with access doors left open. Close compartment doors before operating any equipment.
- Do not remove the surge tank filler cap or the cooling system pressure cap when the engine is hot. Let the engine cool down before removing filler caps.
- Do not attempt to push or pull-start the vehicle.
- The service life of the vehicle depends on the kind of maintenance it receives. Always record any problems and report them immediately to maintenance personnel.

DEFENSIVE DRIVING PRACTICES

- For city driving, allow a four to six second travel interval between your vehicle and the vehicle ahead. Increase this travel interval to six to eight seconds for highway driving. Increase time interval for driving at night or in foul weather.
- Be prepared to stop when approaching an intersection. The stopping distance of the vehicle increases with the weight and speed.
- Establish eye-to-eye contact with other drivers and with pedestrians. Use, high beam and low beam headlights, turn signals and horn as needed.
- On highway, don't stare at the road ahead. Keep your eyes moving. Check mirrors and dashboard instruments frequently.
- To keep the vehicle from drifting across lanes during highway driving, always look over the horizon on the road ahead.
- Adjust your speed to road conditions, traffic and visibility. Never exceed the posted speed limits.
- If another vehicle is following close behind, reduce your speed to let the vehicle pass.
- For additional information about safe operation and defensive driving practices, contact the local department of motor vehicles authority.

OTHER PRECAUTIONS**WARNING**

This vehicle is not designed to carry standing passengers.

**DANGER**

Make sure that electrical current or air pressure is removed before performing any work. A part may be energized even if the ignition switch is OFF. A part may be under pressure even if all tanks are empty. Before performing any work on the vehicle, refer to wiring diagrams and/or air schematics to thoroughly understand the system.

**CAUTION**

Disconnect all electronic control modules before welding. If modules (MCM, ECM, TCM, ECU, ABS) are not disconnected before welding is done, there is a high risk of destroying the electronic components (EPROM, Chip). Refer to procedure described in Maintenance Manual.

ENGINE COMPARTMENT COMPONENTS..... 7

ENGINE COMPARTMENT..... 8

 ENGINE COMPARTMENT CURB-SIDE DOOR..... 8

 ENGINE COMPARTMENT REAR DOORS..... 8

EXHAUST AFTERTREATMENT SYSTEM ACCESS DOOR..... 9

ENGINE RADIATOR DOOR 9

CATALYTIC CONVERTER ACCESS DOOR 10

CONDENSER COMPARTMENT (A/C)..... 10

EVAPORATOR COMPARTMENT 11

COOLANT HEATER COMPARTMENT 11

FRONT ELECTRICAL AND SERVICE COMPARTMENT 12

BAGGAGE COMPARTMENTS..... 12

FUEL AND DIESEL EXHAUST FLUID (DEF) FILLER DOOR..... 13

BI-FOLD ENTRANCE DOOR..... 14

 DOOR OPERATION LOGIC..... 14

 EMERGENCY ENTRANCE DOOR OPENING 15

WHEELCHAIR LIFT ACCESS DOORS..... 15

REAR VIEW MIRRORS..... 15

HUBODOMETER..... 16

6 Coach Exterior

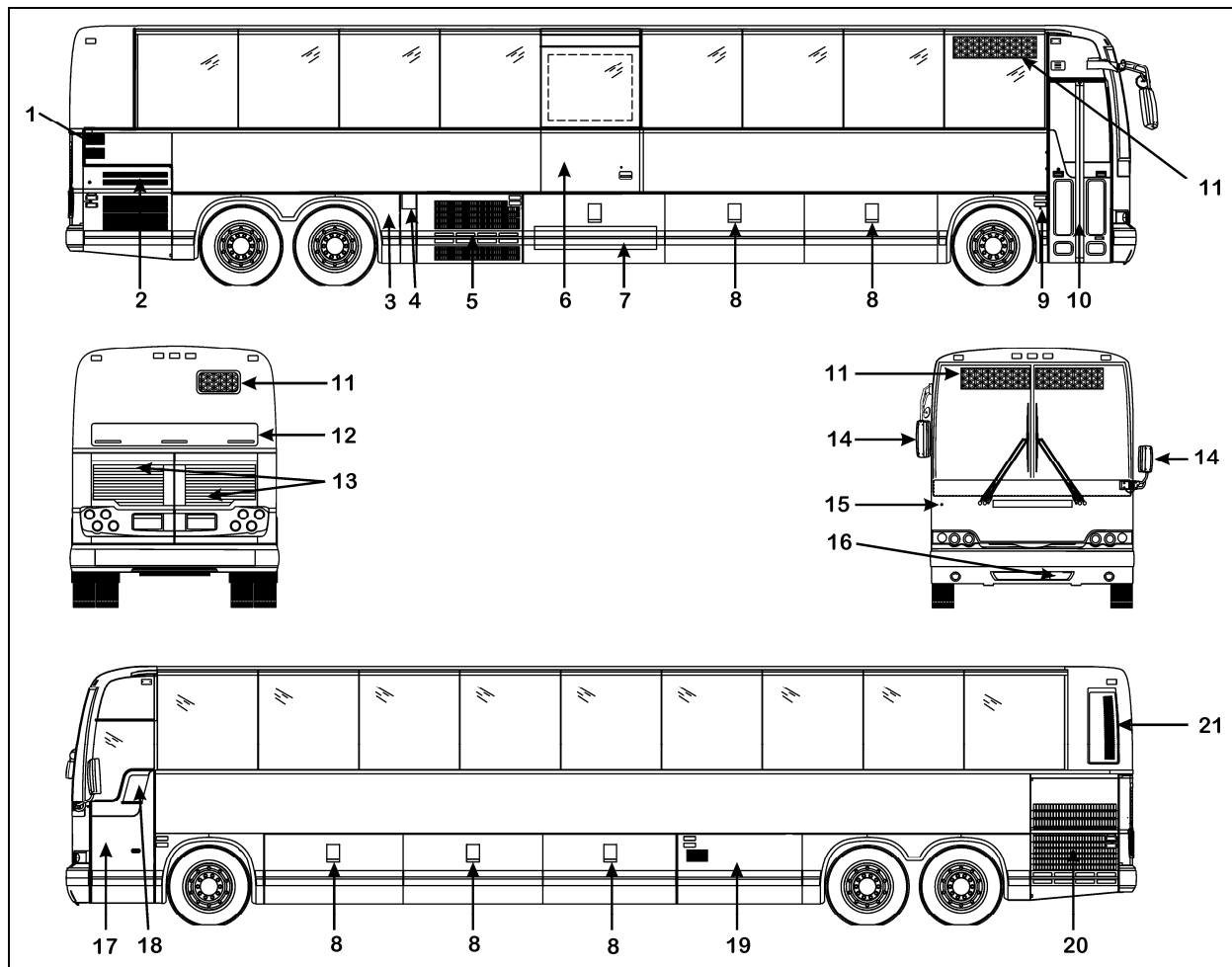

X3-45 EXTERIOR VIEW (TYPICAL)

18606

- | | |
|-------------------------------------------------|------------------------------------------------------------|
| 1. Engine Air Intake | 13. Engine Compartment Rear Doors |
| 2. Engine Compartment Curb-Side Door | 14. Rear-View Mirrors |
| 3. Hinged Rear Fender | 15. Transmission Retarder OFF Indicator Light |
| 4. Fuel Filler Door | 16. Front Towing Air Supply Connectors Access Door |
| 5. Condenser Compartment | 17. Front Electrical And Service Compartment |
| 6. Wheelchair Access Door | 18. Driver's Power Window |
| 7. Lift Mechanism Access Door | 19. Evaporator Compartment and Coolant Heater Compartment. |
| 8. Baggage Compartment | 20. Radiator Door |
| 9. Entrance Door Control Switch | 21. Catalytic Converter Access Door |
| 10. Bi-Fold Entrance Door | |
| 11. Electronic Destination Sign or Route Number | |
| 12. Exhaust Aftertreatment System Access Door | |

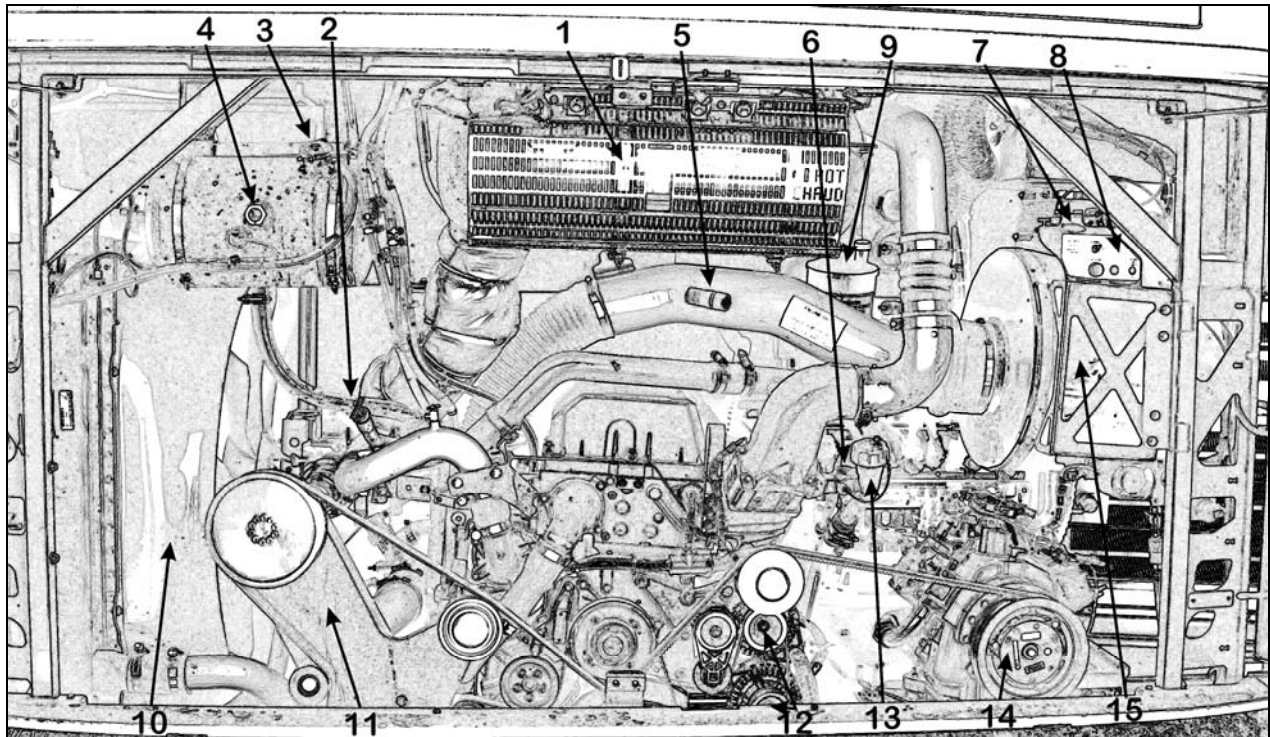
ENGINE COMPARTMENT COMPONENTS**ENGINE COMPARTMENT FEATURING VOLVO D13 ENGINE**

01184

1. Diesel Oxidation Catalyst (DOC) & Diesel Particulate Filter (DPF) Assembly;
2. Transmission fluid dipstick;
3. Coolant fluid surge tank filler cap;
4. Coolant fluid surge tank sight glass;
5. Air filter restriction indicator;
6. Engine oil dipstick;
7. Belt tensioner control valve;
8. Starter selector switch and Engine rear start push-button switch, Engine compartment Lights Switch;
9. Power steering fluid reservoir;
10. Radiator fan;
11. Radiator fan drive mechanism support;
12. Alternators;
13. Engine oil filler tube;
14. Central A/C compressor;
15. Air filter;

ENGINE COMPARTMENT

ENGINE COMPARTMENT CURB-SIDE DOOR

The engine compartment curb-side door provides access to the following (if equipped):

- Engine compartment rear doors release handle;
- Booster terminals;
- Rear electrical panel;
- Rear junction panel;
- Battery compartment;
- Air circuit fill valve and drain cock;

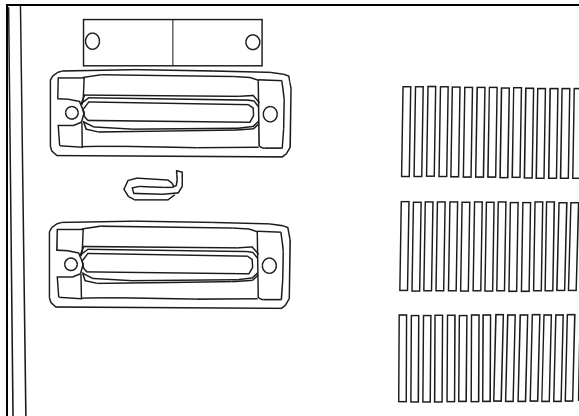

ENGINE COMPARTMENT CURB-SIDE DOOR 18559

This door can be locked or unlocked using the exterior compartment key or, if so equipped, by the central door locking system. To open, push sideways on the small lever located between the marker lights.

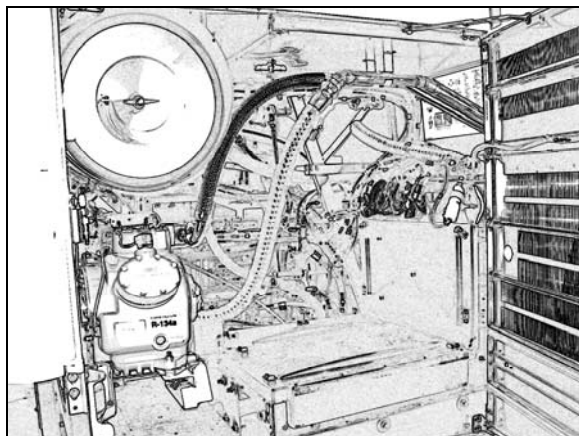

ENGINE COMPARTMENT R.H. SIDE 18607

NOTE

This compartment can be locked/unlocked using the central locking system by pressing the switch located on the L.H. side dashboard panel.

A telltale light illuminates when one or more compartments are unlocked.

ENGINE COMPARTMENT REAR DOORS

To open the engine compartment rear doors, open the engine compartment curb side door and pull the handle located on the rear door, close to the bottom door hinge.



WARNING

Unless otherwise stated, do not run the engine when the engine compartment is open.

These doors swing out to provide access to the following:

- Engine;
- Alternator(s);
- Compressor(s);
- Belt tension control valve (refer to chapter, Care and Maintenance);
- Engine starting selector (refer to chapter, Starting and Stopping Procedures);
- Coolant line shutoff valves;
- Certification plates;
- Engine coolant surge tank and filler cap;
- Air filter restriction indicator;
- Engine oil dipstick;
- Power steering fluid reserve tank;
- Allison automatic transmission fluid dipstick;

A catch holding each door open engages when the door is fully open. Release the catches before closing the doors. Close the L.H. door first, then firmly shut the R.H. door.



OPENING ENGINE COMPARTMENT REAR DOORS 18608

Turn the lights ON in the engine compartment using the switch on the rear start panel.

WARNING

Unless otherwise specified, do not run engine when the engine compartment rear doors are open. Close the engine compartment rear doors before starting the engine.

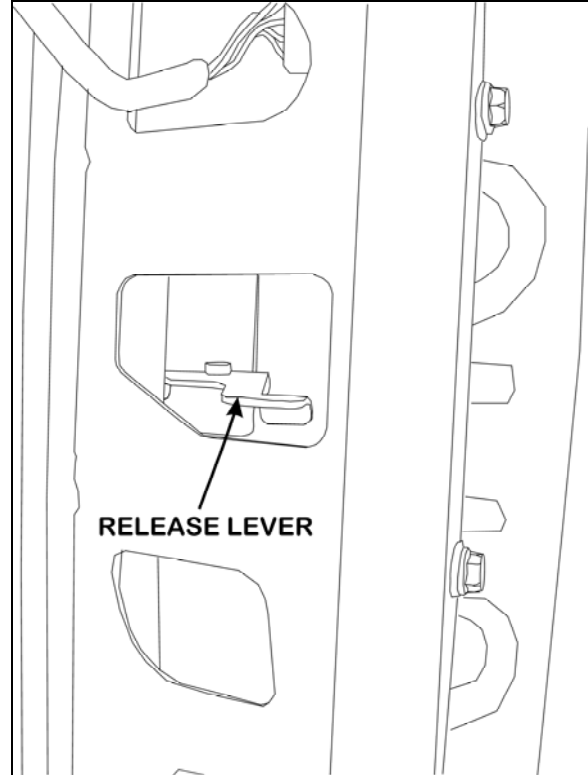

RELEASE LEVER

EXHAUST AFTERTREATMENT SYSTEM ACCESS DOOR



The engine door must be open before opening the exhaust aftertreatment system access door. To open the access door, lower the latch release lever, using a flat tip screwdriver.

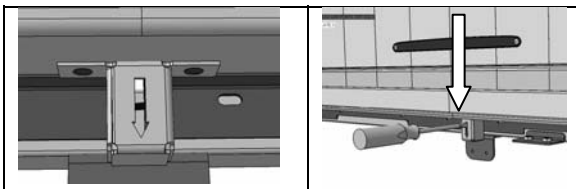

To close the door, lower the door and push against the release lever spring to latch the door shut.

ENGINE RADIATOR DOOR

First open the engine compartment doors before opening the radiator door. The release lever is located near the radiator. Push the release lever forward to open the radiator door.

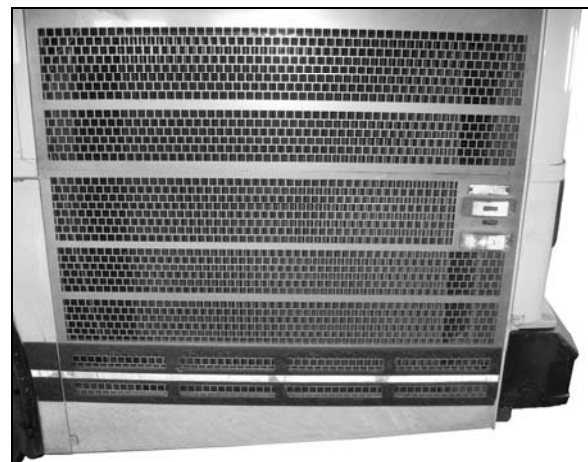

RADIATOR DOOR

18560

CATALYTIC CONVERTER ACCESS DOOR

To gain access to the catalytic converter, open the radiator door first. At the top of the radiator compartment, pull the catch connecting rod to unlock the catalytic converter access door and lift the door open.

Hold the door open by inserting the support rod free end into the receptacle located on the left side of the DPF.

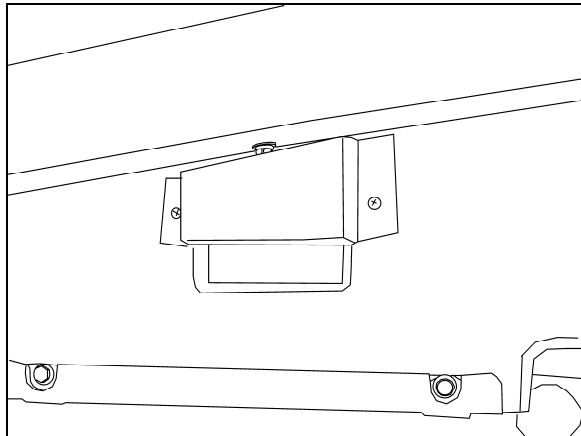

UNLOCKING CATALYTIC CONVERTER ACCESS DOOR



WARNING

After inserting the support rod into the receptacle, make sure the rod supports the door securely from falling down on to your head or body.

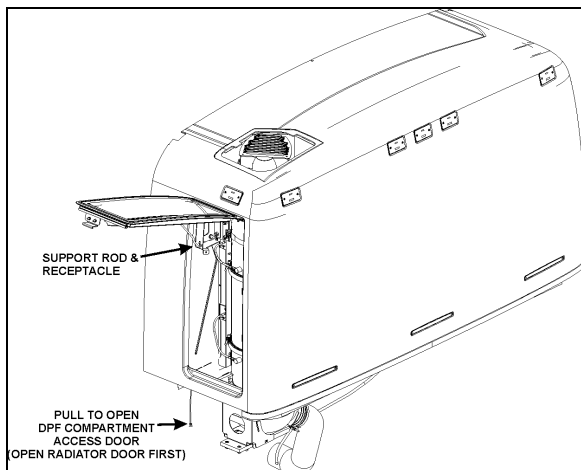

ACCESS TO THE CATALYTIC CONVERTER 04023



WARNING

External and internal temperatures remain hot long after engine has been shutdown. Allow the Exhaust Aftertreatment System to cool before handling. Wear protective clothing and glove while servicing.

CONDENSER COMPARTMENT (A/C)

Pull the release latch located inside the adjacent baggage compartment to open the condenser door.

The condenser compartment provides access to the following:

- Diesel Exhaust Fluid (DEF) Tank
- Condenser;
- Condenser fans and motors;
- Filter dryer and moisture indicator;
- Receiver tank;

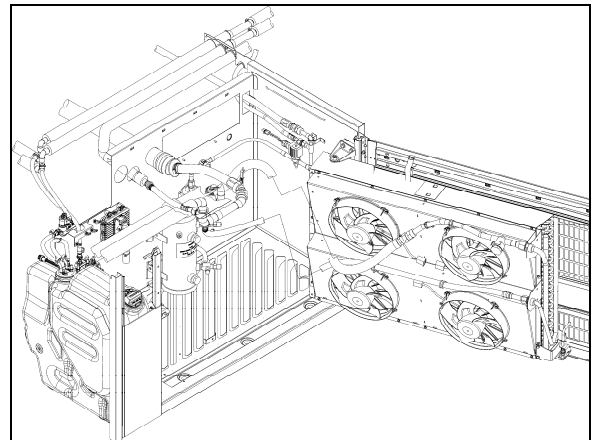

CONDENSER COMPARTMENT (A/C) 22299



CAUTION

Only the strap should be used to pull the condenser-fan assembly open. Damage to condenser could result if pulling by other means.



CONDENSER COMPARTMENT STRAP

EVAPORATOR COMPARTMENT

The HVAC (Heating, Ventilating and Air-Conditioning) evaporator blower and coolant heater compartment are located in this compartment. The compartment door release latch is located on the right side of the baggage compartment and to the left of the HVAC compartment door. Pull the release latch then swing the HVAC compartment door open.

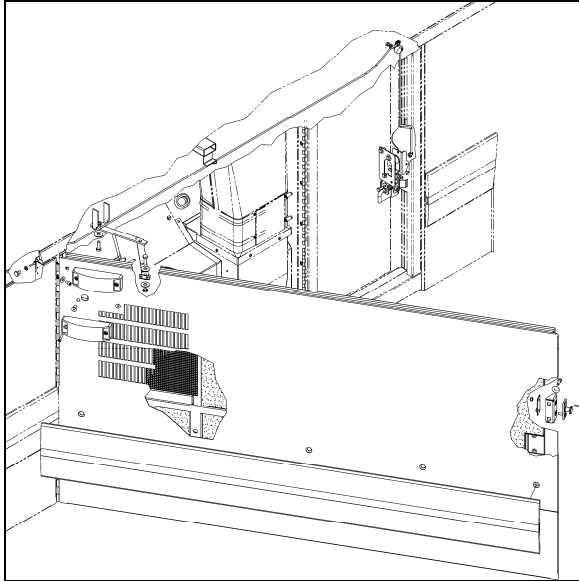

EVAPORATOR COMPARTMENT

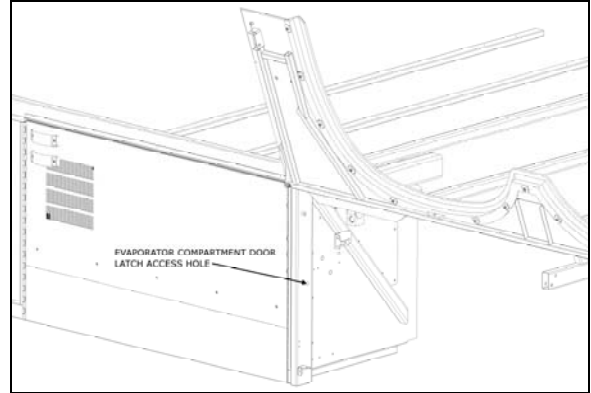

EVAPORATOR COMPARTMENT DOOR RELEASE LATCH ACCESS HOLE

COOLANT HEATER COMPARTMENT

The water recirculating pump is located aft of the evaporator compartment and inside the engine coolant heater compartment and accessible through the evaporator compartment door. The air dryer may also be located in this compartment or in the middle of the rear wheelhousing, above the drive axle.

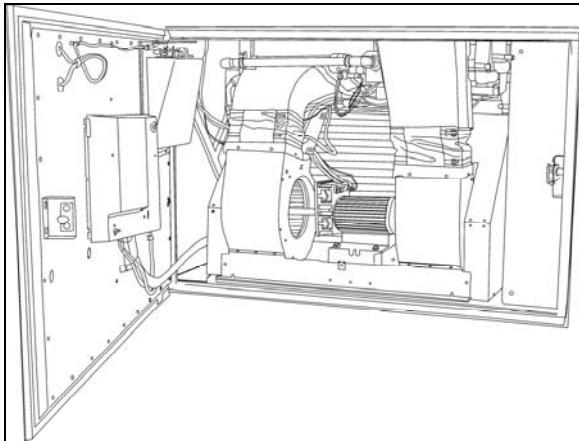

EVAPORATOR COMPARTMENT

22274



RECIRCULATION DAMPER

22302

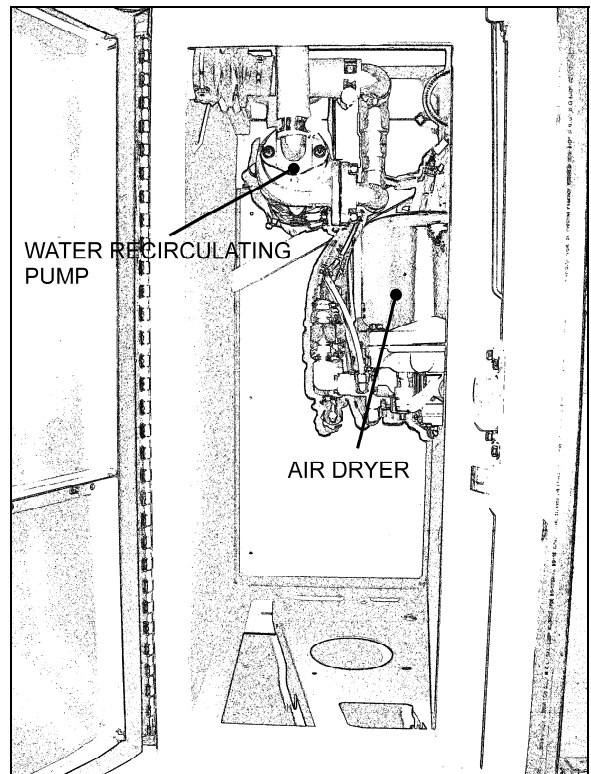

COOLANT HEATER COMPARTMENT

In case of damage or malfunction of the evaporator compartment door release latch, the door can still be opened using the access hole located forward of the compartment.

Insert a small rod through the access hole to release the latch.

12 Coach Exterior

FRONT ELECTRICAL AND SERVICE COMPARTMENT

To open the front electrical and service compartment door, pull the rod inside the vehicle, next to the driver's power window or use the key to open from outside the coach. The front electrical and service compartment provides access to the following:

- Front terminal block;
- VECU with Volvo D13 engine;
- Vehicle Electrical Center Front (VECF), MCM and Multiplex Modules;
- Relays and fuses;
- Tag axle control valve lever;
- ABS Electronic Control Unit (ECU);
- Emergency door opening unlatch valve;
- Windshield washer reservoir;
- Accessory system fill valve;
- Accessory air tank drain valve;
- Jack and tools.

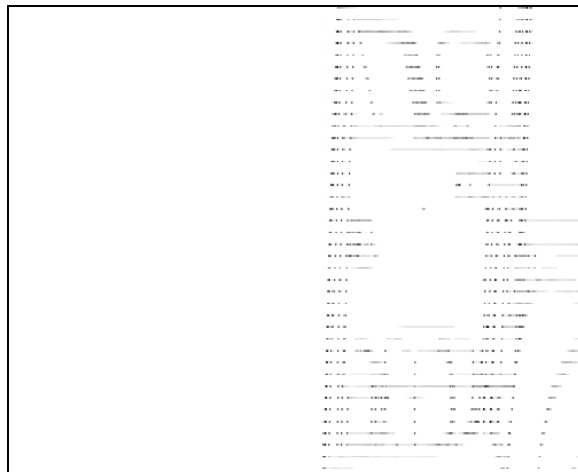

FRONT SERVICE COMPARTMENT DOOR 18610

This compartment door can be locked/unlocked using the exterior compartment key.

The light in the front electrical and service compartment turns *ON* automatically when the door is opened.

NOTE

Jack and tools are located inside the front electrical and service compartment.

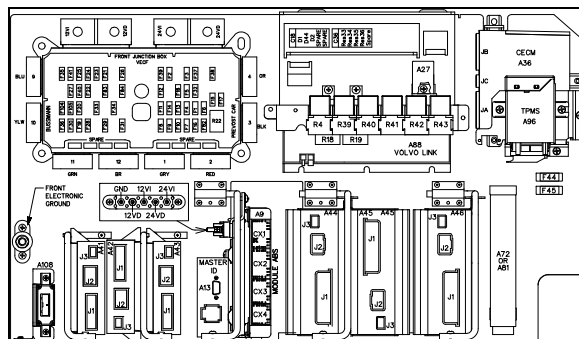

FRONT ELECTRICAL COMPARTMENT 06673

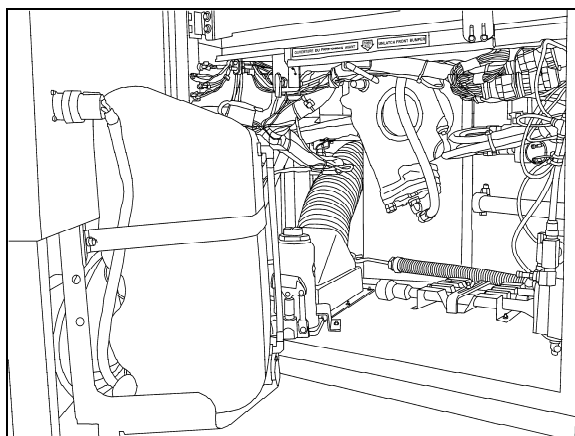

FRONT SERVICE COMPARTMENT 18611

BAGGAGE COMPARTMENTS

The baggage compartments of the X3-45 Coach may be locked using a seal on the operating handle.

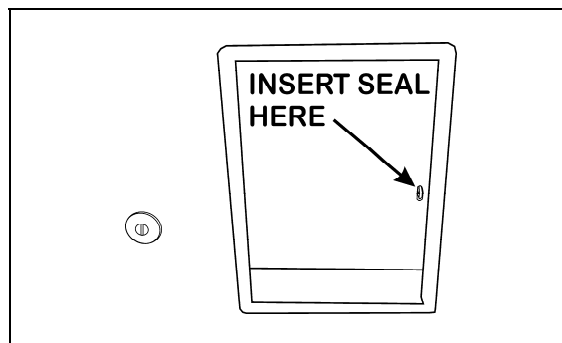

BAGGAGE COMPARTMENT HANDLE

If necessary, the baggage compartments of the X3-45 Coach provide 406 ft³ (11.5 m³) of storage capacity. The compartments can be locked or unlocked by using the exterior compartment key. Pull up operating handle to release the latch, and then pull the door open. Pressurized cylinders assist the opening and closing of the baggage compartment doors and hold the doors open.

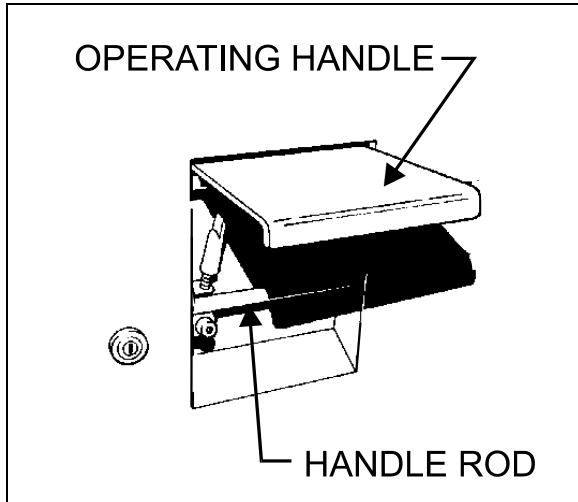

BAGGAGE DOOR LOCK AND LEVER 18043

To close, pull the door down by the handle rod. Complete the closing of the door by returning the operating handle to its initial position.



CAUTION

Do not slam shut the baggage compartment doors. Damage to door weather-stripping or locking mechanism could result.

Lights in the baggage compartments turn ON automatically when the door is opened.

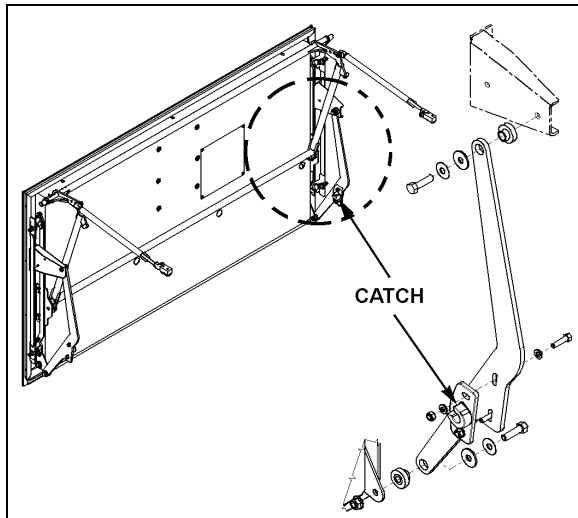

BAGGAGE DOOR CATCH 18612

NOTE

For added safety, open the door until the catch assist in holding the door in the open position.

NOTE

The baggage compartment doors can be locked/unlocked from the driver's position by the optional central locking system. The switch is on the L.H. control panel. Refer to "Controls & Instruments" chapter.



WARNING

To avoid injury, keep hands clear of baggage compartment door edge and door frame when closing.

NOTE

To prevent theft and vandalism, always lock the baggage compartment doors before leaving the vehicle unattended.

FUEL AND DIESEL EXHAUST FLUID (DEF) FILLER DOOR

The fuel and Diesel Exhaust Fluid (DEF) filler door is located on the R.H. side of the coach providing easy filling. A spring keeps the door either open or shut. The vehicle is equipped with Emco Wheaton POSI/LOCK 105 Automatic DRY-BREAK Fuelling System; the POSI/LOCK Filler Neck Assembly is installed on the fuel tank and requires the use of POSI/LOCK Refueling Nozzle for proper operation.

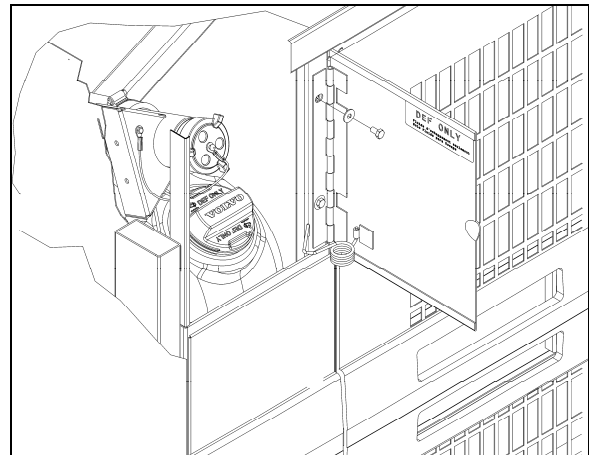

FUEL & DEF FILLER DOOR 03046

NOTE

Provided the vehicle is parked on level ground, an automatic nozzle will automatically shut off when fuel tank is approximately 95% full.



CAUTION

Diesel exhaust fluid DEF will begin to crystallize and freeze at 12°F (-11°C) and expand by 7% when frozen. To allow expansion without damaging the DEF tank, do not fill the tank with more than 15.9 gallons (60 liters).



CAUTION

Do not fill to more than 95% of the fuel tank capacity. Do not "top off" the tank, doing so may result in fuel spillage when the fuel expands.

BI-FOLD ENTRANCE DOOR

Lock or unlock the bi-fold entrance door from outside the vehicle by turning the key in the door lock (counterclockwise to lock, clockwise to unlock). The entrance door can be unlocked from the inside using the small lever located on the door.

From outside, open the door by pushing the switch forward, close by pushing the switch rearward.

Close by pressing and holding the door closing switch (R.H. button) on the dashboard. If the closing switch is released before the door is fully closed, the door will stop in that position. Refer to "Controls and Instruments" chapter for more information.

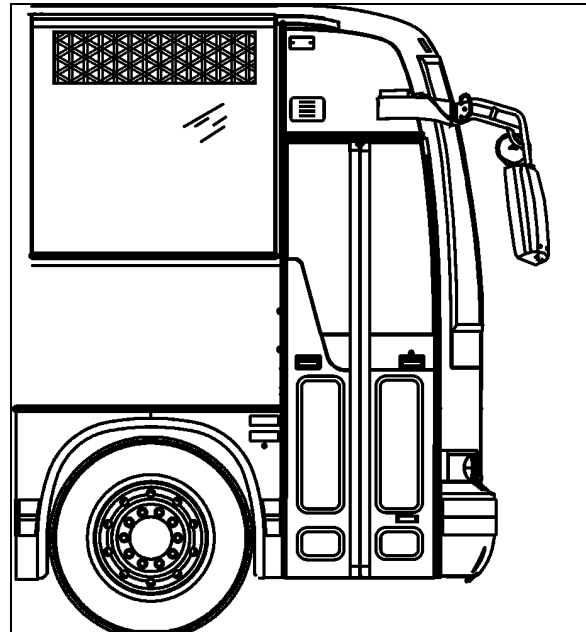

ENTRANCE DOOR

18001

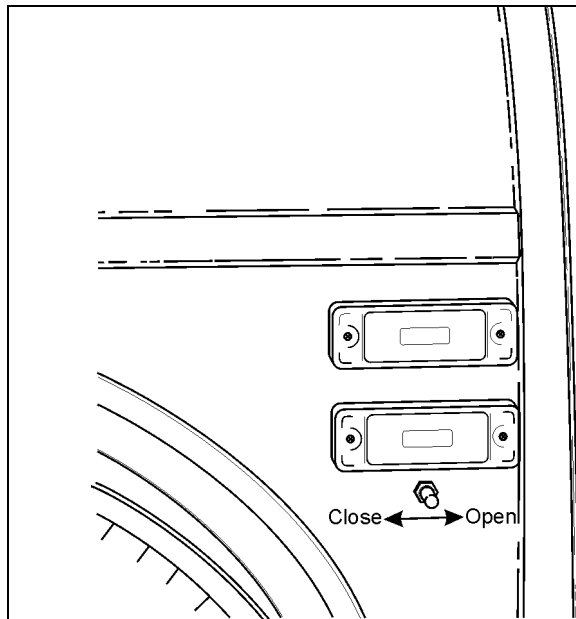

ENTRANCE DOOR EXTERIOR SWITCH

18599

From the inside, open the door by pressing the door opening switch (L.H. button) on the R.H. dashboard panel. The door will open to full open position within 5 seconds.

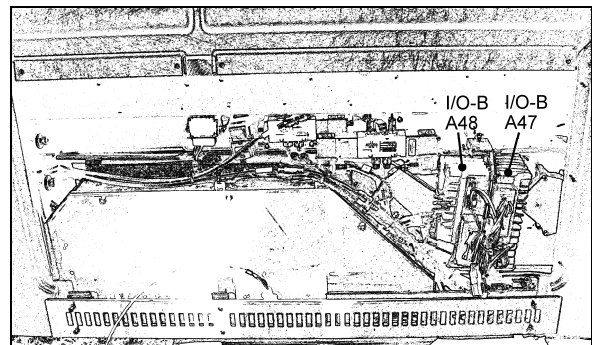

ENTRANCE DOOR & WIPER CONTROL PANEL

06614

DOOR OPERATION LOGIC

If the switch is held in position until the door is fully open or closed, the system holds pressure in the door cylinder, locking the door in that position. A proximity sensor will finish the closing of the door when it senses the door is almost shut.

The door can be closed to any position by releasing the switch (or button, if inside) when the desired position is attained. However, the door is not locked in any position other than fully closed. The door can then be closed further by pushing or pulling on the door.

The door closing switch flashes when the vehicle speed is below 2mph (3 Km/h) to indicate that the driver is allowed to open the door.

EMERGENCY ENTRANCE DOOR OPENING

Refer to “Safety Features and Equipment” chapter.

WHEELCHAIR LIFT ACCESS DOORS

To open the optional wheelchair lift access doors, the coach must be parked on a flat and level surface with the parking brake on. The wheelchair access door swings to the side and is maintained open by a locking mechanism. Open the wheelchair access door completely until it locks in the open position. To close the door, pull on the tab located on the inside of the door and slam the door shut.

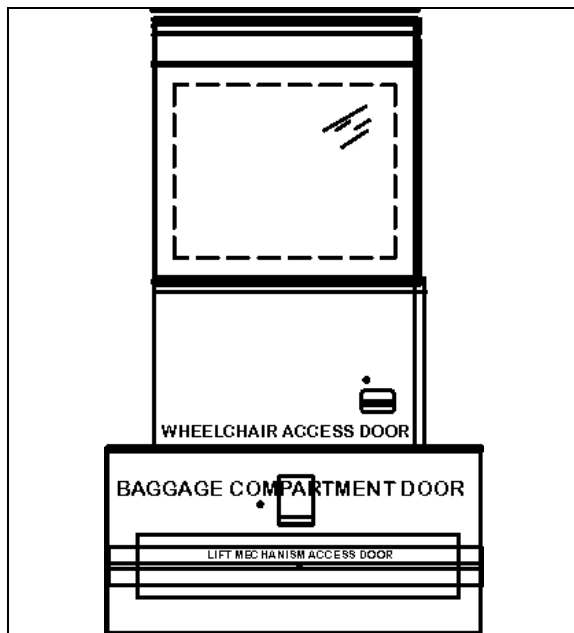

WHEELCHAIR LIFT ACCESS DOORS

Using the exterior compartment doors key, unlock and carefully lower the lift mechanism access door which is part of the baggage compartment door. The lift mechanism access door is located directly below the wheelchair access door. If the parking brake is not activated, a switch in the door will activate the parking brake when it detects the door is open. Refer to “Other Features” for more information on operating the wheelchair lift.

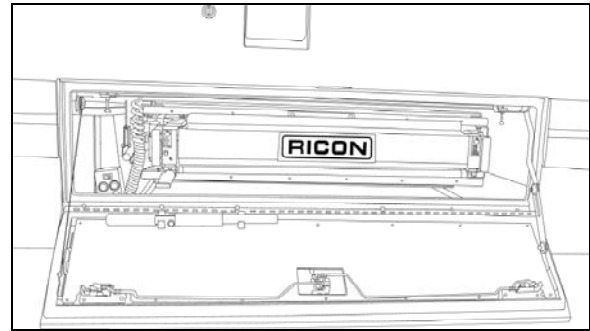

OPENING LIFT MECHANISM ACCESS DOOR

18616

REAR VIEW MIRRORS

The vehicle is equipped with flat-type and convex-type rear-view mirrors. Convex mirrors give a wide angle view. Objects viewed in convex-type rear-view mirrors appear smaller and are actually closer than they appear.

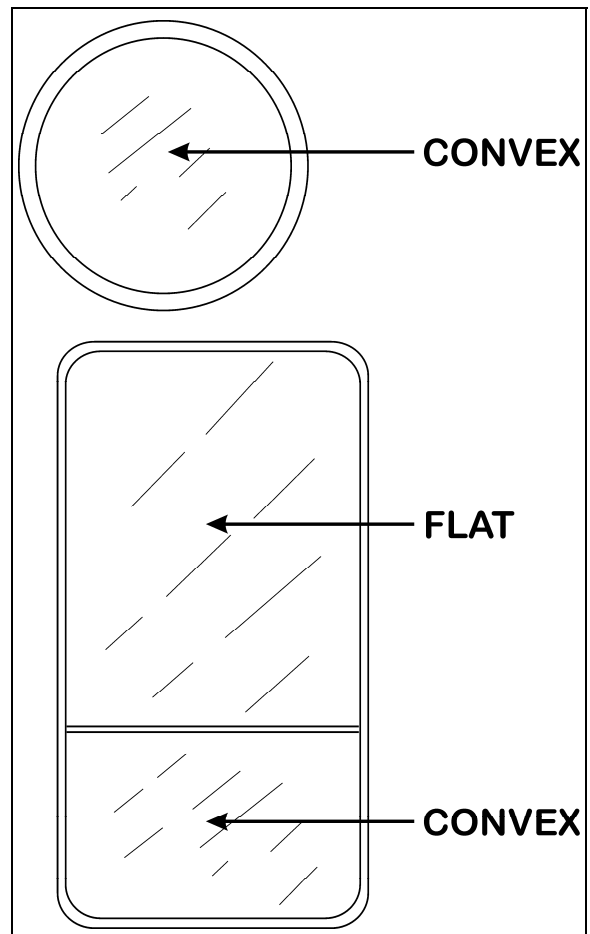

REAR VIEW MIRRORS

L.H. and R.H. side mirrors are basically the same except that the R.H. side mirror support arm is also equipped with a round convex type mirror to provide better visibility in front of the vehicle R.H. side corner.



CAUTION

Round convex type mirror is not adjustable.

The mirrors are adjusted using the controls located on the L.H. control panel. Refer to "Controls & Instruments" chapter. Manual adjustment is also possible.

HUBODOMETER

An odometer is installed on the curb-side drive axle wheel hub. The odometer calculates the total distance in miles or kilometers (depending on model installed) traveled by the coach since manufacture, including factory road testing.

NOTE

It is normal for the hubodometer, the engine ECM and the vehicle odometer to disagree on the total mileage.

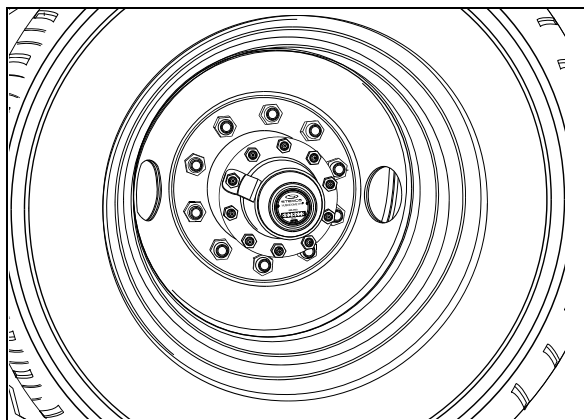

HUBODOMETER

13012

ELECTRONIC DESTINATION SIGN 18

STEERING WHEEL ADJUSTMENT 18

AISLE MIRROR 18

ADJUSTABLE HVAC REGISTERS 18

DRIVER'S SEAT – RECARO 18

 ADJUSTMENT 19

 SAFETY BELTS 19

PASSENGER SEATS 20

OVERHEAD CONSOLE 20

 ADJUSTABLE AIR REGISTERS 20

 SERVICE BELL 21

 READING LIGHTS 21

WINDOWS 21

 PANORAMIC WINDOWS 21

 DRIVER'S POWER WINDOW 21

WINDSHIELD 22

VENTILATION HATCH 22

OVERHEAD COMPARTMENTS 22

ELECTRONIC DESTINATION SIGN

The “aesys” destination sign is activated with the ignition switch located on the dashboard. Refer to Controls & Instruments chapter.

Type in the code on the keyboard of the KC640 Central Control Unit to select the desired destination.

NOTE
 Refer to *aesys Model KC640 CCU Destination Sign Operator’s manual* included at the end of Section 23 in *Maintenance Manual* for more information on programming and downloading data archive.

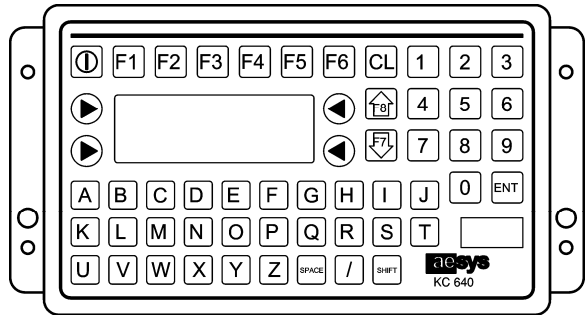

KC640 CENTRAL CONTROL UNIT

STEERING WHEEL ADJUSTMENT

Push on the valve button located in the foot-operated control housing to unlock the steering wheel for tilt and telescopic adjustment (refer to “Controls and Instruments” chapter).

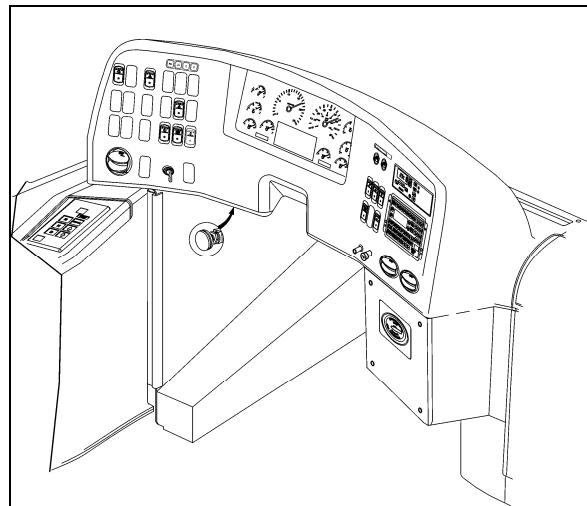

TILT AND TELESCOPIC ADJUSTMENT

18670

⚠ DANGER

Do not adjust the steering wheel while driving. Loss of control could result. Park the vehicle safely and apply parking brakes before adjusting the steering wheel.

AISLE MIRROR

A central mirror allows the driver to see in the aisle. Adjust mirror manually.

ADJUSTABLE HVAC REGISTERS

The HVAC system has adjustable registers to control air flow around the driver’s area. Three are located on the dashboard; two on the R.H. side and one on the L.H. (refer to Controls & Instruments chapter). Another one is located close to the door, below the modesty panel wall for step de-icing. The direction and volume of air flow are adjustable manually.

Use the HVAC control panel to set air temperature.

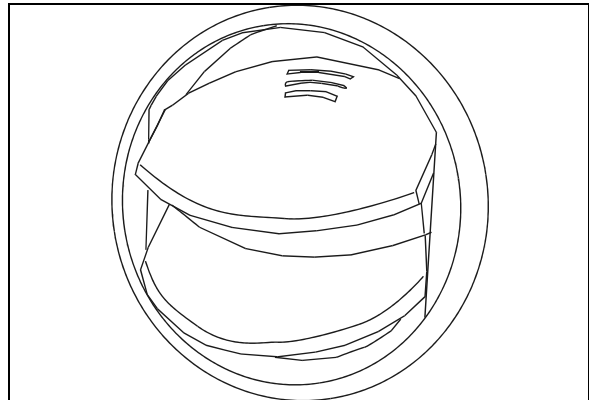

AIR REGISTER

22249

DRIVER’S SEAT – RECARO

The coach is equipped with a Recaro Ergo MS seat.

⚠ DANGER

The driver’s seat must be adjusted to allow the driver easy access to the coach controls. Never adjust seat while driving vehicle as this could result in loss of vehicle control.



DANGER

Make sure that seat is adjusted and that safety belt is buckled up before diving vehicle.

ADJUSTMENT

Seat can be adjusted to the desired driving position by following the instructions listed below:

Fore and Aft



18339

To adjust distance between driver and dashboard, pull handle #1 up and slide the seat forward or backward. Release handle to lock the seat in position.

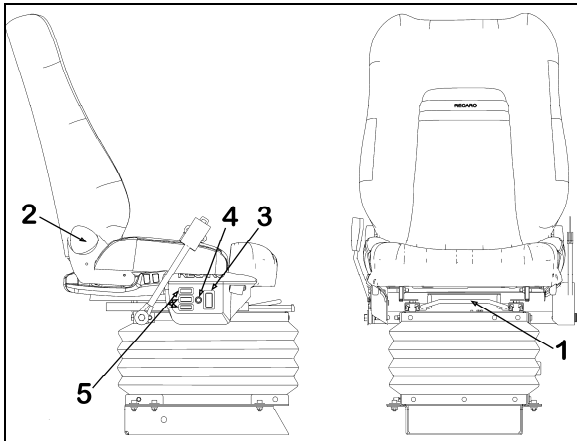

DRIVER'S SEAT ADJUSTMENT (RECARO)

18333

Backrest

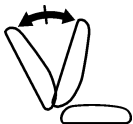

18335

Turn handwheel recline #2 to adjust backrest to the desired angle.

Up and Down



18338

Toggle up/down switch (3) to adjust height of the seat.

Fore and Aft Auto Actuator



18339

To adjust distance between driver and dashboard, push auto actuator #4 and slide the seat forward or backward. Release button to lock the seat in position.

Lumbar Support



18341

Use the 3-cell lumbar switches (5) to adjust lumbar support.

SAFETY BELTS

The driver's seat is equipped with a 2-point retractable safety belt as required by State and Federal regulations. The safety belt is 70-inch long. To fasten, pull seat belt out of the retractor and insert the latch plate into the buckle until it clicks. No special adjustment is required since the reel device is self-adjusting. If seat belt operation becomes defective, report to maintenance personnel immediately.

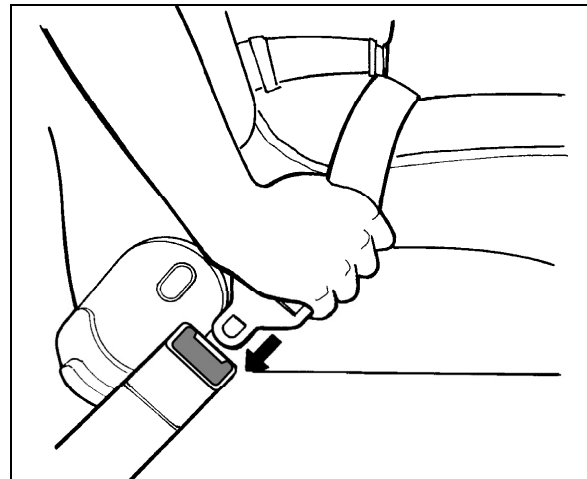

FASTENING SEATBELT

18028

NOTE

The safety belt must be pulled out slowly and continuously, otherwise it will lock the reel before the latch plate reaches the buckle. If this happens, allow the belt to retract completely and repeat the procedure correctly.



WARNING

A snug fit with the lap belt positioned low on the hips is necessary to maximize driver safety. The belt should not be worn twisted. Avoid pinching belt and/or belt hardware in seat mechanism. Do not wear belt over rigid or breakable objects, such as eyeglasses, pens or keys as these may cause injuries.

CAUTION
 Never bleach or dry clean safety belt.

To unfasten belt, press the red button in center of buckle and allow belt to retract. If the belt does not fully retract, pull it out and check for kinks or twists. Make sure that it remains untwisted as it retracts.

DANGER
 Most State and Provincial laws require that safety belts be worn when they are supplied with the seat.

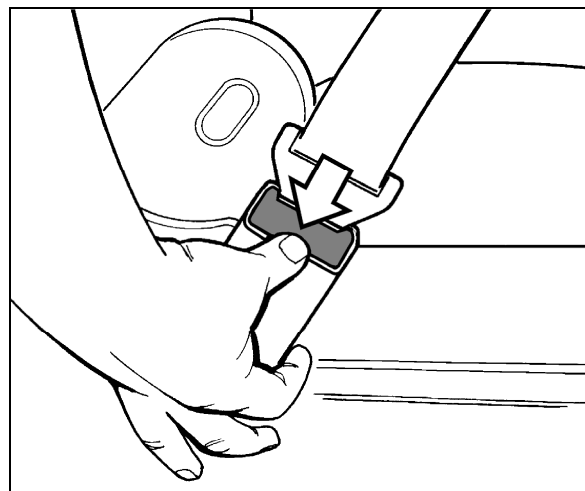

UNFASTENING SEATBELT

18029

PASSENGER SEATS

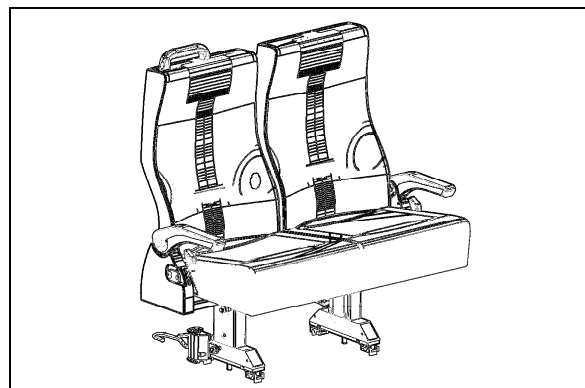

PASSENGER SEAT EQUIPMENT

18121A

All seats are track-mounted so that the seating configuration can be changed. Each set is mounted on rectangular aluminum bases to make cleaning between the base and side wall easier.

Passenger seat backrests can be tilted by using the lever located on the base of the seat. Pull and hold lever, then adjust backrest to the desired angle. Release lever to lock backrest in position.

A folding armrest is installed on the aisle side of the passenger. Another folding armrest is located between the two seats and can be raised for passenger convenience. A fixed armrest is installed on the window side of the seat.

OVERHEAD CONSOLE

One airplane type overhead console is installed above each row of twin seats to provide a total of 107 ft³ (3.0 m³) of storage capacity. Such amenities as reading lights, air vents and stop request service are controlled from this panel.

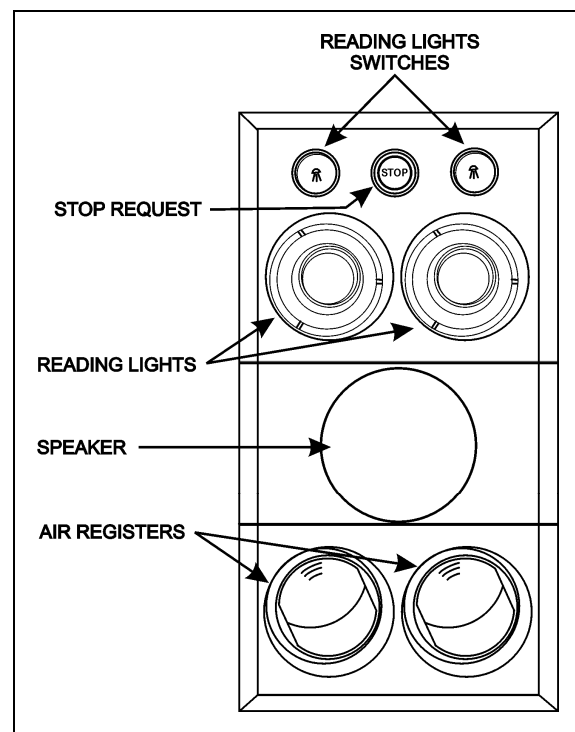

OVERHEAD CONSOLE

23137

ADJUSTABLE AIR REGISTERS

Manually adjustable registers located on the overhead console provide air flow to the passengers. Air flow can be directed, passengers can orient individual registers by rotating the nozzle. To adjust air flow, passengers must open or close the flaps. Activation of the fans is done by depressing a rocker switch on the dashboard. Refer to Controls & Instruments chapter.

STOP REQUEST

Pressing the “STOP” request button on the overhead console will illuminate the button providing a visual cue for service personnel and, if activated, will sound a gong in the driver’s area. Passengers may also use the stop request system to request a stop for disembarking. Press the “STOP” request button a second time to cancel the stop request.

A “STOP” request button is provided for the wheelchair occupant on the window sill of the coach, within easy reach. Pressing this “STOP” request button will sound two gongs to identify the wheelchair occupant.

READING LIGHTS

Reading lights are mounted underneath the overhead storage compartments. Depressing a rocker switch located on the dashboard (refer to Controls & Instruments chapter) will activate the reading light circuit and allow passenger control of reading lights.

WINDOWS

The coach is equipped with frameless flush-mounted “Galaxsee” windows all around and a split-window windshield for maximum visibility.

PANORAMIC WINDOWS

Panoramic side windows can come in either single pane or, as an option, double pane (thermopane) glass. Some of these windows are of the fixed type; they are bonded to the structure and cannot be opened. Others can be easily opened to serve as emergency exits.

Fixed Windows

These windows are bonded to the structure and form an integral part of the body of the vehicle, helping reduce vibration and noise. Fixed windows cannot be opened.

Emergency Windows

These windows can be opened from inside the vehicle as emergency exits. A decal on window sills indicates the location of the emergency windows. To open an emergency window, lift the window release bar (sill) and push the window open from the bottom.

To close, lift the release bar and pull the window into position. Push down on release bar to lock the window shut.

For more information on emergency features, refer to “Safety Features and Equipment” chapter.

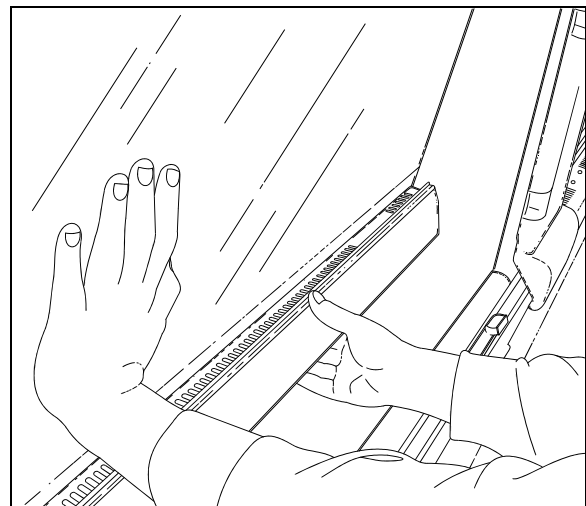

EMERGENCY WINDOW OPENING

18391

DRIVER’S POWER WINDOW

The driver has a power window on the left side of the coach. The windows are controlled by a rocker switch located on the driver’s control panel. Refer to “Controls and Instruments” chapter.

Driver’s window shades

This vehicle is provided with a spring release type sun shade on the driver’s left side window. To operate, pull down the shade by its hem to the appropriate position and release. It will remain in position. To raise, depress the unlocking lever and guide the shade back up using the other hand.

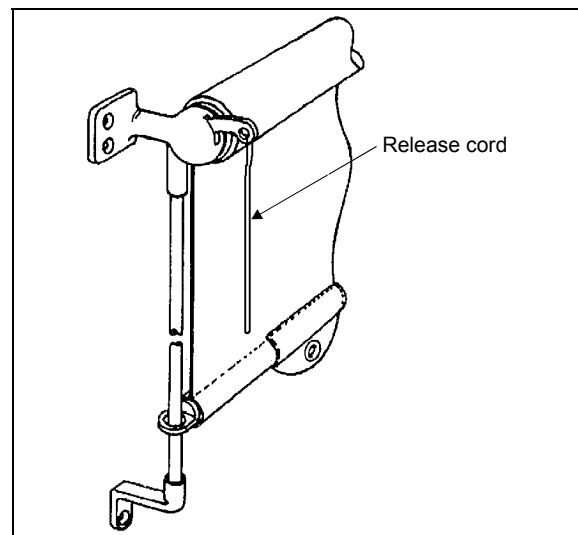

SPRING RELEASE SUNSHADE

23019

WINDSHIELD

Two manually-operated shades are installed behind the windshield. To operate, pull down the shade by its hem to the appropriate position and release. It will remain in position. To retract, raise the shade back up.

VENTILATION HATCH

A ventilation hatch is installed in the ceiling at the rear of the coach and at the front of the coach. To open the hatch, push up with both hands and pull down to close. The ventilation hatch can be completely opened for emergency egress. Refer to "Safety Features and Equipment" chapter.

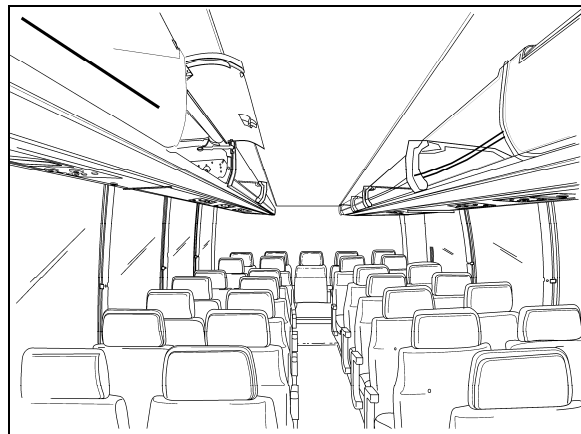

OVERHEAD STORAGE COMPARTMENTS 18603

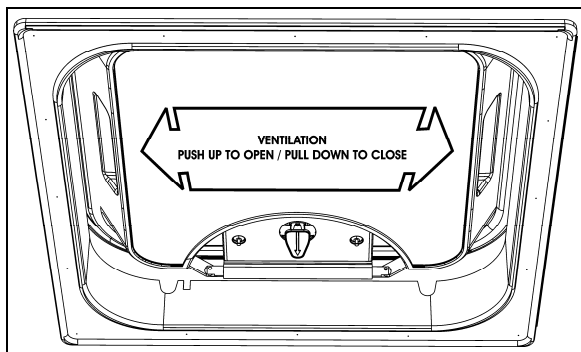

VENTILATION HATCH



WARNING

Be aware of coach overhead clearance when traveling under overpasses with the ventilation hatch(es) open. Check for maximum clearance height.

OVERHEAD COMPARTMENTS

Passenger carry on baggage is stored in overhead compartments on each side of the coach. A first aid kit and a fire extinguisher are located in the first front curb side overhead storage compartment.

To open the closed overhead storage compartments, push the handle in to release the latch, then let go. A pressurized cylinder opens the door.

NOTE

The overhead storage compartments have a minimum amount of separators installed so as to quicken inspection for forgotten objects.

KEYS.....	25
ENTRANCE DOOR AND EXTERIOR COMPARTMENT DOORS KEY	25
IGNITION SWITCH.....	25
LATERAL CONTROL PANEL	28
TRANSMISSION CONTROL PAD	29
CONTROL SWITCHES	29
MIRROR CONTROLS	29
TAG AXLE CONTROL VALVE	29
PARKING BRAKES CONTROL VALVE	29
UTILITY COMPARTMENT	30
EMERGENCY/PARKING BRAKES OVERRULE CONTROL VALVE (BRAKE RELEASE)	30
SILENT ALARM SWITCH	30
DIAGNOSTIC DATA READER (DDR) RECEPTACLE	30
AUTOMATIC FIRE DETECTION AND SUPPRESSION SYSTEM (AFSS)	30
DASHBOARD.....	31
CONTROL SWITCHES	32
L.H. DASHBOARD PANEL	32
R.H. DASHBOARD PANEL	34
DRIVER'S HVAC CONTROL UNIT	36
ELECTRONIC DESTINATION SIGN	37
AIR VENTS	37
INSTRUMENT CLUSTER	38
ANALOG INDICATORS	39
TELLTALE LIGHTS.....	42
DRIVER INFORMATION DISPLAY.....	45
HORNS	53
TRANSMISSION OUTPUT RETARDER	53
FOOT-OPERATED CONTROLS.....	53
HEADLIGHT BEAM TOGGLE SWITCH.....	53
LEFT TURN SIGNAL SWITCH	53
RIGHT TURN SIGNAL SWITCH.....	53
ELECTRIC HORN	53
PANIC BUTTON SWITCH.....	53
BRAKE PEDAL.....	54
ACCELERATOR PEDAL.....	54
ALLISON AUTOMATIC TRANSMISSION.....	54
OPERATION	54
PUSHBUTTON SHIFT SELECTOR.....	54
MODE.....	55

24 Controls and Instruments

TRANSMISSION SERVICE INDICATOR.....	55
DESCRIPTION OF AVAILABLE RANGES.....	55

KEYS

ENTRANCE DOOR AND EXTERIOR COMPARTMENT DOORS KEY

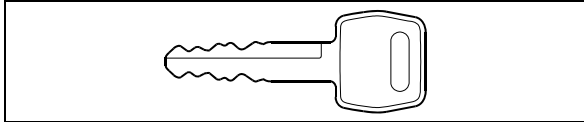

Use this key to lock or unlock the entrance door, the baggage doors, the electrical and service compartment doors.

NOTE

It is also possible to lock or unlock the baggage compartments and engine compartment R.H. side door from the inside by means of the optional baggage compartments locking system.

IGNITION SWITCH

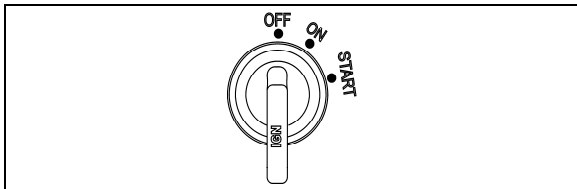

IGNITION SWITCH POSITIONS

06354

Coaches are equipped with an ignition lever instead of an ignition key. Use the ignition lever to activate the electrical circuit by turning it to the ON position.



CAUTION

When the vehicle is parked overnight or for an extended period of time, the ignition switch should be set to the OFF position.

NOTE

When the battery master switch is set to the OFF position, all electrical supply from the batteries is cut off, with the exception of battery equalizer check module, ecm ignition and power supply, allison TCM, coolant electronic, coolant heater and water re-circulating pump, pro-driver, power-verter, fire alarm and entrance door.

The ignition switch doubles as the battery master switch. Any position other than OFF activates the electrical circuits. Electrical circuits are also activated when the hazard switch is

depressed. Two auxiliary master switches in series with the ignition switch are installed on the vehicle; one is located on the rear electrical panel and one in the engine compartment on the rear start panel, for maintenance ease.

The ignition switch is located on the lower left side of the dashboard. It has three positions:

Off

In the OFF position, ignition cannot take place.

The electrical circuits are not activated when the switch is in this position. Only the accessories connected directly to the batteries can be activated. These are the coolant heater and water pump, the baggage compartments locking system, the entrance door and Driver information Display (DID). Maintain the switch in this position when parked overnight or for an extended period.

On

To place the ignition switch to ON, turn the lever clockwise to the first position. Do not leave the lever in this position unless the engine is running.

Start – starting procedure

With your foot off the accelerator pedal, crank the engine by turning the ignition lever to START. Release it when the engine starts. If the engine did not start, return the ignition switch to the OFF position before trying to restart the engine.

The ignition switch is equipped with a starter protection which inhibits turning the lever to the START position if the lever has not previously been turned to the OFF position.



CAUTION

To avoid overheating the starter, do not engage the starter for more than 15 seconds at a time. Allow the starter to cool before trying to restart the engine.



DANGER

Do not use ether or other combustible starting aid fluid on any engine equipped with an intake air preheater. If the engine is equipped with a preheater, introduction of ether or similar starting aids could cause a fire or explosion resulting in severe property damage, serious personal injury or death.

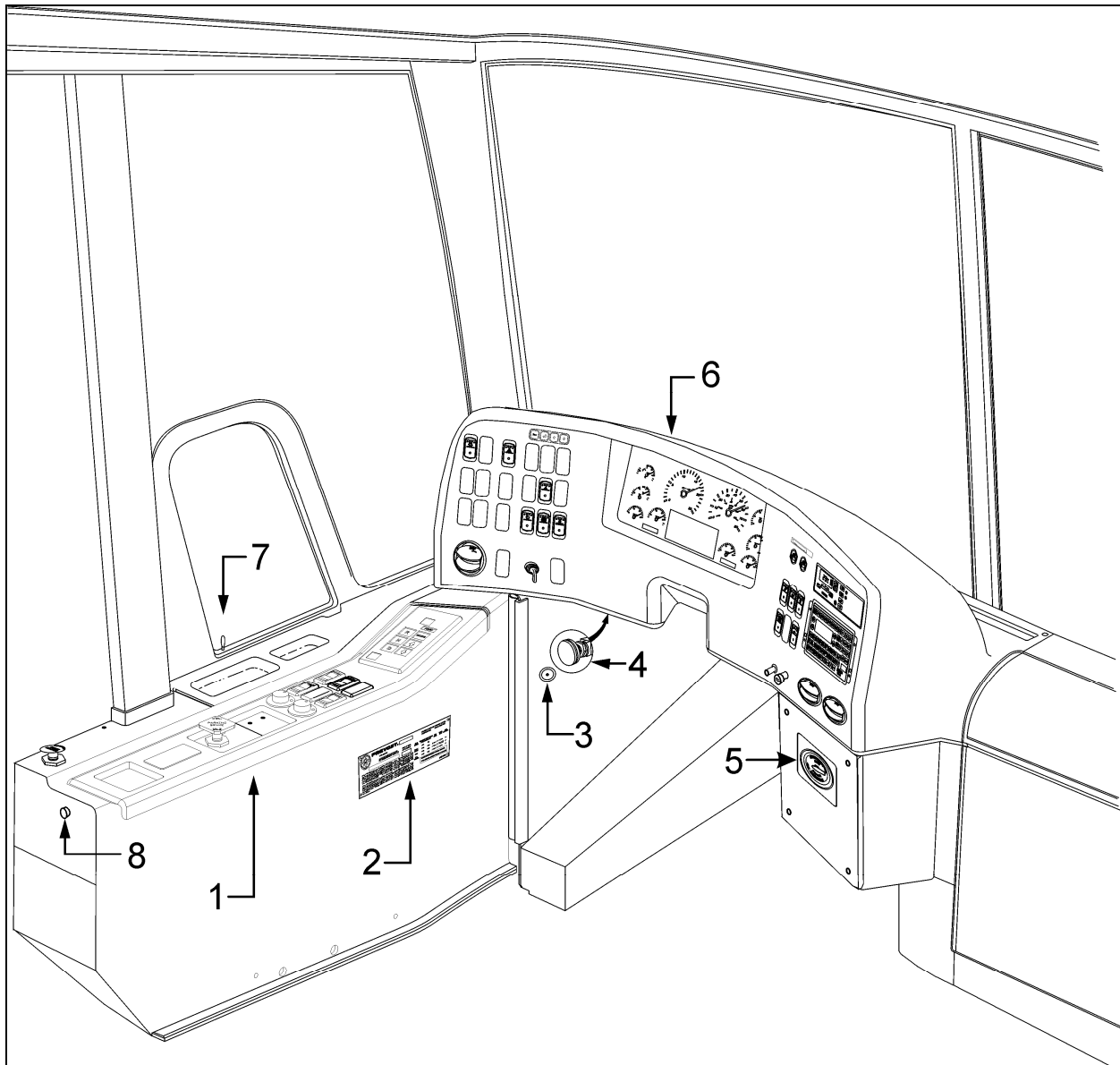

DRIVER'S SECTION

18671

1. Lateral control panel
2. DOT certification plate
3. Diagnostic Data Reader (DDR) receptacle
4. Foot operated steering wheel adjustment unlock air valve
5. Entrance door emergency release air valve
6. Dashboard
7. Front service door unlocking pull rod
8. Silent Alarm Switch

LATERAL CONTROL PANEL

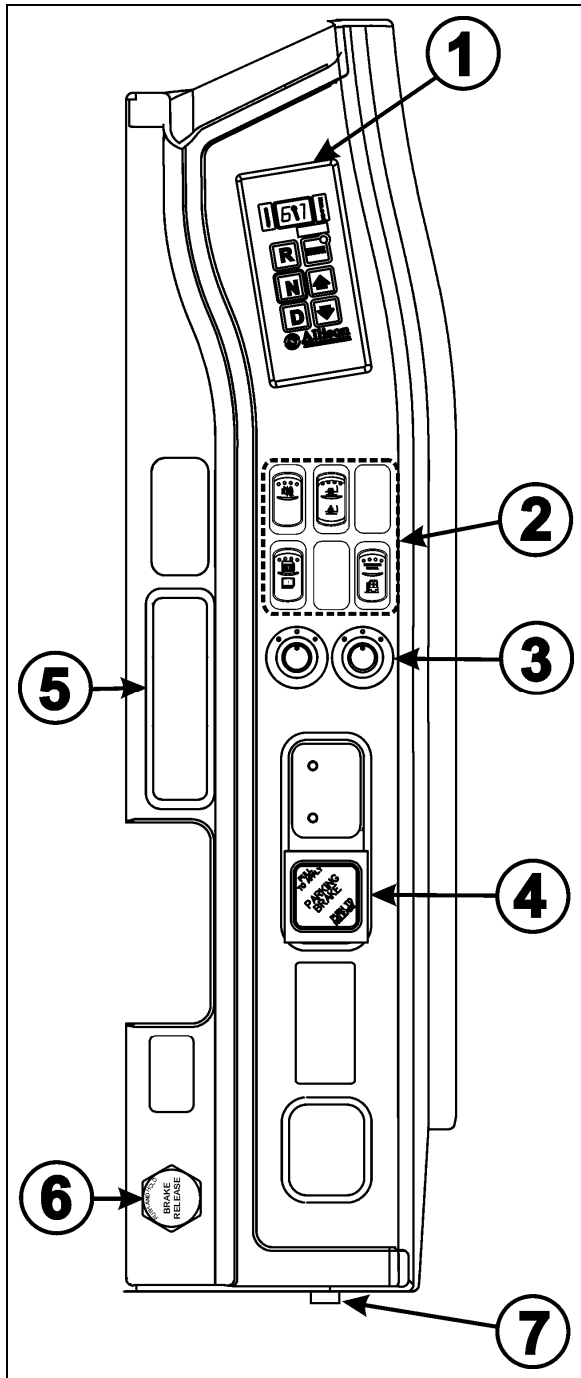

1. Transmission control pad
2. Control switches
3. Mirror controls
4. Parking brakes control valve
5. Utility Compartment
6. Emergency Parking Brakes Ovrerule Control Valve
7. Silent Alarm Switch

LATERAL CONTROL PANEL

06704

TRANSMISSION CONTROL PAD (1)

The Allison transmission control pad is located on the lateral control panel. Refer to "Automatic Transmission" in this chapter for operating instructions and more information.

CONTROL SWITCHES (2)

Kneeling

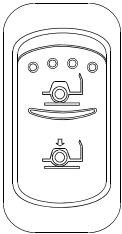

06250

Momentarily press the rocker switch downwards to lower the front end of the coach 4 inches (100 mm). Momentarily press the rocker switch upwards to raise the coach to the normal driving height. Refer to "OTHER FEATURES" chapter for more information.

NOTE

The parking brakes must be applied to allow the use of the kneeling.

Back-Up Alarm Cancel Switch

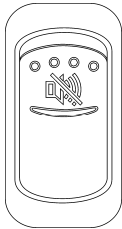

06338

Use this rocker switch to cancel the back-up alarm.

NOTE: After use, return to normal operation.

Power Window Switch

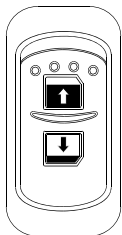

06338

Use this rocker switch to open or close the driver's power window.



CAUTION

Close power window when parked or leaving the coach unattended.

Entrance Door Interlock Cancel Switch

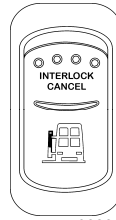

06266

This switch enables moving the vehicle while the entrance door is open for maintenance purposes or in case of emergency.



DANGER

Unless absolutely necessary, always apply parking brakes before lifting safety cover and canceling entrance door interlock to avoid unexpected vehicle movement.

MIRROR CONTROLS (OPTION) (3)

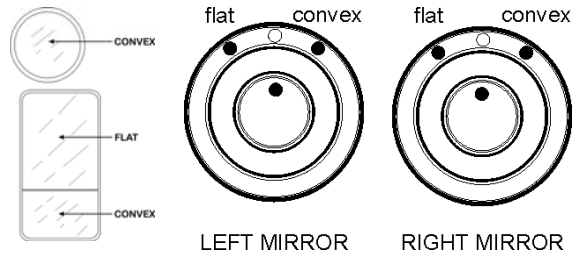

LEFT MIRROR

RIGHT MIRROR

MIRROR CONTROLS

06374

Turn left pointer knob counterclockwise for flat mirror adjustments and to the right for convex mirror adjustments, then use the joystick control to adjust the selected mirror's viewing angle. Adjust the right outside mirror similarly but by using the right side control.

PARKING BRAKES CONTROL VALVE (4)

Spring-loaded parking brakes are applied by pulling up the control valve knob and protector assembly. Lift the safety cover and push down to release brakes. Refer to "Safety Features and Equipment" chapter.

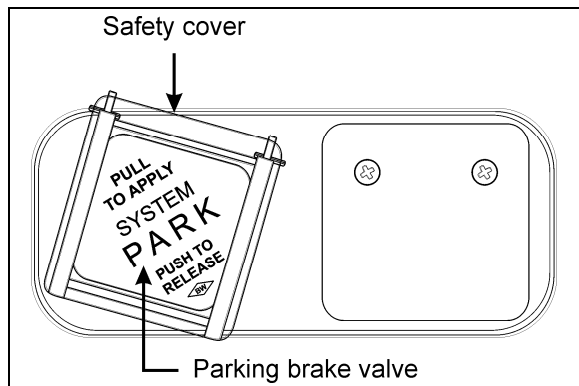

CONTROL VALVES

12129

UTILITY COMPARTMENT (5)

To open the compartment, lift the cover.

**EMERGENCY/PARKING BRAKES
OVERRIDE CONTROL VALVE (BRAKE
RELEASE) (6)**

During normal operation, if air pressure in any brake circuit drops below 40 psi (276 kPa), spring-loaded emergency brake will be immediately applied at full capacity to the drive axle wheels to stop the vehicle. Search and correct the cause of this pressure drop before driving vehicle.

The coach is equipped with the parking brake override system, which allows the vehicle to be driven to the nearest safe parking area even if air pressure is below 40 psi (276 kPa). To actuate the parking brakes override system, push and hold down the control valve located on the lateral control panel.

SILENT ALARM SWITCH (7)

Use this switch to signal an emergency and ask for immediate assistance. A message will be sent via the Motorola system to the monitoring station.

**DIAGNOSTIC DATA READER (DDR)
RECEPTACLE**

To ease troubleshooting, a Diagnostic Data Reader (DDR) (not supplied) can be connected through the DDR receptacle. A user's manual is supplied with the optional DDR. The DDR receptacle is located inside the footwell, on the upper left side wall.

**AUTOMATIC FIRE DETECTION AND
SUPPRESSION SYSTEM (AFSS)**

Protection Panel

The protection panel displays the current system status. The protection panel contains "SYSTEM OK", fire "ALARM" and "TROUBLE" lamps, the audio alarm, the "TEST/RESET" switch, and the "ALARM SILENCE" switch.

The "SYSTEM OK" lamp indicates power is on the system and that there are no trouble conditions present. The "TROUBLE" lamp blinks if there is a fault in the detection circuitry and illuminates solid if there is a fault in the extinguishing circuitry. When the "TROUBLE" lamp is on, the "SYSTEM OK" lamp will be off and the audible alarm will sound intermittently. The "SYSTEM OK" lamp will flash when the system is low on battery power. Depressing the "TEST/RESET" switch tests the protection panel lamps and audio alarm. The "ALARM SILENCE" switch will disable the audio alarm.

When a fire detector automatically detects a fire, the fire "ALARM" lamp and audio alarm activate. When the Manual Activation Switch is activated, the fire "ALARM" lamp blinks and the audio alarm activates. The lamp will remain blinking until power is cycled to the system.

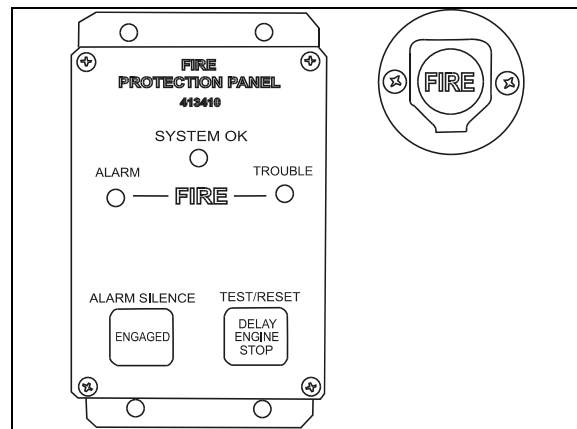

AFSS PROTECTION PANEL & MANUAL ACTIVATION SWITCH

Manual Activation Switch

The manual activation switch allows immediate system activation (extinguisher discharge and engine shutdown) by the operator at any time. Activation of the switch is accomplished by twisting and pulling the tamper seal to remove, lifting the cover and pressing the red "FIRE" button for more than half a second. After the manual activation switch has been activated, the protection panel will blink the fire "ALARM" indicator until power has been cycled to the system.

Refer to chapter "SAFETY FEATURES AND EQUIPMENT" for more information on *Kidde Dual Spectrum* Automatic Fire detection and Suppression System (AFSS).

DASHBOARD

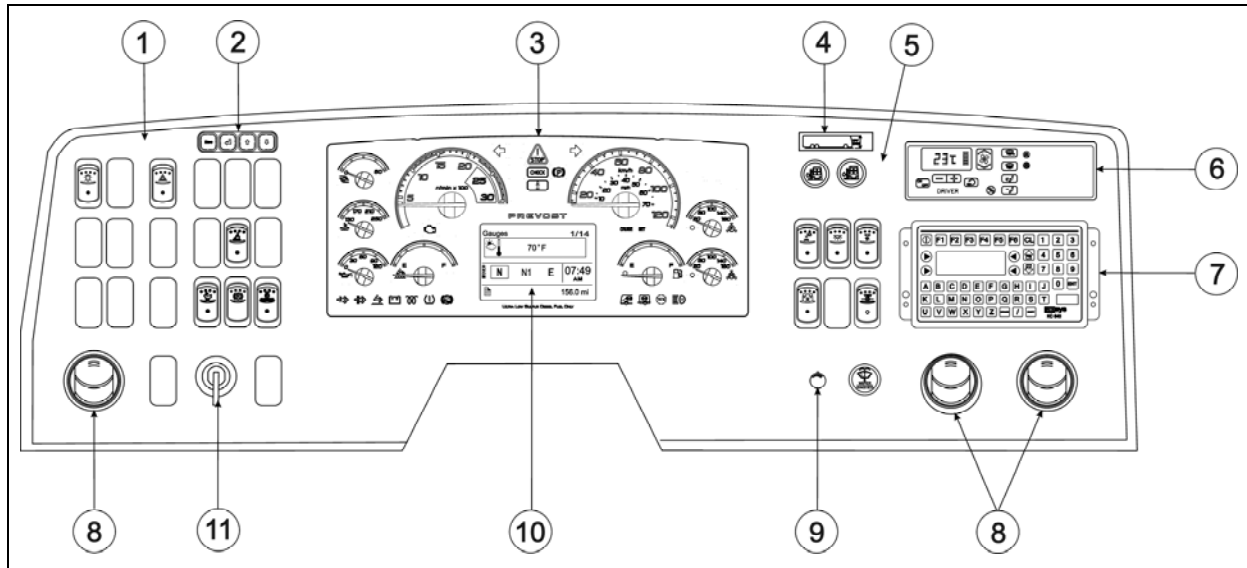

DASHBOARD

06761

1. L. H. Dashboard Panel
2. Driver Information Display (DID) Keyboard
3. Instrument Cluster
4. Vehicle Clearance Information
5. R. H. Dashboard Panel
6. HVAC Control Unit
7. Electronic Destination Sign Central Control Unit
8. Air Vents
9. Brightness Control
10. Diver Information Display (DID)
11. Ignition Switch (Lever)

CONTROL SWITCHES

High quality laser-engraved switches are used to control many of the features of the vehicle. Many switches have an embedded indicator LED to inform the driver at a glance which features are active. Some switches' LED will turn *OFF* after a short while when the engine is running. This is normal and is designed to reduce glare when driving. The functions still operate even if the LED is *OFF*. If the switches are still *ON* when the engine is turned *OFF*, the LEDs will illuminate to warn the driver to turn them *OFF*. Switches are described in the order they appear, from left to right, top to bottom.

L. H. DASHBOARD PANEL

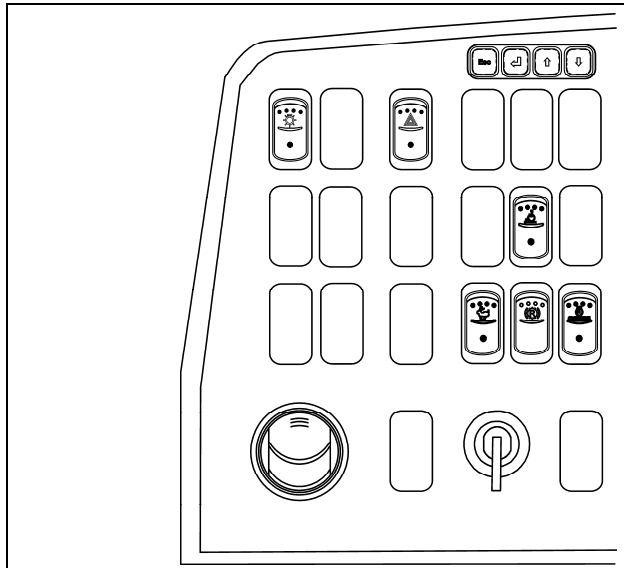

The L.H. dashboard panel includes controls for the operation of the coach; it also includes the ignition switch and an adjustable air vent.

L. H. DASHBOARD PANEL

06762

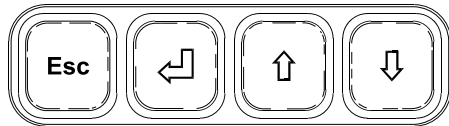

06399

Driver Information Display (DID)

This standard feature gathers, stores and displays important information about the vehicle's operation on a display screen on the lower center portion of the cluster. Refer to Driver Information Display in Other Features chapter for a description of how to set up and operate the Driver Information Display.

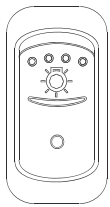

06254

Headlights and Exterior Lighting

Off position – Daytime running lights only

Press this rocker switch to turn on the following lights:

First position – Front parking lights, clearance lights, tail lights, license plate lights and marker lights.

Second position - Push down fully to turn *ON* the headlights, the controls and instrument lights and all lights from first position.

NOTE

Daytime running lights will be automatically cancelled when the exterior lighting switch is fully depressed (second position).

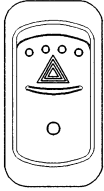

06256

Hazard Warning Flashers

Press the rocker switch to make all turn signal lights flash at once. The dashboard telltale lights will flash when the hazard warning flashers are *ON*.



CAUTION

Do not use the hazard flashers for an extended period of time unless necessary because the electrical circuits are activated when the hazard switch is depressed.

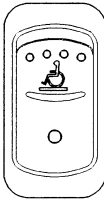

06268

Wheelchair Lift

Activate the optional wheelchair lift by pressing down on the rocker switch. Refer to “Other Features” section and to wheelchair lift system’s Operator’s Manual for operating instructions.

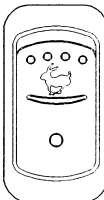

06264

Fast Idle

For extended idling periods, run the engine at fast idle. Press down the rocker switch to engage fast idle. This increases the engine speed to approximately 1,000 rpm. Return to normal idle before driving or when stopping engine.



CAUTION

Reduce the engine to normal idle before shutting the engine *off*.

NOTE

If the parking brake is released and/or the transmission is engaged with the engine running at fast idle, the engine will return to normal idle and remain there as long as the parking brake is not applied and/or transmission is not placed in neutral (N).

The engine will return to fast idle once the parking brake is applied or neutral (N) selected.

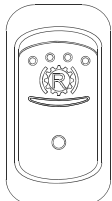

06703

Transmission Retarder

Press this rocker switch to activate the transmission retarder. Refer to "Transmission Output Retarder" in this chapter. Refer also to "Transmission Retarder" in “OTHER FEATURES” chapter.

NOTE

Deactivating the transmission retarder will turn the indicator light located at the front of the coach ON.



06265

Engine Stop Override

Press this switch then release to override the emergency engine shutdown protection. Engine emergency shutdown will be turned *OFF* for 30 seconds. This procedure can be repeated if done before 30 seconds are up.



CAUTION

Use sparingly and in order to move the vehicle to a safe parking place only. Excessive use can cause severe engine damage.

R. H. DASHBOARD PANEL

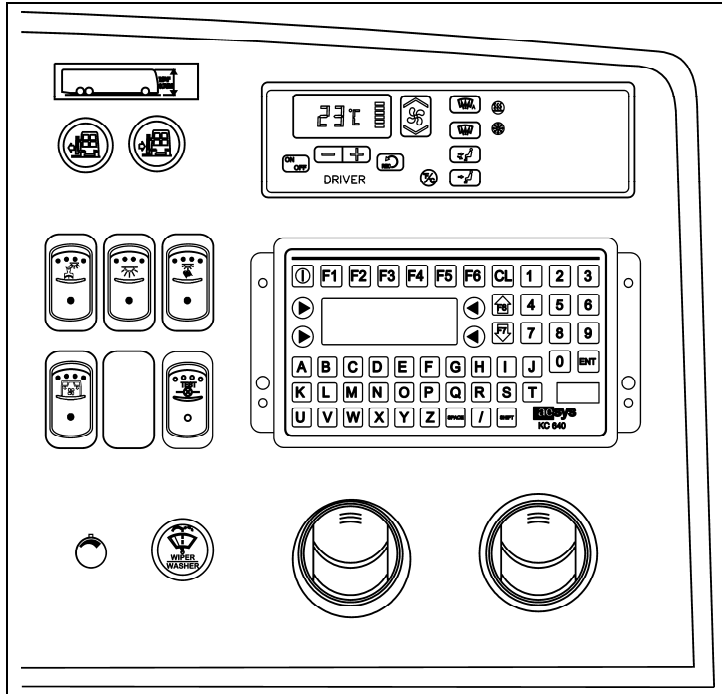

The HVAC control module, electronic destination sign control unit as well as the cluster dimmer switch, interior lighting control switches, entrance door operating buttons and miscellaneous control switches and air vents are located on the R.H. dashboard panel.

R. H. DASHBOARD PANEL

06724

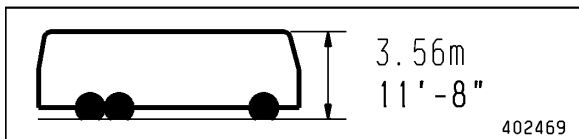

Vehicle Clearance Information

Normal vehicle clearance is 11' 8" (3,56 m).



WARNING

Vehicle clearance is higher when the ventilation hatch is open or if additional equipment is installed on the roof.



06464

Entrance Door Operating Buttons

Press the L.H. button to open the door, press and hold the R.H. button to close the door.

Entrance door takes less than 5 seconds to fully open or close.



WARNING

The door mechanism has no automatic safety protection to avoid injury to bystanders. The driver is responsible for the safe operation of the door.

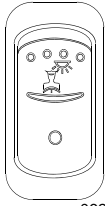

06244

Driver's Area Lighting

Press the rocker switch to illuminate the ceiling lights in the driver's area as needed.

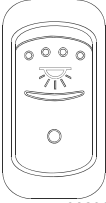

06239

Interior Lighting

Press this rocker switch to the first position to illuminate the aisle fluorescent lighting. Press down the second position to illuminate the in-station fluorescent lights.



CAUTION

To avoid running down the batteries when the engine is OFF, turn off the lights or connect the optional battery charger to a 110 - 120 volt ac power supply.

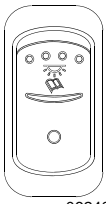

06240

Reading Lights

This switch powers the reading light circuit enabling passengers to operate their personal reading lights. Refer to "Coach Interior" chapter.

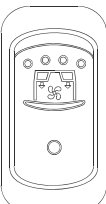

06245

Passenger Overhead Air Registers

Press the switch to the first position to set the fans to low speed. Press the switch to the second position to set the fans to high speed.



06262

LED Light Test

Press this switch while ignition is in the ON position to illuminate the LED lights. Perform this test to verify all of the LED lights in the interior of the bus. LED lights will extinguish automatically after about three seconds.



06249

Brightness Control

Adjusts the brightness of the dashboard instruments and switches.



06249

Wiper/Washer Control

Push the control to activate the windshield washer. Turn the button to activate the wipers. The first position activates the wipers intermittently. The second position is the slow speed and the third position is for high speed wiping.

DRIVER'S HVAC CONTROL UNIT

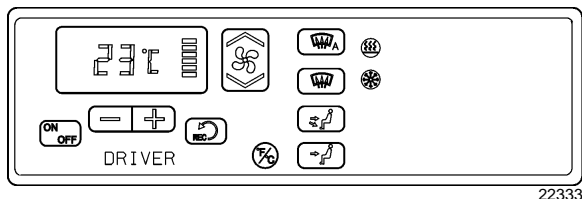

The vehicle is divided into two areas:

- 1 - Driver's area (driver's HVAC unit)
- 2 - Passengers' area (central HVAC unit)

Fresh air is fed in each area and has a separate return air and discharge air duct.

The driver's HVAC control unit is used to control heating, ventilation, air conditioning and defroster in the driver's area. The passenger's area HVAC unit (central unit) has a preset temperature of 68°F (20°) and is fully automatic. It turns on at starting of the engine. No inputs are required from the driver to control the passenger's HVAC unit.

NOTE
 To operate the air conditioning system when stationary, run engine at fast idle. When the system is running, keep roof ventilation hatch and door closed.

To prevent battery run-down, the central HVAC unit will not operate if the charging system is not working properly.

When the HVAC system is in operation, park at least 4 feet from other vehicles or buildings to allow sufficient air flow through the condenser core.

The driver's HVAC unit may be turned ON by pressing the ON/OFF button.

Also, the driver's HVAC unit turns on automatically at starting of the engine and uses the settings kept in memory before turning off of the system.

The HVAC control unit performs a self-test every time it is turned on. Codes are shown on displays or flashed on control buttons. Refer to the Maintenance Manual for more information on the diagnostic codes.

The A/C compressor starts automatically when the two following conditions are satisfied:

- 1. The outside temperature is above 32°F (0°C).

- 2. The passenger's area temperature has reached 7°F (4°C) under the set point.

NOTE
 Upon starting, if the outside temperature is above 32°F (0°C) and then drops below 32°F (0°C), the compressor will keep running up to a temperature of 15°F (-9°C) to prevent fogging up of the windows.

Heating Mode Indicator



This red LED illuminates when system is heating.

Cooling Mode Indicator



This green LED illuminates when the system is cooling (when the compressor clutch is engaged).

Fan Speed



The driver's fan has six speeds. Increase speed by pressing on the upper portion of the button, decrease by pressing on the lower portion.

Recirculate



Closes or opens the driver's and passenger's unit fresh air damper.

A red LED in the top right corner of the button illuminates when air is recirculated. Use for faster driver's section heating.

This feature is automatically cancelled when defogging is activated.

Driver's area temperature setting

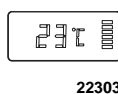

The temperature displayed on the driver's HVAC control unit is the temperature set point.

To increase the temperature set point, press on the "+" sign, to decrease the temperature set point, press on the "-" sign. Temperature range is between 60°F and 82°F (16°C to 28°C). Setting for a temperature set point above 82°F (28°C) will keep the coolant valve open and "FUL" will be displayed.

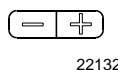

In case of interior temperature sender unit failure, the coolant valve will remain open and three lines "---" will be displayed.

 **WARNING**

Warm temperatures may cause drowsiness and affect alertness while driving. Keep the temperature comfortable but not too high.

Windshield Defogger



22305

Upon pressing this button, the dashboard damper sends air only to the lower windshield. The fan is turned on to maximum speed, the fresh air damper opens completely (REC off) and the driver set point is increased to 4°F (2°C) over the passenger's section set point.



22139

The dashboard damper sends air only to the lower windshield when activated. The footwell damper is closed also but the fan speed can be reduced or increased.

NOTE

To prevent fogging up of the windshield, the upper windshield defroster runs automatically whenever the exterior temperature is lower than 35°F (3°C).

NOTE

Upon starting of the vehicle, when the ambient temperature is very cold and so is the inside of the vehicle, the HVAC control unit will permit a temperature overshoot up to 3° over the passenger's area set point to help warming up of the area because some parts of the vehicle like the seats and the overhead compartments accumulate cold.

Panel and Footwell



22137

The dashboard damper sends air to the panel vents and footwell.

Panel

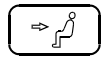

22136

Air is sent to panel registers. The footwell damper is closed.

Temperature Degree Selector



Toggles temperature units between Fahrenheit and Celsius. The HVAC control unit must be on. Also toggles

²²¹³³ the outside temperature units displayed on the telltale panel.

AIR VENTS



AIR VENT

Three adjustable driver air vents in the dashboard and one near the door feed air to the driver's compartment. Use the HVAC control panel to set air temperature and fan speed.

ELECTRONIC DESTINATION SIGN

The "aesys" destination sign is automatically activated when the ignition switch located on the dashboard is turned to the ON position.

After the program/TRX file has been successfully loaded, the user can start displaying messages or destinations on the sign by using the following keys:

- Numeric keypad — Type in the destination code number on the keypad
- <ENT>-key — Press the <ENT> key to send the message to sign
- <CL> key — Press <CL> key and press <ENT> to clear/disable all signs
- <F8> — This key starts the message list from the first message/destination entered, then counts down
- <F7> — This key starts the message list from last message/destination entered then counts up, and
- Rocker Switch — Toggle through messages to view code numbers and destinations.

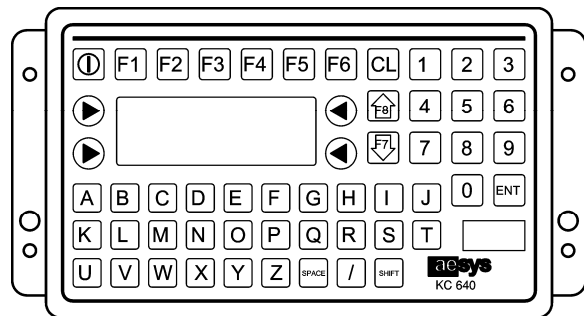

KC640 CENTRAL CONTROL UNIT

NOTE

After you select the destination or message, you must press <ENT> to transmit that data to the sign. Refer to Destination Sign Operator's manual included at the end of section 23 in Maintenance Manual for more information on programming and downloading data archive.

INSTRUMENT CLUSTER

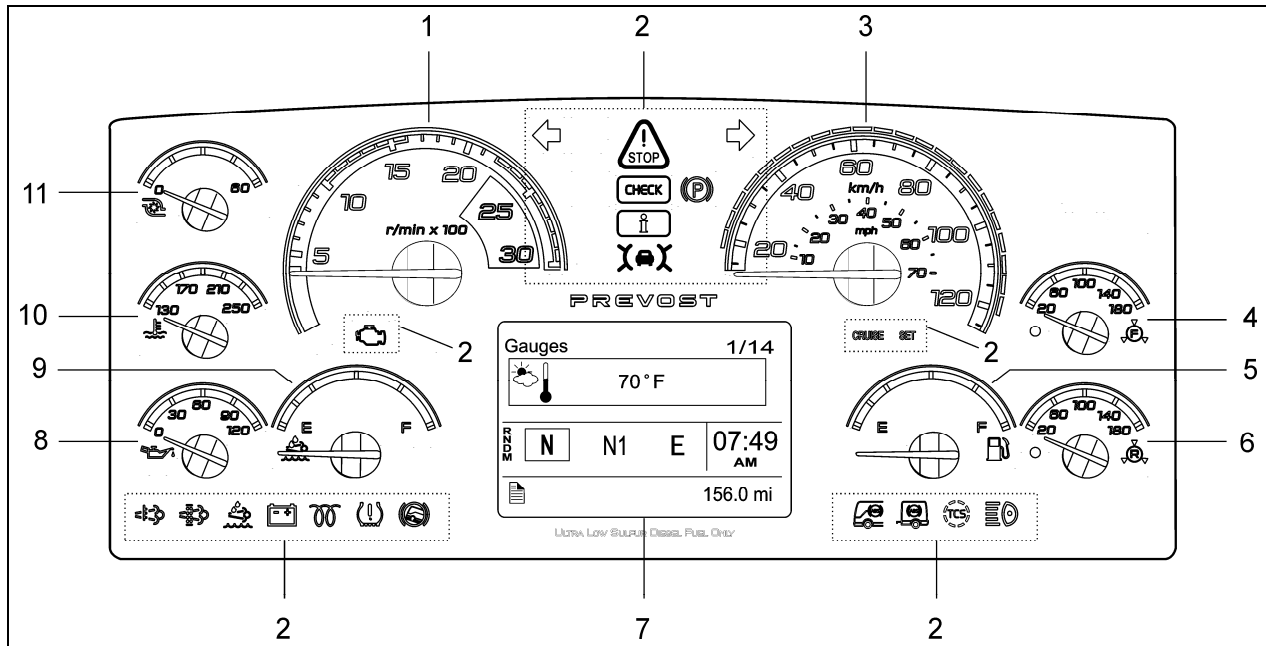

06727

- 1. Tachometer
- 2. Telltale lights
- 3. Speedometer
- 4. Front brake air pressure (secondary)
- 5. Fuel level
- 6. Rear brake air pressure (primary)
- 7. Driver Information Display (DID)
- 8. Oil pressure indicator
- 9. DEF level (Diesel Exhaust Fluid) indicator
- 10. Engine coolant temperature
- 11. Turbo boost pressure

The instrument cluster includes the analog instruments. It also presents two devices to communicate information to the driver, the telltale lights and the Driver Information Display (DID).

Indications and warnings are presented according to three levels of attention required:

1. THE TELLTALE LIGHTS

The highest level of attention. The telltale lights are temporary and exceptional; they present information critical to safety or vehicle integrity.

2. THE POP-UP MESSAGES

The second level of attention. The pop-up messages appear in the Driver Information Display DID without the driver's intervention and acknowledgement. Pop-up messages present supplemental information to the driver.

3. THE STATUS LINE

The lowest level of attention. The status line monitors certain systems and gives feedback to the driver concerning current actions and functions.

ANALOG INDICATORS

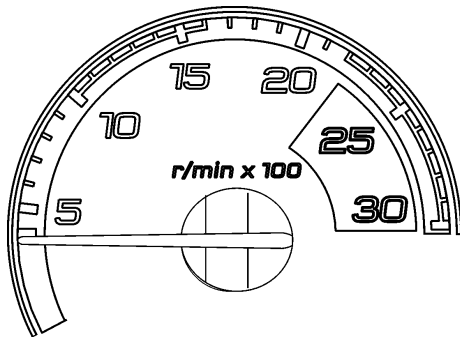

06728

Tachometer (rpm x 100)

Indicates the operating speed of the engine in hundreds of revolutions per minute. The tachometer serves as a guide for gear shifting and helps to prevent engine over-speeding when driving downhill with the engine brake operating. Use the green field for normal driving (1000 to 1600 rpm).

	<p>CAUTION</p>
<p>Never allow the engine to go into the red field. This could lead to severe engine damage.</p>	

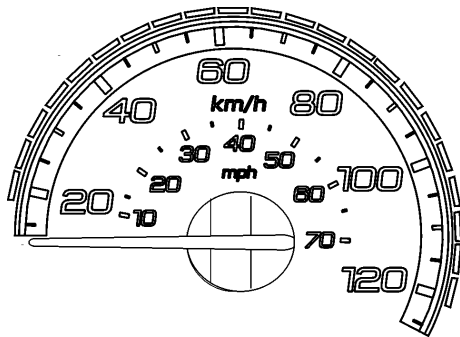

06729

Speedometer (mph, km/h)

Indicates the vehicle speed in miles per hour (mph) and kilometers per hour (km/h).

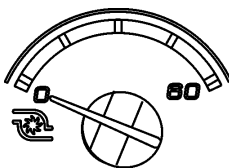

06730

Turbo boost pressure (psi)

Indicates the turbo boost pressure in psi. This pressure should be the same at a given engine temperature, speed, and load. An unusual reading could indicate an engine failure.

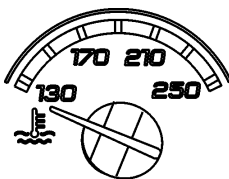

06731

Engine coolant temperature (°f)

Indicates the operating temperature of the engine coolant in °f. The normal reading should be between 170°f and 222°f (80°c to 106°c).

The temperature limit is dependent on the electronic program for the engine model. When coolant temperature is excessive, the stop telltale light turns on, an audible alarm sounds and a pop-up message appears on the DID. If the engine is at risk, the EECU may decrease the engine power. Stop at the first safe place where the problem can be checked.

If the temperature remains below or exceeds the normal temperature range, the cooling system should be checked for problems.



Stop telltale light

Engine Oil Pressure (Psi)

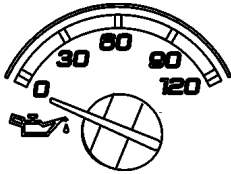

06732

Indicates the engine oil pressure in psi. When the oil pressure is too low, the stop telltale light turns on, an audible alarm sounds and a message appears on the DID. If the engine is at risk, the EECU may decrease the engine power. Bring the vehicle to a safe stop where the problem can be checked.



STOP telltale light



OIL PRESSURE pictogram

	WARNING
<p>Failure to take necessary action when the stop telltale light is on can ultimately result in automatic engine shutdown and loss of power steering assist. Vehicle crash can occur, resulting in severe personal injuries.</p>	

Front Brake Air Pressure (Psi)

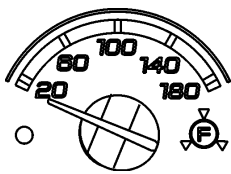

06737

Indicates the front brake air system pressure in psi. The normal operating pressure is from 95 to 125 psi.

A low air pressure indicator led illuminates when the front (secondary) air system pressure drops below 66 psi. If the air pressure drops below 60 psi, the stop telltale light will turn on, an audible alarm will sound and a message will appear on the DID. If the air pressure drops below 40 psi, the emergency spring brake applies at full capacity.

	WARNING
<p>Do not drive the coach when the brake air pressure is low.</p>	

<p>NOTE</p> <p>Do not refer to dashboard instruments during adjustment procedures. Use only calibrated gauges.</p>

Rear Brake Air Pressure (Psi)

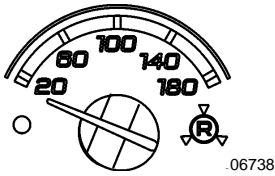

Indicates the rear brake air system pressure in psi. The normal operating pressure is from 95 to 125 psi.

A low air pressure indicator led illuminates when the rear (primary) air system pressure drops below 66 psi. If the air pressure drops below 60 psi, the stop telltale light will turn on, an audible alarm will sound and a message will appear in the did. If the air pressure drops below 40 psi, the emergency spring brake applies at full capacity.



STOP telltale light

 WARNING
Do not drive the coach when the brake air pressure is low.

DEF level

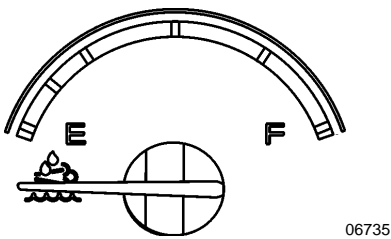

Indicates the amount of DEF (diesel exhaust fluid) remaining in the DEF tank. The DEF tank is considered as being full when it contains 16 gallons (60 liters) of DEF. DEF consumption will be approximately 2% of the diesel fuel consumed.

 CAUTION
DEF will begin to crystallize and freeze at 12°F (-11°C). DEF expands by approximately 7% when frozen. In order to permit DEF expansion without causing damages to the DEF tank, do not fill the DEF tank with more than 16 gallons (60 liters).

Fuel Level

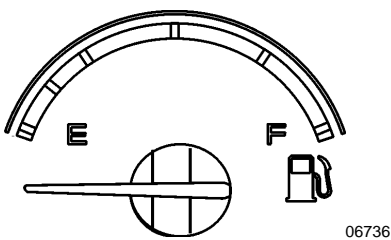

Indicates the amount of fuel remaining in the fuel tank. At the beginning of the red area, there is approximately 48 gallons (182 liters) left in the tank.

NOTE
A pop-up message will appear in the DID informing that there is only 24 gallons (92 liters) left in the fuel tank.

TELLTALE LIGHTS

The telltale lights illuminate during 5 seconds at the start of every ignition cycle as a light bulb check.



STOP

Indicates that a serious problem has been detected. Immediately park the coach in a safe place and stop the engine. This telltale light may be accompanied with a message in the DID and a diagnostic troubleshooting code will be stored to ease identification of the problem.



CHECK

Indicates that a problem has been detected and must be checked at the next stop. This telltale light may be accompanied with a message in the DID and a diagnostic troubleshooting code will be stored to ease identification of the problem.



INFORMATION

This telltale light illuminates when there is a new information message or an abnormal status is detected by the electronic control unit. A pictogram, text or both are shown in the DID in addition to the info telltale light. Make sure the indicated fault is checked at the next stop.



TURN SIGNAL INDICATORS

Flashes when the right or left turn signals are activated. Signal right and left turns by operating the foot control switches. See “Foot Operated Controls” in this chapter.

NOTE
The turn signals are automatically activated when the vehicle is backing up.



PARKING BRAKE OR EMERGENCY BRAKE APPLIED

Illuminates when the emergency/parking brake is applied. The control valve is located on the L.H. control panel. An audible alert will sound if ignition is turned to off and the parking brake is not engaged.



AFTERTREATMENT SYSTEM MALFUNCTION (MALFUNCTION INDICATOR LAMP)

Indicates a failure of an emission control device. May illuminate at the same time as the CHECK amber warning light. The lamp will go out after 3 completed *ignition on-ride-ignition off* cycles. Vehicle can be driven to end of shift. Call for service.



HIGH EXHAUST SYSTEM TEMPERATURE (HEST)

Illuminates to notify the driver of potentially hazardous exhaust gas temperature at the exhaust system diffuser.

06740_A

WARNING

During regeneration, exhaust temperature may reach up to 1200°f (650°c) at the particulate filter. When parking the vehicle, if this telltale light is illuminating, make sure that the exhaust system diffuser is away from people or any flammable materials, vapors or structures.



06740_B

DPF REGENERATION REQUEST

Illuminates to notify the driver that a manual stationary regeneration will be required soon. Refer to "Exhaust Aftertreatment System" paragraph in *Other Features* chapter.



06740_C

Low DEF level

Illuminates when there is less than 2.6 gallons (10 liters) of DEF left in the tank.

**CAUTION**

This telltale light starts flashing when there is only 2.5 liters (0.6 gallons) left in the tank.

If the vehicle is kept in operation with an empty DEF tank, and engine derate will eventually occur, limiting the speed to 5 mph.



06740_D

ALTERNATORS

Indicates an alternator problem. One of the alternators is not charging.

NOTE

To identify which alternator is defective (1=lower alternator, 2=upper alternator), perform a system diagnostic using the driver information display DIAGNOSTICS menu. Select VIEW ACTIVE FAULTS and then ELECTRICAL SYSTEM. Scroll through the active faults. The electrical system active faults will appear. A diagnostic message indicating "alternator 1" or "alternator 2" with failure mode "open circuit" will come in sight.

**INTAKE AIR PREHEATER ON – WAIT BEFORE STARTING**

Illuminates when the intake air preheater element is in function. Wait until this telltale light has turned off before starting the engine. For more information on this feature, refer to paragraph "Cold Weather Starting" in Starting And Stopping Procedures chapter.



06740_G

HILL START ASSIST

Indicates a malfunction of the hill start assist function. This function might not be available.



06740_H

ANTILOCK BRAKE SYSTEM (ABS)

Illuminates when the ABS is not available or when the ABS is malfunctioning. Since the ABS system does not operate at less than 4 mph (7 km/h), the indicator will remain illuminated until the coach reaches that speed. Refer to *Other Features* chapter.



06740_K

HIGH BEAM

Illuminates when the high beams are selected. High and low beams are selected with the foot operated controls. Refer to "Foot Operated Controls" paragraph in this chapter.

STOP, CHECK and INFORMATION telltale lights

STOP, CHECK and INFORMATION telltale lights illuminate automatically to draw the attention of the driver and their associated messages are displayed in the DID. More than one message (see “Acknowledging Messages” below) can be active at the same time. A displayed message can be replaced by a new message provided the new message has a higher priority. Only fault codes that have a direct impact on vehicle operation are displayed. All fault codes are stored in the appropriate ECU for access by service technicians.

STOP Telltale light

In the event of a serious fault, the red STOP telltale light comes on and an audible alarm will sound if the engine is running. An illuminated stop message light indicates a serious problem has been detected, and the driver must respond immediately to the problem.



When illuminating, this telltale light means the vehicle must be safely pulled off the road and stopped. In some instances, the engine must be switched off immediately.

	<p>WARNING</p>
<p>Failure to stop and take necessary action when the stop telltale light is on can result in automatic engine shutdown and loss of power steering assist. This can result in vehicle accident and severe personal injuries.</p>	

In some cases preventive action may be taken by the engine ECU to protect the engine, for example:

- 1- If oil pressure or coolant level drop too low, the engine is forced to low idle and when the vehicle speed is zero, the engine shuts down.
- 2- With excessive coolant temperature, the engine will gradually reduce power output to 50%. This telltale light always activates an audible alarm.

After the automatic engine shutdown sequence, the engine may be restarted after the key is turned off and then back on. However, it will only operate for 30 seconds unless the problem is resolved. The Engine Stop Override switch can be used to override the automatic engine shutdown protection. The automatic engine emergency shutdown will be turned OFF for 30 seconds. This procedure can be repeated if done before the 30 seconds are up. Use this function sparingly and in order to move the vehicle to a safe parking place only.

CHECK Telltale light

This telltale light means that a fault or an abnormal operating condition has been detected. The vehicle must be checked at the next stop.



If the CHECK telltale light illuminates, an associated message is displayed in the DID. Always pay attention to the associated messages (see “Acknowledging Messages” below).

INFORMATION Telltale light

The INFO indicator light comes on when there is a new information message or an abnormal status is detected by the electronic control unit. A pictogram or text or both are shown in the DID in addition to the INFO telltale light (see “Acknowledging Messages” below).



Acknowledging Messages

A fault message associated to a STOP, CHECK or INFORMATION telltale light must be acknowledged by pressing the ESCAPE or ENTER button after which the display returns to the same status that existed before the fault occurred. All messages can be acknowledged. Acknowledged but inactive messages are displayed again when the ignition key is turned to the START position or they can be read in the DID menu. Refer to *Other Features* for more information on the DID menus.

DRIVER INFORMATION DISPLAY

The DID (Driver Information Display) is located in the center of the instrument cluster. It displays digital gauges, main menus and sub-menus that provide necessary and important information to the driver. The information available to the driver depends on vehicle configuration, and whether the vehicle is in operation or parked. For the list of the available menus and sub-menus, refer to "Driver Information Display Menus" in *Other Features* chapter.

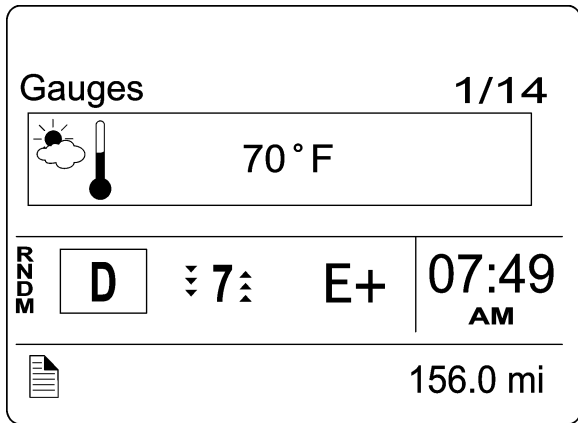

06746

The outside air temperature, fuel flow and the odometer (Allison transmission) are part of the default display. You can replace the default display by your selection of favorite gauges using the Driver Information Display sub-menu Favorite Display Setting. Refer to *Other Features* chapter for more information.

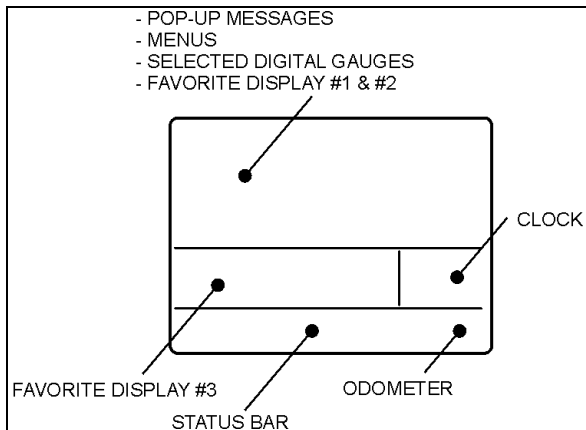

06742

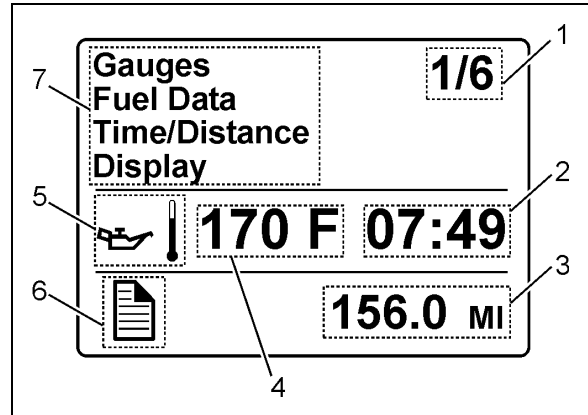

06743



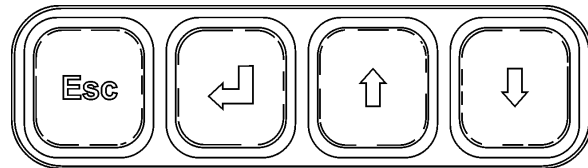

1. Indicates first of six available menus (varies by menu)
2. Clock
3. Odometer
4. Value or data (in this example, the engine oil temperature)
5. Pictogram relevant to the displayed value or data
6. Status bar active pictogram
7. Messages or available menus

Selecting a menu

Menus are placed in a cascade arrangement. Use the Driver Information Display (DID) keyboard to scroll through them.





To select a menu:

1. Press the  or **ESC** button to display the list of available menus.
2. Use the  /  button to scroll up or down through the menus.
3. Use the  button to open a menu.
4. Use the **ESC** button to return to the previous menu or display or to cancel a setting or operation.

To change settings

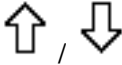
To change a setting, like the clock for example:

5. Use the  button to increase or decrease the numerical value of the selected field.
6. Use the  button to confirm your choice and to move to the next field.
7. Press the  button to return to the previous field or to cancel a setting or operation.

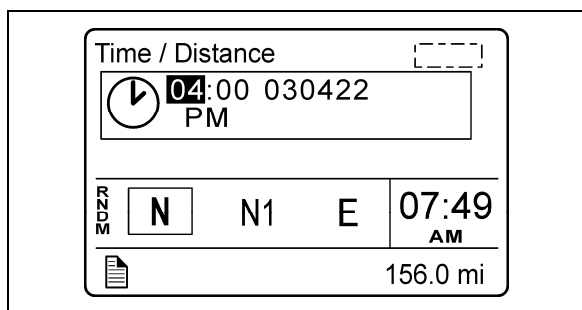







06743









PICTOGRAMS displayed on the driver information display (DID)

NOTE

In certain situations, the pictogram displayed represents a system or a function of the vehicle. A particular pictogram may be displayed with different messages. In that situation, it is very important to pay attention to the message displayed with the pictogram.

Warning pictograms, pop-up message pictograms, verifications and information pictograms

DRIVER INFORMATION DISPLAY “GAUGES” MENU PICTOGRAMS	
Pictogram	Description
	Engine oil temperature
	Outside air temperature
 A/C	A/C compressor pressure This pictogram is displayed with A/C compressor suction pressure value (low side) and discharge pressure value (high side).
	Accessories air pressure Normal pressure should be between 95 and 125 psi.
	Voltmeter This pictogram is displayed with both the 12-volt and 24-volt electrical system current voltage value. When the engine is running, the 24-volt electrical system voltage value should be between 26,5 et 28,0 volts.
	Transmission oil temperature

POP-UP MESSAGES			
Pictogram	Description		
	High engine oil temperature		
	Engine coolant temperature		
	Engine oil pressure		
	Intake air preheater failure		
	High transmission oil temperature This pictogram indicates that the transmission oil temperature is too high. Turn the transmission retarder off to allow the oil to cool down.		
	Allison transmission– oil or filter replacement required This pictogram may be displayed with many different messages. Pay attention to the displayed message which can advise that the transmission oil or filter change is necessary. Refer to Appendix C for more information on the Allison transmission prognostic features (oil life monitor, filter life monitor, transmission health monitor).		
	Low brake or ABS air pressure		
	A/C system pressure high This pictogram indicates that the A/C system pressure is too high. If the A/C pressure is too high, the compressor clutch is disengaged, but the fan remains activated. <table border="1" data-bbox="414 1417 1412 1533"> <tr> <td><i>NOTE</i></td> </tr> <tr> <td>When outside temperature is high, it is possible and normal for that pictogram to appear.</td> </tr> </table>	<i>NOTE</i>	When outside temperature is high, it is possible and normal for that pictogram to appear.
<i>NOTE</i>			
When outside temperature is high, it is possible and normal for that pictogram to appear.			
	A/C system pressure low This pictogram indicates that the A/C system pressure is too low. If the A/C pressure is too low, the compressor clutch disengages and the fan stops. <table border="1" data-bbox="414 1732 1412 1858"> <tr> <td><i>NOTE</i></td> </tr> <tr> <td>When outside temperature is low, it is possible and normal for that pictogram to appear.</td> </tr> </table>	<i>NOTE</i>	When outside temperature is low, it is possible and normal for that pictogram to appear.
<i>NOTE</i>			
When outside temperature is low, it is possible and normal for that pictogram to appear.			



Battery voltage warning

This pictogram indicates that the battery voltage is too high, too low or the 12-volts/24-volts battery arrangement is not equalized.

The value LOW or HIGH is displayed at the right of the pictogram to indicate if the voltage is too low or too high.

NOTE

This pictogram will illuminate for a few seconds after the engine is started because of the voltage drop when the starter is engaged.

NOTE

To identify the battery problem (too high, too low or not equalized voltage), using the DID menus, perform a system diagnostic by selecting DIAGNOSTICS, VIEW ACTIVE FAULTS, ELECTRICAL SYSTEM and see the fault messages.

NOTE

To prevent discharge of the batteries when the engine is not running, some functions are automatically switched off if the batteries voltage drops below 24.0 volts for more than 30 seconds. Set the ignition key to the OFF position and then turn the ignition key to the ON position to reactivate the functions for a period of 30 seconds before they switch off again.

NOTE

If the battery equalizer indicator illuminates, make sure that the battery equalizer circuit breakers are reset before requesting breakdown assistance. Wait 15 minutes after setting breakers to allow batteries to equalize. The breakers are located on the rear junction panel, on the engine compartment R.H. side.



Engine door ajar

This pictogram indicates that the engine compartment door is ajar.



Emergency window open

This pictogram indicates that an emergency window is open or unlocked.



Baggage compartment door ajar

This pictogram indicates that one or more baggage bay doors are ajar.



Low windshield washer fluid level

Illuminates when the windshield washer fluid level is low. The washer fluid container is located inside the front service compartment.



WARNING

Do not drive without sufficient washer fluid.



Wheelchair lift

This pictogram indicates that the wheelchair lift system is enabled and the wheelchair access door or the lift compartment door is open. It is necessary to stow the wheelchair lift, close the doors and set the wheelchair lift system enable switch to the off position to permit release of the parking brake.



Freezing conditions

This pictogram appears when the temperature is in the range between 0°C and 2°C (32°F et 35°F), when the road is most slippery.



Fuel level

This pictogram appears when approximately 24 us gallons (92 liters) of fuel remains in the tank. Refuel as soon as possible.



Parking brake applied



Dpf regeneration



High exhaust gas temperature

This pictogram appears to notify the driver of potentially hazardous exhaust gas temperature at the DPF outlet.

	<p>WARNING</p>
<p>During regeneration, exhaust temperature may reach up to 1200°F (650°C) at the particulate filter. When parking the vehicle, if this pictogram is displayed, make sure that the DPF outlet diffuser is away from people or any flammable materials, vapors or structures.</p>	



Fuel economy

This pictogram is displayed with fuel consumption value of the vehicle. Proper units for the displayed value are written under the pictogram: liters/100km, km/liter, mpg, liters/hour.



Leg fuel consumption

This pictogram is displayed with the value for the fuel consumption for the current leg.



Trip data

Function of the DID's "Time/Distance" menu. Refer to "Driver Information Display Menus" in *Other Features* chapter.



Estimated time of arrival

Function of the DID's "Time/Distance" menu. Refer to "Driver Information Display Menus" in *Other Features* chapter.



Fuel filter/water separator

Indicates that the draining the fuel filter/water separator is required. See *Care And Maintenance* chapter.



Raised tag axle

This pictogram appears if the vehicle speed exceeds 12 mph (20 km/h) while the tag axle is raised.



Kneeling

This pictogram appears if the vehicle speed exceeds 12 mph (20 km/h) while the front suspension of the vehicle (kneeling) is lowered.



Fire in engine compartment

This pictogram appears if a fire is detected in the engine compartment while the vehicle is on the road. An audible alarm informs the driver when a fire is detected. In case of fire detection when parked (parking brake applied, engine running or not), the electric horn is activated to alert the driver. Refer to *Safety Features And Equipment* chapter.



WARNING

In case of a fire, stop the vehicle immediately, stop the engine and evacuate the vehicle.

NOTE

It is possible to cancel an alarm while on the road. To do so, stop the vehicle. Cycle the ignition between the ON and OFF position and then start the vehicle normally. This can be done on a temporary basis when a false alarm is activated by a defective fire detector. The driver can go on without being annoyed by the alarm.







NOTE

To stop the electric horn alarm when parked, cycle the ignition between the ON and OFF position twice within 3 seconds.

NOTE

For extinguisher's location, refer to SAFETY FEATURES AND EQUIPMENT chapter.

Status Line Pictograms

Pictogram	Description
	Message active
	Alarm clock activated
	Raised tag axle
	Kneeling/front suspension active Indicates that the front suspension is lowered (kneeling).
	Allison transmission retarder Confirms that the Allison transmission retarder is OFF.
	Allison transmission retarder Confirms that the transmission retarder is ON. Refer to "Transmission Retarder" heading in this chapter.

HORN

The electric horn is operated from the steering wheel center pad or from the foot-operated switch.

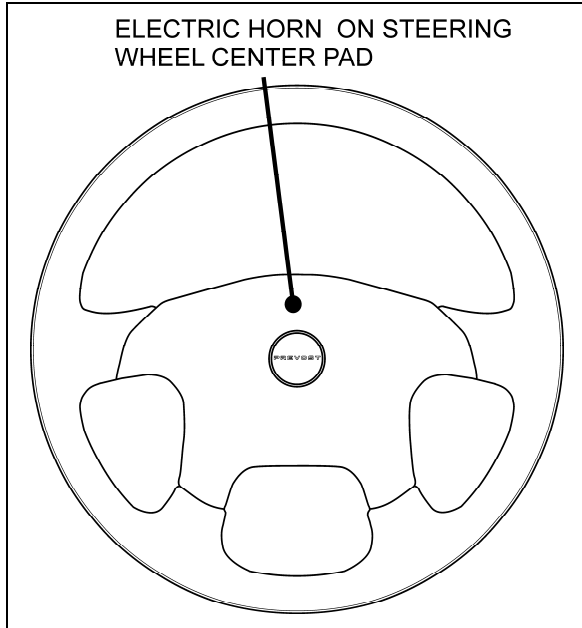

STEERING WHEEL

NOTE

When the vehicle is stationary, the electric horn will sound to inform the driver that a fire is detected in the engine compartment.

TRANSMISSION OUTPUT RETARDER

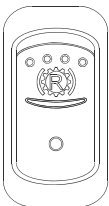

To use the transmission retarder, it must be activated first by pressing the switch located on the L.H. dashboard panel.

NOTE

Deactivating the transmission retarder will turn the indicator light located at the front of the coach ON.

With the retarder enabled, depressing the brake pedal will engage both the service brake and the transmission retarder. This is referred to as retarder-brake blending. The further the pedal is depressed, the more total braking power is provided. Refer to "OTHER FEATURES" chapter for further information about the transmission retarder.

NOTE

If the wheels start to lock up on slippery roads, the output retarder will automatically deactivate until the wheels start to turn.

FOOT-OPERATED CONTROLS

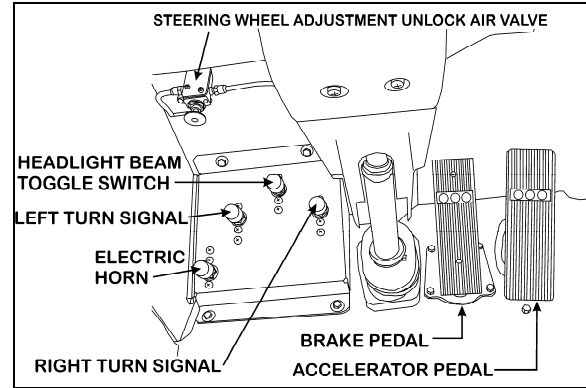

FOOT-OPERATED CONTROLS

00023A

HEADLIGHT BEAM TOGGLE SWITCH

Toggle between high and low beams by pressing the foot-operated switch.

LEFT TURN SIGNAL SWITCH

Press the foot-operated switch to signal a left turn. Press again to stop the signal.

RIGHT TURN SIGNAL SWITCH

Press the foot-operated switch to signal a right turn. Press again to stop the signal.

ELECTRIC HORN

Press the foot-operated switch to activate the electric horn (city horn).

PANIC BUTTON SWITCH

Press the foot-operated panic switch to signal an emergency and ask for immediate assistance. A warning message will be displayed on all exterior destination signs.

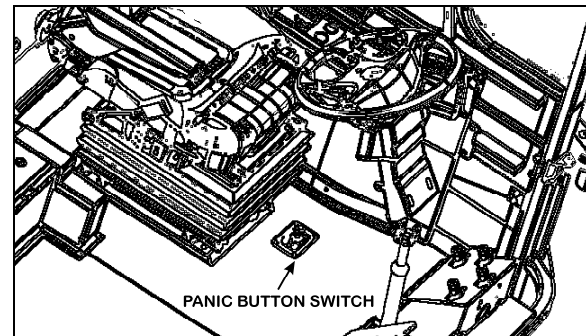

PANIC BUTTON SWITCH

BRAKE PEDAL

The coach is equipped with a dual braking system. The front brakes operate from a different air pressure source from the drive and tag axle brakes. The dual braking system becomes a modulated emergency system if a pressure drop occurs in the primary brake system.

Service brakes are applied by depressing the brake pedal. Braking increases with the amount of pressure applied to the foot pedal. Refer to Other Features chapter under Antilock Braking System. When the brake pedal is depressed, the brake lights turn *ON* automatically.

For safe and effective braking, the air system pressure should reach at least 95 psi (655 kPa) in both the primary and secondary circuits. A warning light and an audible alert will sound when the air pressure in either the primary or secondary circuits drops below 66 psi (455 kPa). If this occurs, stop the coach; determine the cause of the pressure loss before proceeding. The brake pedal can be used in conjunction with the transmission retarder. Refer to Transmission Output Retarder in this chapter.

 DANGER
<p>Immediately report any brake system problem to your company or directly to the nearest Prevost or Prevost-approved service center.</p> <p>Do not "fan" or "pump" the brake pedal. This practice does not increase brake system effectiveness but rather reduces system air pressure thereby causing reduced braking effectiveness.</p>

 CAUTION
<p>"Riding" the brake by resting one's foot on the brake pedal when not braking can cause abnormally high brake temperature, can damage and cause premature wear of brake components and reduce brake effectiveness.</p>

ACCELERATOR PEDAL

Controls engine RPM as needed.

<p><i>NOTE</i></p> <p><i>The accelerator pedal will not operate when the entrance door is open.</i></p>

ALLISON AUTOMATIC TRANSMISSION

The transmission is fully automatic: Proper ranges should be automatically selected according to driving speeds to improve vehicle performance and control. The speed ratio of the power converter changes automatically as vehicle speed increases and direct-drive goes in and out as necessary. The speed ratio is modulated by vehicle speed and accelerator pedal position. You will find the complete transmission operation instructions and driving tips in the **Allison Bus Series Operator's Manual** included in your vehicle's publication box.

OPERATION

When a button is depressed on the transmission control pad, the corresponding letter or number is displayed indicating the transmission is ready to operate in the selected range. If the transmission control module (TCM) detects a serious problem in the transmission, the "CHECK" telltale light will illuminate on the dashboard.

PUSHBUTTON SHIFT SELECTOR

The pushbutton shift selector has the following elements:

R (Reverse) — Press this button to select Reverse.

N (Neutral) — Press this button to select Neutral.

D (Drive) — Press this button to select Drive. The highest forward range available will appear in the digital display window under SELECT. The transmission will start out in the lowest available forward range, displayed under MONITOR, and advance automatically to the highest range.

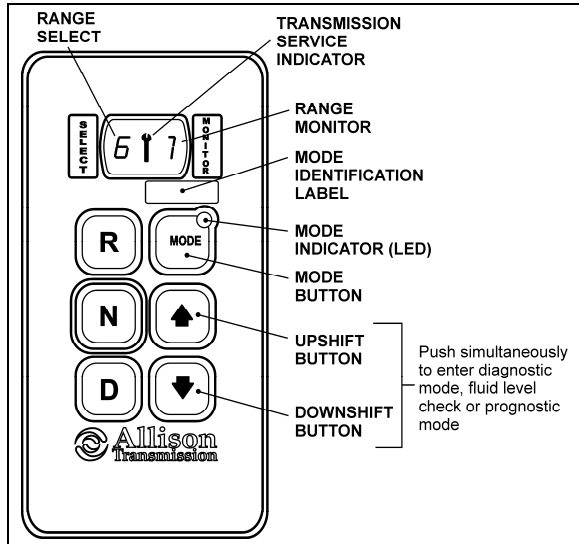

ALLISON PUSHBUTTON SHIFT SELECTOR 07134

▲ ▼ — Press respectively the ▲ (Upshift) or ▼ (Downshift) arrow button when in DRIVE to request the next higher or lower range. One press changes gears by one range. If the button is held down, the selection will scroll up or down until the button is released or until the highest or lowest possible range is selected. Protection mechanisms inhibit selecting ranges that are not appropriate for the current speed or which may damage driveline components.

MODE — The MODE button can allow the driver to enable a secondary shift mode that has been programmed into the TCM unit. The name of the secondary mode appears on the MODE IDENTIFICATION label adjacent to the MODE button. Pressing the MODE button activates the PERFORMANCE shift schedule and illuminates the mode indicator (LED).

NOTE

When the diagnostic display mode has been entered, the mode button is used to view and toggle through diagnostic code information. Refer to appendix C for more details about **diagnostic code display procedure** and **fluid level check** using the pushbutton shift selector.

Functions of The “Mode” Button

Both ECONOMY (default mode at starting of the engine) and PERFORMANCE (secondary shift mode) modes are equivalent from the first to the fourth gear as the transmission upshifts at around 2000 rpm.

The ECONOMY mode allows for upshifts in fifth and sixth gear at around 1700 rpm. This is a more efficient operation of the transmission and thereby helps improve fuel economy.

The PERFORMANCE mode keeps upshifts at 2000 rpm in fifth and sixth gears. This makes for better performance than the economy mode but with higher fuel consumption. It is recommended this mode be selected while driving up or down grades. The mode indicator (LED) is illuminating when PERFORMANCE mode is selected.

TRANSMISSION SERVICE INDICATOR

ⓘ — This indicator will be illuminated upon the detection of a service issue relating to clutch, filter or fluid life. The appearance of the indicator (lit steadily, flashing, etc.) varies for each of the conditions monitored by the system. Refer to appendix C for more details about **diagnostic code display procedure, fluid level check or prognostic features** (Oil Life Monitor, Filter Life Monitor and Transmission Health Monitor) using the pushbutton shift selector.

Illuminated at startup for a bulb check, this indicator will then be turned off if no service conditions exist.

DESCRIPTION OF AVAILABLE RANGES

R (Reverse)

Press the «R» button to select reverse. Completely stop the vehicle and let the engine return to idle before shifting from forward range «D» to reverse «R» or from reverse to forward range. The reverse warning signal will be activated when this range is selected.

N (Neutral)

Use this position to start engine. Select «N» (Neutral) when checking vehicle accessories and for extended periods of engine idle operation; parking brake must then be applied. The pushbutton shifter will automatically select «N» (Neutral) when the ignition switch is turned ON.

NOTE

The automatic transmission does not have a park «P» position. Select «N» (neutral) and apply parking brake when the vehicle is left unattended. An audible alert will sound if the engine is stopped and the parking brake is not applied.

 **DANGER**

Always apply parking brake and put the transmission in NEUTRAL before leaving driver's seat.

 **CAUTION**

Volvo diesel engines should not be idled for extended periods at "slow" idle. For extended idling, engine should run at "fast" idle.

 **DANGER**

The vehicle service brakes or park brake must be applied whenever NEUTRAL is selected to prevent unexpected vehicle movement.

 **CAUTION**

Do not allow your vehicle to "coast" in neutral «N». This practice can result in transmission damage. Also, no engine braking is available in neutral.

D (Drive)

Use this position for all normal driving conditions. After touching this pad, the vehicle will start in first or second range and will automatically upshift to a higher range as output speed increases. As the vehicle slows down, output speed decreases, the transmission automatically downshifts to the correct range. If a locked brake or a slick surface condition should occur, the TCM (Transmission Control Module) will command converter operation (disconnect lockup) and inhibit downshifts for a period of time or until normal wheel speed has been restored.

IMPORTANT NOTE

Brake pedal must be applied when selecting «D» (Drive) otherwise the transmission will stay in «N» (Neutral).

NOTE

The transmission should normally be allowed to shift by itself, but manual shifting can be done as described below.

1 (First range)

Select this range when pulling through mud and snow, when speed control is needed for driving up or down steep grades or when maneuvering in tight spaces. This range also provides maximum driving torque and engine braking power or retarder braking effect. In the lower ranges (1, 2, 3 and 4), the transmission will not upshift above the highest gear selected unless engine overspeed is detected.

2 (Second range)

Select this range when operating in heavy and congested traffic. The transmission will start in first and automatically upshift to second. When slowing, the transmission will automatically downshift to first range. Low ranges provide progressively greater engine and retarder braking power (the lower the range, the greater the engine and retarder braking effect).

3, 4 (Third and fourth ranges)

Select these ranges when driving on moderate grades or when load and traffic conditions limit speed.

 **WARNING**

Service brake should not be used to control the speed of vehicle on long, steep descents. Instead, lower transmission ranges should be used (in conjunction with output retarder. Refer to "Engine Brake" and "Transmission retarder" headings in "Other Features" chapter for details regarding both systems. This procedure keeps service brake cool and ready for emergency stopping.

 **CAUTION**

When descending in lower ranges, care must be taken that engine speed does not exceed 2,450 rpm.

EXHAUST AFTERTREATMENT SYSTEM.....	58
FILTRATION AND REGENERATION UNIT	58
SELECTIVE CATALYTIC REDUCTION UNIT	60
DEF TANK LEVEL – DRIVER WARNING AND INDUCEMENT	62
DEF QUALITY – DRIVER WARNING AND INDUCEMENT	63
SCR SYSTEM TAMPERING – DRIVER WARNING AND INDUCEMENT	64
DRIVER INFORMATION DISPLAY (DID) MENUS.....	65
DRIVING MODE MENU	65
GAUGES	65
FUEL DATA.....	66
TIME / DISTANCE.....	67
VEHICLE MESSAGES	68
RESET TRIP DATA.....	68
NON-DRIVING/STATIONARY MODE MENUS	68
DISPLAY SETTINGS	68
DIAGNOSTICS.....	69
PRE-TRIP ASSISTANT.....	70
DATA LOG	71
AFTERTREATMENT.....	72
PASSWORD	73
TRANSMISSION RETARDER	73
ANTILOCK BRAKING SYSTEM (ABS).....	74
KNEELING SYSTEM.....	74
UNLOADING TAG AXLE	75
RETRACTABLE TAG AXLE.....	75
IN-STATION LIGHTING	75
WHEELCHAIR LIFT SYSTEM	75
WHEELCHAIR LIFT AND ACCESS DOORS.....	75
OPERATING THE WHEELCHAIR LIFT	76
THRESHOLD WARNING SYSTEM (TWS) ADJUSTMENT	77
INTERIOR APPOINTMENTS.....	78
EMERGENCY OPERATION	81
WHEELCHAIR LIFT REMOVAL FOR STORING OR MAINTENANCE PURPOSES.....	82
WHEELCHAIR LIFT INSTALLATION.....	82

EXHAUST AFTERTREATMENT SYSTEM

The exhaust aftertreatment system consists of two units, the filtration and regeneration unit and the selective catalytic reduction SCR unit.

FILTRATION AND REGENERATION UNIT

The aftertreatment system primary function is to capture and oxidize (regenerate) the particulate matter (soot) in the engine exhaust gases and to reduce NOx. To achieve this goal, the exhaust aftertreatment system is split into two main sections: the exhaust gases first enter the **Diesel Oxidation Catalyst (DOC)** and **Diesel Particulate Filter (DPF)** assembly to capture and regenerate the soot on a regular or passive basis, then the exhaust gases flow through the **catalytic converter** to reduce NOx to minimum level. Through constant monitoring of the exhaust gas temperature and the system back pressure, EMS is able to manage regeneration.

Passive regeneration







Passive regeneration is the process by which the particulate matter is oxidized due to the heat generated by the engine internal combustion process. During normal highway operation, exhaust temperatures alone are usually high enough to oxidize accumulating soot. In low ambient temperatures, however, or in some stop-and-go applications, the system needs a little help to regenerate, or clean itself. This process is called "Extended heat Mode".

Stationary (parked) regeneration

In a small number of specific engine duty cycles, engine control module may not be capable of completing a regeneration through the "Extended heat Mode". In these situations, the operator will be notified that a stationary or parked regeneration may be required. A DPF telltale light will illuminate indicating the need for user interaction. The lamp gives the operator a grace period to allow this process to take place at a time when most convenient for the operator. This process requires the vehicle to be parked while a driver or maintenance technician initiates the regeneration process using the DID menus. Once initiated, the stationary regeneration process will be complete in about 45 minutes.

The driver will be notified of the need for a stationary regeneration (parked) by illumination of the DPF REGENERATION telltale light.

Diesel particulate filter clogging sequence – Instrument cluster telltale light

<p>LEVEL 1</p>	 solid	<p>REGENERATION NEEDED</p> <p><i>Diesel particulate filter is becoming full</i></p> <p><i>The DPF REGENERATION telltale light illuminates to notify the driver that a stationary regeneration (parked) will be required soon. When this lamp is lit, initiate stationary regeneration process at an appropriate time of day. THERE IS NO URGENCY AT THIS LEVEL.</i></p>
<p>LEVEL 2</p>	 flashing	<p>REGENERATION REQUIRED</p> <p><i>Diesel particulate filter full</i></p> <p><i>If no DPF regeneration occurs after the initial DPF REGENERATION telltale light illumination, the lamp will begin blinking and a stationary regeneration should be initiated as soon as possible in order to prevent from entering into Level 3.</i></p>
<p>LEVEL 3</p>	 flashing + 	<p>ATD SERVICE REQUIRED</p> <p>ENGINE DERATE ACTIVE</p> <p><i>Diesel particulate filter overfull</i></p> <p><i>If the flashing DPF REGENERATION telltale light is still ignored, the CHECK telltale light will illuminate. In that situation, engine performance is limited. Perform a parked regeneration IMMEDIATELY to avoid further derate and prevent from entering into Level 4.</i></p>
<p>LEVEL 4</p>	 flashing +  + 	<p>ATD SERVICE REQUIRED</p> <p>ENGINE SHUTDOWN ACTIVE</p> <p><i>A serious engine problem has occurred. The DPF may be over its maximum capacity.</i></p> <p><i>If a stationary regeneration is still not initiated, a standard Engine Protection Shutdown sequence will occur. All of the following dashboard lamps will be present:</i></p> <p><i>Blinking DPF REGENERATION telltale light;</i> <i>Solid CHECK telltale light;</i> <i>Solid STOP telltale light.</i></p> <p><i>Once engine derate and/or shutdown sequence is completed, a stationary regeneration must occur to continue vehicle operation. If the driver continues to operate the vehicle without regeneration, additional measures will be taken to protect the engine and ATD from damage, up to and including engine shutdown. Parked regeneration might no longer be possible.</i></p> <p><i>If engine protection has been initiated and forces the engine to shutdown, you CAN immediately re-start the engine and perform the necessary steps in order to initiate a stationary regeneration.</i></p>

Initiating a Stationary (Parked) Regeneration**NOTE**

At starting of the engine, if a stationary regeneration is required, the engine coolant temperature must reach 140°F (60°C) before any stationary regeneration may be initiated and completed. Permit the engine to idle for a short while or drive the vehicle until engine temperature increases sufficiently.

**WARNING**

Do not initiate a stationary regeneration in a closed area like a garage. Stationary regenerations must be undertaken outdoors only.

**WARNING**

During stationary regeneration, exhaust temperature may reach up to 842°F (450°C) at the particulate filter, it will go down to 788°F (420°C) after the catalytic converter and then will be further reduced to 554°F (290°C) at the diffuser outlet. Before initiating stationary regeneration, make sure that the DPF outlet diffuser is clear of objects and that no one is working near the DPF outlet diffuser.

**WARNING**

Hot surfaces. Keep yourself clear of all hot Aftertreatment Device components, particularly during and after active or stationary regeneration. Hot surfaces can cause serious burns.

NOTE**STATIONARY REGENERATION**

This process requires the vehicle to be parked while the driver or a maintenance technician initiates the regeneration process.

The DPF REGENERATION telltale light illuminates to notify the driver of the need and urgency of a manual stationary regeneration.



DPF REGENERATION telltale light

If stationary regeneration is not performed, this telltale light will blink, indicating that a stationary

regeneration is required immediately. If stationary regeneration is still not performed, “engine power derate and shutdown” sequence may occur as per level 1 to level 4 sequence.

To initiate a stationary regeneration:

- Park the vehicle in a clear area, vehicle speed must be 0 mph (0 km/h);
- Engine must be on normal idle and fully warmed up (coolant temperature above 140°F/60°C);
- Apply parking brakes and set the transmission to neutral (N).
- Press the DID ENTER button and then get to the DID Aftertreatment menu. Select sub-menu Request Parked REGEN and press ENTER button to confirm and initiate regeneration.

The regeneration will begin. Turn off the air conditioning to reduce engine load. The engine idling speed will increase to 1600 rpm. Once the regeneration is completed, the engine speed will return to normal idle.

Voluntary Interruption of a Stationary Regeneration

It is possible to interrupt a stationary regeneration at all time. To do so, set the ignition key to the OFF position or get to the DID's Aftertreatment menu, select Cancel REGEN and press ENTER button to confirm. You can stop regeneration simply by releasing the parking brake. Use this procedure in order to move the vehicle in a safe area.

If regeneration is interrupted, it is very important to reinitiate the regeneration as soon as possible.

SELECTIVE CATALYTIC REDUCTION UNIT

Selective Catalytic Reduction (SCR) is a technology that uses Diesel Exhaust Fluid (DEF) and a catalytic converter to reduce nitrogen oxides (NOx) emissions.

SCR is an exhaust aftertreatment system that injects small amount of DEF into the exhaust gas between the DPF and the selective reduction catalytic converter. DEF turns to ammonia and carbon dioxide when heated. The exhaust stream then passes over a catalyst, the ammonia reacts with the NOx to form nitrogen and water vapor.

The basic elements of the SCR system consist of a 15.9 gallons (60 liters) DEF tank complete with pump, lines and heating system, a dosing injector, a catalytic converter and the control and monitoring system.

Diesel exhaust fluid DEF

When handling DEF solution, it is important that electrical connectors to be connected or well encapsulated, otherwise there is a risk that the DEF will cause oxidation that cannot be removed. Water or compressed air will not help, since DEF quickly oxidizes certain metals. If a disconnected connector comes into contact with the DEF solution, it must be replaced immediately to prevent the DEF solution from creeping further into the copper wiring, which takes place at a speed of about 2.4 in (60 mm) per hour.

	<p>CAUTION</p>
<p>Diesel Exhaust Fluid (DEF) is a nontoxic aqueous solution of urea (32.5%) and ultra-pure water (67.5%). Urea is a compound of nitrogen that turns to ammonia when heated. The fluid is non flammable, and is not dangerous when handled as recommended. However, it is highly corrosive to certain metals, especially copper and brass.</p> <p>When detaching hoses and components, do not spill DEF on disconnected or unsealed connectors. If DEF is spilled on a disconnected or unsealed connector, the connector must be removed immediately and replaced.</p>	

Things to know about spilt diesel exhaust fluid (DEF):

- If urea solution comes into contact with the skin, rinse with plenty of water and remove contaminated clothing.
- If urea solution comes into contact with the eyes rinse for several minutes and call for medical help if necessary.
- If inhaled breathe fresh air and call for medical help if necessary.
- Do not allow the DEF solution to come into contact with other chemicals.

- The DEF solution is not flammable. If the DEF solution is exposed to high temperatures, it breaks down into ammonia and carbon dioxide.
- The DEF solution is highly corrosive to certain metals, including copper and aluminum.
- If the DEF solution is spilled onto the vehicle, wipe off the excess and rinse with water. Spilled DEF solution can form concentrated white crystals on the vehicle. Rinse off these crystals with water.

	<p>WARNING</p>
<p>DEF spilt onto hot components will quickly vaporize. Turn your face away!</p>	







Diesel Exhaust Fluid (DEF) Consumption

DEF consumption is related to fuel consumption. In order to meet EPA2010 requirements, DEF tanks are sized so one refill will be necessary every two refill of the fuel tank.

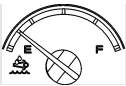
Selective catalytic reduction – Driver warning and inducement

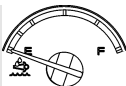
SCR system components must not be removed, altered or modified in any way. In order to protect the SCR system from tampering, inducement measures will occur if the following states are detected:

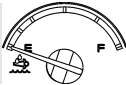
- Disconnection of DEF tank level sensor
- Blocked DEF line or dosing valve
- Disconnection of DEF dosing valve
- Disconnection of DEF pump
- Disconnection of SCR wiring harness
- Disconnection of NOx sensor

DEF TANK LEVEL			
DRIVER WARNING AND INDUCEMENT			
CONDITION	TELLTALE LIGHT AND MESSAGE IN THE DRIVER INFORMATION DISPLAY		INDUCEMENT
<p>There is only 2.6 gallons (10 liters) of DEF remaining in the tank. The actual DEF level gauge indicates about 12% DEF remaining.</p> 	 lighted solid	<p>message:</p> <ul style="list-style-type: none"> • DEF LOW 	None
<p>There is only 0.8 gallons (3 liters) of DEF remaining in the tank. The actual DEF level gauge indicates "Empty".</p> 	 Flashing	<p>message:</p> <ul style="list-style-type: none"> • DEF TANK NEAR EMPTY • ENGINE IN DERATE • ADD DEF 	Gradual engine torque reduction of 25%
<p>The DEF tank is empty and the DEF level gauge indicates "Empty".</p> <p style="text-align: center;">moreover</p> <p>a diesel fuel refueling is done and the diesel fuel level gauge increases <u>more than</u> 15% (approx. 34 gallons/130 liters)</p> <p style="text-align: center;">or</p> <p>the vehicle remains stationary (speed=0) for 20 min. with engine OFF or at idle.</p> 	 Flashing	<p>message:</p> <ul style="list-style-type: none"> • VEHICLE SPEED LIMITED TO 5 mph (8 km/h) • ADD DEF 	<p>Vehicle road speed limited (RSL) to 5 mph (8 km/h)</p> <p>The vehicle has to remain stationary before 5 mph (8 km/h) road speed limit becomes active</p> <p>NOTE: Repeated acts of tampering will result in more severe inducement.</p>

DEF QUALITY			
DRIVER WARNING AND INDUCEMENT			
CONDITION	TELLTALE LIGHT AND MESSAGE IN THE DRIVER INFORMATION DISPLAY	INDUCEMENT	
<p>Poor DEF quality detected (dilution)</p> <p>Emission of initial diagnostic troubleshooting code (DTC).</p>	<div style="border: 1px solid black; border-radius: 50%; padding: 2px; display: inline-block; margin-bottom: 5px;">CHECK</div> lighted solid	<p>message:</p> <ul style="list-style-type: none"> • SCR PERFORMANCE LOW • ENGINE WILL DERATE SOON 	None
<p>1 hour after poor DEF quality detection (chronological time after the initial tampering DTC emission).</p>	<div style="border: 1px solid black; border-radius: 50%; padding: 2px; display: inline-block; margin-bottom: 5px;">CHECK</div> lighted solid	<p>message:</p> <ul style="list-style-type: none"> • SCR MALFUNCTION • ENGINE IN DERATE • CHECK SCR TO AVOID 5 mph (8km/h) LIMIT 	Gradual engine torque reduction of 25%.
<p>3 hours after poor DEF quality detection (chronological time after the initial tampering DTC emission)</p> <p style="text-align: center;">moreover</p> <p>a diesel fuel refueling is done and the diesel fuel level gauge increases <u>more than</u> 15% (approx. 34 gallons/130 liters)</p> <p style="text-align: center;">or</p> <p>the vehicle remains stationary (speed=0) for 20 min. with engine OFF or at idle.</p>	<div style="border: 1px solid black; border-radius: 50%; padding: 2px; display: inline-block; margin-bottom: 5px;">CHECK</div> lighted solid	<p>message:</p> <ul style="list-style-type: none"> • SERVICE SYSTEM SCR • 5 mph (8km/h) LIMIT 	Vehicle road speed limited (RSL) to 5 mph (8 km/h) The vehicle has to remain stationary before 5 mph (8 km/h) road speed limit becomes active
<p>Conditions to temporarily exit the 5 mph (8 km/h) road speed limit inducement</p> <p>First engine restart: At the first engine restart, the engine returns to the 25% torque reduction until proper DEF quality evaluation occurs. If poor DEF quality is detected during the next monitoring cycle then the 8 km/h (5 mph) speed limitation will resume after vehicle is stationary for 20 minutes.</p> <p>After the second engine restart, Premium Tech Tool is required to exit the 5 mph (8 km/h) RSL.</p> <p>With Premium Tech Tool: Invoke 25% torque reduction until proper DEF quality evaluation occurs. If poor DEF quality is detected during the next monitoring cycle then the 8 km/h (5 mph) speed limitation will resume after vehicle is stationary for 20 minutes.</p> <p>Repeating poor DEF quality within 40 hours since correction will resume the inducement stage.</p> <p>If correction occurs during road speed limitation, repeating poor DEF quality will invoke immediate 25% engine torque reduction, then 5 mph (8 km/h) road speed limitation upon vehicle stationary state of 20 minutes.</p>			

SCR SYSTEM TAMPERING		
DRIVER WARNING AND INDUCEMENT		
CONDITION	TELLTALE	INDUCEMENT
<p><i>Tampering detected</i></p> <p><i>Tampering DTC pending.</i></p>	<p>CHECK</p> <p><i>lighted solid</i></p>	<p>None</p>
<p><i>Tampering detected</i></p> <p><i>Tampering DTC confirmed.</i></p>	<p>CHECK</p> <p><i>lighted solid</i></p>	<p>None</p>
<p><i>1 hour after tampering DTC detection (chronological time after the initial tampering DTC emission).</i></p>	<p>CHECK</p> <p><i>lighted solid</i></p>	<p><i>Gradual engine torque reduction of 25%.</i></p>
<p><i>3 hours after tampering DTC detection (chronological time after the initial tampering DTC emission).</i></p> <p style="text-align: center;"><i>moreover</i></p> <p><i>a diesel fuel refueling is done and the diesel fuel level gauge increases <u>more than</u> 15% (approx. 34 gallons/130 liters)</i></p> <p style="text-align: center;"><i>or</i></p> <p><i>the vehicle remains stationary (speed=0) for 20 min. with engine OFF or at idle.</i></p>	<p>CHECK</p> <p><i>lighted solid</i></p>	<p><i>Vehicle road speed limited (RSL) to 5 mph (8 km/h)</i></p> <p><i>The vehicle has to remain stationary before 5 mph (8 km/h) road speed limit becomes active.</i></p>
<p><i>Correcting the SCR tampering condition will exit inducement.</i></p> <p><i>Repeating SCR tampering within 40 hrs since correction will resume the inducement at the same inducement stage and timer status existing at the time of correction.</i></p> <p><i>If correction occurs during road speed limitation, repeating tampering will invoke immediate 25% engine torque reduction, then 5 mph (8 km/h) road speed limitation upon vehicle stationary state of 20 minutes.</i></p>		

DRIVER INFORMATION DISPLAY (DID) MENUS

There are Driving and Non-Driving menus. Several sub-menus are password-protected while the vehicle is parked. The Non-Driving menu is accessible only when the vehicle is parked.

“DRIVING” MODE MENUS

Gauges

1. Outside Temperature
2. Engine Oil Temperature
3. Transmission Fluid Temperature
4. Accessories Air Pressure
5. A/C Compressor Pressure
6. Battery Voltage
7. Allison Transmission Oil Life

Fuel Data

1. Fuel flow
2. Trip Fuel Used
3. Distance to Empty

Time-Distance

1. Time and Date
2. Alarm Clock
3. Distance to Destination
4. Average Trip Speed
5. Estimated Time of Arrival (ETA)

Vehicle Messages

Reset Trip Data

“NON-DRIVING/STATIONARY” MODE MENUS

Display Settings

1. Language
2. Units
3. Time/Date
4. Favorite Display Setting
5. Display Light
6. Change Password

Diagnostics

1. View Active Faults
2. View Inactive Faults
3. Cluster Selftest
4. Part Number
5. Reset Inactive Faults
6. Vehicle Tests

Pre-Trip Assistant

1. Exterior Light Inspection
2. Air Leakage Monitor

Datalog

1. Vehicle ID
2. Total Data
3. Trip Data
4. Reset Trip Data

Aftertreatment

1. Request Parked REGEN
2. ATS Status
3. Cancel REGEN

Password

1. Enter Password

GAUGES

There are several gauges in this menu. The gauges are used to view current status of important functions in the vehicle.

1. Outside Temperature

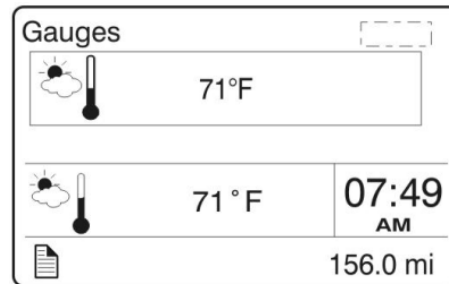

2. Engine Oil Temperature

Selection of this gauge will display the engine oil temperature.

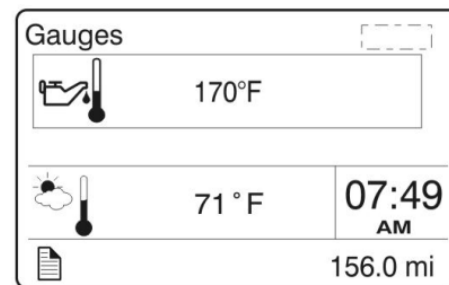

3. Transmission Fluid Temperature

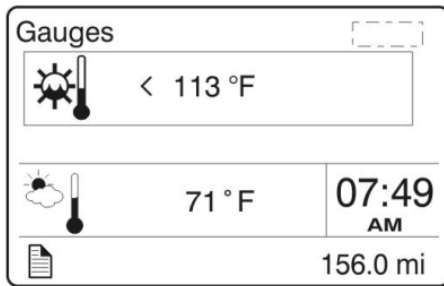

displayed as 99%. Refer to Appendix C for more details.

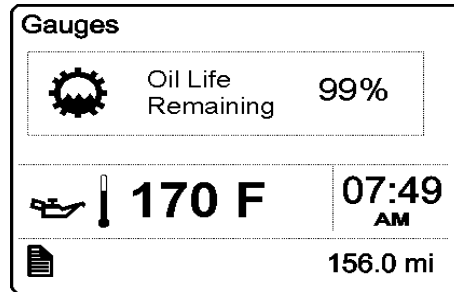

4. Accessories Air Pressure

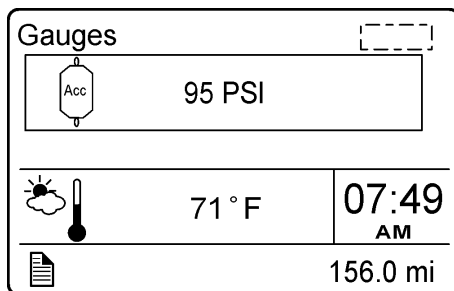

5. Battery Voltage

Displays the current 12-volts and 24-volts system voltage.

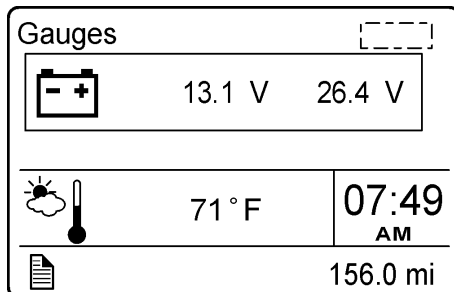

6. A/C Compressor Pressure

Displays the A/C compressor suction pressure value (LoS=low side) and discharge pressure value (HiS=high side).

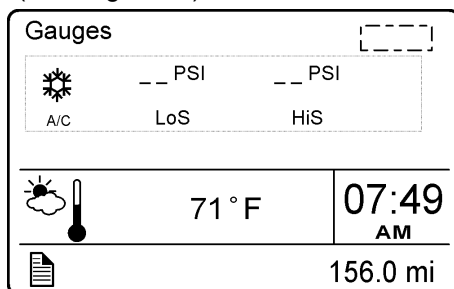

7. Allison Transmission Oil Life

Displays the percentage of the calculated remaining life of the transmission oil. New oil is

FUEL DATA

The Fuel Data menu provides information on the fuel consumption of the vehicle in various situations. For example, how much fuel has been used, how much fuel is remaining, how much fuel is remaining before refueling the vehicle.

1. Fuel Flow (gph)

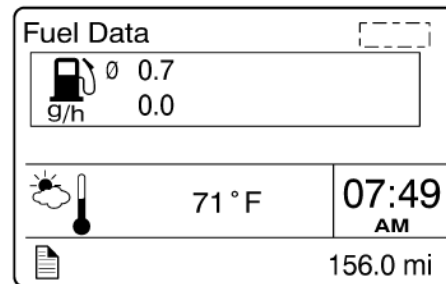

2. Trip Fuel Used

Indicates the total fuel consumption since the last reset.

NOTE: Use Reset function before each new trip.

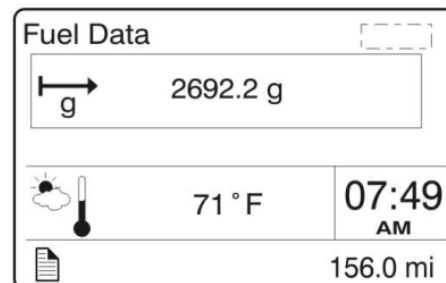

3. Distance to Empty

Indicates the distance that can be traveled with the quantity of fuel that remains in the tank.

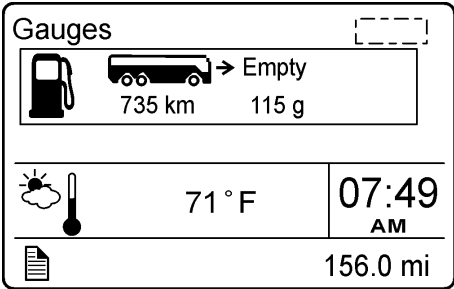

TIME/DISTANCE

The time and date can be set in the Time/Distance menu. The alarm clock can also be set from this menu. Following the alarm clock menu is the Distance to Destination selection, which allows the operator to see the distance to travel before destination. Average trip speed is also shown. By specifying the distance to your destination, the vehicle can calculate the estimated time of arrival (ETA).

1. Time And Date

Adjust time and date with this menu. The instrument cluster has its own internal battery, so the date and date setting is keep in memory even if the vehicle's battery is disconnected.

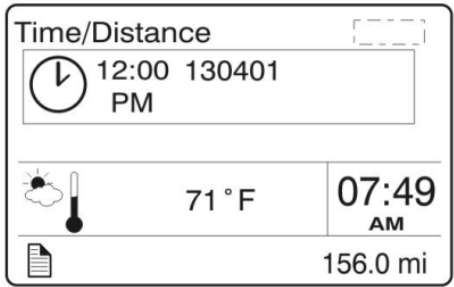

2. Alarm Clock

Use this function to program an alarm on the instrument cluster clock.

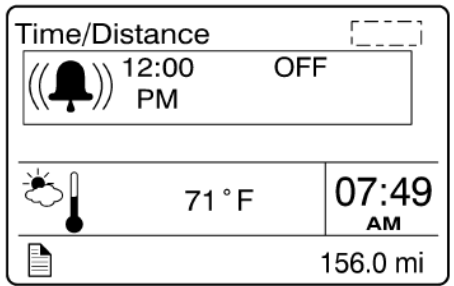

3. Distance to Destination

If the distance to be traveled before reaching the destination was entered in Estimated Time of Arrival (ETA) menu, this function will display the remaining distance to be traveled before reaching destination. Two independent driving distances can be entered, for example, 1 could be for leg 1 distance and 2 would be the entire trip.

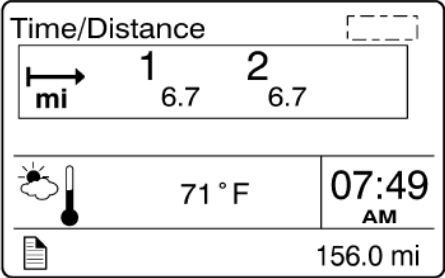

4. Average Trip Speed

This function displays the average speed for the current travel. The average trip speed is calculated as the distance traveled divided by the time the engine has been running (since the last reset). Two average trip speeds can be measured. Use Reset function before each new travel to start new measurements.

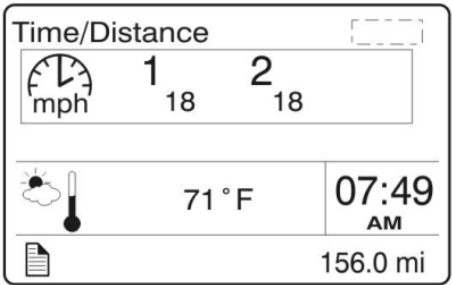

5. Estimated Time of Arrival (ETA)

This function will display the estimated time of arrival if the distance to be traveled is entered first, in this menu. To set distance to be traveled, press ENTER and enter the distance left to drive in mile or km using the DID control buttons.

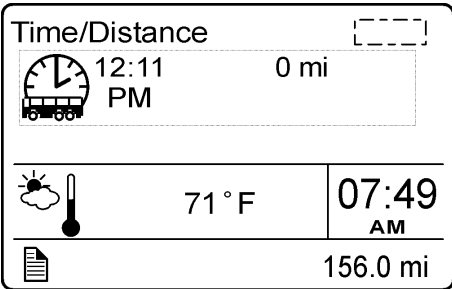

VEHICLE MESSAGES

Use this function to consult the vehicle active messages that were previously displayed as pop-up messages and then acknowledged. When consulting a message, the corresponding STOP, CHECK or INFORMATION warning light will illuminate. Scroll through the messages using the up/down button. Press ESC button to return to main menu.

RESET TRIP DATA

When the Reset Trip Data menu is open, pressing and holding down the Enter button for more than 1 second resets the functions listed below. This function will permit to the system to calculate new value from the point of resetting.

- Trip Fuel Used
- Average Trip Speed

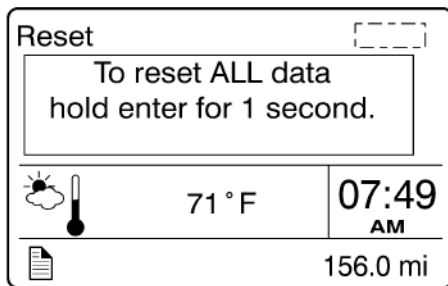

NON-DRIVING/STATIONARY MODE MENUS

DISPLAY SETTINGS

The Display Settings menu is used to change languages and units. The password, time and date can also be changed. The backlight and contrast of the display screen can be adjusted.

1. Language

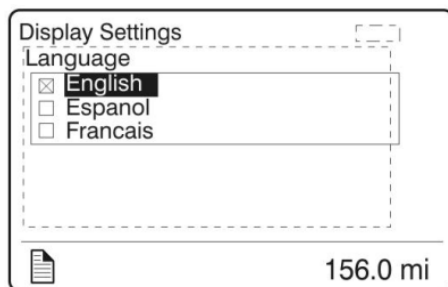

2. Units

Use this function to select desired unit formats for:

- Distance (miles or km);
- Fuel consumption (km/l, l/100km, mpg US or IMP);
- Temperature (°C or °F).

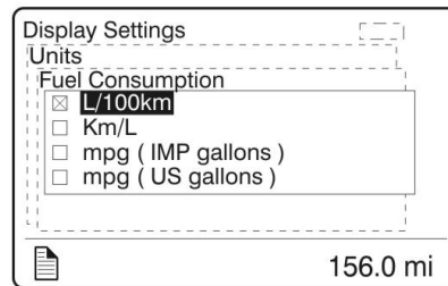
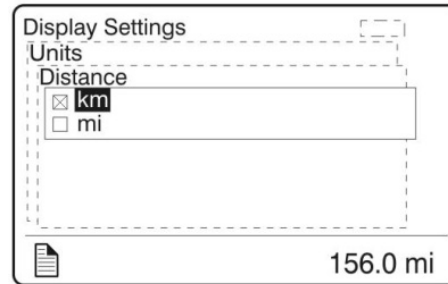

3. Time/Date

Select the time and date format (am, pm, 24h) using this function.

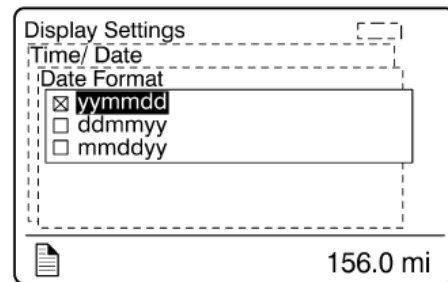

4. Favorite Display Setting

Use this menu to select your favorite display gauges 1, 2 and 3 and replace the default gauges. On vehicles provided with the I-Shift transmission, Favorite Display Gauge 3 cannot be edited as it is kept for display of the transmission status.



Example: You wish to display the engine oil temperature at the Gauge 1 position.

1. Use UP/DOWN button until Gauge 1 position is selected.
2. Press ENTER button to confirm.
3. Use UP/DOWN button to scroll through the available gauges. When the engine oil temperature gauge is displayed, press ENTER button to confirm (repeat steps 1-3 to change Gauge 2 and Gauge 3 if needed).

5. Display Light

The Display Light menu has three sub-menus:

• Contrast

Adjust the contrast with the UP/DOWN button and press ENTER button to confirm.

• Backlight

In this menu, the display lighting can be adjusted relative to other instrument lighting with the UP/DOWN button.

• Night/Day

Use the Night/Day menu to choose a dark background with light text and images or a light background with dark text and images. Press ENTER button to toggle between Night and Day.

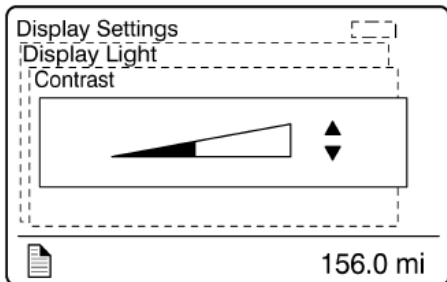

6. Change Password

Use this menu to change the current password. This menu is only accessible if the correct password is entered. The default password is 0000.

1. Mark which password is to be changed with the display UP/DOWN button.

2. Confirm with ENTER button.
3. Set the first digit with the UP/DOWN button.
4. Step to the next digit using ENTER button.
5. Step backwards with ESC button.

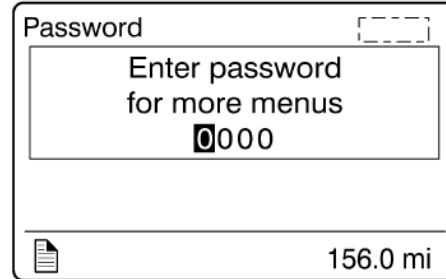

DIAGNOSTICS

The Diagnostics menu enables fault tracing on the control units in the vehicle to check for faults. Instrument tests are available to check the telltales, gauges, display and speaker. The part number of a control unit can be identified in the part number menu.

1. View Active Fault

A list of the control units on the vehicle is displayed. Use this function to check for active faults on specific control units.

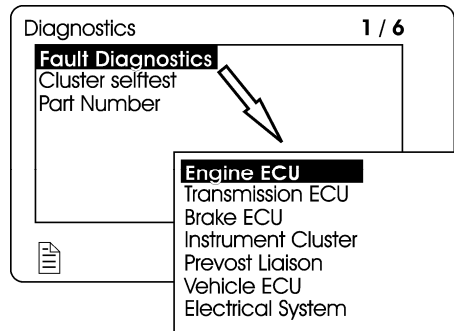

2. View Inactive Fault

Use this function to check for inactive faults on specific control units.

3. Cluster Selftest

Use this menu to check proper functioning of the following components:

- Telltale lights
- Analog gauges
- Display
- Speakers

The following table describes the available tests. To cancel a test, press the ESC button).

<p><i>Telltale lights test</i></p>	<p><i>Telltale lights illuminate for approximately five seconds.</i></p> <p><i>Press the Esc button to cancel the test.</i></p>
<p><i>Analog gauges</i></p>	<p><i>The indicators move forwards and backwards between the end positions. They do not show any particular value. This is just a check to confirm that the indicators move, and to make sure the operators are working.</i></p> <p><i>Press the Esc button to cancel the test.</i></p>
<p><i>Display test</i></p>	<p><i>The entire display lights up until the Esc button is pressed.</i></p>
<p><i>Speaker Test</i></p>	<p><i>A sound is emitted through the speakers. Press the Esc button to cancel the test.</i></p>

4. Part Number

A list of the control units on the vehicle with their part numbers is displayed in the Part Number menu.

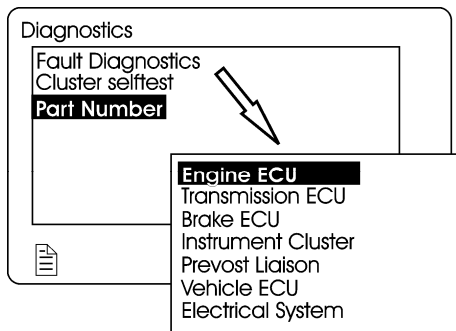

5. Reset Inactive Faults

Use this menu to delete an inactive fault for a particular control unit. Note: it is not possible to delete inactive faults of the Engine ECU.

6. Vehicle Test

Use this menu to perform tests of the dashboard switches. You can also test some electrical components with this menu (electrical motors, contactors, etc.). For more information, refer to section 06: Electrical, under "Test mode for

electric motors" paragraph of the Maintenance Manual.

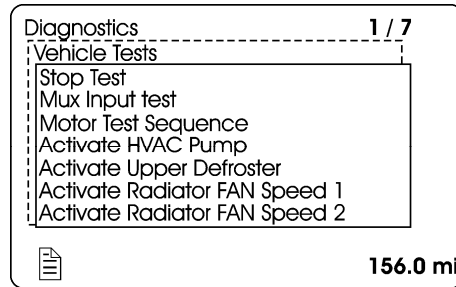

PRE-TRIP ASSISTANT (option)

The Pre-Trip Assistance option is a tool to assist the driver in completing the pre-trip inspection of the vehicle. This option is not a substitute for a complete pre-trip inspection. If any system of the vehicle does not pass inspection, the error must be corrected before operating the vehicle. The available pre-trip tests include the Exterior Light Inspection check, and the Air Leakage check.

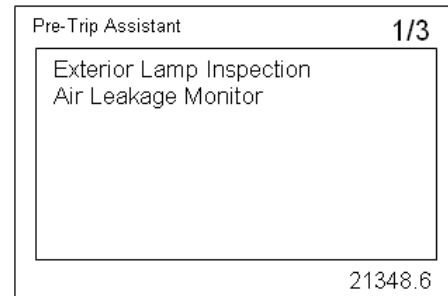

1. Exterior Light Inspection

The Exterior Light Inspection check repeatedly turns all exterior lights on/off for the vehicle. This allows the operator to start the test, exit the vehicle and do a visual check that all exterior lighting is functioning properly.

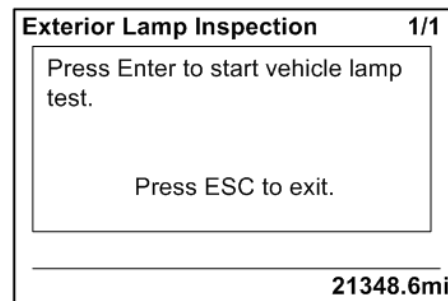

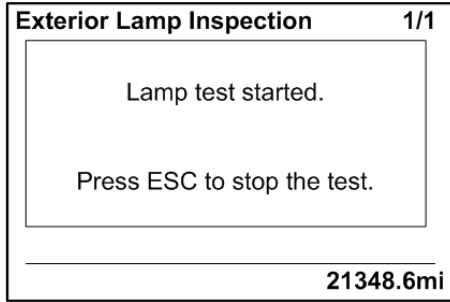

2. Air leakage Monitor

The Air Leakage check allows the driver to accurately measure the amount of air pressure drop in the front and rear brake air systems. After selecting this test from the DID, you are prompted to apply the service brake for 60 seconds. After applying and holding the service brake for 60 seconds, the DID will display the amount of pressure drop in the brake system.

Before starting the test through the DID, complete the following:

- Start the engine and check that the brake systems air pressure is greater than 100 psi.
- Turn engine off.
- Release the brakes and allow the system to settle (air gauge needle stops moving).
- Press the ENTER button to start the test.

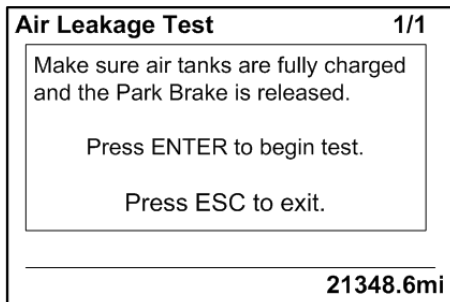

- If the air tanks pressure is too low to perform the test (pressure must be greater than 100 psi), the following messages will appear.

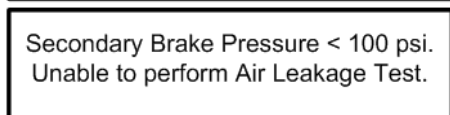
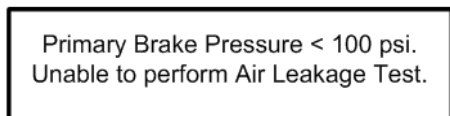

- You must press and hold brake pedal for 60 seconds, as instructed.

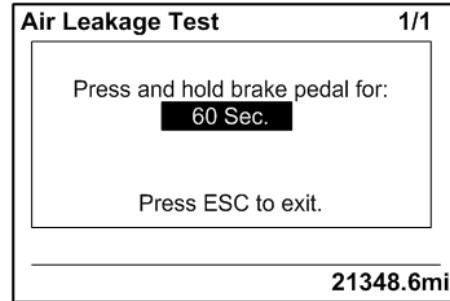

- Once the brake pressure test is completed the pressure leak test results are displayed.

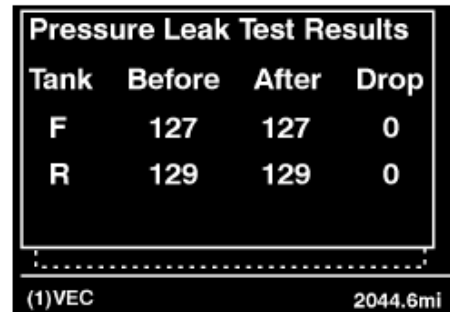

DATA LOG

1. Vehicle ID

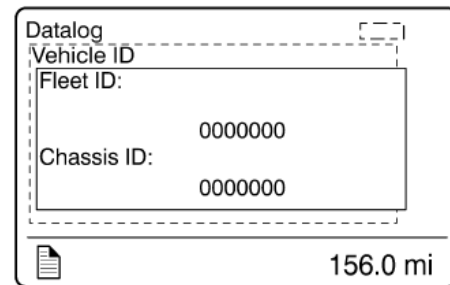

2. Total Data

Total Data menu indicates the accumulated engine values that have been logged during the lifetime of the engine ECU.

Available information:

- Total distance traveled
- Total fuel used
- Total engine hours
- Total idle time
- Total PTO hours

- total engine revolutions

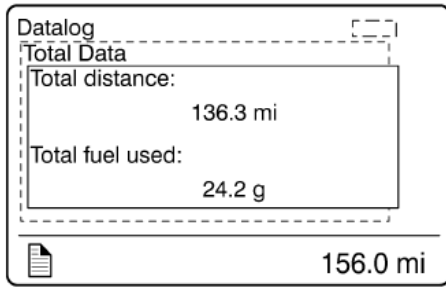

3. Trip Data

This menu displays the trip information listed below. This function must be reset before each measurement (before each new trip or leg) using the Reset Trip Data menu.

Available information for the trip or leg is:

- Trip distance (miles or km)
- Trip fuel average (mpg, liter/100km; km/liter)
- Trip fuel used (gallons or liters)
- Trip duration on cruise control (hours)
- Trip duration with engine rpm greater than economy rpm (hours)
- Trip duration while engine rpm is greater than the desire maximum rpm RPM Limit set in Fleet Limits sub-menu (hours)
- Trip fuel used with engine rpm greater than the economy rpm (gallons/liters)
- Trip average speed (mph, km/h)
- Trip duration with speed greater than the maximum desired speed as set in Fleet Limits sub-menu (hours)
- Trip engine hours
- Trip duration on engine idle (hours)
- Trip fuel used while in engine idle (gallons, liters)

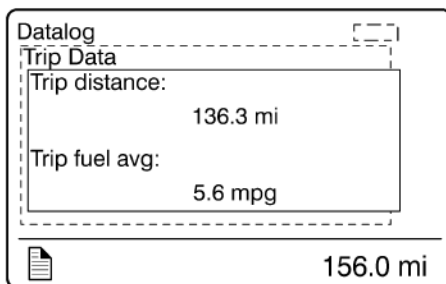

4. Reset Trip Data

This menu can only be accessed if the correct password has been entered. Use this function to reset measurements of the Trip Data menu before each new trip or leg.

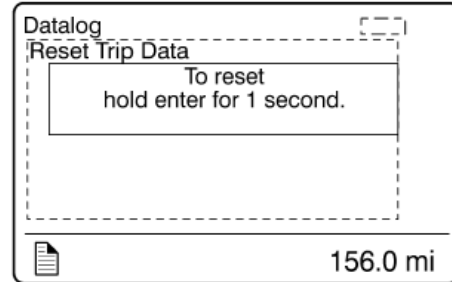

AFTERTREATMENT

This menu permits to the driver to initiate a stationary regeneration, to check the status of the aftertreatment system and to interrupt regeneration.

1. Request Parked REGEN

Use this function to initiate a stationary (parked) regeneration.

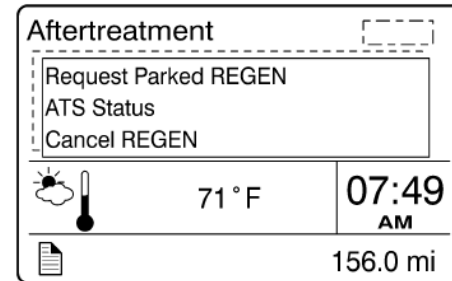

2. ATS Status

The Aftertreatment status sub-menus provide information about the conditions required for performing regeneration. The status can be OK (regeneration allowed), CHECK (regeneration not allowed) or N/A (not applicable). When ATS Status is selected, the following sub-menus are available.

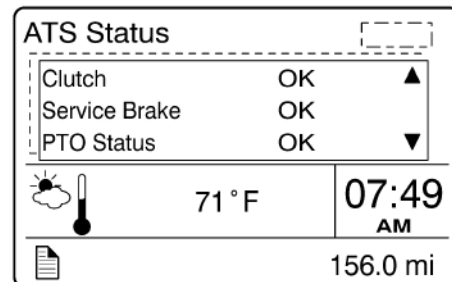

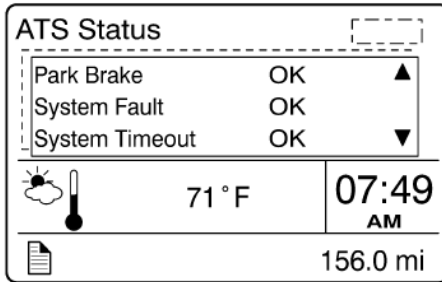
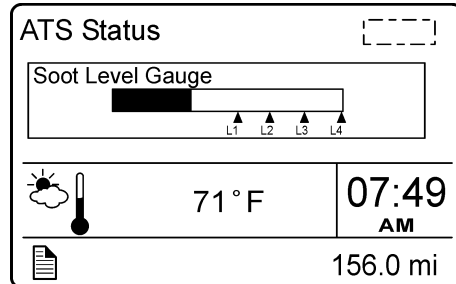
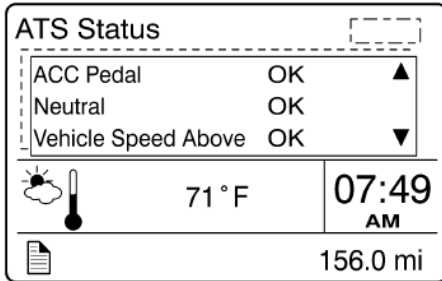

3. Cancel REGEN
From the Aftertreatment main menu, you can cancel a REGEN cycle.

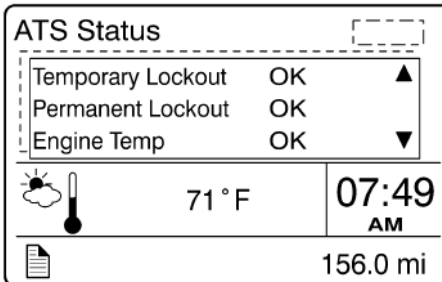

PASSWORD

Certain functions are password-protected. These passwords give the user access to all password-protected functions. The default password is 0000.

- 1. Password**
The following menus are password-protected and marked with a key symbol in the menus:
- Change Password
 - Fleet ID
 - Reset Trip Data
 - Fault Diagnostics
 - Inactive Faults

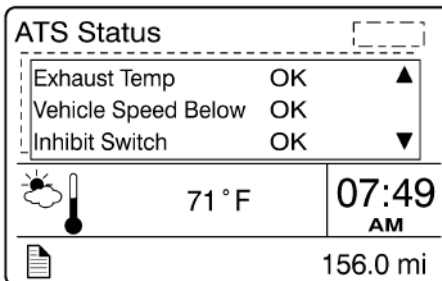

TRANSMISSION RETARDER

Soot Level Gauge
From the ATS Status sub-menu, you can view the soot level for the Aftertreatment system. When the soot level is high, regeneration is necessary. L1, L2, L3 and L4 under the scale correspond to Level 1 up to Level 4 (see Diesel particulate filter clogging sequence – Engine indicator lamp).

The transmission retarder is a device that helps to reduce the speed of a vehicle. It improves vehicle control, increases driving safety and permits more economical operation. The retarder provides slowing power when it is most needed, such as when descending mountain roads, in stop-and-go traffic and on crowded freeways.

The transmission retarder is a vehicle-slowng device, not a vehicle-stopping device. It is not a substitute for the service braking system. The service brake must be used to bring the vehicle to a complete stop.

NOTE

Extended use will raise the temperature of the transmission fluid.

The retarder is provided with a switch located on the L.H. dashboard panel (refer to "CONTROLS AND INSTRUMENTS" chapter).

NOTE

Deactivating the transmission retarder will turn the indicator light located at the front of the coach ON.

The retarder helps reduce speed on grades without using the vehicle's conventional service braking system. This virtually eliminates brake overheating and reduces the risk of a runaway vehicle. A retarder greatly increases the service life of brake pads and discs, resulting in reduced brake maintenance costs.

NOTE

The stoplights automatically illuminate when the vehicle is slowing down after application of the transmission retarder.

NOTE

For vehicles equipped with the Antilock Braking System (ABS), as the wheels start to lock up on slippery roads, the output retarder automatically deactivates until the wheels roll freely.

ANTILOCK BRAKING SYSTEM (ABS)

The purpose of the Antilock Braking System (ABS) is to maintain vehicle stability and control during braking and to minimize the stopping distance in any road condition.

On slippery roads and more generally in emergency situations, over-braking frequently induces wheel locking. Wheel locking greatly increases breaking distance on any road surface. Locked wheels also impede directional control and cause severe tire abrasion. An antilock braking system provides maximum braking performance while maintaining adequate control on slippery roads.

The basis of ABS is constant monitoring of wheel parameters during braking. Sensors on each wheel of the front and drive axles constantly measure wheel speed during braking. This information is transmitted to a four-channel electronic processor which senses when any wheel is about to lock. Modulating valves quickly

adjust brake pressure (up to 5 times every second) to prevent wheel lock. Each wheel is therefore controlled according to the available grip.

In this way, the vehicle is brought to a stop in the shortest possible time while remaining stable and under the driver's control.



WARNING

Vehicles following ABS-equipped vehicles may not be able to brake as fast on slippery roads.

KNEELING SYSTEM

This system lowers the front end, enabling passengers to get on and off the coach without any difficulty.

NOTE

This coach is equipped with an interlock system which automatically applies the parking brake when the kneeling system is activated.

To operate, stop the coach, set the transmission to neutral (N), then push down the rocker switch located on the dashboard. (Refer to "Controls & Instruments" chapter). The parking brake will be applied automatically and a status line pictogram will appear on the DID to indicate that the front of the coach is being lowered.

To raise the front of the coach to its normal height, push up the rocker switch. The front end will rapidly rise up. The system will release the parking brake and shift the transmission to the previously selected range.



CAUTION

Avoid parking the coach too close to the sidewalk or to other obstacles which could damage the coach during kneeling.

NOTE

Kneeling is disabled when the entrance door is open.

NOTE

The kneeling system does not operate when the coach is traveling over 5 mph (8 km/h). Consequently, the driver cannot inadvertently operate the kneeling system at higher speeds.

UNLOADING TAG AXLE

To reduce the turning radius, the air springs pressure will be automatically reduced by 75% when the coach is moving at speed lower than 5 mph (8 km/h) and with more than 1½ turn from the steering.

RETRACTABLE TAG AXLE

The standard tag axle retraction system is controlled by a valve located in the front service compartment. The valve can be switched to either the WHEELS UP or WHEELS DOWN position. The axle will be raised or lowered by air pressure according to the valve position.

The tag axle service brakes operate only when the tag axle is in the WHEELS DOWN position. Never lower the tag axle while the coach is moving. When the tag axle is in the WHEELS UP position, the corresponding indicator light will illuminate. The indicator light will start flashing and an audible alarm will sound to warn the driver if the vehicle speed exceeds 12 mph (20 km/h) with tag axle raised. The tag axle can be raised in tight maneuvering areas like in a parking lot or to make it easier to turn a short corner. The tag axle shortens the wheelbase and allows tighter turning. Raising the tag axle transfers extra weight and additional traction to the drive wheels providing improved control on slippery roads.



CAUTION

Do not use tag axle in raised position for an extended period. Raising tag axle increases load on the drive axle, suspension and tires.

Do not drive vehicle with tag axle raised when speed is exceeding 12 mph (20 km/h).

In order to prevent damage to the suspension, always raise the tag axle before lifting the coach.

IN-STATION LIGHTING

The in-station lighting system circuit is linked with the battery charger: When the charger is connected to an external power source, the in-station lighting circuit can be energized without depleting the batteries.

The receptacle used for the battery charger is located on the engine compart. R.H. side door.

WHEELCHAIR LIFT SYSTEM

Read and understand the RICON Service/Owner Manual before attempting to use the wheelchair lift. The instructions below are a quick reference and serve to complement the information provided by RICON.



WARNING

To operate the optional wheelchair lift, the coach must be parked on a flat and level surface, with the parking brake applied.

Activate the lift mechanism circuit by pressing down on the wheelchair rocker switch on the dashboard.

WHEELCHAIR LIFT AND ACCESS DOORS

The wheelchair access door slides towards the front of the coach on the exterior side and is maintained open by a locking mechanism. Slide the wheelchair access door completely until it locks in the open position at the end of stroke. To close the door, pull on the handle to release the locking mechanism and slide back the door in closed position.

NOTE

The wheelchair access door must be completely opened for the WCL to work.

A light inside the vehicle illuminates the doorway when the wheelchair access door is open.

A telltale light on the dashboard illuminates when the lift mechanism access door or the wheelchair access door is open. Refer to Controls and Instruments chapter.

When either the lift mechanism access door or the wheelchair access door is open, the parking brake cannot be released and the transmission gear selector will not register any gear selection.

NOTE

The activation switch must be in the ON position for this interlock feature to be in effect.

If in motion and the access door opens, a telltale light will illuminate and an audible alert will sound.

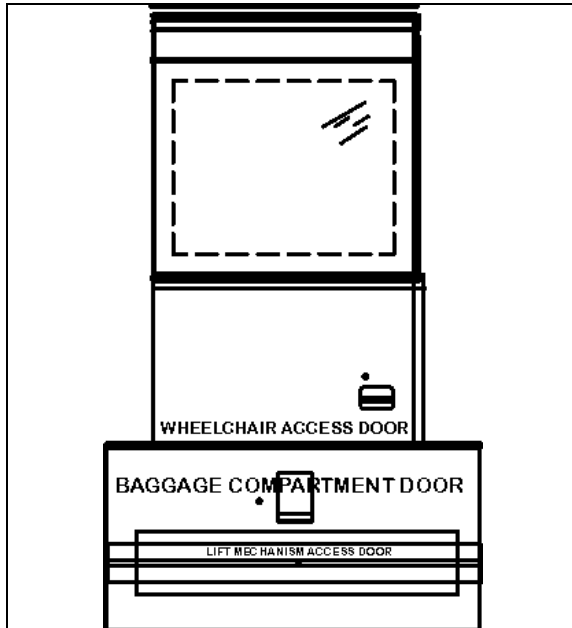

WHEELCHAIR LIFT AND ACCESS DOORS 18615

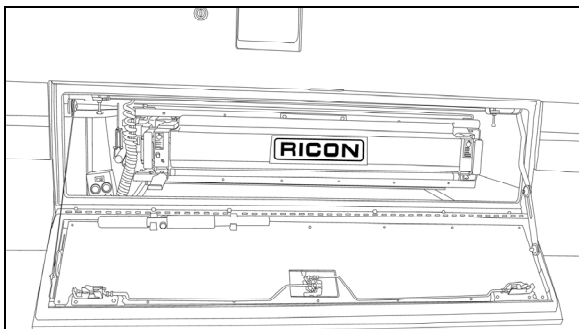

OPENING LIFT MECHANISM ACCESS DOOR 18616

OPERATING THE WHEELCHAIR LIFT

WARNING

Inspect the lift before each use as described in the RICON Owner's manual. If any unsafe condition exists, or if unusual noises or movements are noticed, DO NOT use and contact an authorized RICON dealer for repair.

WARNING

Read and comply with all warning labels and symbols affixed to the wheelchair lift.

WARNING

Do not operate with a load in excess of 660 lbs (300 Kg).

The coach must be parked at least 10 feet (3 meters) away from other vehicles or large objects. Toggle the POWER switch to the ON position and then control each lift motion by pressing on the appropriate button. The POWER switch provides power to the pendant and thereby enables the lift. When toggled on, the power switch and each button illuminate. When operating the lift, be careful the control wire doesn't bind with the lift mechanism.

Deploy Platform

CAUTION

Make sure lift mechanism access door is opened completely.

Using the handheld control pendant, deploy the lift by pressing on the DEPLOY button until the platform is completely extended from compartment. When the lift begins to deploy, it is normal to hear a clutch action of one or two clicks should be heard.

NOTE

Platform cannot be moved UP or DOWN unless platform is fully extended.

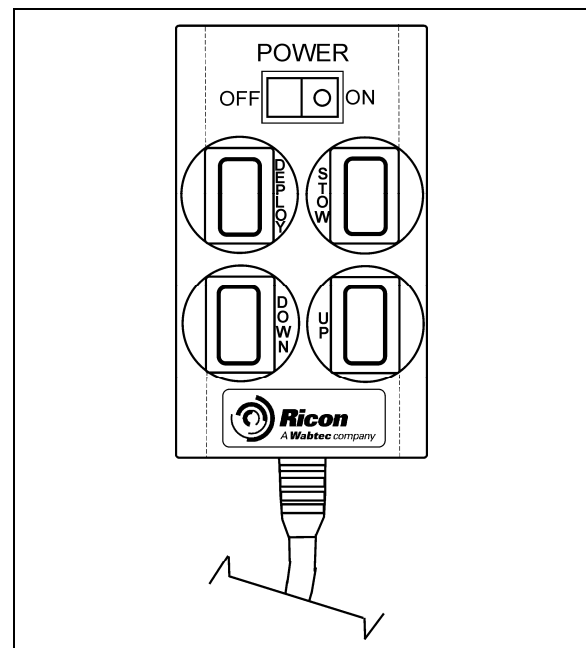

CONTROL PENDANT 23421

Raise Platform

Once deployed, lift each handrail up and outward to a vertical position and then pushing down to lock into place.

If this is the case, carefully roll the wheelchair onto the center of platform with the wheelchair facing outwards (away from vehicle) and lock wheelchair brakes. Pull safety belt from retractor on handrail and fasten to other handrail. Press and hold UP button until platform rises and stops automatically at vehicle floor level.

 CAUTION
<p>Make sure the wheelchair access door is opened completely, if not, the platform will stop when it reaches $\frac{3}{4}$ height position to prevent damages to the vehicle side.</p>

Verify that bridgeplate lowers to horizontal position and rests flat on vehicle floor.

Release wheelchair brakes and carefully board passenger into vehicle.

<i>NOTE</i>
<p><i>The restraint belt acts as a safety device and it prevents raising or lowering the lift when not buckled.</i></p>

Lower Platform

If this is the case, carefully roll the wheelchair onto the center of platform with the wheelchair facing outwards (away from vehicle) and lock wheelchair brakes. Pull safety belt from retractor on handrail and fasten to other handrail. Press and hold DOWN button until platform contacts ground.

 WARNING
<p>Use extreme care when rolling on or off the platform and lock the wheelchair brakes while stationary on the platform. Make sure the wheelchair fits safely on the platform. Keep arms and legs away from moving parts.</p>

<i>NOTE</i>
<p><i>The indicator light on the control device illuminates when power is supplied (when the lift electrical circuit is activated by the switch on the dashboard).</i></p>

Stow Platform

To stow the platform, detach the restraint belt, lift each handrail up to unlock and fold handrails. Re-fasten restraint belt. Press down and hold the STOW button until the lift is fully stowed.

THRESHOLD WARNING SYSTEM (TWS) ADJUSTMENT

There are three verifications to perform; 1) Adjust Aiming of Acoustic Sensor Beam, 2) Test Aim of Acoustic Sensor Beam, and 3) Adjust Acoustic Sensor Timing.

Adjustment of the sensor timing is done at the factory and should not need to be repeated in the field. Readjustment should only be considered if the sensor aiming could not be adjusted to ignore both the wheelchair in the aisle and the platform during its normal movement.

Adjust Aiming of Acoustic Sensor Beam

1. Place wheelchair with passenger in center aisle of coach, pointed at doorway where Threshold Warning System (TWS) is installed. The TWS should not detect a wheelchair and passenger when they are located this far from doorway.
2. Turn power to lift on (LED on TWS module will light steady) and indicator light on the control device illuminates. If wheelchair and passenger are detected by acoustic sensors the LED will flash, the buzzer will sound and the module red light will flash. If this occurs it is necessary to adjust aiming of sensors.

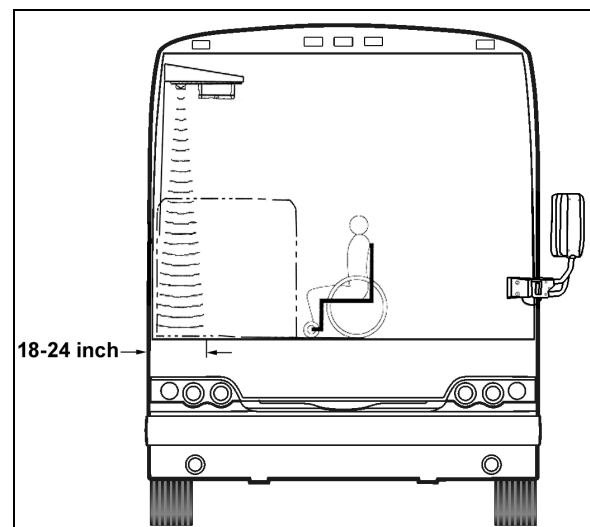

TWS AREA 23371

3. Turn sensor angle adjustment screw clockwise to move direction of beam away from center aisle and towards doorway. Stop adjustment when LED ceases to flash.

NOTE

Only in rare instances will adjustment be needed in the counterclockwise direction.

4. Move centerline of small wheels of wheelchair (with passenger) to within 24 inches of doorway and repeat aiming procedure in previous step.

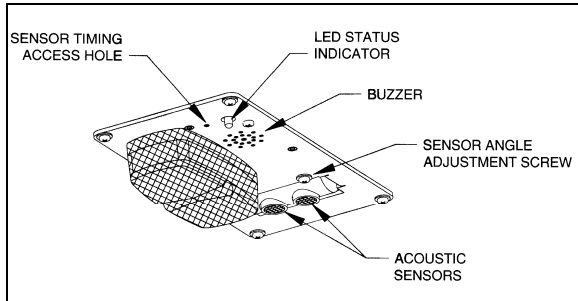

TWS MODULE DETAIL

23368

Test Aim of Acoustic Sensor Beam

1. Move wheelchair and passenger slowly towards doorway. TWS should detect wheelchair and passenger (LED will flash, buzzer will sound and the module red light will flash) when centerline of front wheels is between 18 and 24 inches from doorway.
2. Open vehicle access door above lift. Lower platform to ground and place wheelchair and passenger at rear of platform. Bridgeplate should be up. Raise platform to floor level. This normal platform motion with wheelchair and passenger aboard should not actuate TWS. If LED does flash (buzzer will also sound and module red light will flash), turn sensor adjustment screw slightly counterclockwise.

NOTE

If an adjustment is made, repeat the previous step where wheelchair is between 18 and 24 inches from doorway.

Adjust Acoustic Sensor Timing

1. Support a flat sheet of cardboard, or similar material, directly beneath TWS module at a distance of 4½ feet below module. Sheet must be facing sensors.

NOTE

Before proceeding, visually inspect sensors to verify that they are pointing directly at floor, or nearly, and are not pointing off at an extreme angle.

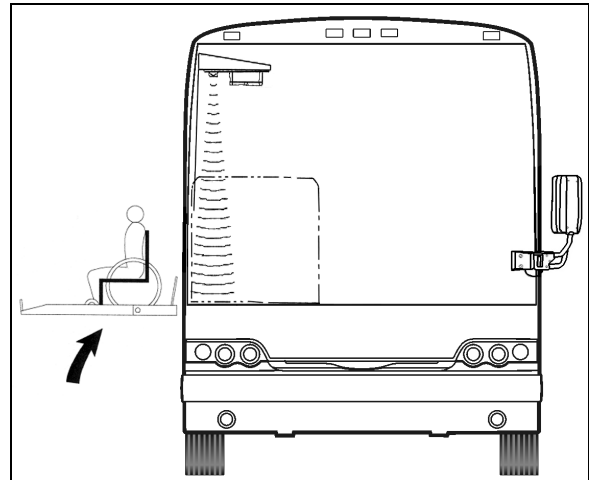

CHECKING NORMAL PLATFORM POSITION

23372

2. Note the sensor timing access hole. This hole provides access to a plunger-actuated switch that sets the sensor timing. Insert a 1/16-inch diameter wire-like object into the access hole and press the plunger inward. The LED will flash momentarily while the module establishes the distance and then remain on steady. Release the plunger when the LED ceases to flash.

NOTE

It is important that objects, such as your body, tools, seats, etc, do not interfere with the beam while the adjustment is being made.

INTERIOR APPOINTMENTS

To accommodate a wheelchair, one row of regular seats must be folded and two rows of regular seats must be folded and slid away on one side of the coach. Seats may be folded on both sides of the coach to make room for a second wheelchair.

An electrical wheelchair or tri-wheeler may require sliding back seats from both sides of the coach to allow enough turnaround space.

To fold a set of seats, raise the seat back then lift up the seat cushion (pull on lever 1). To slide a row of seats, raise the seat locking bar (2) then slide the seat along the track. Push the locking bar down to lock the seat in place.

The wheelchair occupants have a stop request and a reading light switch at their disposal on the window sill of the coach, within easy reach.

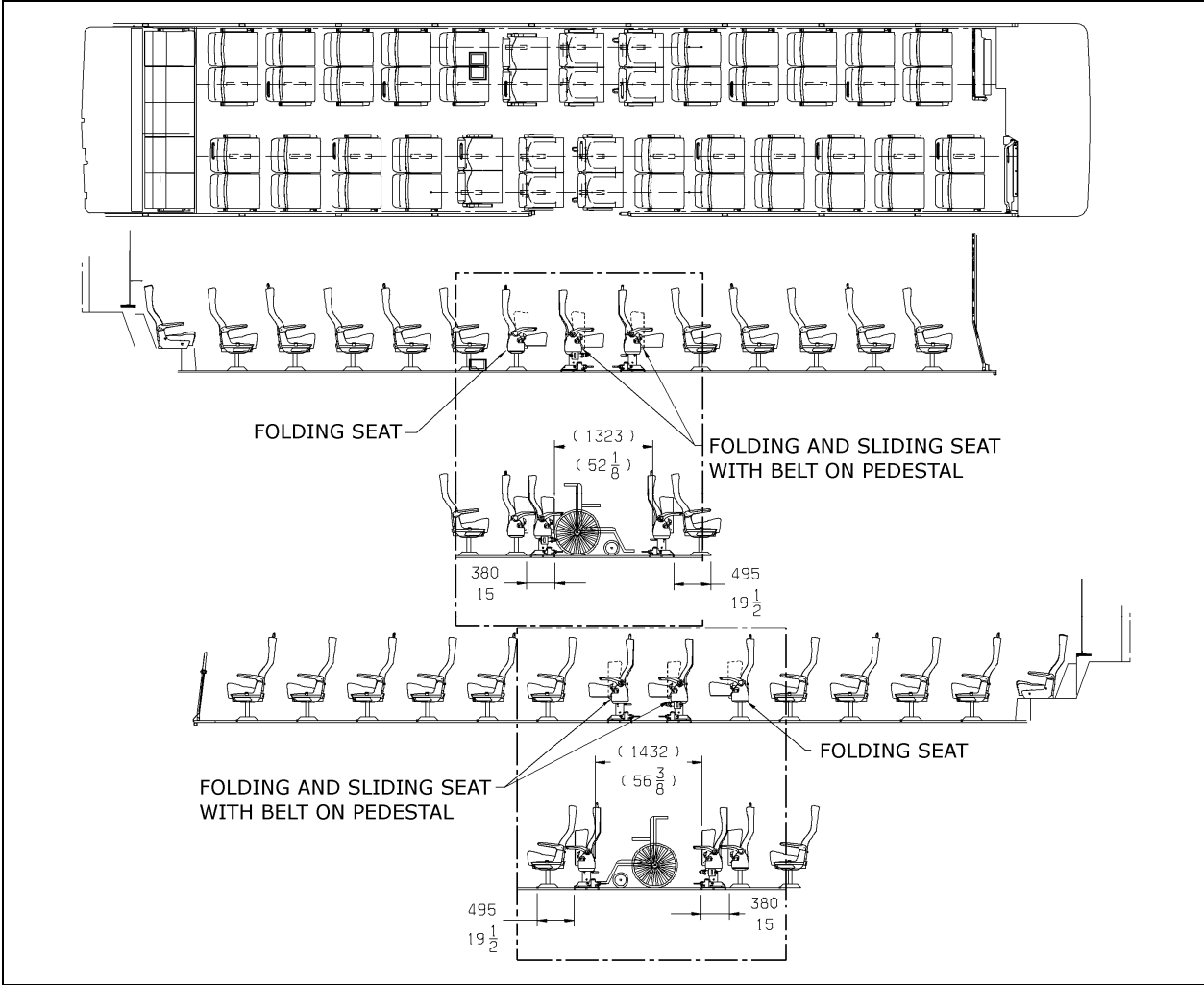

POSSIBLE SEATING ARRANGEMENTS

23259

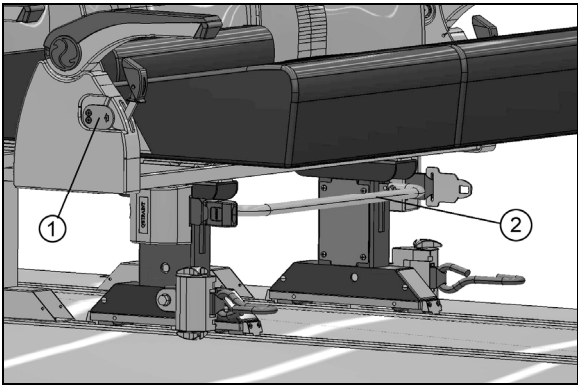

FOLDING SEATS

18430

Accommodating a Wheelchair

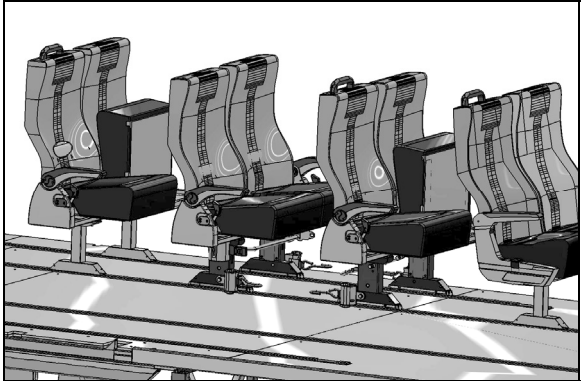

FOLDING & SLIDING SEATS LOCATION

Locate the folding and sliding seats.
 Slide rows of seats to accommodate the wheelchair.

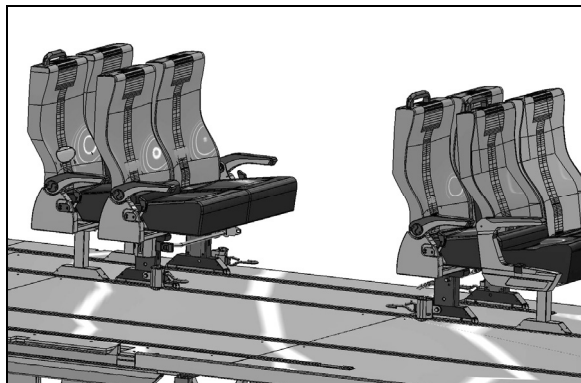

SEATS FOLDED AND SLID

Wheelchair Restraint System

This 4-point anchoring system includes four retractors with restraint belts located at the base of passengers seats, which must be used (at all four corners) to secure each wheelchair.

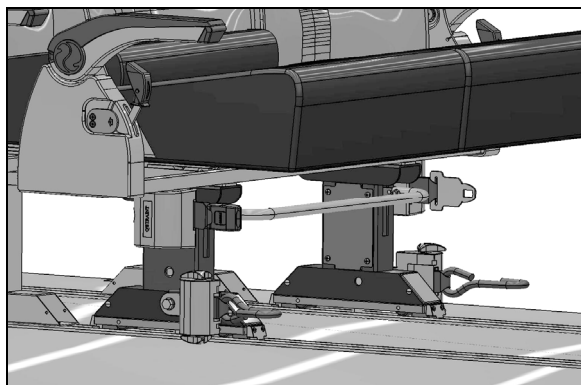

WHEELCHAIR ANCHORING SYSTEM (REAR PORTION)

Secure each hook to each corner of the wheelchair frame (DO NOT USE WHEELS) and allow the retractors to tension the belts.

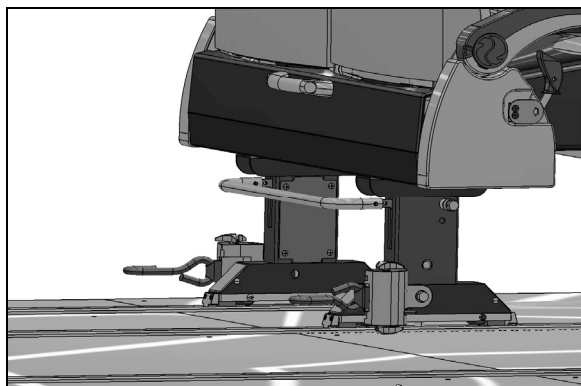

WHEELCHAIR ANCHORING SYSTEM (FRONT PORTION)

To remove the restraint belts, lower releasing lever. Free hooks from wheelchair to allow the belts to retract and guide the belts in, making sure they remain untwisted as they retract.



IMPROPER BELT POSITIONING

23262

Wheelchair Occupant Restraint

Secure the wheelchair occupant in the following manner:

Fasten and adjust the lap belt so it sits snug across the hips. Locate buckle on the center aisle side. Snap the shoulder belt to the attachment on the lap belt. A retractor adjusts shoulder belt length automatically.



CAUTION

Lap belt buckle including red releasing button must always be located on the center aisle side.

To release the belt, unsnap the shoulder belt then press the red button in the center of the buckle.



WARNING

A snug fit with the lap belt positioned low on the hips is necessary to maximize safety. The belt should not be worn or twisted. Avoid pinching the belt and/or hardware. Do not wear over rigid or breakable objects such as eyeglasses, pens or keys as these may cause injuries.



WARNING

Do not let restraint or safety belts rub against sharp edges. Do not bleach or dry clean.

EMERGENCY OPERATION

In the event of electrical power loss, manual operation of the lift is possible as explained below.

To manually deploy the platform

Allow enough space for lift operation and passenger boarding. If a break down situation exists and the vehicle cannot be moved so that the lift system can be operated safely, the operator must summon emergency assistance to move the vehicle before operating the lift.

Fully open wheelchair access and lift doors. Ensure that there are no obstacles in the path of the lift.

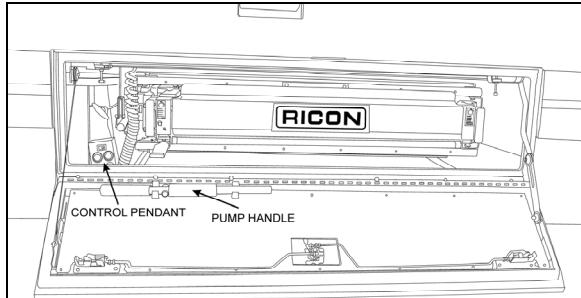

WHEELCHAIR LIFT MANUAL OPERATION 23375

Remove the pump handle from inside the lift mechanism access door. Turn one of the manual platform release shafts using pump handle extension to disengage the platform and then lift the stowlock mechanical catch.

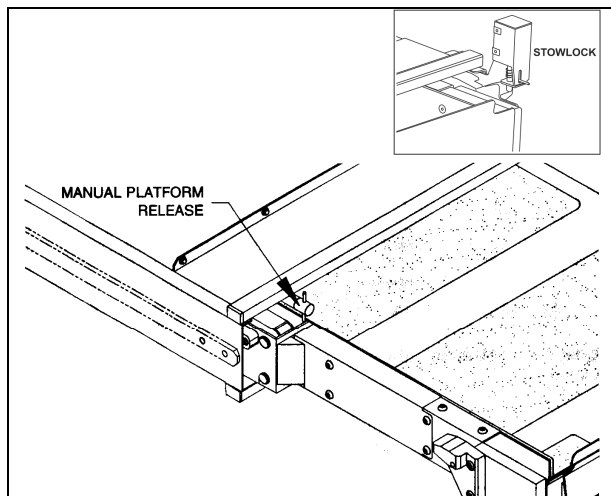

MANUAL PLATFORM RELEASE SHAFT 23334

Grasp the platform and pull firmly until the lift is all the way out against the carriage stops.

To manually raise the platform

Remove the pump handle from inside the lift mechanism access door.

Push the pump release valve actuating rod UP.



CAUTION

During manual rising of the lift, do not raise the platform more than 1-1/2 inches above the vehicle floor level. Any excessive travel will make it difficult to enter the platform and/or damage the lift bridge plate actuator. The outer edge of the bridge plate must rest squarely on the vehicle floor.

Insert handle extension into manual backup pump handle socket and pump to raise the platform to the vehicle floor level.

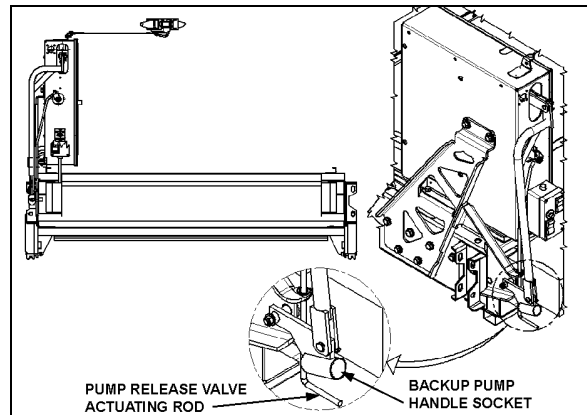

WHEELCHAIR LIFT MANUAL HYDRAULIC PUMP 23373

The lift passenger and attendant must follow the instructions to ENTER or EXIT the vehicle, as previously described.

To manually lower the platform

Slowly pull the pump release valve actuating rod DOWN until the platform begins to lower.

Allow the platform to reach ground level.

Push the pump release valve actuating rod back UP until lightly-snug.

Using the rollstop manual control knob and one hand on the rollstop, OPEN the rollstop.

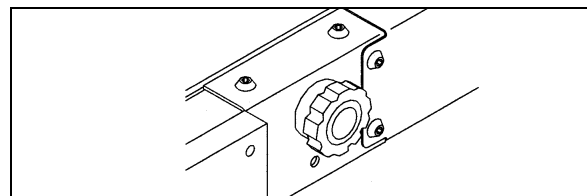

ROLLSTOP MANUAL CONTROL KNOB 23275

The attendant and lift passenger should follow the instructions to ENTER or EXIT the vehicle, as described previously.

To manually stow the platform

Raise or lower the platform to the deploy/stow position; the platform frame must be parallel to the side of the lift enclosure. If the exact position cannot be obtained, slightly low is preferred to slightly high.

Using the rollstop manual control knob and one hand on the rollstop, close the rollstop until it latches.

Use one person on each side of the lift to prevent mechanical binding.

With fingers up and palms forward, push the platform forcefully to start the lift moving inward. As the lift begins to move inward, maintain a constant pushing motion until the lift comes to rest completely inside the lift enclosure.

Push firmly and make sure that the platform manual release shafts have turned to lock the platform.

To manually stow the lift from ground level

In the unlikely event of a hydraulic system failure and the manual backup pump is inoperative, the lift may be stowed as follows by **two or more able-bodied people**:

Raise or lower the platform to the deploy/stow position; the platform frame must be parallel to the side of the lift enclosure. If the exact position cannot be obtained. Slightly low is preferred to slightly high.

Using the rollstop manual control knob and one hand on the rollstop, close the rollstop until it latches.

 WARNING
<p>The platform is heavy and should be lifted using caution and proper lifting technique: Always lift with legs and not the back when attempting to lift heavy objects.</p>

Use one person on each side of the lift to prevent mechanical binding.

With fingers up and palms forward, push the platform forcefully to start the lift moving inward. As the lift begins to move inward, maintain a constant pushing motion until the lift comes to rest completely inside the lift enclosure.

Push firmly and make sure that the platform manual release shafts have turned to lock the platform.

WHEELCHAIR LIFT REMOVAL FOR STORING OR MAINTENANCE PURPOSES

Disconnect connector located at compartment ceiling.

Remove 4 fixing bolts located inside compartment, on each side of platform.

Grasp the platform and pull firmly, sustaining a constant pull so that the platform slides onto the rails until the carriage come in contact with the stops.

Pull the platform until the rear carriage hit against the stops.

Remove platform completely.

 WARNING
<p>For better stability, keep the platform at minimum height when moving.</p>

 WARNING
<p>Before moving platform, make sure that floor is level and free of obstacles.</p>

WHEELCHAIR LIFT INSTALLATION

Raise the platform to proper level.

Insert the platform so that the rear carriage clears the stops.

Insert the platform until the front carriage clears the stops.

Lower the front of the platform.

Push firmly and make sure that the platform manual release shafts have turned to lock the platform.

Secure the 4 fixing bolts located inside compartment, on each side of platform. **Apply a torque of 60 lbf-ft.**

Reconnect connector located at compartment ceiling.

 WARNING
<p>When re-inserting platform into compartment, make sure that carriage wheels are properly aligned over the L. H. side triangular rail.</p>

Starting and Stopping Procedures **83**

STARTING THE ENGINE	84
STARTING FROM THE DRIVER'S SEAT	84
STARTING FROM THE ENGINE COMPARTMENT	84
COLD WEATHER STARTING	85
JUMP STARTING.....	86
ENGINE WARM-UP	87
ALLISON TRANSMISSION WARM-UP	87

STARTING THE ENGINE

In normal circumstances, the engine should be started from the driver's seat. However, a rear-start panel in the engine compartment permits starting the engine from that location, mainly for maintenance purposes.

STARTING FROM THE DRIVER'S SEAT

- Make sure the starter selector switch located in the engine compartment is set to the *NORMAL* position and that the battery master switch (master cut-out) located on the rear electrical panel is set to the *ON* position.

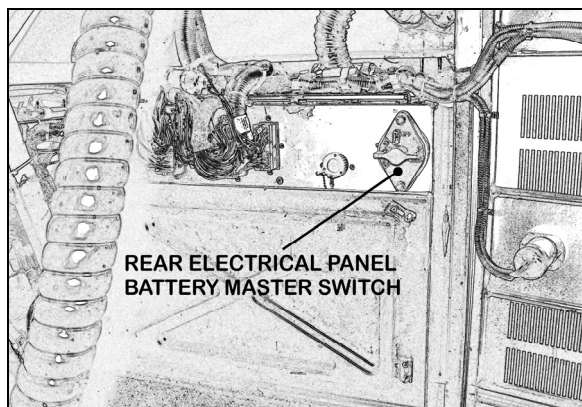

REAR ELECTRICAL PANEL 06621

- Apply the spring-loaded parking brake by pulling the parking brake control button all the way up;
- Place transmission in neutral;
- Turn ignition switch to *START* position (refer to Controls and Instruments chapter), release the key after the engine starts.
- Brake pedal must be applied when selecting Drive (D) otherwise the transmission will stay in neutral (N).

	<p>CAUTION</p>
<p>Do not engage starter for more than 15 seconds at a time. If engine does not start within 15 seconds, release ignition key and let starter cool for one minute before attempting to restart.</p>	

	<p>CAUTION</p>
<p>Do not press accelerator pedal before starting. This could result in an electronic control unit fault and degrade the fuel system control.</p>	

	<p>CAUTION</p>
<p>Special precautions are necessary with turbocharged engines to avoid possible turbine damage. After starting, run the engine at normal idle for two minutes to allow lubricating oil to reach the turbocharger then run the engine at fast idle. Let oil pressure reach normal operating range before driving.</p>	

<p><i>NOTE</i></p>
<p><i>If engine does not start, return key to OFF position before attempting to restart.</i></p>

<p><i>NOTE</i></p>
<p><i>If the accelerator pedal is depressed before starting, release and wait 30 seconds before attempting to restart.</i></p>

Stopping the Engine

- Apply parking brake and place transmission in neutral (N);
- Allow engine to idle for at least two minutes before shutting engine *OFF*. This insures that the turbine speed drops and allows time for the engine exhaust gas temperature to drop to about 300°F (150°C);
- Shut off all electrical loads;
- Turn the ignition switch to the *OFF* position.

	<p>CAUTION</p>
<p>Do not shut <i>OFF</i> engine when running above normal idle.</p>	

	<p>CAUTION</p>
<p>Turn the battery master switch (master cut-out) to the <i>OFF</i> position after parking and when left unattended for an extended period of time.</p>	

STARTING FROM THE ENGINE COMPARTMENT

Switches to start and stop the engine from inside the engine compartment are mounted on a small panel above the air filter.

⚠ DANGER

Apply parking brake and place transmission in neutral (N) before starting engine from inside the engine compartment.

Turn the battery master switches (ignition and master cut-out) to the *ON* position;

Flip the starter selector switch to the *REAR START* position;

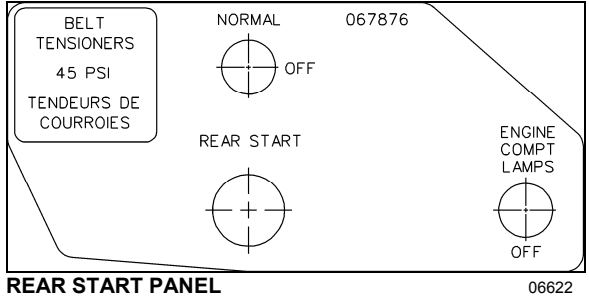

REAR START PANEL 06622

Press the *REAR START* push-button switch, release push-button after the engine starts.

⚠ DANGER

Do not wear loose clothing when working near engine. Stand clear of rotating components.

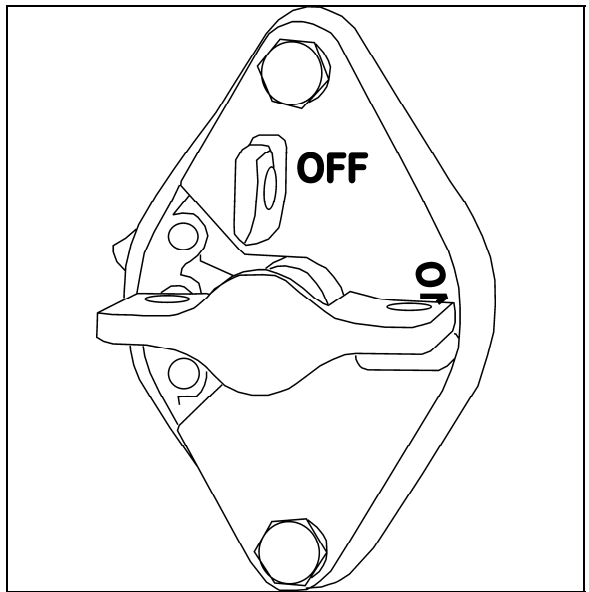

BATTERY MASTER SWITCH

⚠ CAUTION

Refer to cautions in "Starting From The Driver's Seat" in this chapter

⚠ DANGER

Rotating shafts can be dangerous. You can snag cloths, skin, hair, hands, etc. This can cause a serious injury or death. Do not work on a shaft (with or without a guard) when the engine is running.

Stopping the Engine

To stop the engine from the engine compartment, flip the starter selector switch to the *OFF* position.

⚠ DANGER

Make sure parking brake is applied and entrance door interlock is not canceled before stopping the engine.

⚠ CAUTION

Do not stop engine by any other method.

COLD WEATHER STARTING

When starting a cold engine, the intake air should be warmed up by using the intake air preheater. Turn the ignition switch to the *ON* position. The preheater will not engage at coolant temperature above 54°F (12°C). If the coolant temperature is below 54°F (12°C), the preheater will engage and will light the preheater telltale between 0 and 50 seconds, depending on the engine coolant temperature. Wait before the preheater telltale has turned off before starting the engine.

If necessary, once the engine has started, the preheater will reengage (post heating) for the same length of time as the preheat time.

⚠ DANGER

Do not use ether or other combustibile starting aid fluid on any engine equipped with an intake air preheater. If the engine is equipped with a preheater, introduction of ether or similar starting aids could cause a fire or explosion resulting in severe property damage, serious personal injury or death.

JUMP STARTING

In order to avoid damage to solid-state electrical components, it is important that jumper (booster) cables be used correctly and only in emergencies. To jump start, use another 24 volt DC, negative grounded, power source. Use only jumper cables rated at 500 cranking amperes.

 **DANGER**

Injury, explosion, battery acid damage or charging system overload may result if these jump starting procedures are not precisely followed.

 **WARNING**

Wear eye protection and remove rings, metal jewelry and watches with metal bands.

 **DANGER**

The gases given off by batteries while jump starting are explosive. Do not smoke near batteries.

 **DANGER**

The battery could rupture or explode if jump started when the run-down battery fluid is frozen or if the battery fluid level is low. Check condition of run-down battery before attempting to jump start.

 **CAUTION**

Do not let the two vehicles touch. Keep a walk-through distance between the two vehicles. Make sure positive (red) and negative (black) jumper cable clamps do not touch.

 **CAUTION**

Never connect the jumper cable to the negative terminal post of the run-down battery.

 **CAUTION**

Do not jump start if a maintenance-free battery has a yellow test indicator. Have the battery replaced.

 **WARNING**

Before attempting to jump start, make sure the parking brake is applied and the transmission is in neutral (N). Turn off all lights, heaters and other electrical accessories.

 **CAUTION**

Choose a booster vehicle which produces comparable amperage as your vehicle.

To jump start, proceed as follows:

1. Remove the protective plug from the booster block bulkhead connector located in the R.H. side engine compartment;
2. Connect Whittaker type connector to the bulkhead connector. If the good battery is in another vehicle, that vehicle's engine must be shut *OFF* before connecting;
3. Disconnect the jumper cables in reverse order;
4. Install protective plug on the booster block terminal.

NOTE

Jumper cables must be rated at 500 cranking amperes. If jumper cable length is 20 feet (6 m) or less, use 2/0 (AWG) gauge wires. If cable length is between 20 to 30 feet (6 to 9 m), use 3/0 (AWG) gauge wires.

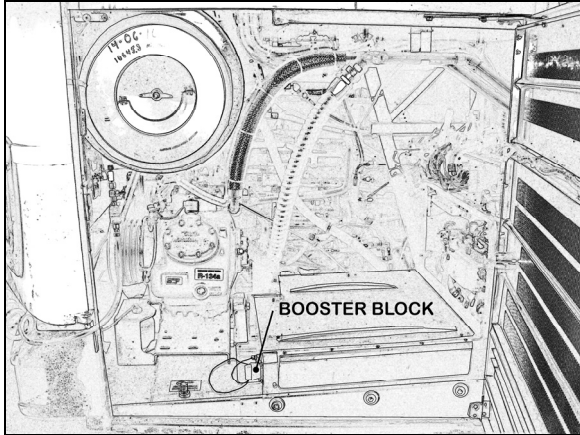

BOOSTER BLOCK LOCATION

06623

ALLISON TRANSMISSION WARM-UP

When the transmission temperature falls below -20°F (-29°C), the CHECK TRANS telltale light illuminates after the engine is started, and a reminder tone will sound. In this case, the transmission will be locked in neutral (N) until the transmission temperature rises above -20°F (-29°C) and the CHECK TRANS telltale light goes out. The transmission will only operate in first or reverse gears until it reaches normal operating temperature.

ENGINE WARM-UP

After starting the engine, keep the parking brake applied and let the engine run at normal idle for two minutes to allow lubricating oil to reach the turbocharger. Increase engine speed to fast idle, using the FAST IDLE switch located on the dashboard for five minutes, without loading the engine. Monitor the gauges and indicator lights to make sure all conditions are normal. If an abnormal condition is observed, stop the engine immediately and have the condition corrected.

DANGER

Never let the engine run in an enclosed, non-ventilated area. Engine exhaust fumes contain dangerous gases which can be fatal if inhaled. Before warming up the engine, open the door(s) or move the vehicle outside.

NOTE

The engine will reach normal operating temperature shortly after driving. Avoid driving at full throttle until engine coolant temperature reaches 140°F (60°C).

EMERGENCY EXITS	90
SIDE WINDOWS.....	90
ROOF HATCH.....	90
EMERGENCY ENTRANCE DOOR OPENING	91
EMERGENCY EQUIPMENT	91
SUPPRESSION SYSTEM (AFSS).....	91
FIRE EXTINGUISHER AND FIRST AID KIT	92
WARNING REFLECTORS	92
JACK AND TOOLS.....	93
JACKING POINTS	93
HYDRAULIC JACK.....	94
TOWING	94
LIFTING FROM THE FRONT.....	94
MOVING A VEHICLE FROM THE REAR.....	96
EMERGENCY AIR-FILL VALVES	97
EMERGENCY AND PARKING BRAKES	97
DAYTIME RUNNING LIGHTS	98
COMPARTMENT LIGHTING	98
MUD FLAPS AND SPLASH GUARDS	98
BACK-UP ALARM	98
ESSENTIAL FUNCTIONS TO OPERATE THE VEHICLE (BASIC LIMP-HOME FUNCTIONS)	98
AVAILABLE FUNCTIONS	98

EMERGENCY EXITS

Locate and learn how to use all possible emergency exits. It is good practice to inform passengers of the location of exits and how to use them in case of an emergency.

SIDE WINDOWS

Some side windows can be opened from the inside for emergency exit. A decal located on the bottom of each passenger window indicates the location of the nearest emergency exit. Also, blue lights close to the wall in the overhead storage compartments illuminate the emergency exit decals. These lights illuminate when the general lighting switch is on.

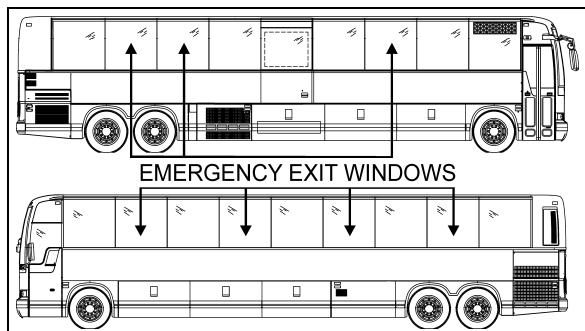

EMERGENCY EXIT WINDOWS (X3-45)

18617

To open a side window emergency exit, tilt up the release bar and push the bottom of the window outwards, as illustrated below. The window is hinged from the top and will not fall out.

A telltale light on the dashboard illuminates when a window is opened. Refer to Controls and Instruments chapter for more information.

To close the window, tilt up the release bar and pull the window back. Push down the release bar to lock shut.

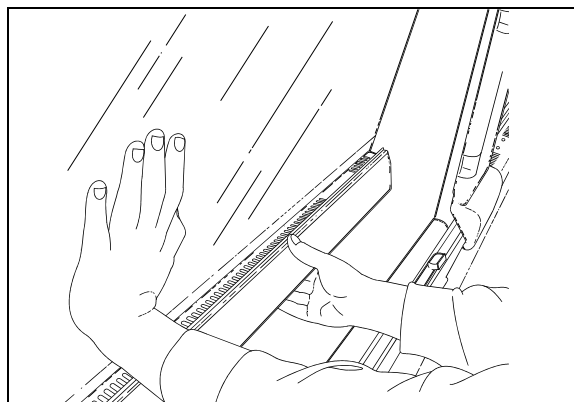

SIDE WINDOW EMERGENCY EXIT

18391

ROOF HATCH

A roof ventilation hatch, designed to be opened by occupants is installed in the roof at the rear of the vehicle. Another roof hatch is located in the front of the vehicle. The hatches can serve as emergency exits. In case of an emergency, push the ventilation hatch upwards (1). Turn knob 1/4 turn (arrow pointing "TO EXIT") and then push knob to release the hatch (2). Push the escape hatch outwards (3). A decal with operating instructions is located on the hatch.

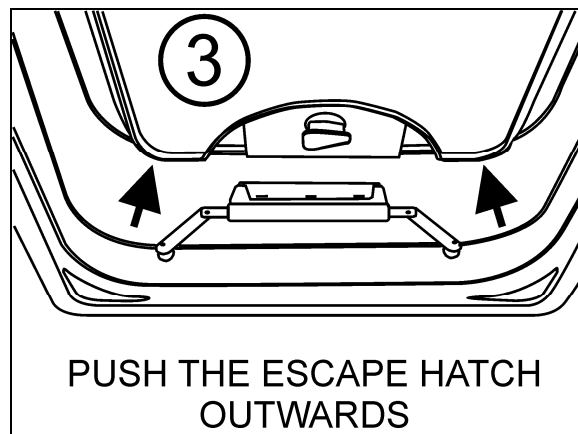
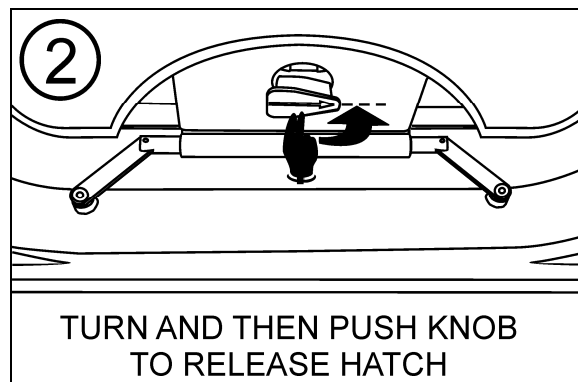
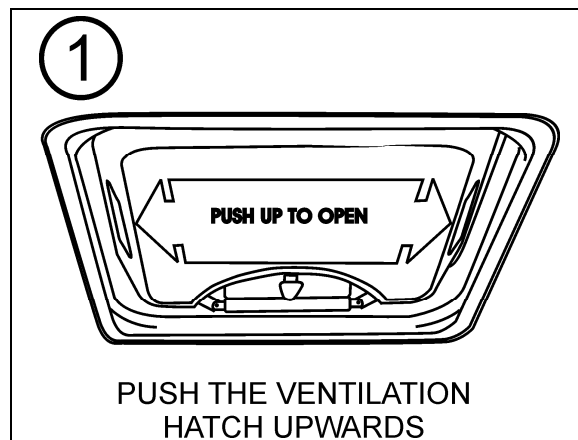

EMERGENCY ROOF ESCAPE OPENING

NOTE
 In the event of ventilation blower motor failure, the roof hatch may be used to aid ventilation by pushing the hatch upwards.

CAUTION
 Be aware of reduced vehicle overhead clearance when driving under overpasses with the roof hatch open.

To latch escape hatch after use, vent arms must be pushed upright in FULL OPEN VENT position. Insert edge firmly between the two sections of the bracket and then return knob to original position (arrow pointing "LATCHED") to lock the hatch. Finally, pull the hatch in to closed position, one side at a time.

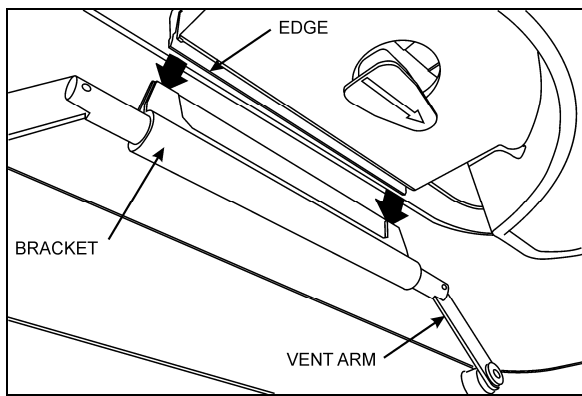

ROOF ESCAPE LATCHING

EMERGENCY ENTRANCE DOOR OPENING

An emergency release air valve located on the dashboard R.H. side allows emergency depletion of the door and latching cylinders. Another unlatch valve is located in the front service compartment and allows opening the door from the outside. To open the door in an emergency situation, first turn the unlatch valve in the direction of the arrows and push (or pull) the door open. To close the door after emergency opening, return the valve to its initial position, open the door using the door cylinder, then close the door normally.

NOTE
 To be able to open the entrance door in an emergency situation, the entrance door must first be unlock using the key or lock lever before unlatching the door from the outside or the inside.

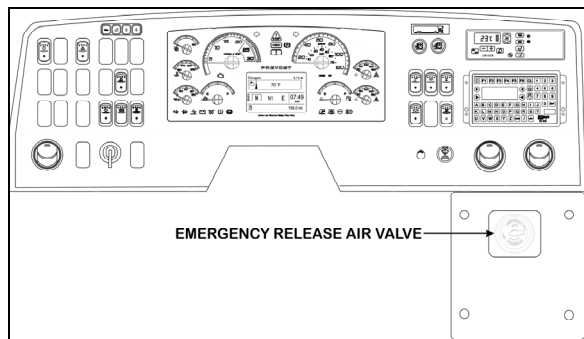

INTERIOR EMERGENCY RELEASE AIR VALVE 12164

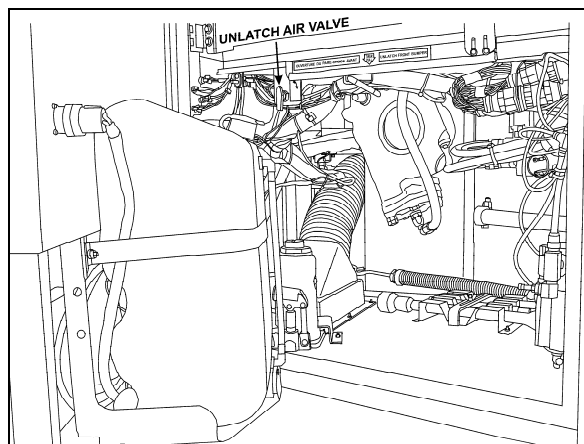

UNLATCH AIR VALVE LOCATION 12209

EMERGENCY EQUIPMENT

SUPPRESSION SYSTEM (AFSS)

The coach is equipped with the Automatic Fire Detection and Suppression System (AFSS).

System operation

When a fire is detected inside the engine compartment, the system sends a fire alarm signal to the **Protection Panel** located in the Driver's area near the lateral control panel. The **Protection Panel** immediately turns on the fire "ALARM" lamp and sounds the audio alarm. After a 15-second time delay the engine is automatically shut down. The fire extinguisher is discharged simultaneously with engine shutdown.

NOTE
 The **Manual Activation Switch** is used when immediate discharge of the fire extinguisher and engine shutdown is desired.

NOTE

The **Protection Panel** continuously monitors system integrity and displays the information via the “SYSTEM OK” and fire “TROUBLE” indicators.

Operational sequence (fire)

1. A fire detector or liner thermal detector detects a fire in the engine compartment and sends a signal to the **Protection Panel** in the driver’s area.
2. The fire “ALARM” lamp on the **Protection Panel** will illuminate solid red and an audible alarm will sound.
3. The operator shall bring the vehicle to a safe stop.
4. The system automatically shuts down the vehicle engine and discharges the extinguisher into the engine compartment 15 seconds after the fire alarm starts unless advanced or delayed by the operator.
 - If the operator presses the **Manual Activation Switch**, all delays will terminate and the engine shutdown and extinguisher discharge will occur immediately.
 - If the operator presses and releases the **Delay Engine Stop** switch once, the engine shutdown and extinguisher discharge will be delayed by an additional 15 seconds.



WARNING

The engine will stop 15 seconds after the fire alarm starts. The operator must be prepared to bring the vehicle to a safe stop as soon as the alarm sounds. Steering may become difficult after engine shutdown. If more time is required, the “DELAY ENGINE STOP” switch may be pressed and released for an additional 15 second delay.



WARNING

The extinguisher discharge may cause an obscuring cloud behind and near the vehicle.

5. The red fire “ALARM” lamp and audible alarm will stay on. The yellow fire “TROUBLE” lamp will also be on indicating a discharged extinguisher.
6. The system must be reset and the fire extinguisher removed and replaced in accordance with the System Reset portion of the Kidde Dual Spectrum Operation & Maintenance Manual.

FIRE EXTINGUISHER AND FIRST AID KIT

The fire extinguisher is located behind the driver’s seat. Instructions for use are found on the extinguishers.



WARNING

Make sure you know how to operate the fire extinguishers in case of an emergency.

The first aid kit is located in the second curb-side overhead storage compartment, above seats 9-10. A white cross over red background decal identifies the first aid kit location.

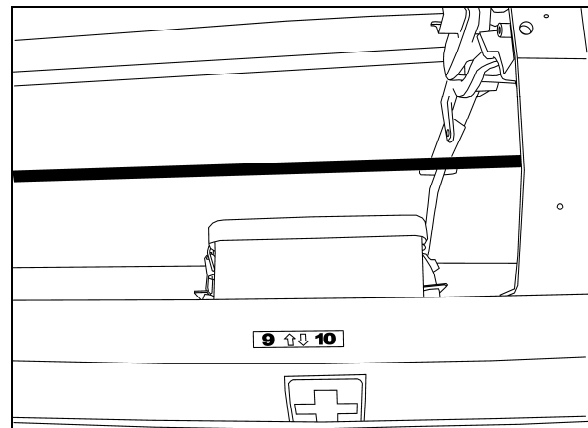

FIRST AID KIT LOCATION

WARNING REFLECTORS

A kit containing three triangular reflectors is provided to warn other drivers on the road in case of a breakdown. The kit is located at the ceiling of the first baggage compartment, on the R.H. side. The reflectors provide visible warning of an emergency situation. The three reflectors should be placed as indicated on the box cover. These reflectors comply with FMVSS 125 (Federal Motor Vehicle Safety Standards).

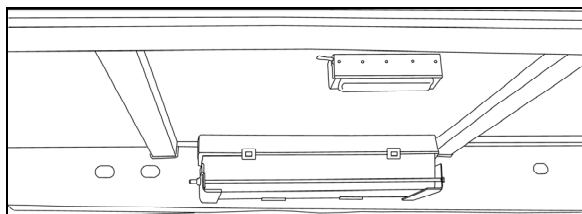

WARNING REFLECTORS LOCATION 23376

JACK / TOOLS

A kit for jacking up the vehicle and changing wheels is stored in the front service compartment. The kit includes a:

30 ton bottle jack;

- Wheel nut wrench and lever.

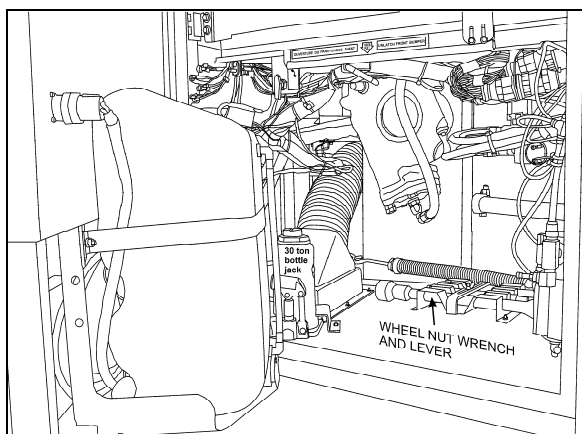

JACK/TOOLS LOCATION 23377

JACKING POINTS

Ten jacking points are located on the vehicle; two are located under each axle. The two jacking points that are located on each side of the frame are equipped with receptacles (pads). Refer to the following illustrations for the location of jacking points.

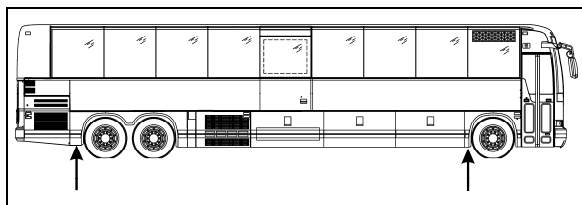

JACKING POINTS ON FRAME 18618

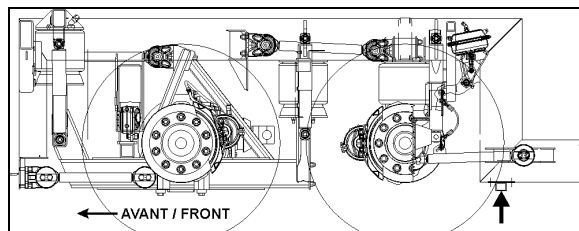

REAR END JACKING POINTS 18593



WARNING

The suspension of the vehicle must be in the normal ride position before jacking.

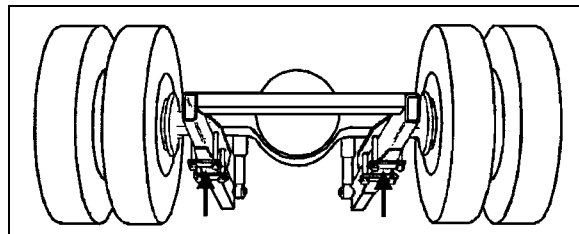

JACKING POINTS ON DRIVE AXLE 11005

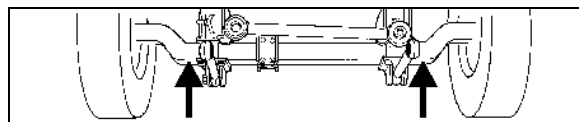

JACKING POINTS ON FRONT AXLE 10005



WARNING

Always unload or retract the tag axle before jacking the vehicle from the front and drive axle jacking points to prevent damage to suspension components.

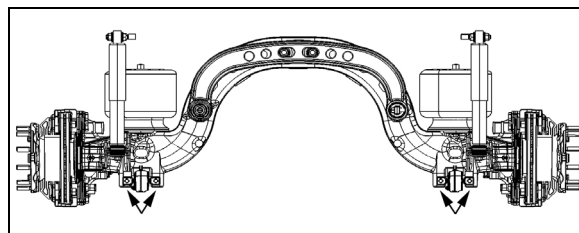

JACKING POINTS ON TAG AXLE 11029



WARNING

The jacking points on the tag axle must be used for raising the tag axle only.

Several kinds of hydraulic jacks can be used. Only jack at the specified jacking points. Jack must support the following capacities:

Front axle: 20,000 lb (9 100 kg);

94 Safety Features and Equipment

Drive axle: 40,000 lb (18 200 kg).

HYDRAULIC JACK

To raise: turn release valve clockwise. Insert handle in socket and raise by pumping.

To lower: remove handle and turn the release valve slowly counterclockwise.

Always keep ram and extension screw retracted when jack is not in use.

Service: Check oil level when jack fails to raise to full height. Lower ram completely with release valve open and jack in upright position, remove filler plug and refill to level of filler hole with hydraulic jack oil. **Never use brake fluid.**



DANGER

Jack is intended for lifting only. Do not get under the vehicle or load for any reason unless it is properly supported with safety stands and securely blocked.



DANGER

Do not load jack above rated capacity. Prevent "side loading", make sure load is centered on ram. Do not push or tilt load off jack.

TOWING

LIFTING FROM THE FRONT

To prevent damage to the vehicle, use the two tow eyes fixed to the vehicle frame between the front axle and the front bumper. Use only a solid link tow bar and a safety chain to tow the vehicle.

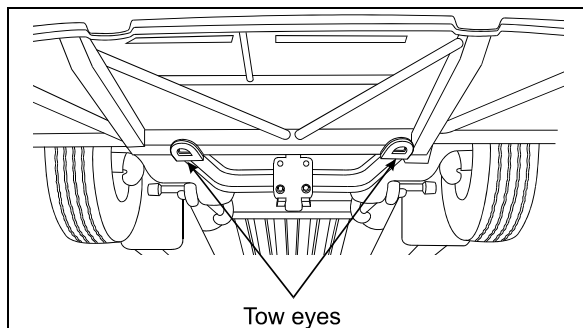

TOW EYES UNDER VEHICLE

18401

- Disconnect driveshaft or remove both drive axle shafts to prevent damage to the transmission. Plug axle tube to prevent oil loss. Refer to Rockwell's "Maintenance

manual no.5" annexed at the end of Section 11: Rear Axle of the maintenance manual.



CAUTION

To prevent damage to the drive train components, disconnect axle shafts or driveshaft before towing. Do not attempt to push or pull-start a vehicle equipped with an automatic transmission.

Failure to disconnect the driveshaft, remove the drive axle shafts or lift the drive wheels off the ground before towing can cause serious transmission damage and void the warranty.

- The towed vehicle must be lifted from under the front end only. The tow truck must be equipped with the proper lifting equipment to reach under the tow eyes or the front axle since no other lifting points are recommended. Lifting and towing from any other point are unauthorized as it may cause serious damage to the structure. Do not unload or raise the tag axle when lifting and towing to prevent overloading the drive axle.



- Raise the front of the coach then install wooden blocks underneath front tires.

- Install axle forks and supports onto tow bar, position axle forks around beam and into tow eyes, insert chains into tow eyes to secure.

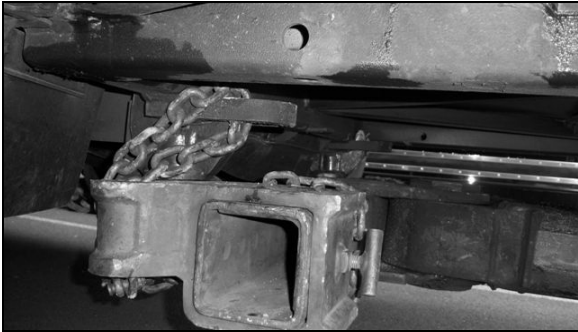

⚠ DANGER
Do not carry passengers while the coach is being towed.

- The coach can also be towed by installing axle forks on the front axle.

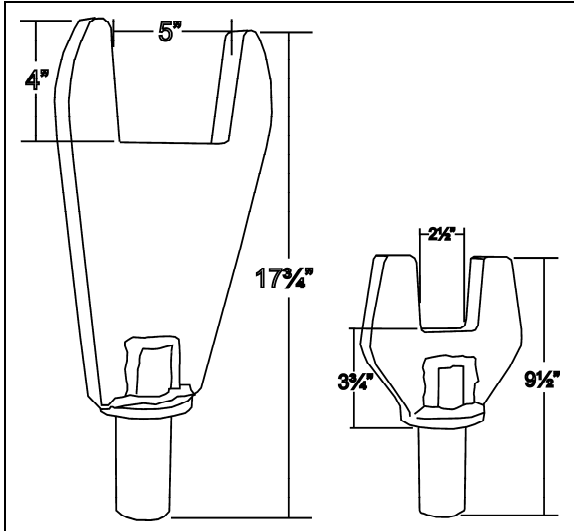

AXLE FORKS



- Install chains around tow bar and front axle.

⚠ CAUTION
Make sure a safe distance (27-28") is kept between the front of the coach and the tow truck. This space ensures that coach does not suffer damages when being towed.



- Flip down the access door located in the front bumper, connect an auxiliary air supply to the two quick connectors so the emergency/ parking brakes don't apply while towing.

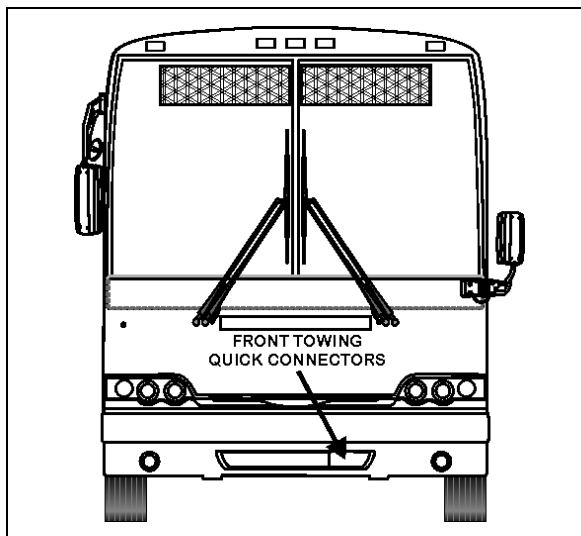

FRONT TOWING AIR SUPPLY CONNECTORS

Towing with a front flat tire

- In case of a flat tire, drive coach over a wooden block to be able to slide the tow bar underneath.



- Repeat previous steps for attaching tow bar to tow eyes or front axle using axle forks and chains.



MOVING A VEHICLE FROM THE REAR

The vehicle should not be towed from the rear unless an emergency situation occurs. If the vehicle has to be moved over a short distance as in a parking lot:

- Chock front vehicle wheels.



- Lift the vehicle rear end. Slide axle forks and supports onto tow bar and install onto engine cradle.



CAUTION

To prevent damage to the vehicle structure, it is not recommended to tow the vehicle from the rear. In case of damage to the drive train components, use a low bed semi-trailer to support the rear end.



DANGER

Do not carry passengers while the coach is being towed.



CAUTION

Make sure axle shafts or driveshaft are installed correctly after towing. Tighten axle shaft and driveshaft nuts to the correct torque settings. Do not invert shafts.

EMERGENCY AIR-FILL VALVES

The vehicle is equipped with two air system emergency fill valves to supplement the air system when air pressure is low and the engine cannot be operated. One valve is located inside the front service compartment. The other valve is located inside the engine compartment.

Both air system emergency fill valves are fitted with standard tire valve stems. The air systems can be filled using any standard external air supply line. The fill valve located in the engine compartment supplies air for all systems (brakes, suspension and accessories). The fill valve located in the front service compartment supplies air for accessories only.

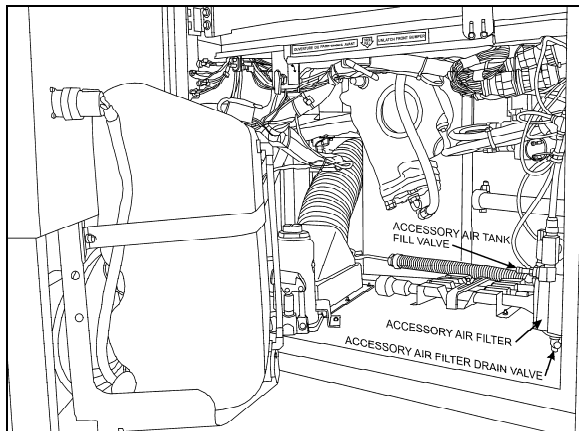

FRONT SERVICE COMPARTMENT

12210

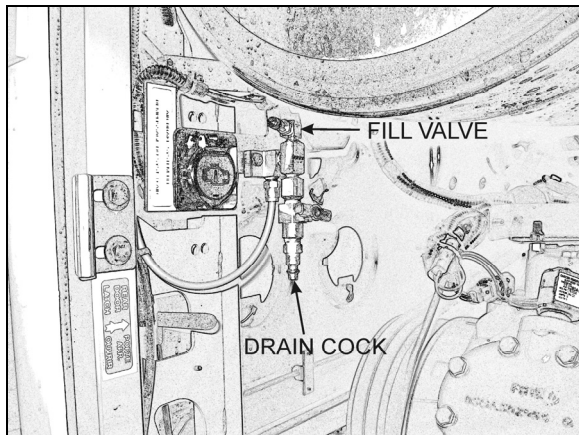

FILL VALVE IN ENGINE COMPARTMENT

12211



CAUTION

Air filled through the two emergency fill valves will pass through the standard air filtering-drying system. Do not fill air at any other location. Do not exceed 120 psi (827 kPa).

EMERGENCY AND PARKING BRAKES

During normal operation, if air pressure in all brake circuits drops below 40 psi (276 kPa), spring-loaded emergency brake will be immediately applied at full capacity to the drive axle wheels to stop the vehicle.

Spring-loaded parking brake is applied by pulling up the control valve knob located on the L.H. lateral console.

Parking brake is not designed to be used as a service brake. For normal driving conditions, the control valve knob must remain in the down position.



DANGER

Always apply the parking brake before leaving the driver's seat.

NOTE

Only use the parking brake to supplement the service brake to stop the vehicle in emergency conditions. The stopping distance will be considerably longer than when using normal service brake.

NOTE

Before releasing the parking brake by pushing down the control valve knob, check the pressure gauges to make sure that the brake system air pressure is greater than or equal to 95 psi (655 kPa).

NOTE

A beep will sound if the ignition switch has been turned off without applying the parking brake. The same beep will sound if pressure is still applied to the service brake pedal.

NOTE

The stoplights will automatically turn on when the parking brake is applied and the ignition key is turned to the ON position.

DAYTIME RUNNING LIGHTS

The inner lamps only also called high beams illuminate automatically when the engine is started and the parking brake is released to serve as daytime running lights. The daytime running lights provide added safety by making the traveling vehicle more visible to other drivers during the day.

The daytime running lights system turns the headlights on when:

- Engine is running;
- Parking brake is released;

The exterior lighting switch is set to the OFF position or pressed to the first position.

	<h3>WARNING</h3>
<p>Do not drive with only the daytime running lights at night because the tail and marker lights are not turned on in that situation and the high beams can blind other drivers. For night driving, turn ON the headlights by depressing the exterior lighting rocker switch to the second position.</p>	

COMPARTMENT LIGHTING

Baggage compartments and front service compartment lights are automatically turned ON when the corresponding compartment door is opened. A pictogram will appear on the status bar of the Driver Information Display (DID) when the baggage compartment door is open.

MUD FLAPS AND SPLASH GUARDS

Mud flaps are installed behind each front and tag axle wheel in order to minimize dirt on the lower panels of the vehicle and prevent stones and debris from being thrown at vehicles traveling behind the vehicle. Mud flaps are also installed on front of each front axle wheel to reduce water splash on rear-view mirrors. Splash guards may be installed behind each dual wheel of the drive axle to prevent stone projectiles from being thrown at the tag axle wheels.

BACK-UP ALARM

The back-up alarm alerts pedestrians and other drivers when the vehicle is being backed-up.

Take extra precautions whenever backing-up. If necessary, use a guide to provide directions when backing-up. The alarm is automatically activated when the transmission is put in the reverse (R) range.

ESSENTIAL FUNCTIONS TO OPERATE THE VEHICLE (BASIC LIMP-HOME FUNCTIONS)

Even with a defective MCM (Master Chassis Module) or a CAN network problem, essential base functions are maintained to rear start the vehicle from the engine compartment and drive in a secure manner.

AVAILABLE FUNCTIONS

- Startup: Turn on the ignition in the driver's area and rear start the vehicle from the engine compartment,
- Opening the door: Functions normally,
- Closing the door: Manually pull on the door and it will lock automatically,
- Windshield wipers: Wipers functions at 1st speed only,
- Headlights: Low beams only,
- Directional signals: Rear and front only,
- Stoplights: 2 upper stoplights + high-mounted stoplight are functional,
- HVAC: Functional with set point fixed at 68°F (20°C), evaporator and condenser fixed at speed 1, defroster fixed at speed 4.

	<h3>CAUTION</h3>
<p>The following directives must be followed.</p> <ul style="list-style-type: none"> • Never connect a battery charger when the ignition is at the ON position on a vehicle with a CAN defective or certain functions will start up by themselves, • Disconnect the charger before starting the vehicle, if not the default functions will not activate, • If the default mode does not activate, try to turn the ignition OFF while ensuring that no charger is connected and then restart the vehicle. 	

CLEANING	100
SEAT UPHOLSTERY	100
PLASTIC AND VINYL	101
WINDOWS	101
STAINLESS STEEL	101
FORMICA	101
CARPET	101
RUBBER COMPONENTS	101
FLOOR CLEANING	101
EXTERIOR SURFACES	101
WINDSHIELD	102
FLUID LEVEL VERIFICATION	102
ENGINE OIL LEVEL	102
TRANSMISSION OIL LEVEL	103
POWER STEERING FLUID LEVEL	104
COOLING FAN RIGHT ANGLE GEARBOX OIL LEVEL	104
DRIVE AXLE WHEEL BEARING OIL LEVEL	104
FRONT AND TAG AXLE WHEEL HUBS	105
COOLANT FLUID LEVEL	105
WINDSHIELD WASHER RESERVOIR	105
OTHER VERIFICATIONS	105
AIR TANK PURGE	105
FIRE EXTINGUISHER	106
PRIMARY FUEL FILTER	106
A/C COMPRESSOR BELT TENSION ADJUSTMENT	106
FAN AND ALTERNATOR DRIVE BELTS	107
AIR FILTER RESTRICTION INDICATOR	107
A/C AND HEATING SYSTEM AIR FILTERS	107
HOSE INSPECTION	108
LUBRICATION	108
WHEELS AND TIRES	108
WHEEL BEARINGS	109
SERVICE BRAKE TEST	109
PARKING BRAKE TEST	109
EXTERIOR LIGHTING VERIFICATION	109
FIRST SERVICE ON NEW VEHICLE	110
ENGINE OIL	110
COOLANT SYSTEM FILTER	110
GENERAL RECOMMENDATIONS	110
WALK-AROUND INSPECTION (BEFORE EVERY TRIP)	113

CLEANING

The cleaning information provided in this section is regarded as recommended cleaning practices. Cleaning results may vary depending on the condition of the stain. Always clean stains promptly for best results.

NOTE
Use only approved cleaning products such as Prevost A.P.C., all purpose cleaner (Prevost # 683664). Never use stain protection products on new fabrics. To prevent permanent staining of fabrics, clean stains soon after they occur. Incorrect treatment of stains can worsen them. Get help from a cleaning specialist to remove stubborn stains.

 **CAUTION**
Custom fabrics and materials may require different cleaning and maintenance practices. Consult your supplier.

SEAT UPHOLSTERY

Firmly beat the fabric with a blunt object, such as a wooden paddle, to release dust and dirt. Vacuum the seat fabric in the direction of the stitching using an upholstery nozzle.

NOTE
The abrasive nature of dirt and grit will reduce upholstery life expectancy. Vacuum regularly.

Removal Of Stains And Marks

Depending on the nature of the stain, apply one of the two methods explained below to remove stains and marks on wool plush.

Method One:

1. Apply a nonflammable solvent (Trichloroethylene) to stained area with a clean, white absorbent rag;
2. Clean stain by starting at the outer edges of the stain and working in toward the center;
3. Blot affected area frequently with a clean, dry absorbent cloth to prevent stain rings caused by excess solvent.

 **WARNING**
Use solvents in a well ventilated area. Open all windows and doors.

Method Two

1. Wet the stain with a solution of household detergent and lukewarm water. Do not soak the stain;
2. Rub the stain with a damp cloth;
3. Rinse cloth after each application.

 **CAUTION**
Do not use soap, soap powder, ammonia, soda, bleach or cleaning products containing any of these compounds.

Beverage Stains

Remove beverage stains by following method one. If stain persists, repeat method one using methylated spirits instead of solvent.

Alcoholic Beverage Stains

Remove alcoholic beverage stains by wetting the stain with water, then cleaning following method two.

Burns

Scrape burnt area using a knife or razor blade then clean following method two. Consult an upholstery specialist when dealing with extensive burns.

Cosmetic Stains

Remove stains left by cosmetics by following method one then method two.

Ink Stains

Remove ink stains following method two. If stain persists, apply a warm oxalic acid solution. Rinse with water.

Blood, Urine Or Vomit Stains

Remove such stains by following method two.

Copying Ink - Ball-Point Pen Ink

Treat with methylated spirits, blotting frequently to avoid spreading stain, followed by method two.

Marking Ink (Felt-tip Pens)

Treat with Methyl-Ethyl-Ketone (MEK) followed by method two.

Oil, Grease And Paint

Remove excess using a knife. Treat with method one followed by method two. If stain persists, repeat procedure.

Rust Stains

Remove rust stains by following method two. Apply a warm oxalic acid solution to stained area. Rinse with water.

Tar

Soften tar with benzene, then treat using method one followed by method two.

Chewing Gum

Soften gum with cyclohexane. Carefully scrape off stains using a sharp knife or razor blade.

PLASTIC AND VINYL

Clean plastic and vinyl trim using a clean damp cloth or sponge. For vinyl trim marks, use a lukewarm all purpose cleaner or a mild saddle soap. Remove water spots and soap traces using a clean damp cloth or sponge. Dry with a clean soft cloth.

Remove grease, tar or oil stains with a clean cloth or sponge and an all purpose or solvent-type vinyl cleaner.

Apply a colorless vinyl or leather protective product to maintain the luster and pliability of the plastic or vinyl surface.

WINDOWS

Clean the inside of the windows with a solution of one part vinegar to ten parts water.

STAINLESS STEEL

Use a stainless steel cleaner and follow the manufacturer's instructions. Stainless steel cleaning solution may be ordered from Prevost Car Inc. quoting part number 68-0356.

FORMICA

Remove stains on Formica surfaces with a household detergent, methylated spirits or mineral turps. Clean with a mild abrasive and water solution if stain persists.

CARPET

Vacuum carpets regularly to prolong carpet life.

RUBBER COMPONENTS

Use only pure water or glycerin to clean stains on rubber components.

**CAUTION**

Never use solvents on rubber components.

FLOOR CLEANING

Clean vinyl floors with a quality nonionic detergent cleaner. Follow the manufacturer's recommendations for cleaning.

Remove any excess detergent solution using a wet/dry vacuum or mop. Rinse floor with a solution of one part Clorox to ten parts warm water.

Polish dry floor using a high-speed buffer and a smooth red 3-M polishing pad.

Mop floor periodically with a solution of 5 per cent Clorox in warm water.

NOTE

For custom or special floor covering materials, consult the manufacturer or your converter for information on how to clean and maintain these types of floors.

**CAUTION**

Using a water hose to clean the floor is prohibited since it could cause electrical shorts or damage the electrical system.

EXTERIOR SURFACES

Frequent washing and waxing of the vehicle exterior will help protect the finish and luster. The paint finish is attacked by the abrasive effects of airborne particles and corrosive pollutants.

Before washing the exterior of the vehicle, close the fresh air dampers using the "REC" button located on HVAC control panel and on the air intake duct in the evaporator compartment. Install keyhole protectors to prevent water from penetrating. Rinse vehicle with water to remove all loose dirt. Wash vehicle using a quality brand car wash soap. Follow manufacturer's recommendations for cleaning. Rinse well with water.

The vehicle exterior should be cleaned, waxed and buffed when water droplets no longer form on the painted surfaces.



CAUTION

Hot water can damage paint. Keep water cool or lukewarm.



CAUTION

- Make sure cleaning solutions are not harmful to painted surfaces. Read the manufacturer's instructions before using.
- Do not spray water jet directly into fresh air inlet dampers.
- Do not aim high pressure water jet at radiator doors. This could damage the radiator fins.

To prevent corrosion, remove caked-on dirt and road salt from the vehicle underbody using a high pressure water jet. Clean wheel housings, bumpers, muffler, tailpipe and brackets.

Carry out corrosion prevention cleaning at least twice a year. Spray underneath of the vehicle and let soak before cleaning. Let engine and exhaust system cool down before cleaning.

Tar Or Oil

Remove tar or oil as soon as possible with an approved automotive tar and oil remover or turpentine. Thoroughly clean area with car wash soap and water. Let dry, then wax.

Insects

Remove insect stains as soon as possible with lukewarm soap and water or insect remover.

Tree Sap

Remove tree sap or bird droppings with lukewarm soap and water. Do not allow to harden.

WINDSHIELD

To prevent windshield wiper streaking, keep silicone sprays away from windshield. Remove road film and wax build-up from windows with lukewarm soap and water or with an alcohol-based cleaning agent. If a chamois is used to dry and polish glass, use it exclusively for that purpose.

Wiper Blades

To avoid tearing frozen wiper blades, loosen them before removing. Remove and clean wiper blades periodically with an alcohol-based cleaning solution. Clean wiper blades using a sponge or soft cloth.

FLUID LEVEL VERIFICATION

Periodic inspection of oil and fluids levels is the most economical and easiest way to help your vehicle perform at its best. Rigorous oil level inspection and replacement will greatly help minimize expensive and unscheduled repairs.

ENGINE OIL LEVEL

Check engine oil level when engine is still warm and with vehicle parked on a level surface. Shut *OFF* engine and wait at least 10 minutes for oil to drain into oil pan before checking. Check engine oil level daily or before each trip. Add oil as required. Do not overfill. Remove dipstick, wipe clean and fully reinsert to ensure an accurate reading. Remove dipstick and check engine oil level.

Do not let the oil level fall below the marking on the dipstick. **Do not** overfill so the level is above the upper marking on the dipstick. Add oil through the oil filler pipe as required in order to maintain level within the safe range

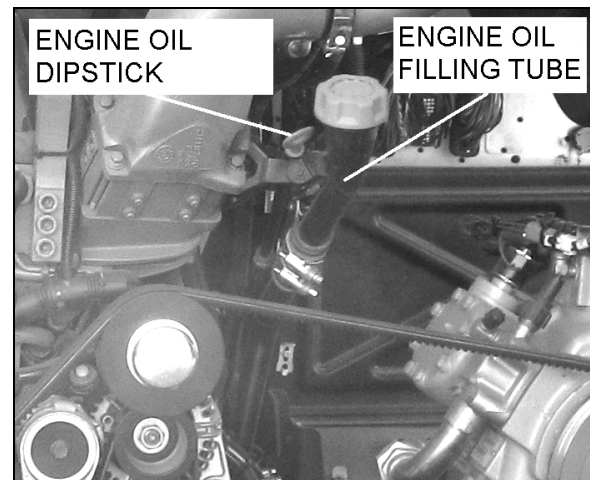

ENGINE OIL DIPSTICK - VOLVO D13 ENGINE 01192

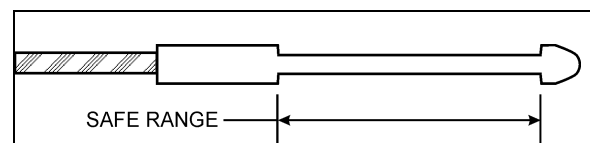

VOLVO D13 ENGINE OIL LEVEL DIPSTICK 01195

TRANSMISSION OIL LEVEL



DANGER

To prevent personal injury, do not service transmission wearing loose clothing. Stand clear of the engine and rotating components while checking the oil level.



CAUTION

Do not mix fluid types or brands because of possible incompatibility.



CAUTION

Use clean fluid and containers when filling transmission. Never use containers that have contained water or anti-freeze (Glycol).

Transmission fluid level may be checked using dipstick or transmission control pad display. For more information on how to use the shift selector display to check the transmission oil level, refer to Appendix C under "Allison transmission oil level check using the pushbutton shift selector" in this manual.

The transmission fluid level dipstick is accessible through the engine compartment rear door and is located on the left side of the engine.

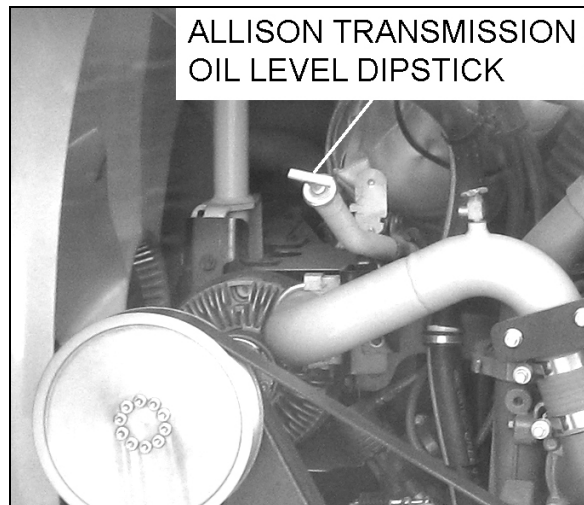

ALLISON TRANSMISSION OIL LEVEL DIPSTICK

ENGINE L. H. SIDE

01189

To check the transmission fluid level, a "cold check" and a "hot check" must be performed. A cold check must be made when the transmission fluid is between 60°F and 120°F (16°C and 50°C).

NOTE

Perform the cold check first to verify the transmission fluid level before performing the hot check.

To prevent dirt and foreign matter from entering the transmission, clean the end of the oil fill tube before removing dipstick. To remove dipstick, unscrew filler cap approximately three turns and pull out dipstick.

- **Cold Check**

Run the engine until the transmission fluid temperature is between 60°F and 120°F (16°C and 50°C). With the engine idling, make sure the parking brake is applied and the transmission is in neutral (N). Remove and wipe the dipstick with a clean cloth. Check oil level. If the oil level is within the COLD RUN band, the oil level is correct and a hot check can be performed. If the oil level is on or below the lower line of the COLD RUN band, add oil until the level lies within the COLD RUN band. If the oil level is above the COLD RUN band, drain oil until the level is within the band.

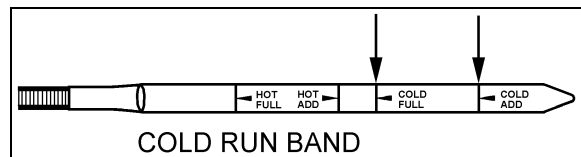

TRANSMISSION FLUID LEVEL DIPSTICK (TYPICAL) 07050



CAUTION

The oil level rises as oil temperature rises. Do not add oil above the "cold run" band before the transmission reaches 180°F to 220°F (82°C to 104°C).

- **Hot Check**

Make sure the transmission fluid temperature is between 180°F and 220°F (82°C and 104°C) before performing the hot check. Run the engine between 1,000 and 1,200 RPM for approximately one minute to purge air from the system. With the engine idling and the parking brake applied, shift transmission from forward (D) to reverse (R) and back into neutral (N) to fill clutch cavities with oil. Remove and clean dipstick, then check oil level. If the oil level is on or under the lower HOT RUN line, add just enough oil to bring up the level to the middle of the HOT RUN band.

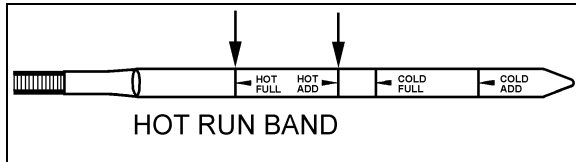

TRANSMISSION FLUID LEVEL DIPSTICK (TYPICAL) 07049

Replace dipstick and tighten the filler tube cap until the rubber seal is correctly seated.

CAUTION

Do not overfill transmission fluid reservoir. Severe damage may result.

POWER STEERING FLUID LEVEL

The coach is equipped with a power steering system. The hydraulic fluid tank is located in the engine compartment behind the engine air intake pipe and above the alternators.

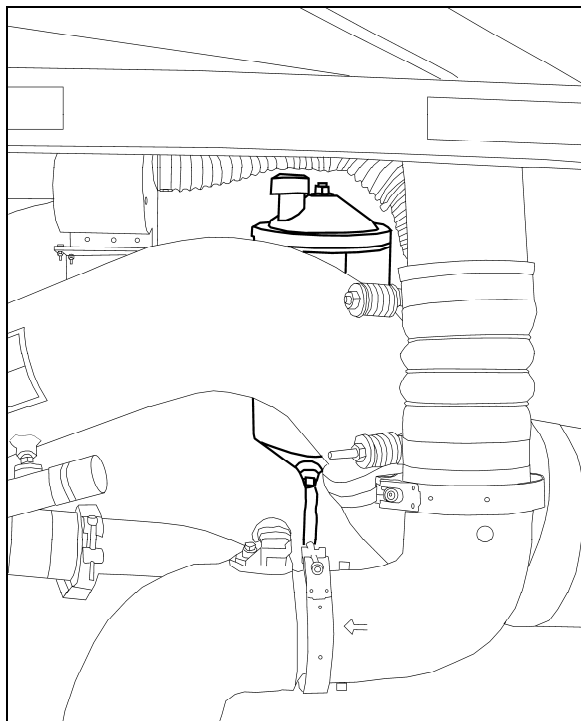

ENGINE COMPARTMENT 14059

Check fluid level as follows:

1. Stop engine, open engine compartment doors and place rear start switch to *OFF* position;
2. Unscrew and remove the dipstick located on top of the fluid tank and wipe with a clean rag;
3. Replace dipstick in tank, then remove to check fluid level;

4. Add hydraulic fluid until it reaches the **FULL** mark on the dipstick (use Dexron II, Dexron IIE, Dexron III or Mercon fluid type);
5. Replace and tighten dipstick;
6. Place engine rear start switch to *NORMAL* position. Close engine compartment doors.

COOLING FAN RIGHT ANGLE GEARBOX OIL LEVEL

Check cooling fan right angle gearbox oil level as follows:

1. Stop engine, open engine compartment doors and place engine rear start switch to *OFF* position;
2. Remove side oil filler plug;
3. Add oil through the top or side oil filling point if the oil level has fallen below the side oil filling point;
4. The oil level is correct once the top of the oil has reached the bottom of the side oil filling point or once oil has already started to escape from the side oil filling point;
5. Replace the seal and screw the side and top filler plugs back in;
6. Place engine rear start switch to *NORMAL* position. Close engine compartment door.

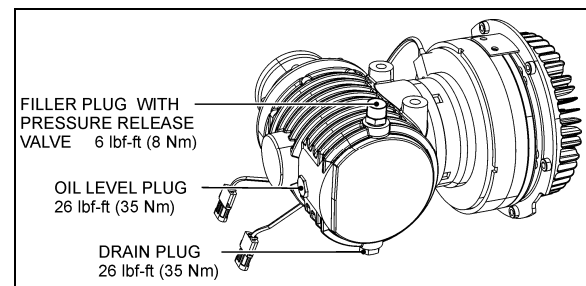

RIGHT ANGLE GEARBOX OIL LEVEL CHECK 05118

DRIVE AXLE WHEEL BEARING OIL LEVEL

Drive axle wheel bearings are lubricated by the differential oil. Maintain differential oil at correct level to ensure adequate lubrication of drive axle wheel bearings at all times.

FRONT AND TAG AXLE WHEEL HUBS

The unitized hub bearings used on the NDS range of axles, are non-serviceable items. Bearings are pre-adjusted, lubricated and have seals fitted as part of the manufacturing process. The bearings are greased for life and there is no need or facility for re-lubrication.

COOLANT FLUID LEVEL

Coolant level is correct when coolant is visible through the surge tank sight glass when cold. Fill the tank as necessary with the same 50/50 water-antifreeze mixture normally used. **Do not** mix two different types of coolant. Refer to the Maintenance Manual for proper coolant type specifications or see the label affixed near the coolant surge tank on the vehicle.

When the coolant level reaches the coolant surge tank level sensor, the STOP telltale light illuminates, a beeping tone rings and “ENGINE COOLANT LEVEL CRITICALLY LOW” message appears in the DID. Stop the vehicle in a safe location and add coolant to the cooling system surge tank as soon as possible.

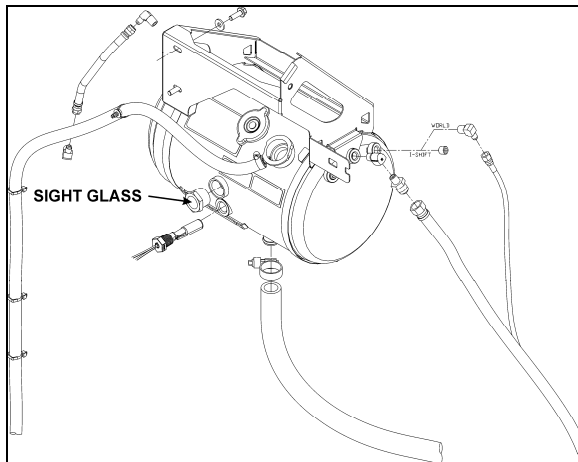

COOLANT LEVEL SIGHT GLASS 05094

WARNING

Hot engine coolant is under high pressure. Allow engine to cool down before adding coolant.

WINDSHIELD WASHER RESERVOIR

The windshield washer reservoir is located in the front service compartment door. The windshield washer reservoir has a capacity of 5.3 US gallons (20 liters). Check fluid level regularly.

The windshield spray jets are located on the windshield wipers and are angled to spray towards the center of the windshield.

You may use water or windshield washer fluid as well.

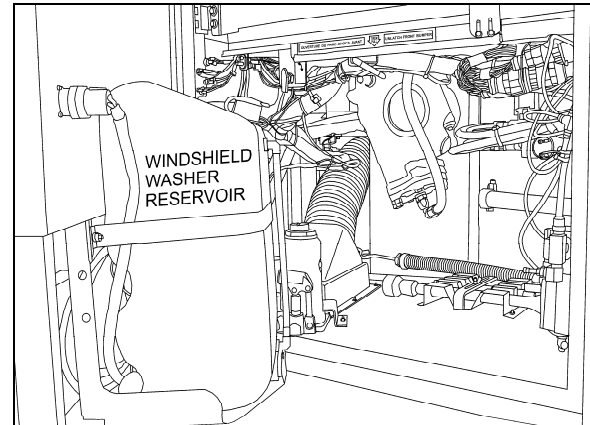

WINDSHIELD WASHER RESERVOIR 18619

CAUTION

During cold weather days, use windshield washer fluid suitable for freezing temperature only.

OTHER VERIFICATIONS

It is good practice to regularly inspect the vehicle for signs of component wear and to perform safety and maintenance routines.

AIR TANK PURGE

The vehicle is equipped with six air tanks. Purge accessory and wet air tanks before each trip. The primary, secondary, kneeling and parking brakes overrule air tanks must be purged at every oil change. Oil changes should be scheduled at least every 25,000 miles (40 000 km).

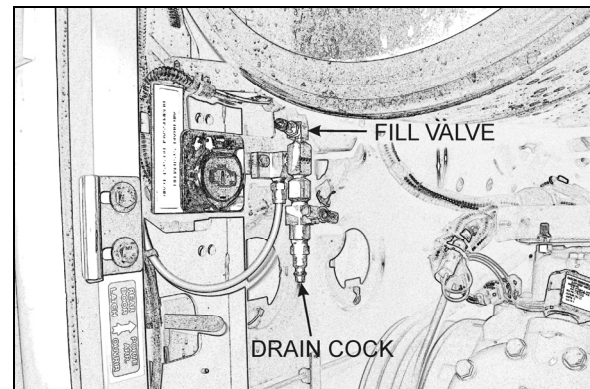

ENGINE COMPARTMENT R. H. SIDE 12211

The accessory air tank drain cock is accessible from the front service compartment.

The parking brakes overrule air tank is located at the ceiling of the last baggage compartment.

The wet air tank drain cock is accessible from the engine compartment. All air tanks are equipped with a drain cock underneath the tank. Refer to "General Recommendations" in this chapter for tank locations.

Drain tanks by turning cocks counterclockwise.

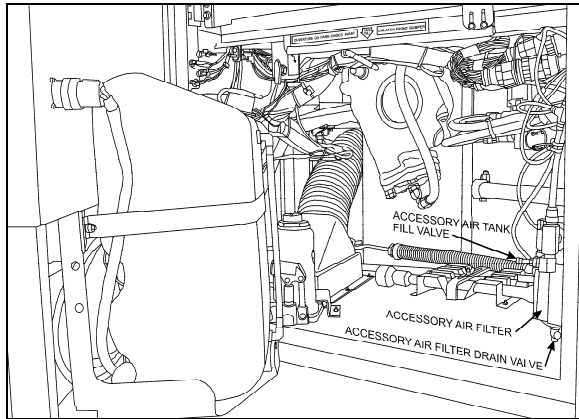

FRONT SERVICE COMPARTMENT

12210

FIRE EXTINGUISHER

Inspect fire extinguisher monthly to insure operation in emergency situations.

On extinguishers with a pressure gauge, the needle should be in the green or *NORMAL* range. Refill or replace extinguisher if pressure is below normal;

Check that seal on handle is intact;

Check that hose nozzle is in good condition and the nozzle is free of obstructions;

Keep fire extinguishers clean.

PRIMARY FUEL FILTER

A primary fuel filter is installed on the engine. This filter may consist of a filter cartridge with a drain valve at the bottom, or a filter cartridge, a water separation bowl and may have a fuel heater built in. It is used to prevent water from entering the fuel system. The primary fuel filter should be drained periodically or when the telltale light on the dashboard illuminates if equipped with this system. To drain water, loosen the drain valve below the separator. Close the drain valve when finished.

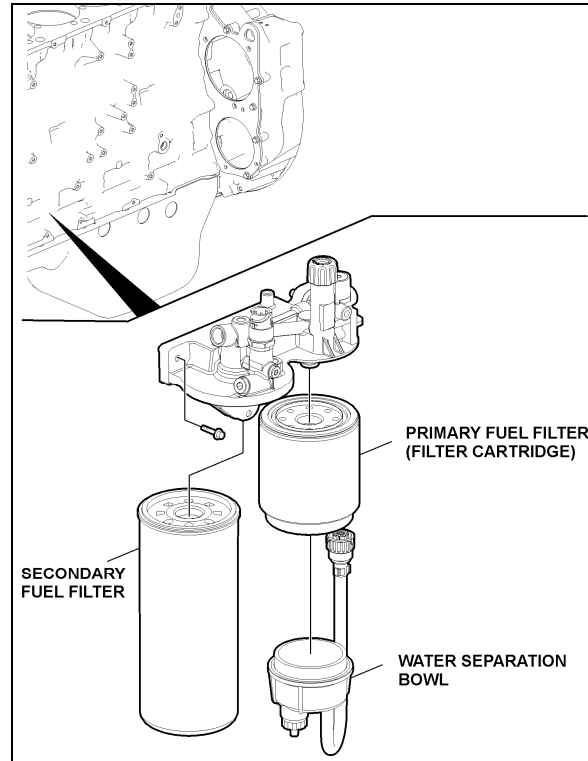

FUEL FILTERS WITH VOLVO D13 ENGINE

03085

A/C COMPRESSOR BELT TENSION ADJUSTMENT

The air conditioning compressors are driven by V-belts.

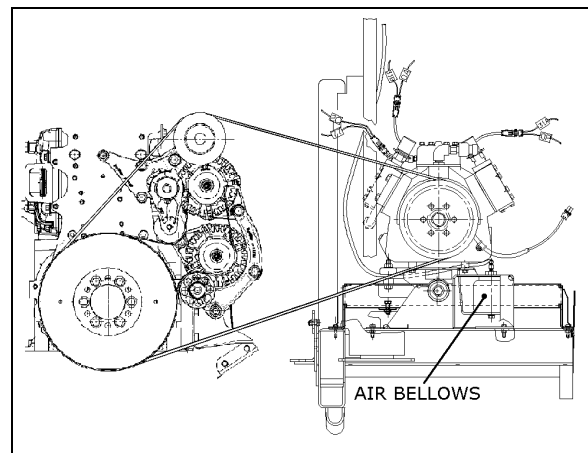

AIR BELLOWS

22288

Belt tensioning is applied through air bellows which are adjusted by an air pressure regulating valve mounted in the engine compartment, right behind the belt tensioning pressure control valve. The correct pressure of 45 psi (310 kPa) is set at the factory. Periodically verify the pressure at the regulating valve using a pressure gauge and correct if necessary.

For belt replacement, air pressure must be released from bellows by means of the belt tensioning pressure control valve. This valve, mounted close to the pressure regulating valve, is manually operated. Before handling, set the rear start switch to OFF and observe all applicable safety precautions.

- Refer to the Parts Manual, Maintenance Manual or "Service Bulletins" for recommended belt sizes and tension settings;
- Periodically inspect belt and pulleys for wear or damage;
- Do not treat belts with any compounds. Keep belts dry.

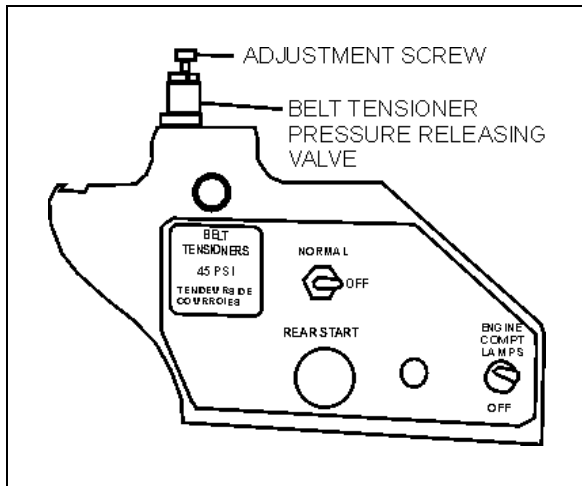

PRESSURE REGULATING VALVE 12200

FAN AND ALTERNATOR DRIVE BELTS

These belts have automatic belt tensioner to keep the correct tension without adjustment.

AIR FILTER RESTRICTION INDICATOR

A filter restriction indicator (optional) is used to monitor the vacuum level between the air filter and engine. A red marker is displayed when the air filter is clogged. Replace the air filter when a red marker is displayed or after a maximum of two years. Reset by pressing on the indicator's extremity.

The filter restriction indicator is located on the engine air intake duct

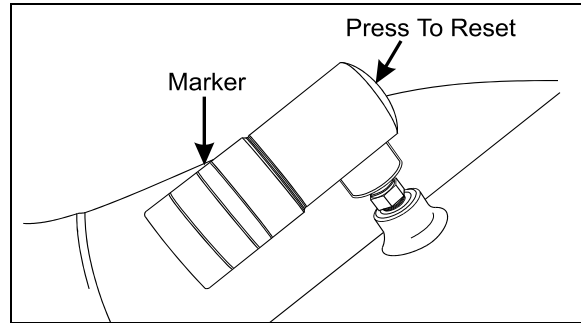

AIR FILTER RESTRICTION INDICATOR 01052

A/C AND HEATING SYSTEM AIR FILTERS

For maximum air conditioning and heating system efficiency, air filters should be inspected, cleaned and replaced as required in maintenance schedule to ensure proper ventilation of the evaporator and heating radiator cores.

CAUTION

Do not use high pressure water jet to avoid damaging filter. Be sure not to reverse filters upon installation.

Driver's Area Air Filters

The driver HVAC system's air filters are located behind the R.H. console. To gain access to the A/C filters, unscrew the grill located at the top step of the entrance door steps. Remove the filters for cleaning or replacement.

NOTE

If the windshield is continuously fogged, check that the driver's air filter is not clogged.

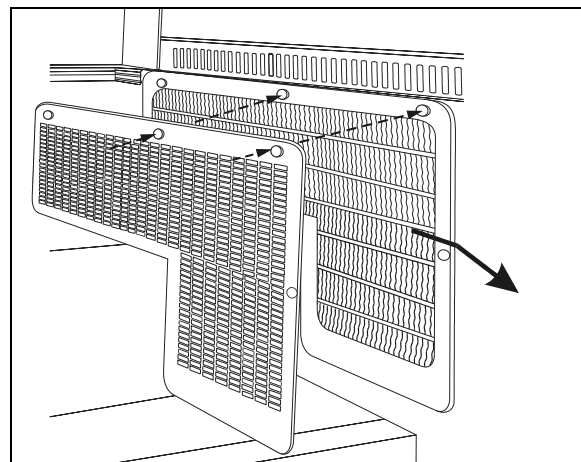

DRIVER'S AREA AIR FILTER REMOVAL 22193

Passengers Area Air Filter

The central HVAC system's air filter is located in the evaporator compartment on driver's side of the vehicle. To access, open the baggage compartment forward of the evaporator compartment. An access door held shut by six retaining screws is located in the wall separating the baggage compartment and the evaporator compartment. Slide out the filter for maintenance purposes.

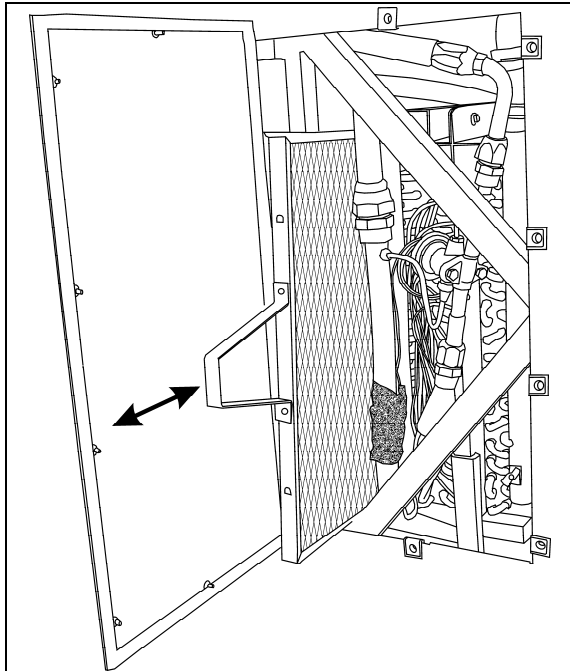

PASSENGERS AREA AIR FILTER REMOVAL 22306

CAUTION
Be sure not to install filter in inverted position.

Air Filters in the Overhead Compartments

Remove, clean or replace the air filter located behind each overhead baggage compartment fan.

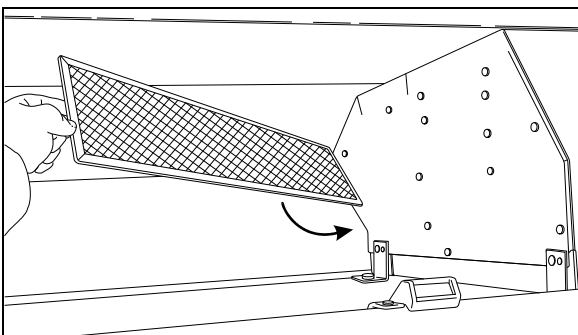

OVERHEAD COMPARTMENT FAN AIR FILTER 22201

HOSE INSPECTION

Inspect hoses for leaks regularly to ensure efficient, economical and safe operation of the engine and related equipment. Carefully inspect all fittings, clamps and ties. To prevent chafing, make sure hoses are not touching shafts, couplings, heated surfaces, sharp edges or other parts. Since hose clamps and ties can vibrate loose or fail over time, inspect frequently and tighten or replace as necessary.

Correct leaking hoses immediately. Failure to correct leaks can cause severe damage to the equipment, as well as increase operating costs due to lost fluids. Treat fuel and oil leaks as an immediate fire hazard.

WARNING
Personal injury and property damage may result from fire caused by leaking flammable fluids.

Hose Service Life

Hoses have a limited service life. Thoroughly inspect hoses annually. Look for surface damage or indications of twisted, worn, crimped, cracked or leaking lines. Replace damaged hoses immediately.

Hoses should be replaced during major overhaul or after a maximum of seven years service. Be certain replacement hoses match the original equipment manufacturer's specifications.

LUBRICATION

Grease all lubrication points during scheduled maintenance. For heavy loads or extended use, lubricate more often. Refer to the Maintenance Manual, section 24 for information on lubrication.

WHEELS AND TIRES

Check for loose wheel nuts. Inspect all types of rims for cracks. Cracks can appear in many places but typically radiate out from where a load is applied. Both aluminum alloy and steel wheel nuts should be tightened to 450 to 500 foot-pounds (610 to 680 N.m.) torque.

Keep the tires inflated to the recommended inflation pressure to prolong tire life and for safety.

NOTE

Recommended tire inflation pressures are given in the "Coach Final Record", placed in the technical publications package supplied with the vehicle. The cold tire inflation pressures are on the Department of Transport certification plate located on the L.H. console besides the driver's seat. When special tires are installed by Prevost on a new vehicle, a special tire inflation chart is added next to the certification plate.

**WARNING**

Do not exceed maximum inflation pressure. Incorrect tire pressure increases tire wear and could lead to loss of driving control because of reduced road handling. Check tire pressure regularly.

WHEEL BEARINGS

Check wheel bearing cover for overheating (especially after using the service brakes) during fuel stops by touching the wheel bearing cover.

**WARNING**

If replacement tires are different from those described on the certification plate, pressure must be adjusted as requested in the Tire and Rim Association Manual.

SERVICE BRAKE TEST

Check for correct pressure build-up. Stop engine and check pressure gauge. Pressure loss should be imperceptible with engine stopped and without brake pedal applied. Air loss should not exceed 3 psi/minute (21 kPa/minute) with engine stopped and brake pedal fully applied.

PARKING BRAKE TEST

Release parking/emergency brake. Pump service brake pedal until air pressure drops to 65 psi (448 kPa). Make sure the warning buzzer operates and that the emergency brakes apply (the control valve knob lifts up). Allow air pressure to reach 95 psi (655 kPa) before releasing parking brake.

Driving the vehicle while the parking brake is applied should not be possible.

EXTERIOR LIGHTING VERIFICATION**Exterior Lighting Test Mode**

This useful function allows quick verification of the vehicle exterior lights.

- **Activating the test mode:**

When the vehicle is stationary (parking brake applied), press the left turn signal and right turn signal switches at the same time and then release to activate the test mode. This test can be done when the engine is not running providing that the battery charge is sufficient (above 24.0 volts).

- **Stopping the test mode:**

To stop the test mode, press the left turn signal and right turn signal switches at the same time again and then release or turn the ignition OFF or remove the parking brake.

IMPORTANT NOTE

The test mode is useful to check the functioning of the multiplex outputs and the exterior lights. It doesn't test the functionality of the commands related to the exterior lighting. For a complete testing, the directional signal commands, the headlights commands and the brake pedal have to be checked before. Once these commands tested, activate the test mode to check the exterior lighting.

- **Using the test mode:**

First, test the functionality of the commands related to the exterior lighting:

- Press the right turn signal switch and check that the corresponding telltale light illuminates.
- Press the left turn signal switch and check that the corresponding telltale light illuminates.
- Press on the brake pedal and check that the STOP telltale light illuminates.

Once these commands tested, activate the test mode to check the exterior lighting by pressing the left turn signal and right turn signal switches at the same time and then releasing.

- All marker lights, clearance lights and identification lights are illuminated.
- High and low beam headlights illuminate.

- All directional signal lights and center stop lights flash.
- Stop lights and center high-mounted stop light (CHSL) illuminate every 4 seconds.

IMPORTANT NOTE

To check the back-up lights and back-up alarm, you must flip the starter selector switch to REAR START position. (If the engine is running, do this quick enough so that the engine does not stop).

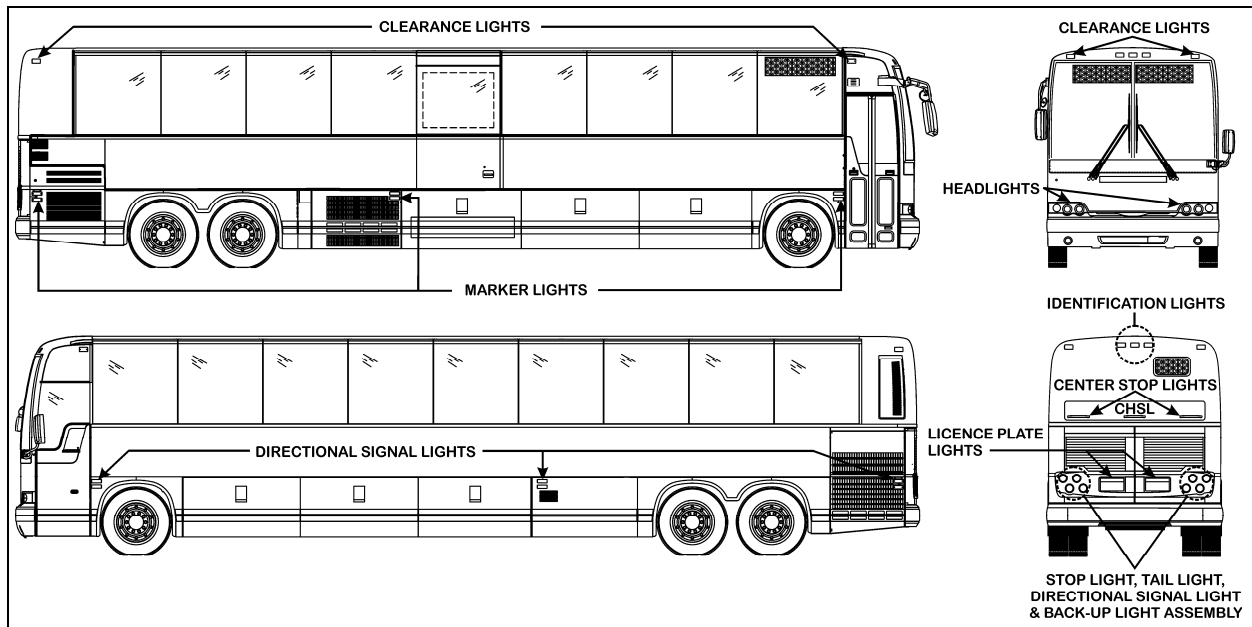

VARIOUS LIGHTS LOCATION

FIRST SERVICE ON NEW VEHICLE

NOTE

Refer to Maintenance Manual for precise service schedule.

NOTE

If soldering has been performed on cooling system, clean filter after 3,000 miles (5 000 km).

ENGINE OIL

Preliminary oil change is not required since the engine has been test-run at the factory. Change oil and filter as specified in Section 24 of the Maintenance Manual.

COOLANT SYSTEM FILTER

The coolant system filter is designed to recover the soldering residues trapped inside the coolant lines during their initial assembly. Replace filter every 50,000 miles (80 000 km). Refer to the Maintenance Manual under section 05: Cooling System.

GENERAL RECOMMENDATIONS

- Understand basic principles of vehicle operation;
- Always maintain the vehicle in good running condition;
- Do not drive with low fuel. If the fuel tank runs dry, the engine will not start until the air is bled from the fuel system. Refer to "Maintenance Manual" for more information;
- Allow engine to run for at least two minutes at normal idle before shutting OFF;
- Engine should be at idle when shifting from neutral (N) to forward (D) or from neutral (N) to reverse (R);

- The automatic transmission does not have a park (P) position. Place transmission in neutral (N) position and apply parking brake when the vehicle is stopped. A warning buzzer will sound if the engine is stopped and the parking brake has not been applied when foot pressure is removed from the brake pedal;
- Always follow the procedures described in this manual;
- Unless stated otherwise, shut *OFF* the engine before performing all servicing, lubrication and maintenance tasks;
- Do not attempt to push or pull-start the coach;

- The vehicle may be damaged if towed with the axle shafts or driveshaft connected;
- The chemical fire extinguisher is located behind the driver's seat. In case of fire, immediately evacuate all occupants. Occupant safety is the first priority. Do not attempt to extinguish the fire if there is immediate danger or risk for personal injury;
- When driving on ice and snow, accelerate and decelerate gradually;



WARNING

Report all problems affecting passenger or driver safety to a Prevost service center or an authorized service center. Have problems corrected immediately.

1	Accessories air tank drain cock	22	Secondary fuel filter
2	Accessories air filter	23	Power steering fluid tank
3	Steering drag link	24	Engine oil filter
4	Height control valve (front)	25	Cooling fan gearbox
5	Steering tie rod	26	Allison transmission oil dipstick
6	Accessories air tank	27	Engine coolant surge tank
7	Steering column U-joints	28	Coolant filter & conditioner
8	Steering knuckle pins	29	Engine air filter restriction indicator
9	Steering damper cylinder	30	Engine air filter
10	Secondary air tank	31	Engine oil dipstick and filler tube
11	Kneeling air tank	32	DEF tank
12	Air dryer	33	Diesel particulate filter
13	Height control valve (rear)	34	SCR catalytic converter
14	Wet air tank	35	Diesel fuel tank
15	Primary air tank	36	Power steering pump
16	Differential	37	Air compressor
17	Propeller shaft	38	Alternators
18	Tag axle lever pivot	39	Emergency / parking Brakes Overrule Control Valve
19	Transmission	40	Air dryer purge tank
20	Starter	41	Haldex Consep® Condenser / Separator
21	Primary fuel filter		

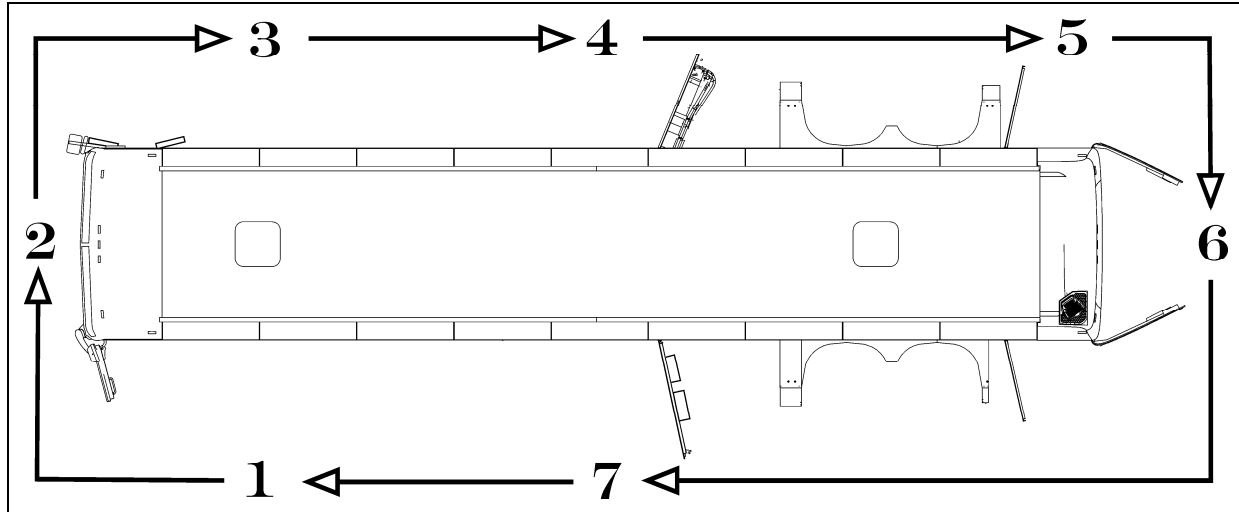

COMPONENTS IDENTIFICATION (COMPONENTS REPRESENTATION MAY DIFFER SLIGHTLY FROM AN ACTUAL VEHICLE)

WALK-AROUND INSPECTION (BEFORE EVERY TRIP)**NOTE**

Inspect the coach in a circular manner as shown in the illustration.

Approaching the Coach

- Check under the coach for oil, fuel, coolant leaks or other signs of damage.
- Check exterior body surfaces for signs of breaks or damage.

Preparation

- Drain accumulated water from accessory and wet air tanks.
- Close air tank drain valves.
- Start the engine and let the air pressure build up to normal. Stop engine.
- Switch on hazard warning flashers.
- Make sure parking brakes are applied.

Step 1: Front Left Side of the Coach

- Check condition of wheel rim. Especially look for cracks, missing nuts, bent or broken studs.
- Check condition of tire: properly inflated, no serious cuts, bulges, tread wear or any signs of misalignment; valve stem not touching wheel or rim; valve cap in place.
- Check windshield washer reservoir fluid level and add if necessary.

Step 2: Front of the Coach

- Check for damage and clean if dirty.
- Check windshield wiper arms for proper spring tension.
- Check wiper blades for any damage, “dead” rubber and attachment to arm.
- Check clearance and identification lights, they should be clean, operating and of the proper color. Refer to “Exterior Lighting Verification” in Care and Maintenance chapter.
- Turn on headlights. High and low beams should be operating and lenses clean. Refer to “Exterior Lighting Verification” in Care and Maintenance chapter.
- Left and right front turn signal lights clean, operating and proper color. Refer to “Exterior Lighting Verification” in Care and Maintenance chapter.

Step 3: Front Right Side of the Coach

- Check condition of wheel rim. Especially look for cracks, missing nuts, bent or broken studs.
- Check condition of tire: properly inflated, no serious cuts, bulges, tread wear or any signs of misalignment; valve stem not touching wheel or rim; valve cap in place.

Step 4: Rear Right Side of the Coach

- Check condition of wheels and rims. Especially look for cracks, missing nuts, bent or broken studs.
- Check that baggage and service compartment doors are properly closed.
- Check condition of tires: properly inflated, no serious cuts, bulges, tread wear or any signs of misalignment; valve stems not touching wheels or rims; valve caps in place and no objects stuck between the wheels.

Step 5: Engine Compartment Right Side Area

- Check engine and surrounding areas for coolant, oil and fuel leaks.
- Check fuel/filter water separator and drain if necessary. Check for leaks.
- Check wiring harness for signs of damage.

Step 6: Engine Compartment

- Check engine and surrounding areas for coolant, oil and fuel leaks.
- Check wiring harness for signs of damage.
- Check condition of drive belts.
- Check engine crankcase oil level, add if necessary.
- Check Allison transmission fluid level (can also be checked from push-button shift selector), add if necessary.
- Check power steering reservoir fluid level, add if necessary.
- Check coolant surge tank fluid level, add if necessary.
- Check air cleaner restriction indicator, replace air cleaner when red signal locks in full view.
- Check that exhaust aftertreatment system access door is properly closed.
- Check stop light, tail light, directional signal light and back-up light assembly; operating, clean and proper color. Refer to "Exterior Lighting Verification" in Care and Maintenance chapter.

Step 7: Rear Left Side of the Coach

- Check condition of wheels and rims. Especially look for cracks, missing nuts, bent or broken studs.
- Check that baggage and service compartment doors are properly closed.
- Check that catalytic converter access door is properly closed.
- Check condition of tires: properly inflated, no serious cuts, bulges, tread wear or any signs of misalignment; valve stems not touching wheels or rims; valve caps in place and no objects stuck between the wheels.

Inside the Coach

- Check for proper operation of the entrance door.
- Check steps; clean them if there is any substance that makes them slippery, which makes coach entry/exit hazardous.
- Check that emergency exit windows and roof escape hatches can be opened then close all windows and hatches securely.
- Verify proper operation of windshield wiper/ washer.
- Adjust and clean mirrors for adequate rear view vision.
- Start engine and check for proper operation of all gauges and indicator lights.
- Check for proper operation of electric horns and back-up alarm.

Perform a brake test. Check both primary and secondary pressure gauges.

DIMENSIONS AND WEIGHTS	116
CAPACITIES	116
FUEL TYPE	116
BIODIESEL FUELS	116
WHEELS AND TIRES	117
RECOMMENDED TIRE INFLATION PRESSURE AT MAXIMUM COLD LOAD	117
BELTS	117
VOLVO D13 ENGINE	117
ALLISON TRANSMISSION	117
PROPELLER SHAFT	117
BRAKES	117
BRAKE CHAMBER EFFECTIVE AREA	117
AIR SYSTEM	117
ANTILOCK BRAKING SYSTEM (ABS)	118
TROUBLESHOOTING AND TESTING	118
STEERING	118
ELECTRICAL SYSTEM	118
SUSPENSION	118
I-BEAM AXLE FRONT SUSPENSION	118
DRIVE AXLE	118
TAG AXLE	118
ALIGNMENT SPECIFICATIONS	118
COOLING SYSTEM	119
FUEL SYSTEM	119
EXHAUST SYSTEM	119
HEATING AND AIR CONDITIONING	119
OIL SPECIFICATIONS	120
ENGINE.....	120
ALLISON TRANSMISSION	120
DIFFERENTIAL	120
FAN RIGHT ANGLE GEARBOX	120
POWER STEERING RESERVOIR.....	120
PLATES AND CERTIFICATION	120
SAFETY CERTIFICATION	121
DOT CERTIFICATION PLATE	121
VEHICLE IDENTIFICATION NUMBER (VIN)	121
COACH FINAL RECORD	121

DIMENSIONS AND WEIGHTS	X3-45
Overall length (including bumpers)	45' (13,7 m)
Overall width	102" (2,59 m)
Overall height	134 3/8" (3,413 m)
Wheelbase (center of front axle to center of drive axle)	340" (8,64 m)
Floor height from ground	48 1/2" (1,23 m)
Ground clearance	11" (280 mm)
Step height from ground	15" (380 mm)
Step height (other steps)	7" (178 mm)
Headroom	80" (2,03 m)
Entrance door opening width	30" (762 mm)
Front overhang	70 3/4" (1,80 m)
Rear overhang	107 1/2" (2,73 m)
Front track	85.9" (2,18 m)
Drive track	76.7" (1,95 m)
Rear track (Tag axle)	83.6" (2,12 m)
Turning circle radius (I-Beam Axle)	47'-3" (14.4 m)
Curb weight	36,000 lb (16 327 kg)
Gross Vehicle Weight Rating (G.V.W.R.)	49,600 lb (22 498 kg)
Front axle Gross Axle Weight Rating (G.A.W.R.)	16,500 lb (7 500 kg)
Drive axle (G.A.W.R.)	20,500 lb (9 299 kg)
Tag axle (G.A.W.R.)	12,600 lb (5 727 kg)

The Gross Vehicle Weight Rating (G.V.W.R.) and the Gross Axle Weight Rating (G.A.W.R.) for front, drive and tag axles are listed on a certification plate located on the L.H. control panel in driver's section.

CAPACITIES	X3-45
Volvo D13 Engine oil (Total with filters)	41 U.S. qrts (39 l)
Fuel tank (legal capacity equal to 95% of volume)	208 U.S. gal. (787 l)
Cooling system	18.7 U.S. gal. (71 l)

CAPACITIES	X3-45
Allison Automatic Transmission (does not include external circuit)	6 U.S. gallons (23 l) 6.9 U.S. gallons (26 l) with retarder
Differential oil	20 U.S. qts (18,7 l)
Power steering reservoir	4.0 U.S. qts (3,8 l)
A/C compressor oil	4.5 U.S. qts (4,3 l)
Windshield washer reservoir	5.3 U.S. gal. (20 l)
Refrigerant	24.1 lb (11 kg)

FUEL TYPE

Diesel engines for 2007 and later model year vehicles are designed to operate only with **Ultra Low Sulfur Diesel** (ULSD) fuel, which can contain no more than 15 ppm sulfur.

	CAUTION
<p>ULSD fuel is necessary to avoid fouling the engine's Exhaust Aftertreatment System. Use of fuel other than ULSD will reduce the efficiency and durability of the engine.</p>	

BIODIESEL FUELS

ULSD-B5 biodiesel may be used. B5 tells you the percentage of biodiesel mixed in with ULSD. B5 is 5% biodiesel and 95% ULSD.

Fuel used must meet engine manufacturer's specification for biodiesel fuel. Concerning the use of biodiesel with Volvo D13 engines, refer to Volvo's specifications.

Biodiesel fuels are alkyl esters of long chain fatty acids derived from renewable resources. Biodiesel fuels made from soybean or rapeseed oil through the proper transesterification reaction process are recommended. Other feedstock source of biodiesel fuels such as animal fat and used cooking oils are not recommended. Biodiesel fuels meeting ASTM D6751 specification and from BQ-9000 accredited producer, prior to blending can be mixed up to 5% maximum by volume in petroleum diesel fuel. The resulting mixture must meet the fuel properties of ASTM D975 specification. Failures attributed to the use of biodiesel fuel will not be covered by Volvo or Prevost product warranty. Also, any engine performance problem related to the use of biodiesel fuel would not be recognized nor considered as Volvo or Prevost's responsibility.

WHEELS AND TIRES

Accuride steel wheels9" X 22½"
 Except inner drive axle (steel).....8¼" X 22½"
 Tires 315/80 R22.5 load range "L"

RECOMMENDED TIRE INFLATION PRESSURE AT MAXIMUM COLD LOAD

The recommended tire inflation pressures are given in the applicable documents supplied with the vehicle. In addition, minimum cold tire inflation pressures are listed on the Department of Transport (DOT) certification plate, affixed on the left wall near the driver's seat.

	CAUTION
<p>These tire pressures are established in accordance with the maximum allowable load on each axle. A lower pressure is recommended if the axle load is less than the above specifications. Weigh vehicle fully loaded and pressurize according to tire manufacturer's recommendations. For non standard tire and wheel specifications, see Prevost tire pressure tabulation in "Coach Final Record".</p>	

	WARNING
<p>Special tire selection may lower maximum allowable speed limit, even below posted speed limit. For maximum safety, check with tire manufacturer.</p>	

BELTS

Use	Model	Qty
Cooling fan drive belt	Multi V-14 Rib 14PK2526	1
A/C system 05G compressor	V Belt BX-100 9212-0404	2
Alternator (twin Bosch)	Multi-V-8 Rib 8PK1935	1
Alternator (emergency)	Multi-V-8 Rib 8PK1865	1

NOTE
<i>Belts specifications may vary. For proper belt selection, always consult your vehicle Coach Final Record.</i>

VOLVO D13 ENGINE

Volvo D13 engine displacing 12.8 liters. The engine is an inline six cylinder, four stroke cycle, turbocharged, air to air charge cooled, diesel engine with SOHC with 4 valves per cylinder.

Power 435 HP
 Torque..... 1,700 lbf•ft (2304 Nm)
 Operating range 1400-1800rpm
 Full dress, dry weight..... 2519 lb

ALLISON TRANSMISSION

Allison B500 (B500R with the optional output retarder) electronically controlled six speed automatic transmission.

Gear Ratios

1st 3.510
 2nd 1.906
 3rd 1.429
 4th 1.000
 5th 0.737
 6th 0.639
 Reverse..... 4.801
 Converter 1.9
 Differential ratio..... 3.91

PROPELLER SHAFT

Hayes-Dana SPL250 type tubular shafts. It is provided with heavy-duty universal joints.

BRAKES

The features of the braking system include a dual system where the front and rear circuits are completely independent from each other. The brakes are air operated disc type brakes with automatic slack adjusters on front, drive and tag axles. The emergency/parking brakes are located on the drive and tag axles only.

BRAKE CHAMBER EFFECTIVE AREA

Front axle 24 in²
 Drive axle 24/24 in² (service / emergency)
 Tag axle 14/16 in² (service / emergency)

AIR SYSTEM

Compressed air is provided by a twin cylinder, 31.8 cfm Wabco, gear-driven, water-cooled and engine oil lubricated air compressor.

ANTILOCK BRAKING SYSTEM (ABS)

The antilock braking system has one Electronic Control Unit (ECU) controlling a four channel system. A wheel slip sensor is mounted at each front axle and drive axle wheel. The Tag axle wheels are slave to the drive axle wheels.

The Electronic Control Unit (ECU) is maintenance free. Its operating voltage is 24 ± 6 volts DC. The thermal operating range for the ECU is from -40 to 167°F (-40 to 75°C).

The solenoid control valves are maintenance free. Their operating voltage is 24 (+4.8, -2.4) volts DC. The rated current draw is 1.65 amps. The thermal operating range of the solenoid control valves is from -40 to 176°F (-40 to 80°C).

TROUBLESHOOTING AND TESTING

For troubleshooting and testing of the vehicle's anti-lock braking system, refer to Meritor WABCO Maintenance Manual: "Anti-Lock Brake Systems For Trucks, Tractors and Buses" or use dashboard Driver Information Display (DID).

STEERING

- ZF 8098 integral hydraulic assisted steering gear;
- Volvo hydraulic pump gear driven from engine drive.
- Hydraulic reservoir and dipstick accessible from engine compartment.
- System pressure: 2175 psi (150 bars).
- Steering wheel diameter 20". Tilt steering wheel and telescopic steering column; pneumatically locked with foot operated switch for adjustment.
- Number of turns: 5¾.
- Outside turning radius: See Dimensions and Weight.

ELECTRICAL SYSTEM

- 24-volt, negative ground;
- 12-volt exterior lighting;
- Two 28 volts, 120 amp, self-regulated, belt-driven, air-cooled HD 10 Bosch alternators;
- Two 12 volt, 8D format maintenance-free batteries connected in series/parallel. Cold cranking capacity is 1400 amps @ 0°F (-18°C) with a reserve capacity of 430 minutes;

- 100 amp battery equalizer.

SUSPENSION

Goodyear rolling lobe type air springs (bellows) are used throughout.

I-BEAM AXLE FRONT SUSPENSION

- 2 Bellows (12"); for a G.A.W.R. of 16,500 lb;
- 2 Shock absorbers;
- 4 Radius rods;
- 1 Transverse radius rod;
- 1 Height control valve.
- 1 sway bar (1¾" diameter).

DRIVE AXLE

- 4 Bellows (11");
- 4 Shock absorbers;
- 3 Radius rods;
- 1 Panhard rod;
- 2 Height control valves.

TAG AXLE

- 2 Bellows (11");
- 2 Shock absorbers;
- 3 Radius rods;
- 1 Panhard rod.

ALIGNMENT SPECIFICATIONS

Use wheel alignment systems which work with angle measurements only, such as Josam or Hunter systems. Alignment specifications are listed in the following tables:

I-BEAM AXLE FRONT SUSPENSION			
	Minimum value	Nominal value	Maximum value
Right camber (degrees)	-0.250	0.125	0.375
Left camber (degrees)	-0.250	0.125	0.375
Right caster (degrees)	2.0	2.75	3.5
Left caster (degrees)	2.0	2.75	3.5
Total toe-in (degrees)	0.04	0.06	0.08

DRIVE AXLE			
	Minimum value	Nominal value	Maximum value
Thrust angle (degrees)	-0.04	0	0.04

TAG AXLE			
	Minimum value	Nominal value	Maximum value
Parallelism (degrees)	-0.02	0	0.02
(*) Use the drive axle as reference			

COOLING SYSTEM

- Extra capacity, copper fin radiator and aluminum charge air cooler arranged one behind the other.
- 3 speed fan clutch engine ECM controlled.
- Rubber insulated from the body.
- Expansion tank above radiator and remote mounted.
- System pressure 14 psi.
- 185° F thermostat.
- System capacity 24 us gal.
- Coolant filter.
- Radiator fan: 38 inches fan belt and drive shaft driven.

FUEL SYSTEM

Polyethylene 208 US gallons/787 liters fuel tank centrally located.

Equipped with:

- Emco Wheaton fuel filling system.
- Provided with filling access on the right side of the coach with safety filler cap.
- Pressure relief valve.
- Electric fuel gauge.
- Low level signal at 26 US gallons/98.4 liters.
- Primary filter 25 microns (standard).
- Primary fuel filter with electrical water indicator (Volvo D13).
- Secondary filter 3 to 5 microns.
- Shut-off valve on fuel supply line.

EXHAUST SYSTEM

One all stainless steel exhaust aftertreatment system including:

- Catalytic converter to reduce NOx.
- FleetGuard assembly made of a DOC (Diesel Oxidation Catalyst and a DPF (Diesel Particulate Filter). Noise, vibration and heat insulated. This assembly is mounted to the bus structure and is accessible through an exterior access door.
- Tail pipe diffuser and rain deviation device.
- Exhaust pipe with Insulation and a flexible section.
- Exhaust to rear left hand top of rear cap.
- Diesel exhaust fluid (DEF) tank (60 liters) and injection system.

HEATING AND AIR CONDITIONING

The large capacity A/C provides adequate capacity of conditioned and filtered air for all climatic conditions. Fresh air is drawn into the system from the left (driver's) side of the vehicle. Return air is taken from the middle of the vehicle. The driver's heater and defogger are controlled separately from the central unit. An air mixture selector enables air to be drawn into the system from outside the vehicle or recirculated.

CENTRAL A/C	
Air conditioning capacity	9 tons
Refrigerant type	134A
Heating capacity	152 000 Btu/h
Air flow	2 600 cfm (73,6 m ³ /min)

COMPRESSOR (for central A/C)	
Number of cylinders	6
Operating speed	400 to 2 200 rpm (2,600 rpm, intermittent)
Minimum speed for lubrication	400 rpm
Oil capacity	6.3 U.S. pints (3,0 l)
Approved oil	Castrol SW-68 (POE)

NOTE

The above oils are suitable for use with reciprocating compressors using refrigerant R-134a and with evaporator temperatures above -40°F (-40°C).

OIL SPECIFICATIONS

ENGINE

Use Total Rubia TIR 10W-30 FE for best fuel economy. SAE 5W-30 & 15W-40 oils, meeting VDS-4 and CJ4, are also approved. CJ-4 is required in 2010 and later diesel engines.

The Volvo D13 engine oil specification is designated EO-O Premium Plus (or VDS-4). EO-O Premium Plus oils exceed the new API service category CJ-4.

ALLISON TRANSMISSION

Allison Transmission recommends the following fluids:

- Castrol TranSynd™ or TES-295 specification equivalent fluid;
- Dexron-III®, Dexron VI automatic transmission fluid or TES-389 specification equivalent fluid.

DIFFERENTIAL

Multigrade gear oil meeting MIL-PRF-2105E: 85W140 is recommended for use in drive axle. This lubricant performs well over a broad temperature range, providing good gear and bearing protection in a variety of climates. If temperature drops below 10°F (-12°C), 80W90 should be used, and below -15°F (-26°C), 75W90 should be used. In extreme conditions or for better performance, full synthetic gear oil should be used.

FAN RIGHT ANGLE GEARBOX

Use Shell synthetic transmission oil MA 75W90 or equivalent.

POWER STEERING RESERVOIR

Use Automatic Transmission Fluid (ATF) Dexron-III or Dexron-VI for this system.

PLATES AND CERTIFICATION

The main components of the vehicle such as engine, transmission, axles and chassis are identified by different serial numbers. It may be necessary to locate these numbers for warranty purposes.

The engine data plate is located on the rocker cover. The engine serial and model number and a list of the optional engine equipment are written on this plate. Refer to this information when ordering replacement parts. Also the engine data plate certifies that the engine conforms to federal and any state exhaust emissions regulations.

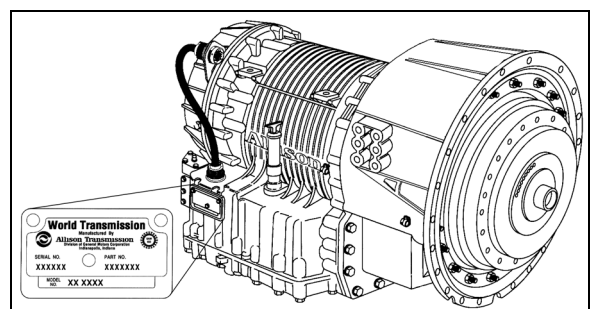

ALLISON TRANSMISSION 07076

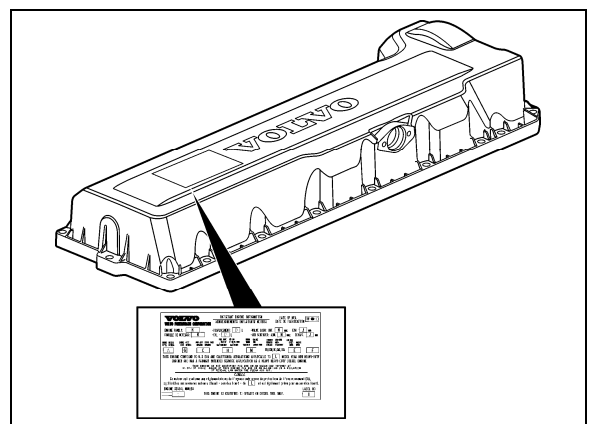

VOLVO D13 ENGINE DATA PLATE 00052

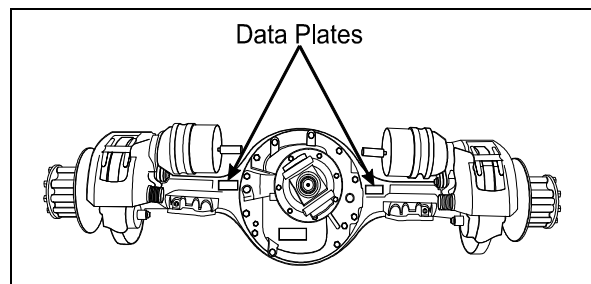

DRIVE AXLE 00007

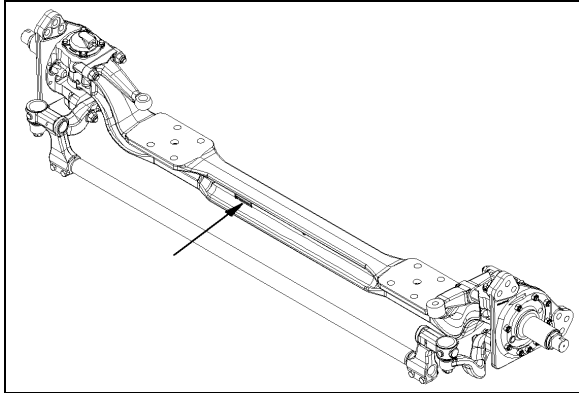

I-BEAM FRONT AXLE

00008

SAFETY CERTIFICATION

- Vehicle components meet specifications and standards as follows:
- Material and parts conform to ASTM and/or SAE standards in effect at the time of manufacture.
- All factory-installed interior materials meet FMVSS 302 for fire resistance.
- Certified according to Provincial, State and Federal Safety standards (Canadian and US) BMCSS, FMVSS and CMVSS.
- Other applicable certification labels are affixed to the component.

DOT CERTIFICATION PLATE

This certifies that vehicles manufactured by Prevost Car Inc. comply with all Federal Motor Vehicle Safety Standards at the time of manufacture. Information such as date of manufacture, model year, gross vehicle weight rating, tire types and inflation pressure is also etched on this plate. The DOT Certification plate is affixed to L.H. control panel.

		PREVOST			
MANUFACTURED BY : PREVOST FAÏRIQUE PAR : STE-CLAIRE, Q.U.E.		DATE OF MFG. : <input type="text"/> DATE DE FAB. : <input type="text"/>			
G.V.W.R. : 24040 KG. (53000 LBS). P.N.B.V. :					
AXLES/ ESSELUX	G.A.V.R./ P.N.B.E.	TIRES/ PNEUS	RIMS/ JANTES	COLD INFLATION PRESS./ PRESS. A FROID	SINGLE OR DUAL SIMPLE OU DOUBLE
KG (LBS)	KG (LBS)	KPA (PSI)			
FRONT: AVANT :	7484 (16500)	315/80R22.5 (J)	22.5X9	827 (120)	S
INT. DIFF. :	10206 (22500)	315/80R22.5 (J)	22.5X9	621 (90)	D
REAR: TANDEM:	6350 (14000)	315/80R22.5 (J)	22.5X9	689 (100)	S
THIS VEHICLE CONFORMS TO ALL APPLICABLE U.S. FEDERAL MOTOR VEHICLE SAFETY STANDARDS IN EFFECT ON THE DATE OF MANUFACTURE SHOWN ABOVE.					
VEHICLE IDENTIFICATION NO. <input type="text"/> NO. IDENTIFICATION VEHICULE <input type="text"/>					
TYPE: BUS B/A			#405405		

DOT CERTIFICATION PLATE

00016

VEHICLE IDENTIFICATION NUMBER (VIN)

The Vehicle Identification Number is stamped on a plate located on the windshield frame pillar (driver's side). The VIN is visible from the outside of the vehicle. Make sure the correct vehicle identification number is given when ordering replacement parts. Using the VIN when ordering parts will facilitate processing.

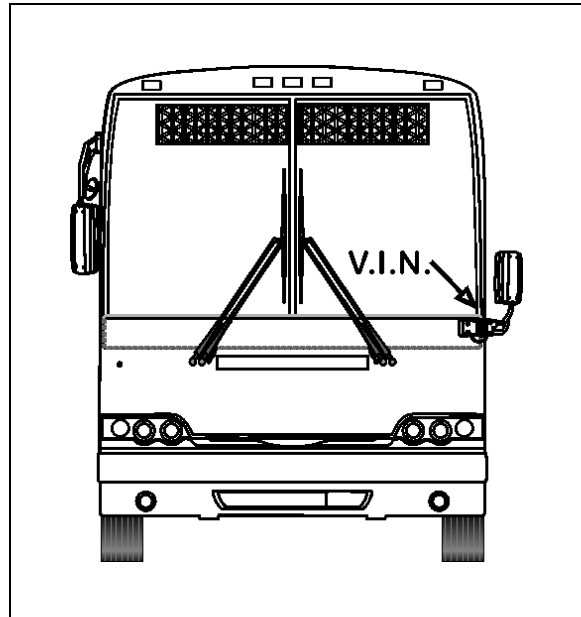

VEHICLE IDENTIFICATION NUMBER

00044

NOTE

Record the VIN in the vehicle documentation and keep with company records. The VIN will normally be used for vehicle registration, service reference needs and for obtaining vehicle insurance coverage.

COACH FINAL RECORD

The Coach Final Record is a record of all data pertaining to the assembly of the vehicle. This record is shipped to the new customer via a courier company. Retain this record in the company records office for reference and safe-keeping.

ABBREVIATION	DESCRIPTION
--------------	-------------

ABS	Antilock Brake System
A/C	Air Conditioning
AFSS	Automatic Fire Suppression System
DDR	Diagnostic Data Reader
DEF	Diesel Exhaust Fluid
DID	Driver Information Display
D-MIC	Driver Microphone
DPF	Diesel Particulate Filter
DTC	Diagnostic Troubleshooting Code
ECM	Engine Control Module
ECU	Electronic Control Unit
EECU	Engine Electronic Control Unit
EGR	Exhaust Gas Recirculation
ESC	Escape
E+	Eco-Roll
GECU	Gear selector Electronic Control Unit
HVAC	Heating, Ventilation and Air Conditioning
LED	Light Emitting Diode
MCM	Master Chassis Module
MPH	Miles Per Hour
PPT	Premium Tech Tool
PTO	Power Take Off
SCR	Selective Catalytic Reduction
TCM	Transmission Control Module
TCS	Traction Control System
TECU	Transmission Electronic Control Unit
TWS	Threshold Warning System
ULSD	Ultra Low Sulfur Diesel
VCADS	Diagnostic Tool
VEB	Volvo Engine Brake
VECF	Vehicle Electrical Center Front
VECR	Vehicle Electrical Center Rear
VECU	Vehicle Electronic Control Unit
WCL	Wheelchair Lift

Appendix A – Service Literature 125

SERVICE LITERATURE	126
NOTICE	127
DECLARATION OF THE MANUFACTURING DEFECTS TO THE GOVERNMENT OF THE UNITED STATES	127
DECLARATION OF THE MANUFACTURING DEFECTS TO THE CANADIAN GOVERNMENT	127
DECLARATION OF THE MANUFACTURING DEFECTS TO PREVOST	127

SERVICE LITERATURE

Visit our web sit at www.prevostcar.com for on-line product information and technical publications!

Additional copies of the following service literature are available on request and at low cost. These can be helpful to mechanics and drivers alike.

- * **Maintenance Manual**
- * **Operator's Manual**
- * **Parts Manual**
- * **Service Center Directory**

To order, call Prevost Parts toll free 1-800-463-8876 or write to:

PREVOST PARTS INC.

2955-A Watt Street
Sainte-Foy, (Quebec)
Canada G1X 3W1

Specify the complete vehicle serial number. Allow 30 days for delivery

NOTICE

DECLARATION OF THE MANUFACTURING DEFECTS TO THE GOVERNMENT OF THE UNITED STATES

If you believe that your vehicle has defect which could cause a crash or could cause injury or death, you should immediately inform the National Highway Traffic Safety Administration (NHTSA) in addition to notifying Prevest.

If NHTSA receives similar complaints, it may open an investigation, and if it finds that a safety defect exists in a group of vehicles, it may order a recall and remedy campaign.

However, NHTSA cannot become involved in individual problems between you, your dealer, or Prevest Car Inc.

To contact NHTSA you may either call the Auto Safety Hotline toll-free at **1-800-424-9393** (or **366-0123** in Washington, D.C. area) or write to:

**NHTSA
U.S. Department of transportation
Washington, D.C. 20590.**

You can also obtain other information about motor vehicle safety from the Hotline.

DECLARATION OF THE MANUFACTURING DEFECTS TO THE CANADIAN GOVERNMENT

If you live in Canada, and if you believe that your vehicle has a safety defect, you should immediately inform Transport Canada and Prevest. You may write to:

**Transport Canada
Box 8880
Ottawa, Ontario, K1G 3J2**

DECLARATION OF THE MANUFACTURING DEFECTS TO PREVOST.

In addition to notify the NHTSA (or Transport Canada), please contact Prevest at **1-418-831-2046**. Or you may write to:

**Prevest
After-sales service department
850 Olivier Road,
Saint-Nicolas (Quebec)
Canada, G7A 2N1**

Troubleshooting

Problem/Symptom	Probable Causes	Actions
Vehicle does not Start	<p>Rear Start selector switch is not in the NORMAL position</p> <p>Battery master switch on the rear electrical panel is in the OFF position</p>	<ol style="list-style-type: none"> 1. Check that the rear start selector switch is flipped up to NORMAL start position and battery master switch is turned to ON and retry cranking 2. Flip the rear start selector switch to “Rear Start” and start the vehicle from the rear
	<p>CAN network problem (Multiplex)</p> <p>Module A53 not powered or is defective</p> <p>Engine ECM does not receive the ignition signal</p> <p>Engine ECM is not powered</p>	<p>If the vehicle does not start from the rear:</p> <ol style="list-style-type: none"> 1. Verify that module A53 is powered: <ol style="list-style-type: none"> a) Check the Diagnostics menu of the Driver Information Display (DID). Select Fault Diagnostics and Electrical System. The message “No Response ModA53, Active”, indicates a power problem on the module or a CAN network problem. b) Check / reset circuit breaker CB5 c) Check / replace fuse F65 d) Probe gray connector on module to see if it is powered. 2. Verify that the engine ECM is powered and get the ignition signal <ol style="list-style-type: none"> a) Check / reset circuit breaker CB8 Check / replace fuse F74 b) Check / reset circuit breaker CB2 Check / replace fuse F78
<p>None of the Multiplexed functions are operating, including the basic limp-home functions (door opening, flashers, wipers in speed 1)</p> <p><i>Note: The sunshades are still functioning since these are not multiplexed</i></p>	<p>The program version in the MCM is different than the program in the I/O modules and the MCM is forcing all I/O modules to stay inactive</p>	<ol style="list-style-type: none"> 1. Engage the auto-programming of the I/O modules: Turn the ignition switch to the OFF position, turn the battery master switch on the rear electrical panel to OFF and ON and then turn the ignition switch back ON. The letters CAN will appear in the telltale LCD panel for about 3 minutes Everything shall get back to normal once the letters CAN are replaced with outside temperature display 2. Try disconnecting the green connector on the MCM and reconnect 3. Try disconnecting the MCM completely, leave it disconnected and see if the limp-home functions (start of the vehicle from the engine compartment, wipers speed 1, flashers, etc) are functioning

130 Appendix B – Troubleshooting Guide for Multiplex Vehicles

Problem/Symptom	Probable Causes	Actions
<p>Many secondary functions (not essential for driving) not functioning (interior lighting, driver's area lighting, wiper speed 2 and intermittent).</p> <p>Marker lights and clearance lights are turned ON when setting ignition to the ON position.</p>	<p>The MCM module does not receive 24 V power.</p> <p>The CAN network is not working. It could be caused by a short on the network, an open circuit, a problem with the MCM or the MCM being disconnected from the network.</p>	<ol style="list-style-type: none"> 1. Check / reset circuit breaker CB6 (3rd from the left on the junction panel) Check / replace fuse F1 2. Operate in limp-home mode by starting the vehicle from the engine compartment (REAR START). All functions essential to drive are available <p>To close and lock the door, pull the door manually up to its closed position and it will lock by itself. The door opening button is still functioning</p>
<p>Entrance door does not open nor close using the control buttons</p> <p>Defroster fan not functioning</p> <p>Windshield wipers not functioning in speed 1 or intermittent</p>	<p>Module A47 is not powered or is faulty</p>	<ol style="list-style-type: none"> 1. Check the Diagnostics menu of the Driver Information Display (DID). Select Fault Diagnostics and Electrical System. The message "No Response ModA47, Active" indicates a power problem on the module. (A CAN network problem would show the same message but doesn't produce these symptoms). 2. Check / reset circuit breaker CB6 3. Check / replace fuse F5 4. Check / replace relay R18 5. Probe gray connector on module to see if it is powered. 6. Use the air release valves on the dashboard and in the front service compartment to lock / unlock the door
<p>Windshield wipers not functioning in speed 1 or intermittent</p>	<p>No power on R23</p>	<p>Check / replace fuse F82</p>
<p>HVAC condenser fans not functioning in speed 1</p>	<p>Circuit breaker CB7 was manually tripped and not reset</p>	<p>Check / reset circuit breaker CB7</p>
<p>HVAC condenser fans not functioning in speed 2</p>	<p>Circuit breaker CB7 was manually tripped and not reset</p>	<p>Check / reset circuit breaker CB7</p>
<p>Windshield washer not functioning</p> <p>Windshield upper section de-icing system not functioning</p> <p>Defroster fan is functioning but no heat or cooling available in the driver area.</p>	<p>Module A46 is not powered or is faulty</p>	<ol style="list-style-type: none"> 1. Check the Diagnostics menu of Driver Information Display (DID). Select Fault Diagnostics and Electrical System. The message "No Response ModA46, Active" indicates a power problem on the module. (A CAN network problem would show the same message but doesn't produce these symptoms).

Problem/Symptom	Probable Causes	Actions
		<ol style="list-style-type: none"> 2. Check / reset circuit breaker CB1 3. Check / replace fuse F12 or F13 4. Probe gray connector on module to see if it is powered.
<p>Low beam headlights and front flasher on left side not functioning</p> <p>Electric horn not functioning</p>	<p>Module A45 is not powered or is faulty</p>	<ol style="list-style-type: none"> 1. Check the Diagnostics menu of Driver Information Display (DID). Select Fault Diagnostics and Electrical System. The message “No Response ModA45, Active” indicates a power problem on the module. (A CAN network problem would show the same message but doesn’t produce these symptoms). 2. Check / reset circuit breaker CB2 3. Check / replace fuse F33 and F34 4. Check / replace relay R19 5. Probe gray connector on module to see if it is powered.
<p>Low beam headlights and flasher on right side not functioning</p>	<p>Module A48 is not powered or is faulty</p>	<ol style="list-style-type: none"> 1. Check the Diagnostics menu of Driver Information Display (DID). Select Fault Diagnostics and Electrical System. The message “No Response ModA48, Active” indicates a power problem on the module. (A CAN network problem would show the same message but doesn’t produce these symptoms). 2. Check / reset circuit breaker CB2 3. Check / replace fuse F33 and F34 4. Check / replace relay R19 5. Probe gray connector on module to see if it is powered.
<p>Rear flashers not functioning</p> <p>Stoptlights and center stoptlights not functioning</p>	<p>Module A51 is not powered or is faulty</p>	<ol style="list-style-type: none"> 1. Check the Diagnostics menu of Driver Information Display (DID). Select Fault Diagnostics and Electrical System. The message “No Response ModA51, Active” indicates a power problem on the module. (A CAN network problem would show the same message but doesn’t produce this symptom). 2. Check / reset circuit breaker CB2 3. Check / replace fuse F80 4. Probe gray connector on module to see if it is powered.

132 Appendix B – Troubleshooting Guide for Multiplex Vehicles

Problem/Symptom	Probable Causes	Actions
<p>Engine is overheating and radiator fan clutch does not engage</p> <p>The A/C compressor clutch does not engage</p>	<p>Module A52 is not powered or is faulty</p>	<ol style="list-style-type: none"> 1. Check the Diagnostics menu of Driver Information Display (DID). Select Fault Diagnostics and Electrical System. The message “No Response ModA52, Active” indicates a power problem on the module. (A CAN network problem would show the same message but doesn’t produce this symptom). 2. Check / reset circuit breaker CB5 3. Check / replace fuse F65 4. Probe gray connector on module to see if it is powered.
<p>Evaporator fan not functioning</p>	<p>Circuit breaker CB3 tripped</p> <p>Module A54 is not powered or is faulty</p>	<ol style="list-style-type: none"> 1. Check / reset circuit breaker CB3 2. Check the Diagnostics menu of Driver Information Display (DID). Select Fault Diagnostics and Electrical System. The message “No Response ModA54, Active” indicates a power problem on the module. (A CAN network problem would show the same message but doesn’t produce this symptom). 3. Check / reset circuit breaker CB5 4. Check / replace fuse F67 , F68 5. Probe gray connector on module to see if it is powered.
<p>HVAC condenser fans not functioning in speed 1</p>	<p>Module A54 is not powered or is faulty</p>	<ol style="list-style-type: none"> 1. Check the Diagnostics menu of Driver Information Display (DID). Select Fault Diagnostics and Electrical System. The message “No Response ModA54, Active” indicates a power problem on the module. (A CAN network problem would show the same message but doesn’t produce this symptom). 2. Check / reset circuit breaker CB5 3. Check / replace fuse F67 , F68 4. Probe gray connector on module to see if it is powered.
<p>Fire alarm telltale light and audible alarm always ON and there is no fire or high temperature in the engine compartment</p>	<p>Short-circuited fire sensor or defective sensor</p>	<p>Prior to start the vehicle, cycle the ignition switch to the ON position, OFF position and then ON position again and then start the vehicle. This will deactivate the fire alarm function. This has to be repeated each time the vehicle is re-started</p>

Problem/Symptom	Probable Causes	Actions
The vehicle is parked and the electrical horn is activated to indicate a fire in the engine compartment but there is no fire	Short-circuited fire sensor or defective sensor	Cycle the ignition switch between the ON and OFF position twice within 3 seconds. This will deactivate the fire alarm function. This has to be repeated each time the vehicle is parked
A single light, a group of LED lights or another function of the vehicle is not functioning	The multiplex outputs are protected in current by an internal "soft-fuse". When an output is shorted, it turns OFF and stays OFF until the "soft-fuse" is reset	Turn the ignition switch to the OFF position and turn to the ON position again. This resets all "soft -fuses"
No backlighting in the instrument cluster	Circuit breaker CB10 is tripped or fuse F20 blown	Check / reset circuit breaker CB10 Check / replace fuse F20
The radiator fan clutch does not function and the engine is overheating		<ol style="list-style-type: none"> 1. Set the ignition switch to the ON position. 2. Activate the dashboard Telltale Light Test switch 3 times within 4 seconds. 3. In the engine compartment, flip the starter selector switch to REAR START and then start the engine from the rear. <p>While in this mode, the rear start push-button can be used to manually engage the fan clutch. The Multiplex system knows when the engine is already running, and it will not activate the starter.</p> <ol style="list-style-type: none"> 4. Press the push-button one time to engage the clutch in 1st speed, press a second time to engage in 2nd speed, press a third time to stop the fan, press once again to return to 1st speed. <p>If the fan clutch does not engage using this procedure then the clutch is faulty or the wiring between the multiplex module and the clutch is faulty. Mechanically lock the fan clutch as described in section 05: COOLING SYSTEM of the maintenance manual.</p>

Appendix C – Allison Diagnostic Troubleshooting Codes 135

DIAGNOSTIC TROUBLESHOOTING CODES (DTC) - ALLISON 4TH GENERATION CONTROLS	136
DIAGNOSTIC TROUBLESHOOTING CODES (DTC) OVERVIEW	136
DIAGNOSTIC CODES – ALLISON 4 TH GENERATION CONTROLS.....	136
DIAGNOSTIC CODE DISPLAY AND CLEARING PROCEDURE - ALLISON 4 TH GENERATION CONTROLS ..	137
DIAGNOSTIC CODE RESPONSE	138
ALLISON TRANSMISSION DIAGNOSTIC TROUBLESHOOTING CODES (DTC) AND DESCRIPTIONS	139
ALLISON TRANSMISSION OIL LEVEL CHECK USING THE PUSH-BUTTON SHIFT SELECTOR	143
EXITING THE FLUID LEVEL DISPLAY MODE.....	143
CONTROL SYSTEM PROGNOSTICS.....	144
OIL LIFE MONITOR.....	144
FILTER LIFE MONITOR.....	144
TRANSMISSION HEALTH MONITOR	145

DIAGNOSTIC TROUBLESHOOTING CODES (DTC) — ALLISON 4TH GENERATION CONTROLS

DIAGNOSTIC TROUBLESHOOTING CODES (DTC) OVERVIEW

Diagnostic codes (DTC) are numerical indications relating to a malfunction in transmission operation. These codes are logged in a list in the TCM memory with the most severe or most recent code listed first. A maximum of five codes (numbered d1 to d5) may be listed in memory at one time. As codes are added, the oldest inactive code is dropped from the list. If all codes are active, the code with the lowest priority that is not included on the severity list is dropped from the list.

Diagnostic codes (DTC) and code information may be accessed through the pushbutton shift selector or using an Allison DOC™ diagnostic tool.

The TCM separately stores the active and inactive codes. An active code is any code that is current in the TCM decision-making process. Inactive codes are codes that are retained in the TCM memory and will not necessary affect the TCM decision-making process. Inactive codes are useful in determining if a problem is:

- Isolated ;
- Intermittent ;
- Result from a previous malfunction.

The TCM may automatically delete a code from memory if it has not recurred. If the condition which generated the code is active, the LED indicator on the selector will be illuminated simultaneously with the display of the code. If the condition which generated the code no longer exists, the LED is not illuminated and the code is maintained only as a historical record of the prior condition. An illuminated MODE INDICATOR (LED) during normal operation signifies secondary shift mode operation.



DIAGNOSTIC CODES – ALLISON 4TH GENERATION CONTROLS

When the diagnostic mode is entered, the first code (position d1) is displayed as follows:

Exemple: Code P0722

Displayed as: **d1...P...07...22**

The code list position is the first item displayed, followed by the DTC. Each item is displayed for about one second. The display cycles continuously until the next code list position is accessed by pressing the **MODE** button. The following example shows how DTC P0722 is displayed on the pushbutton shift selector.

SELECT	d	1	MONITOR
		P	
	0	7	
	2	2	

- d1 (code list position) – The position which a code occupies in the list. Positions are displayed as « d1 » through « d5 » (code list position 1 through code list position 5).
- P0722 (DTC) – The diagnostic troubleshooting code number referring to the general condition or area of fault detected by the TCM.

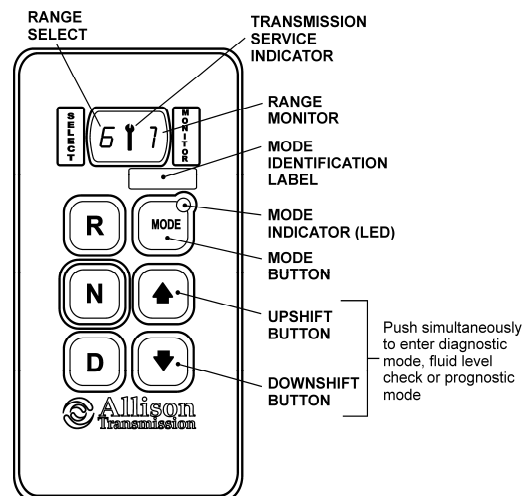

Push simultaneously to enter diagnostic mode, fluid level check or prognostic mode

DIAGNOSTIC CODE DISPLAY AND CLEARING PROCEDURE – ALLISON 4TH GENERATION CONTROLS

Diagnostic codes can be read and cleared by two methods:

- Using an Allison DOC™ diagnostic tool. For specific instructions on how to use an Allison DOC™ diagnostic tool, refer to the User Guide.
- Using the pushbutton shift selector.

To begin the diagnostic process:

1. Bring the vehicle to a stop at a safe location.
2. Apply the parking brake.

To display stored codes:

1. Simultaneously press the ▲ (Up) and ▼ (Down) arrow buttons five times to access the Diagnostic Display Mode.

NOTE

To access the Oil Level Display Mode, simultaneously press the ▲ (Up) and ▼ (Down) arrow buttons once. Consult paragraph: « ALLISON TRANSMISSION OIL LEVEL CHECK USING THE PUSHBUTTON SHIFT SELECTOR » at the end of this section.

2. Observe the digital display for code (d1).
3. Press the MODE button to see the next code (d2) – repeat for subsequent codes (d3, d4 & d5).

NOTE

Be sure to record all codes displayed before they are cleared. This is essential for troubleshooting.

NOTE

The Diagnostic Display Mode can be entered for viewing codes at any speed. Codes can only be cleared when the output speed = 0 and no output speed sensor failure is active

Active indicators (MODE INDICATOR LED) and inactive codes can be cleared manually, while in the diagnostic display mode, after the condition causing the code is identified.

To clear active indicators and inactive codes:

1. While in Diagnostic Display Mode, press and hold the MODE button for 10 seconds to clear both active indicators and inactive codes.
2. Begin operating as normal. Have the transmission checked at the earliest opportunity by an Allison Transmission distributor or dealer.

NOTE

All active indicators are cleared at TCM power down.

Some codes will clear their active indicator when the condition causing the code is no longer detected by the TCM.

138 Appendix C – Allison Diagnostic Troubleshooting Codes

The Diagnostic Display Mode can be exited by any of the following methods:

- Press simultaneously the ▲ (Up) and ▼ (Down) arrow buttons at the same time on the pushbutton shift selector.
- Press any range button «D», «N» or «R» on the pushbutton shift selector (the shift will be commanded if it is not inhibited by an active code).
- Wait until the calibrated time (approximately 10 minutes) has passed. The system will automatically return to the normal operating mode.
- Turn off power to the TCM (shut off the engine using the ignition key).

<i>NOTE</i>

<i>If clearing a code while locked in a «D» (Drive) or «R» (Reverse) position (fail-to-range), the transmission will still be in «D» (Drive) or «R» (Reverse) when the clearing procedure is completed. «N» (Neutral) must be manually selected.</i>

DIAGNOSTIC CODE RESPONSE

The following responses are used in the "Diagnostic Troubleshooting Code List and Inhibited Operation Description" table to command safe operation when diagnostic codes are sent.

DNS - Do Not Shift Response

Release lock up clutch and inhibit lock up operation.

Inhibit all shifts.

Turn *ON* the CHECK TRANS light.

Display the range attained.

Ignore any range selection inputs from the shift selector.

DNA - Do Not Adapt Response

The TCM stops adaptive shift control while the code is active.

SOL OFF - SOLenoid OFF Response

All solenoids are commanded *OFF* (turning solenoids "A" and "B" off electrically cause them to be on hydraulically).

RPR - Return to Previous Range Response

When the speed sensor ratio or C3 pressure switch test associated with a shift not successful, the TCM commands the same range as commanded before the shift.

NNC - Neutral No Clutches Response

When certain speed sensor ratio or C3 pressure switch tests are not successful, the TCM commands a neutral condition with no clutches applied.

ALLISON TRANSMISSION DIAGNOSTIC TROUBLESHOOTING CODES (DTC) AND DESCRIPTIONS

DTC	Description	CHECK TRANS Light	Inhibited Operation Description
C1312	Retarder Request Sensor Failed Low	No	May inhibit retarder operation if not using J1939 datalink
C1313	Retarder Request Sensor Failed High	No	May inhibit retarder operation if not using J1939 datalink
P0122	Pedal Position Sensor Low Voltage	No	Use default throttle values. Freezes shift adapts.
P0123	Pedal Position Sensor High Voltage	No	Use default throttle values. Freezes shift adapts.
P0218	Transmission Fluid Over Temperature	No	Use hot mode shift schedule. Holds fourth range. TCC is inhibited. Freezes shift adapts.
P0561	System Voltage Performance		
P0562	System Voltage Low		
P0563	System Voltage High		
P0602	TCM Not Programmed	Yes	Lock in Neutral
P0610	TCM Vehicle Options (Trans ID) Error	Yes	Use TID A calibration
P0613	TCM Processor	No	All solenoids off
P0614	Torque Control Data Mismatch - ECM/TCM	Yes	Allows operation only in reverse and second range.
P0634	TCM Internal Temperature Too High	Yes	SOL OFF (hydraulic default)
P063E	Auto Configuration Throttle Input Not Present	Yes	Use default throttle values
P063F	Auto Configuration Engine Coolant Temp Input Not Present	No	None
P0658	Actuator Supply Voltage 1 (HSD1) Low	Yes	DNS, SOL OFF (hydraulic default)
P0659	Actuator Supply Voltage 1 (HSD1) High	Yes	DNS, SOL OFF (hydraulic default)
P0667	TCM Internal Temperature Sensor Circuit Range / Perform		
P0668	TCM Internal Temperature Sensor Circuit Low		
P0669	TCM Internal Temperature Sensor Circuit High		
P0701	Transmission Control System Performance		
P0702	Transmission Control System Electrical (TransID)	Yes	Use TID A calibration
P0703	Brake Switch Circuit Malfunction	No	No Neutral to Drive shifts for refuse packer. TCM inhibits retarder operation if a TPS code is also active.
P0708	Transmission Range Sensor Circuit High Input	Yes	Ignore defective strip selector inputs
P070C	Transmission Fluid Level Sensor Circuit – Low Input	No	None
P070D	Transmission Fluid Level Sensor Circuit – High Input	No	None
P0711	Transmission Fluid Temperature Sensor Circuit Performance	Yes	Use default sump temp
P0712	Transmission Fluid Temperature Sensor Circuit Low Input	Yes	Use default sump temp
P0713	Transmission Fluid Temperature Sensor Circuit High Input	Yes	Use default sump temp
P0716	Turbine Speed Sensor Circuit Performance	Yes	DNS, Lock in current range
P0717	Turbine Speed Sensor Circuit No Signal	Yes	DNS, Lock in current range
P071A	RELS Input Failed On	Yes	Inhibit RELS operation
P071D	General Purpose Input Fault	Yes	None

140 Appendix C – Allison Diagnostic Troubleshooting Codes

DTC	Description	CHECK TRANS Light	Inhibited Operation Description
P0720	Output Speed Sensor Circuit		
P0721	Output Speed Sensor Circuit Performance	Yes	DNS, Lock in current range
P0722	Output Speed Sensor Circuit No Signal	Yes	DNS, Lock in current range
P0726	Engine Speed Sensor Circuit Performance	No	Default to turbine speed
P0727	Engine Speed Sensor Circuit No Signal	No	Default to turbine speed
P0729	Incorrect 6 th Gear Ratio	Yes	DNS, Attempt 5 th , then 3 rd
P0730	Incorrect Neutral Gear ratio		
P0731	Incorrect 1 st Gear ratio	Yes	DNS, Attempt 2 nd , then 5 th
P0732	Incorrect 2 nd Gear ratio	Yes	DNS, Attempt 3 rd , then 5 th
P0733	Incorrect 3 rd Gear ratio	Yes	DNS, Attempt 4 th , then 6 th
P0734	Incorrect 4 th Gear ratio	Yes	DNS, Attempt 5 th , then 3 rd
P0735	Incorrect 5 th Gear ratio	Yes	DNS, Attempt 6 th , then 3 rd , then 2 nd
P0736	Incorrect Reverse Gear ratio	Yes	DNS, Lock in Neutral
P0741	Torque Converter Clutch System Stuck Off	Yes	None
P0776	Pressure Control Solenoid 2 Stuck Off	Yes	DNS, RPR
P0777	Pressure Control Solenoid 2 Stuck On	Yes	DNS, RPR
P0796	Pressure Control Solenoid 3 Stuck Off	Yes	DNS, RPR
P0797	Pressure Control Solenoid 3 Stuck On	Yes	DNS, RPR
P0842	Transmission Pressure Switch 1 Circuit Low	Yes	DNS, Lock in current range
P0843	Transmission Pressure Switch 1 Circuit High	Yes	DNS, Lock in current range
P0847	Transmission Pressure Switch 2 Circuit Low		
P0848	Transmission Pressure Switch 2 Circuit High		
P088A	Transmission Fluid Filter Deteriorated		
P088B	Transmission Fluid Filter Very Deteriorated		
P0880	TCM Power Input Signal	No	None
P0881	TCM Power Input Signal Performance	No	None
P0882	TCM Power Input Signal Low	Yes	DNS, SOL OFF (hydraulic default)
P0883	TCM Power Input Signal High	No	None
P0894	Transmission Component Slipping	Yes	DNS, Lock in first
P0960	Pressure Control Solenoid Main Mod Control Circuit Open	Yes	None
P0961	Pressure Control Solenoid (PCS) MM System Performance		
P0962	Pressure Control Solenoid Main Mod Control Circuit Low	Yes	DNS, SOL OFF (hydraulic default)
P0963	Pressure Control Solenoid Main Mod Control Circuit High	Yes	None
P0964	Pressure Control Solenoid 2 (PCS2) Control Circuit Open	Yes	DNS, SOL OFF (hydraulic default)
P0965	Pressure Control Solenoid (PCS) 2 System Performance		
P0966	Pressure Control Solenoid 2 (PCS2) Control Circuit Low	Yes	DNS, SOL OFF (hydraulic default)
P0967	Pressure Control Solenoid 2 (PCS2) Control Circuit High	Yes	DNS, SOL OFF (hydraulic default)
P0968	Pressure Control Solenoid 3 (PCS3) Control Circuit Open	Yes	DNS, SOL OFF (hydraulic default)
P0969	Pressure Control Solenoid (PCS) 3 System Performance		
P0970	Pressure Control Solenoid 3 (PCS3) Control Circuit Low	Yes	DNS, SOL OFF (hydraulic default)
P0971	Pressure Control Solenoid 3 (PCS3) Control Circuit High	Yes	DNS, SOL OFF (hydraulic default)
P0973	Shift Solenoid 1 (SS1) Control Circuit Low	Yes	DNS, SOL OFF (hydraulic default)
P0974	Shift Solenoid 1 (SS1) Control Circuit High	Yes	DNS, SOL OFF (hydraulic default)

DTC	Description	CHECK TRANS Light	Inhibited Operation Description
P0975	Shift Solenoid 2 (SS2) Control Circuit Open	Yes	7-speed: Allow 2 through 6, N, R
P0976	Shift Solenoid 2 (SS2) Control Circuit Low	Yes	7-speed: Allow 2 through 6, N, R Inhibit TCC operation
P0977	Shift Solenoid 2 (SS2) Control Circuit High	Yes	7-speed: Allow 2 through 6, N, R
P0989	Retarder Pressure Sensor Failed Low	No	None
P0990	Retarder Pressure Sensor Failed High	No	None
P1739	Incorrect Low Gear Ratio	Yes	Command 2 nd and allow shifts 2 through 6, N, R
P1891	Throttle Position Sensor PWM Signal Low Input	No	Use default throttle values
P1892	Throttle Position Sensor PWM Signal High Input	No	Use default throttle values
P2184	Engine Coolant Temperature Sensor Circuit Low Input	No	Use default engine coolant values
P2185	Engine Coolant Temperature Sensor Circuit High Input	No	Use default engine coolant values
P2637	Torque Management Feedback Signal (SEM)	Yes	Inhibit SEM
P2641	Torque Management Feedback Signal (LRTP)	Yes	Inhibit LRTP
P2670	Actuator Supply Voltage 2 (HSD2) Low	Yes	DNS, SOL OFF (hydraulic default)
P2671	Actuator Supply Voltage 2 (HSD2) High	Yes	DNS, SOL OFF (hydraulic default)
P2685	Actuator Supply Voltage 3 (HSD3) Low	Yes	DNS, SOL OFF (hydraulic default)
P2686	Actuator Supply Voltage 3 (HSD3) High	Yes	DNS, SOL OFF (hydraulic default)
P2714	Pressure Control Solenoid 4 (PCS4) Stuck Off	Yes	DNS, RPR
P2715	Pressure Control Solenoid 4 (PCS4) Stuck On	Yes	DNS, SOL OFF (hydraulic default)
P2718	Pressure Control Solenoid 4 (PCS4) Control Circuit Open	Yes	DNS, SOL OFF (hydraulic default)
P2719	Pressure Control Solenoid (PCS) 4 System Performance		
P2720	Pressure Control Solenoid 4 (PCS4) Control Circuit Low	Yes	DNS, SOL OFF (hydraulic default)
P2721	Pressure Control Solenoid 4 (PCS4) Control Circuit High	Yes	DNS, SOL OFF (hydraulic default)
P2723	Pressure Control Solenoid 1 (PCS1) Stuck Off	Yes	DNS, RPR
P2724	Pressure Control Solenoid 1 (PCS1) Stuck On	Yes	DNS, RPR
P2727	Pressure Control Solenoid 1 (PCS1) Control Circuit Open	Yes	DNS, SOL OFF (hydraulic default)
P2728	Pressure Control Solenoid (PCS) 1 System Performance		
P2729	Pressure Control Solenoid 1 (PCS1) Control Circuit Low	Yes	DNS, SOL OFF (hydraulic default)
P2730	Pressure Control Solenoid 1 (PCS1) Control Circuit High	Yes	DNS, SOL OFF (hydraulic default)
P2736	Pressure Control Solenoid 5 (PCS5) Control Circuit Open	Yes	Inhibit retarder operation
P2737	Pressure Control Solenoid (PCS) 5 System Performance		
P2738	Pressure Control Solenoid 5 (PCS5) Control Circuit Low	Yes	Allow 2 through 6, N, R. Inhibit retarder and TCC operation
P2739	Pressure Control Solenoid 5 (PCS5) Control Circuit High	Yes	Inhibit retarder operation
P2740	Retarder Oil Temperature Hot	No	None
P2742	Retarder Oil Temperature Sensor Circuit – Low Input	No	Use default retarder temp values
P2743	Retarder Oil Temperature Sensor Circuit – High Input	No	Use default retarder temp values
P2761	TCC PCS Control Circuit Open	Yes	Inhibit TCC operation
P2762	TCC PCS Control Circuit Range / Performance		
P2763	TCC PCS Control Circuit High	Yes	Inhibit TCC operation
P2764	TCC PCS Control Circuit Low	Yes	7-speed: Allow 2 through 6, N, R. Inhibit TCC operation
P2772	Four Wheel Drive Low Switch Circuit Performance		
P278A	Kickdown Input Failed ON	No	Inhibit kickdown operation

142 Appendix C – Allison Diagnostic Troubleshooting Codes

DTC	Description	CHECK TRANS Light	Inhibited Operation Description
P2793	Gear Shift Direction Circuit	Yes	Ignores PWM input from shift selector
P2808	Pressure Control Solenoid 6 (PCS6) Stuck Off	Yes	DNS, RPR
P2809	Pressure Control Solenoid 6 (PCS6) Stuck On	Yes	DNS, RPR
P2812	Pressure Control Solenoid 6 (PCS6) Control Circuit Open	Yes	DNS, SOL OFF (hydraulic default)
P2813	Pressure Control Solenoid (PCS) 6 System Performance		
P2814	Pressure Control Solenoid 6 (PCS6) Control Circuit Low	Yes	DNS, SOL OFF (hydraulic default)
P2815	Pressure Control Solenoid 6 (PCS6) Control Circuit High	Yes	DNS, SOL OFF (hydraulic default)
U0001	Hi Speed CAN Bus Reset Counter Overrun (IESCAN)	No	Use default values, inhibit SEM
U0010	CAN BUS Reset Counter Overrun	No	Use default values, inhibit SEM
U0100	Lost Communications with ECM/PCM (J1587)	Yes	Use default values
U0103	Lost Communication with Gear Shift Module (Shift Selector) 1	Yes	Maintain range selected, observe gear shift direction circuit
U0115	Lost Communication with ECM	Yes	Use default values
U0291	Lost Communication with Gear Shift Module (Shift Selector) 2	Yes	Maintain range selected, observe gear shift direction circuit
U0304	Incompatible Gear Shift Module 1 (Shift Selector) ID	Yes	Ignore shift selector inputs
U0333	Incompatible Gear Shift Module 2 (Shift Selector) ID	Yes	Ignore shift selector inputs
U0404	Invalid Data Received From Gear Shift Module (Shift Selector) 1	Yes	Maintain range selected, observe gear shift direction circuit
U0592	Invalid Data Received From Gear Shift Module (Shift Selector) 2	Yes	Maintain range selected, observe gear shift direction circuit

ALLISON TRANSMISSION OIL LEVEL CHECK USING THE PUSHBUTTON SHIFT SELECTOR

Oil level codes are obtained as follows:

1. Park vehicle on a level surface, select «N» (neutral) on the pushbutton shift selector and apply parking brake.
2. Press simultaneously the ▲ (Up) and ▼ (Down) arrow buttons once.
3. Oil level codes are displayed in 2 minutes (e.g. display will flash and 8, 7, 6, 5, ...; countdown will occur during the 2 minutes) once the following parameters are met:
 - **Waiting time, vehicle must be stationary for at least 2 minutes to allow the oil to settle;**
 - **Engine at idle;**
 - **Oil at normal operating temperature, between 140°F (60°C) and 220°F (104°C);**
 - **Transmission in «N» (Neutral);**
 - **Transmission output shaft stopped;**
 - **Oil level sensor present and working.**

After 2 minutes, the display will flash one of the codes shown below:

CODE	CAUSE OF CODE
O L...O K	Oil level is correct
O L...L O... 1	Oil Level is LOw 1 quart
O L...L O... 2	Oil Level is LOw 2 quart
O L...L O... 3	Oil Level is LOw 3 quarts
O L...L O... 4	Oil Level is LOw 4 or more quarts
O L...H I... 1	Oil Level is Hlgh 1 quart
O L...H I... 2	Oil Level is Hlgh 2 quarts
O L...H I... 3	Oil Level is Hlgh 3 or more quarts
O L... – (fc)	Oil Level is invalid. Source of invalid reading is defined by a two-character fault code (fc)

NOTE

Note that the quantities LO 4 and HI 3 are the largest values displayed and that the actual variation in oil level may exceed these numbers.

NOTE

Failure to meet one of the above parameters will stop the two minute countdown. One of the codes shown hereafter will indicate the cause of the countdown interruption. Once all parameters are met, the countdown will continue from where it left off.

If the fluid level check cannot be completed, an Invalid for Display fault is reported. This condition is reflected by the display of "OL", followed by "–", followed by one or two additional characters. The displayed characters define the cause of the fault, which may be either a system malfunction or an improper condition for conducting the check.

CODE	CAUSE OF CODE
OL...-...0X	Waiting period is not complete
OL...-...EL	Engine speed (rpm) too low
OL...-...EH	Engine speed (rpm) too high
OL...-...SN	N (neutral) must be selected
OL...-...TL	Sump oil temperature too low
OL...-...TH	Sump oil temperature too high
OL...-...SH	Output shaft rotation
OL...-...FL	Sensor failure

EXITING THE FLUID LEVEL DISPLAY MODE

To exit the Oil Level Display Mode, press any range button: «R», «N» or «D» at any time.

CONTROL SYSTEM PROGNOSTICS

The transmission control system includes the provision for the user to monitor various transmission operating parameters. Transmission operating parameters monitored by the prognostics feature are:

- Oil Life Monitor
- Filter Life Monitor
- Transmission Health Monitor



NOTE

*The prognostics package requires the use of TranSynd™ or an Allison approved TES-295 licensed fluid in the transmission and Allison High Capacity filters. If any other fluids or filters are used, Prognostic mode **must be disabled**. Prognostic information will not be accurate with any other fluids or filters and could result in missed maintenance activities resulting in transmission damage.*

Refer to TES 295 Approved Fluids list, found under the Service/Fluids heading on the home page of the Allison Transmission web site.

www.allisontransmission.com

When a specified threshold is detected for any of the serviceable conditions, the TRANSMISSION SERVICE indicator  is illuminated to alert the operator. Failure to attend to the service condition and reset the TRANSMISSION SERVICE indicator within a defined operating period will result in illumination of the CHECK TRANS light on the dashboard telltale panel, indicating the increased probability that the service condition will develop into a more serious condition.

To access the Prognostic Mode functions, simultaneously press the  (Up) and  (Down) arrow buttons repeatedly. See the reference table at the end of this section.

OIL LIFE MONITOR

The display message denotes the calculated remaining life of the transmission fluid. This value is based on the established life for the required baseline fluid, and then is continuously adjusted for cumulative effects of such operating parameters as operating time, retarder operation, output shaft revolutions and shift frequency.

Display: The display is a two-digit number, denoting percentage of the fluid life which remains. New fluid is displayed as 99%.

The TRANSMISSION SERVICE indicator  will be illuminated, denoting a required change of transmission fluid, when the remaining fluid life reaches approximately 1–2 %. The indicator will be lit steadily upon each initialization of the TCM, and will remain on steady for approximately 1–2 minutes after the first selection of “D” (drive) range each time, until service is performed and the indicator is reset.

Failure to perform maintenance and reset the TRANSMISSION SERVICE indicator within a defined period will result in the illumination of the CHECK TRANS light on the dashboard telltale panel and diagnostic code P0897 Transmission Fluid at Limit will be set.

Reset: The TRANSMISSION SERVICE indicator can be reset by a message over the SAE J1939 communication interface, with the Allison DOC™ for PC diagnostic program, or by depressing and holding the MODE button for ten (10) seconds while the Oil Life Monitor function is displayed. It may also be reset by selecting N-D-N-D-N-R-N on the shift selector, pausing briefly (less than 3 seconds) between each selector movement, with the ignition on and the engine not running.



CAUTION

Required calendar-based oil & filter change intervals (based on month) still apply because Oil Life Monitor function cannot measure time while ignition power is OFF.

If the Oil Life Monitor function has not indicated the need for a fluid change before 60 month (five years) have passed, it will be necessary to change the fluid and filters per calendar requirements and reset the system.

FILTER LIFE MONITOR

The display message denotes operating status of the transmission main fluid filter, based on the measured pressure drop across the filter. The feature is not functional at transmission sump temperatures below 40 °C (105 °F). Both the main and lube filters **must be** changed when the TRANSMISSION SERVICE indicator  shows the main filter should be changed.

Display: An acceptable filter life status is displayed as "OK". An unacceptable filter life status is displayed as "LO".

Once the programmed threshold for maximum filter pressure drop has been observed and verified, the diagnostic code P088A Transmission Filter At/Over Limit will be recorded to indicate that the filter has reached the end of its designed life. At the next initialization of the TCM, the TRANSMISSION SERVICE indicator **⚡** will flash for approximately 1–2 minutes after the first selection of "D" (drive) range. Thereafter, the indicator will illuminate and flash upon each TCM initialization, continuing to flash for 1–2 minutes after the first selection of a drive range each time, until service is performed and the indicator is reset.

Failure to perform maintenance and reset the monitor after a calibration-defined number of warnings will result in the illumination of the CHECK TRANS light on the dashboard telltale panel and diagnostic code P088B will be recorded to indicate a highly deteriorated filter.

Reset: The feature will reset automatically when the main fluid filter has been changed and the pressure drop across the filter no longer exceeds the threshold value. A manual reset can be performed by depressing and holding the MODE button for ten (10) seconds while the Filter Life Monitor function is displayed. It may also be reset by selecting N-R-N-R-N-D-N on the shift selector, pausing briefly (less than 3 seconds) between each selector movement, with the ignition on and the engine not running.

TRANSMISSION HEALTH MONITOR

The display message denotes clutch life status, as determined by monitored changes and the calculated running clearance of the transmission clutches C1, C2, C3, C4 & C5.

Display: An acceptable clutch life status is displayed as "OK". An unacceptable clutch life status is displayed as "LO". The specific clutch(es) for which the function indicates "LO" cannot be identified with the shift selector. Allison DOC™ for PC-Service Tool displays clutch condition as OK or NOT OK for each clutch, C1 through C5.

The TRANSMISSION SERVICE indicator will be illuminated, indicating the need for clutch maintenance, when the remaining clutch life reaches approximately 10%, or if the running clearance exceeds a maximum value which may indicate a non-wear-related issue. Thereafter, the indicator will be lit upon each initialization of the TCM, and will remain on steady during all vehicle operation until service is performed and the indicator is reset.

Failure to perform maintenance and reset the monitor after a number of warnings will result in the illumination of the CHECK TRANS light on the dashboard telltale panel and diagnostic code P2789 Clutch Adaptive learning at Limit will be set.

Reset: The feature will reset automatically upon elimination of the clutch clearance condition which initiated it. The indicator can also be manually reset using the Allison DOC™ for PC diagnostics program if necessary.

146 Appendix C – Allison Diagnostic Troubleshooting Codes

▲ (up) & ▼ (down) arrow buttons pressed simultaneously	Description	SELECT	MONITOR
1 st press	Allison transmission oil level check Other codes will be displayed	" _ "	" _ "
2 nd press	Oil Life Monitor Oil life remaining will range from 99% down to 00%	" O " Some number from 9 to 0	" M " Some number from 9 to 0
3 rd press	Filter Life Monitor Present life of filter is OK Present life of filter is low	" F " " O " " L "	" M " " K " " O "
4 th press	Transmission Health Monitor Shows "OK" until remaining life of one or more of the clutch(es) wear enough so that the programming changes One or more of the clutches C1 through C5 have worn enough to change the program	" O " " O " " L "	" K " " K " " O "
5 th press	Display of diagnostic codes Other codes will be displayed	" d "	" 1 "

A

ABBREVIATIONS 123

ADJUSTABLE HVAC REGISTERS 18

AIR SYSTEM 117

AISLE MIRROR 18

ALIGNMENT SPECIFICATIONS 121

ALLISON AUTOMATIC TRANSMISSION 54, 117

DESCRIPTION OF AVAILABLE RANGES 55

MODE 55

OPERATION 54

PUSHBUTTON SHIFT SELECTOR 54

TRANSMISSION SERVICE INDICATOR 55

ALLISON TRANSMISSION WARM-UP 87

ANTILOCK BRAKING SYSTEM (ABS) .. 74, 118

TROUBLESHOOTING AND TESTING 118

APPENDIX A – SERVICE LITERATURE 125

NOTICE 127

SERVICE LITERATURE 126

APPENDIX B – TROUBLESHOOTING GUIDE FOR MULTIPLEX VEHICLES 129

APPENDIX C – ALLISON DIAGNOSTIC TROUBLESHOOTING CODES 135

CONTROL SYSTEM PROGNOSTICS 146

DIAGNOSTIC TROUBLESHOOTING CODES (DTC) - ALLISON 4TH GENERATION CONTROLS 136

AUTOMATIC FIRE DETECTION AND SUPPRESSION SYSTEM (AFSS) 30

B

BACK-UP ALARM 98

BAGGAGE COMPARTMENTS 12

BELTS 117

BI-FOLD ENTRANCE DOOR 14

DOOR OPERATION LOGIC 14

EMERGENCY ENTRANCE DOOR OPENING 15

BRAKES 117

BRAKE CHAMBER EFFECTIVE AREA 117

C

CAPACITIES 116

CARE AND MAINTENANCE 99

CATALYTIC CONVERTER ACCESS DOOR. 10

CLEANING 100

CARPET 101

EXTERIOR SURFACES 101

FLOOR CLEANING 101

FORMICA 101

PLASTIC AND VINYL 101

RUBBER COMPONENTS 101

SEAT UPHOLSTERY 100

STAINLESS STEEL 101

WINDOWS 101

WINDSHIELD 102

COACH EXTERIOR 5

COACH FINAL RECORD 121

COACH INTERIOR 17

COMPARTMENT LIGHTING 98

CONDENSER COMPARTMENT (A/C) 10

CONTROLS AND INSTRUMENTS ... 23

COOLANT HEATER COMPARTMENT 11

COOLING SYSTEM 119

D

DASHBOARD 31

AIR VENTS 37

CONTROL SWITCHES 32

ELECTRONIC DESTINATION SIGN 37

HVAC CONTROL UNIT 36

L.H. DASHBOARD PANEL 32

R.H. DASHBOARD PANEL 34

DAYTIME RUNNING LIGHTS 98

DEFENSIVE DRIVING PRACTICES 2

DIAGNOSTIC DATA READER (DDR) RECEPTACLE 30

DIAGNOSTIC TROUBLESHOOTING CODES (DTC) - ALLISON 4TH GENERATION CONTROLS 136

ALLISON TRANSMISSION DIAGNOSTIC TROUBLESHOOTING CODES (DTC) AND DESCRIPTIONS.....139

ALLISON TRANSMISSION OIL LEVEL CHECK USING THE PUSH-BUTTON SHIFT SELECTOR143

DIAGNOSTIC CODE DISPLAY AND CLEARING PROCEDURE - ALLISON 4TH GENERATION CONTROLS137

DIAGNOSTIC CODE RESPONSE138

DIAGNOSTIC CODES – ALLISON 4TH GENERATION CONTROLS136

DIAGNOSTIC TROUBLESHOOTING CODES (DTC) OVERVIEW136

EXITING FLUID LEVEL DISPLAY MODE.....143

DIMENSIONS AND WEIGHTS116

DRIVER'S SEAT – RECARO.....18

 ADJUSTMENT19

 SAFETY BELTS19

DRIVER INFORMATION DISPLAY (DID) MENUS65

DRIVING MODE MENU.....65

 FUEL DATA.....66

 GAUGES65

 RESET TRIP DATA.....68

 TIME/DISTANCE.....67

 VEHICLE MESSAGES68

E

ELECTRICAL SYSTEM118

ELECTRONIC DESTINATION SIGN.....18

EMERGENCY AIR-FILL VALVES97

EMERGENCY AND PARKING BRAKES97

EMERGENCY EQUIPMENT.....91

 FIRE EXTINGUISHERS92, 106

 FIRST AID KIT92

 JACK AND TOOLS.....93

 SUPPRESSION SYSTEM (AFSS)91

 WARNING REFLECTORS92

EMERGENCY EXITS.....90

 EMERGENCY ENTRANCE DOOR OPENING 91

 ROOF HATCH.....90

 SIDE WINDOWS.....90

EMERGENCY/PARKING BRAKES OVERRULE CONTROL VALVE.....30

ENGINE (VOLVO D13).....117

ENGINE COMPARTMENT COMPONENTS....7

ENGINE COMPARTMENT8

 ENGINE COMPARTMENT CURB-SIDE DOOR 8

 ENGINE COMPARTMENT REAR DOORS.....8

ENGINE RADIATOR DOOR.....9

ENGINE WARM-UP.....87

ESSENTIAL FUNCTIONS TO OPERATE THE VEHICLE (BASIC LIMP-HOME FUNCTIONS)98

 AVAILABLE FUNCTIONS98

EVAPORATOR COMPARTMENT.....11

EXHAUST AFTERTREATMENT SYSTEM58

 DEF QUALITY – DRIVER WARNING AND INDUCEMENT63

 DEF TANK LEVEL – DRIVER WARNING AND INDUCEMENT62

 FILTRATION AND REGENERATION UNIT58

 SCR SYSTEM TAMPERING – DRIVER WARNING AND INDUCEMENT.....64

 SELECTIVE CATALYTIC REDUCTION UNIT .60

EXHAUST AFTERTREATMENT SYSTEM ACCESS DOOR9

EXHAUST SYSTEM119

F

FIRST SERVICE ON NEW VEHICLE110

 COOLANT SYSTEM FILTER.....110

 ENGINE OIL.....110

FLUID LEVEL VERIFICATION102

 COOLANT FLUID LEVEL.....105

 COOLING FAN RIGHT ANGLE GEARBOX OIL LEVEL104

 DRIVE AXLE WHEEL BEARING OIL LEVEL..104

 ENGINE OIL LEVEL.....102

 FRONT AND TAG AXLE WHEEL HUBS105

 POWER STEERING FLUID LEVEL104

 TRANSMISSION OIL LEVEL103

 WINDSHIELD WASHER RESERVOIR105

FOOT-OPERATED CONTROLS.....53

 ACCELERATOR PEDAL.....54

<p> BRAKE PEDAL 54 ELECTRONIC HORN..... 53 HEADLIGHT BEAM TOGGLE SWITCH..... 53 LEFT TURN SIGNAL SWITCH..... 53 PANIC BUTTON SWITCH..... 53 RIGHT TURN SIGNAL SWITCH 53 FRONT ELECTRICAL AND SERVICE COMPARTMENT12 FUEL AND DIESEL EXHAUST FLUID (DEF) FILLER DOOR 13 FUEL SYSTEM 119 FUEL TYPE.....116 BIODIESEL FUELS116 G GENERAL RECOMMENDATIONS111 H HEATING AND AIR CONDITIONING 119 HORNS53 HUBODOMETER.....16 I IGNITION SWITCH25 IN-STATION LIGHTING75 INSTRUMENT CLUSTER.....38 ANALOG INDICATORS 39 DRIVER INFORMATION DISPLAY 45 TELLTALE LIGHTS 42 J JACKING POINTS93 HYDRAULIC JACK..... 94 K KEYS.....25 ENTRANCE DOOR AND EXTERIOR COMPARTMENT DOORS KEY 25 KNEELING SYSTEM74 L LATERAL CONTROL PANEL.....28 CONTROL SWITCHES 29 </p>	<p> EMERGENCY/PARKING BRAKES OVERRULE CONTROL VALVE (BRAKE RELEASE) 30 MIRROR CONTROLS 29 PARKING BRAKES CONTROL VALVE..... 29 SILENT ALARM SWITCH 30 TAG AXLE CONTROL VALVE 29 TRANSMISSION CONTROL PAD 29 UTILITY COMPARTMENT 30 M MUD FLAPS AND SPLASH GUARDS 98 N NON-DRIVING / STATIONARY MODE MENUS 68 AFTERTREATMENT 72 DATA LOG 71 DIAGNOSTICS..... 69 DISPLAY SETTINGS 68 PASSWORDS 73 PRE-TRIP ASSISTANT..... 70 O OIL SPECIFICATIONS 120 ALLISON TRANSMISSION120 DIFFERENTIAL.....120 ENGINE.....120 FAN RIGHT ANGLE GEARBOX120 POWER STEERING RESERVOIR.....120 OTHER FEATURES..... 57 OTHER PRECAUTIONS 3 OTHER VERIFICATIONS..... 105 A/C AND HEATING SYSTEM AIR FILTERS...107 A/C COMPRESSOR BELT TENSION ADJUSTMENT106 AIR FILTER RESTRICTION INDICATOR107 AIR TANK PURGE105 EXTERIOR LIGHTING VERIFICATION109 FAN AND ALTERNATOR DRIVE BELTS.....107 FIRE EXTINGUISHERS106 HOSE INSPECTION108 LUBRICATION109 </p>
---------------------------------------------------------------------------------------------------------------------------------------------------------------------------------------------------------------------------------------------------------------------------------------------------------------------------------------------------------------------------------------------------------------------------------------------------------------------------------------------------------------------------------------------------------------------------------------------------------------------------------------------------------------------------------------------------------------------------------------------------------------------------------------------------------------------------------------------------------------------------------------------------------------------------------------------------------------------------------------------------------------------------------------------------------------------------------------------------------------------------------------------------------------------------------------------------------------------------------------------------------------------------------------------------------------------------------------------------------------------------------------------------------------------------------------------------------------------------------------------------------------------------------------------------------------------------------------------------------------------------------------------------------------------------------------------------------------------------------------------------------------------------------------------	----------------------------------------------------------------------------------------------------------------------------------------------------------------------------------------------------------------------------------------------------------------------------------------------------------------------------------------------------------------------------------------------------------------------------------------------------------------------------------------------------------------------------------------------------------------------------------------------------------------------------------------------------------------------------------------------------------------------------------------------------------------------------------------------------------------------------------------------------------------------------------------------------------------------------------------------------------------------------------------------------------------------------------------------------------------------------------------------------------------------------------------------------------------------------------------------------------------------------------------------------------------------------------------------------------------------------------------------------------------------------------------------------------------------------------------------------------------------------------------------------------------------------------------------------------------------------------------------------------------------------------------------------------------------------------------------------------------------------------------------------------------------------------------------------------------------------------------------------------------------------------------------------------------------------------------------------------------------------------------------------------------------------------------------------------------------------------------------------------------------------------------

PARKING BRAKE TEST109
 PRIMARY FUEL FILTER.....106
 SERVICE BRAKE TEST109
 WHEELS AND TIRES109
 WHEEL BEARINGS109
 OVERHEAD COMPARTMENTS22
 OVERHEAD CONSOLE20
 ADJUSTABLE AIR REGISTERS..... 20
 READING LIGHTS 21
 SERVICE BELL..... 21

P

PASSENGER SEATS20
 PLATES AND CERTIFICATION120
 DOT CERTIFICATION PLATE121
 SAFETY CERTIFICATION121
 PROPELLER SHAFT117

R

REAR VIEW MIRRORS15
 RETRACTABLE TAG AXLE75

S

SAFE OPERATING PRACTICES2
 SAFETY FEATURES AND EQUIPMENT 89
 SAFETY PRECAUTIONS 1
 STARTING AND STOPPING PROCEDURES 83
 STARTING THE ENGINE84
 COLD WEATHER STARTING 85
 JUMP STARTING..... 85
 STARTING FROM THE DRIVER'S SEAT..... 84
 STARTING FROM THE ENGINE COMPARTMENT 85
 STEERING WHEEL ADJUSTMENT18
 STEERING118
 SUSPENSION.....118
 DRIVE AXLE118
 I-BEAM AXLE FRONT SUSPENSION118

TAG AXLE118

T

TECHNICAL INFORMATION..... 115
 TOWING 94
 TRANSMISSION RETARDER..... 53, 73

U

UNLOADING TAG AXLE 75

V

VEHICLE IDENTIFICATION NUMBER (VIN) 121
 VENTILATION HATCH22

W

WALK-AROUND INSPECTION (BEFORE EVERY TRIP) 113
 WHEELCHAIR LIFT ACCESS DOORS 15
 WHEELCHAIR LIFT SYSTEM..... 75
 EMERGENCY OPERATION 81
 INTERIOR APPOINTMENTS 78
 OPERATING THE WHEELCHAIR LIFT 76
 THRESHOLD WARNING SYSTEM (TWS) ADJUSTMENT 77
 WHEELCHAIR LIFT AND ACCESS DOORS... 75
 WHEELCHAIR LIFT INSTALLATION..... 82
 WHEELCHAIR LIFT REMOVAL FOR STORING OR MAINTENANCE PURPOSES 82
 WHEELS AND TIRES 117
 RECOMMENDED TIRE INFLATION PRESSURE AT MAXIMUM COLD LOAD117
 WINDOWS21
 DRIVER'S POWER WINDOW..... 21
 PANORAMIC WINDOWS 21
 WINDSHIELD 22