

# PREVOST

## Pneumatic diagram

### PNEUMATIC DIAGRAMS X3-45 COACHES WITH FRONT BEAM AXLE

NO:	<b>D140390P0</b>	REVISION :	<b>D</b>
-----	------------------	------------	----------

EFF. OC#	2008110	PRIOR TO OC#	2011095
EFF. VEH#	#C-5053	PRIOR TO VEH#	#C-5212

DR.	R. Bouillon	date	2012-02-06
CHK	Marc-Jose Handfield	appr	Marc-José Handfield

REV.	DATE	DESCRIPTION	PAGE	BY	CHK.	APPR.
A	2010-04-01	Coach X3-45 NYCTA with Front Beam Axle, Preliminary Vehicle: #C-5053	P.1	Rob.	M.J.H.	M.J.H.
	2010-04-27	90 Coach X3-45 NYCTA with Front Beam Axle, Preliminary Vehicles: #C-5125, #C-5131, #C-5134, #C-5137, #C-5140 Other Serial Numbers : #C-5144 @ #C-5169 #C-5172 @ #C-5187 #C-5191 @ #C-5232	P.1	Rob.	M.J.H.	M.J.H.
B	2010-04-27	Revision B : Manual Entrance Door Safety Valve , Update .	P.1	R.Lam.	R.Lam.	M.J.H.
C	2011-11-30	ADD 5 NEW PAGES : Main Air Supply Front Brake Secondary Rear Brake Primary Entrance Door Interlock Emergency and Parking Brake	P1.3.1 P1.3.2 P1.3.3 P1.3.4 P1.3.5	Rob.	Rob.	M.J.H.
D	2012-02-06	Remove DRV valve (Volvo engine) , Effective on vehicles #C-5212 @ #C-5232 Update #D140390 P1.3.4 Revision D	ALL PAGES P1.3.4	Rob. Rob.	M.Pelletier M.J.H.	M.Pelletier M.J.H.

## Pneumatic diagram

### *PNEUMATIC DIAGRAMS X3-45 COACHES WITH FRONT BEAM AXLE*

PRODUCTION NUMBER	REV	EFF. VEH.	ECN	S.A.V. NUMBER	REV	DESCRIPTION
D140390P1.0	C	#C-5212	2011095	D140390P1.1	D	FULL PNEUMATIC SYSTEM ABS 6
				D140390P1.2	D	ACCESSORIES
				D140390P1.3	D	COMPLETE AIR BRAKE SYSTEM
				D140390P1.3.1	D	MAIN AIR SUPPLY
				D140390P1.3.2	D	FRONT BRAKE SECONDARY
				D140390P1.3.3	D	REAR BRAKE PRIMARY
				D140390P1.3.4	D	ENTRANCE DOOR INTERLOCK
				D140390P1.3.5	D	EMERGENCY AND PARKING BRAKE
				D140390P1.4	D	SUSPENSION

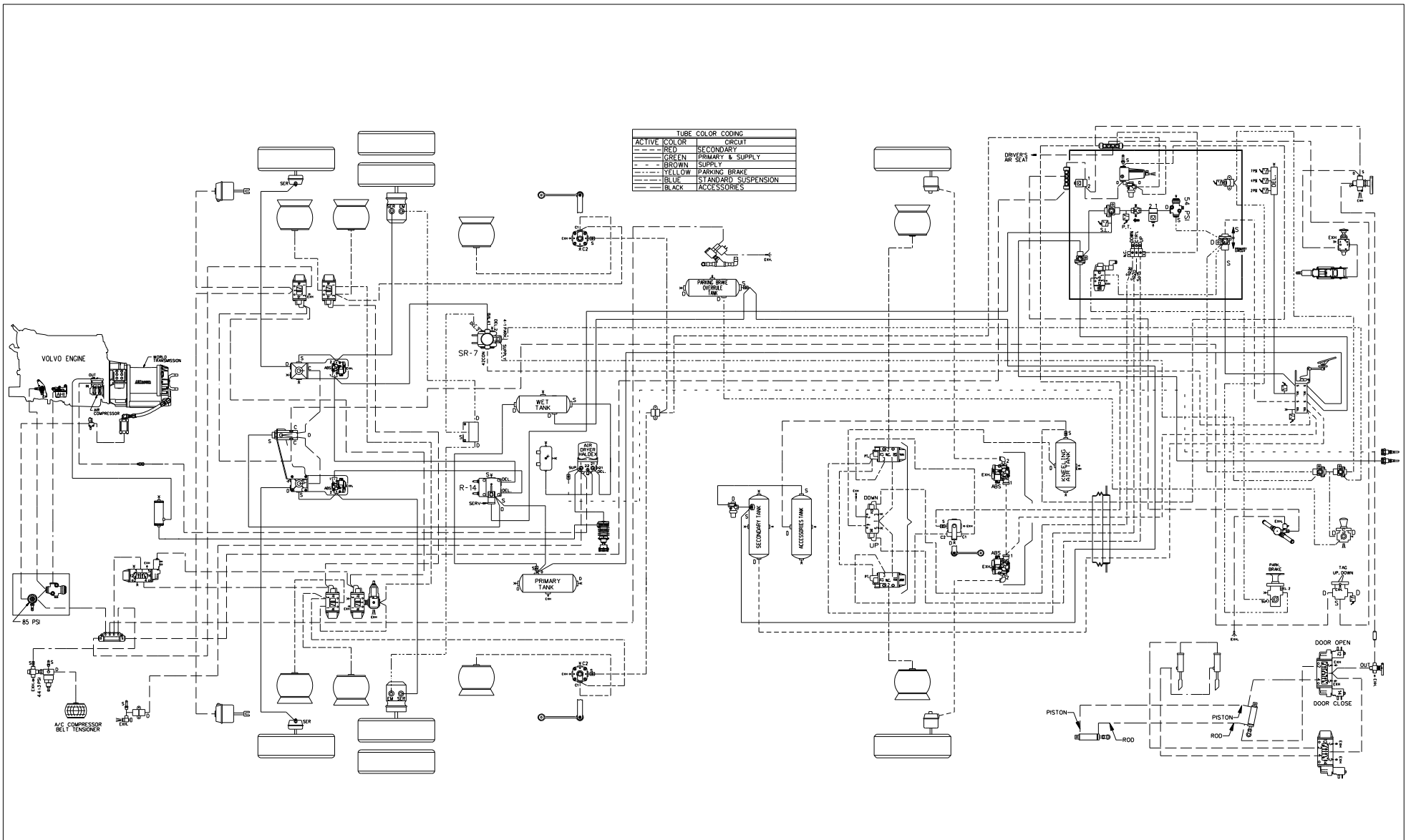

**PREVOST**

DESCRIPTION:

SCHEMATIC PNEU. COACH X3 NYCTA

REV.:

B

PAGE:

D140390 P1.1

DATE:

2011/04

TUBE COLOR CODING	
ACTIVE COLOR	CIRCUIT
RED	SECONDARY
GREEN	PRIMARY & SUPPLY
BROWN	SUPPLY
YELLOW	PARKING BRAKE
BLUE	STANDARD SUSPENSION
BLACK	ACCESSORIES

NOTE: ITEM #4 REMOVED FOR VEHICLES  
 \*C-5212 @ \*C-5232

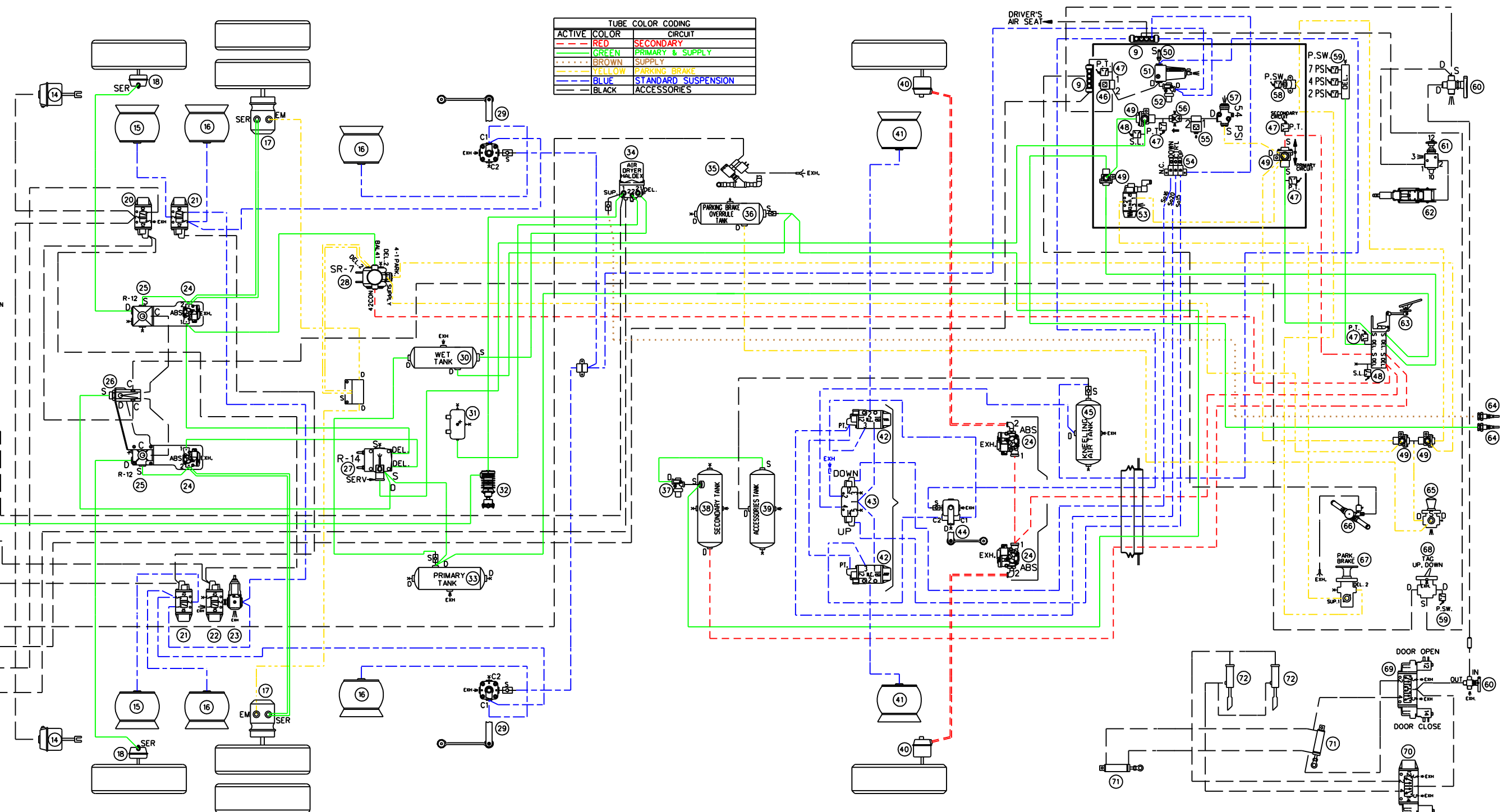
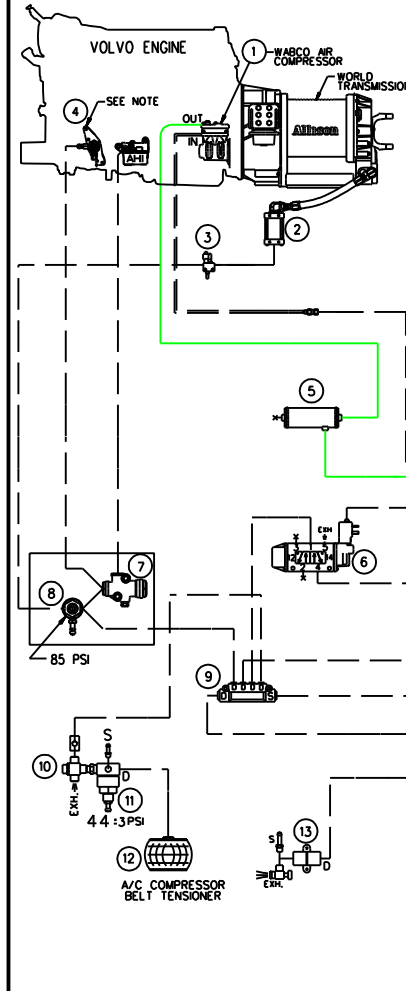

020 TAG UNLOAD VALVE NORRGREN, NUGGET 200	040 FRONT BRAKE CHAMBER, KNORR TYPE 24	060 ENTRANCE DOOR MANUAL VALVE, D-PRO V82	080
019 LIFT TAG AIR VALVE NORRGREN, NUGGET 200	039 ACCESSORIES AIR TANK, JOHNSON WELDING	059 PRESSURE SWITCH N.O. ALLISON	079
018 TAG AXLE BRAKE CHAMBER, KNORR, TYPE 14	038 SECONDARY AIR TANK, JOHNSON WELDING	058 PRESSURE SWITCH N.C. KLIXON	078
017 DRIVE AXLE BRAKE CHAMBER, KNORR TYPE 24/24	037 PROTECTION VALVE, BENDIX PR-4	057 PRESSURE REDUCING VALVE, BENDIX RV-3	077
016 DRIVE AXLE AIR SPRING GOODYEAR, TR11	036 PARKING BRAKE OVERRULE AIR TANK, JOHNSON WELDING	056 INLINE QUICK RELEASE VALVE, BENDIX, QR-L	076
015 TAG AXLE AIR SPRING GOODYEAR, TR12	035 WATER VALVE SOLENOID BURKERT, SYSTEM 2002	055 SOLENOID ENTRANCE DOOR INTERLOCK PARKER 7131	075
014 LIFT TAG AIR CYLINDER MGM, TYPE 36	034 AIR DRYER HALDEX	054 MANIFOLD VALVE NORRGREN D0043	074
013 REAR AIR FILL VALVE	033 PRIMARY AIR TANK, JOHNSON WELDING	053 PARKING BRAKE INTERLOCK, NORRGREN NUGGET 200	073
012 AIR BAG 4", GOODYEAR 154	032 OIL SEPARATOR, HALDEX CONSEP	052 PROTECTION VALVE, BENDIX PR-4	072
011 BELT TENSIONER PRESSURE REGULATOR NORRGREN R06	031 PURGE TANK, JOHNSON WELDING	051 AIR FILTER NORRGREN F74G	071
010 BELT TENSIONER MANUAL VALVE	030 WET TANK, JOHNSON WELDING	050 FRONT FILL VALVE, SCHRAEDER 645	070
009 AIR MANIFOLD BLOC, PARKER 24M	029 REAR HEIGHT CONTROL VALVE, BARKSDALE 52321	049 DOUBLE CHECK VALVE, BENDIX DC-4	069
008 REGULATOR OUTPUT RETARDER, NORRGREN R06	028 VALVE FOR PARKING BRAKE, BENDIX SR-7	048 STOP LIGHT SWITCH, BENDIX	068
007 PRESSURE REDUCTOR VALVE AHI, BENDIX RV-3	027 VALVE FOR SERVICE BRAKE, BENDIX R-14	047 PRESSURE TRANSDUCER, VOLVO	067
006 TAG UNLOAD VALVE, NORRGREN V60	026 INVERSION VALVE, BENDIX TR-2	046 ACCESSORIES CUT-OFF SOLENOID, PARKER 7121	066
005 PING TANK, JOHNSON WELDING	025 TAG BRAKE VALVE RELAY, BENDIX R-12	045 KNEELING AIR TANK, JOHNSON WELDING	065
004 SOLENOID VALVE (VOLVO ENGINE)	024 ABS VALVE MODULATOR BENDIX M320	044 FRONT HEIGHT CONTROL VALVE, BARKSDALE 52341	064
003 ALLISON SOLENOID VALVE	023 RELIEF VALVE, NORRGREN V72G	043 KNEELING SUSPENSION VALVE, NORRGREN NUGGET 200	063
002 ALLISON TRANSMISSION RETARDER CYLINDER	022 TAG BAG DEPLETION VALVE NORRGREN NUGGET 200	042 KNEELING SUSPENSION VALVE, NORRGREN NUGGET 200	062
001 AIR COMPRESSOR WABCO 636	021 UNLOAD VALVE NORRGREN, NUGGET 200	041 FRONT AIR SPRING, GOODYEAR 1R12	061

**PREVOST**

DESCRIPTION: PNEUMATIC SCHEMATIC COACH X3 NYCTA COMPLETE SYSTEM

REV.: D  
 DATE: 2012/02

PAGE: D140390 P.1

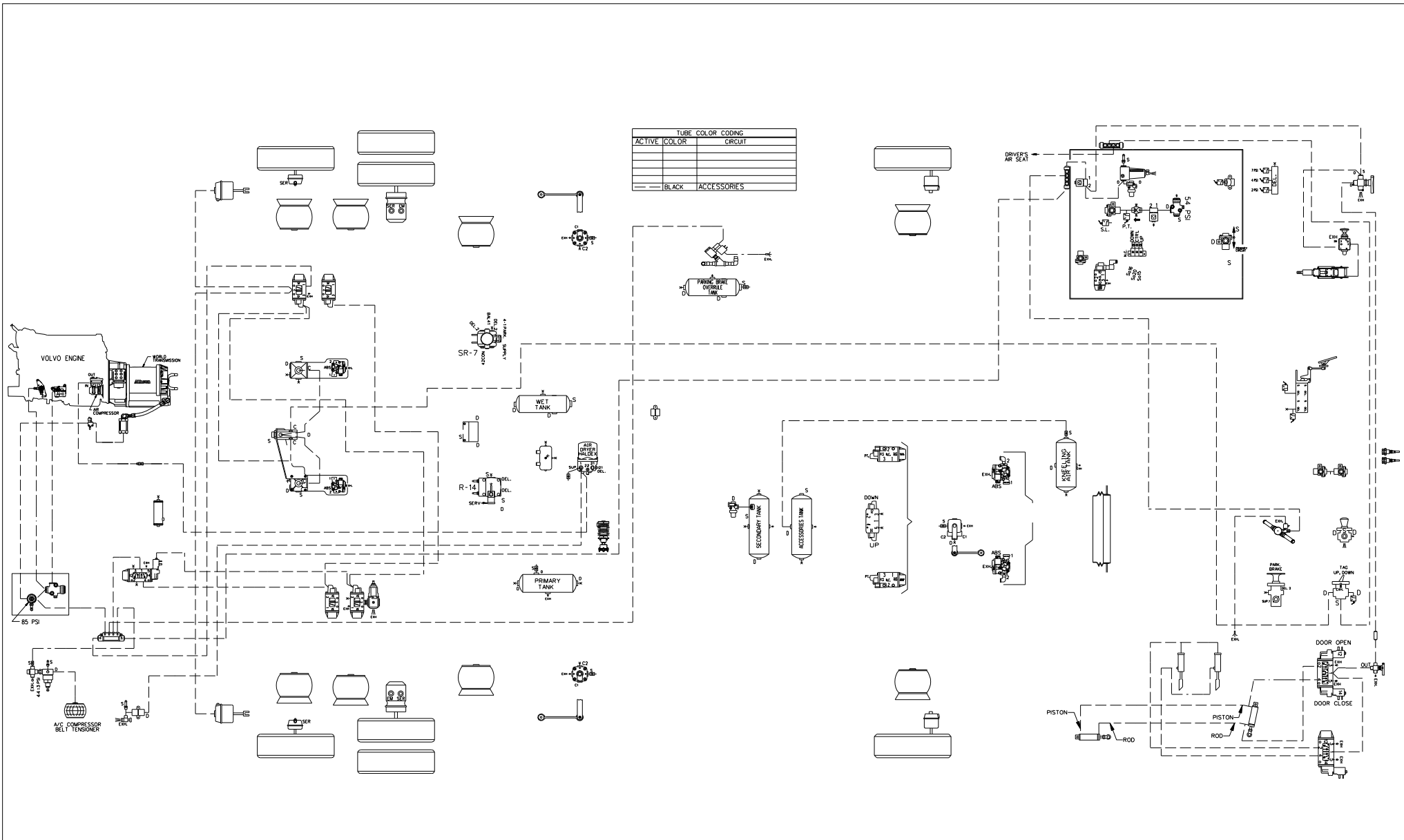

**PREVOST**®

DESCRIPTION:

SCHEMATIC PNEU. X3 NYCTA,  
ACCESSORIES ONLY

REV.:

B

PAGE:

DATE:

2011/04

D140390 P1.2

TUBE COLOR CODING		
ACTIVE	COLOR	CIRCUIT
	BLACK	ACCESSORIES

NOTE: ITEM #4 REMOVED FOR VEHICLES  
•C-5212 @ •C-5232

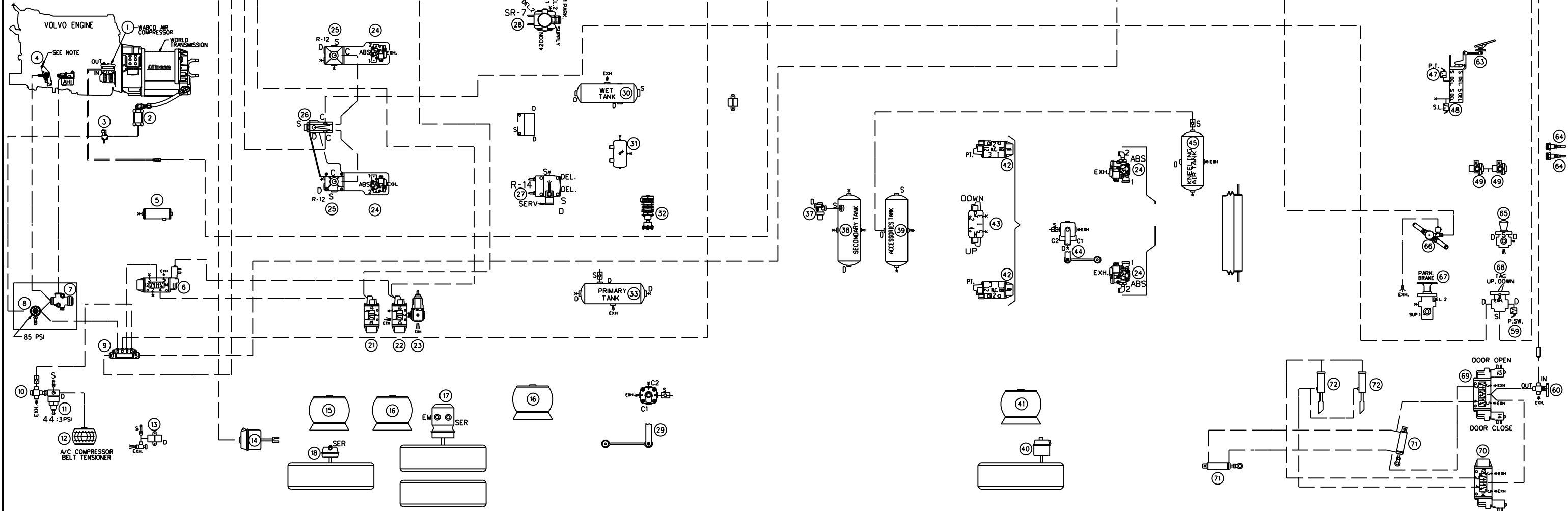

020 TAG UNLOAD VALVE NORRGREN NUGGET 200	040 FRONT BRAKE CHAMBER, KNORR TYPE 24	060 ENTRANCE DOOR MANUAL VALVE, D-PRO V82	080
019 LIFT TAG AIR VALVE NORRGREN NUGGET 200	039 ACCESSORIES AIR TANK, JOHNSON WELDING	059 PRESSURE SWITCH N.O. ALLISON	079
018 TAG AXLE BRAKE CHAMBER KNORR TYPE 14	038 SECONDARY AIR TANK, JOHNSON WELDING	058 PRESSURE SWITCH N.C. KLIXON	078
017 DRIVE AXLE BRAKE CHAMBER, KNORR TYPE 24/24	037 PROTECTION VALVE, BENDIX PR-4	057 PRESSURE REDUCING VALVE, BENDIX RV-3	077
016 DRIVE AXLE AIR SPRING GOODYEAR, TR11	036 PARKING BRAKE OVERRULE AIR TANK, JOHNSON WELDING	056 INLINE QUICK RELEASE VALVE BENDIX, QR-L	076
015 TAG AXLE AIR SPRING GOODYEAR, TR12	035 WATER VALVE SOLENOID BURKERT, SYSTEM 2002	055 SOLENOID ENTRANCE DOOR INTERLOCK PARKER 7131	075
014 LIFT TAG AIR CYLINDER MGM, TYPE 36	034 AIR DRYER HALDEX	054 MANIFOLD VALVE NORRGREN D0043	074
013 REAR AIR FILL VALVE	033 PRIMARY AIR TANK, JOHNSON WELDING	053 PARKING BRAKE INTERLOCK, NORRGREN NUGGET 200	073
012 AIR BAG 4", GOODYEAR 1S4	032 OIL SEPARATOR, HALDEX CONSEP	052 PROTECTION VALVE, BENDIX PR-4	072
011 BELT TENSIONER PRESSURE REGULATOR NORRGREN R06	031 PURGE TANK, JOHNSON WELDING	051 AIR FILTER NORRGREN F74G	071
010 BELT TENSIONER MANUAL VALVE	030 WET TANK, JOHNSON WELDING	050 FRONT FILL VALVE, SCHRAEDER 645	070
009 AIR MANIFOLD BLOC, PARKER 24M	029 REAR HEIGHT CONTROL VALVE, BARKSDALE 52321	049 DOUBLE CHECK VALVE, BENDIX DC-4	069
008 REGULATOR OUTPUT RETARDER, NORRGREN R06	028 VALVE FOR PARKING BRAKE, BENDIX SR-7	048 STOP LIGHT SWITCH, BENDIX	068
007 PRESSURE REDUCTOR VALVE AHI, BENDIX RV-3	027 VALVE FOR SERVICE BRAKE, BENDIX R-14	047 PRESSURE TRANSDUCER, VOLVO	067
006 TAG UNLOAD VALVE, NORRGREN V60	026 INVERSION VALVE, BENDIX TR-2	046 ACCESSORIES CUT-OFF SOLENOID, PARKER 7121	066
005 PING TANK, JOHNSON WELDING	025 TAG BRAKE VALVE RELAY, BENDIX R-12	045 KNEELING AIR TANK, JOHNSON WELDING	065
004 SOLENOID VALVE (VOLVO ENGINE)	024 ABS VALVE MODULATOR BENDIX M320	044 FRONT HEIGHT CONTROL VALVE, BARKSDALE 52341	064
003 ALLISON SOLENOID VALVE	023 RELIEF VALVE, NORRGREN V72G	043 KNEELING SUSPENSION VALVE, NORRGREN NUGGET 200	063
002 ALLISON TRANSMISSION RETARDER CYLINDER	022 TAG BAG DEPLETION VALVE NORRGREN NUGGET 200	042 KNEELING SUSPENSION VALVE, NORRGREN NUGGET 200	062
001 AIR COMPRESSOR WABCO 636	021 UNLOAD VALVE NORRGREN, NUGGET 200	041 FRONT AIR SPRING, GOODYEAR 1R12	061
ITEM DESCRIPTION	ITEM DESCRIPTION	ITEM DESCRIPTION	ITEM DESCRIPTION

DESCRIPTION:

PNEUMATIC SCHEMATIC X3 NYCTA  
ACCESSORIES ONLY

**PREVOST**

REV.:

D

PAGE:

D140390 P1.2

DATE:

2012/02

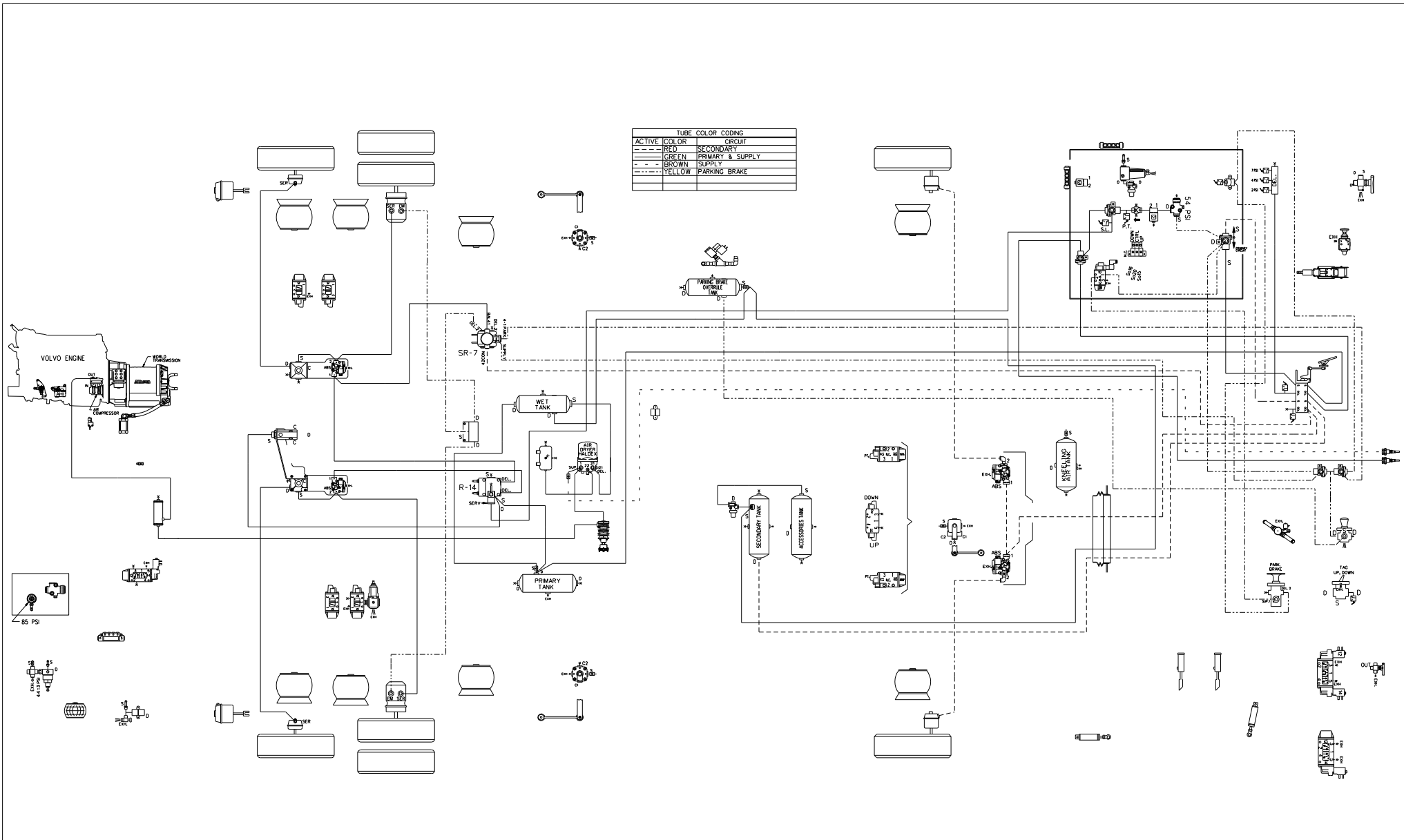

**PREVOST**

DESCRIPTION:

SCHMATIC PNEU. X3 NYCTA,  
BRAKES, ALIMENTATION & SUPPLY SYS. ONLY

REV.:

B

PAGE:

D140390 P1.3

DATE:

2011/04

TUBE COLOR CODING		
ACTIVE	COLOR	CIRCUIT
- - -	RED	SECONDARY
- - -	GREEN	PRIMARY & SUPPLY
- - -	BROWN	SUPPLY
- - -	YELLOW	PARKING BRAKE

NOTE: ITEM #4 REMOVED FOR VEHICLES  
•C-5212 @ •C-5232

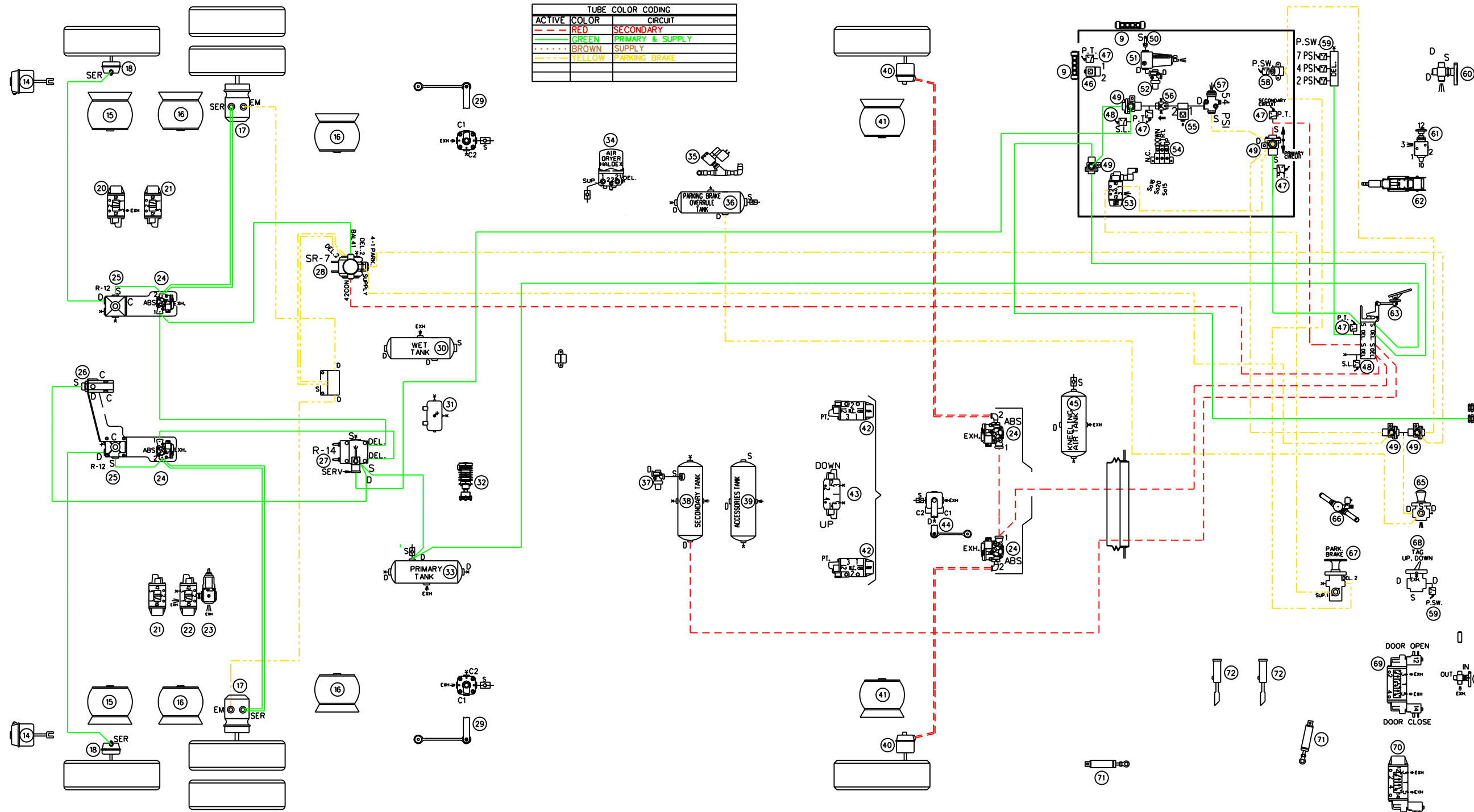
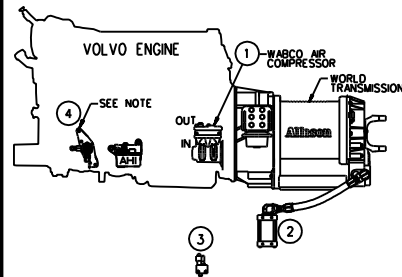

020 TAG UNLOAD VALVE NORRGREN NUGGET 200	040 FRONT BRAKE CHAMBER , KNORR TYPE 24	060 ENTRANCE DOOR MANUAL VALVE ,D-PRO V82	080
019 LIFT TAG AIR VALVE NORRGREN NUGGET 200	039 ACCESSORIES AIR TANK , JOHNSON WELDING	059 PRESSURE SWITCH N.O. ALLISON	079
018 TAG AXLE BRAKE CHAMBER KNORR ,TYPE 14	038 SECONDARY AIR TANK , JOHNSON WELDING	058 PRESSURE SWITCH N.C. KLIXON	078
017 DRIVE AXLE BRAKE CHAMBER , KNORR TYPE 24/24	037 PROTECTION VALVE , BENDIX PR-4	057 PRESSURE REDUCING VALVE , BENDIX RV-3	077
016 DRIVE AXLE AIR SPRING GOODYEAR , TR11	036 PARKING BRAKE OVERRULE AIR TANK,JOHNSON WELDING	056 INLINE QUICK RELEASE VALVE BENDIX , QR-L	076
015 TAG AXLE AIR SPRING GOODYEAR , TR12	035 WATER VALVE SOLENOID BURKERT , SYSTEM 2002	055 SOLENOID ENTRANCE DOOR INTERLOCK PARKER 7131	075
014 LIFT TAG AIR CYLINDER MGM , TYPE 36	034 AIR DRYER HALDEX	054 MANIFOLD VALVE NORRGREN D0043	074
013 REAR AIR FILL VALVE	033 PRIMARY AIR TANK , JOHNSON WELDING	053 PARKING BRAKE INTERLOCK, NORRGREN NUGGET 200	073
012 AIR BAG 4" , GOODYEAR 1S4	032 OIL SEPARATOR , HALDEX CONSEP	052 PROTECTION VALVE , BENDIX PR-4	072
011 BELT TENSIONER PRESSURE REGULATOR NORRGREN R06	031 PURGE TANK , JOHNSON WELDING	051 AIR FILTER NORRGREN F74G	071
010 BELT TENSIONER MANUAL VALVE	030 WET TANK , JOHNSON WELDING	050 FRONT FILL VALVE , SCHRAEDER 645	070
009 AIR MANIFOLD BLOC , PARKER 24M	029 REAR HEIGHT CONTROL VALVE , BARKSDALE 52321	049 DOUBLE CHECK VALVE, BENDIX DC-4	069
008 REGULATOR OUTPUT RETARDER , NORRGREN R06	028 VALVE FOR PARKING BRAKE , BENDIX SR-7	048 STOP LIGHT SWITCH , BENDIX	068
007 PRESSURE REDUCTOR VALVE AHI , BENDIX RV-3	027 VALVE FOR SERVICE BRAKE , BENDIX R-14	047 PRESSURE TRANSDUCER , VOLVO	067
006 TAG UNLOAD VALVE , NORRGREN V60	026 INVERSION VALVE , BENDIX TR-2	046 ACCESSORIES CUT-OFF SOLENOID, PARKER 7121	066
005 PING TANK , JOHNSON WELDING	025 TAG BRAKE VALVE RELAY , BENDIX R-12	045 KNEELING AIR TANK , JOHNSON WELDING	065
004 SOLENOID VALVE (VOLVO ENGINE)	024 ABS VALVE MODULATOR BENDIX M320	044 FRONT HEIGHT CONTROL VALVE,BARKSDALE 52341	064
003 ALLISON SOLENOID VALVE	023 RELIEF VALVE , NORRGREN V72G	043 KNEELING SUSPENSION VALVE,NORRGREN NUGGET 200	063
002 ALLISON TRANSMISSION RETARDER CYLINDER	022 TAG BAG DEPLETION VALVE NORRGREN NUGGET 200	042 KNEELING SUSPENSION VALVE,NORRGREN NUGGET 200	062
001 AIR COMPRESSOR WABCO 636	021 UNLOAD VALVE NORRGREN, NUGGET 200	041 FRONT AIR SPRING , GOODYEAR 1R12	061
ITEM DESCRIPTION	ITEM DESCRIPTION	ITEM DESCRIPTION	ITEM DESCRIPTION

**PREVOST**

DESCRIPTION:

PNEUMATIC SCHEMATIC X3 NYCTA  
COMPLETE AIR BRAKE SYSTEM

REV.:

D

DATE:

2012/02

PAGE:

D140390 P1.3



TUBE COLOR CODING		
ACTIVE	COLOR	CIRCUIT

NOTE: ITEM #4 REMOVED  
FOR VEHICLES  
•C-5212 @ •C-5232

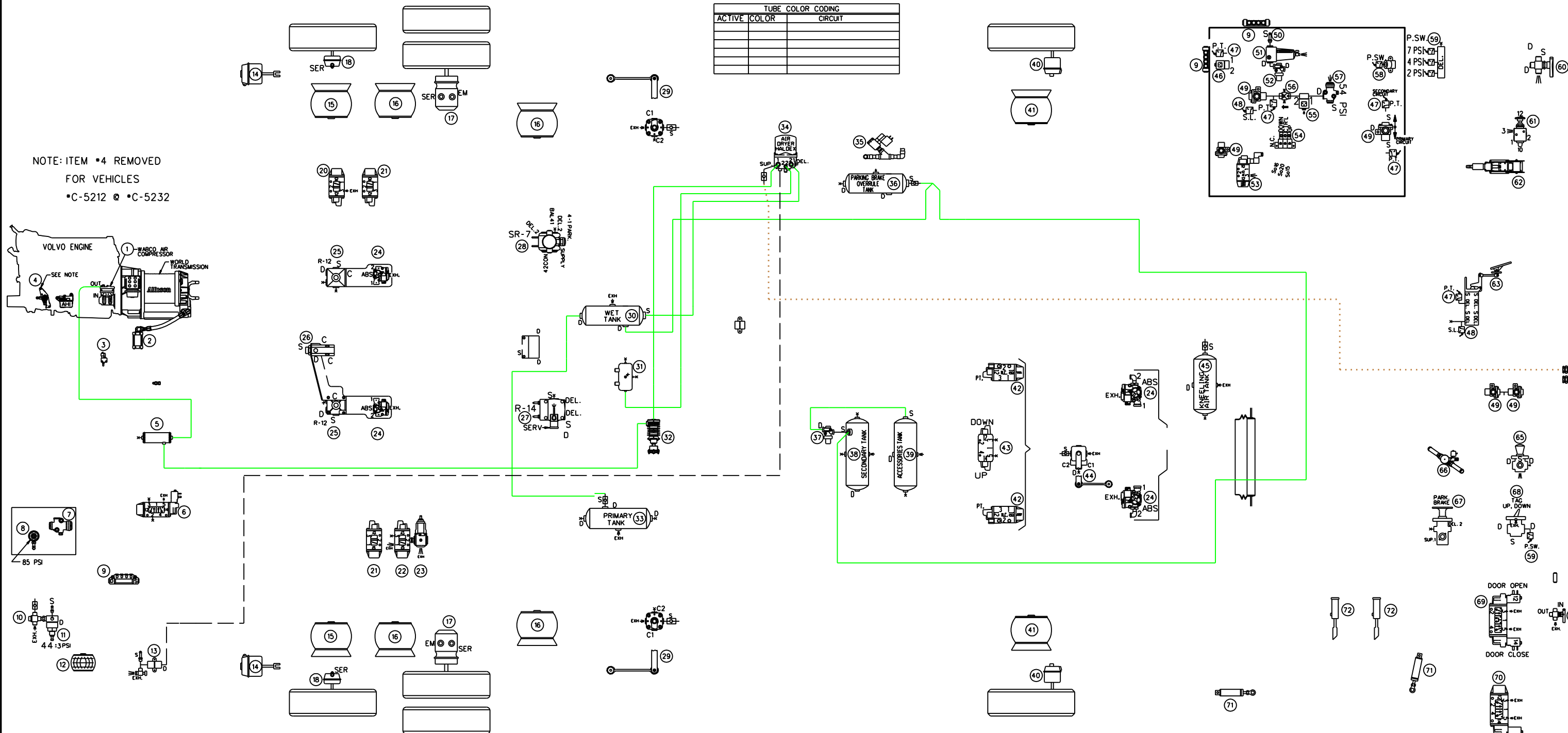

020 TAG UNLOAD VALVE NORRGREN NUGGET 200	040 FRONT BRAKE CHAMBER , KNORR TYPE 24	060 ENTRANCE DOOR MANUAL VALVE, D-PRO V82	080
019 LIFT TAG AIR VALVE NORRGREN NUGGET 200	039 ACCESSORIES AIR TANK , JOHNSON WELDING	059 PRESSURE SWITCH N.O. ALLISON	079
018 TAG AXLE BRAKE CHAMBER KNORR , TYPE 14	038 SECONDARY AIR TANK , JOHNSON WELDING	058 PRESSURE SWITCH N.C. KLIXON	078
017 DRIVE AXLE BRAKE CHAMBER , KNORR TYPE 24/24	037 PROTECTION VALVE , BENDIX PR-4	057 PRESSURE REDUCING VALVE , BENDIX RV-3	077
016 DRIVE AXLE AIR SPRING GOODYEAR , TR11	036 PARKING BRAKE OVERRULE AIR TANK,JOHNSON WELDING	056 INLINE QUICK RELEASE VALVE BENDIX , QR-L	076
015 TAG AXLE AIR SPRING GOODYEAR , TR12	035 WATER VALVE SOLENOID BURKERT , SYSTEM 2002	055 SOLENOID ENTRANCE DOOR INTERLOCK PARKER 7131	075
014 LIFT TAG AIR CYLINDER MGM , TYPE 36	034 AIR DRYER HALDEX	054 MANIFOLD VALVE NORRGREN D0043	074
013 REAR AIR FILL VALVE	033 PRIMARY AIR TANK , JOHNSON WELDING	053 PARKING BRAKE INTERLOCK, NORRGREN NUGGET 200	073
012 AIR BAG 4" , GOODYEAR 1S4	032 OIL SEPARATOR , HALDEX CONSEP	052 PROTECTION VALVE , BENDIX PR-4	072
011 BELT TENSIONER PRESSURE REGULATOR NORRGREN R06	031 PURGE TANK , JOHNSON WELDING	051 AIR FILTER NORRGREN F74G	071
010 BELT TENSIONER MANUAL VALVE	030 WET TANK , JOHNSON WELDING	050 FRONT FILL VALVE , SCHRAEDER 645	070
009 AIR MANIFOLD BLOC , PARKER 24M	029 REAR HEIGHT CONTROL VALVE , BARKSDALE 52321	049 DOUBLE CHECK VALVE, BENDIX DC-4	069
008 REGULATOR OUTPUT RETARDER , NORRGREN R06	028 VALVE FOR PARKING BRAKE , BENDIX SR-7	048 STOP LIGHT SWITCH , BENDIX	068
007 PRESSURE REDUCTOR VALVE AHI , BENDIX RV-3	027 VALVE FOR SERVICE BRAKE , BENDIX R-14	047 PRESSURE TRANSDUCER , VOLVO	067
006 TAG UNLOAD VALVE , NORRGREN V60	026 INVERSION VALVE , BENDIX TR-2	046 ACCESSORIES CUT-OFF SOLENOID, PARKER 7121	066
005 PING TANK , JOHNSON WELDING	025 TAG BRAKE VALVE RELAY , BENDIX R-12	045 KNEELING AIR TANK , JOHNSON WELDING	065
004 SOLENOID VALVE (VOLVO ENGINE)	024 ABS VALVE MODULATOR BENDIX M320	044 FRONT HEIGHT CONTROL VALVE, BARKSDALE 52341	064
003 ALLISON SOLENOID VALVE	023 RELIEF VALVE , NORRGREN V72G	043 KNEELING SUSPENSION VALVE, NORRGREN NUGGET 200	063
002 ALLISON TRANSMISSION RETARDER CYLINDER	022 TAG BAG DEPLETION VALVE NORRGREN NUGGET 200	042 KNEELING SUSPENSION VALVE, NORRGREN NUGGET 200	062
001 AIR COMPRESSOR WABCO 636	021 UNLOAD VALVE NORRGREN, NUGGET 200	041 FRONT AIR SPRING , GOODYEAR 1R12	061
ITEM DESCRIPTION	ITEM DESCRIPTION	ITEM DESCRIPTION	ITEM DESCRIPTION

DESCRIPTION:

PNEUMATIC SCHEMATIC COACH X3 NYCTA  
MAIN AIR SUPPLY

REV.: D  
DATE: 2012/02

PAGE:  
D140390 P1.3.1



TUBE COLOR CODING		
ACTIVE	COLOR	CIRCUIT
-	RED	SECONDARY

NOTE: ITEM #4 REMOVED  
FOR VEHICLES  
•C-5212 @ •C-5232

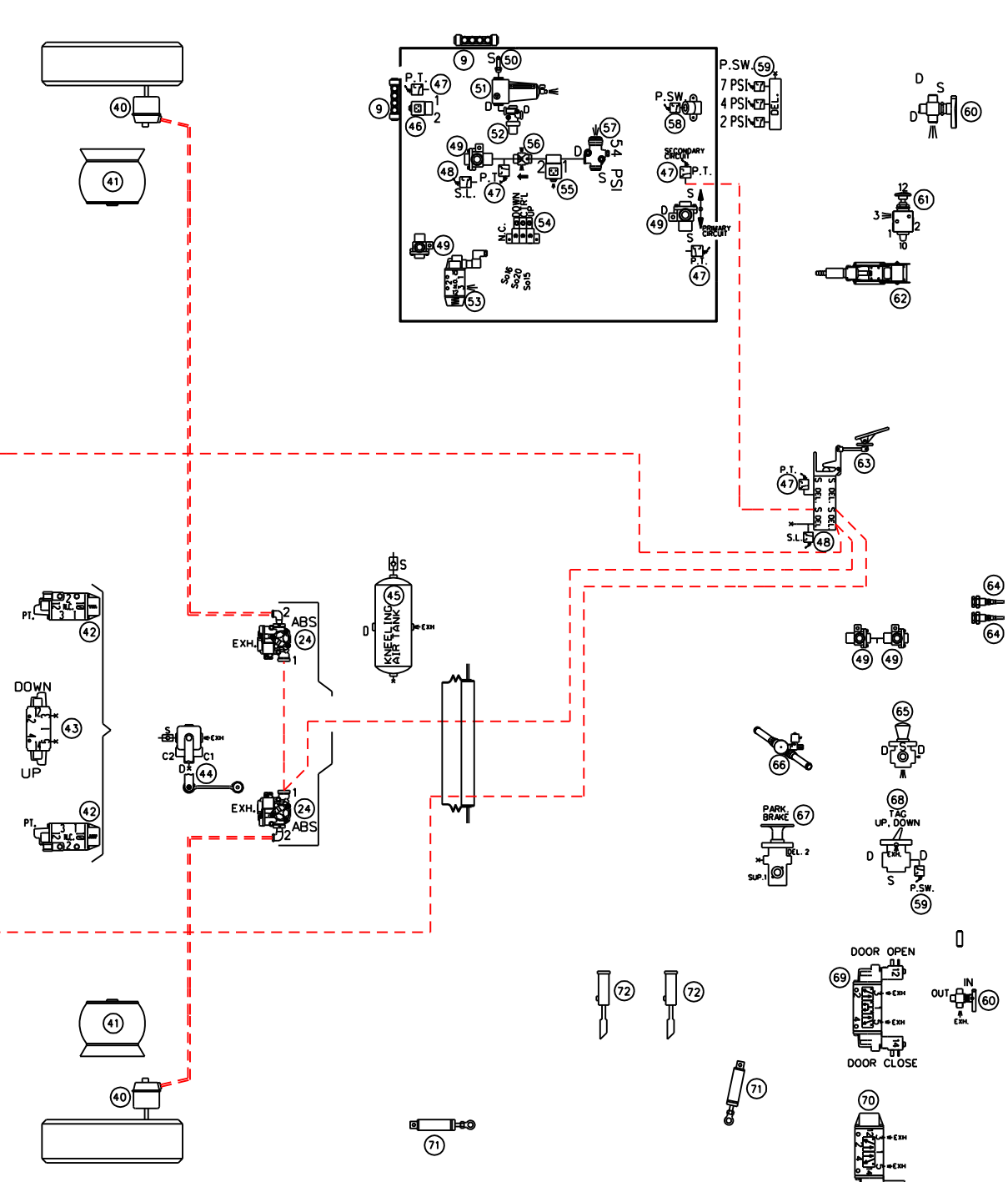
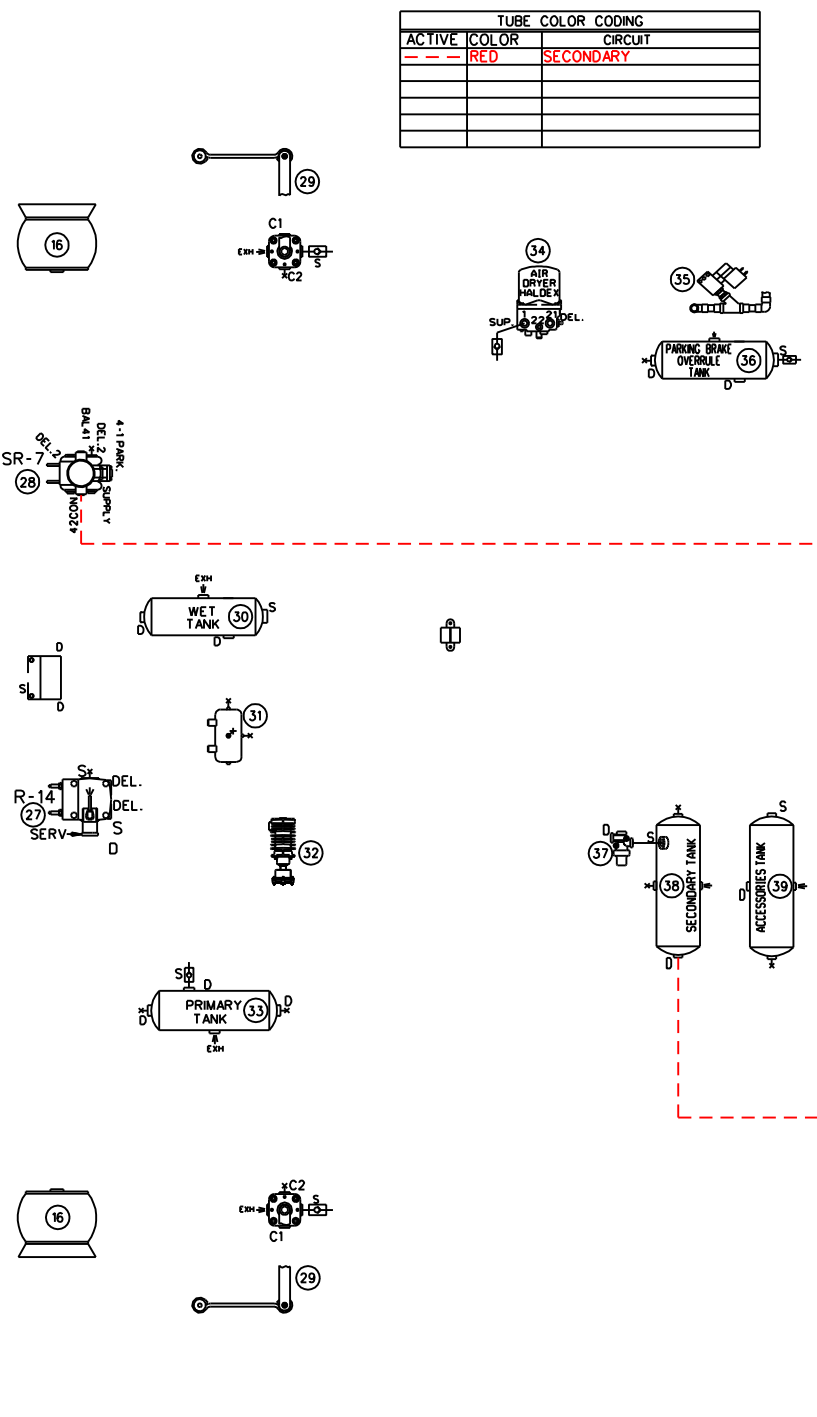
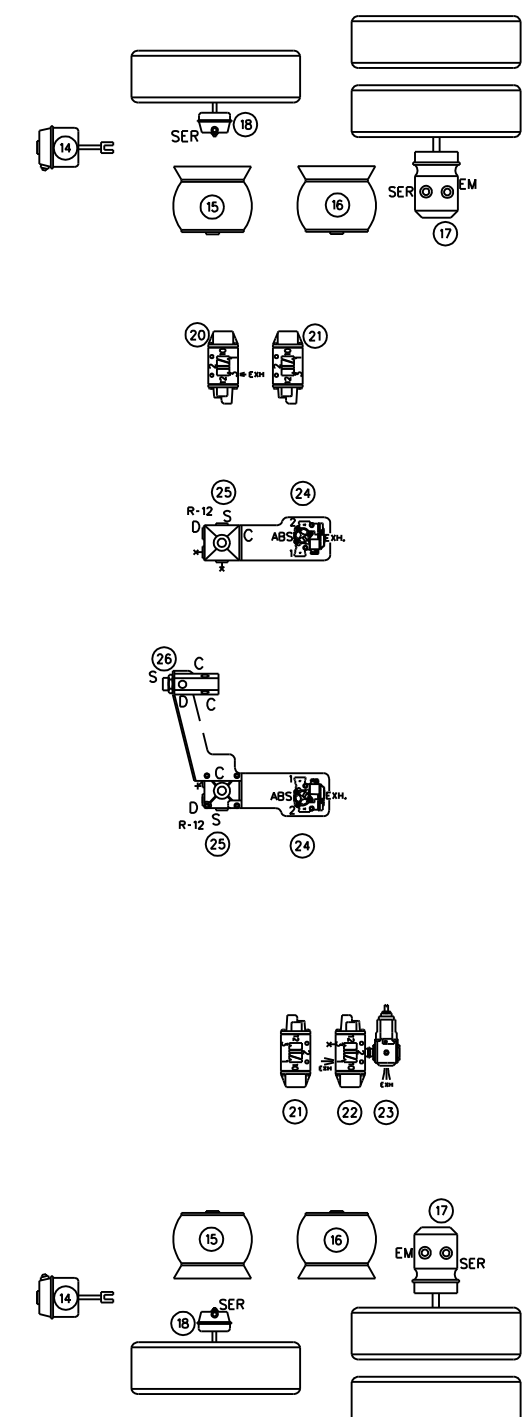
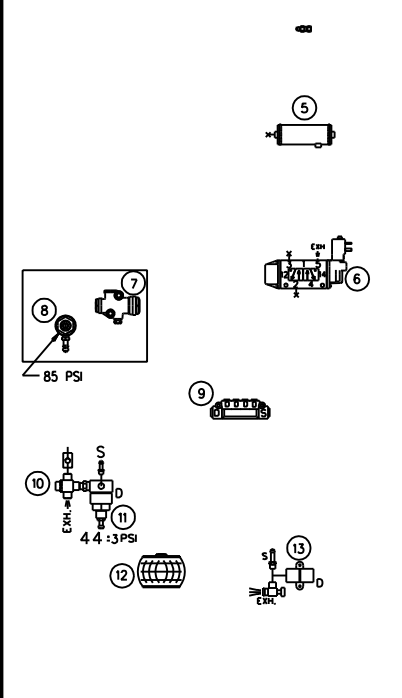
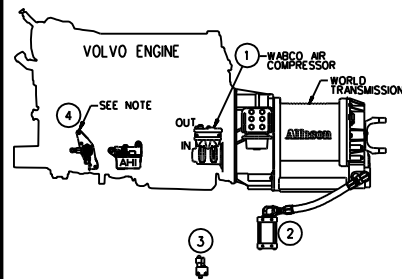

020 TAG UNLOAD VALVE NORRGREN, NUGGET 200	040 FRONT BRAKE CHAMBER, KNORR TYPE 24	060 ENTRANCE DOOR MANUAL VALVE, D-PRO V82	080
019 LIFT TAG AIR VALVE NORRGREN, NUGGET 200	039 ACCESSORIES AIR TANK, JOHNSON WELDING	059 PRESSURE SWITCH N.O. ALLISON	079
018 TAG AXLE BRAKE CHAMBER KNORR, TYPE 14	038 SECONDARY AIR TANK, JOHNSON WELDING	058 PRESSURE SWITCH N.C. KLIXON	078
017 DRIVE AXLE BRAKE CHAMBER, KNORR TYPE 24/24	037 PROTECTION VALVE, BENDIX PR-4	057 PRESSURE REDUCING VALVE, BENDIX RV-3	077
016 DRIVE AXLE AIR SPRING GOODYEAR, TR11	036 PARKING BRAKE OVERRULE AIR TANK, JOHNSON WELDING	056 INLINE QUICK RELEASE VALVE, BENDIX, QR-L	076
015 TAG AXLE AIR SPRING GOODYEAR, TR12	035 WATER VALVE SOLENOID BURKERT, SYSTEM 2002	055 SOLENOID ENTRANCE DOOR INTERLOCK PARKER 7131	075
014 LIFT TAG AIR CYLINDER MGM, TYPE 36	034 AIR DRYER HALDEX	054 MANIFOLD VALVE NORRGREN D0043	074
013 REAR AIR FILL VALVE	033 PRIMARY AIR TANK, JOHNSON WELDING	053 PARKING BRAKE INTERLOCK, NORRGREN NUGGET 200	073
012 AIR BAG 4", GOODYEAR 1S4	032 OIL SEPARATOR, HALDEX CONSEP	052 PROTECTION VALVE, BENDIX PR-4	072
011 BELT TENSIONER PRESSURE REGULATOR NORRGREN R06	031 PURGE TANK, JOHNSON WELDING	051 AIR FILTER NORRGREN F74G	071
010 BELT TENSIONER MANUAL VALVE	030 WET TANK, JOHNSON WELDING	050 FRONT FILL VALVE, SCHRAEDER 645	070
009 AIR MANIFOLD BLOC, PARKER 24M	029 REAR HEIGHT CONTROL VALVE, BARKSDALE 52321	049 DOUBLE CHECK VALVE, BENDIX DC-4	069
008 REGULATOR OUTPUT RETARDER, NORRGREN R06	028 VALVE FOR PARKING BRAKE, BENDIX SR-7	048 STOP LIGHT SWITCH, BENDIX	068
007 PRESSURE REDUCTOR VALVE AHI, BENDIX RV-3	027 VALVE FOR SERVICE BRAKE, BENDIX R-14	047 PRESSURE TRANSDUCER, VOLVO	067
006 TAG UNLOAD VALVE, NORRGREN V60	026 INVERSION VALVE, BENDIX TR-2	046 ACCESSORIES CUT-OFF SOLENOID, PARKER 7121	066
005 PING TANK, JOHNSON WELDING	025 TAG BRAKE VALVE RELAY, BENDIX R-12	045 KNEELING AIR TANK, JOHNSON WELDING	065
004 SOLENOID VALVE (VOLVO ENGINE)	024 ABS VALVE MODULATOR BENDIX M320	044 FRONT HEIGHT CONTROL VALVE, BARKSDALE 52341	064
003 ALLISON SOLENOID VALVE	023 RELIEF VALVE, NORRGREN V72G	043 KNEELING SUSPENSION VALVE, NORRGREN NUGGET 200	063
002 ALLISON TRANSMISSION RETARDER CYLINDER	022 TAG BAG DEPLETION VALVE NORRGREN NUGGET 200	042 KNEELING SUSPENSION VALVE, NORRGREN NUGGET 200	062
001 AIR COMPRESSOR WABCO 636	021 UNLOAD VALVE NORRGREN, NUGGET 200	041 FRONT AIR SPRING, GOODYEAR 1R12	061
ITEM DESCRIPTION	ITEM DESCRIPTION	ITEM DESCRIPTION	ITEM DESCRIPTION

**PREVOST**

DESCRIPTION:

PNEUMATIC SCHEMATIC X3 NYCTA  
FRONT BRAKE, SECONDARY RED COLOR TUBES

REV.: D  
DATE: 2012/02

PAGE: D140390 P1.3.2

TUBE COLOR CODING	
ACTIVE COLOR	CIRCUIT
GREEN	PRIMARY & SUPPLY
BROWN	SUPPLY

NOTE: ITEM #4 REMOVED FOR VEHICLES  
 \*C-5212 @ \*C-5232

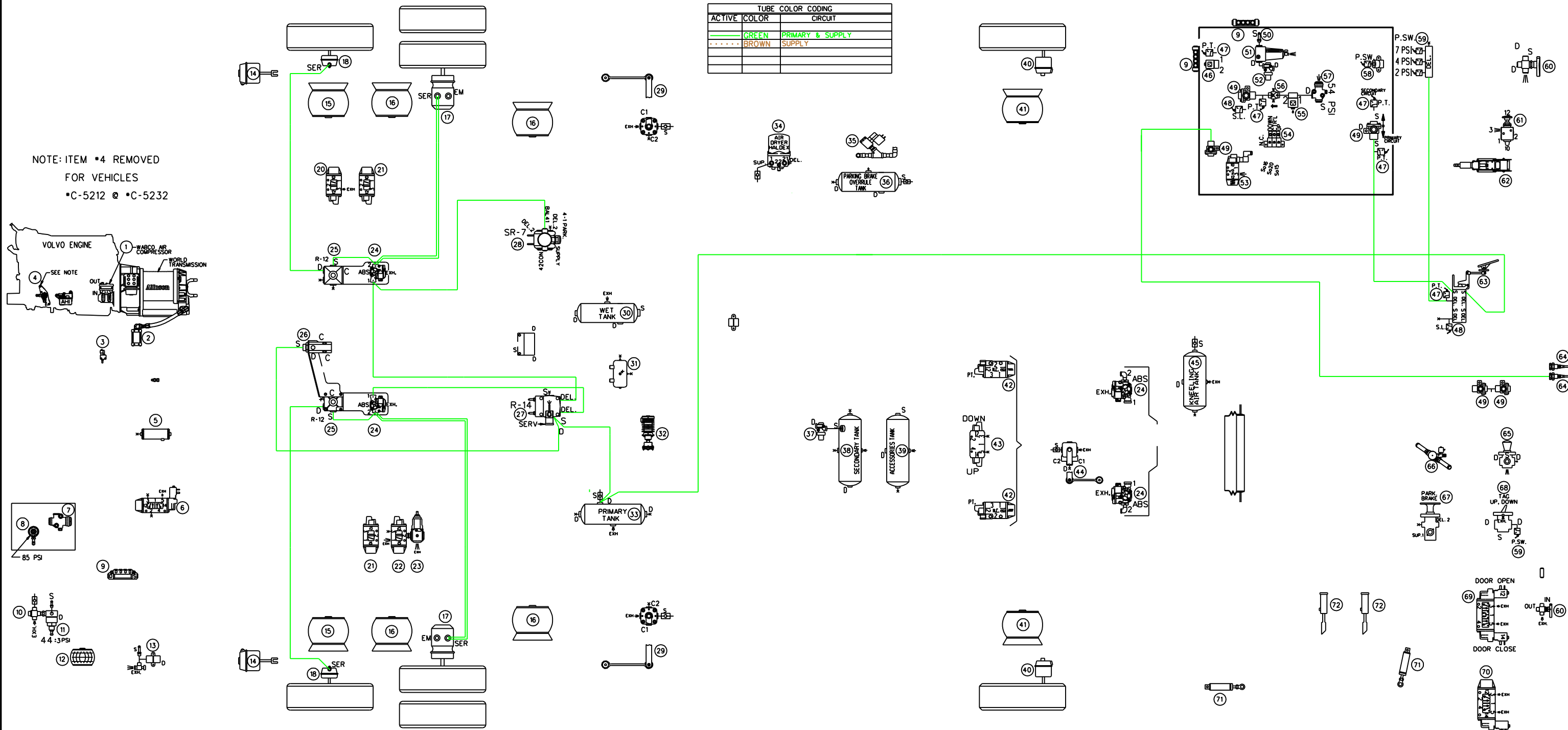

020 TAG UNLOAD VALVE NORRGREN, NUGGET 200	040 FRONT BRAKE CHAMBER, KNORR TYPE 24	060 ENTRANCE DOOR MANUAL VALVE, D-PRO V82	080
019 LIFT TAG AIR VALVE NORRGREN, NUGGET 200	039 ACCESSORIES AIR TANK, JOHNSON WELDING	059 PRESSURE SWITCH N.O. ALLISON	079
018 TAG AXLE BRAKE CHAMBER KNORR, TYPE 14	038 SECONDARY AIR TANK, JOHNSON WELDING	058 PRESSURE SWITCH N.C. KLIXON	078
017 DRIVE AXLE BRAKE CHAMBER, KNORR TYPE 24/24	037 PROTECTION VALVE, BENDIX PR-4	057 PRESSURE REDUCING VALVE, BENDIX RV-3	077
016 DRIVE AXLE AIR SPRING GOODYEAR, TR11	036 PARKING BRAKE OVERRULE AIR TANK, JOHNSON WELDING	056 INLINE QUICK RELEASE VALVE BENDIX, QR-L	076
015 TAG AXLE AIR SPRING GOODYEAR, TR12	035 WATER VALVE SOLENOID BURKERT, SYSTEM 2002	055 SOLENOID ENTRANCE DOOR INTERLOCK PARKER 7131	075
014 LIFT TAG AIR CYLINDER MGM, TYPE 36	034 AIR DRYER HALDEX	054 MANIFOLD VALVE NORRGREN D0043	074
013 REAR AIR FILL VALVE	033 PRIMARY AIR TANK, JOHNSON WELDING	053 PARKING BRAKE INTERLOCK, NORRGREN NUGGET 200	073
012 AIR BAG 4", GOODYEAR 1S4	032 OIL SEPARATOR, HALDEX CONSEP	052 PROTECTION VALVE, BENDIX PR-4	072
011 BELT TENSIONER PRESSURE REGULATOR NORRGREN R06	031 PURGE TANK, JOHNSON WELDING	051 AIR FILTER NORRGREN F74G	071
010 BELT TENSIONER MANUAL VALVE	030 WET TANK, JOHNSON WELDING	050 FRONT FILL VALVE, SCHRAEDER 645	070
009 AIR MANIFOLD BLOC, PARKER 24M	029 REAR HEIGHT CONTROL VALVE, BARKSDALE 52321	049 DOUBLE CHECK VALVE, BENDIX DC-4	069
008 REGULATOR OUTPUT RETARDER, NORRGREN R06	028 VALVE FOR PARKING BRAKE, BENDIX SR-7	048 STOP LIGHT SWITCH, BENDIX	068
007 PRESSURE REDUCTOR VALVE AHI, BENDIX RV-3	027 VALVE FOR SERVICE BRAKE, BENDIX R-14	047 PRESSURE TRANSDUCER, VOLVO	067
006 TAG UNLOAD VALVE, NORRGREN V60	026 INVERSION VALVE, BENDIX TR-2	046 ACCESSORIES CUT-OFF SOLENOID, PARKER 7121	066
005 PING TANK, JOHNSON WELDING	025 TAG BRAKE VALVE RELAY, BENDIX R-12	045 KNEELING AIR TANK, JOHNSON WELDING	065
004 SOLENOID VALVE (VOLVO ENGINE)	024 ABS VALVE MODULATOR BENDIX M320	044 FRONT HEIGHT CONTROL VALVE, BARKSDALE 52341	064
003 ALLISON SOLENOID VALVE	023 RELIEF VALVE, NORRGREN V72G	043 KNEELING SUSPENSION VALVE, NORRGREN NUGGET 200	063
002 ALLISON TRANSMISSION RETARDER CYLINDER	022 TAG BAG DEPLETION VALVE NORRGREN NUGGET 200	042 KNEELING SUSPENSION VALVE, NORRGREN NUGGET 200	062
001 AIR COMPRESSOR WABCO 636	021 UNLOAD VALVE NORRGREN, NUGGET 200	041 FRONT AIR SPRING, GOODYEAR 1R12	061
ITEM DESCRIPTION	ITEM DESCRIPTION	ITEM DESCRIPTION	ITEM DESCRIPTION

**PREVOST**

DESCRIPTION:

PNEUMATIC SCHEMATIC X3 NYCTA  
 REAR BRAKE, PRIMARY GREEN COLOR TUBES

REV.: D  
 DATE: 2012/02

PAGE:  
 D140390 P1.3.3

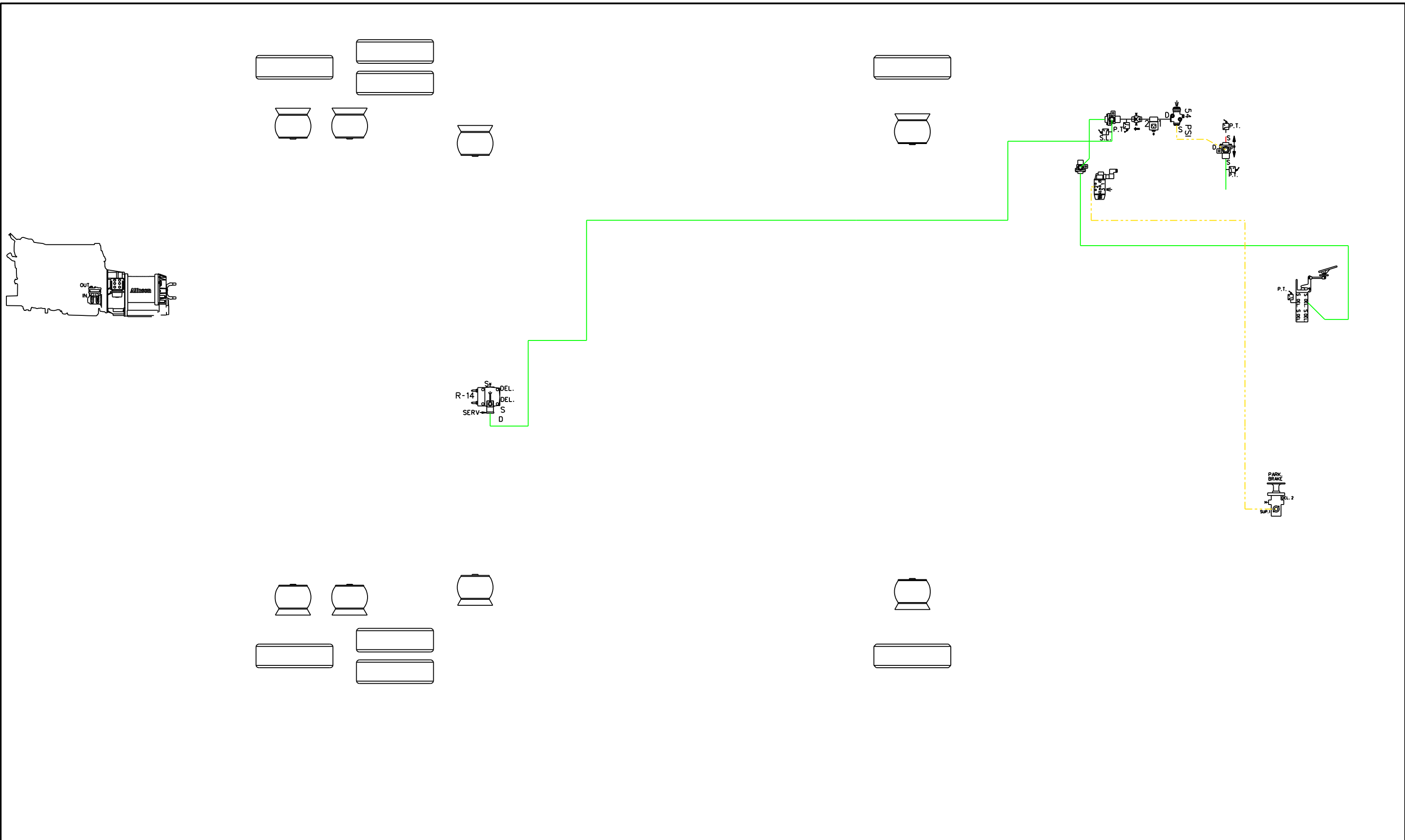

TUBE COLOR CODING		
ACTIVE	COLOR	CIRCUIT
---	YELLOW	PARKING BRAKE

NOTE: ITEM #4 REMOVED  
FOR VEHICLES  
•C-5212 @ •C-5232

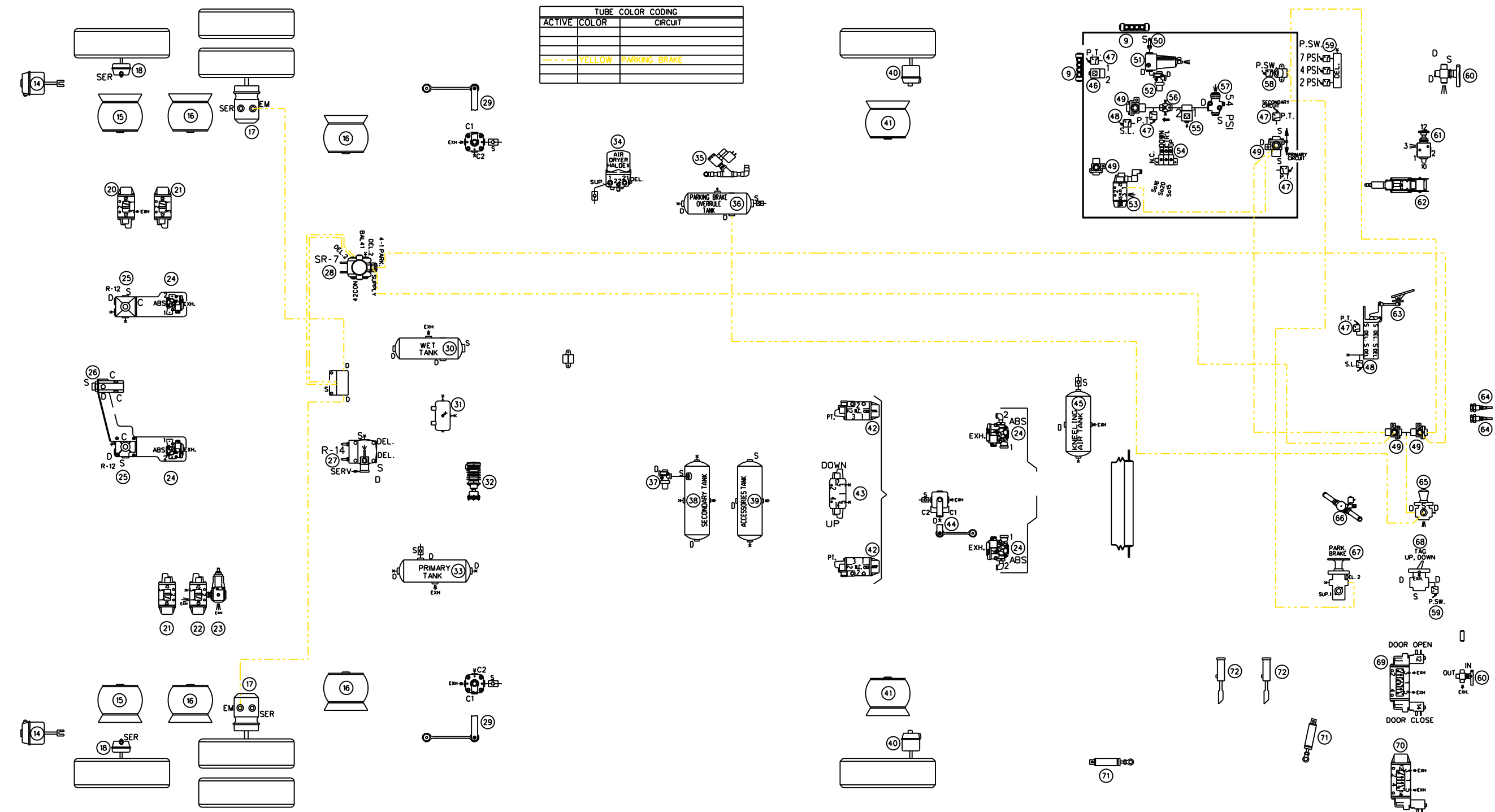
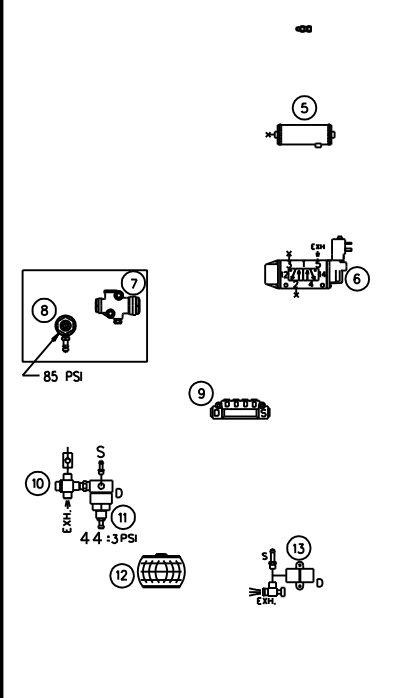
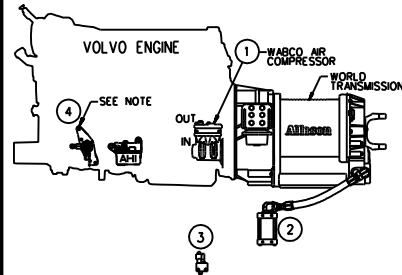

020 TAG UNLOAD VALVE NORRGREN NUGGET 200	040 FRONT BRAKE CHAMBER, KNORR TYPE 24	060 ENTRANCE DOOR MANUAL VALVE, D-PRO V82	080
019 LIFT TAG AIR VALVE NORRGREN NUGGET 200	039 ACCESSORIES AIR TANK, JOHNSON WELDING	059 PRESSURE SWITCH N.O. ALLISON	079
018 TAG AXLE BRAKE CHAMBER KNORR, TYPE 14	038 SECONDARY AIR TANK, JOHNSON WELDING	058 PRESSURE SWITCH N.C. KLIXON	078
017 DRIVE AXLE BRAKE CHAMBER, KNORR TYPE 24/24	037 PROTECTION VALVE, BENDIX PR-4	057 PRESSURE REDUCING VALVE, BENDIX RV-3	077
016 DRIVE AXLE AIR SPRING GOODYEAR, TR11	036 PARKING BRAKE OVERRULE AIR TANK, JOHNSON WELDING	056 INLINE QUICK RELEASE VALVE BENDIX, QR-L	076
015 TAG AXLE AIR SPRING GOODYEAR, TR12	035 WATER VALVE SOLENOID BURKERT, SYSTEM 2002	055 SOLENOID ENTRANCE DOOR INTERLOCK PARKER 7131	075
014 LIFT TAG AIR CYLINDER MGM, TYPE 36	034 AIR DRYER HALDEX	054 MANIFOLD VALVE NORRGREN D0043	074
013 REAR AIR FILL VALVE	033 PRIMARY AIR TANK, JOHNSON WELDING	053 PARKING BRAKE INTERLOCK, NORRGREN NUGGET 200	073
012 AIR BAG 4", GOODYEAR 1S4	032 OIL SEPARATOR, HALDEX CONSEP	052 PROTECTION VALVE, BENDIX PR-4	072
011 BELT TENSIONER PRESSURE REGULATOR NORRGREN R06	031 PURGE TANK, JOHNSON WELDING	051 AIR FILTER NORRGREN F74G	071
010 BELT TENSIONER MANUAL VALVE	030 WET TANK, JOHNSON WELDING	050 FRONT FILL VALVE, SCHRAEDER 645	070
009 AIR MANIFOLD BLOC, PARKER 24M	029 REAR HEIGHT CONTROL VALVE, BARKSDALE 52321	049 DOUBLE CHECK VALVE, BENDIX DC-4	069
008 REGULATOR OUTPUT RETARDER, NORRGREN R06	028 VALVE FOR PARKING BRAKE, BENDIX SR-7	048 STOP LIGHT SWITCH, BENDIX	068
007 PRESSURE REDUCTOR VALVE AHI, BENDIX RV-3	027 VALVE FOR SERVICE BRAKE, BENDIX R-14	047 PRESSURE TRANSDUCER, VOLVO	067
006 TAG UNLOAD VALVE, NORRGREN V60	026 INVERSION VALVE, BENDIX TR-2	046 ACCESSORIES CUT-OFF SOLENOID, PARKER 7121	066
005 PING TANK, JOHNSON WELDING	025 TAG BRAKE VALVE RELAY, BENDIX R-12	045 KNEELING AIR TANK, JOHNSON WELDING	065
004 SOLENOID VALVE (VOLVO ENGINE)	024 ABS VALVE MODULATOR BENDIX M320	044 FRONT HEIGHT CONTROL VALVE, BARKSDALE 52341	064
003 ALLISON SOLENOID VALVE	023 RELIEF VALVE, NORRGREN V72G	043 KNEELING SUSPENSION VALVE, NORRGREN NUGGET 200	063
002 ALLISON TRANSMISSION RETARDER CYLINDER	022 TAG BAG DEPLETION VALVE NORRGREN NUGGET 200	042 KNEELING SUSPENSION VALVE, NORRGREN NUGGET 200	062
001 AIR COMPRESSOR WABCO 636	021 UNLOAD VALVE NORRGREN, NUGGET 200	041 FRONT AIR SPRING, GOODYEAR 1R12	061
ITEM DESCRIPTION	ITEM DESCRIPTION	ITEM DESCRIPTION	ITEM DESCRIPTION

**PREVOST**

DESCRIPTION:

PNEUMATIC SCHEMATIC X3 NYCTA  
EMERGENCY AND PARKING BRAKE

REV.: D  
DATE: 2012/02

PAGE:  
D140390 P1.3.5

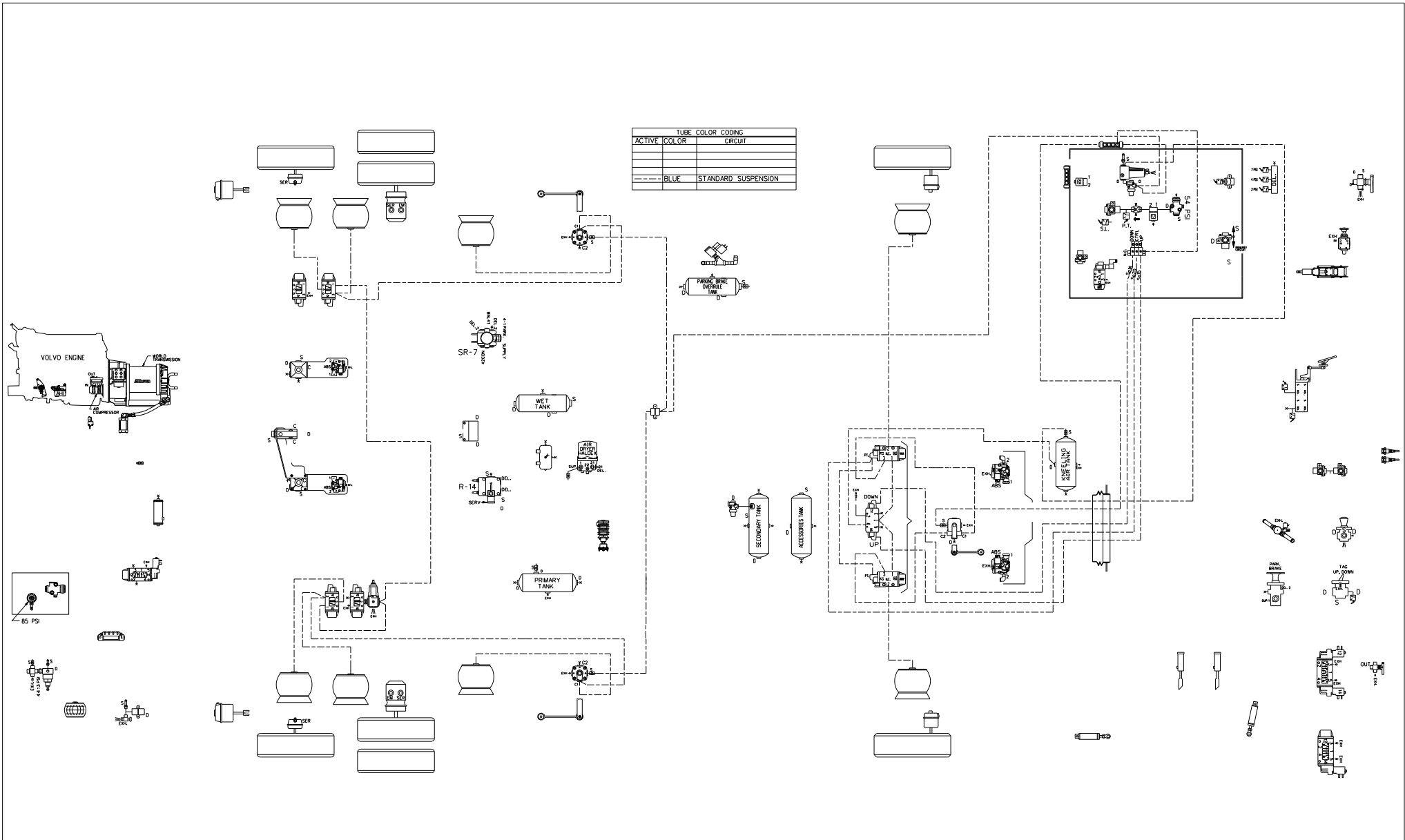

**PREVOST**

DESCRIPTION:

SCHMATIC PNEU. X3 NYCTA,  
SUSPENSION SYS. ONLY

REV.:

B

PAGE:

DATE:

2011/04

D140390 P1.4



TUBE COLOR CODING		
ACTIVE	COLOR	CIRCUIT
---	BLUE	STANDARD SUSPENSION

NOTE: ITEM #4 REMOVED FOR VEHICLES  
 \*C-5212 @ \*C-5232

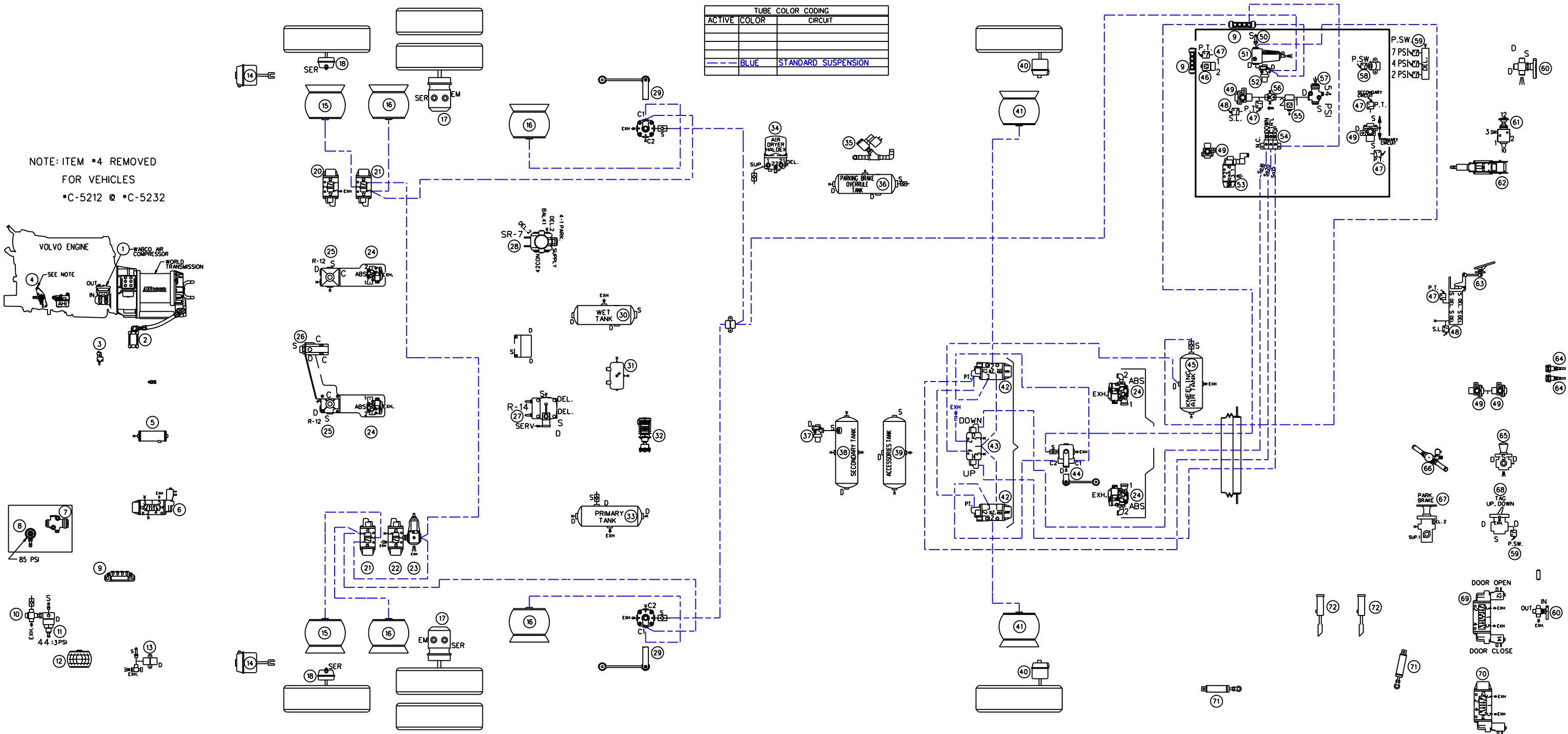

020 TAG UNLOAD VALVE NORRGREN, NUGGET 200	040 FRONT BRAKE CHAMBER, KNORR TYPE 24	060 ENTRANCE DOOR MANUAL VALVE, D-PRO V82	080
019 LIFT TAG AIR VALVE NORRGREN, NUGGET 200	039 ACCESSORIES AIR TANK, JOHNSON WELDING	059 PRESSURE SWITCH N.O. ALLISON	079
018 TAG AXLE BRAKE CHAMBER KNORR, TYPE 14	038 SECONDARY AIR TANK, JOHNSON WELDING	058 PRESSURE SWITCH N.C. KLIXON	078
017 DRIVE AXLE BRAKE CHAMBER, KNORR TYPE 24/24	037 PROTECTION VALVE, BENDIX PR-4	057 PRESSURE REDUCING VALVE, BENDIX RV-3	077
016 DRIVE AXLE AIR SPRING GOODYEAR, TR11	036 PARKING BRAKE SOLENOID BURKERT, SYSTEM 2002	056 INLINE QUICK RELEASE VALVE, BENDIX, QR-L	076
015 TAG AXLE AIR SPRING GOODYEAR, TR12	035 WATER VALVE SOLENOID BURKERT, SYSTEM 2002	055 SOLENOID ENTRANCE DOOR INTERLOCK PARKER 7131	075
014 LIFT TAG AIR CYLINDER MGM, TYPE 36	034 AIR DRYER HALDEX	054 MANIFOLD VALVE NORRGREN D0043	074
013 REAR AIR FILL VALVE	033 PRIMARY AIR TANK, JOHNSON WELDING	053 PARKING BRAKE INTERLOCK, NORRGREN NUGGET 200	073
012 AIR BAG 4", GOODYEAR 154	032 OIL SEPARATOR, HALDEX CONSEP	052 PROTECTION VALVE, BENDIX PR-4	072
011 BELT TENSIONER PRESSURE REGULATOR NORRGREN R06	031 PURGE TANK, JOHNSON WELDING	051 AIR FILTER NORRGREN F74G	071
010 BELT TENSIONER MANUAL VALVE	030 WET TANK, JOHNSON WELDING	050 FRONT FILL VALVE, SCHRAEDER 645	070
009 AIR MANIFOLD BLOC, PARKER 24M	029 REAR HEIGHT CONTROL VALVE, BARKSDALE 52321	049 DOUBLE CHECK VALVE, BENDIX DC-4	069
008 REGULATOR OUTPUT RETARDER, NORRGREN R06	028 VALVE FOR PARKING BRAKE, BENDIX SR-7	048 STOP LIGHT SWITCH, BENDIX	068
007 PRESSURE REDUCTOR VALVE AHI, BENDIX RV-3	027 VALVE FOR SERVICE BRAKE, BENDIX R-14	047 PRESSURE TRANSDUCER, VOLVO	067
006 TAG UNLOAD VALVE, NORRGREN V60	026 INVERSION VALVE, BENDIX TR-2	046 ACCESSORIES CUT-OFF SOLENOID, PARKER 7121	066
005 PING TANK, JOHNSON WELDING	025 TAG BRAKE VALVE RELAY, BENDIX R-12	045 KNEELING AIR TANK, JOHNSON WELDING	065
004 SOLENOID VALVE (VOLVO ENGINE)	024 ABS VALVE MODULATOR BENDIX M320	044 FRONT HEIGHT CONTROL VALVE, BARKSDALE 52341	064
003 ALLISON SOLENOID VALVE	023 RELIEF VALVE, NORRGREN V72G	043 KNEELING SUSPENSION VALVE, NORRGREN NUGGET 200	063
002 ALLISON TRANSMISSION RETARDER CYLINDER	022 TAG BAG DEPLETION VALVE, NORRGREN NUGGET 200	042 KNEELING SUSPENSION VALVE, NORRGREN NUGGET 200	062
001 AIR COMPRESSOR WABCO 636	021 UNLOAD VALVE, NORRGREN, NUGGET 200	041 FRONT AIR SPRING, GOODYEAR 1R12	061
ITEM	DESCRIPTION	ITEM	DESCRIPTION

# PREVOST

DESCRIPTION:

PNEUMATIC SCHEMATIC X3 NYCTA  
 SUSPENSION SYSTEM ONLY

REV.: D  
 DATE: 2012/02

PAGE: D140390 P1.4