

BALLOON	PIPE
*1	1/4" O.D. BLACK

TUBE COLOR CODING		
LINE TYPE	COLOR	CIRCUIT
	BLACK	ACCESSOIRES

PREVOST®

DESCRIPTION:

BUS SHELL WE WITH SPECIAL OPTION AIR HORN

REV.:

A

DATE:

2013/02

PAGE:

D140385 SP1.1

PREVOST

Pneumatic diagram

PNEUMATIC DIAGRAMS WE & WM BUS SHELL WITH INDEPENDENT SUSPENSION SYSTEM

NO:	D140385P0	REVISION :	G
-----	------------------	------------	----------

EFF. OC#	2010001 WE 2010060 WM	PRIOR TO OC#	2011095	DR.	Robert Bouillon	date	2013-02-06
EFF. VEH#	#B-5003 WE #C-5097 WM	PRIOR TO VEH#	#C-5233 WE #C-5236 WM	CHK	Marc-Jose Handfield	appr	Marc-José Handfield

REV.	DATE	DESCRIPTION	PAGE	BY	CHK.	APPR.
A	2010-11-26	WE with Independent Front Suspension IFS, Production Vehicle #B-5003...		Rob.	M.J.H.	M.J.H.
	2011-06-01	WM with Independent Front Suspension IFS, Preliminary veh. WM #C-5070, Production Vehicle #C-5097...		Rob.	M.J.H.	M.J.H.
B	2011-05-18	#D140385 P6.0 REVISION: B (AHI REPLACED) #D140385 P7.0 REVISION: B (AHI REPLACED)	P6.0 & 6.1 P7.0 & 7.1	R.LAM.	M.J.H.	M.J.H.
C	2011-10-04	#D140385 P1.0 REVISION: B (UPDATE) Effectif #C-5234	P1.0 1.1@1.4	Rob.	M.J.H.	M.J.H.
D	2011-10-24	#D140385 P1 Revision C (NEW IFS 19 LBS) #D140385 P2 Revision B Production Vehicle WE #C-5133 Production Vehicle WM #C-5236	P1.0 1.1@1.4 P2.0 & 2.1	Rob.	M.J.H.	M.J.H.
E	2011-11-04	VOLVO ENGINE VERSION WITHOUT DRV VALVE Production vehicle WE : #C-5233	P.6 & 7 P6.1&7.1	Rob.	M.Pelletier	M.Pelletier
F	2012-02-07	#D140385 P1 Revision D (UPDATE)	P1.0 1.1@1.4	Rob.	M.J.H.	M.J.H.
G	2013-02-06	NEW #D140385SP1 #D-5454 WITH SPECIAL OPTION AIR HORN	SP1,SP1.1	J.Aubry	M.J.H.	M.J.H.

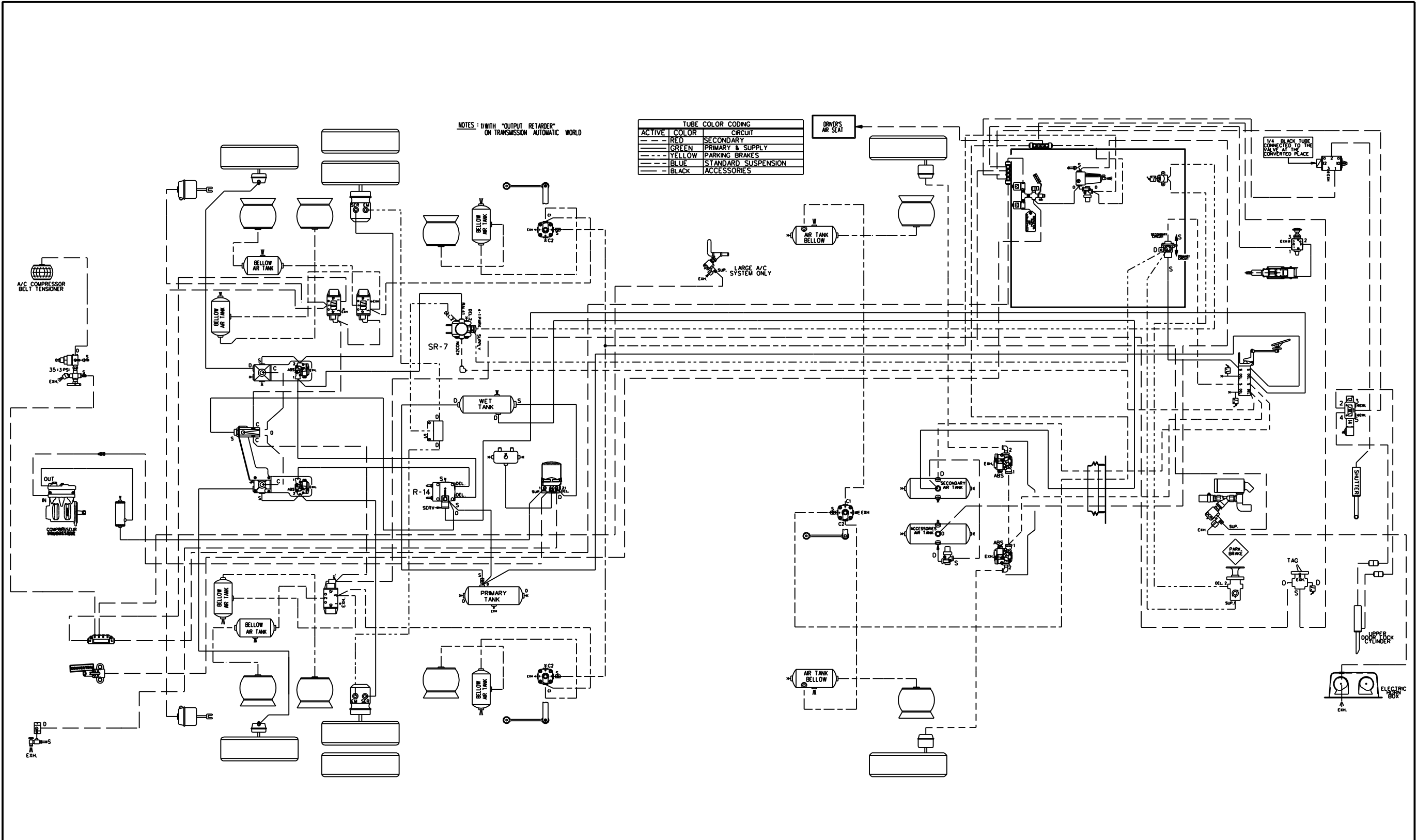

NOTES: WITH "OUTPUT RETARDER"
ON TRANSMISSION AUTOMATIC WORLD

ACTIVE	COLOR	CIRCUIT
---	RED	SECONDARY
---	GREEN	PRIMARY & SUPPLY
---	YELLOW	PARKING BRAKES
---	BLUE	STANDARD SUSPENSION
---	BLACK	ACCESSORIES

PREVOST®

DESCRIPTION: BUS SHELL WE
WITH FULL PNEUMATIC SYSTEM

REV.: A
DATE: 2010/11

PAGE: D140385 P1.1

NOTES: 1) WITH "OUTPUT RETARDER"
ON TRANSMISSION AUTOMATIC WORLD

ACTIVE	COLOR	CIRCUIT
---	RED	SECONDARY
---	GREEN	PRIMARY & SUPPLY
---	YELLOW	PARKING BRAKES
---	BLUE	STANDARD SUSPENSION
---	BLACK	ACCESSORIES

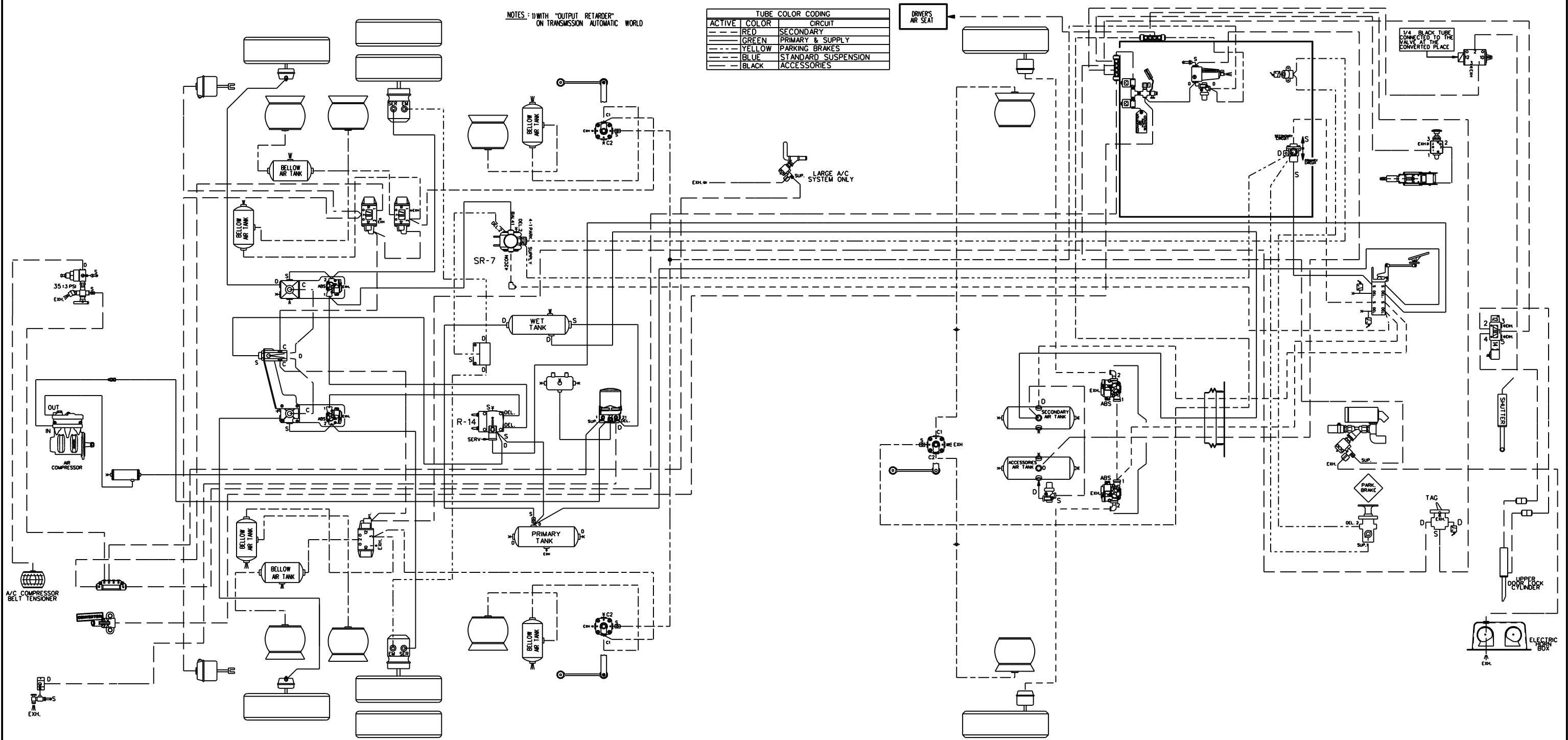

PREVOST®

DESCRIPTION:

BUS SHELL WE
WITH FULL PNEUMATIC SYSTEM

REV.:

D

PAGE:

D140385 P1.1

DATE:

2012/02

NOTES: 1) WITH "OUTPUT RETARDER"
ON TRANSMISSION AUTOMATIC WORLD

TUBE COLOR CODING		
ACTIVE	COLOR	CIRCUIT
---	BLACK	ACCESSORIES

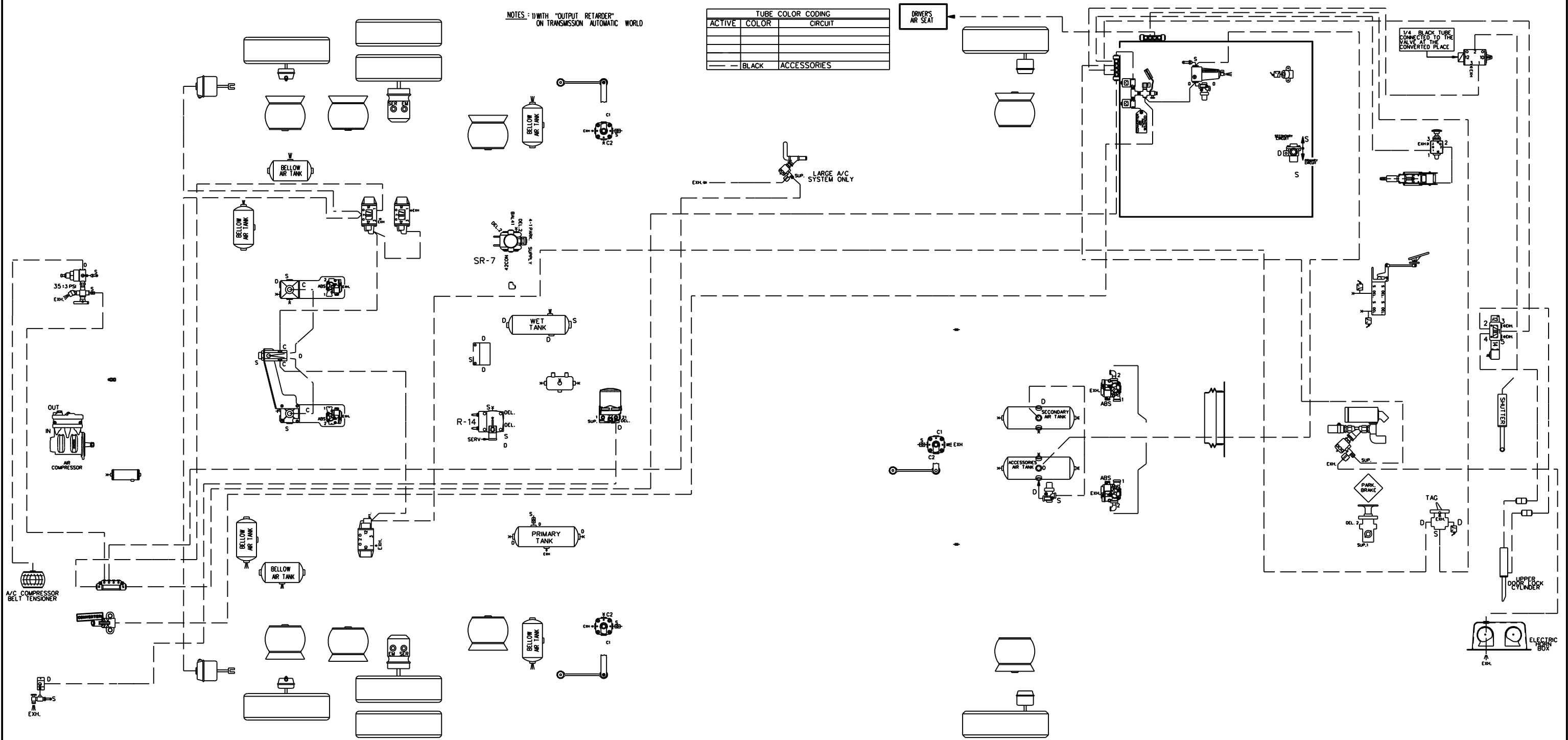

PREVOST

DESCRIPTION:

BUS SHELL WE
ACCESSORIES

REV.:

D

PAGE:

DATE:

2012/02

D140385 P1.2

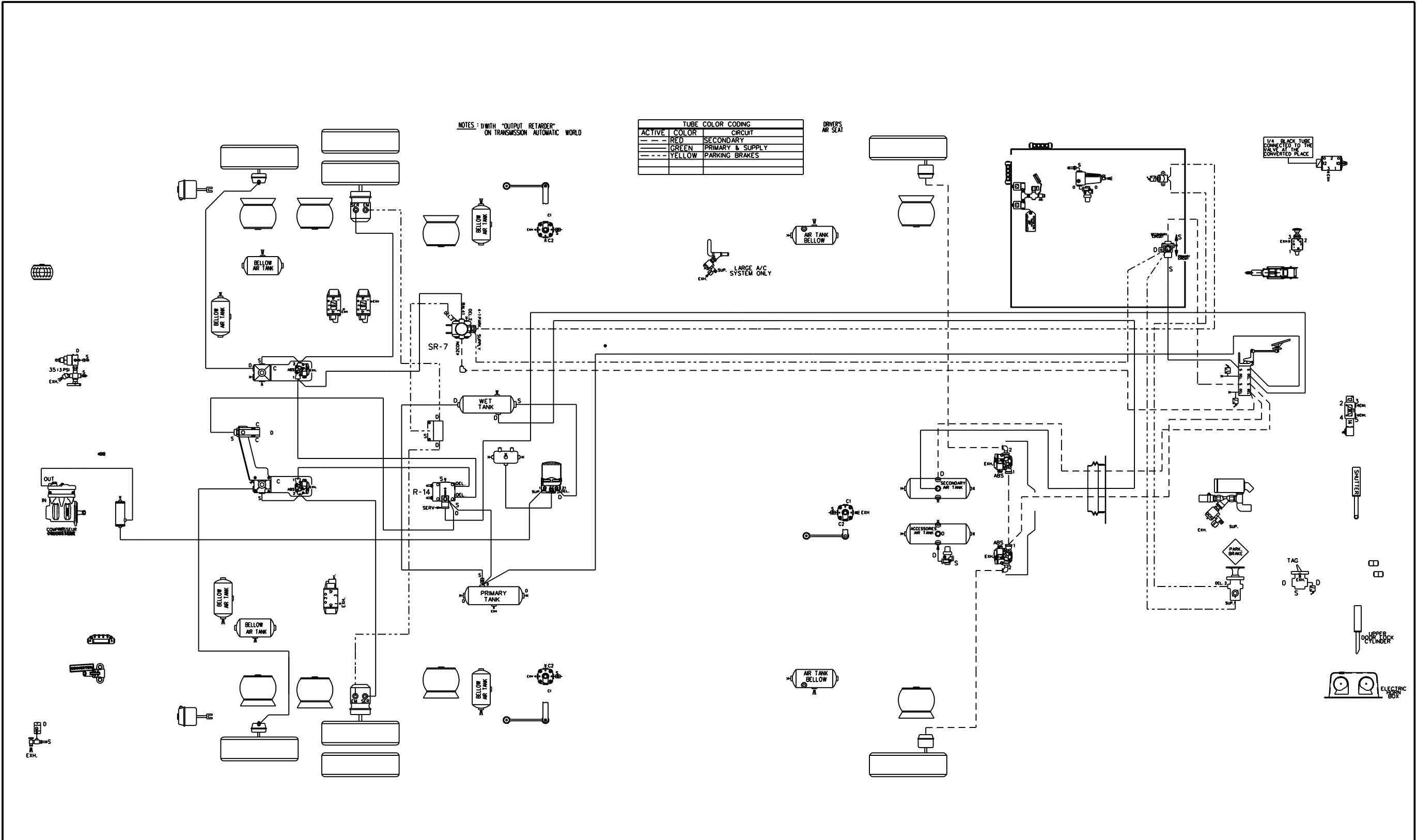

NOTES: 1) WITH "OUTPUT RETARDER"
ON TRANSMISSION AUTOMATIC WORLD

TUBE COLOR CODING		
ACTIVE	COLOR	CIRCUIT
---	RED	SECONDARY
---	GREEN	PRIMARY & SUPPLY
---	YELLOW	PARKING BRAKES

DRIVERS
AIR SEAT

LARGE A/C
SYSTEM ONLY

1/4 BLACK TUBE
CONNECTED TO THE
VALVE AT THE
CONVERTED PLACE

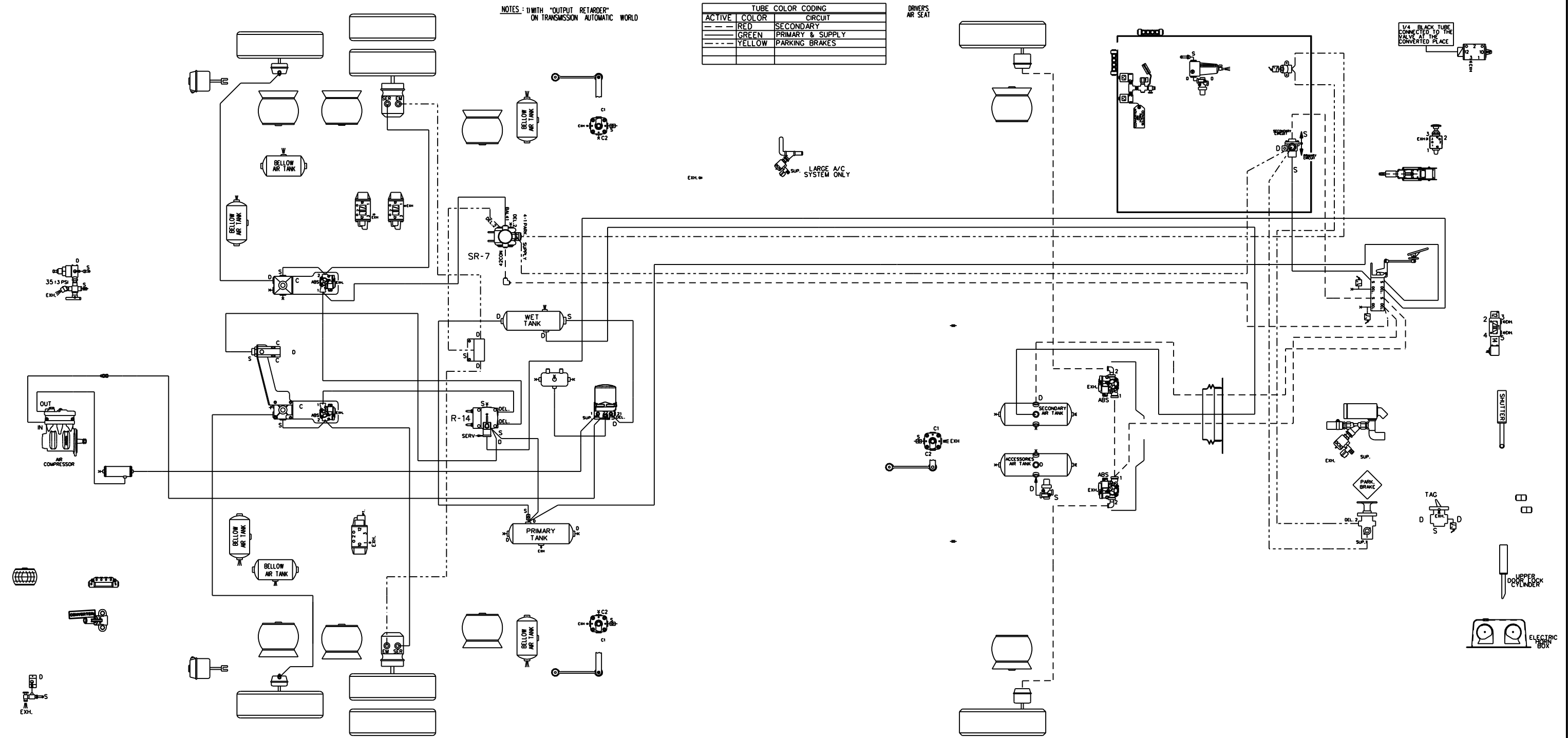

PREVOST

DESCRIPTION:
BUS SHELL WE
BRAKES SYSTEM

REV.: D
DATE: 2012/02

PAGE:
D140385 P1.3

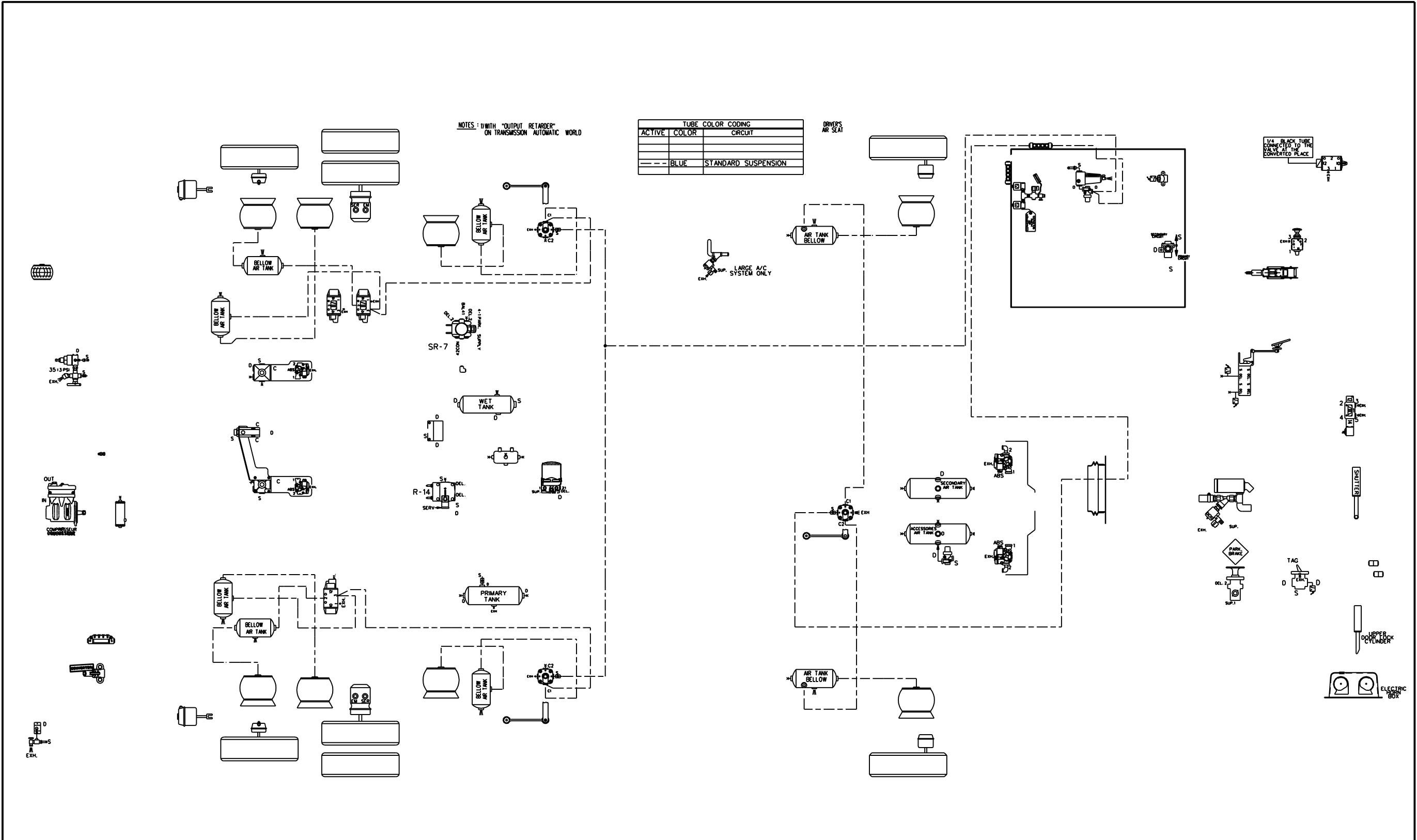

NOTES: 1) WITH "OUTPUT RETARDER" ON TRANSMISSION AUTOMATIC WORLD

TUBE COLOR CODING	
ACTIVE	CIRCUIT
---	BLUE
---	STANDARD SUSPENSION

DRIVERS AIR SEAT

LARGE A/C SYSTEM ONLY

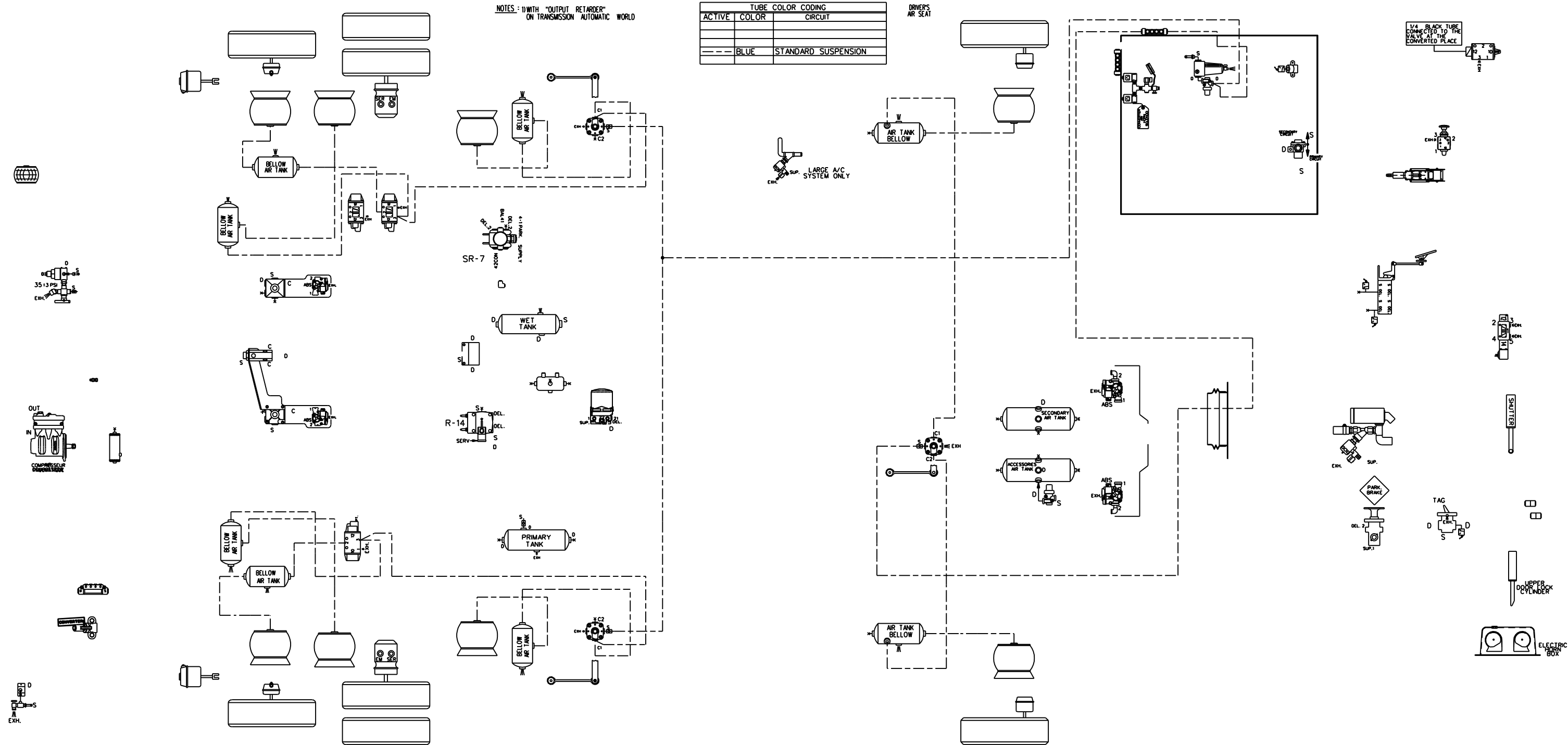

PREVOST

DESCRIPTION:

BUS SHELL WE
STANDARD SUSPENSION

REV.:

B

PAGE:

DATE:

2011/10

D140385 P1.4

NOTES: 1) WITH "OUTPUT RETARDER"
ON TRANSMISSION AUTOMATIC WORLD

TUBE COLOR CODING		
ACTIVE	COLOR	CIRCUIT
---	BLUE	STANDARD SUSPENSION

DRIVERS
AIR SEAT

LARGE A/C
SYSTEM ONLY

SR-7
4200N
A, 1/4" B
C, 1/2" D
SERV 1-19

R-14
DEL.
SERV
S
D

PRIMARY
TANK

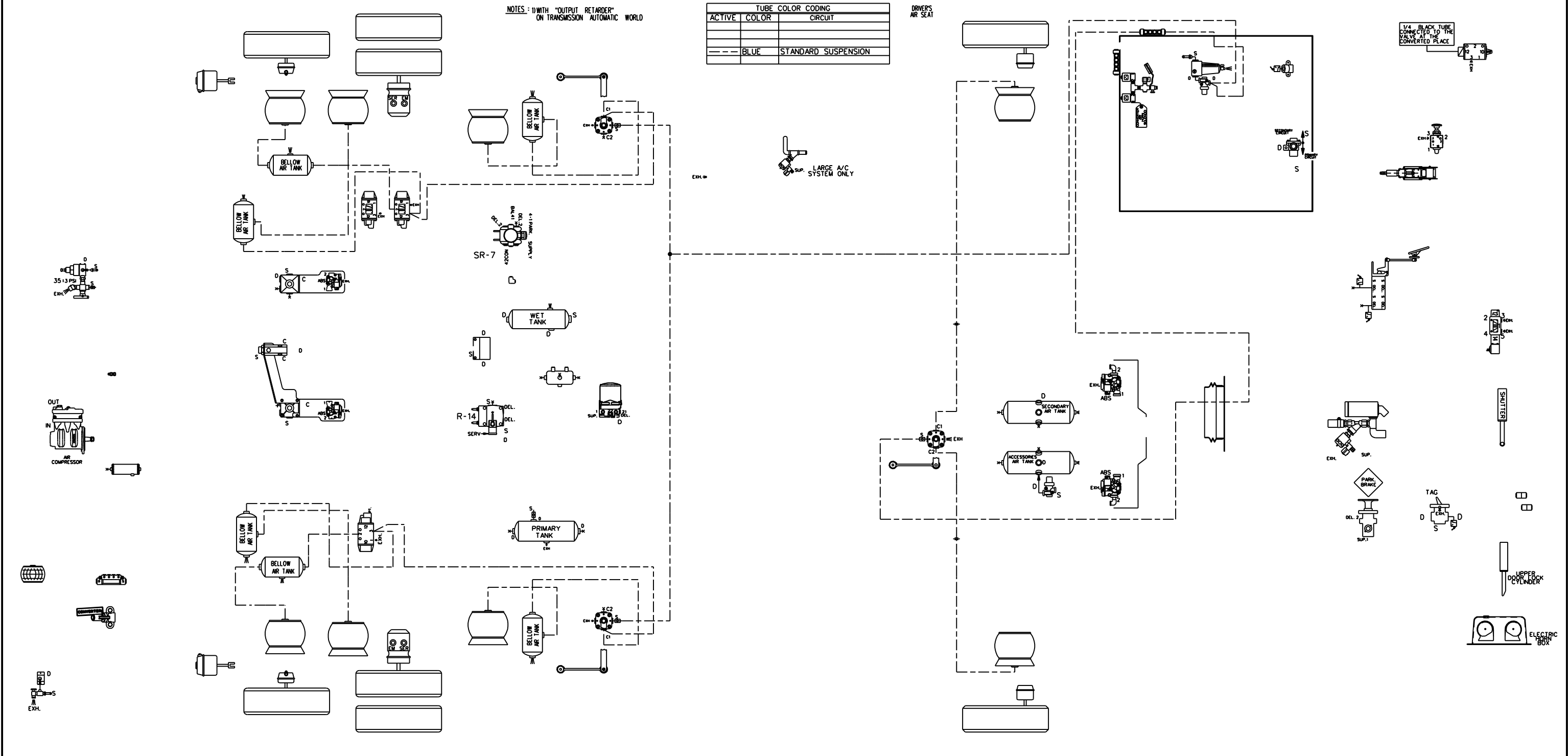

PREVOST®

DESCRIPTION:
BUS SHELL WE
STANDARD SUSPENSION

REV.: D
DATE: 2012/02

PAGE:
D140385 P1.4

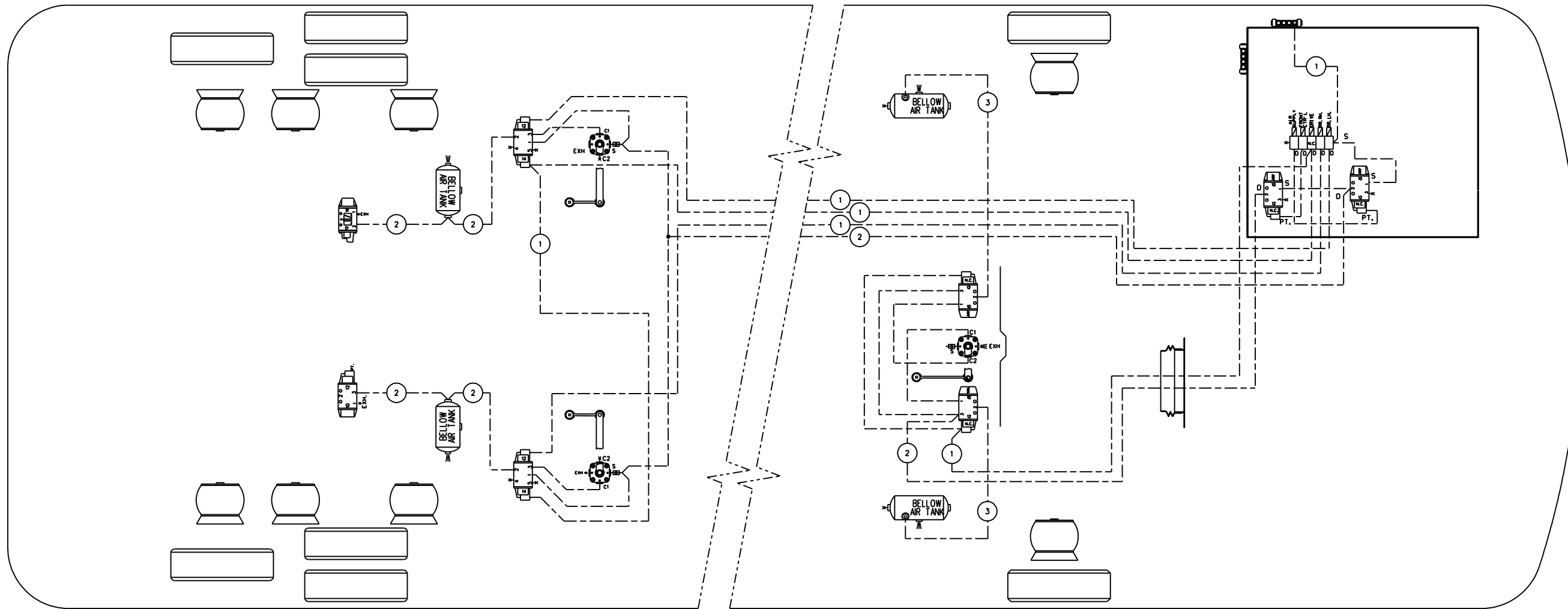

TUBE COLOR CODING	
ACTIVE COLOR	CIRCUIT
---	BLACK ACCESSORIES
---	BLUE STANDARD SUSPENSION

BALLOON	PIPE
*1	1/4" O.D. BLACK
*2	3/8" O.D. BLUE
*3	1/2" O.D. BLUE

PREVOST®

DESCRIPTION:
 BUS SHELL WE
 WITH OPTION LEVEL LOW

REV.: A
 DATE: 2010/11

PAGE:
 D140385 P2.1

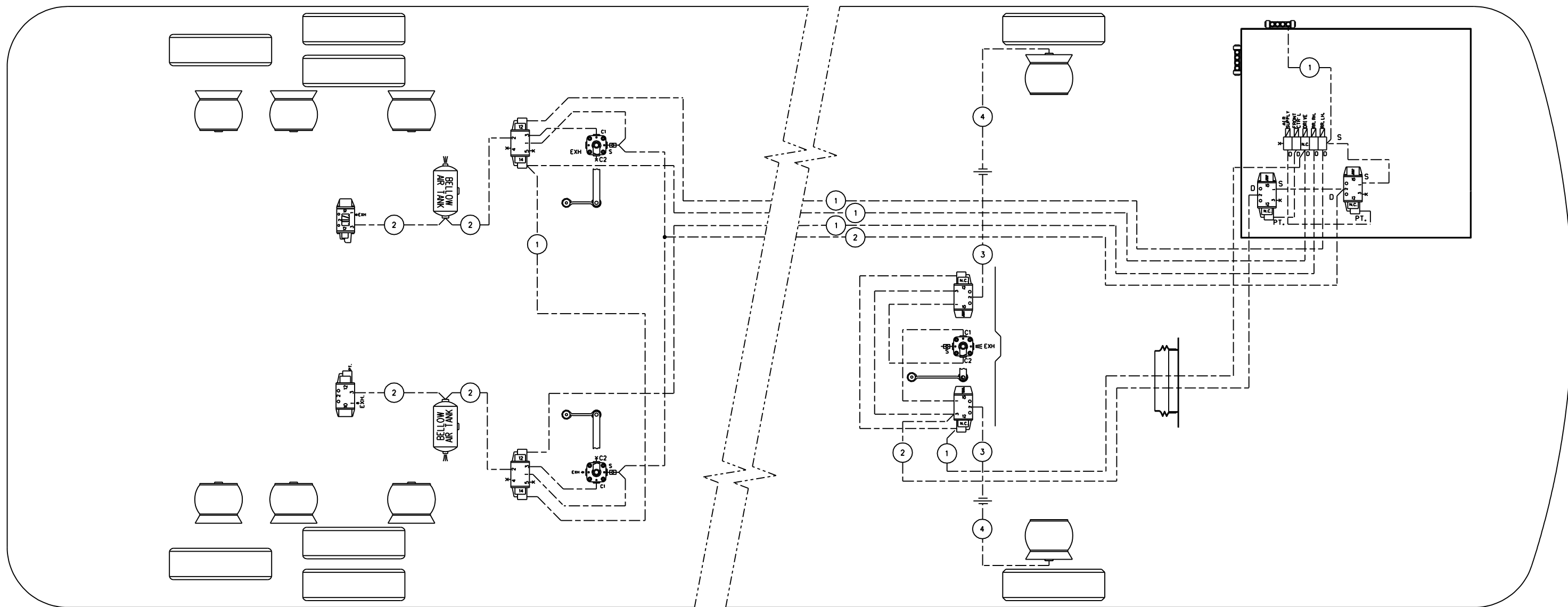

TUBE COLOR CODING	
ACTIVE	COLOR
---	BLACK
---	BLUE

CIRCUIT	
---	ACCESSORIES
---	STANDARD SUSPENSION

BALLOON	PIPE
*1	1/4" O.D. BLACK
*2	3/8" O.D. BLUE
*3	1/2" O.D. BLUE
*4	HOSE ASSY (*8)

PREVOST®

DESCRIPTION:

BUS SHELL WE
WITH OPTION LEVEL LOW

REV.:

B

PAGE:

DATE:

2011/10

D140385 P2.1

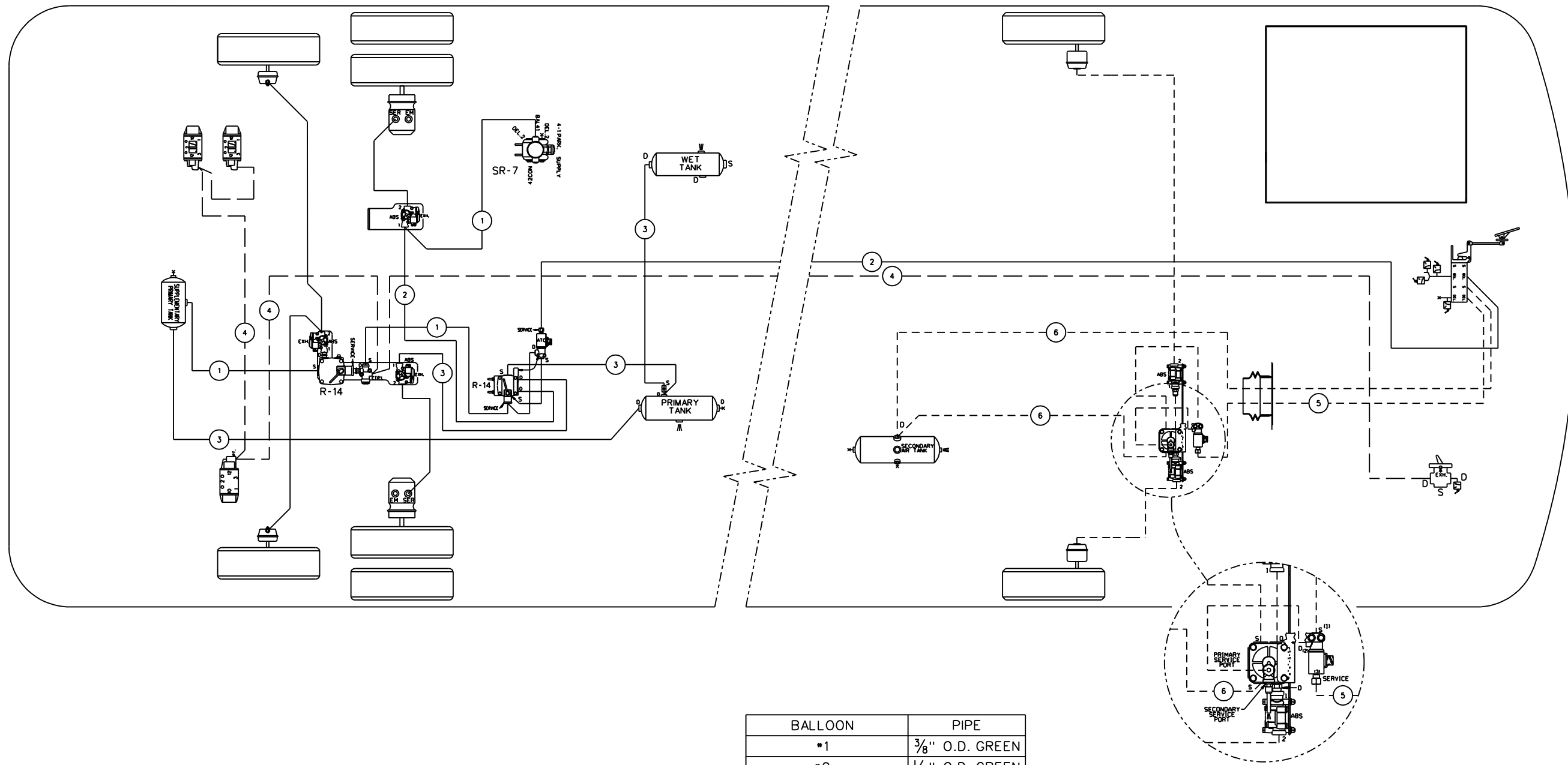

BALLOON	PIPE
*1	3/8" O.D. GREEN
*2	1/2" O.D. GREEN
*3	5/8" O.D. GREEN
*4	1/4" O.D. BLACK
*5	1/2" O.D. RED
*6	5/8" O.D. RED

TUBE COLOR CODING	
ACTIVE COLOR	CIRCUIT
— GREEN	PRIMARY & SUPPLY
— BLACK	ACCESSORIES
--- RED	SECONDARY

PREVOST®

DESCRIPTION:

WE BUS SHELL
WITH OPTION ESP BRAKE SYSTEM

REV.:

A

PAGE:

DATE:

2010/11

D140385 P3.1

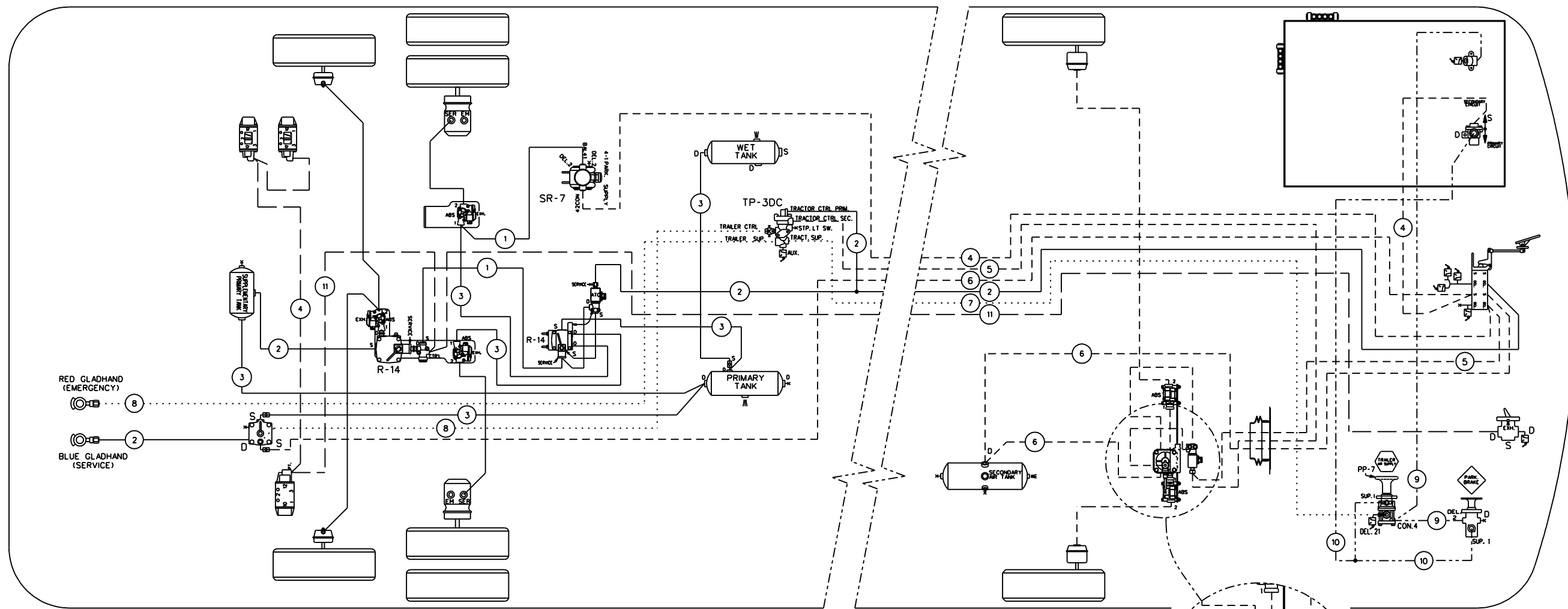

RED GLADHAND
(EMERGENCY)

BLUE GLADHAND
(SERVICE)

BALLOON	PIPE
•1	3/8" O.D. GREEN
•2	1/2" O.D. GREEN
•3	3/8" O.D. GREEN
•4	3/8" O.D. RED
•5	1/2" O.D. RED
•6	3/8" O.D. RED
•7	3/8" O.D. BROWN
•8	1/2" O.D. BROWN
•9	1/4" O.D. YELLOW
•10	3/8" O.D. YELLOW
•11	1/4" O.D. BLACK
•12	3/8" O.D. BLACK

TUBE COLOR CODING	
ACTIVE COLOR	CIRCUIT
---	RED SECONDARY
---	GREEN PRIMARY & SUPPLY
---	YELLOW PARKING BRAKE
---	BROWN TRAILER
---	BLACK ACCESSORIES

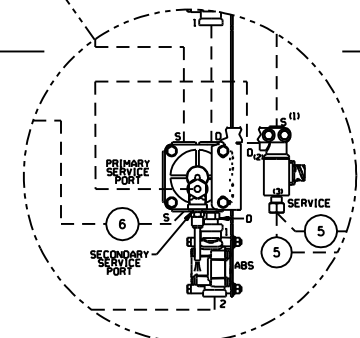

PREVOST®

DESCRIPTION:

BUS SHELL WE WITH OPTION TRAILER HITCH AIR BRAKE
WITH ESP BRAKE SYSTEM

REV.:

A

PAGE:

DATE:

2010/11

D140385 P4.1

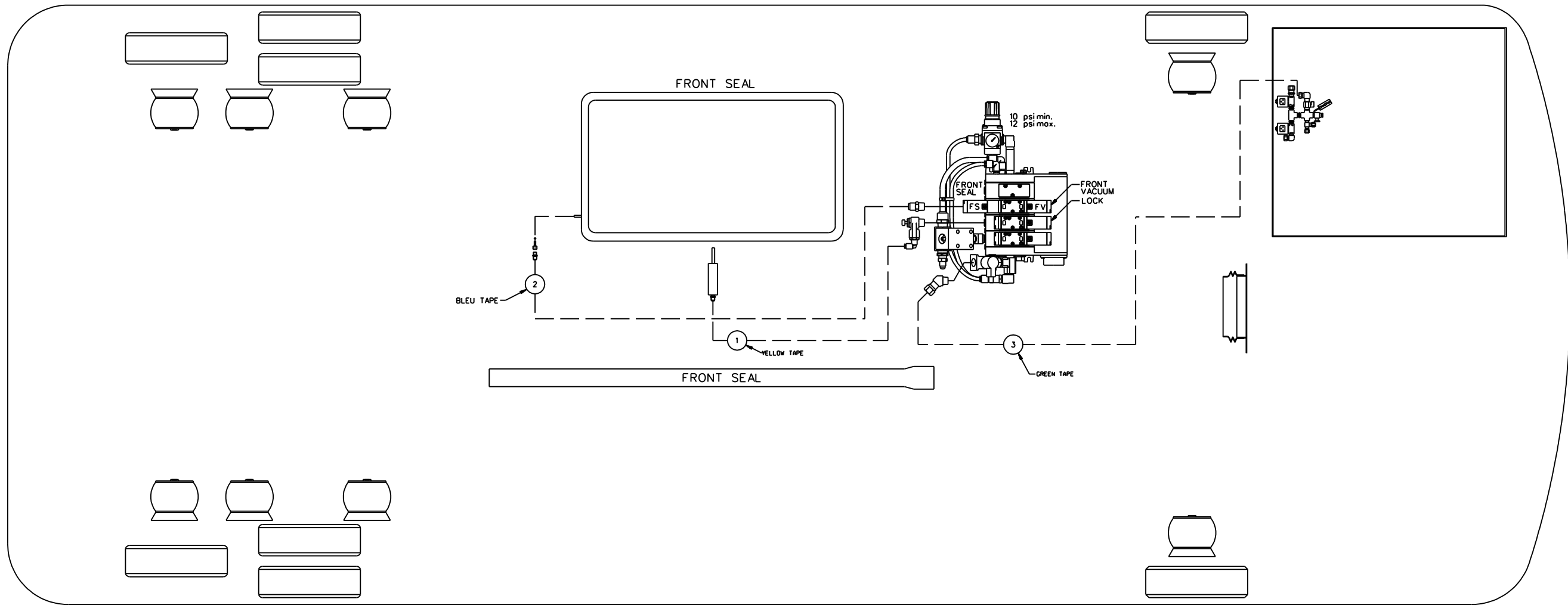

BALLOON	PIPE
*1	1/8" O.D. BLACK
*2	3/8" O.D. BLACK
*3	1/2" O.D. BLACK

TUBE COLOR CODING		
LINE TYPE	COLOR	CIRCUIT
---	BLACK	ACCESSOIRES

PREVOST®

DESCRIPTION:

BUS SHELL WE WITH OPTION SINGLE SLIDE-OUT

REV.:

A

PAGE:

DATE:

2010/11

D140385 P5.1

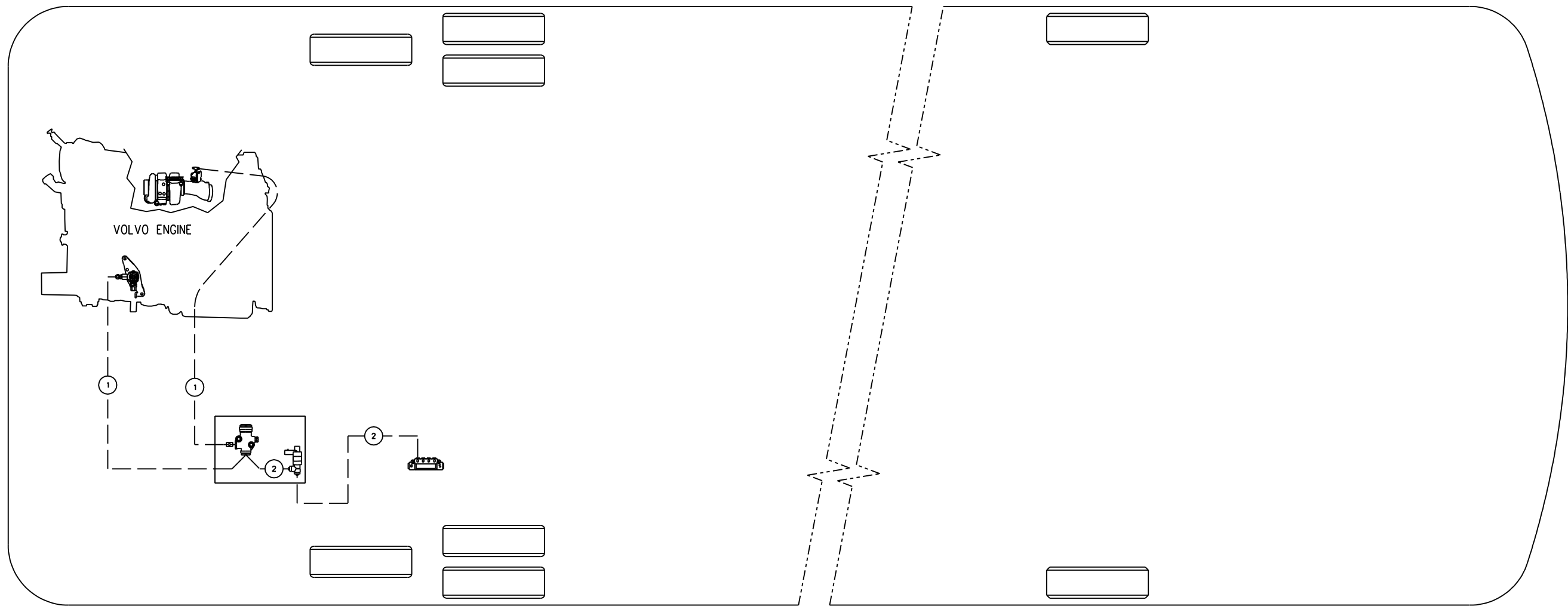

TUBE COLOR CODING		
ACTIVE	COLOR	CIRCUIT
—	BLACK	ACCESSORIES

BALLOON	PIPE
*1	HOSE ASS'Y
*2	1/4" O.D. BLACK

PREVOST®

DESCRIPTION:

WE BUS SHELL
WITH OPTION WITHOUT OUTPUT RETARDER ON WORLD
TRANSMISSION

REV.:

A

PAGE:

DATE:

2010/11

D140385 P6.1

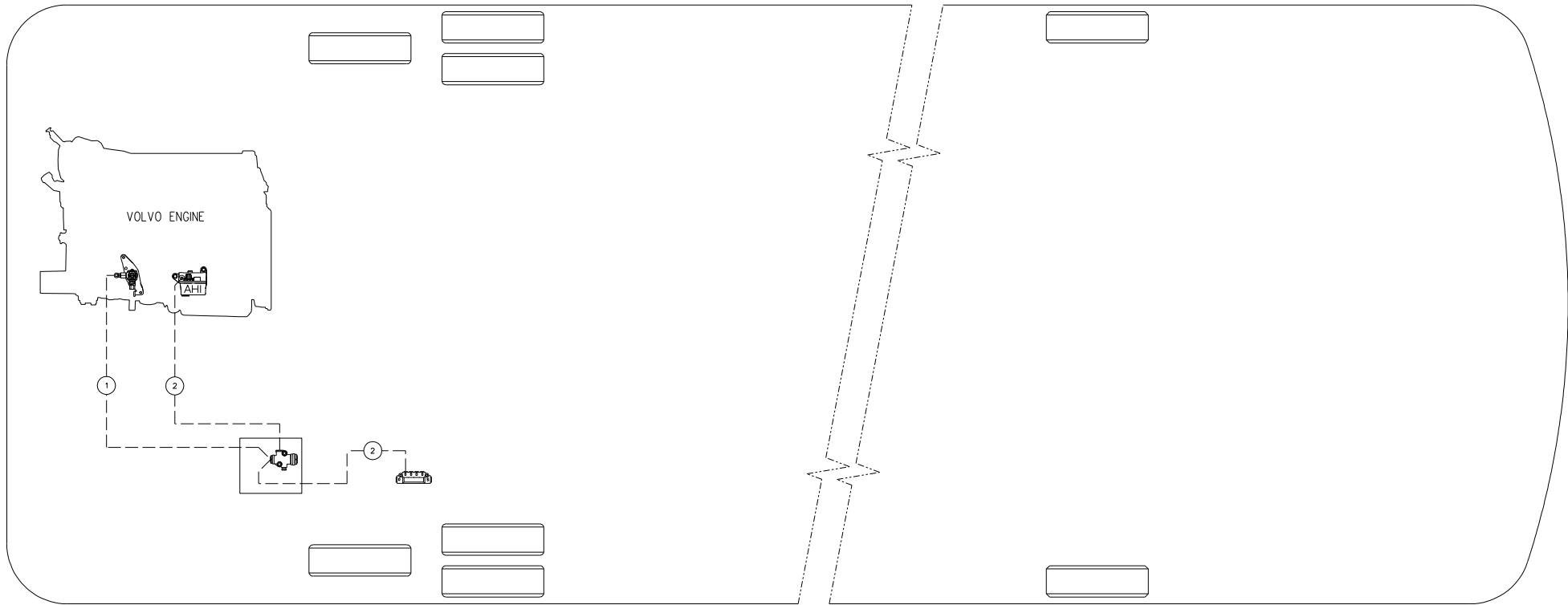

TUBE COLOR CODING		
ACTIVE	COLOR	CIRCUIT
---	BLACK	ACCESSORIES

BALLOON	PIPE
*1	HOSE ASS'Y
*2	1/4" O.D. BLACK

PREVOST®

DESCRIPTION:

WE BUS SHELL
WITH OPTION WITHOUT OUTPUT RETARDER ON WORLD
TRANSMISSION

REV.:

B

PAGE:

DATE:

2011/02

D140385 P6.1

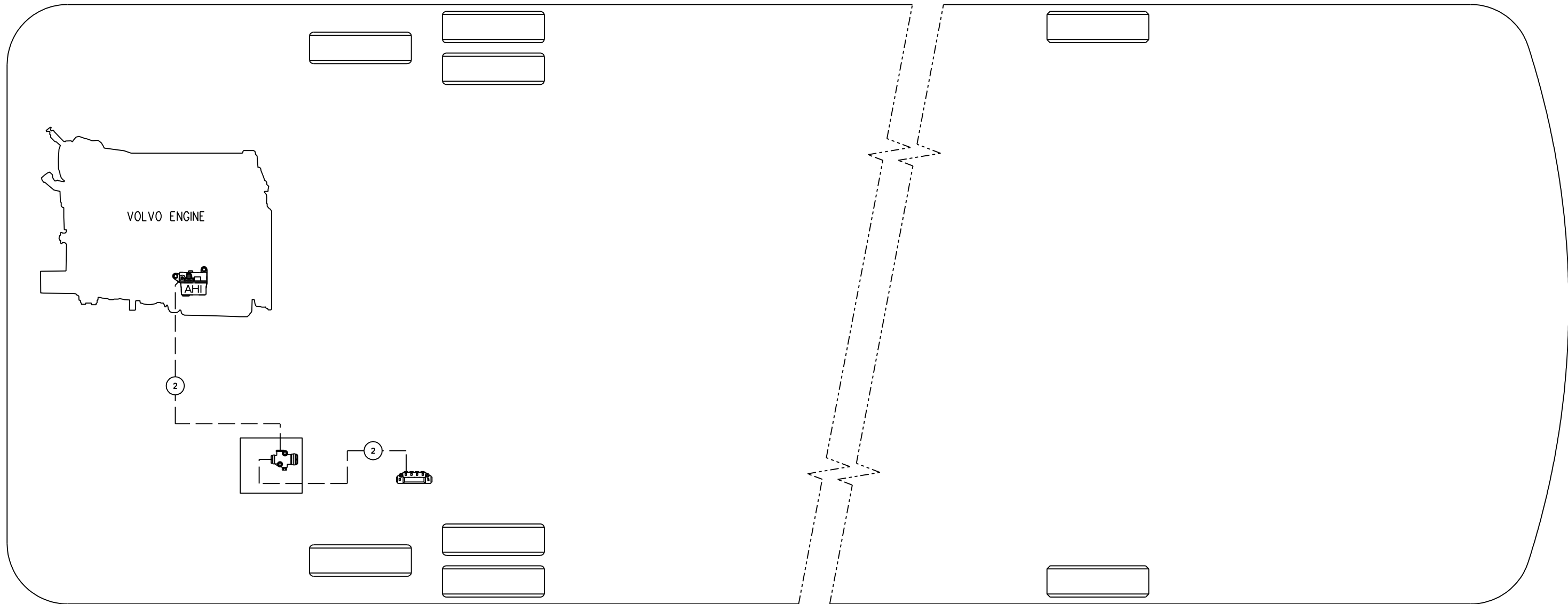

TUBE COLOR CODING		
ACTIVE	COLOR	CIRCUIT
---	BLACK	ACCESSORIES

BALLOON	PIPE
*1	---
*2	1/4" O.D. BLACK

PREVOST®

DESCRIPTION:

WE BUS SHELL
WITH OPTION WITHOUT OUTPUT RETARDER ON WORLD
TRANSMISSION

REV.:

C

PAGE:

D140385 P6.1

DATE:

2011/12

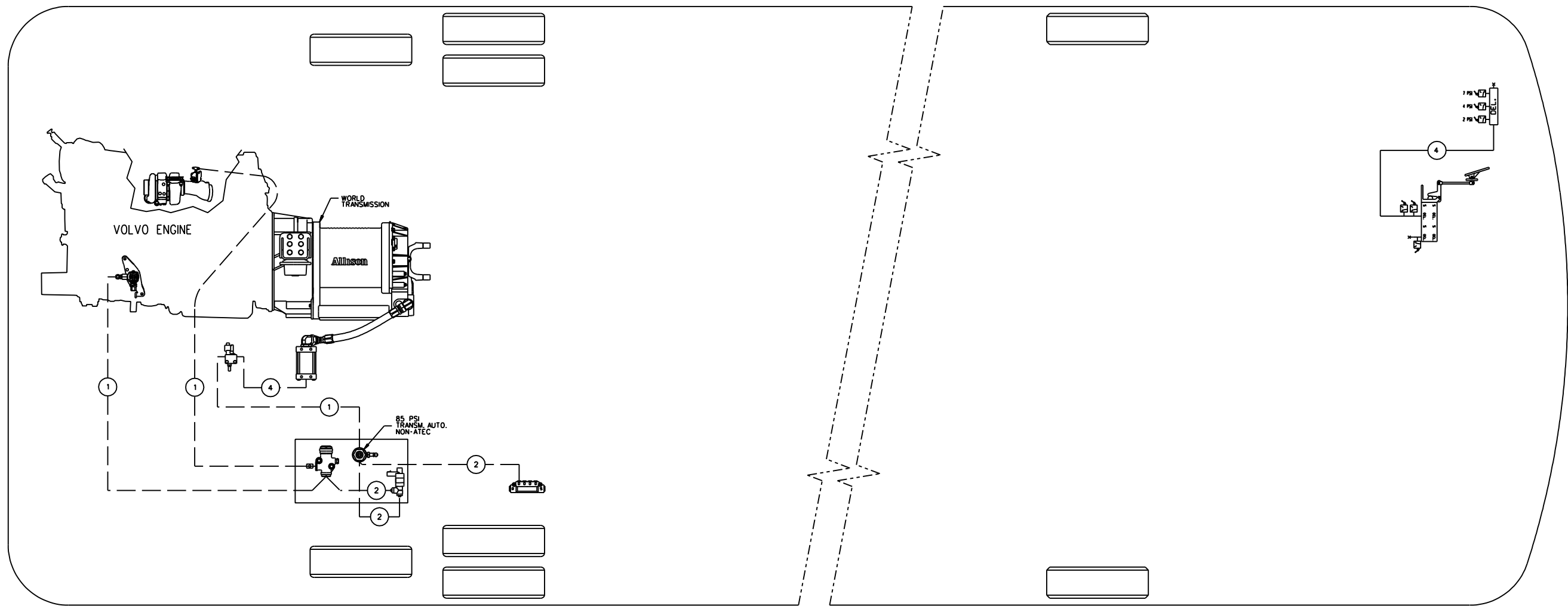

TUBE COLOR CODING		
ACTIVE	COLOR	CIRCUIT
---	BLACK	ACCESSORIES
---	GREEN	PRIMARY & SUPPLY

BALLOON	PIPE
*1	HOSE ASS'Y
*2	1/4" O.D. BLACK
*3	3/8" O.D. BLACK
*4	3/8" O.D. GREEN

PREVOST®

DESCRIPTION:

WE BUS SHELL WITH OPTION OUTPUT RETARDER ON
WORLD TRANSMISSION

REV.:

A

PAGE:

DATE:

2010/11

D140385 P7.1

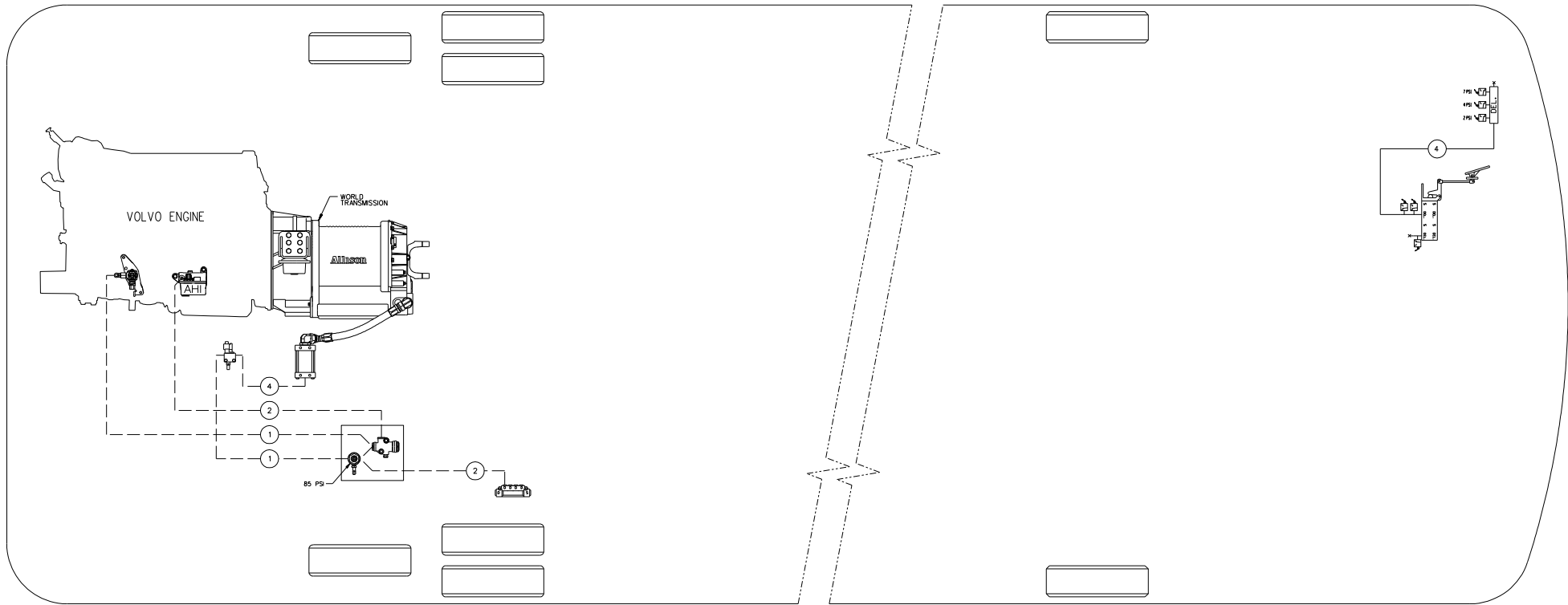

TUBE COLOR CODING		
ACTIVE	COLOR	CIRCUIT
---	BLACK	ACCESSORIES
---	GREEN	PRIMARY & SUPPLY

BALLOON	PIPE
*1	HOSE ASS'Y
*2	1/4" O.D. BLACK
*3	3/8" O.D. BLACK
*4	3/8" O.D. GREEN

PREVOST®

DESCRIPTION:

WE BUS SHELL WITH OPTION OUTPUT RETARDER ON
WORLD TRANSMISSION

REV.:

B

DATE:

2011/02

PAGE:

D140385 P7.1

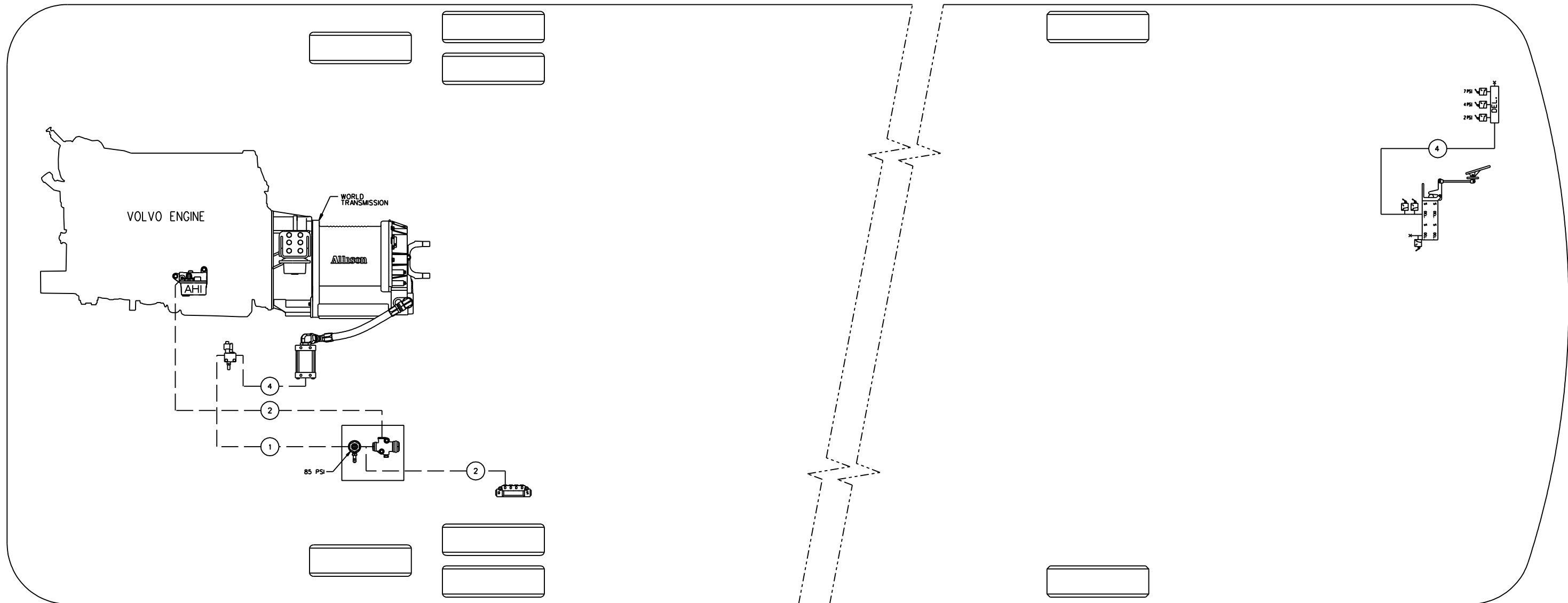

TUBE COLOR CODING		
ACTIVE	COLOR	CIRCUIT
---	BLACK	ACCESSORIES
---	GREEN	PRIMARY & SUPPLY

BALLOON	PIPE
*1	HOSE ASS'Y
*2	1/4" O.D. BLACK
*3	3/8" O.D. BLACK
*4	3/8" O.D. GREEN

PREVOST®

DESCRIPTION:

WE BUS SHELL WITH OPTION OUTPUT RETARDER ON
WORLD TRANSMISSION

REV.:

C

PAGE:

DATE:

2011/12

D140385 P7.1