

## Pneumatic diagram

### *PNEUMATIC DIAGRAMS W0-WE BUS SHELL WITH INDEPENDENT SUSP.*

NO:	<b>D140342 P0</b>	REVISION :	<b>i</b>
-----	-------------------	------------	----------

EFF. OC#	2006012	PRIOR TO OC#	2007131	DR.	Y. Laine	date	2010-04-28
EFF. VEH#	#7-9096	PRIOR TO VEH#	#B-9954	CHK	Marc-Jose Handfield	Appr	Marc-José Handfield

REV.	DATE	DESCRIPTION	PAGE	BY	CHK.	APPR.
A	2006-06-19 2006-10-15	#7-9010 WE PRELIMINARY VEHICLE #7-9096 PRODUCTION VEHICLE  NOTE : ABS 6 BASIC WITH AIR BRAKE ON TRAILER HITCH , NOT AVAILABLE.				
B	2006-10-19	#D140342 AIR BRAKE ON TRAILER HITCH OPTION	2	Rob.	M.J.H.	M.J.H.
C	2007-02-27	#8-9187 WE PRELIMINARY VEHICLE, WITH ESP ABS 6 (ELECTRONIC STABILITY PROGRAM)				
	2007-06-01 2007-06-01	D140342 P1.0 Revision :B , ABS 6 BASIC D140342 P2.0 New Version ABS 6 ADVANCED W/TRAILER	1 2	Rob. Rob.	M.J.H. M.J.H.	M.J.H. M.J.H.
	2007-06-01 2007-06-01	D140342 P3.0 Revision :B , LEVEL LOW SYSTEM D140342 P4.0 New Version ABS 6 ADVANCED	3 4	Rob. Rob.	M.J.H. M.J.H.	M.J.H. M.J.H.
D	2008-04-14	D140342 P2.0 Revision : D (Update) D140342 P5.0 Revision : B (Update)	P2 &2.1 P5 & 5.1	Rob. Rob.	M.J.H. M.J.H.	M.J.H. M.J.H.
E	2008-06-27	D13 VOLVO ENGINE, ADD AIR CLEANER INJECTOR D140342 P8 & P9 NEW PAGE, RETROFIT # R479	P8 &P8.1 P9 &P9.1	Y.L. Y.L.	M.J.H. M.J.H.	M.J.H. M.J.H.
F	2008-06-30	D140342 P1 Rev.D NEW AIR TANK ASSY FOR DIFFERENTIAL AIR BELLOWS SUSPENSION	P1 &P1.1	Rob.	M.J.H.	M.J.H.

# Pneumatic diagram

## *PNEUMATIC DIAGRAMS W0-WE BUS SHELL WITH INDEPENDENT SUSP.*

REV.	DATE	DESCRIPTION	PAGE	BY	CHK.	APPR.
<b>G</b>	2009-01-16	D140342 P1 Revision : D (Update)	P1 & P1.1	Y.L.	M.J.H.	M.J.H.
		D140342 P2 Revision : E ( Update ) OC #2008107	P2 & P2.1	Rob.	M.J.H.	M.J.H.
		D140342 P6 VOLVO ENGINE PRELIMINARY #9-9596 , EFF.# 9-9682...	P6 & 6.1	Rob.	M.J.H.	M.J.H.
		D140342 P7 NEW PAGE , DETROIT ENGINE ALLISON W/RETARDER	P7 & 7.1	Rob.	M.J.H.	M.J.H.
<b>H</b>	2010-04-20	VOLVO ENGINE, O.C. #2009088 , RV-3 VALVE SOLENOID ASSY	P7 & P7.1	Y.L.	M.J.H.	M.J.H.
		D140342 P7,P8,P9 Revision : B	P8 & P8.1	Y.L.	M.J.H.	M.J.H.
			P9 & P9.1	Y.L.	M.J.H.	M.J.H.
<b>i</b>	2010-04-28	NEW TAG AXLE, O.C. #2007131 (Preliminary vehicle : #A-9902)	P1 & P1.1	Y.L.	M.J.H.	M.J.H.
			P2 & P2.1	Y.L.	M.J.H.	M.J.H.
			P4 & P4.1	Y.L.	M.J.H.	M.J.H.
			P5 & P5.1	Y.L.	M.J.H.	M.J.H.
			P6 & P6.1	Y.L.	M.J.H.	M.J.H.

# Pneumatic diagram

## *PNEUMATIC DIAGRAMS W0-WE BUS SHELL WITH INDEPENDENT SUSP.*

PRODUCTION NUMBER	REV	EFF. VEH.	ECN	S.A.V. NUMBER	REV	DESCRIPTION
D140342P1.0	A	#7-9096	2006012	D140342P1.1	<b>E</b>	FULL PNEUMATIC SYSTEM ABS 6 BASIC SYSTEM
	B	#8-9279	2006038 2005002	D140342P1.2	<b>E</b>	ACCESSORIES
	C	#8-9436	2007108	D140342P1.3	<b>E</b>	BRAKES SYSTEM
	D	#9-9702	UPDATE	D140342P1.4	<b>E</b>	SUSPENSION
	<b>E</b>	<b>#B-9954</b>	<b>2007131</b>			
D140342P2.0	A	#7-9096	2006012	D140342P2.1	A	ESP ABS 6 ADVANCED WITH AIR BRAKE ON TRAILER HITCH
	B				B	
	C	#8-9279	2006038 2005002		C	
	D	-----	UPDATE		D	
	E	#9-9702	2008107		E	
	<b>F</b>	<b>#B-9954</b>	<b>2007131</b>		<b>F</b>	
D140342P3.0	<b>A</b>	<b>#7-9096</b>	<b>2006012</b>	D140342P3.1	<b>A</b>	FRONT SINGLE SLIDE OUT OPTION (WE ENTERTAINER ONLY)
D140342P4.0	A	#7-9096	2006012	D140342P4.1	A	LEVEL LOW SUSPENSION OPTION
	B	#8-9279	2006038 2005002		B	
	C	#8-9436	2007108		C	
	<b>D</b>	<b>#B-9954</b>	<b>2007131</b>		<b>D</b>	
D140342P5.0	A	#8-9279	2006038 2005002	D140342P5.1	A	ESP ABS 6 ADVANCED
	B	-----	UPDATE		B	
	<b>C</b>	<b>#B-9954</b>	<b>2007131</b>		<b>C</b>	
D140342P6.0	<b>A</b>	<b>#9-9682</b>	<b>2008048</b>	D140342P6.1	<b>A</b>	D13 VOLVO ENGINE WITH HALDEX AIR DRYER
	<b>B</b>	<b>#B-9954</b>	<b>2007131</b>		<b>B</b>	
D140342P7.0	<b>A</b>	<b>#8-9279</b>	<b>2005002</b>	D140342P7.1	<b>A</b>	DETROIT ENGINE WITH RETARDER ALLISON TRANSM.
	<b>B</b>	<b>#A-9952</b>	<b>2009088</b>		<b>B</b>	
D140342P8.0	<b>A</b>	<b>#9-9682</b>	<b>2008048</b>	D140342P8.1	<b>A</b>	D13 VOLVO ENGINE WITH RETARDER ALLISON TRANSM.
	<b>B</b>	<b>#A-9952</b>	<b>2009088</b>		<b>B</b>	

# Pneumatic diagram

*PNEUMATIC DIAGRAMS W0-WE BUS SHELL WITH INDEPENDENT SUSP.*

PRODUCTION NUMBER	REV	EFF. VEH.	ECN	S.A.V. NUMBER	REV	DESCRIPTION
D140342P9.0	A B	#9-9682 #A-9952	2008048 2009088	D140342P9.1	A B	D13 VOLVO ENGINE WITHOUT RETARDER ALLISON TRANSM.
D140342SP1.0	A	#8-9279	2006012	D140342SP1.1	A	DIFFERENTIAL AIR LOCK OPTION

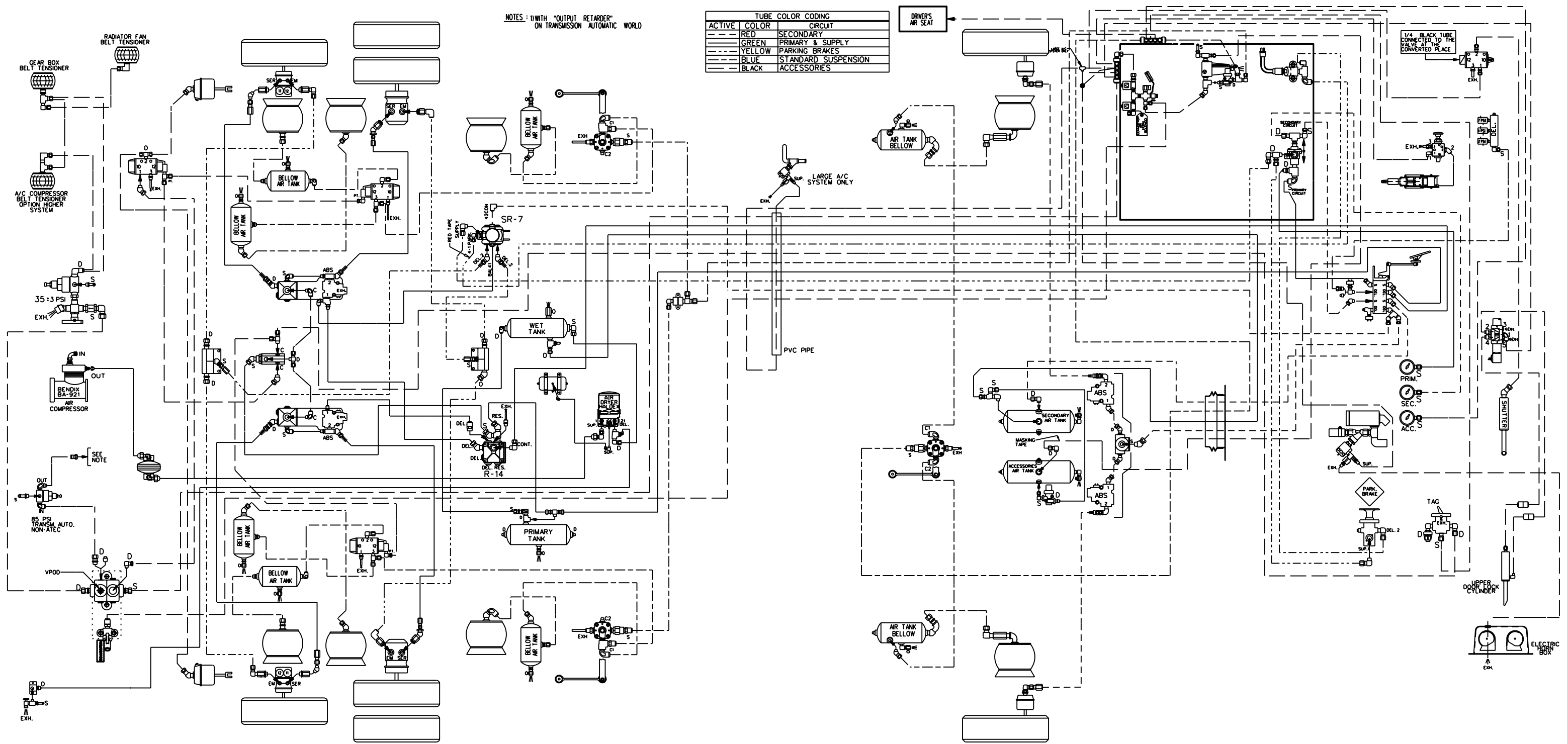

ACTIVE	COLOR	SECONDARY	CIRCUIT
---	RED	---	SECONDARY
---	GREEN	---	PRIMARY & SUPPLY
---	YELLOW	---	PARKING BRAKES
---	BLUE	---	STANDARD SUSPENSION
---	BLACK	---	ACCESSORIES

NOTES : 1) WITH "OUTPUT RETARDER"  
ON TRANSMISSION AUTOMATIC WORLD

**PREVOST**®

DESCRIPTION:  
BUS SHELL WE & WO 2006  
WITH FULL PNEUMATIC SYSTEM

EFF. W/ VEH : #7-9096  
Preliminary #7-9010  
DATE: 2006/09 REV.: A

PAGE:  
D140342 P1.1

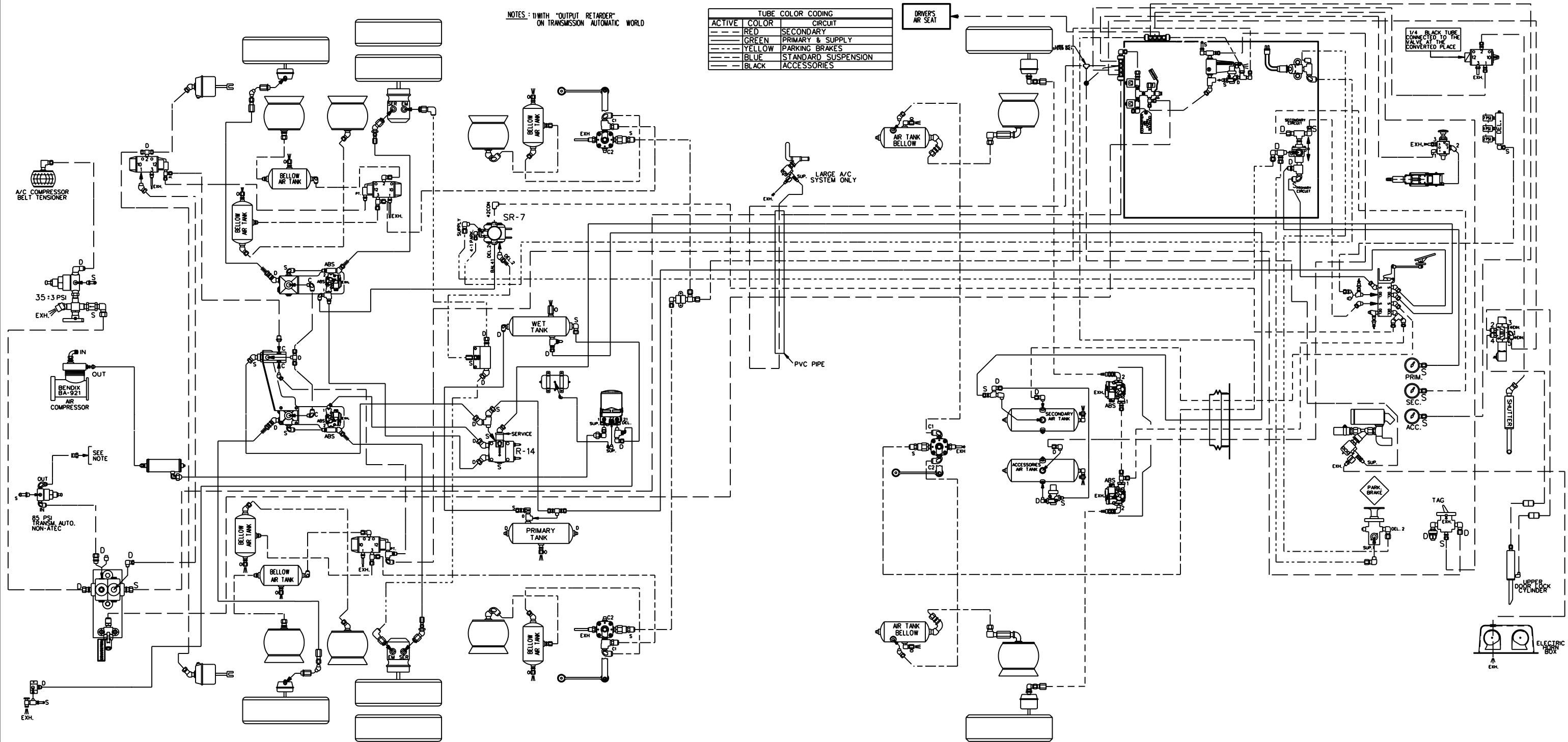

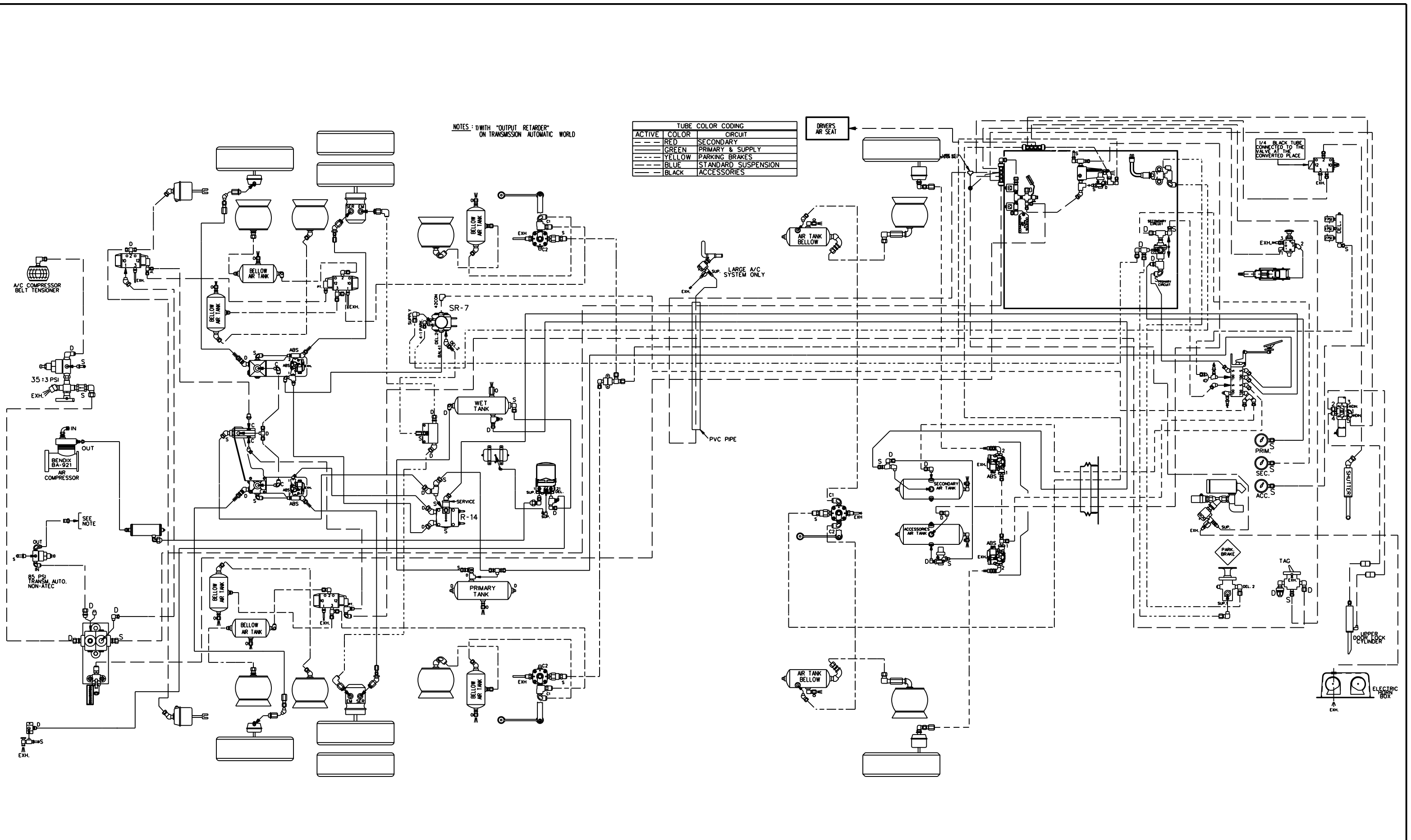

ACTIVE COLOR	SECONDARY CIRCUIT
---	---
---	---
---	---
---	---
---	---
---	---

NOTES : 1) WITH "OUTPUT RETARDER"  
ON TRANSMISSION AUTOMATIC WORLD

**PREVOST**

DESCRIPTION: BUS SHELL WE & WO 2006 WITH FULL PNEUMATIC SYSTEM

EFF. W/ VEH : #8-9436  
DATE: 2008/04 REV.: C

PAGE: D140342 P1.1

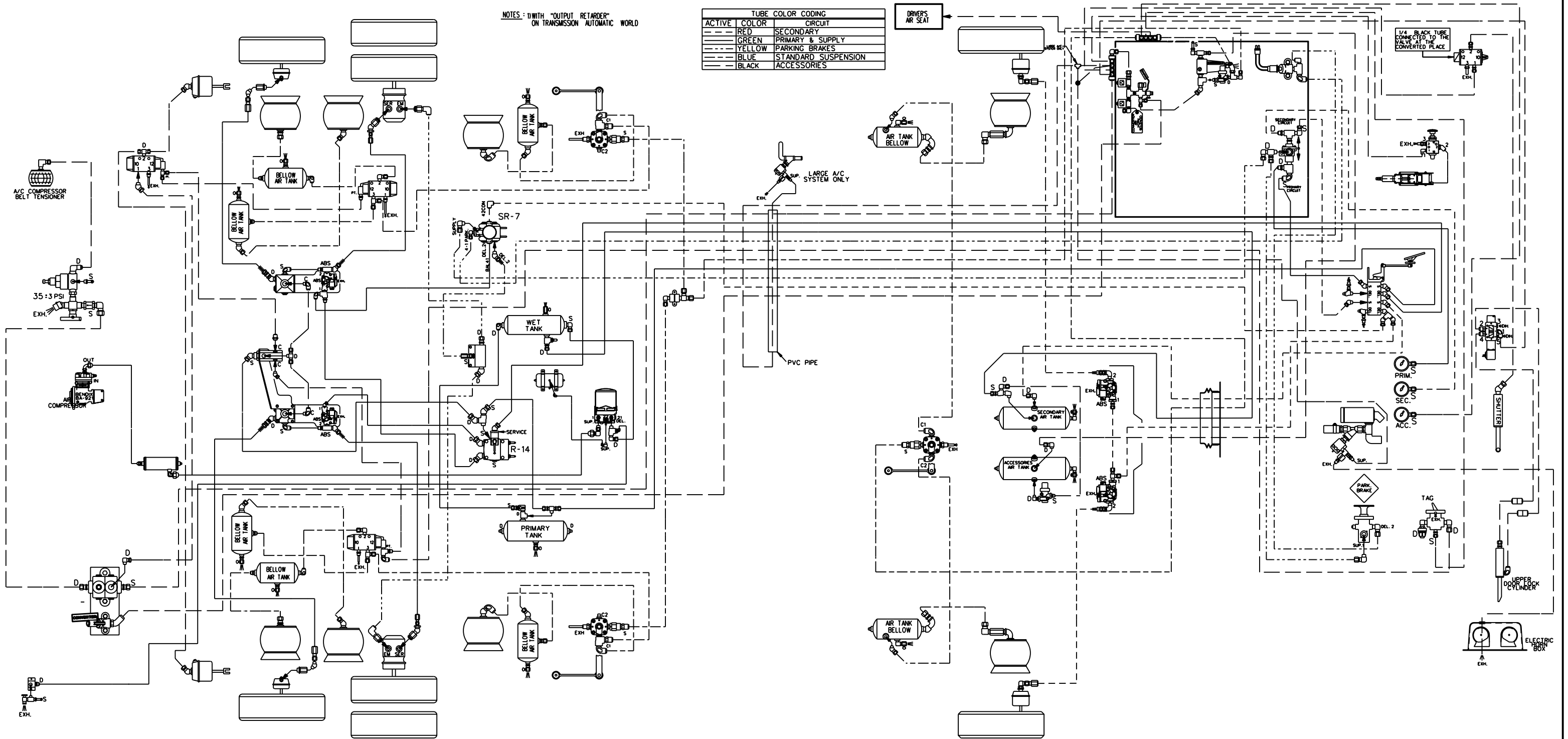

**PREVOST®**

DESCRIPTION:

BUS SHELL WE 2006  
WITH FULL PNEUMATIC SYSTEM

EFF. W/ VEH : #9-9702...

PAGE:

D140342 P1.1

DATE: 2008/12

REV.: D



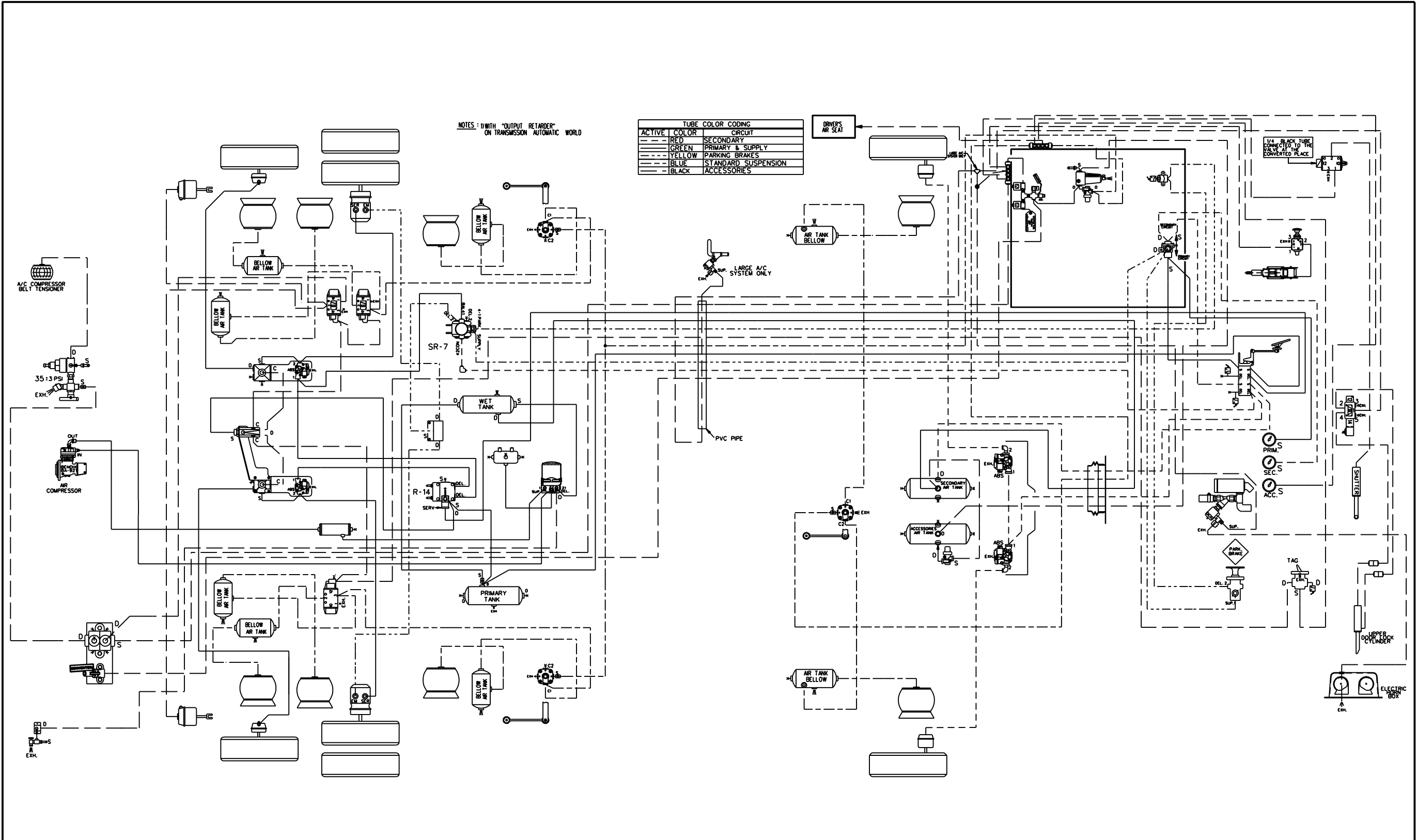

NOTES : WITH "OUTPUT RETARDER" ON TRANSMISSION AUTOMATIC WORLD

ACTIVE	COLOR	CIRCUIT
- - -	RED	SECONDARY
- - -	GREEN	PRIMARY & SUPPLY
- - -	YELLOW	PARKING BRAKES
- - -	BLUE	STANDARD SUSPENSION
- - -	BLACK	ACCESSORIES

**PREVOST®**

DESCRIPTION: BUS SHELL WE WITH FULL PNEUMATIC SYSTEM

EFF. W/ VEH : \*B-9954...  
 DATE: 2010/04 REV.: E

PAGE: D140342 P.1

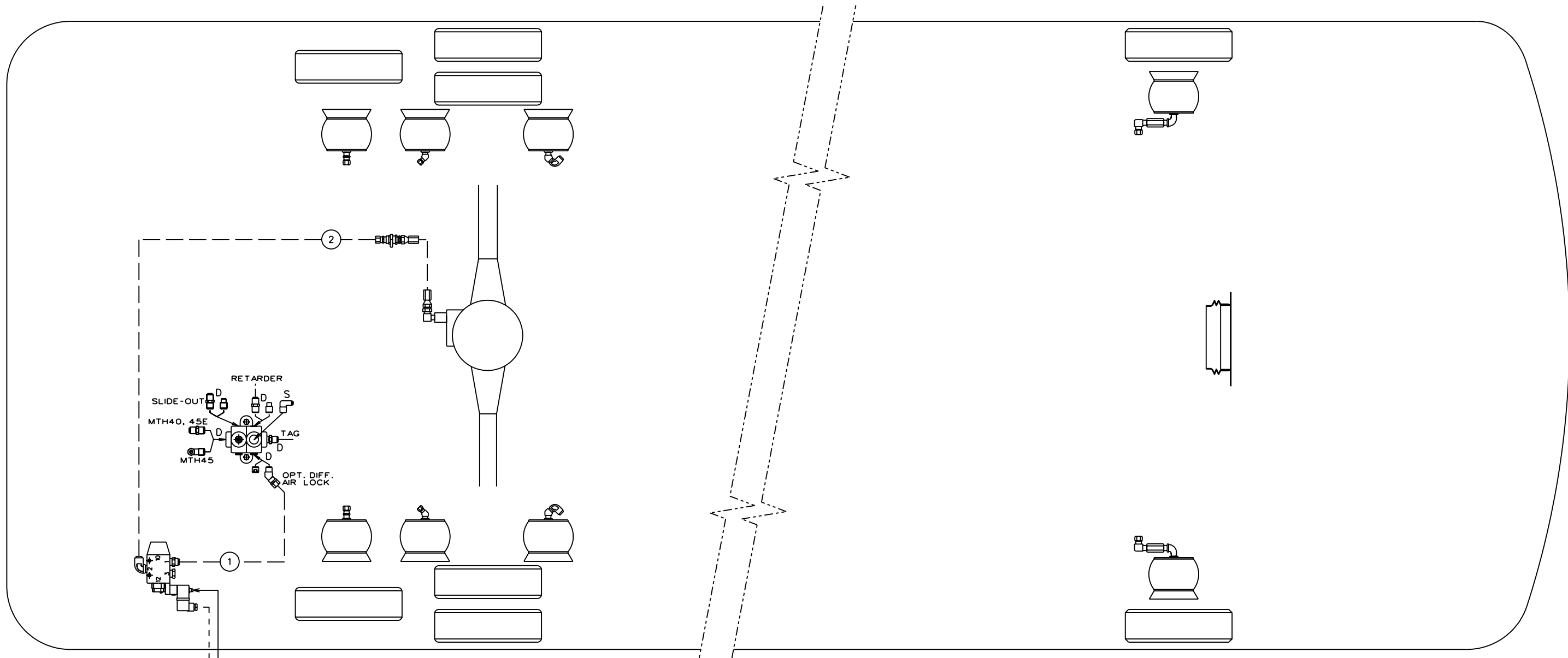

SOLENOID ENERGISED = DIFF. LOCK ACTIVE

CONNECTOR \*CDL FROM HARNESS FRONT JCT. BOX TO REAR JCT. BOX

BALLOON	PIPE
*1	1/4" O.D. BLACK
*2	3/8" O.D. BLACK

TUBE COLOR CODING		
LINE TYPE	COLOR	CIRCUIT
---	BLACK	ACCESSORIES

**PREVOST**®

DESCRIPTION:

BUS SHELL WE & WO 2006  
WITH OPTION DIFFERENTIAL AIR LOCK

EFF. W/VEH : TO FOLLOW  
DATE: 2006/09 REV.: A

PAGE: D140342SP1.1

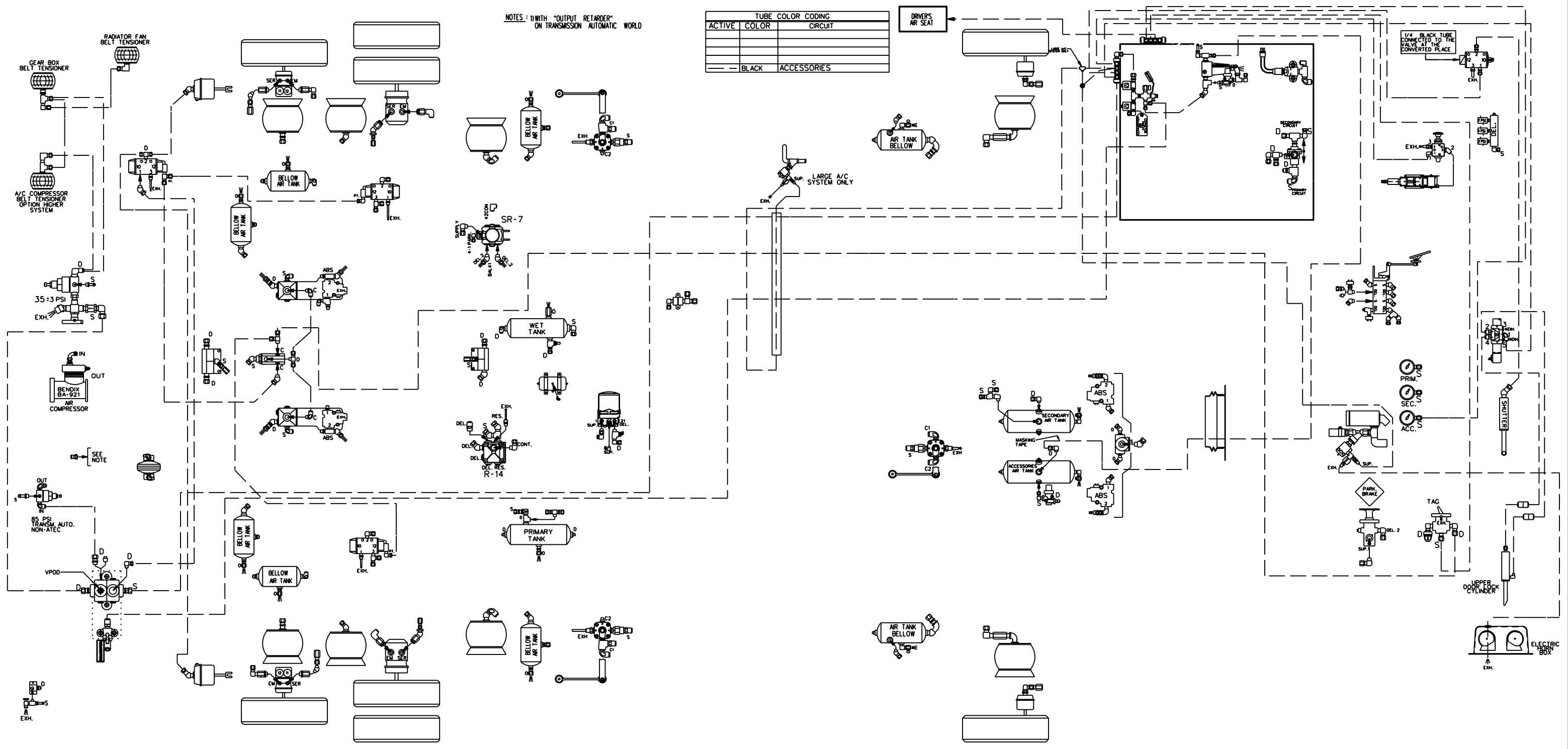

**PREVOST**®

DESCRIPTION:

BUS SHELL WE & WO 2006  
ACCESSORIES

EFF. W/ VEH : #7-9096  
Preliminary #7-9010  
DATE: 2006/09 REV.: A

PAGE:

D140342P1.2

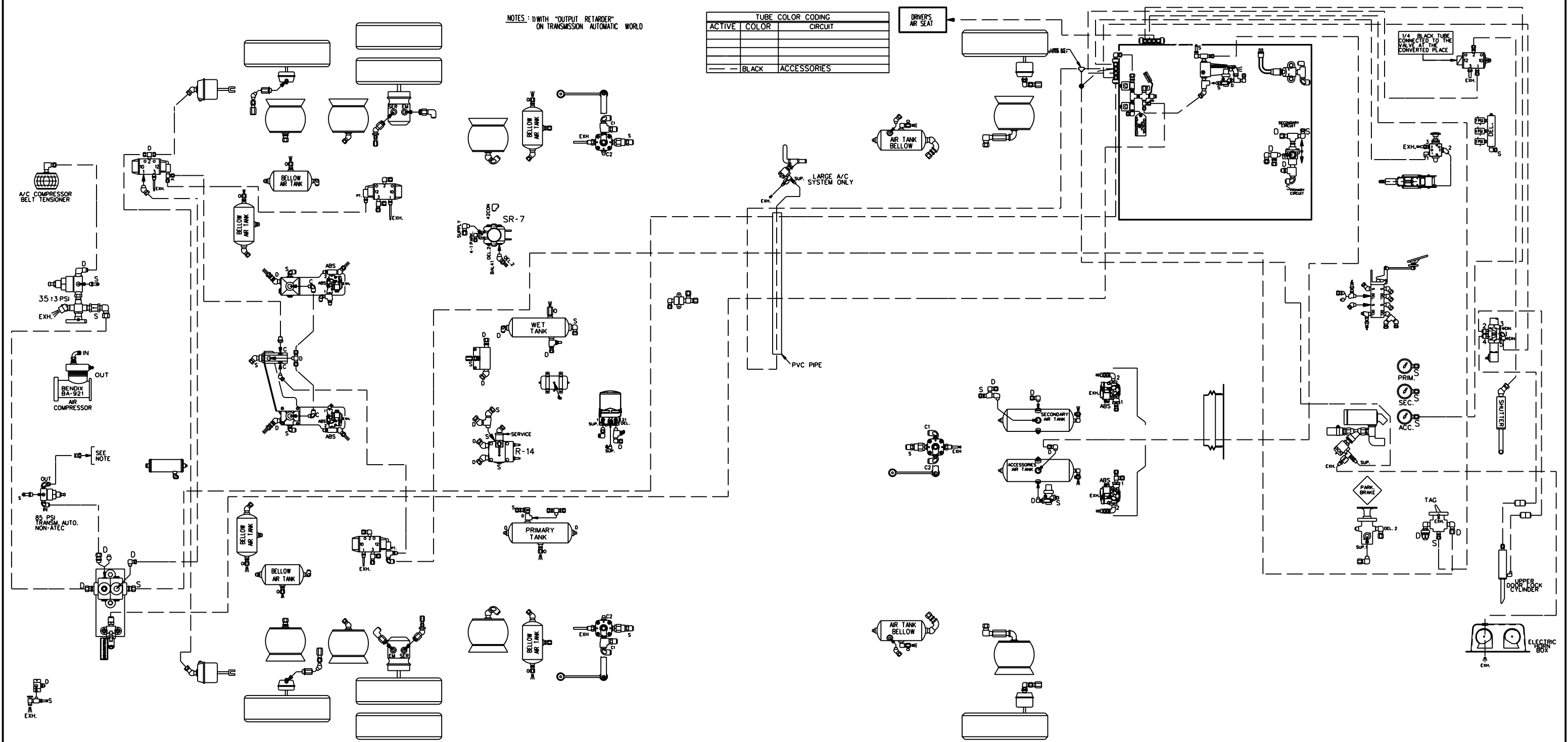

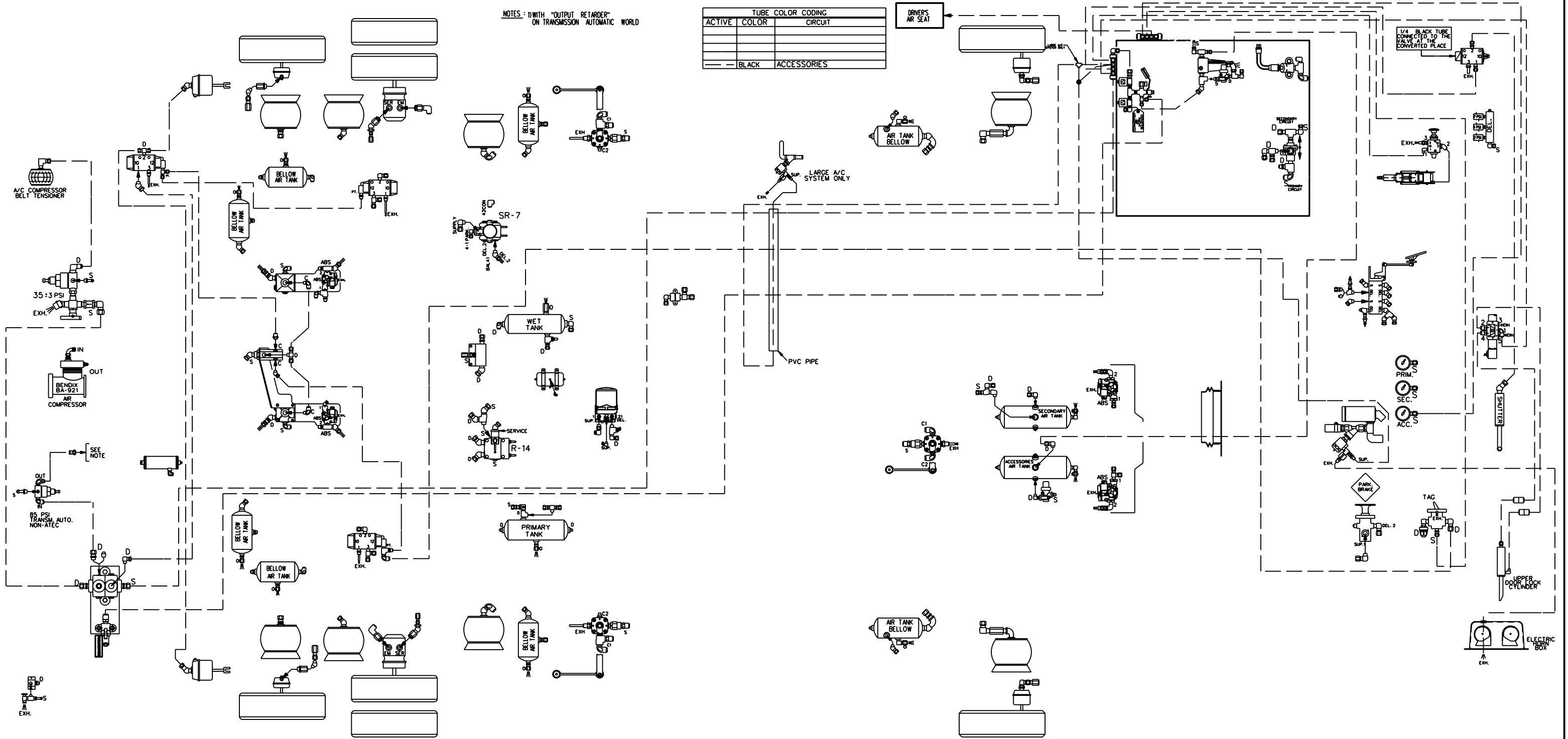

**PREVOST**®

DESCRIPTION:

BUS SHELL WE & WO 2006  
ACCESSORIES

EFF. W/ VEH : #8-9436

PAGE:

DATE: 2008/04

REV.: C

D140342 P1.2

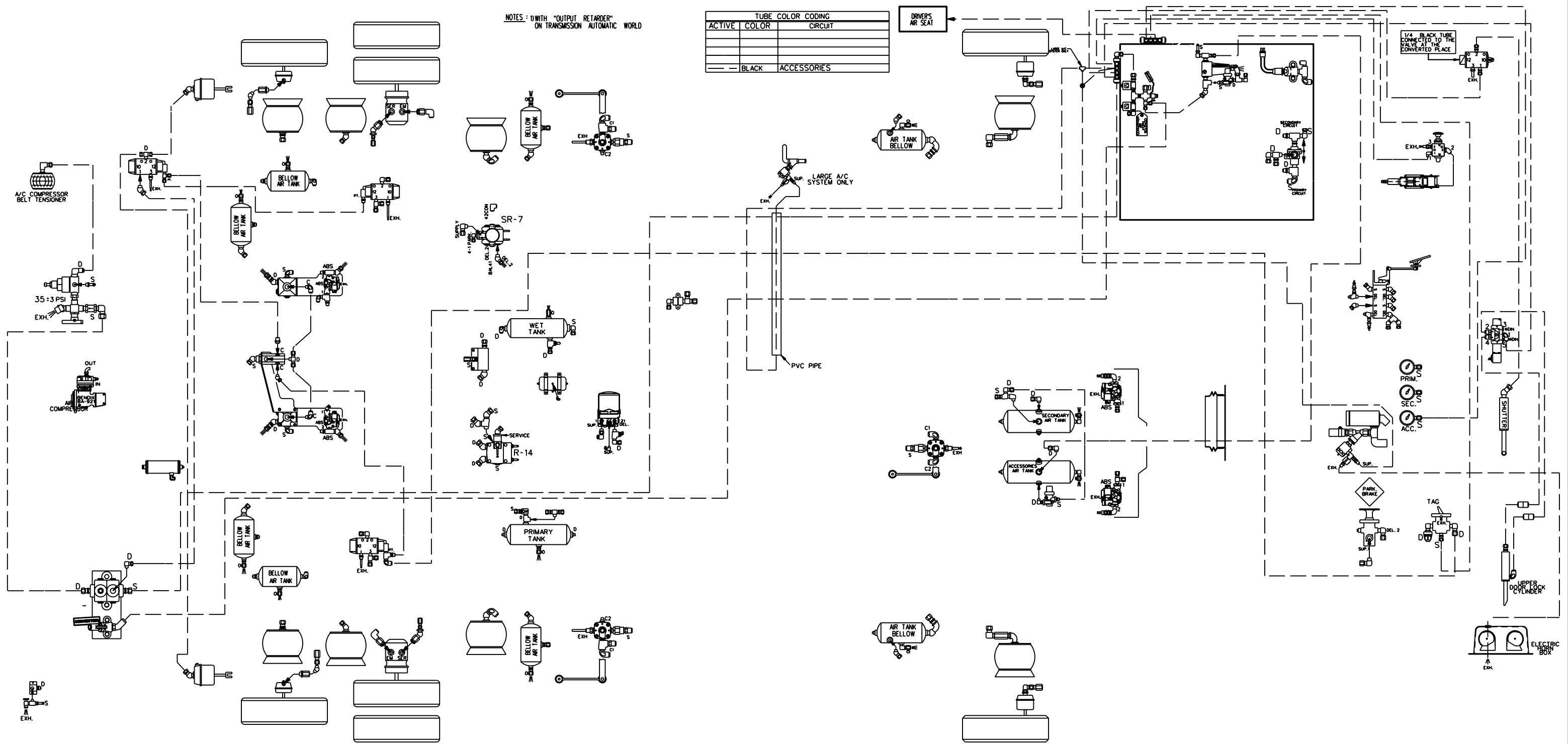

**PREVOST**

DESCRIPTION:

BUS SHELL WE & WO 2006  
ACCESSORIES

EFF. W/ VEH : #9-9702...

PAGE:

DATE: 2008/12

REV.: D

D140342 P1.2

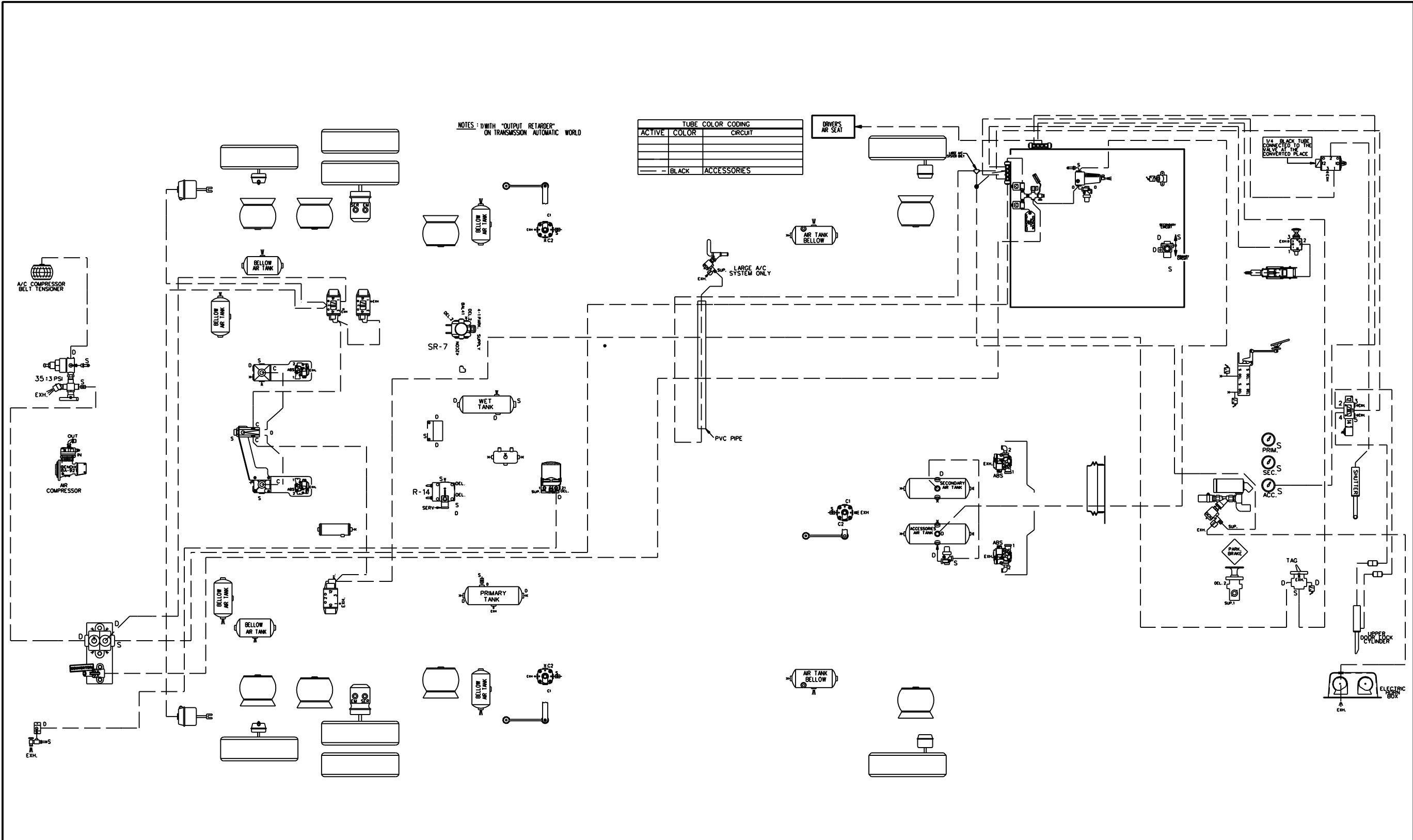

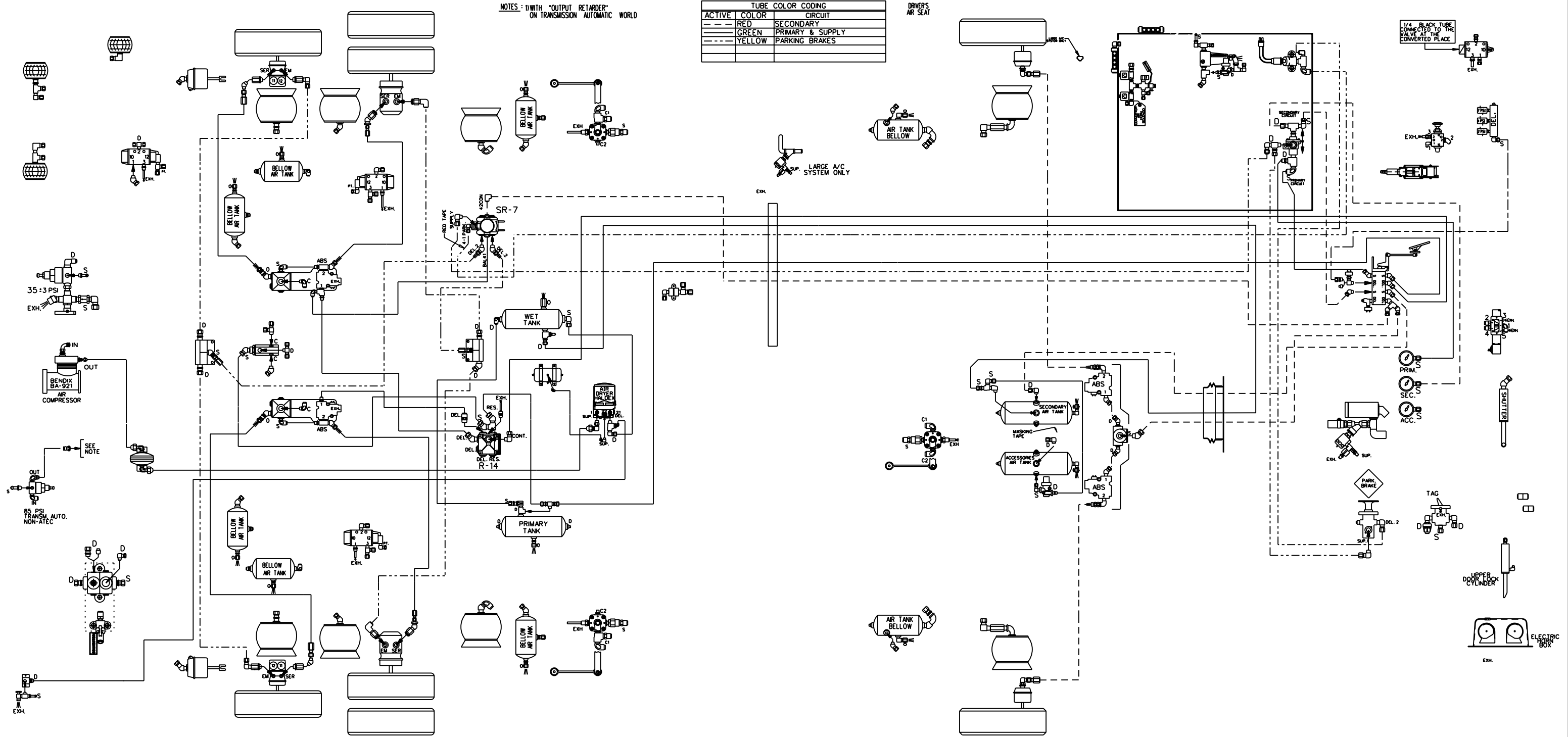

NOTES : 1) WITH "OUTPUT RETARDER" ON TRANSMISSION AUTOMATIC WORLD

ACTIVE	TUBE COLOR	CODING	CIRCUIT
---	RED		SECONDARY
---	GREEN		PRIMARY & SUPPLY
---	YELLOW		PARKING BRAKES

**PREVOST**®

DESCRIPTION: BUS SHELL WE & WO 2006 BRAKES SYSTEM

EFF. W/ VEH : #7-9096  
 Preliminary #7-9010  
 DATE: 2006/09 REV.: A

PAGE: D140342 P1.3



NOTES: 1) WITH "OUTPUT RETARDER" ON TRANSMISSION AUTOMATIC WORLD

ACTIVE	COLOR	CIRCUIT
---	RED	SECONDARY
---	GREEN	PRIMARY & SUPPLY
---	YELLOW	PARKING BRAKES

DRIVERS AIR SEAT

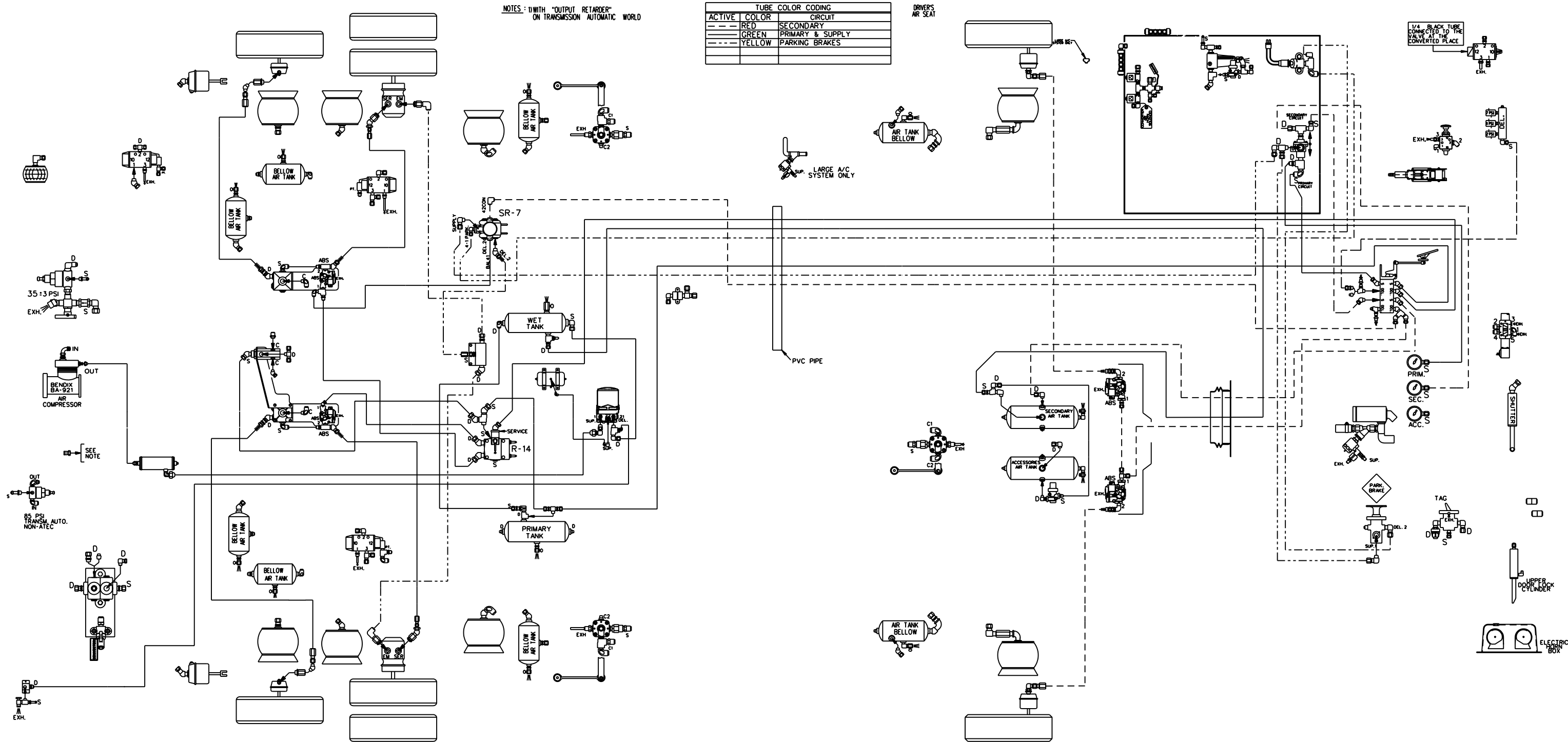

**PREVOST**

DESCRIPTION:

BUS SHELL WE & WO 2006  
BRAKES SYSTEM

EFF. W/ VEH : #8-9279

PAGE:

DATE: 2007/06

REV.: B

D140342 P1.3

NOTES : 1) WITH "OUTPUT RETARDER"  
ON TRANSMISSION AUTOMATIC WORLD

TUBE COLOR CODING	
ACTIVE	COLOR
---	RED
---	GREEN
---	YELLOW

DRIVERS  
AIR SEAT

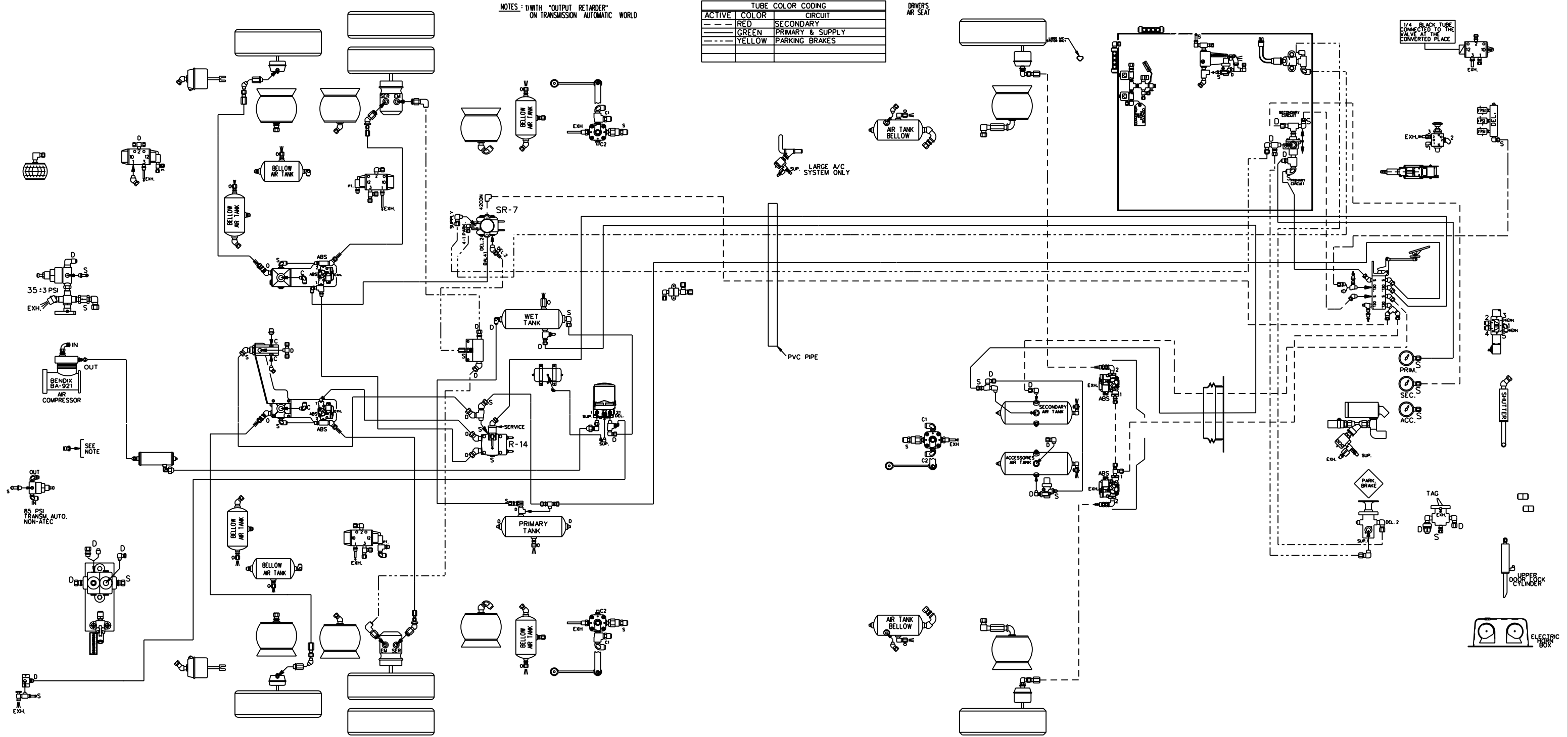

**PREVOST**

DESCRIPTION: BUS SHELL WE & WO 2006 BRAKES SYSTEM

EFF. W/ VEH : #8-9436  
DATE: 2008/04 REV.: C

PAGE: D140342 P1.3

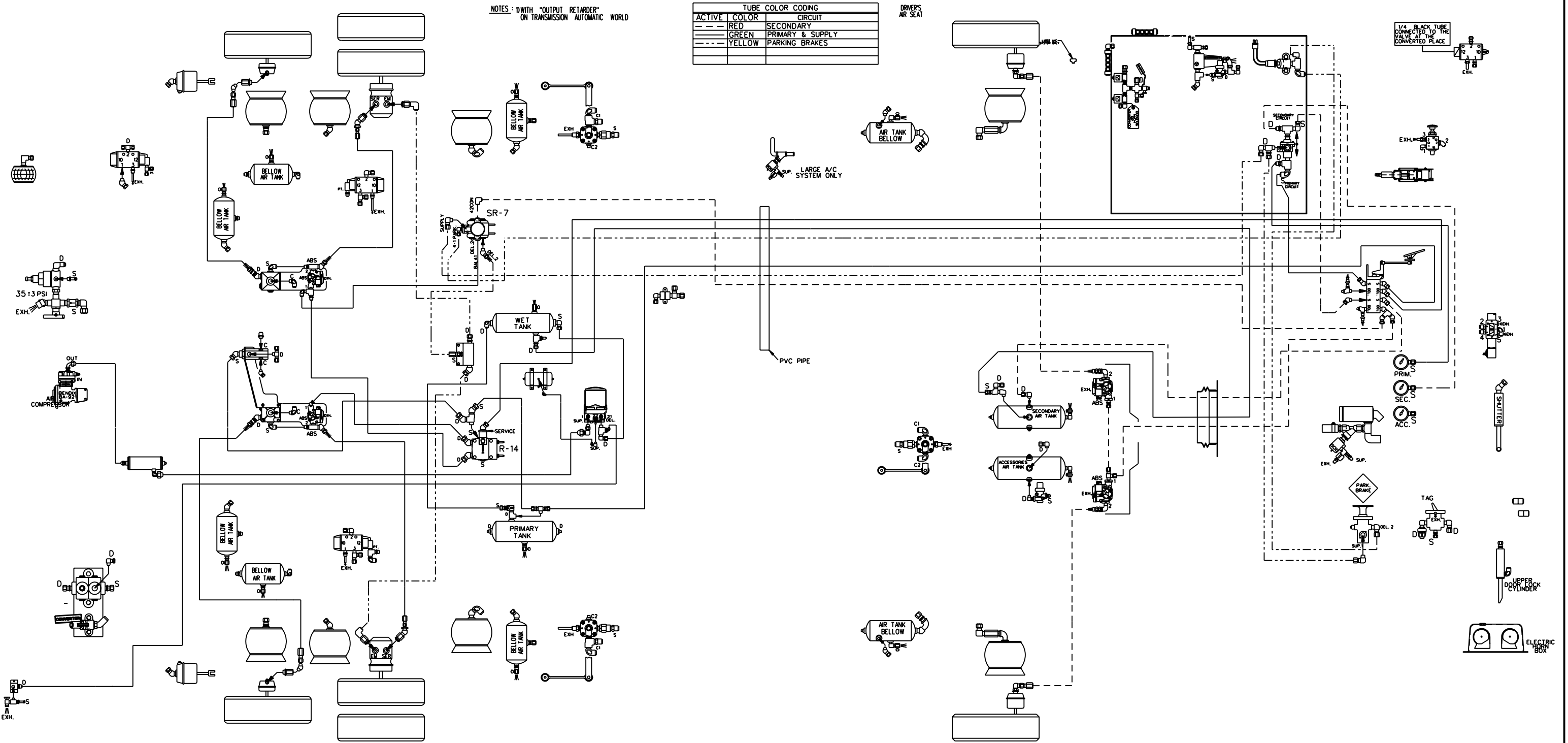

**PREVOST**

DESCRIPTION:

BUS SHELL WE & WO 2006  
BRAKES SYSTEM

EFF. W/ VEH : #9-9702...

PAGE:

DATE: 2008/12

REV.: D

D140342 P1.3

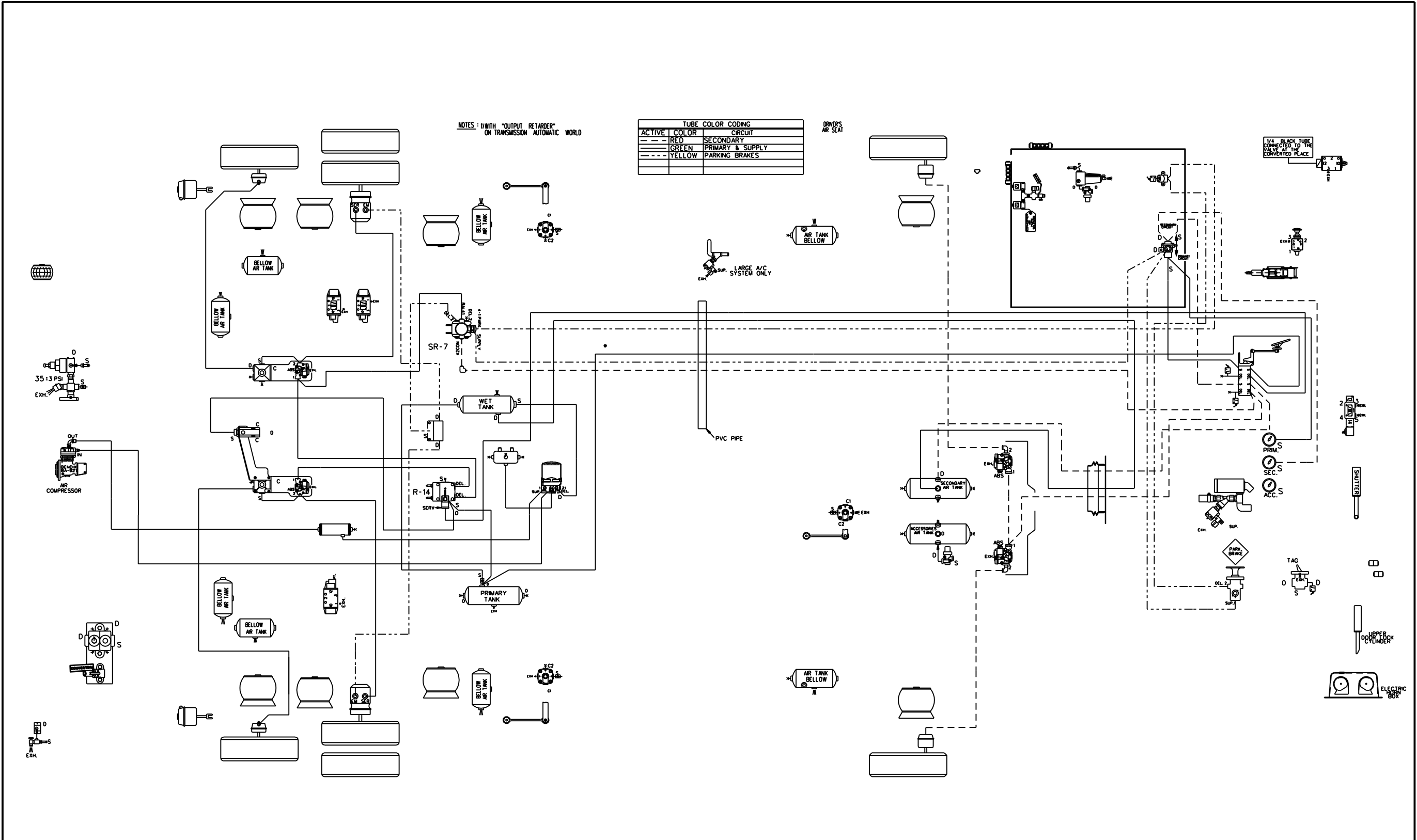

NOTES : 1) WITH "OUTPUT RETARDER"  
ON TRANSMISSION AUTOMATIC WORLD

TUBE COLOR CODING		
ACTIVE	COLOR	CIRCUIT
---	BLUE	STANDARD SUSPENSION

DRIVERS  
AIR SEAT

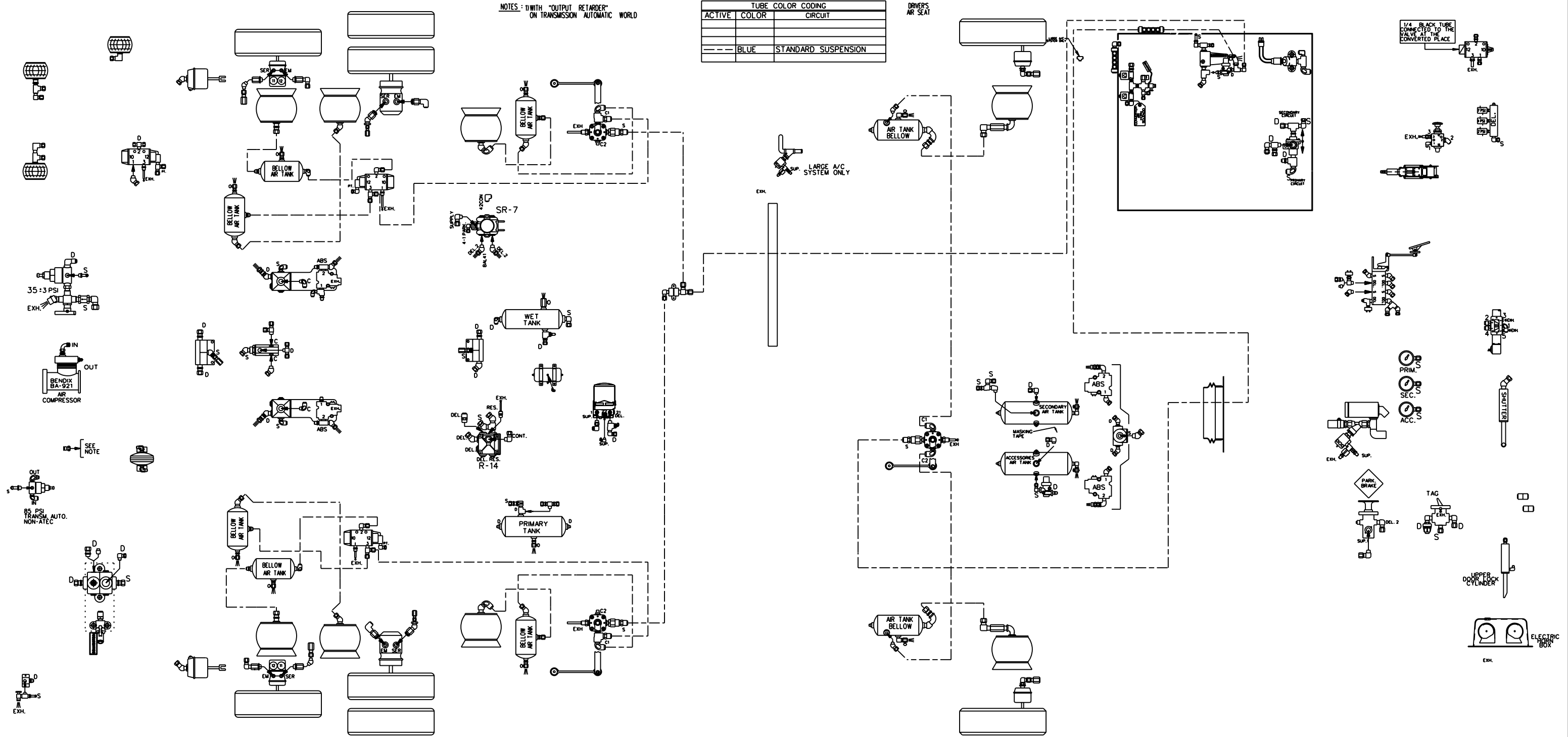

**PREVOST**®

DESCRIPTION:

BUS SHELL WE & WO 2006  
STANDARD SUSPENSION

EFF. W/ VEH : #7-9096  
Preliminary #7-9010  
DATE: 2006/09 REV.: A

PAGE:  
D140342 P1.4

DESCRIPTION:

BUS SHELL WE & WO 2006  
STANDARD SUSPENSION

EFF. W/ VEH : #8-9279

PAGE:

DATE: 2007/06

REV.: B

D140342 P1.4

NOTES : 1) WITH "OUTPUT RETARDER"  
ON TRANSMISSION AUTOMATIC WORLD

TUBE COLOR CODING		
ACTIVE	COLOR	CIRCUIT
---	BLUE	STANDARD SUSPENSION

DRIVERS  
AIR SEAT

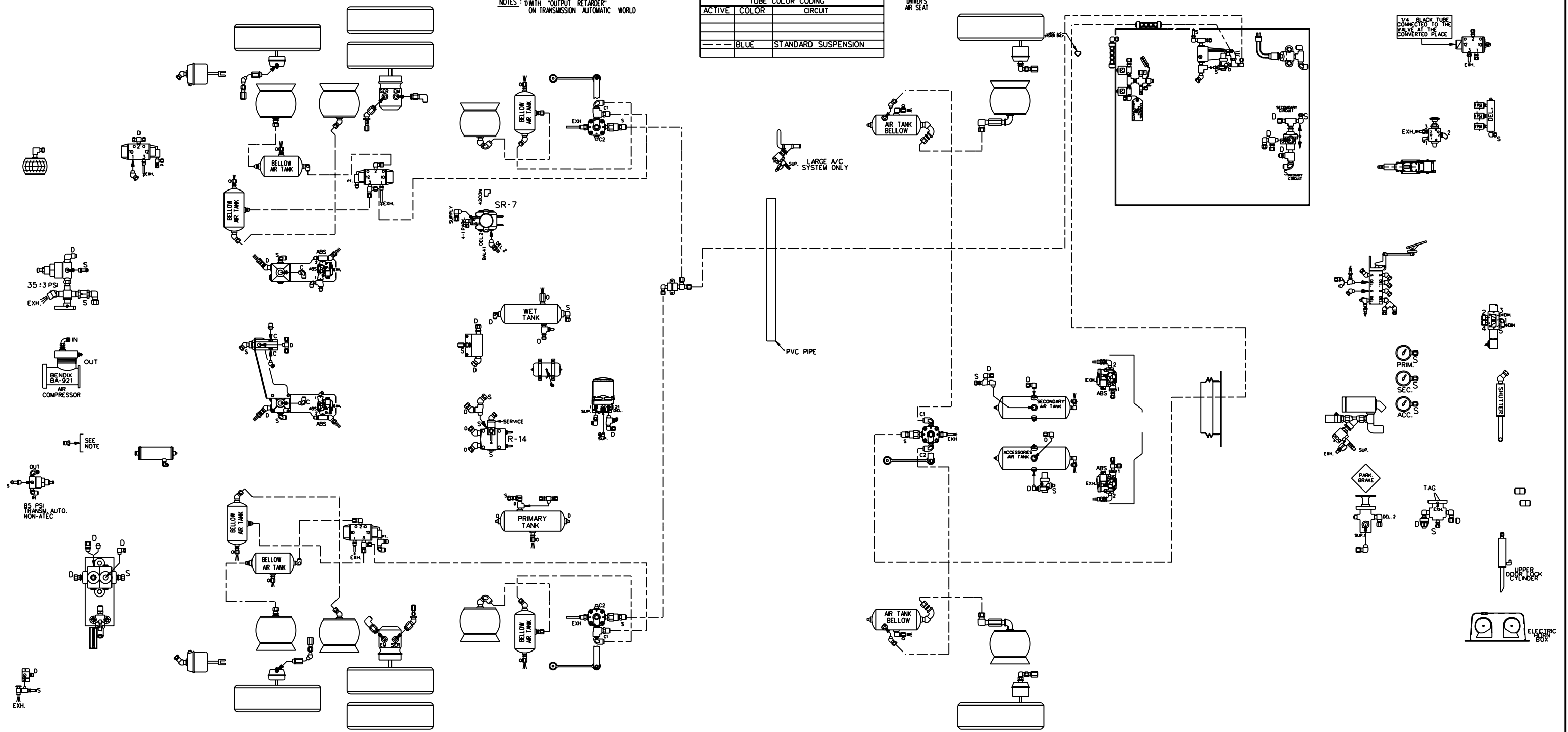

ELECTRIC  
BOX

NOTES : 1) WITH "OUTPUT RETARDER"  
ON TRANSMISSION AUTOMATIC WORLD

TUBE COLOR CODING		
ACTIVE	COLOR	CIRCUIT
---	BLUE	STANDARD SUSPENSION

DRIVERS  
AIR SEAT

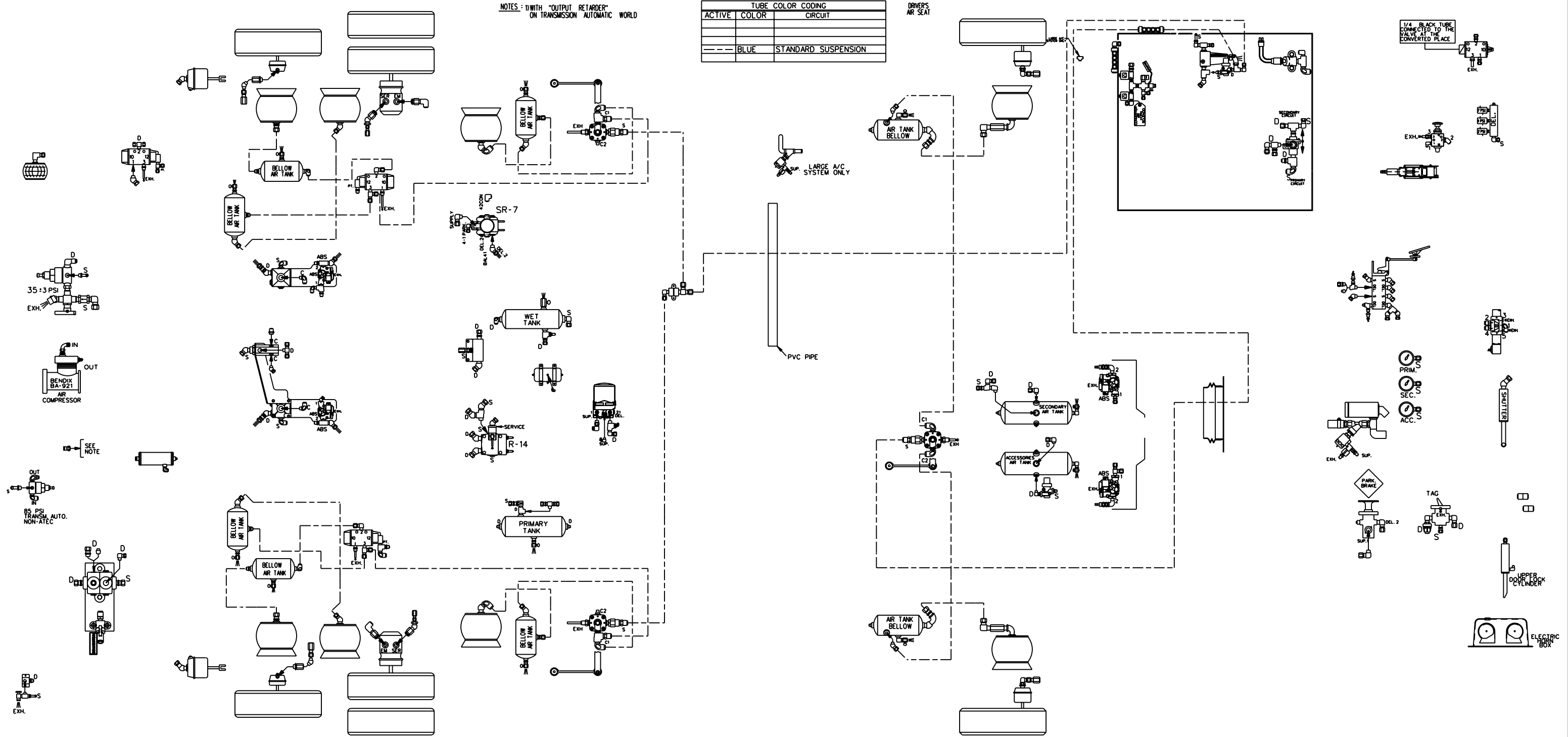

**PREVOST**®

DESCRIPTION: BUS SHELL WE & WO 2006  
STANDARD SUSPENSION

EFF. W/ VEH : #8-9436  
DATE: 2008/04 REV.: C

PAGE: D140342 P1.4

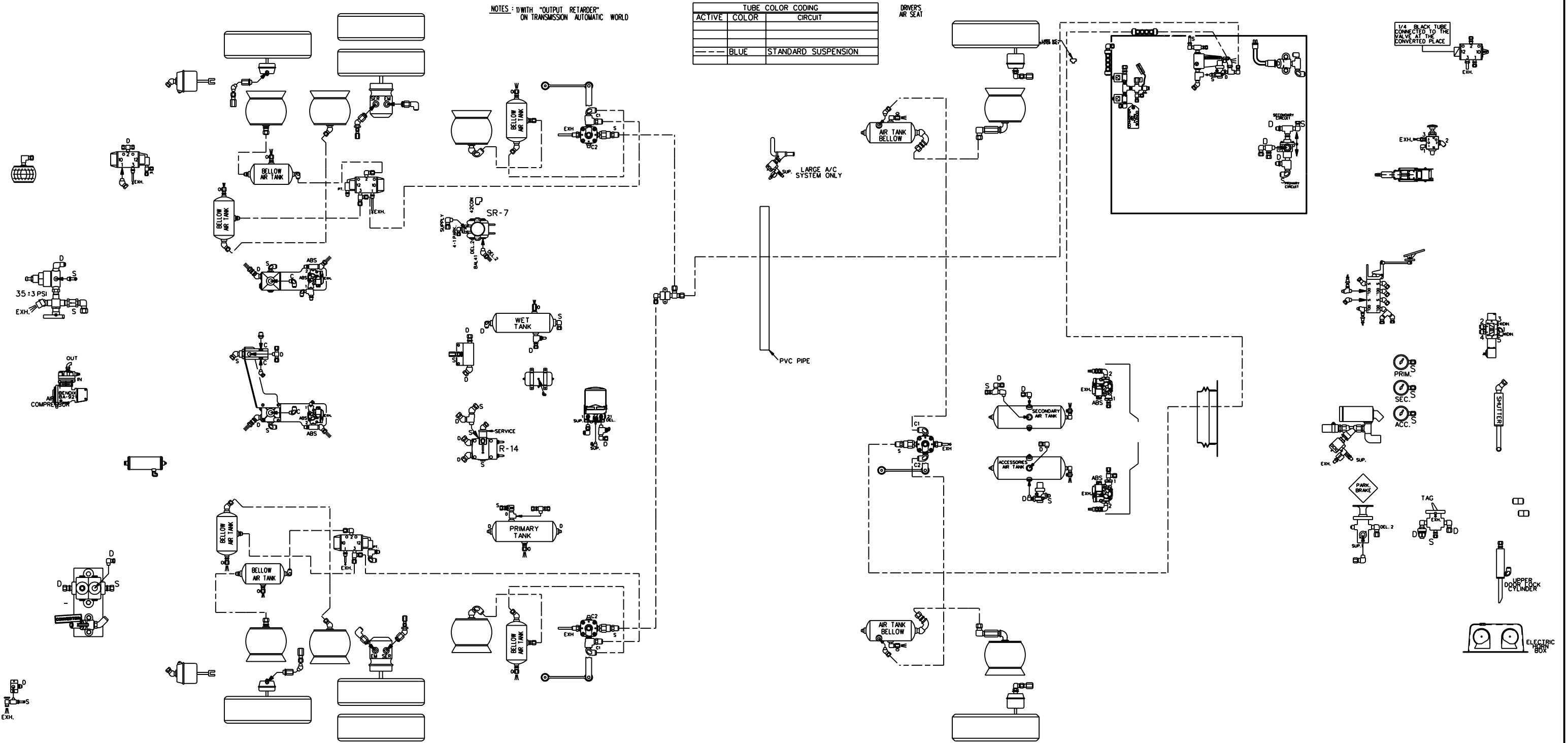

**PREVOST**®

DESCRIPTION:

BUS SHELL WE & WO 2006  
STANDARD SUSPENSION

EFF. W/ VEH : #9-9702...

PAGE:

DATE: 2008/12

REV.: D

D140342 P1.4



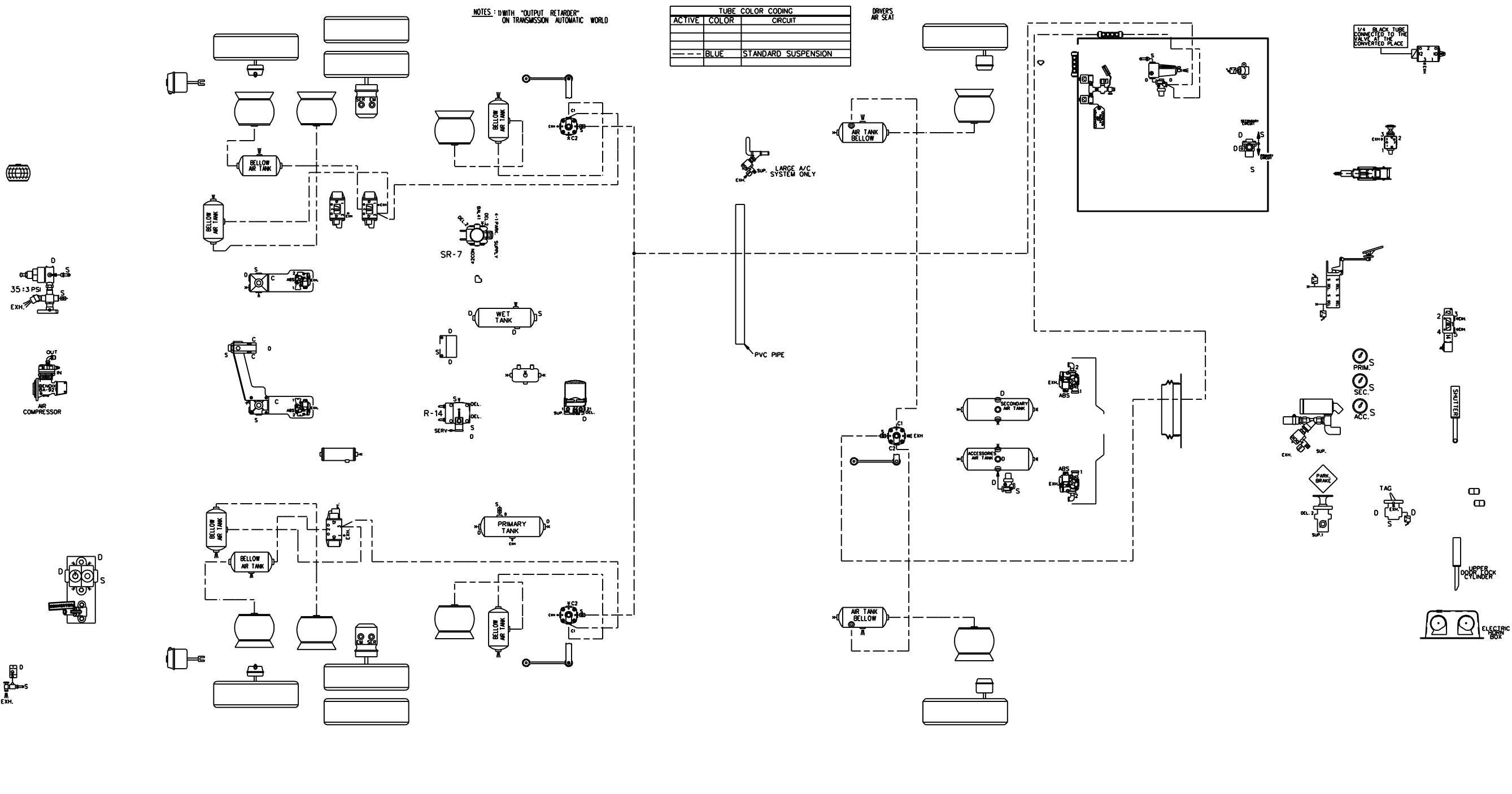

**PREVOST®**

DESCRIPTION:  
 BUS SHELL WE  
 STANDARD SUSPENSION

EFF. W/ VEH : \*B-9954...  
 DATE: 2010/04  
 REV.: E

PAGE:  
 D140342 P1.4

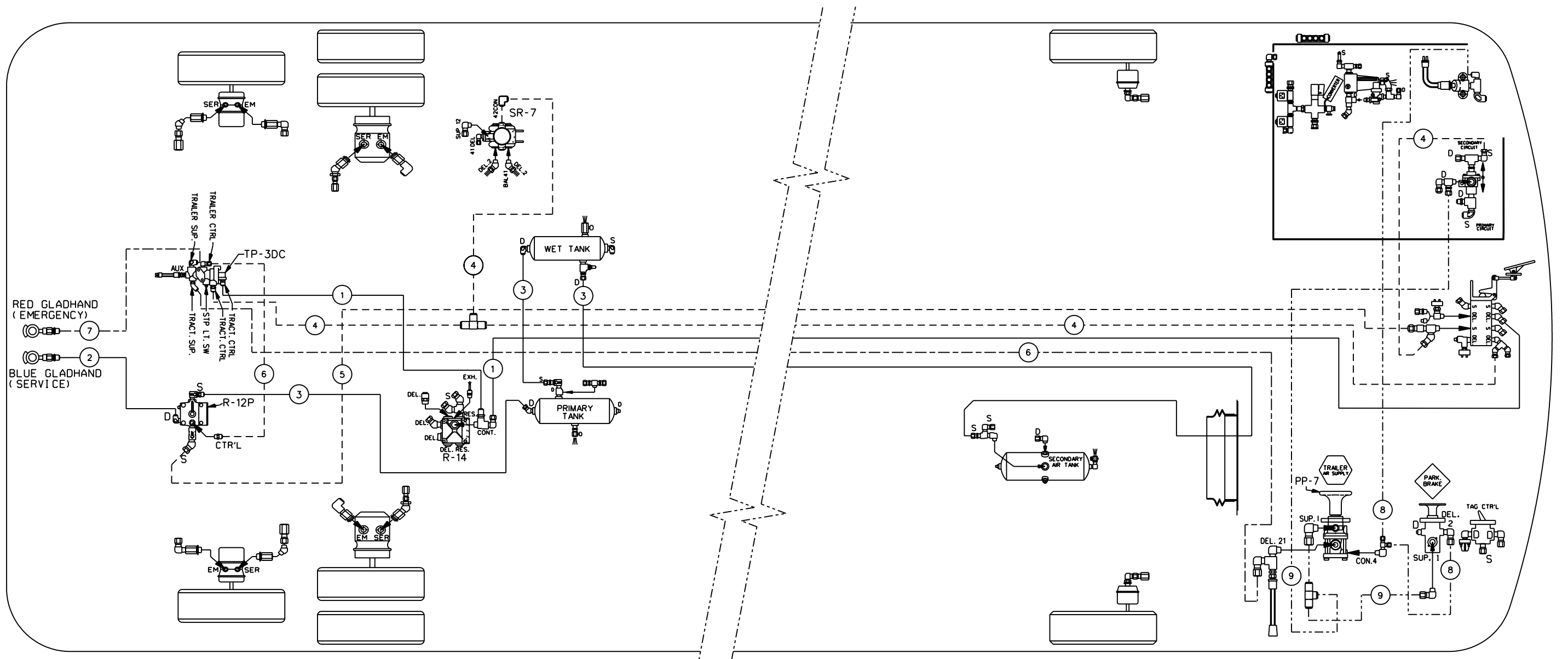

TUBE COLOR CODING	
ACTIVE COLOR	CIRCUIT
---	RED SECONDARY
---	GREEN PRIMARY & SUPPLY
---	YELLOW PARKING BRAKE
---	BROWN TRAILER

BALLOON	PIPE
#1	3/8" O.D. GREEN
#2	1/2" O.D. GREEN
#3	5/8" O.D. GREEN
#4	3/8" O.D. RED
#5	5/8" O.D. RED
#6	3/8" O.D. BROWN
#7	1/2" O.D. BROWN
#8	1/4" O.D. YELLOW
#9	3/8" O.D. YELLOW

**PREVOST**®

DESCRIPTION:

BUS SHELL WE & WO 2006  
WITH OPTION TRAILER HITCH AIR BRAKE

EFF. W/VEH : #7-9102...

PAGE:

DATE: 2006/09

REV.: A

D140342 P2.1

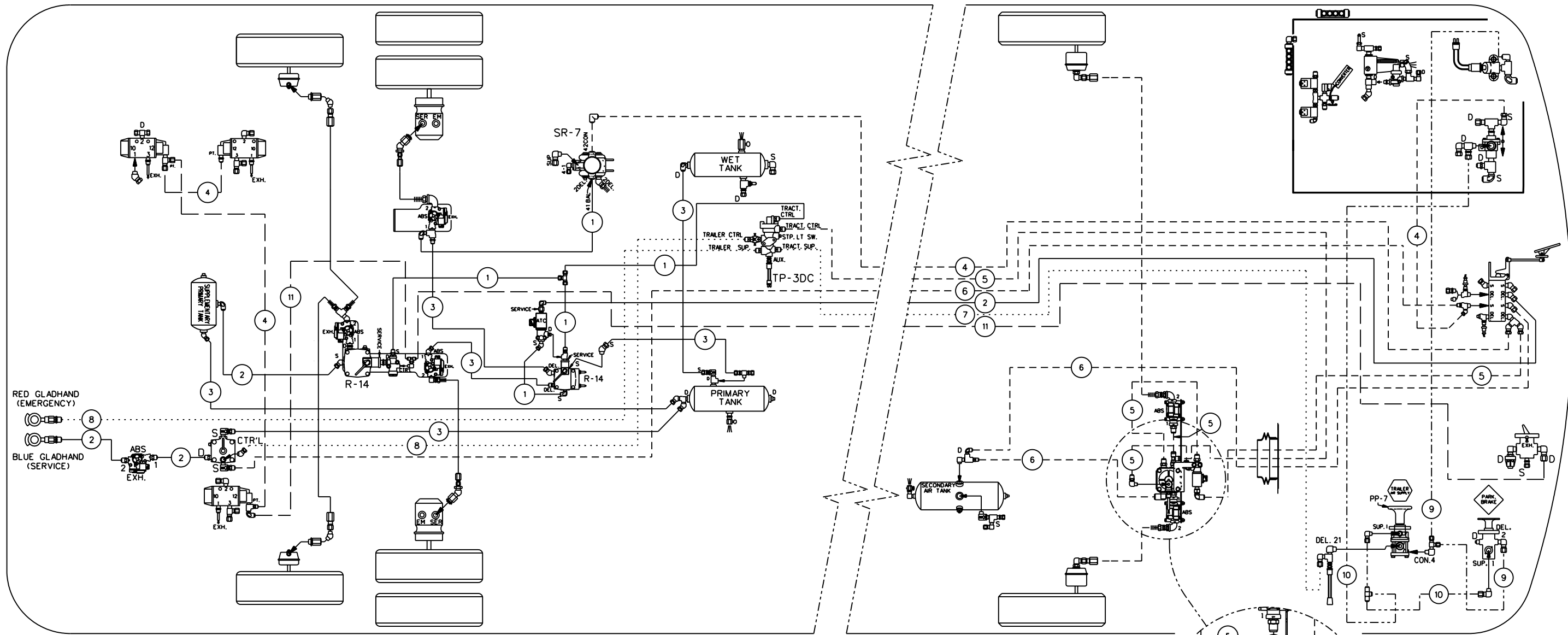

RED GLADHAND  
(EMERGENCY)

BLUE GLADHAND  
(SERVICE)

BALLOON	PIPE
•1	3/8" O.D. GREEN
•2	1/2" O.D. GREEN
•3	5/8" O.D. GREEN
•4	3/8" O.D. RED
•5	1/2" O.D. RED
•6	5/8" O.D. RED
•7	3/8" O.D. BROWN
•8	1/2" O.D. BROWN
•9	1/4" O.D. YELLOW
•10	3/8" O.D. YELLOW
•11	1/4" O.D. BLACK
•12	3/8" O.D. BLACK

TUBE COLOR CODING	
ACTIVE COLOR	CIRCUIT
---	RED SECONDARY
---	GREEN PRIMARY & SUPPLY
---	YELLOW PARKING BRAKE
---	BROWN TRAILER
---	BLACK ACCESSORIES

**PREVOST**®

DESCRIPTION:

BUS SHELL WE & WO 2006  
WITH OPTION TRAILER HITCH AIR BRAKE  
WITH ESP ADVANCED

EFF. W/VEH :

8-9279

PAGE:

D140342 P2.1

DATE:

2007/05

REV.:

C

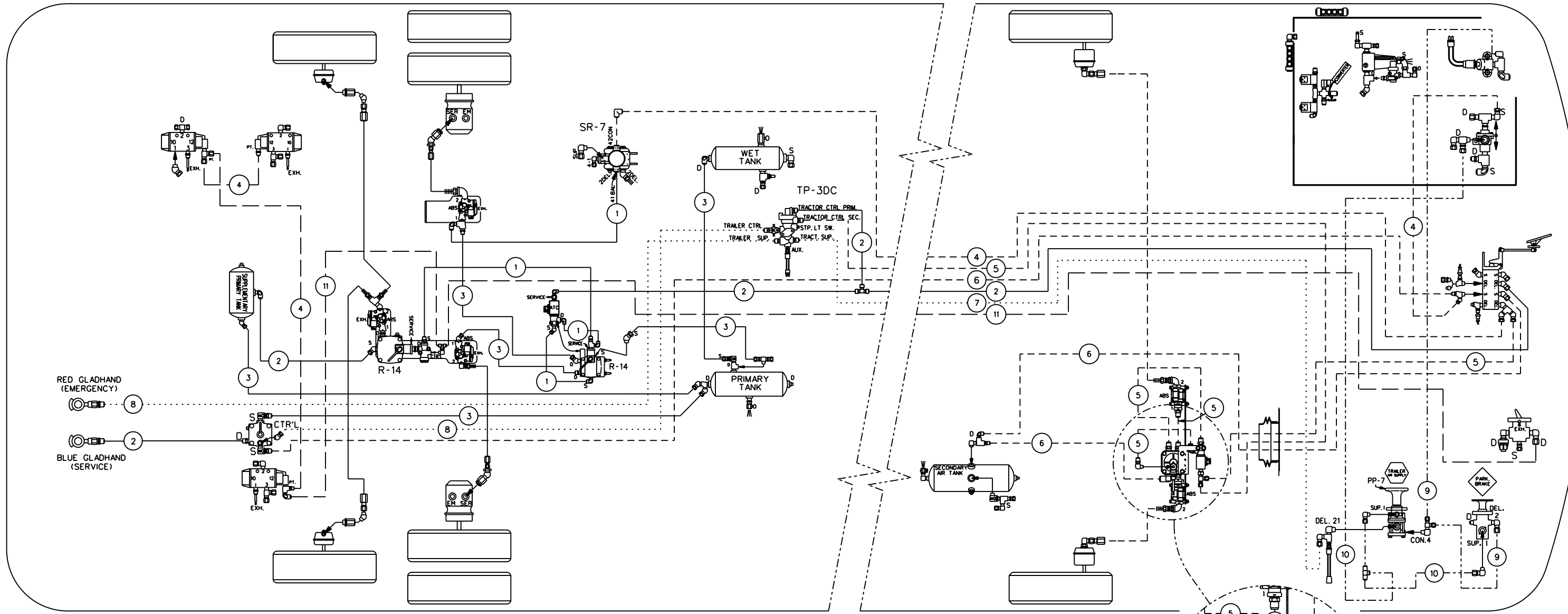

BALLOON	PIPE
•1	3/8" O.D. GREEN
•2	1/2" O.D. GREEN
•3	5/8" O.D. GREEN
•4	3/8" O.D. RED
•5	1/2" O.D. RED
•6	5/8" O.D. RED
•7	3/8" O.D. BROWN
•8	1/2" O.D. BROWN
•9	1/4" O.D. YELLOW
•10	3/8" O.D. YELLOW
•11	1/4" O.D. BLACK
•12	3/8" O.D. BLACK

TUBE COLOR CODING	
ACTIVE COLOR	CIRCUIT
---	RED SECONDARY
---	GREEN PRIMARY & SUPPLY
---	YELLOW PARKING BRAKE
---	BROWN TRAILER
---	BLACK ACCESSORIES

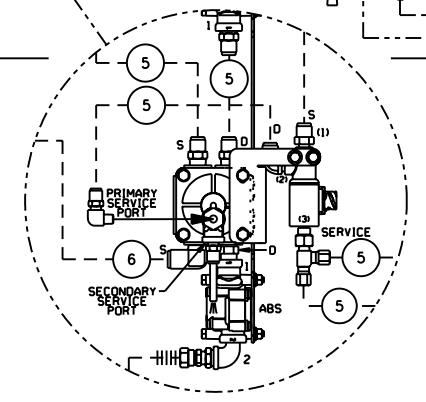

**PREVOST**®

DESCRIPTION: BUS SHELL WE & WO 2006  
WITH OPTION TRAILER HITCH AIR BRAKE  
WITH ESP BRAKE SYSTEM

EFF. W/VEH : #9-9702...  
DATE: 2008/12 REV.: E

PAGE: D140342 P2.1

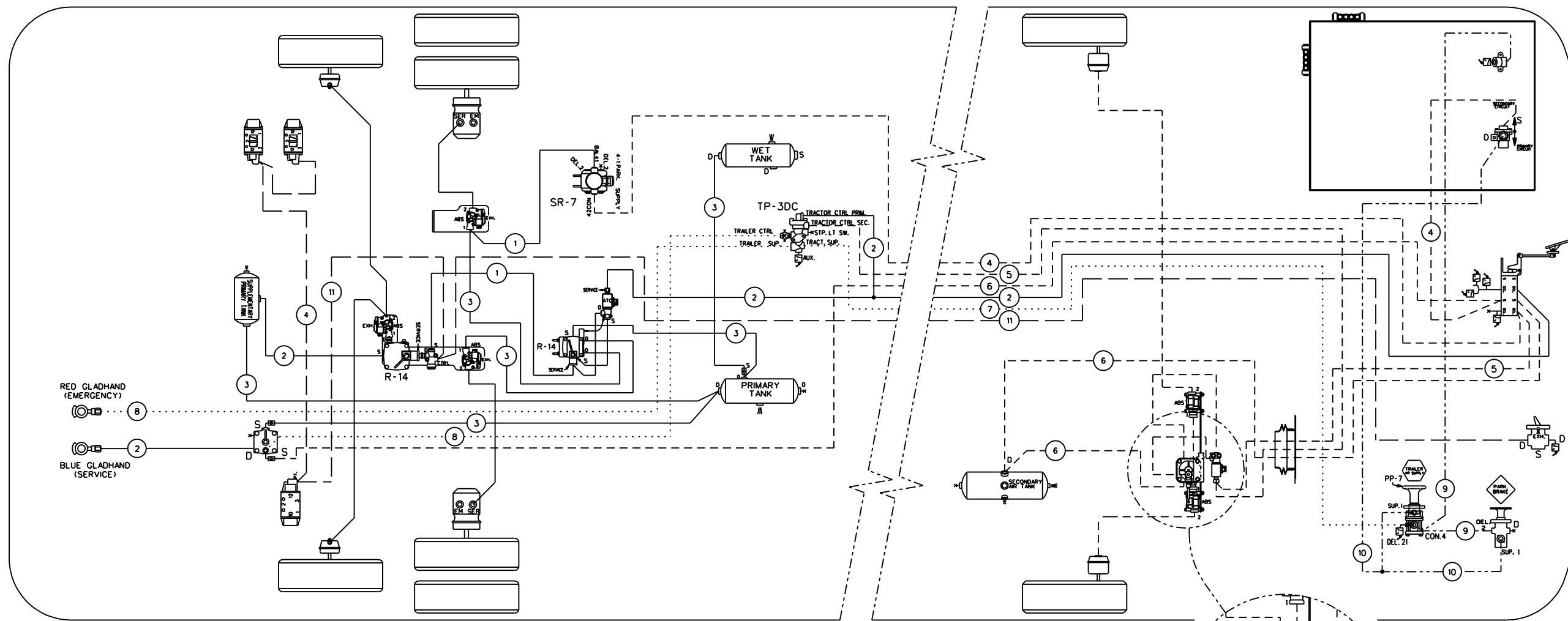

RED GLADHAND  
(EMERGENCY)

BLUE GLADHAND  
(SERVICE)

BALLOON	PIPE
•1	3/8" O.D. GREEN
•2	1/2" O.D. GREEN
•3	3/8" O.D. GREEN
•4	3/8" O.D. RED
•5	1/2" O.D. RED
•6	3/8" O.D. RED
•7	3/8" O.D. BROWN
•8	1/2" O.D. BROWN
•9	1/4" O.D. YELLOW
•10	3/8" O.D. YELLOW
•11	1/4" O.D. BLACK
•12	3/8" O.D. BLACK

TUBE COLOR CODING	
ACTIVE COLOR	CIRCUIT
---	RED SECONDARY
---	GREEN PRIMARY & SUPPLY
---	YELLOW PARKING BRAKE
---	BROWN TRAILER
---	BLACK ACCESSORIES

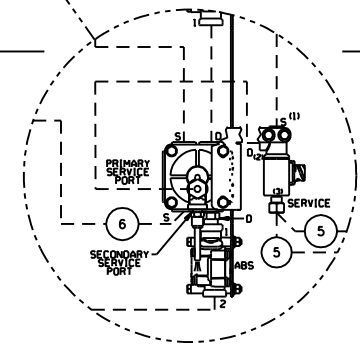

**PREVOST**®

DESCRIPTION:  
 BUS SHELL WE 2006  
 WITH OPTION TRAILER HITCH AIR BRAKE  
 WITH ESP BRAKE SYSTEM

EFF. W/VEH : #B-9954...  
 DATE: 2010/04 REV.: F

PAGE:  
 D140342 P2.1

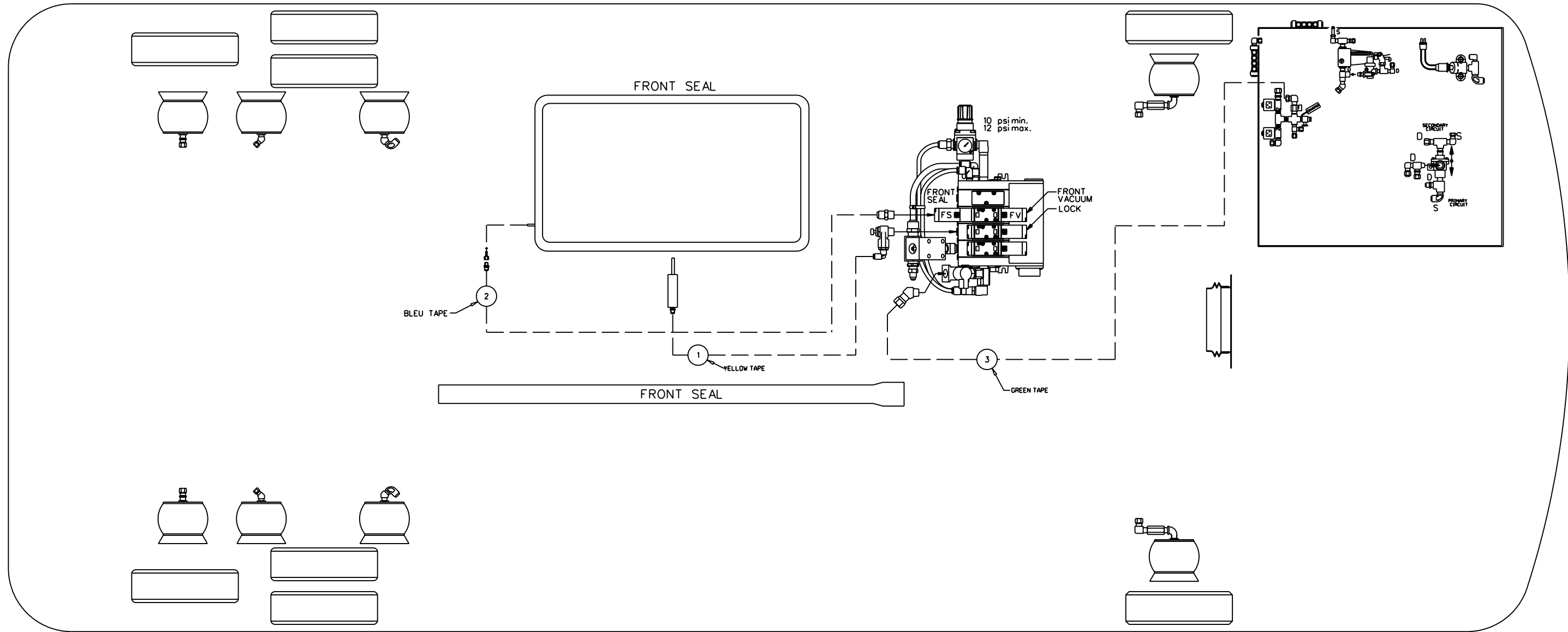

BALLOON	PIPE
*1	1/8" O.D. BLACK
*2	3/8" O.D. BLACK
*3	1/2" O.D. BLACK

TUBE COLOR CODING		
LINE TYPE	COLOR	CIRCUIT
---	BLACK	ACCESSOIRES

**PREVOST**®

DESCRIPTION:

BUS SHELL WE & WO 2006  
WITH OPTION SIMPLE SLIDE-OUT

EFF. W/VEH : \*7-9096

Preliminary \*7-9010

DATE: 2006/09

REV.: A

PAGE:

D140342 P3.1

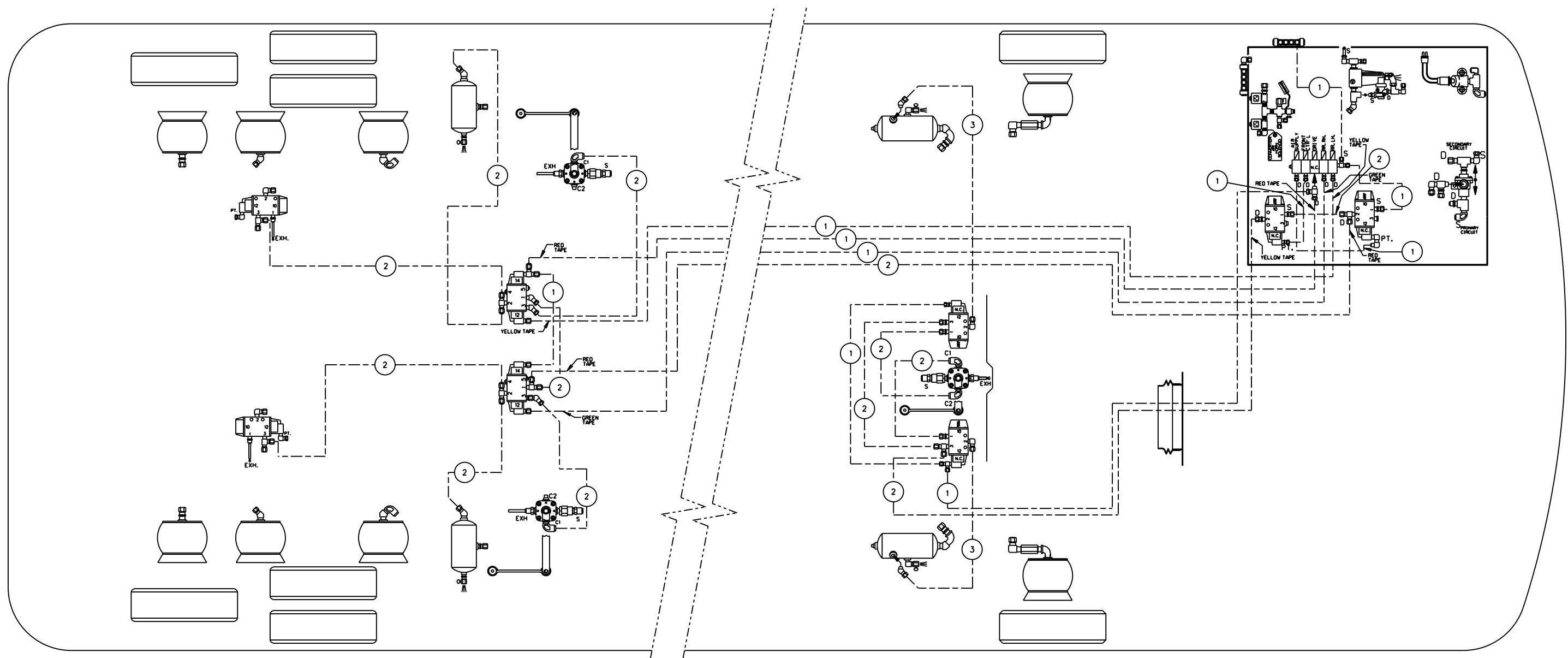

BALLOON	PIPE
#1	1/4" O.D. BLACK
#2	3/8" O.D. BLUE
#3	1/2" O.D. BLUE

TUBE COLOR CODING		
LINE TYPE	COLOR	CIRCUIT
---	BLUE	SUSPENSION
---	BLACK	SUSPENSION

**PREVOST**®

DESCRIPTION:

BUS SHELL WE & WO 2006  
WITH OPTION LEVEL LOW

EFF. W/VEH : #7-9096...

Preliminary #7-9010

DATE:  
2006/09

REV.:  
A

PAGE:

D140342 P4.1

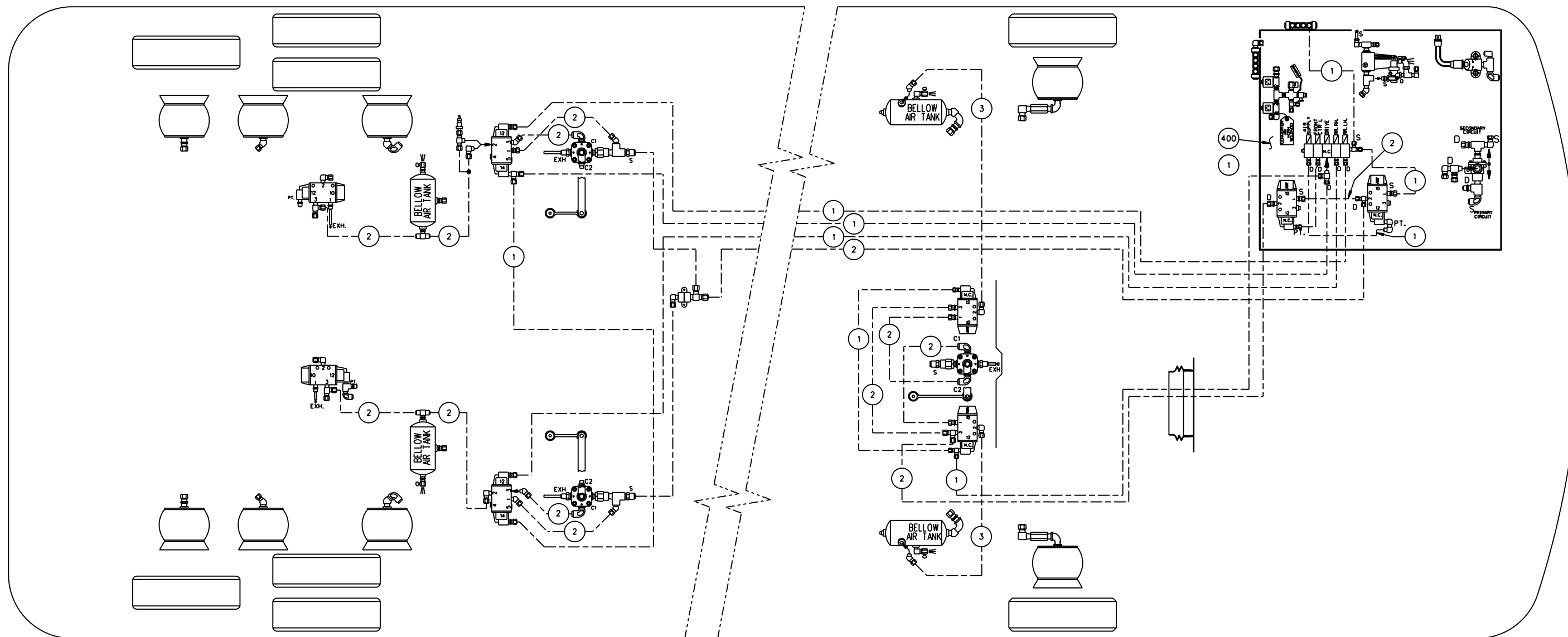

TUBE COLOR CODING	
ACTIVE COLOR	CIRCUIT
---	BLACK ACCESSORIES
---	BLUE STANDARD SUSPENSION

BALLOON	PIPE
*1	1/4" O.D. BLACK
*2	3/8" O.D. BLUE
*3	1/2" O.D. BLUE

**PREVOST®**

DESCRIPTION:

BUS SHELL WE & WO 2006  
WITH OPTION LEVEL LOW

EFF. W/VEH :  
#8-9279...

PAGE:

DATE:  
2007/06

REV.:  
B

D140342 P4.1



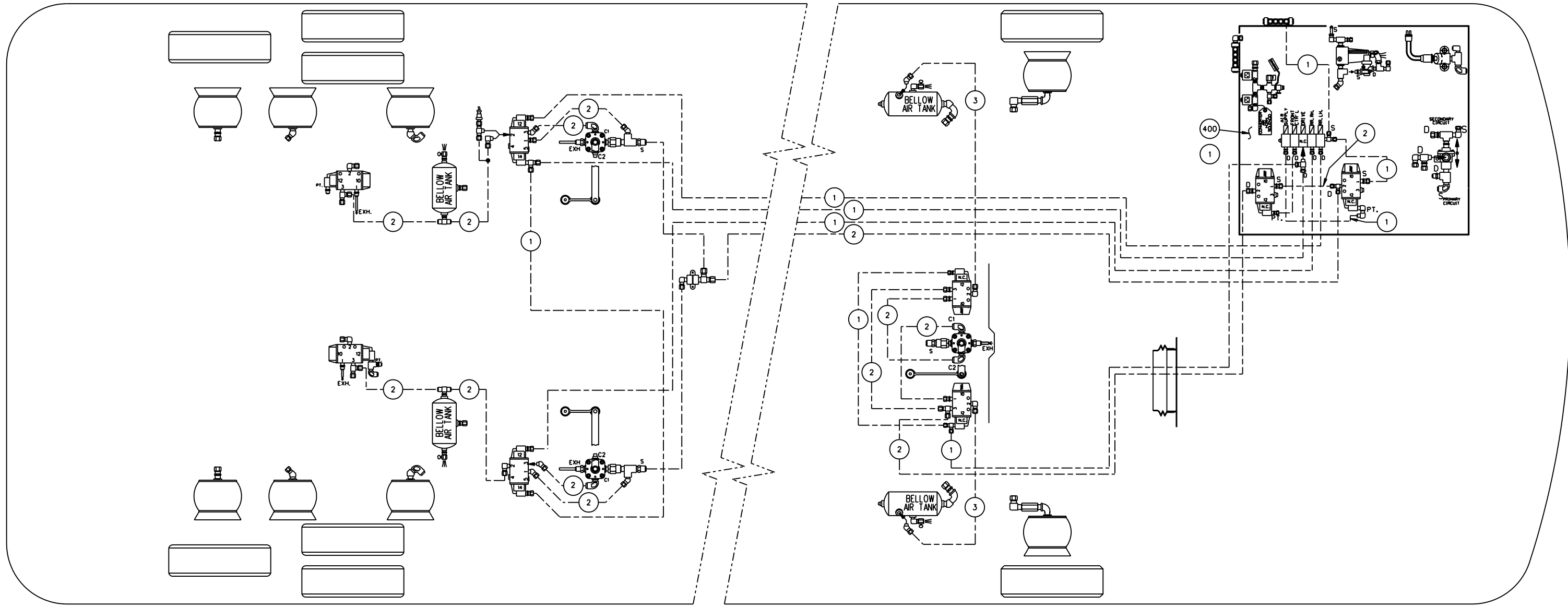

TUBE COLOR CODING		
ACTIVE	COLOR	CIRCUIT
—	BLACK	ACCESSORIES
- - -	BLUE	STANDARD SUSPENSION

BALLOON	PIPE
*1	1/4" O.D. BLACK
*2	3/8" O.D. BLUE
*3	1/2" O.D. BLUE

**PREVOST**®

DESCRIPTION:

BUS SHELL WE & WO 2006  
WITH OPTION LEVEL LOW

EFF. W/VEH : #8-9436

PAGE:

DATE: 2008/04

REV.: C

D140342 P4.1

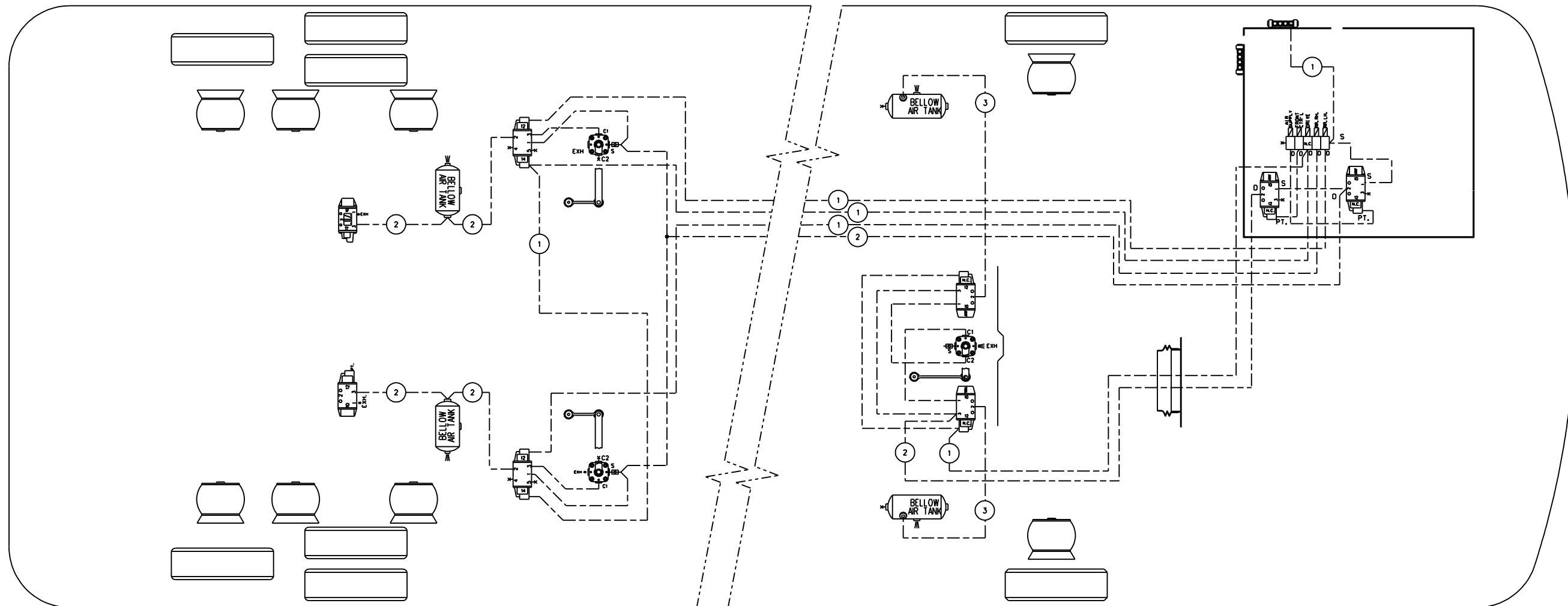

TUBE COLOR CODING	
ACTIVE COLOR	CIRCUIT
—	BLACK ACCESSORIES
---	BLUE STANDARD SUSPENSION

BALLOON	PIPE
*1	1/4" O.D. BLACK
*2	3/8" O.D. BLUE
*3	1/2" O.D. BLUE

**PREVOST**®

DESCRIPTION:

BUS SHELL WE 2006  
WITH OPTION LEVEL LOW

EFF. W/VEH : #B-9954...

PAGE:

D140342 P4.1

DATE: 2010/04

REV.: D

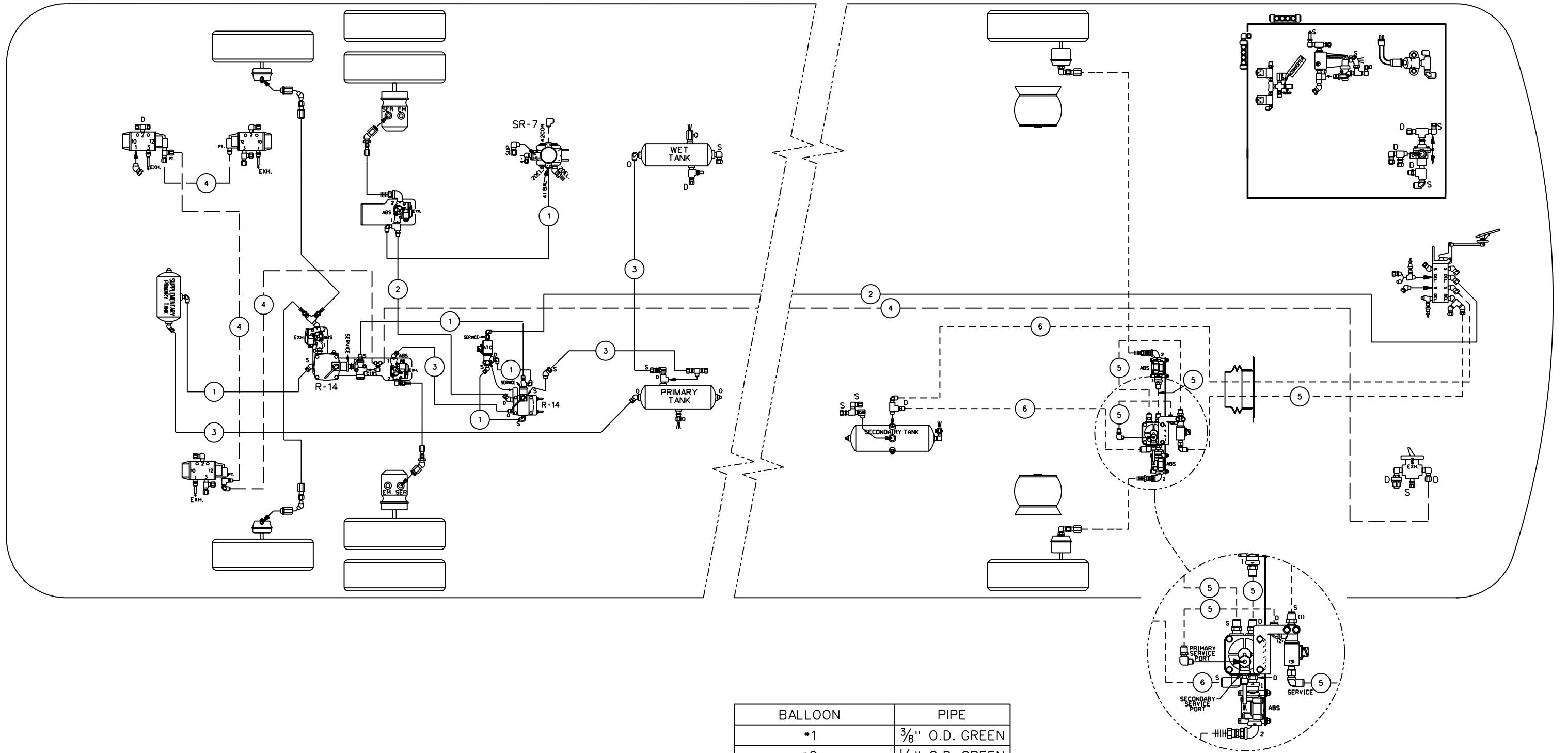

BALLOON	PIPE
*1	3/8" O.D. GREEN
*2	1/2" O.D. GREEN
*3	5/8" O.D. GREEN
*4	1/4" O.D. BLACK
*5	1/2" O.D. RED
*6	5/8" O.D. RED

TUBE COLOR CODING		
ACTIVE	COLOR	CIRCUIT
—	GREEN	PRIMARY & SUPPLY
—	BLACK	ACCESSORIES
- - -	RED	SECONDARY

**PREVOST**®

DESCRIPTION:  
 WO & WE BUS SHELL  
 WITH OPTION ESP BRAKE SYSTEM

EFF. W/ VEH : 8-9279...  
 DATE: 2008/03  
 REV.: B

PAGE:  
 D140342 P5.1

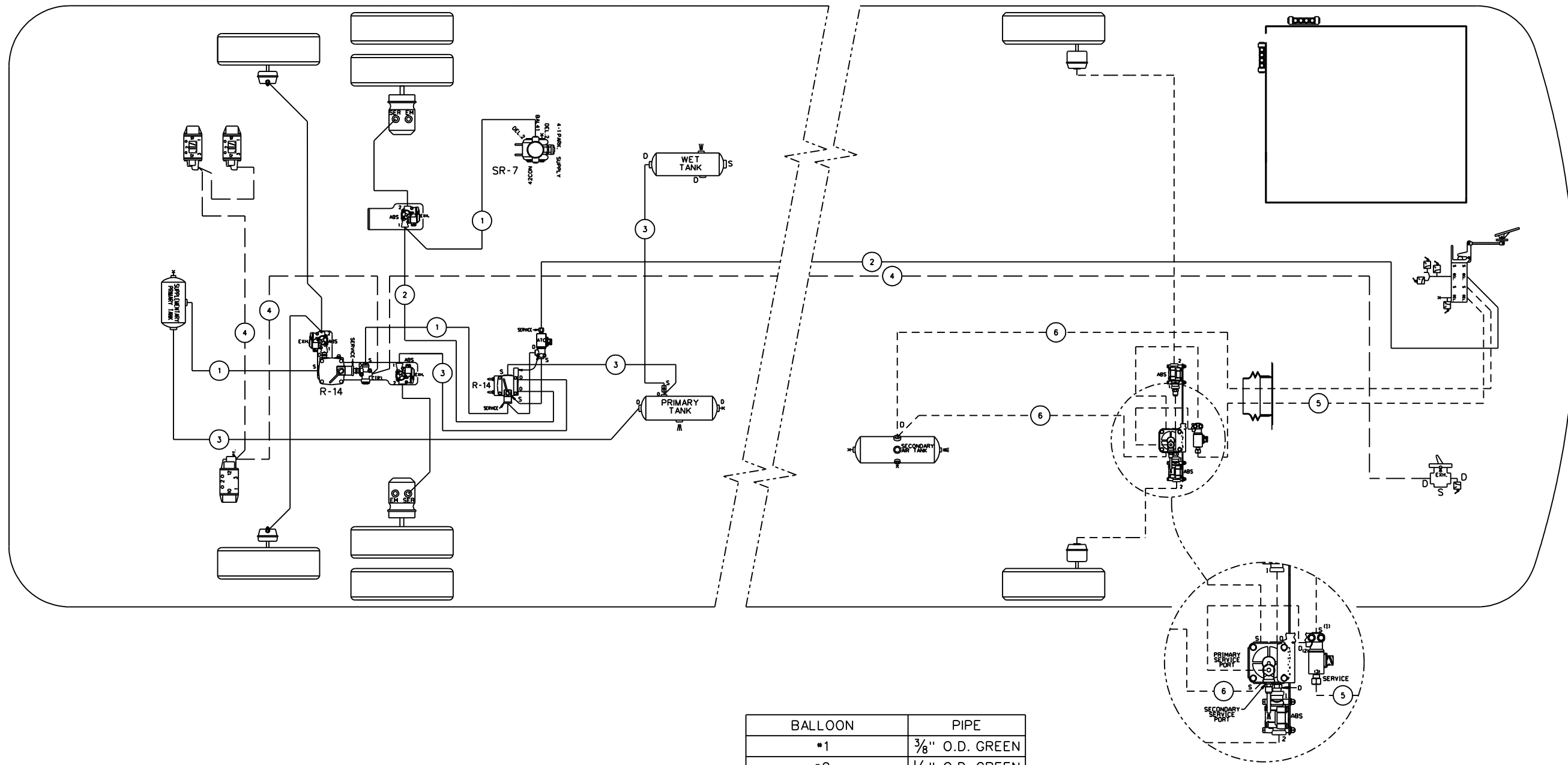

BALLOON	PIPE
*1	3/8" O.D. GREEN
*2	1/2" O.D. GREEN
*3	5/8" O.D. GREEN
*4	1/4" O.D. BLACK
*5	1/2" O.D. RED
*6	5/8" O.D. RED

TUBE COLOR CODING	
ACTIVE COLOR	CIRCUIT
— GREEN	PRIMARY & SUPPLY
— BLACK	ACCESSORIES
--- RED	SECONDARY

**PREVOST®**

DESCRIPTION:

WE BUS SHELL  
WITH OPTION ESP BRAKE SYSTEM

EFF. W/ VEH : \*B-9954...

PAGE:

D140342 P5.1

DATE: 2010/04

REV.: C

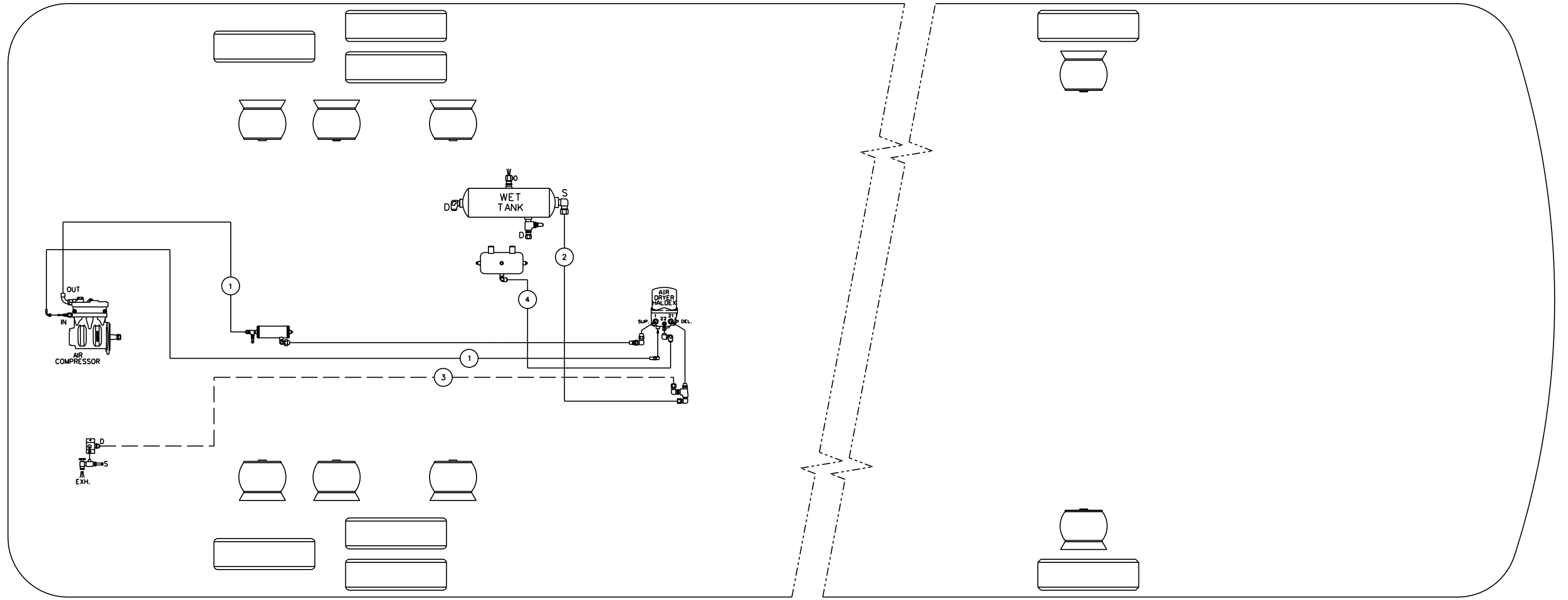

TUBE COLOR CODING	
ACTIVE COLOR	CIRCUIT
— GREEN	PRIMARY & SUPPLY
— BLACK	ACCESSORIES

BALLOON	PIPE
*1	HOSE ASS'Y
*2	3/4" O.D. GREEN
*3	1/4" O.D. BLACK
*4	3/8" O.D. GREY

**PREVOST**®

DESCRIPTION:  
 WE BUS SHELL  
 HALDEX AIR DRYER WITH OPTION MD13 VOLVO ENGINE

EFF. W/ VEH : #9-9620...  
 DATE: 2008/10  
 REV.: A

PAGE:  
 D140342 P6.1

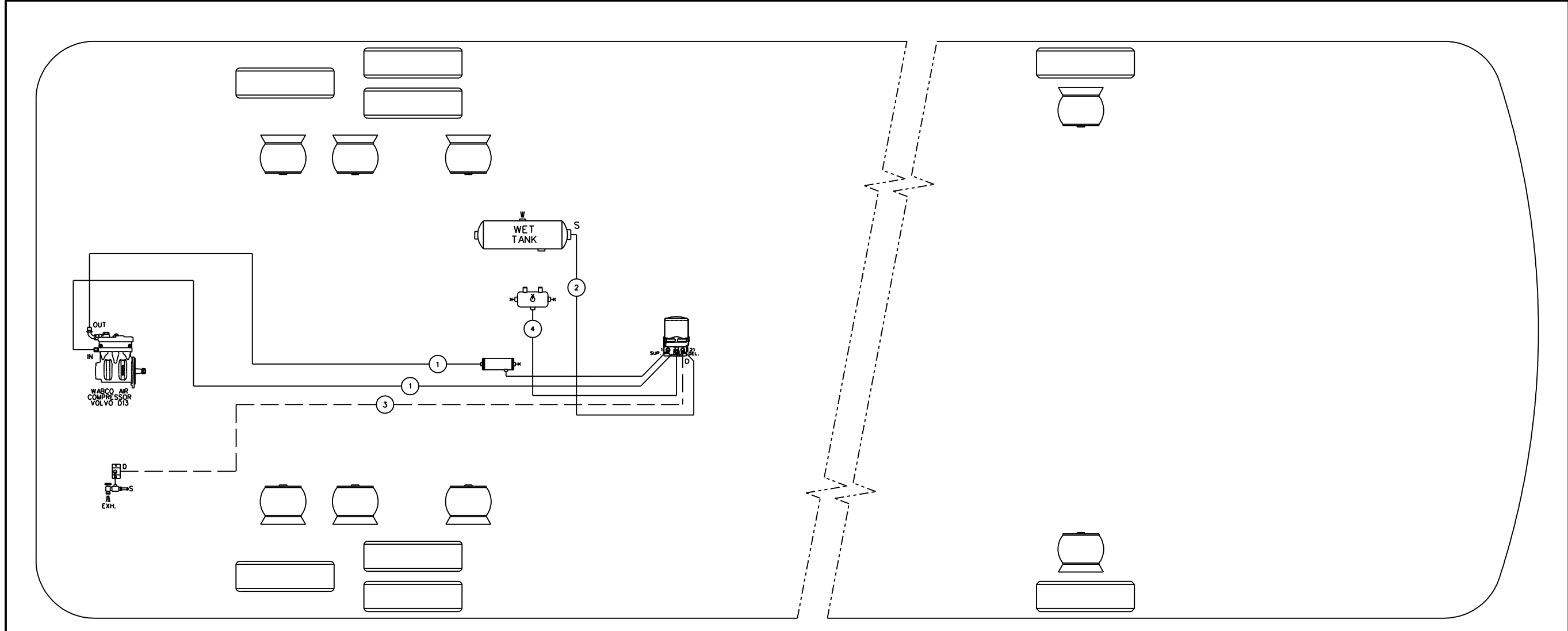

TUBE COLOR CODING	
ACTIVE COLOR	CIRCUIT
— GREEN	PRIMARY & SUPPLY
— BLACK	ACCESSORIES

BALLOON	PIPE
•1	HOSE ASS'Y
•2	3/4" O.D. GREEN
•3	1/4" O.D. BLACK
•4	3/8" O.D. GREY

**PREVOST**®

DESCRIPTION:  
 WE BUS SHELL  
 HALDEX AIR DRYER WITH OPTION MD13 VOLVO ENGINE

EFF. W/ VEH : #B-9954...  
 DATE: 2010/04 REV.: B

PAGE:  
 D140342 P6.1

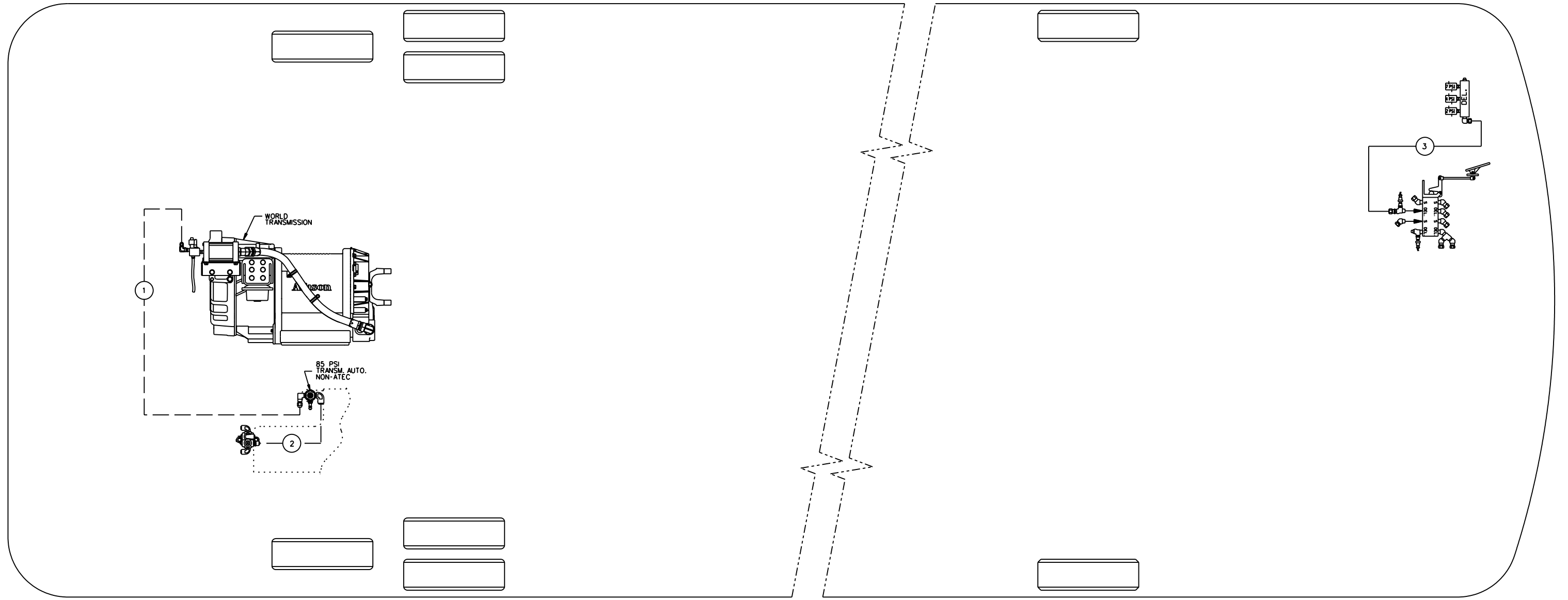

TUBE COLOR CODING		
ACTIVE	COLOR	CIRCUIT
---	BLACK	ACCESSORIES
---	GREEN	PRIMARY & SUPPLY

BALLOON	PIPE
*1	HOSE ASS'Y
*2	3/8" O.D. BLACK
*3	3/8" O.D. GREEN

**PREVOST®**

DESCRIPTION:  
 BUS SHELL WE COOLING 2007  
 WITH OUTPUT RETARDER ON WORLD TRANSMISSION

EFF. W/ VEH : #8-9279...  
 DATE: 2008/07  
 REV.: A

PAGE:  
 D140342 P7.1

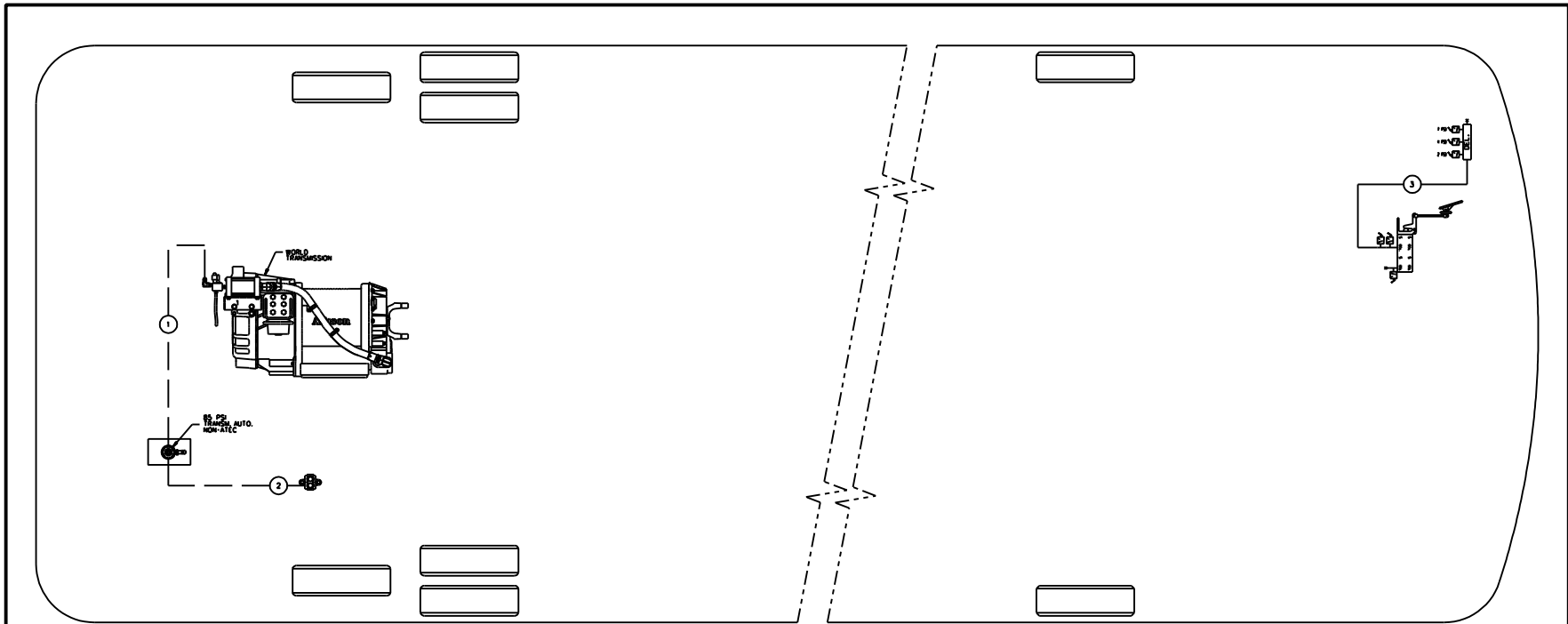

TUBE COLOR CODING	
ACTIVE COLOR	CIRCUIT
— BLACK	ACCESSORIES
— GREEN	PRIMARY & SUPPLY

BALLOON	PIPE
*1	HOSE ASS'Y
*2	1/4" O.D. BLACK
*3	3/8" O.D. GREEN

**PREVOST.**

DESCRIPTION:

BUS SHELL WE COOLING 2007  
WITH OUTPUT RETARDER ON WORLD TRANSMISSION

EFF. W/ VEH :

\*A-9952...

PAGE:

D140342 P7.1

DATE:

2010/04

REV.:

B



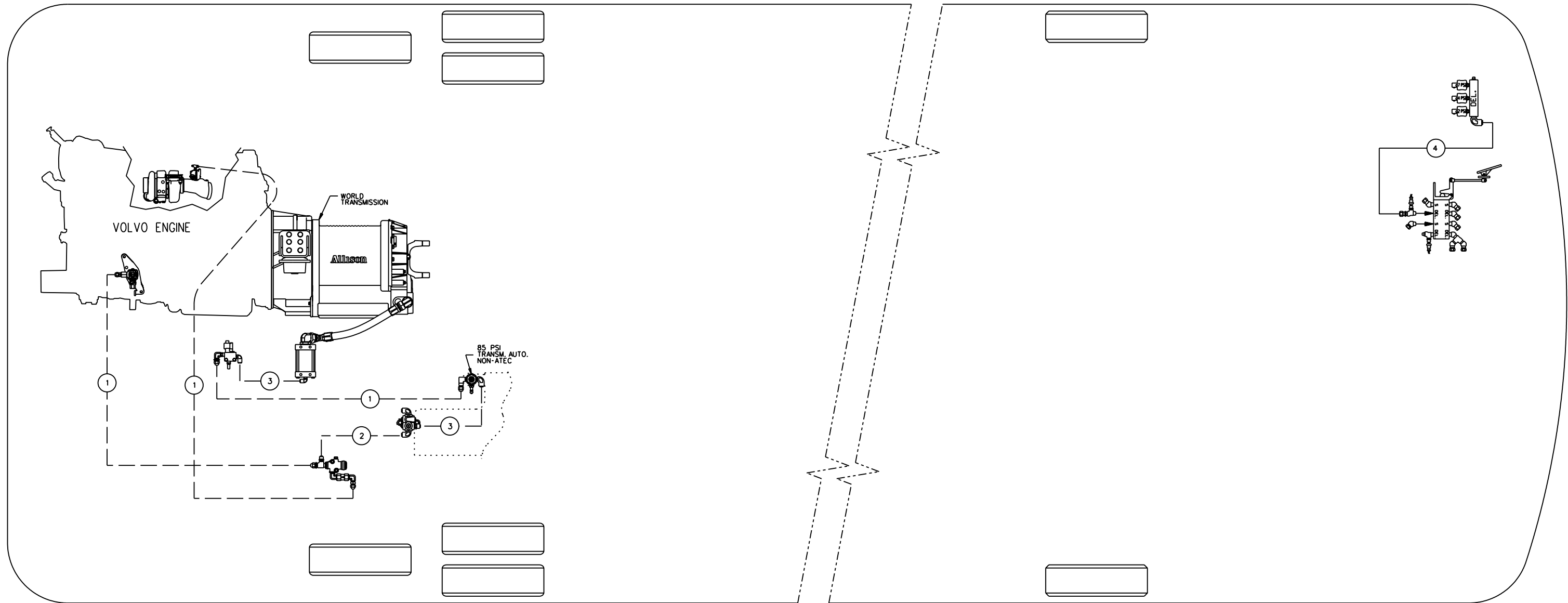

TUBE COLOR CODING		
ACTIVE	COLOR	CIRCUIT
---	BLACK	ACCESSORIES
---	GREEN	PRIMARY & SUPPLY

BALLOON	PIPE
*1	HOSE ASS'Y
*2	1/4" O.D. BLACK
*3	3/8" O.D. BLACK
*4	3/8" O.D. GREEN

**PREVOST**®

DESCRIPTION:

WE BUS SHELL  
WITH OPTION MD13 VOLVO ENGINE  
& OUTPUT RETARDER ON WORLD TRANSMISSION

EFF. W/ VEH : #9-9096...

DATE: 2008/06

REV.: A

PAGE:

D140342 P8.1

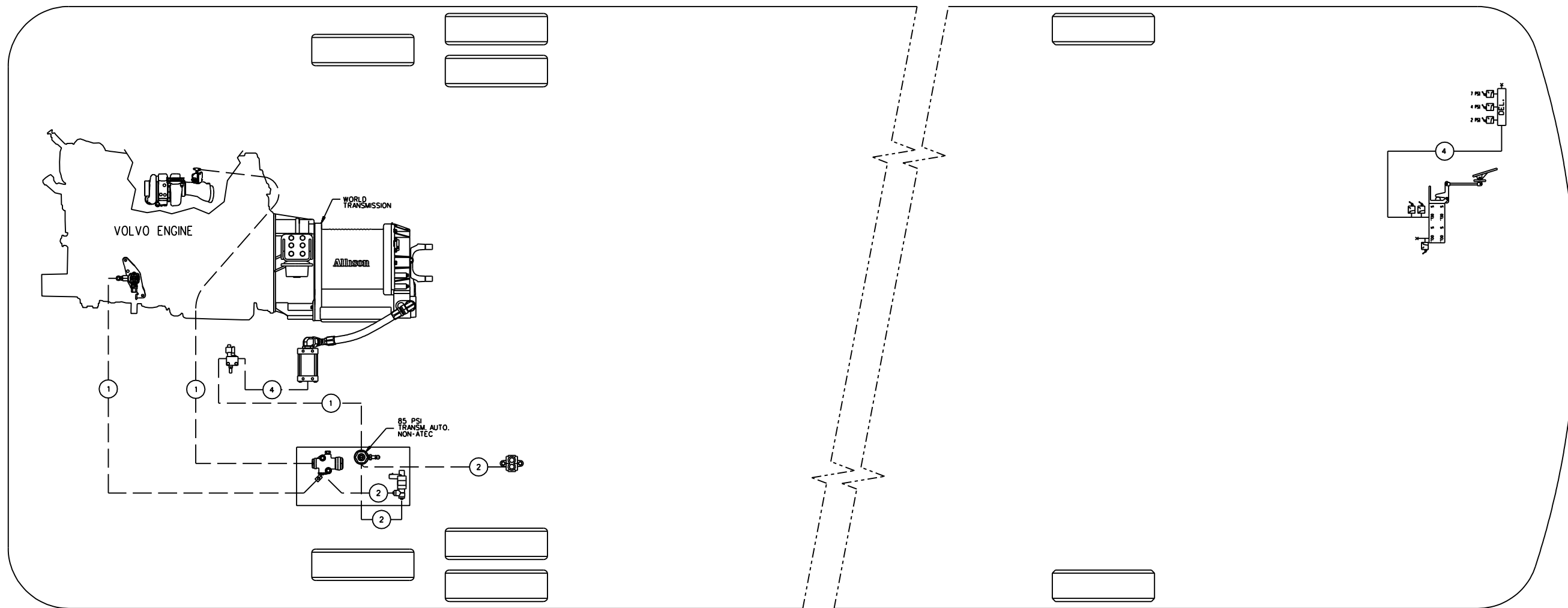

TUBE COLOR CODING		
ACTIVE	COLOR	CIRCUIT
---	BLACK	ACCESSORIES
---	GREEN	PRIMARY & SUPPLY

BALLOON	PIPE
*1	HOSE ASS'Y
*2	1/4" O.D. BLACK
*3	3/8" O.D. BLACK
*4	3/8" O.D. GREEN

**PREVOST®**

DESCRIPTION:

WE BUS SHELL  
WITH OPTION MD13 VOLVO ENGINE  
& OUTPUT RETARDER ON WORLD TRANSMISSION

EFF. W/ VEH :  
#A-9952...

DATE: 2010/04

REV.: B

PAGE:

D140342 P8.1

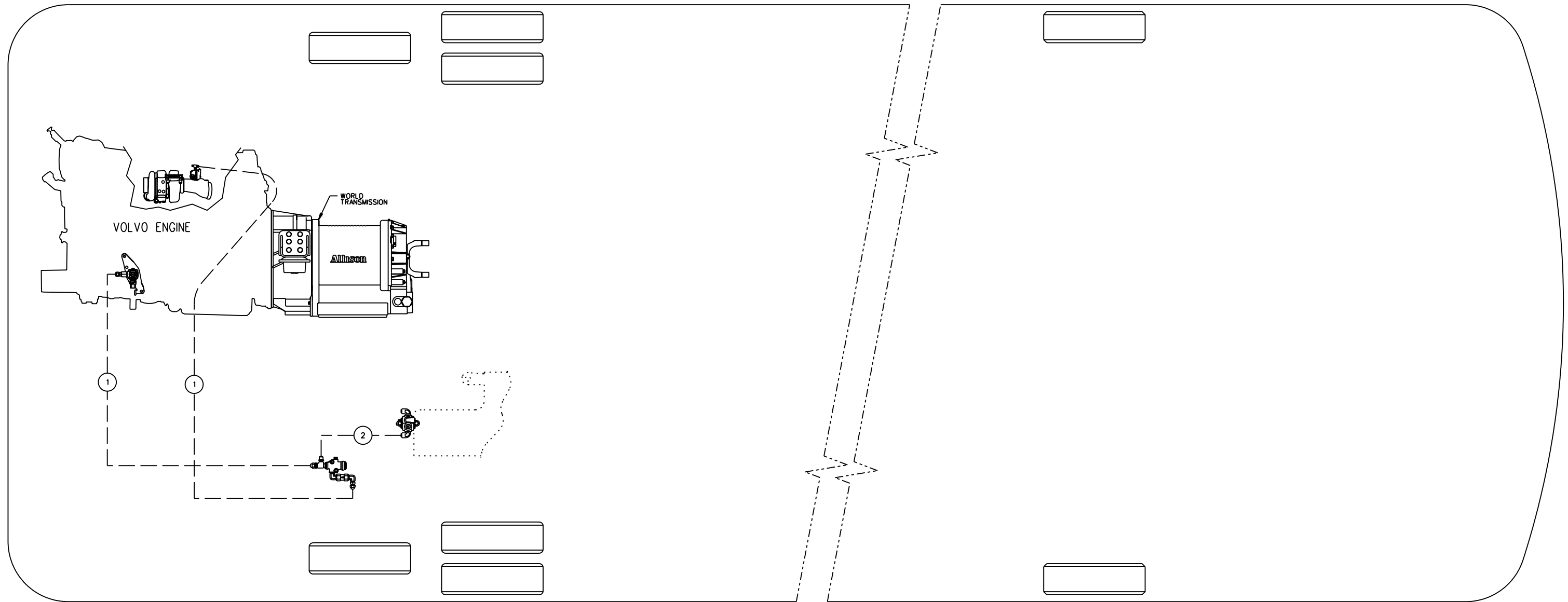

TUBE COLOR CODING		
ACTIVE	COLOR	CIRCUIT
---	BLACK	ACCESSORIES

BALLOON	PIPE
*1	HOSE ASS'Y
*2	1/4" O.D. BLACK

**PREVOST**®

DESCRIPTION: WE BUS SHELL  
 WITH OPTION MD13 VOLVO ENGINE  
 WITHOUT OUTPUT RETARDER ON WORLD TRANSMISSION

EFF. W/ VEH : #9-9096...  
 DATE: 2008/06  
 REV.: A

PAGE:  
 D140342 P9.1

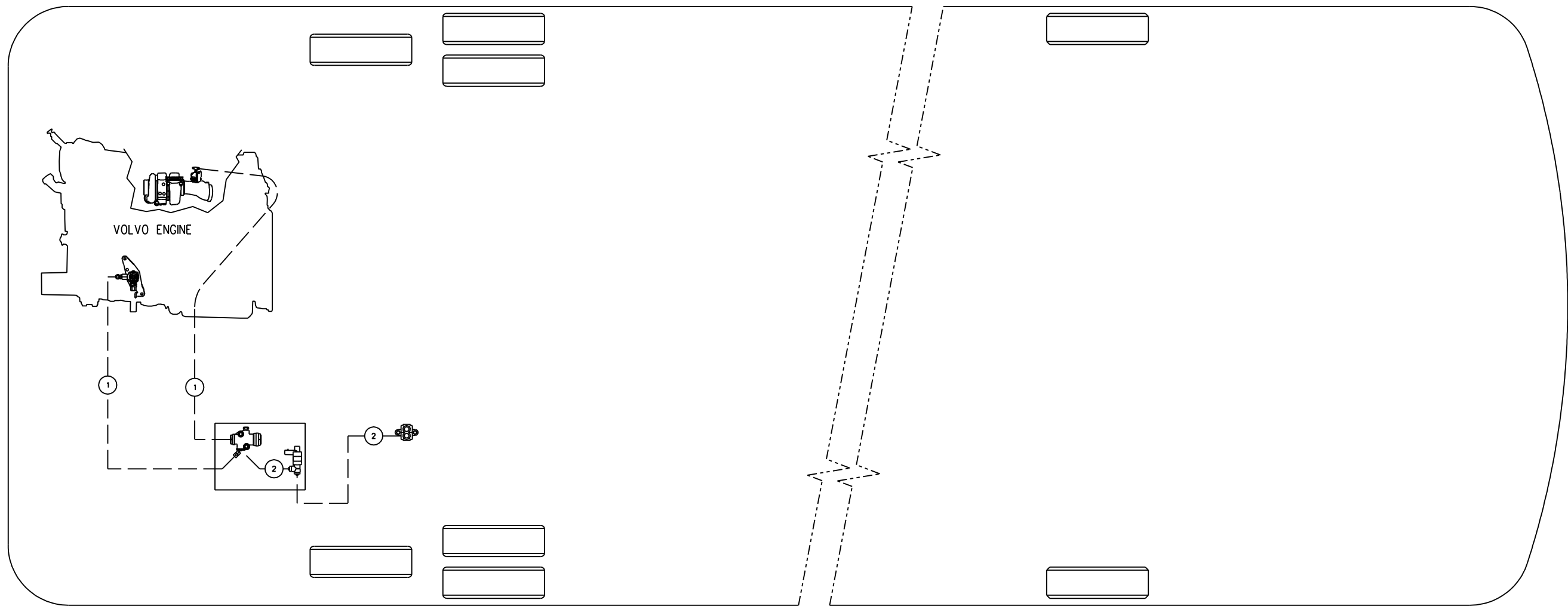

TUBE COLOR CODING	
ACTIVE	CIRCUIT
—	BLACK ACCESSORIES

BALLOON	PIPE
*1	HOSE ASS'Y
*2	1/4" O.D. BLACK

**PREVOST**®

DESCRIPTION: WE BUS SHELL  
WITH OPTION MD13 VOLVO ENGINE  
WITHOUT OUTPUT RETARDER ON WORLD TRANSMISSION

EFF. W/ VEH : #A-9952...  
DATE: 2010/04 REV.: B

PAGE: D140342 P9.1