

Driver's Handbook

Volvo 9700 US/CAN

B13R



VOLVO

Foreword

This manual contains information concerning the operation and function of the Volvo 9700 US/Can bus with version 2 of the multiplex electrical system. The information in this manual applies to vehicles complying with US10 Emission Standard. Please keep this manual in the vehicle at all times.

Note: Illustrations in this manual are used for reference only and may differ slightly from the actual vehicle. However, key components addressed in this document are represented as accurately as possible.

The National Highway Traffic Safety Administration (NHTSA) and Prevost should be informed immediately if you believe that the vehicle has a defect that could cause a crash, injury or death.

Contact NHTSA by calling the Auto Safety Hotline at 1 (888) 327-4236, by writing to NHTSA, U.S. Department of Transportation, Washington, DC 20590, by TTY at 1 (800) 424-9153, or visit their website at www.nhtsa.dot.gov.

Volvo Bus Corporation

Göteborg, Sweden

Order number: 89052801

©2013 Volvo Bus Corporation, Göteborg, Sweden

All rights reserved. No part of this publication may be reproduced, stored in retrieval system, or transmitted in any forms by any means, electronic, mechanical, photocopying, recording or otherwise, without the prior written permission of Volvo Bus Corporation

Contents

Introduction	1
Driver's Responsibility.....	1
Keys	2
Key and Cylinder Replacement	3
Entering the Bus.....	4
Main Power Switch.....	4
Emergency Stop.....	5
Protection Against Battery Discharge.....	5
Doors and Hatches	6
Doors.....	6
Opening from Inside	6
Closing.....	7
Hatches.....	8
9700 US/CAN (with Wheel Chair Lift).....	9
9700 US/CAN (without Wheel Chair Lift).....	10
Roof Hatches.....	11
Driver's Position	12
Driver's Position.....	12
Driver's Seat.....	13
Horn	13
Dashboard.....	14
Instruments and Controls	16
Faults and Warnings.....	16
Accelerator Pedal Deactivated.....	17
STOP Message.....	18
Warning Message.....	18
Stop at the next bus stop Message	18
Instrumentation	19
Types of Instruments.....	19
Instrument Panel Lamps and Symbols.....	26
Light Switch.....	28
Switches.....	30
Main Switch.....	30
Emergency Stop.....	31
Kneeling.....	32
Level Control	33
Increasing Load on the Driving Axle (trailing axle lift).....	34
Traction Control System (TCS).....	35
Differential Lock.....	36
Hill Start Assistance.....	36
Passenger Compartment Lighting.....	37
Night Lighting (Option).....	37
Half-Light	37

Driver Compartment Lighting	38
Passengers' Individual Lighting	38
Rear Door Lighting	39
Position Lights	39
Destination Sign Lighting (option)	39
Electrically heated rear—view mirrors	40
Driver's window heating	40
Driver's Blower	41
Central Locking	41
Sun Visor	41
Driver's Window	42
Activation of the Toilet	42
Audio System	42
Opening the Doors from the Outside	43
Wheelchair Lift System (Option)	43
Emergency Window in use Indicator Lamp	44
Wheelchair Lift System Indicator Lights	44
Switches in the Electrical Center	45
Controls	46
Starting Switch	46
Adjusting External Rear-view Mirrors	47
Open Door Brake	48
Steering Wheel Adjustment	49
Directional indicator, Dipped/full beam changer	50
Windscreen Wipers, Windscreen/headlight Washer	51
Transmission	52
Transmission, I-Shift Lever Selector.	52
Transmission, I-Shift Pad Selector.	52
Retarder	53
Retarder Overheating	54
Transmission Overheating	55
Brakes	56
Parking Brake	56
Blocking Valve	57
Service Brakes	58
A/C Controller	61
Destination Sign Control (Option)	62
Interior Equipment	63
Interior Equipment	63
Toilet	64
Passenger's Clock Display	64
Passengers Panel	65
Lighting Stripe LED	65
Passenger's AC 110 V Power Outlets	66
Passenger's AC 110 V Power Outlets Circuit Braker	66

Audiovisual System.....	67
Audiovisual System	67
Audiovisual Controller.....	68
Video System	68
Audio System.....	68
Emergency and Safety Equipment.....	69
Overview.....	69
Fire Extinguisher.....	69
Automatic Fire Suppression System.....	70
Manual Discharge	71
Warning Triangle	72
First-aid Kit.....	72
Tire Pressure Monitoring System	73
Tire Pressure Monitoring System (TPMS) Display.....	74
Tire Inflation Valve	75
External Air Supply Connection	75
Jack	76
Toolbox	77
Engine Control Box in Engine Bay	78
Emergency Exits	79
Doors.....	79
Ceiling, Roof Hatches.....	79
Emergency Windows	80
Starting and Driving	81
Checking Before Driving.....	81
Checking Warning Lights	82
Daily Inspection.....	82
Engine	82
Steering Servo/Hydraulic Fan.....	83
Coolant.....	83
Washer Fluid	83
Refuelling.....	84
Diesel Exhaust Fluid (DEF) Tank.....	85
Engine Block Heater	86
Starting the Engine.....	87
Starting.....	87
Checks After the Engine Has Been Started.....	88
Idling (programming).....	89
Cruise Control.....	90
Retarder.....	91
Power Steering.....	95
Aftertreatment DPF with vertical SCR.....	96
Exhaust Aftertreatment System	97
DPF Regeneration Required Icon.....	98

High Exhaust System Temperature.....	99
Some Advice for Driving	100
Safe Driving.....	100
Economy Driving.....	101
Driving in Cold Weather.....	102
If Something Happens	103
Safety.....	103
If the Engine is Not Working.....	104
Punctures.....	104
Punctured Air Springs.....	104
Towing.....	105
Second Fire Detection Circuit.....	106
Releasing the Parking Brake.....	107
Release the Parking Brake with Air from the Bus Tires.....	107
Mechanical Releasing of the Parking Brake.....	108
Regarding Disc Brakes.....	109
Changing the Batteries.....	110
Starting Assistance.....	111
Battery Cut-off Switch.....	111
Bulb Replacement.....	113
Headlamps.....	113
Rear Lights.....	113
Xenon Lights.....	114
Licence Plate Lighting.....	114
Fuses and Relays (chassis).....	115
Relays.....	116
Fuses.....	117
Fuses and relays (body).....	120
Relays.....	120
Fuses.....	121
Technical Data.....	123
Technical Specification.....	123
Bulbs.....	124
Type Plates.....	125
Identification Plate.....	125
Vehicle Identification (VIN).....	126
Engine.....	126
Transmission.....	126
Rear Axle.....	126
Retarder.....	126
Service Intervals.....	127

Safety Information

IMPORTANT: Before driving this vehicle, be certain that you have read and that you fully understand each and every step of the driving and handling information in this manual. Be certain that you fully understand and follow all safety warnings.

IT IS IMPORTANT THAT THE FOLLOWING INFORMATION BE READ, UNDERSTOOD AND ALWAYS FOLLOWED.

The following types of advisories are used throughout this manual:



DANGER

Danger indicates an unsafe practice that could result in serious personal injury or death. A danger advisory banner is in **white** type on a **black** background with a **black** border.



WARNING

Warning indicates an unsafe practice that could result in personal injury. A warning advisory banner is in **black** type on a **gray** background with a **black** border.



CAUTION

Caution indicates an unsafe practice that could result in damage to the product. A caution advisory is in **black** type on a **white** background with a **black** border.

Note: Note indicates a procedure, practice, or condition that must be followed in order for the vehicle or component to function in the manner intended.

Driver's Responsibility

- As the driver, you are responsible for the safety and comfort of the passengers during the journey. Therefore, do not drive the bus before you have read this driver's manual. You must be familiar with all the indicators and warning lights and know what to do if something unexpected happens.
- As the driver of the vehicle, you should be aware of the vehicle weight and loading capacity. See instructions on warning stickers, the vehicle registration book and on the identification plate.
- As the driver of the vehicle, it is your responsibility to foresee any hazards that could threaten your passengers.
- It is also your responsibility to ensure that all the safety equipment of the bus is in place. Therefore check regularly the working order of safety belts, emergency door and window opening, door sensitive edges, fire extinguishers and first aid equipment.
- The brakes on the bus are operated by compressed air. Never drive if the air pressure is too low or if you discover other problems with the brakes.
- Pay attention to any steering faults. The vehicle can be steered even if the power steering is not working, although the steering will be heavy.
- Never crawl under the bus if it is supported by a jack. Use approved vehicle supports or a solid pallet in case of punctures or wheel changes.
- Lifting devices and supports should stand securely on a horizontal surface. The wheels that are not to be lifted should be blocked to ensure that the vehicle will not start to move.
- Re-tighten the wheel nuts after approximately 200 km (125 mi) if the wheels have been removed.
- Tighten the wheel nuts every 6 months regardless of whether the wheels have been removed or not.
- Follow the recommended service and maintenance program to maintain the bus's condition and safety.
- Pay attention to exhaust and fuel smells. Any leaks should be taken care of immediately at the garage.
- The bus tires and rims should be approved for the intended load and speed in accordance with current legal requirements.

2 Introduction

Keys

The following keys are delivered with the bus:

- 1 Ignition
- 2 Exterior and Interior Hatches
- 3 Engine RH Side Access Door, Radiator Door

There may be alternative versions of the keys, depending on the types of locks that are fitted.

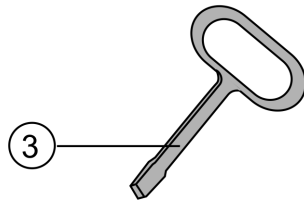
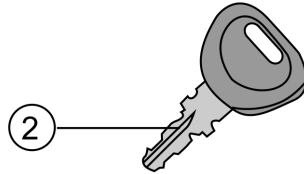
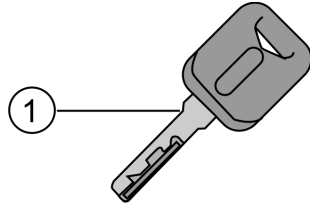

W0077796

Note: Note the number of the ignition key to facilitate ordering of spare keys.

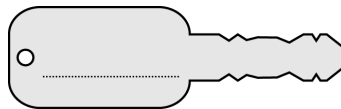

T0013333

Key and Cylinder Replacement

Key and Cylinder Replacement

Key and Cylinder Replacement	
Location	Part Number
Exterior and Interior hatches	(*) 70348099 (cylinder) 70364098 (key).
Ignition	8159908 (1 ignition lock + switch, 2 door locks, 2 keys)
Engine RH Side Access Door, Radiator Door	70319047

(*) Both parts (Cylinder and Key) must be ordered.

4 Introduction

Entering the Bus

To open the front door:

- turn the key in the lock to the horizontal position
- turn the knob to the vertical position
- push the pneumatic door opening button

The button for the pneumatic opening of the first door is placed in the door handle.

Note: In case of total or partial emptying of the door pneumatic system, open the door by pushing the right side of the door.

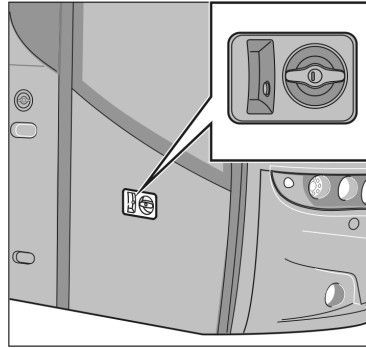

T8012405

Main Power Switch

Is located on the dashboard. Always turn off the power supply with the main switch before leaving the bus.

Note: Never turn off the main switch while the engine is running.

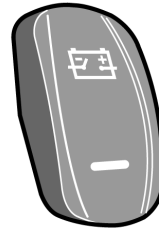

T0012043

Emergency Stop

An emergency switch is located on the left side of the dashboard. Depending on the market specification, the emergency switch may disconnect the bus electrical power supply, cut off the fuel supply and activate the hazard warning lights.

Note: Only use the emergency cut out in an emergency situation.

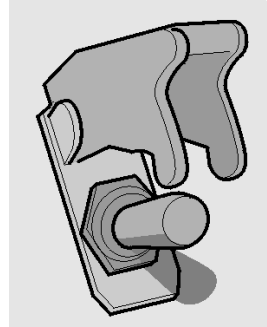

T0009170

Protection Against Battery Discharge

In order to prevent battery discharge while the bus is standing, the Volvo 9700 bus is equipped with a function that disconnects the supply to major electrical consumers such as: electric heaters, some external lighting, etc. Power to these consumers is switched off around 30 seconds after the engine is shut down, and it is then switched back on once the engine is started and its revolutions reach at least 1000 rpm for 10 seconds.

6 Doors and Hatches

Doors

The Volvo 9700 bus is equipped with one single-leaf door opening outwards. The door is normally operated by pneumatic cylinders.

The door may be equipped with a system protecting passengers from being trapped in the doorway during opening or closing, this system has sensors measuring the air pressure in the door system.

Note: In the case of excessive drop of the door pneumatic system air pressure, the “Door failure” warning lamp lights in the lower right corner of the bus instrument cluster.



T001200
8

Opening from Inside

There is a button for door opening on the right hand side of the driver's dashboard. Pushing the button causes the door to open. The button indicator lamp is lit when the door is open.

Note: Before closing the door ensure that there are no passengers standing in the doorway.

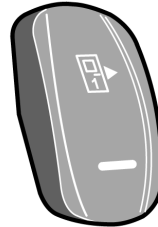

T3018176

Closing

Proceed as follows:

- 1 Select neutral position on the gear selector.
- 2 Engage the parking brake
- 3 Turn on the switch that activates the door opening push-button in the door handle
- 4 Open the door
- 5 Turn off the power supply with the main switch
- 6 Leave the bus and close the door using the push-button in the door handle
- 7 Lock the door with the key

Note: After locking the door with the key, the push-button in the door handle becomes inactive.

After turning off the power supply with the main power switch, the light above the entrance door remains on for about 90 seconds.

If the button activating the button in the handle for opening the door **is not switched on**, in order to enter the bus again, the emergency valve must be used.

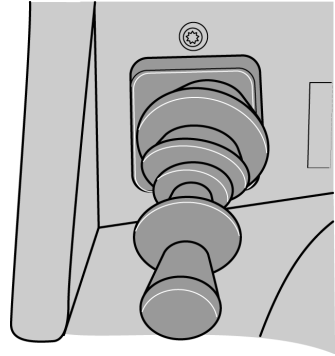

T5014881

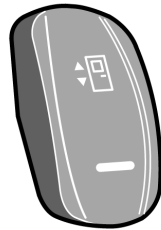

T1008555

Button for outside opening of the door

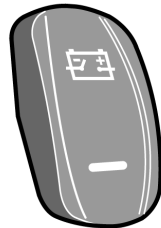

T0012043

8 Doors and Hatches

Hatches

If any of the bus hatches are open or not properly closed, a “hatch open” symbol will appear on the instrument panel display.

Note: The engine cannot be started unless the engine hatch is closed.

Note: With the engine hatch open, the engine can be started by means of a button in the control box. See: “Engine Control Box in Engine Bay”, page 78



T3018116

The configuration of the service and luggage compartment hatches depends on the bus variant. Possible variants are shown below. The description refers to items located behind the hatch.

9700 US/CAN (with Wheel Chair Lift)

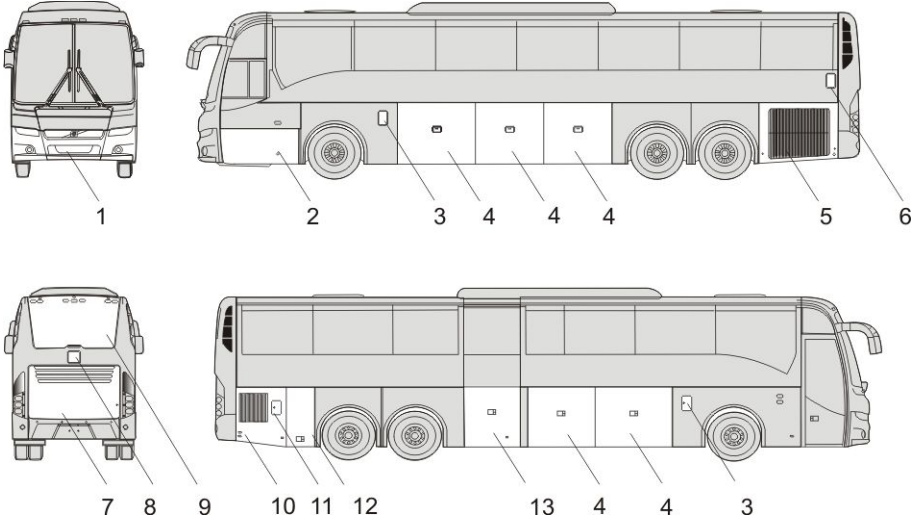

T8061040

- | | |
|---|---------------------|
| 1 External Air Valve, Towing Point, Spare Wheel | 7 Engine |
| 2 Battery Box, Battery Cut-off Switch, Main Fuses, Washer Fluid Reservoir | 8 Coolant Filler |
| 3 Fuel Filler | 9 SCR |
| 4 Luggage Compartment Hatch | 10 Auxiliary Heater |
| 5 Radiator | 11 DEF Filler |
| 6 Urea Injector Service Access | 12 Waste Tank |
| | 13 Wheel Chair Lift |

10 Doors and Hatches

9700 US/CAN (without Wheel Chair Lift)

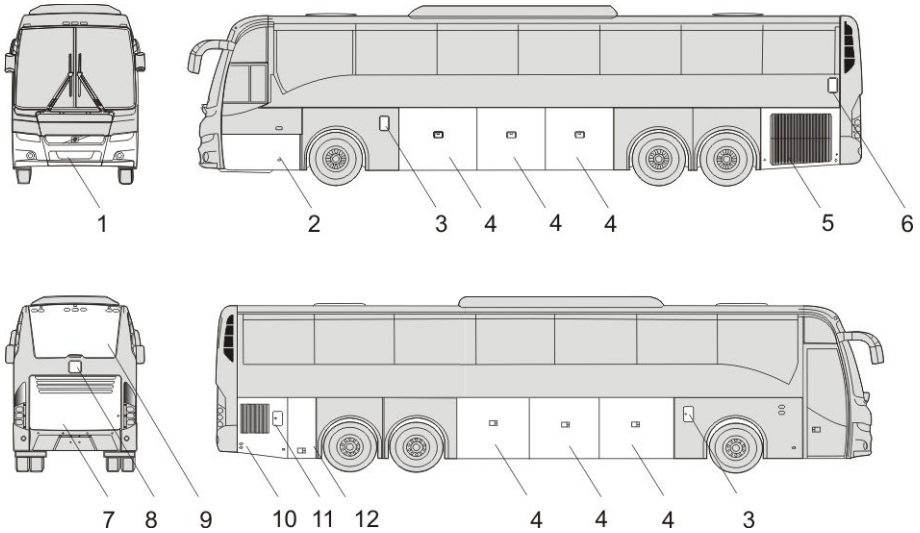

T8061041

- | | |
|---|---------------------------------------|
| 1 External Air Valve, Towing Point, Spare Wheel | 7 Engine |
| 2 Battery Box, Battery Cut-off Switch, Main Fuses, Washer Fluid Reservoir | 8 Coolant Filler |
| 3 Fuel Filler | 9 Selective Catalytic Reduction (SCR) |
| 4 Luggage Compartment | 10 Auxiliary Heater |
| 5 Radiator | 11 Diesel Exhaust Fluid (DEF) Filler |
| 6 Urea Injector Service Access | 12 Waste Tank |

Roof Hatches

The Volvo 9700 bus is equipped with roof hatches manually operated. Manually operated hatches are opened by the handles on each side of the hatch.

For more information see separated instructions “Manual Roof Hatch”

Note: When the A/C is activated in the bus its hatches should be closed, since the air coming in from outside may interfere with the operation of the equipment controlling the temperature inside the bus.

Note: Make sure that the hatches are closed when it's raining and when you leave the bus for a longer period of time.

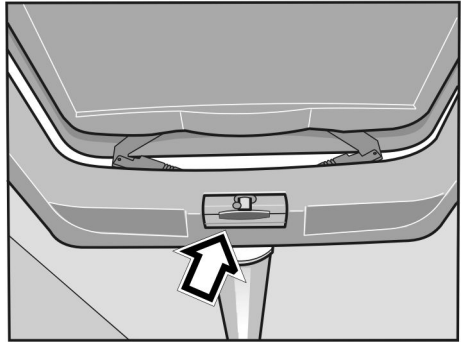

T8010110

12 Driver's Position

Driver's Position

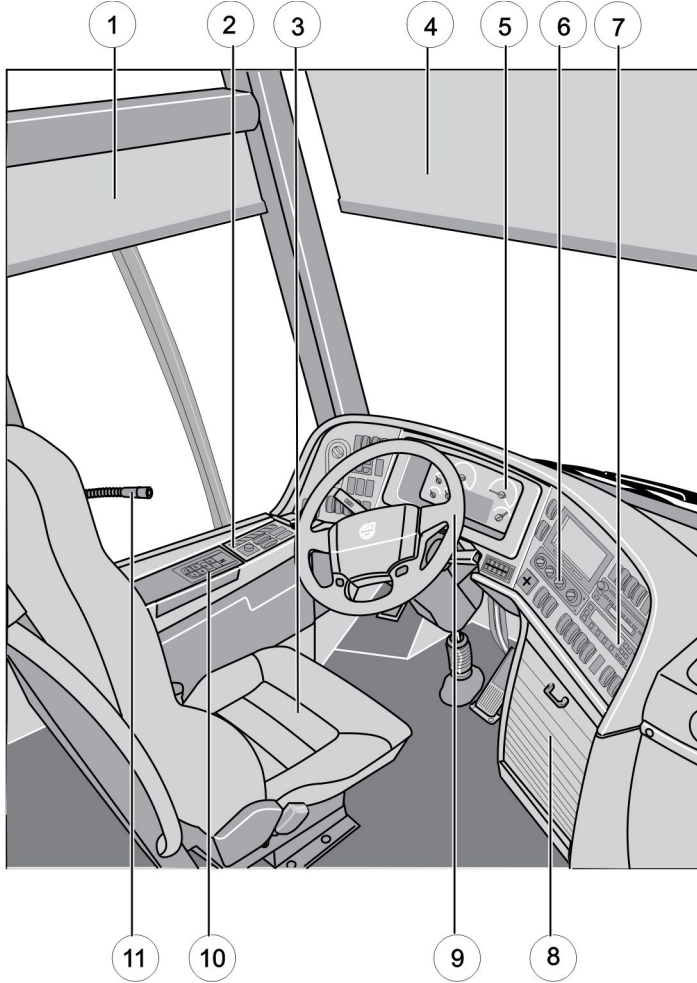

W8081291

- | | |
|---------------------------------|-----------------------------------|
| 1 Side Sun Visor | 7 Controllers, Audiovisual System |
| 2 Side Panel | 8 Locker, Audio Equipment |
| 3 Driver's Seat | 9 Steering Wheel |
| 4 Front Sun Visor | 10 Gear Selector |
| 5 Dashboard, Instrument Cluster | 11 Driver's Microphone |
| 6 Controller, AC | |

Driver's Seat

The Volvo 9700US/CAN bus is equipped with driver's seat type National. For more information see separated instructions "Driver's Seat".



DANGER

Adjusting seat position or fastening a seat belt should only be performed when the vehicle is stationary. Attempting this while the vehicle is moving may lead to an accident, causing serious personal injury or death.

Note: The safety belt should not be twisted or blocked when properly fastened.

Note: Before adjusting, check whether there are any objects in front of the seat or behind it, that could hinder adjustment.

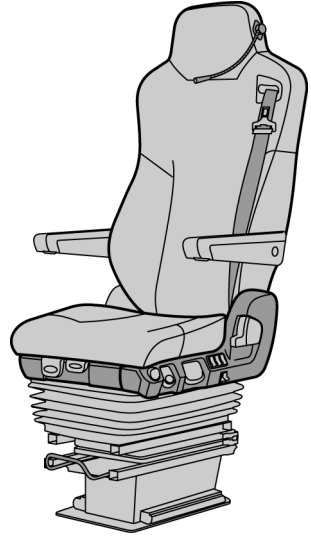

T8010545

Horn

The Volvo 9700US/CAN bus is equipped with one electrical horn (diaphragm) and one operated by compressed air. Pushing the central part of the steering wheel activates the electrical horn, while pushing one of the two small buttons beneath activates the air horn.

Note: Remember that the use of horns is subject to regulations.

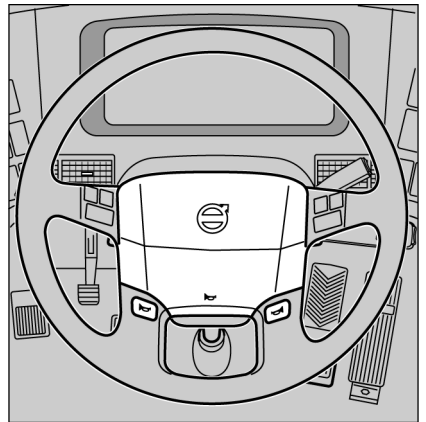

T6010187

14 Driver's Position

Dashboard

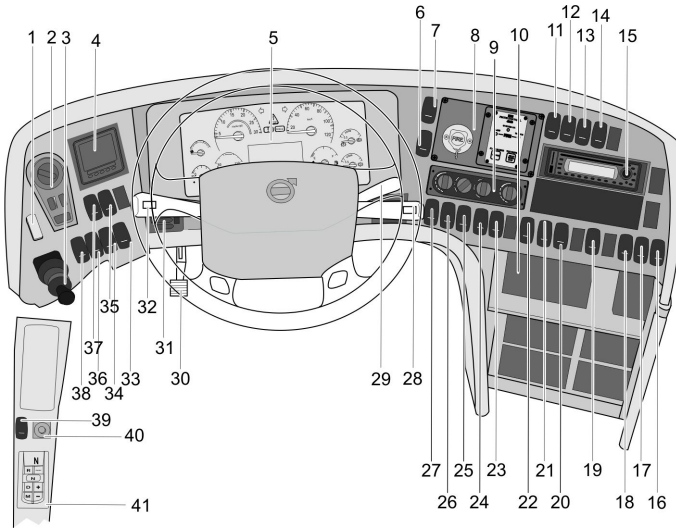

W8081292

- | | |
|---|---|
| 1 Emergency Stop Switch | 18 Spare |
| 2 Light Switch | 19 Central Lock |
| 3 Parking Brake | 20 Driver's Microphone enabled |
| 4 Tire Monitoring System | 21 Position Lights |
| 5 Instrument Cluster | 22 Service First Door |
| 6 Delay Automatic Fire Suppression System | 23 Door Lock |
| 7 Emergency Windows Open Warning | 24 Night Light Under Seats |
| 8 Automatic Fire Suppression System | 25 Interior Lights |
| 9 AC controller | 26 Reading Light |
| 10 Spare | 27 Night Light |
| 11 Light for Driver's Position | 28 Display Control Stalk, Wipers and Washers Control Stalk |
| 12 Front Sun Visor | 29 Retarder |
| 13 Wheel Chair Lift System Enable and Door Ajar | 30 Steering Wheel Adjustment Pedal |
| 14 Wheel Chair Lift Main Switch | 31 Air Inlet |
| 15 Audio and Video System | 32 Control Stalk at the Steering Wheel, Direction Indicators and Cruise Control |
| 16 Toilet Activation | 33 Traction Control System |
| 17 Driver's fan | |

34 Hill Start Auxiliary

35 Bogie

36 Bus Level

37 Kneeling

38 Main Switch

39 Mirror Heater

40 Mirror Adjustment

41 I-Shift Selector Pad

16 Instruments and Controls

Faults and Warnings

There are three different types of signals that give the driver all the necessary information on the vehicle:

- STOP message
- Warning message
- Stop at the next bus stop message

Above the display there are three lamps (for stop at the next bus stop, warning and STOP messages), that alert the driver's attention when necessary.

Messages with appropriate symbols are shown automatically on the display.

Several messages can be active simultaneously. A new message will only replace the current message on the display if it is of higher priority. This means that the display always shows the message with the highest priority.

For more detailed information about display functions, see the separate Operating Instruction "Display".

Accelerator Pedal Deactivated

The bus is fitted with prioritized brake function.

This function deactivates a request for acceleration if **both** the accelerator pedal and the foot brake pedal or parking brake have been activated simultaneously.

The accelerator pedal remains deactivated until it is reset, which occurs once the pedal has been fully released.

For additional information on this function, see the separate Operating Instruction “Display”.



T0013511

18 Instruments and Controls

STOP Message



If this lamp lights while driving, stop the bus immediately and turn off the engine. Continuing to drive may severely endanger the vehicle, the driver and/or passengers.

Note: If the STOP message appears while the engine is running, it is accompanied by activation of the audible warning buzzer.



T3014364

Warning Message

If this lamp lights, the vehicle must be taken to a workshop for repair as soon as possible. There is no immediate danger of the vehicle breaking down, and under normal circumstances it should be possible to complete the journey. This lamp is also used to draw the driver's attention to problems other than vehicle failures, e.g. as a warning in the case of an open luggage compartment hatch.



T3014365

Stop at the next bus stop Message

Simultaneously with this lamp lighting up, a new message is shown on the display. The fact that this lamp lights up does not mean that there is something wrong with the vehicle. This lamp may for example illuminate to draw the driver's attention to low fuel level.

Acknowledge the message with **ESC** key. If the information message is still activate, it will be shown again next time the starter key is turned to the starting position.



W3079585

Instrumentation

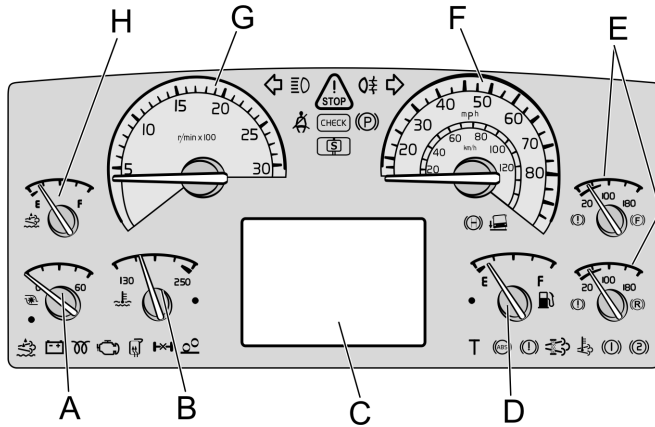

W3081293

Types of Instruments

- A Turbo Pressure Gauge
- B Coolant Temperature Gauge
- C For the display, see the separate Operating Instruction “Display”
- D Fuel Gauge
- E Air Pressure Gauge for Brakes
- F Speedometer
- G Tachometer
- H Diesel Exhaust Fluid Gauge

20 Instruments and Controls

Turbo Pressure Gauge (A)

The turbo pressure gauge indicates the pressure in the intake manifold. A high turbo pressure increases fuel consumption. This gauge helps you drive in the most economical manner. When driving on level roads at constant speed, the pointer should remain still within the green zone.

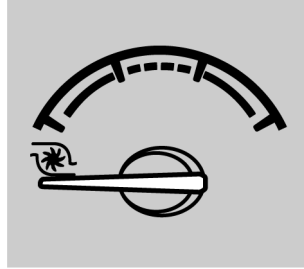

T0011983

Engine Coolant Temperature Gauge (B)

This gauge indicates the temperature in the engine's coolant system. Under normal driving conditions, the pointer should stay just below the red zone (normal operating temperature is between 80°C (176°F) and 100°C (212°F)).

The engine is fitted with overheating protection, that reduces the engine power output to 50% if the temperature reaches the red zone. The bus can still be driven even after activation of the overheating protection.



CAUTION

The bus must not be driven if the temperature rises even higher as this can result in damage to the engine.

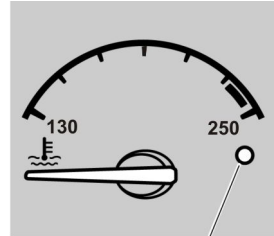

1

T0015289

1 Warning lamp, red

An indicator signals when the cooling system temperature is too high.

- warning lamp (1) lights
- STOP– lamp lights
- the acoustic signal sounds (if the engine is running)

22 Instruments and Controls

Display (C)

The display consists of the main menu and several submenus with their relevant functions. For additional information, see the separate Operating Instruction “Display”.

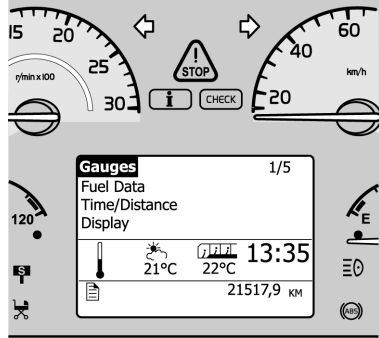

T0012082

Fuel Gauge (D)

The Fuel Gauge shows the amount of fuel in the tank. The red zone and the warning lamp (1) give a warning of low fuel level.

The display gives considerable information on the fuel situation, i.e. fuel consumption, A to B information and remaining fuel. For more information, see separate driver instructions “Display”.

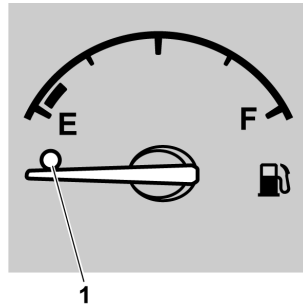

T0011986

Air Pressure Gauge for Brakes (E)



DANGER

Stop the bus immediately if any of the warning lamps illuminate! A warning lamp will illuminate if there is an excessive pressure drop in the braking system. Investigate the cause of the fall in pressure. Failure to do so may result in failure of the vehicles brakes that may cause an accident, leading to serious personal injury or death.

If the engine remains switched off for a long time, the compressed air pressure may fall to a level which will prevent the bus being started immediately. The warning lamp remains lit until the pressure in the braking system rises to a sufficiently high level. If the compressed air in the braking system has been completely exhausted, it may take quite a long time before the pressure starts to rise.

During driving, the gauge pointer should remain within the green zone, but it can temporarily drop below that zone during braking.

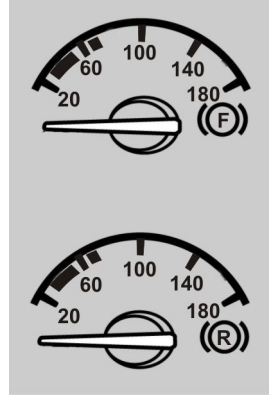

T0015292

- F. Air Pressure, front brake circuit
- R. Air pressure, rear brake circuit

24 Instruments and Controls

Speedometer (F)

The speedometer indicates the speed of the bus in mph. For some markets, speedometers are also available that indicate speed both in mph and km/h.

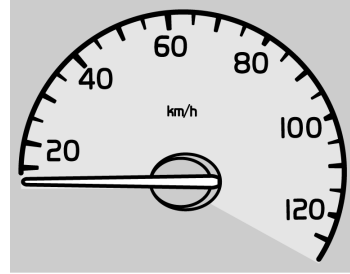

T0011985

Tachometer (G)

The tachometer scale is divided into three zones. During normal driving you should stay within the green zone, which gives the best fuel economy.

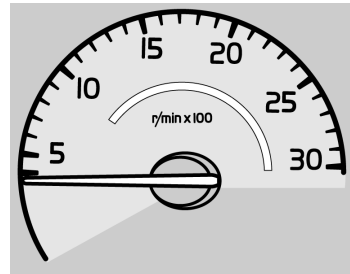

T0011984



CAUTION

Avoid operating the vehicle with the tachometer in the red zone. Such high engine speeds can result in damage to the engine and the transmission.

Diesel Exhaust Fluid Gauge (H)

The Diesel Exhaust Fluid (DEF) gauge shows the amount of DEF in the tank. The red zone and warning lamp (1) give a warning of low DEF level.

The following will be indicate if the DEF level drops too low

- If level is equal or less than about 12% tank volume the dash lamp will light constantly, it warns drivers to fill the tank;
- If the warning was ignored and the gauge reads empty, the dash lamp starts flashing and the engine will experience a 25% torque reduction
- If driver continues to ignore warnings and the bus becomes stationary, the bus speed will be limited to 5 mph.

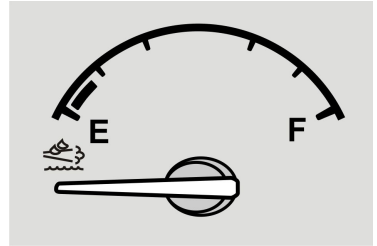

T0061352



T8061207





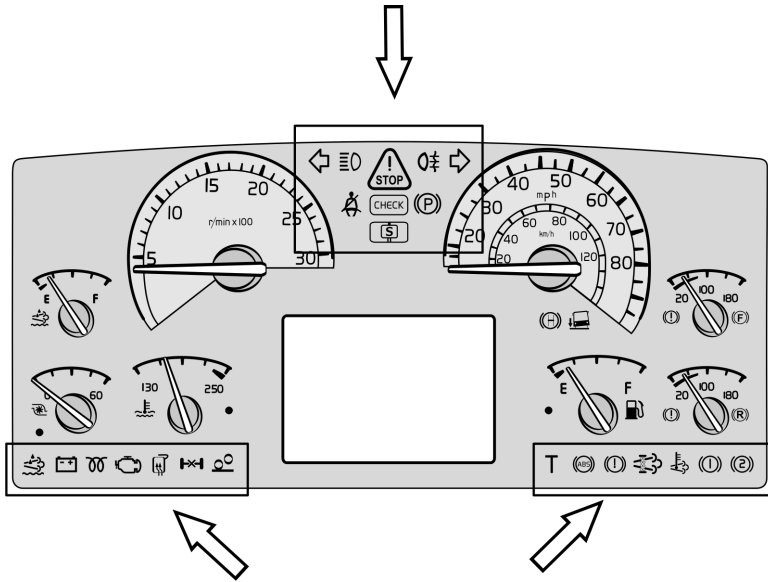











26 Instruments and Controls

Instrument Panel Lamps and Symbols



W3081294

Symbol	Meaning	Symbol	Meaning
	Left indicator ON		Main beam
	If there is a problem with the bus you must stop.		Fog Light Rear
	Right indicator ON		Safety belt reminder
	Check		Parking brake applied

	Stop at the next bus stop		
	Hill Start Assistance		Kneeling activated (for easier access)
 <p style="font-size: small;">T8061207</p>	DEF Low Level		Battery not charging
	Pre-heating ON		OBD – On-Board Diagnostics
	Screen / mirrors heating activated		Differential lock activated
	The switch for increasing load on the drive axle (bogie lift) of the bogie is on		
	Tachograph event		ABS not functioning
	Brake Air Pressure Low	 <p style="font-size: x-small;">T00154 82</p>	DPF Regeneration Required
 <p style="font-size: x-small;">T00154 83</p>	High Exhaust System Temperature (HEST)		Brake Air Pressure Circuit 1
	Brake Air Pressure Circuit 1		

28 Instruments and Controls

Light Switch

- a Lights OFF or automatic activation of Dipped Beam
- b Parking Lights
- c Dipped Beam
- d Auxiliary Spotlights
- 1 Lighting Switch
Pressing the switch turns the front fog lights on and off. Pulling it turns the rear fog lights on and off.
- 2 Indication (Repeater) Lamp, Front Fog Light
- 3 Indicator Light, Fog Light, Rear
- 4 Instrument Lighting Rheostat
- 5 Hazard Warning Lights

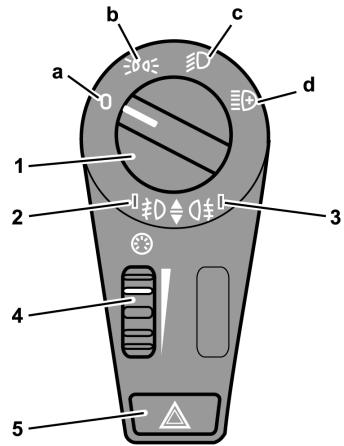

T0012036

Hazard Warning Lights

Pressing this switch in will turn on all the bus hazard warning lights (both sets of direction indicators). The hazard warning lights will work even if both the ignition and power supply are turned off (with the main power switch).

 **DANGER**

Use the hazard warning lights if the bus is stopped in a manner that may put other road users at risk. Failure to do so may lead to an accident, resulting in serious personal injury or death.

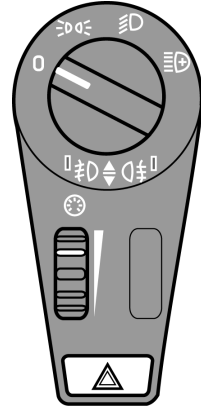

T0014325

Two upper lights (A) works as direction indicators and hazard warning lights

When exterior lights switch is at ON position, five upper rear lamps (B) turns on.

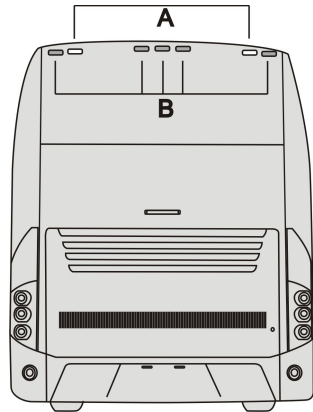

T8061317

30 Instruments and Controls

Switches

The number of switches depends on the bus specification.

Main Switch

The bus is equipped with a main power switch. By switching off the main power before leaving the bus, all the major electrical consumers are switched off, which helps to preserve sufficient battery capacity to enable subsequent bus starting. The main switch does not cut off the power supply to the clocks and auxiliary heater.

Note: Never turn off the main switch while the engine is running.

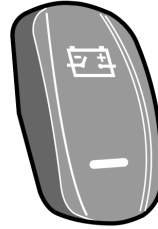

T0012043

Emergency Stop

Note: Only use the emergency cut out in an emergency situation; to switch off the electrical feed in normal conditions use only the main switch.

When the emergency stop is activated the following occurs (can vary from country to country):

- air is exhausted from the door system
- engine is stopped
- power supply to the main electrical consumers is cut off
- fuel supply to the engine is cut off and so is outflow of fuel from the tanks
- hazard lights are switched on
- lights above the doors are switched on

Activate the emergency cut out by lifting the cover upwards and pressing up the switch. When the cover is closed the power switch automatically is pressed down to the disconnected position.

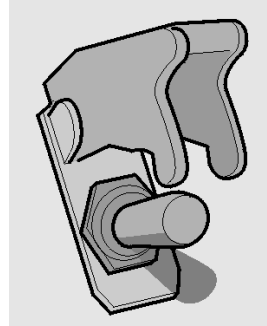

T0009170

32 Instruments and Controls

Kneeling

This switch allows the right-hand side of the bus to be lowered (kneeling) to a level that facilitates passenger entry and exit.

There are two possible operating modes for the kneeling switch:

- 1 The bus lowers while the kneeling switch is depressed. After reaching the lowest level, i.e. entry/exit level, kneeling stops and the switch can be released. Releasing the switch prior to reaching the lowest level causes the bus to return to the normal ride height.
- 2 Pressing the switch once lowers the bus to its lowest level for entry/exit. When kneeling function is active, an icon in the instrument cluster lit and a blinking lamp is activated at the door as well as an acoustic signal

Various ways to resume normal riding height:

- Pressing the upper part of the switch
- Closing the door
- Starting the bus and accelerating beyond 5 km/h (3 mph) road speed (only buses without door brake)
- Restarting the engine

Conditions for kneeling:

- Engine running (vehicle stopped)
- Without extra step



DANGER

Ensure that the bus can kneel without the risk of trapping passengers' feet between the door sill and the curb. Failure to do so may result in serious personal injury.

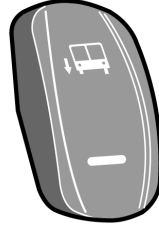

T0012054

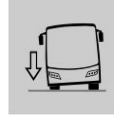

W0081879

Level Control

The ground clearance of the bus can be adjusted with this switch.

- to lower the bus press the lower part of the switch, e.g. while passing under a low bridge.
- to raise the bus press the upper part of the switch, e.g. while driving onto a ferry.

Note: Levelling control should only be used temporarily. During normal driving the switch **must** be in the middle position.

When the bus reaches the selected level a symbol and INFO lamp are shown on the display panel.

The suspension system attempts to keep the bus at the required height irrespective of the load. Any faults in the system are indicated by a symbol and INFO lamp on the display panel.

Note: The speed of the bus must not exceed 30 km/h (20 mph) in the high position or 5 km/h (3 mph) in the low position. If this happens a warning message and warning signal are sent.

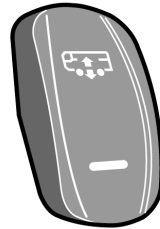

T0012058



T3014366



T001222
4

Low pressure in the air suspension system

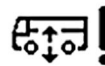

T0012467

Fault in the air suspension system

34 Instruments and Controls

Increasing Load on the Driving Axle (trailing axle lift)

The drive axle load is increased by pressing this switch. Increase in drive axle load is often an advantage when moving on slippery surfaces.

Pressing this switch increases the load on the driving axle by removing the suspension load on the trailing (non-driving) axle.

The unweighting continues until one of the following takes place:

- speed of the bus rises above 30 km/h (20 mph)
- the switch is pressed again

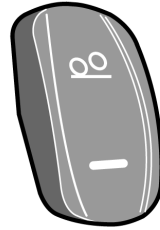

T0012046

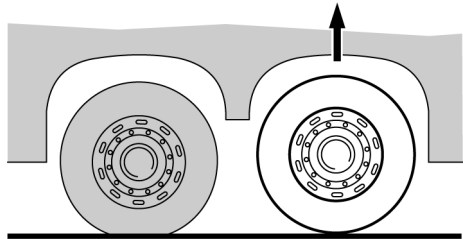

T6009559

Traction Control System (TCS)

The TCS system automatically reduces the driving torque of the engine if the drive wheels start to spin.

At speeds below 40 km/h (25 mph) the TCS system also acts as an automatic differential brake, braking the driving wheel that begins to spin.

For more information, see separate driver instructions “EBS”.

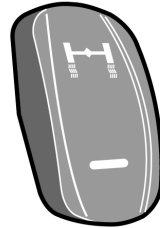

T0012059



CAUTION

Turn off the TCS before towing. Failure to do so may result in damage to the system components.

36 Instruments and Controls

Differential Lock

Differential lock allows drive axle shafts to be connected together. The wheels then rotate at the same speed, which makes driving on slippery surfaces easier.

The differential lock is only to be used on slippery surfaces. Engage as soon as the bus is on the slippery surface. It can be coupled in during driving, at any speed, but will not actually engage until the bus is travelling at less than 15 km/h (10 mph).

Do not forget to disengage the differential lock when you have left the slippery surface! For more information, see separate driver instructions “EBS”.

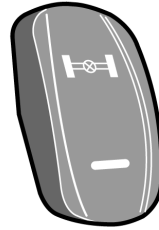

T0012041

3 stage switch for the manual/automatic coupling of the differential lock.



CAUTION

The differential lock is only to be used on slippery surfaces. Other uses may result in damage to the drive axle.

Hill Start Assistance

This function helps the driver to pull away on inclines by holding the bus still until the required torque at the wheels is applied.

This function's mode of operation depends on whether the bus is equipped with a manual or automatic transmission. Additional information, see separate Operating Instruction “EBS”.

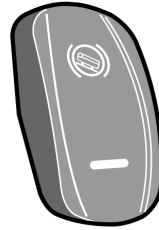

T0012045

Passenger Compartment Lighting

This switch turns on the passenger compartment lighting as follows:
 Press button once— after 3 seconds, all lamps will illuminate at 50% intensity.
 Press twice— after 3 seconds, all the passenger compartment lights will illuminate at 100% intensity.
 Press three or more times — switching between interval of 3 seconds the light intensity decreases from 100% to 50% and vice versa.
 Press and hold button for 3 seconds — to turn off passenger compartment lighting.

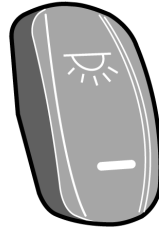

T1008556

Night Lighting (Option)

This switch has two positions, ON and OFF. Activation of the night lighting turns on the lamps illuminating the gangway, which are located under the seats.
 When the night lighting is on, the passenger compartment lighting level is dimmed to 30% regardless of the positions of the other switches.

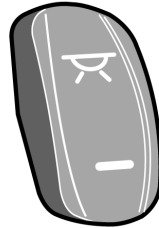

T1008549

Half-Light

Switches on blue lights around reading lights.
 Press once — to turn on only the blue lights in the passenger compartment.
 Press twice — to turn on the blue lights in the driver's compartment.
 Press three times — to turn on all the blue lights.
 Press and hold for 3 seconds — to turn off all the blue lights.

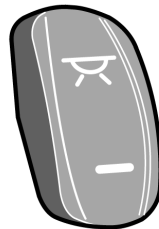

T1008549

38 Instruments and Controls

Driver Compartment Lighting

This switch has three positions as follows:

Position I — or bottom position, all lighting is OFF.

Position II — or middle position, the lighting is OFF if the door is closed, but the lighting is on if the door is open.

Position III — or top position, the lighting turns on without any restriction.

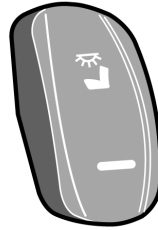

T1008557

Passengers' Individual Lighting

Enabling/disabling of the passengers' individual lighting. Lamps are located in the panels above the passenger seats. See “Passengers Panel”, page 65.

Position I - or bottom position all lamps are turned on, which is useful for example when checking whether all bulbs are OK.

Position II - or middle position all lamps are turned off.

Position III — or top position every passenger can individually turn on the lighting with the push-button on the panel.

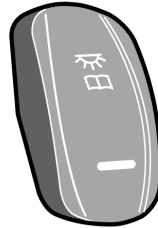

T1008548

Rear Door Lighting

When this button is activated, the entrance lighting of the rear door switches on when it is open.

In some buses there is a double-position control. It operates as follows:

Position I — the light switches on when the door is open.

Position II — the lighting switches on when reverse gear is selected.

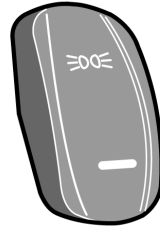

T3019957

Position Lights

This switch allows the creation of signs with position lights.

If the position lights are off, press and hold the switch to turn on the position lights.

If the positions lights are on, press and hold the switch to turn off the position lights.

Press and depress and so on for position lights blinking

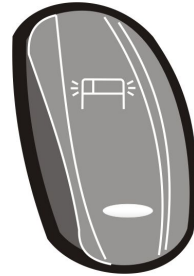

T0015279

Destination Sign Lighting (option)

This switch has three positions as follows:

Position I — or bottom position, destination sign lighting is off.

Position II — or middle position, destination sign lighting turns on when parking lights are on.

Position III — or top position, lighting turns on when the ignition switch is in position II.

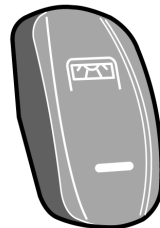

T1008545

Electrically heated rear—view mirrors

Pressing the button switches on the heating for 8 minutes.

Heating can be used to remove water droplets and ice from the mirror glass. Make sure the mirrors are free of mist or ice when driving.

Note: On some buses this switch, besides heating the rear-view mirrors, also switches on heating of the driver's window and front door window.

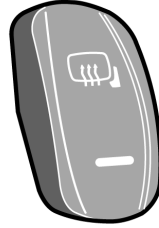

T1008551

Driver's window heating

Pressing the button switches on the heating for 8 minutes. Pressing the button again switches off the heating.

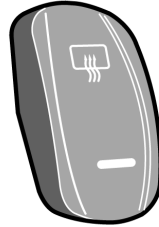

T1008580

Driver's Blower

Switch for the driver's blower.

It turns on/off two small fans located on the top of the driver's and guide's seats. Push the switch to turn on both fans and push again to turn off.

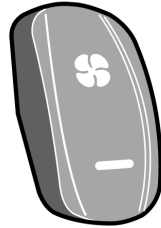

T1008550

Central Locking

This switch locks/unlocks all luggage compartment hatches.

Additionally this switch turns on the luggage compartment lights (Luggage compartment lighting turns off after 10 minutes of luggage hatches stills opened).

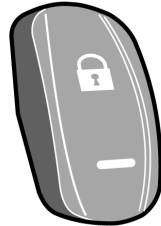

T1008543

Sun Visor

This switch facilitates lowering and raising of the front sun visor as follows:

- Lowering — Press at the bottom to low the sun visor, depress to stop the movement.
- Raising — Press at the top to raise the sun visor, depress to stop the movement.



T3018180

42 Instruments and Controls

Driver's Window

This switch facilitates lowering and raising of the driver's window.

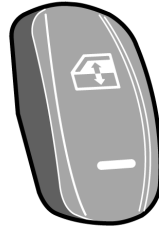

T3018172

Activation of the Toilet

Activates the power for the toilet and disengages the lock.

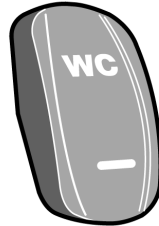

T3018183

Audio System

This switch has two positions as follows:
Position I — or bottom position, enabled radio, CD or mp3 audio for passengers (microphones disabled)
Position II — or top position, enabled microphones (for driver or guide).



W0082466

Opening the Doors from the Outside

Allows for the opening of the doors using the external push-button.

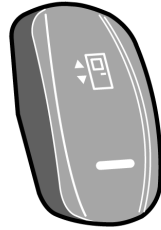

T1008555

Wheelchair Lift System (Option)

Enables Wheel Chair Lift System to be operated by its remote pendant.



W3081609

44 Instruments and Controls

Emergency Window in use Indicator Lamp

This lamp lights up to indicate that one of the emergency windows has been opened.

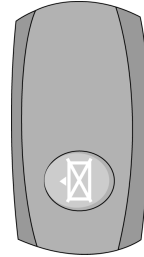

T0015524

Wheelchair Lift System Indicator Lights

Upper light indicates the Wheelchair lift system is enabled.

Bottom light indicates wheelchair lift door is ajar.



W3081610

Switches in the Electrical Center

The Volvo 9700 bus is equipped with additional push button switches in the electrical distribution box.

Air Conditioning Test.

Using this switch the driver can check if the air condition is working.

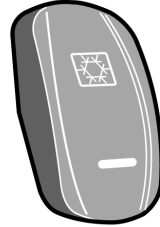

T3018175

Door Brake Switch.

A two position toggle switch with a protective cover is installed in the electrical center enables/ disables the door brake function.

- With the switch in the up position, the door brake is enabled.
- With the switch in the down position, the door brake is disabled.

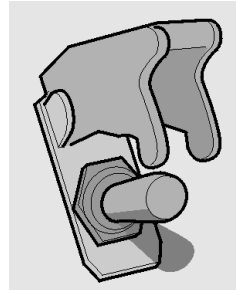

T0009170

Controls

Starting Switch

The ignition switch has four positions:

- 0 **Stop position.**
- I **Intermediate position.** In this position certain electrical devices can be used according to customer requirements.
- II **Drive position.** Between positions II and III there is a spring-return position for preheating.
- III **Start position.** Spring-return.

Note: Removing the key from the starting switch activates the steering lock.

Note: The key can only be removed from the starting switch when it is in the stop position.

Note: Do not remove the key from the starting switch when the bus is being towed!

Note: Always remove the key from the starting switch when leaving the bus.



T0014333

Adjusting External Rear-view Mirrors

Both rear-view mirrors are adjusted using the same switch. The switch can be turned to one of the two positions (adjustment of the right or left mirror). The arrow shows which of the mirrors has been selected. The selected mirror is adjusted by moving the switch in the appropriate direction.

Note: Rear-view mirrors should be adjusted before starting to drive.

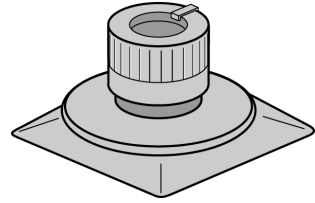

T0014718

Open Door Brake

The open door brake can be activated in various ways, depending on its design and customer requirements. The open door brake is activated only at speeds below 5 km/h (3 mph) if any of the/specified doors are opened. In the event that the door brake is activated, its indicator light comes on the instrument panel.

Note: The open door brake does **not** engage if the brake system registers poor traction when the bus is stopping on a slippery surface. This prevents the bus skidding when stopping on a slippery surface.

Note: The open door brake does **not** engage at speeds over 5 km/h (3 mph).

Open Door Brake Deactivation

- 1 The accelerator must not be active (fully release the accelerator)
- 2 Doors/The specified door(s) must be completely closed.
- 3 The accelerator must be activated again (depress the accelerator again)

In the event that, due to the bus stopping on a slippery surface, the brake system has not activated the door brake, you must brake again (in a place where no slippery surface is detected) to enable this brake to be reactivated.

General Door Brake Deactivation

Depending on the design, the electrical distribution box may also be equipped with a disabling switch (bypass switch). This switch deactivates the door brake independently of the other functions.

Note: This switch should only be used in the event that the bus cannot be driven in the normal manner. The door brake should normally be **always** on, i.e. the bus must not be able to move until the doors are closed.

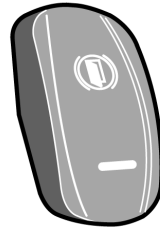

T1008554

Steering Wheel Adjustment

Both the steering wheel height and its tilt allow of continuous adjustment.

Adjust the steering wheel as follows:

- depress the pedal to which the arrow points
- Setting the steering wheel
- after releasing the pedal the steering wheel is locked in its new position.

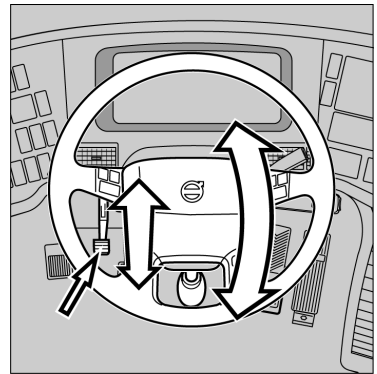

T6010216



DANGER

Steering wheel adjustments should only be performed while the bus is stationary. Adjustments with the vehicle is moving may lead to an accident, resulting in serious personal injury or death.

Directional indicator, Dipped/full beam changer

1 Location of point of resistance.

When making maneuvers requiring only slight movements of the steering wheel (changing lanes, overtaking), move the stalk up or down and hold it there. After releasing the stalk, it will immediately return to its neutral position.

2 Move the stalk beyond the resistance point. .

The directional indicators will continue to flash until the stalk is manually moved back to the neutral position, or the steering wheel is returned to the straight ahead position after the turn.

3 Main beam “flash”.

Pull the stalk towards the steering wheel (until you feel slight resistance).

The main beam will stay lit until the stalk is released.

Main/dipped beam switching (lights on).

Pull the stalk towards the steering wheel beyond the “flashing point” and release it.

Each time you do this, the headlamps will toggle between main and dipped beam.

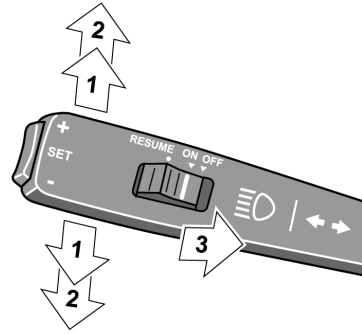

T0012077

In addition, engine idling speed can be controlled with this stalk. See: “Low Idle Adjustment”, page 89

Windscreen Wipers, Windscreen/headlight Washer

Note: This stalk also provides control of the display, for additional information about display control, see the separate Operation Instruction “Display”.

1 Interval wiping

Used when driving in mist or drizzle conditions.

The wipers make one sweep every 10 seconds. To reduce the time between sweeps, move the stalk to the normal position, and then, after the desired time interval, back to the interval wiping position. This permits the wiping interval to be set to any value between 1 and 10 seconds.

2 Flick wipe position.

If you want the wiper to make only one or two strokes (e.g. drizzle), move the lever to the flick wipe position and keep it there with your finger. The wipers will stop in parking position after releasing the lever.

3 Windscreen wipers, normal speed.

4 Windscreen wipers, high speed.

5 Windscreen washers + headlight washers.

Moving the stalk to this position will also activate the windscreen wipers, which will make an additional 2-3 sweeps after the stalk has been released.

The headlight washers and windscreen washers have a common fluid reservoir.

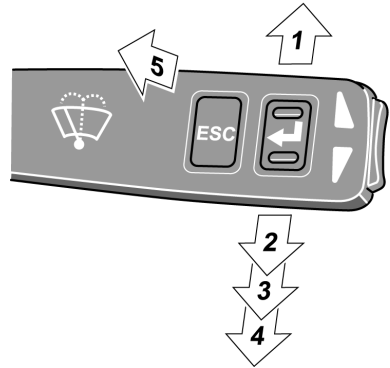

T0012079

52 Instruments and Controls

Transmission

Transmission, I-Shift Lever Selector.

The bus may be fitted with an I-shift automatic transmission lever selector.

Both clutch operation and gear shifts are performed fully automatically. If necessary the gears can be changed manually.

By pressing the FOLD button and tilting the lever downwards to the position where the lever is on a level with the seat, extra room may be created for the driver.

For more information, see separate driver instructions “I-shift”.

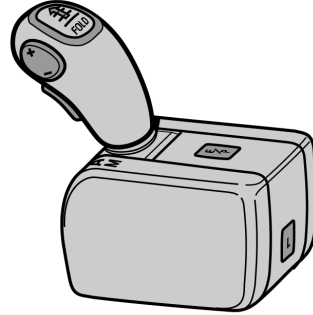

T4021276

Transmission, I-Shift Pad Selector.

The bus may be fitted with an I-shift automatic transmission pad selector.

Both clutch operation and gear shifts are performed fully automatically. If necessary the gears can be changed manually.

The push-button shift selector has four positions: R, N, D and M.

- R — Reverse: Vehicle must be stationary when selecting R.
- N — Neutral: No gear engaged.
- D — Drive: Automatic drive mode. The transmission will select most suitable gear for running conditions such as load, speed, accelerator pedal position, hill climbing, etc.
- M — Manual Program: Changing up and down is done with the + and — buttons.

For more information, see separate driver instructions “I-shift pad selector”.



W4058838

Retarder

The transmission has an integrated retarder, which helps to brake the bus reducing the load on the brakes as a result. It is automatically engaged by the initial movement of the foot brake pedal, even before the wheel brakes are engaged.

Note: The retarder brakes only the driving wheels. If the bus is fitted with the Anti-Lock Brake system (ABS), the retarder is automatically disengaged on any signs of the wheels locking. When the retarder is active, its symbol is shown on the display.

The retarder can be disabled by pressing its switch on the dashboard.

Note: Under normal driving conditions, the retarder should not be disabled.

 **DANGER**

Avoid using the retarder on slippery roads because of the risk of locking the wheels and skidding (the retarder brakes only the driving wheels). Failure to do so may lead to an accident, resulting in serious personal injury or death.

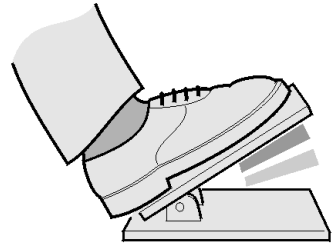

T0009004



T3018117

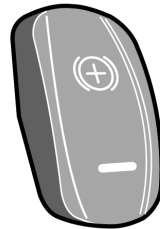

T1008547

Retarder Overheating

If the retarder remains engaged for a long time (e.g. during a long downhill stretch) it may overheat, causing an increase in retarder oil temperature.

The first indication of retarder overheating is the white “INFO” lamp lighting and the temperature symbol showing up on the display. If this happens, select a lower gear and make greater use of the main brakes.

If the temperature continues to rise, the red “STOP” lamp will light and there will be an increase in the temperature accompanying the symbol on the display. Stop the bus as soon as possible and select neutral, i.e. N. To increase the circulation of the coolant run the engine at higher idle until the temperature returns to the normal level.

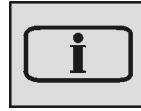

T3014366



T3008844



T3014364



CAUTION

Do not switch off the engine before the temperature is back to normal. Failure to do so may result in component damage.

Transmission Overheating

If the transmission overheats, the white “INFO” lamp will light and the display will show a red symbol.

If the temperature rises further, the red “STOP” lamp will light. Slow down and stop the bus as soon as it is safe to do so. Contact Service for advice.



T3014366



T3014364



T0008817

Brakes

Parking Brake

The parking brake acts on the drive wheels. When the hand control is in the forward position with the compressed air system charged and the blocking valve depressed, the parking brake is released.

When the parking brake hand control is moved backwards, the parking brake is gradually applied. It is fully applied when the hand control is in its backmost, locked position.

To release the parking brake hand control from the locked position, lift the ring upwards and move the lever forwards.

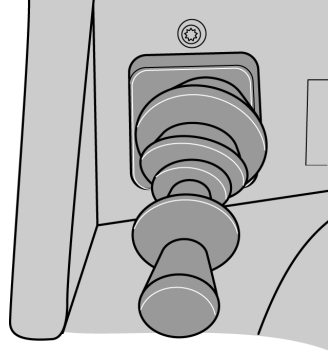

T5014881

DANGER

Never leave the bus without engaging the parking brake. Failure to do so will prevent the bus from staying stationary leading to an accident that may result in seriously personal injury or death.

DANGER

If the warning lamp lights while driving, stop the bus immediately. Failure to do so may result in serious personal injury or death.

DANGER

Never start driving while the brake system warning lamp is still lit. Failure to do so may result in serious personal injury or death.

Emergency Brake

To use the parking brake as an emergency brake, move the lever gradually backwards to the parking position. Keep the catch pulled in all the time, or the control will fasten in the locked position.

Note: The parking brake is only to be used for parking or as an emergency brake in case of malfunction of the foot brake system. The parking brake only brakes the drive wheels, the braking distance will be longer than when using the foot brake. There is also an increased risk of skidding because only the drive wheels are used for braking.

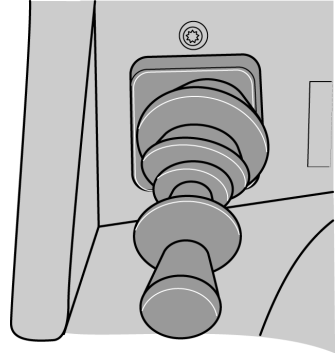

T5014881

Blocking Valve

If the brake system at any point in time is emptied of air, for example — the bus standing parked for a longer time period, the parking brake cannot be released.

To release the parking brake you must first start the engine and wait until the brake system warning light has gone out. Then press the blocking valve.

Even if the hand lever for the parking brake has been moved to the forward position, the brake will not be released until the blocking valve has been pressed in.

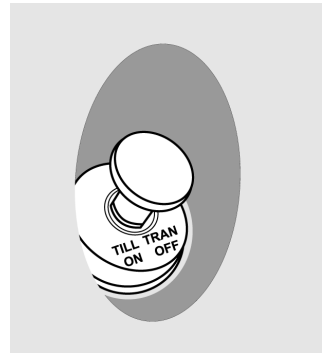

T0015484

Service Brakes

The bus is equipped with an EBS brake system (Electronically-controlled Braking System). This system monitors and controls brake operation. For additional information concerning the EBS system, refer to the separate Operating Instruction “EBS”.

If the main brakes are used without care when driving down steep and long inclines, they will heat up very quickly to extreme temperatures. The low speed that is generally the rule in such cases means that the brakes are not cooled as efficiently as when driving on level roads.

When driving downhill, in the first instance use the retarder brake, and only supplement this with the main brakes as necessary. For additional information about the retarder, see “Retarder”, page 91.

If you have to use the footbrake while driving downhill, do not pump the brakes, as this will only use up compressed air. Brake sufficiently hard, and then release the brake pedal completely, or just to the pedal position where only the retarder is engaged. Heat builds up very quickly in the brakes, causing increased wear of the brake linings and reduced brake efficiency.

The main purpose of the EBS system is to increase road traffic safety by shortening braking distances.

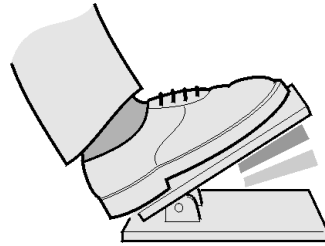

T0009004

Dark zone — only retarder

Light zone — retarder and foot brake



T0009682



T3008834

EBS controls the ABS and ASR braking forces. It is fitted only on buses with disc brakes. ABS is a part of the EBS system and works completely automatically. The ABS (Anti-lock Brake System) prevents the wheels from locking up during braking. In case of ABS failure, the appropriate symbol appears on the instrument panel.

Note: ABS efficiency is limited. Remember, that on slippery surfaces ABS will not shorten the braking distance significantly. It can nevertheless help in avoiding obstacles during braking.



T0009682



T3008834

60 Instruments and Controls

Compensating for Differences in the Wear of the Brake Pads

If the brake pads on one of the axles wear down faster than those on the other, braking force is redistributed so that a greater portion of the braking force is applied to the wheels on the axle with less wear.

Note: This function activates when braking lightly. During hard braking the braking force is distributed so as to achieve the most efficient braking.

When the thickness of the brake pads is reduced to 20% of the thickness of new pads, a warning symbol is shown on the display.



T5013668

DANGER

When brake pad warning symbol is displayed, immediately proceed to the nearest service station to replace the brake pads with new ones. Driving any further with worn out brake pads may lead to losing control of the vehicle and cause an accident resulting in serious personal injury or death.

Brake temperature High Warning

If the temperature of the brakes increases too much, the “CHECK” lamp lights, and the relevant symbol is shown on the display.

Note: If the temperature is allowed to rise further, maintaining the same braking force will require increased pressure on the brake pedal.



T5013670



T3014365

A/C Controller

The Volvo 9700 bus is equipped with an AC controller to maintain a constant temperature inside the bus.

For more detailed information, see separate instructions “AC controller”

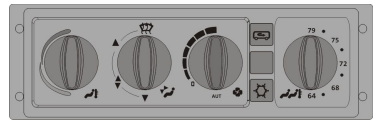

T5061140

62 Instruments and Controls

Destination Sign Control (Option)

The bus may be fitted with a high definition destination sign.

Use instructions:

- **Destination text:** Press the select button until the letter D appears in the display. Insert the destination text code using the buttons of units, tens and hundreds (for example D001)
- **Extra text:** Press the select button until the letter E letter appears into the display. Insert the extra text code using the buttons of units, tens and hundreds (for example E002).
- **Departure time:** Insert the time into the display in E (Normally E001 is reserved). Press the button until the letter S appears, adjust the hour with button H and minutes with button M.

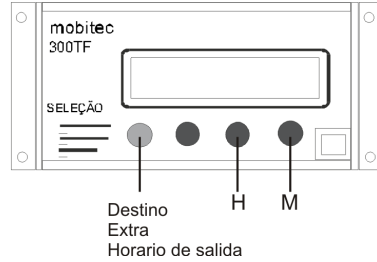

T0015271

Destination sign will be updated 4 seconds after., for more information see separated instructions “Destination sign”.

Interior Equipment

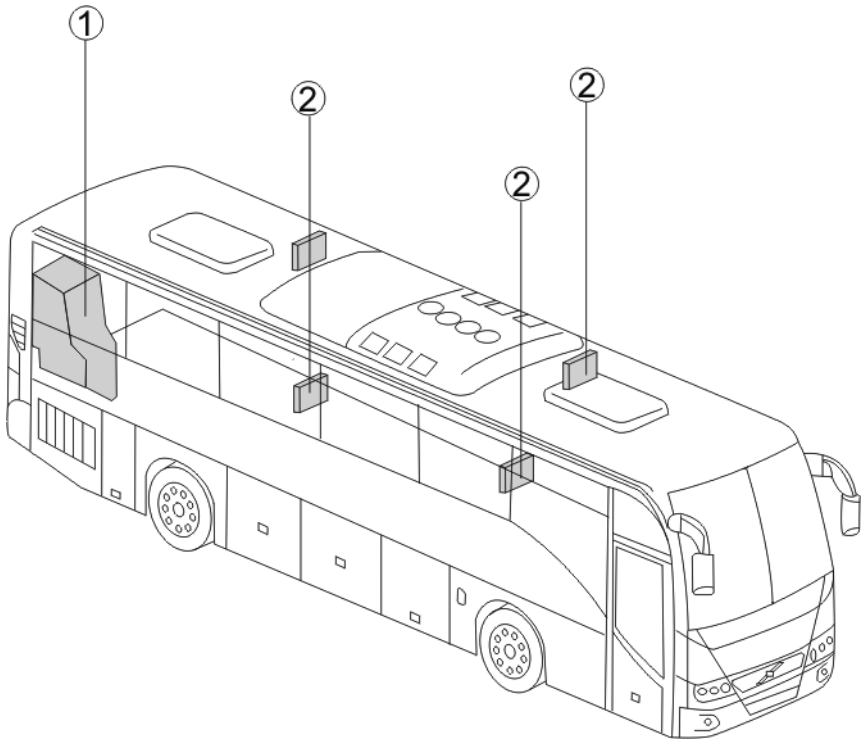

T0015326

To enhance travel comfort, the bus may be fitted with additional interior equipment such as:

- 1 Toilet
- 2 Monitors

64 Interior Equipment

Toilet

The bus is equipped with a toilet, located on the right-hand side at the rear of the vehicle. Pressing a switch on the dashboard enables the toilet to be used, by releasing its central lock and switching on the toilet power supply. While the toilet is occupied (after locking the door) a sign lights up in the passenger compartment.

In the toilet compartment there is an emergency push-button with backlight. After it has been pressed, the toilet indicator lamp flashes on the dashboard.

For additional information and instructions regarding the servicing and maintenance of the toilet, see the separate Operating Instructions “Toilet Facility, B13R”.

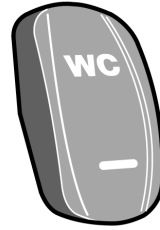

T3018183

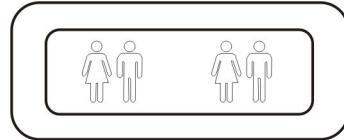

T0015272

Passenger's Clock Display

The bus is equipped with a clock display located on the front of the passenger's cabin roof.

Display shown:

Time

Date

Toilet occupied

Toilet unoccupied

For detailed information, see separate instructions “Clock Display”.

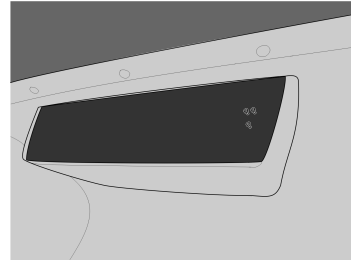

W3081817

Passengers Panel

Above every pair of passenger seats there is a passenger panel. On each panel there is:

- 1 Left Reading Light ON/ OFF.
- 2 Right Reading Light ON/ OFF.
- 3 Loudspeaker ON/OFF
- 4 Call Button
- 5 Reading Light
- 6 A/C Outlet Grill

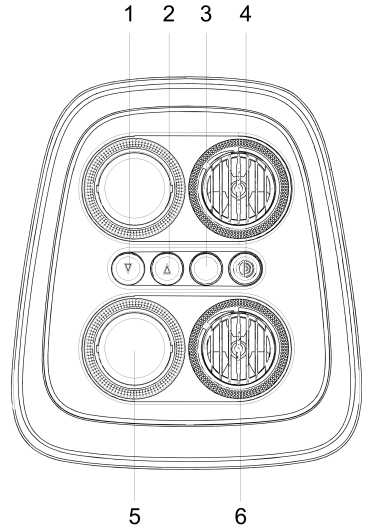

W3081339

Lighting Stripe LED

The 9700 bus is equipped with a lighting stripe LED mounted on each passenger's panel. The stripe illuminates 100% when the main switch is turned on, however, when the parking brake is released, the stripes dim by 50%.

66 Interior Equipment

Passenger's AC 110 V Power Outlets

For each pair of passenger's seats there are two power outlets to connect:

Cell phone charger.

LapTop.

MP3 player

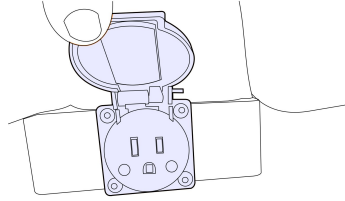

W3081816

Passenger's AC 110 V Power Outlets Circuit Braker



WARNING

Do not connect high power consumption electrical devices such as: Hair dryers or curling iron or similar electrical equipment, if this equipment is connected to the power outlets system, it may cause damage to the electrical system of the bus.

In case of an electrical overload, the system is equipped with a thermally protected circuit breaker, which disables the electrical power outlet system. The operator can reset the system by pressing the blue button (1) integrated into the protection device. The

protection device is located in the lower center console of the dashboard.

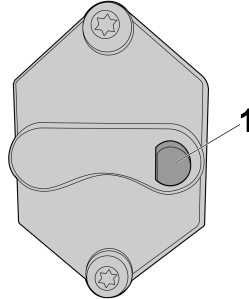

W3081815

Audiovisual System

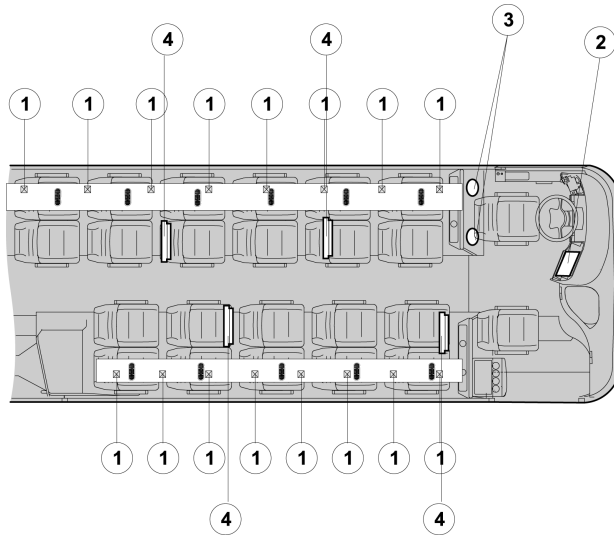

T0015327

To enhance the comfort of the passengers during journeys, the Volvo 9700 bus is equipped with an audiovisual system, whose main components are:

- 1 Loudspeakers in the luggage racks
- 2 CD, DVD player
- 3 Driver's loudspeakers
- 4 LCD monitors

68 Audiovisual System

Audiovisual Controller

The Volvo 9700 could be equipped with main unit, giving the driver complete control of the system. See separate Operating Instructions: “Bosch Multimedia System”.

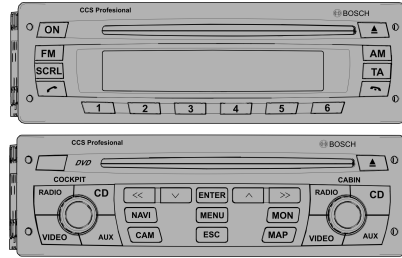

W8081374

Video System

There are four LCD monitors in the bus. They are activated by selecting the VIDEO signal source on the audiovisual controller. See separate Operating Instructions. “Bosch Multimedia System”.

Audio System

The main elements of the audio system are:

- Radio
- CD player
- USB mp3 input
- Loudspeakers

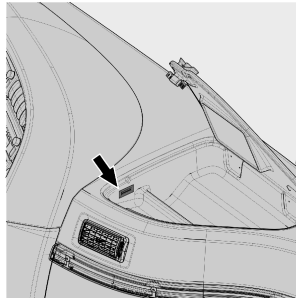

W8081636

USB Connection for Audio System

Overview

As the driver you must always be familiar with the location of the emergency equipment in the bus, and how to use it.

It is essential that all emergency equipment is checked on a regular basis to make sure that it is in working condition and in place. The location of the safety equipment and its scope can vary, depending on the regulations in the country in question. Therefore make sure that you know where the equipment is and check that nothing is missing.

Fire Extinguisher

The fire extinguisher is located in the front of the bus (most often mounted under dashboard on the right-hand side).

The fire extinguisher can be used to put out fires in volatile fluids, wood, fabric, paper and electrical equipment. Check regularly that the pressure gauge indicator is in the green zone.

How to use the fire extinguisher:

- 1 Remove the fire extinguisher from its holder.
- 2 Hold the extinguisher by its handle with one hand, and pull the safety pin with the other.
- 3 Point the rubber hose at the heart of the fire and press the trigger.

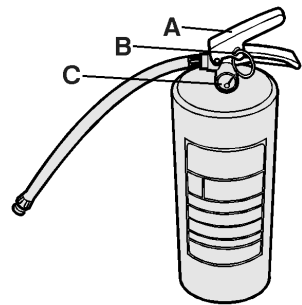

T0008196

- | | |
|---|----------------|
| A | Trigger |
| B | Safety pin |
| C | Pressure gauge |

70 Emergency and Safety Equipment

Automatic Fire Suppression System

The bus is equipped with an Automatic fire detection and suppression system (AFSS) . This system provides continuous monitoring of the hazard areas of the engine bay. It responds to fires fueled by diesel, oil, lubricants and another flammable liquids.

If a fire is detected, the system will alert the driver with both audible and visual alarms while immediately shutting down the Air Conditioning system. A time delay allows the driver the capability to bring the vehicle to a safe stop prior of the activation of the fire extinguisher and engine shutdown.

Note: If additional time is required the timer can be reset by pressing the

For more information see separate operating instruction “Automatic Fire Detection System”.

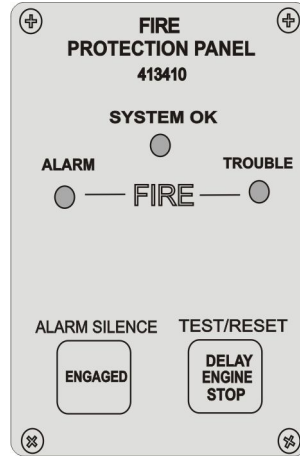

T8061163

Manual Discharge

In the event of fire:

- 1 Twist and pull tamper seal to remove
- 2 Lift cover
- 3 Push red button

If the driver activates the Manual discharge switch the following will occur:

The “FIRE” alarm lamp will illuminate and the alarm buzzer will sound

The extinguisher will discharge

The engine will shutdown

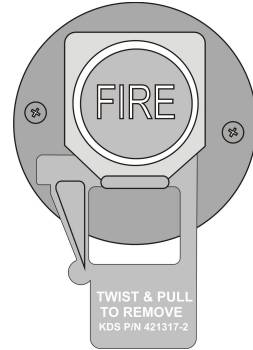

T8061299



CAUTION

Service fire suppression system before restarting equipment.

72 Emergency and Safety Equipment

Warning Triangle

The warning triangle is located either in the toolbox, or in a holder to the right of the driver.

The warning triangle is used whenever a fault forces the bus to stop in a hazardous location. Switch on the hazard warning lights and place the warning triangle at a distance stipulated by the traffic regulations of the country in question.

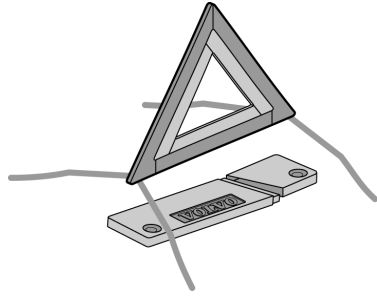

T8011683

First-aid Kit

The first aid kit contains basic first aid materials.

For location of the first aid kit: see the markings inside the bus.

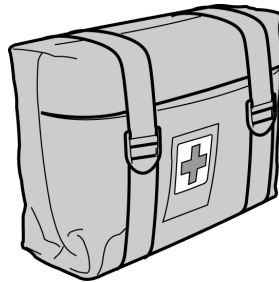

T1008716

Tire Pressure Monitoring System

The Tire Pressure Monitoring System (TPMS) is a sensing device designed to identify and display tire operating data and activate an alert or warning when pressure or temperature irregularities are detected.

Note: Is it responsibility of the driver to react promptly and with discretion to alerts and warnings. Abnormal tire inflation pressures should be corrected at the earliest opportunity.

The system will monitor all vehicle tires plus the spare tire when a spare is supplied. For more information see separate operating instruction “Tire Pressure Monitoring System”.

74 Emergency and Safety Equipment

Tire Pressure Monitoring System (TPMS) Display

The TPMS Display knows where the sensor are located. It receives the raw temperature and pressure readings from the TPMS receiver, it reads several signals from the vehicle and does the calculation required to generate the various screens.

When no readings have been received for a tire location or when the received data correspond to a parameter range defined as unavailable and appears as two dash lines “_ _”.

The TPMS display is initially configured to define how many axles and running tires are present on the vehicle.

The TPMS display is also configured with several other parameters, including threshold levels for the alarms.

The TPMS display power supply turns OFF when the ignition key is switched OFF.

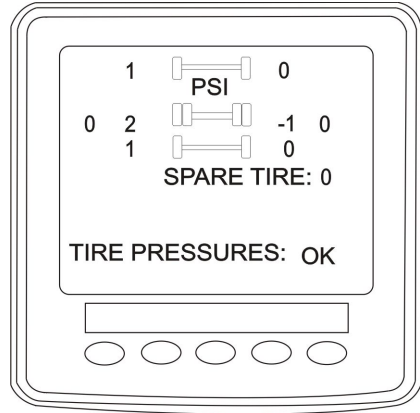

T8061165

Tire Inflation Valve

Tire Inflation Valve may be used to:

- Inflate a tire using the bus pneumatic system
- Release the parking brake with air from a tire

Its main use is to release the parking brake in a situation when the bus cannot supply its own air, e.g. engine breakdown.

The bus toolbox contains a hose that connects between the tire and the tire inflation valve.

The tire inflation valve is located next to the driver's seat or inside the first service hatch.

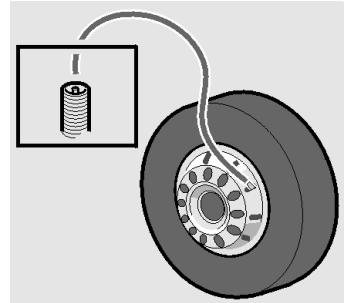

T0009182

External Air Supply Connection

Behind the front hatch there is a valve to which an external air supply can be connected. This could be used when parking the bus overnight, to prevent emptying of the air system.

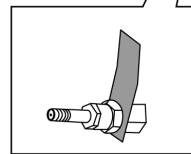
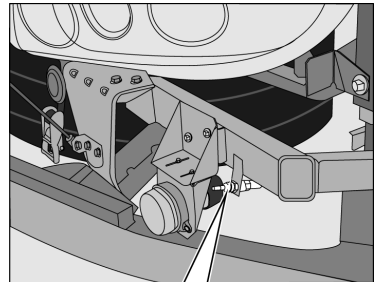

T0015390

76 Emergency and Safety Equipment

Jack

The bus is fitted with special jacking points to comply with safety regulations. For detailed information concerning the use of the jack and changing wheels, see the separate Operating Instruction “Replacement of Wheels, 9700”



DANGER

Always ensure that the bus is standing on a level surface and chock the wheels so it cannot move. Failure to do so may result in serious personal injury or death.

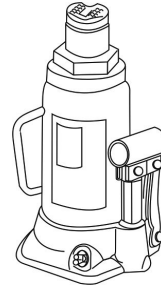

T0015345

Note: The jack supplied with the bus should be only be used to lift the bus to change a wheel.

Toolbox

The toolbox and tools can be purchased from your local dealer. A complete toolbox contains:

Toolbox	
Item	Part Number
Jack (2 units)	3124497
Adaptor for the jack	3178753
Wheel wrench	9521826
Towing kit	205465449
Hammer	962207
Pumping hose	942868
Warning triangle	3176488
Key for the hatches	70319047
Female key	70344906
Male key	70344905
Pliers	962042
Adjustable wrench	755
Screwdriver with bits	978201
Spare wheel wrench	1062412
Winch handle	1590997
Extension for pumping valve	1621456
Socket wrench 19/24 mm	8189085
Jack extension	1586079
Jack extension	1577686
Wheel wrench extension	20592217
Tool bag	1577384
Wheel chocks (2)	8158698

78 Emergency and Safety Equipment

Engine Control Box in Engine Bay

The engine control box is located behind the engine hatch in the back of the bus. It is used only in conjunction with servicing.



CAUTION

To avoid accidental engine turning on while you are in the engine bay, the switch (1) must be in position 0.

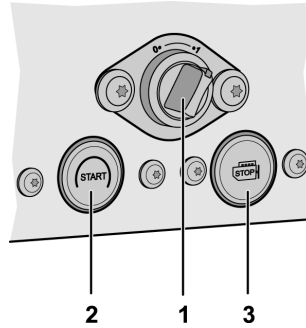

T2023998

The control box has three controls:

1 Start enable switch

When the switch is turned to position 1, the engine can be started from either the start button on the control box, or the key ignition on the dashboard. When the switch is turned to position 0, the engine cannot be started from the engine bay, nor from the dashboard.

2 Start button

When switch (1) is turned to position 1, pressing this button starts the engine. To allow the engine to be started from the control box in the engine bay, the transmission must be in neutral position (N), and the ignition key in the “DRIVE” position.

3 Emergency stop button

To stop the engine press the red button.

Emergency Exits

Doors

There is a valve for emergency door opening above the door. Turning the knob cuts off the compressed air supply to the door.

After turning the knob and hence cutting off the compressed air supply to the door, a warning lamp lights up and a buzzer sounds. To return the compressed air system to its normal state, turn the knob back to its initial position and press the appropriate door button on the dashboard.

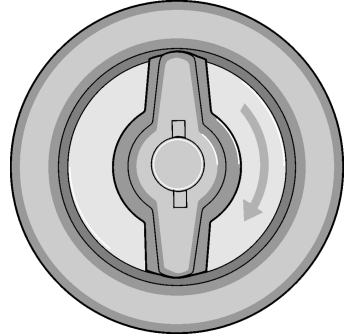

T8009617

Ceiling, Roof Hatches

To open the roof hatch in case of emergency, pull the hatch red handles and push the hatch upwards.

For more information see separate operating instruction “Manual roof hatch operation”.

- From inside, pull the hatch red handles and push the hatch upwards
- From outside, pull the hatch red handles and pull the hatch.

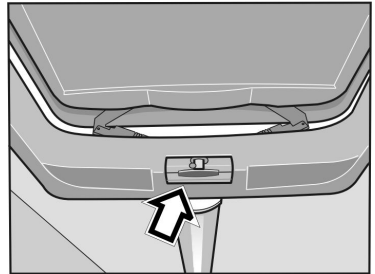

T8010110

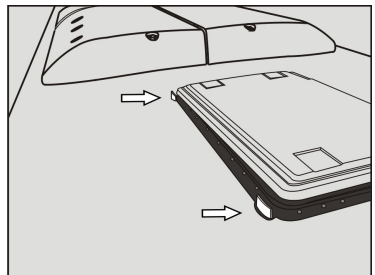

T8061298

80 Emergency and Safety Equipment

Emergency Windows

These windows can be opened from inside the vehicle as emergency exits. A decal on window sills indicates the location of the emergency windows. To open an emergency window, lift the window release bar (sill) and push the window open from the bottom. To close, lift the release bar and pull the window into position. Push down on release bar to lock the window shut.



F8061781

Checking Before Driving

Before starting the bus and driving off, check the pressure sensitive edges on the doors. If the door leaf during opening encounters an obstacle, the door should stop. If the door leaf encounters an obstacle during closing, the door should open again. It should not be possible to open the doors by hand while the engine is running.

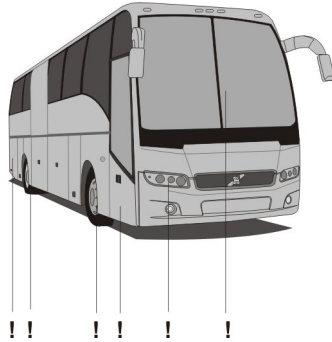

T0015270



WARNING

Make sure that the sensitive edges on the door work prior to vehicle use. Failure to do so may lead to personal injury of passengers.

Make sure that:

- all hatches are closed
- all the lighting is working properly
- the windscreen wipers/washers are working properly
- safety equipment is in place
- the direction indicators and horn are working properly
- the air pressure in the tires is in order (using a hammer) and nothing has got stuck between the back twin wheels.
- destination information and line number are correct
- the emergency opening system for the doors is working properly.
- all emergency windows and roof hatches are properly closed

82 Starting and Driving

Checking Warning Lights

When the key is in position **I**, the control system checks that all the warning lamps are working properly.

All the warning lamps and the warning LEDs in the instrument cluster are lit for about 5 seconds. The ABS system indicator lamp will light up for slightly longer than the others. If it continues to be lit then a fault has been detected in the ABS system.

Daily Inspection

Engine oil level, as well as the servo fluid and coolant levels in the bus should be checked on a daily basis. The checks are carried out with the engine **warm**, but switched off.

Note: It is a good idea to do these checks after a tour as the engine is then at normal operating temperature.

All tanks are located in the back of the bus.

Engine

When checking the oil level:

- position the bus on level ground.
- if the engine is cold, let it idle for 1-2 minutes
- turn the engine off. Wait at least 2 minutes before carrying out the check
- remove the dipstick and wipe it with a clean cloth
- check the oil level with the dipstick. The oil level should be between MAX and MIN
- top up if necessary.

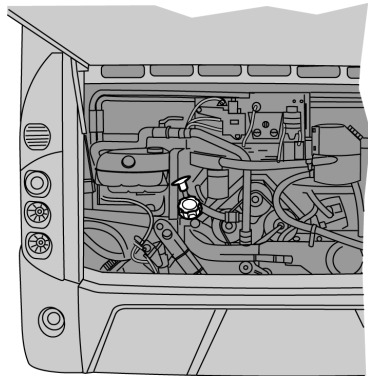

Steering Servo/Hydraulic Fan

Check that the oil level is between the MAX and MIN markings on the reservoir (B). Top up if necessary.

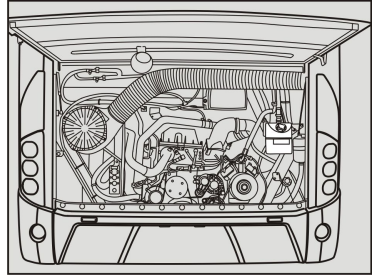

T1061953

Coolant

Check that the coolant level is between the MAX and MIN markings on the reservoir (A). Top up if necessary.

The reservoir is located over the rear engine door.

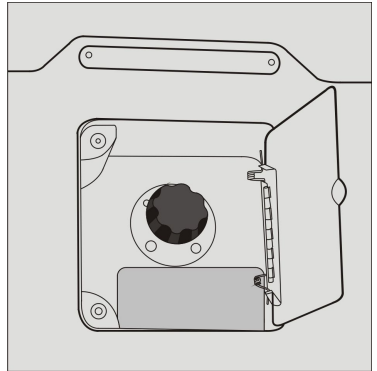

T8061297

Washer Fluid

Check the level of the washer fluid in the reservoir. Top up if necessary.

Note: In winter use appropriate fluid with lower freezing temperature.

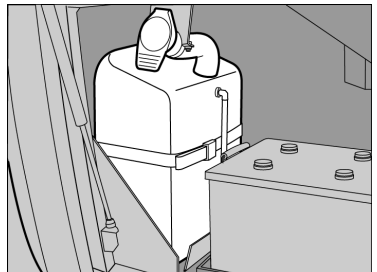

T2024567

Refuelling

Open the flap and the fuel filler cap. Insert the end of the fuel hose into the filler neck. Fill up the tank. After filling up the tank, remove the fuel pipe and put it back on the pump. Close the fuel filler cap and the flap. Volvo 9700 buses have two tanks with 400 liter (105 gallons) capacity each one.

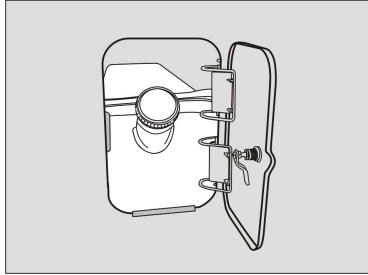

T2061889



CAUTION

The use of Diesel fuel other than ULSD, will adversely affect performance, efficiency and durability of the DPF system and the engine, to the point where the engine may not run at all. Manufacturer's warranties can also be rendered void due to usage of improper fuel. None approved fuel additives (including engine oil) are NOT permitted. Blends of No. 1D and No. 2D grades of ULSD are recommended and allowable for cold weather operations.

Note: Avoid spilling fuel on to painted surfaces. Refuel only at designated places.

Diesel Exhaust Fluid (DEF) Tank

On the right side and on the rear is the Diesel Exhaust Fluid (DEF) tank. The tank can hold 60 l. As a guide, use 5 — 7% DEF



WARNING

Use only pure certified DEF from an approved dispenser or sealed container.



CAUTION

Do not put diesel fuel in the DEF tank. Diesel fuel, if sprayed into the hot exhaust along with the DEF, could ignite explosively causing a fire resulting in personal injury or damage to the exhaust system.

Note: Avoid spilling DEF on to painted surfaces. In case of spilling, rinse the painted surfaces immediately.

The level of DEF is indicated on the display in the “Gauges” menu, in the “DEF tank, level” submenu.

If the level of DEF drops below defined level (12% of the tank capacity), an information or warning message is displayed on the dashboard and the DEF dash lamp illuminates. Fill the tank as quickly as possible.

For additional information, see the separate Operating Instructions “Exhaust Aftertreatment System”

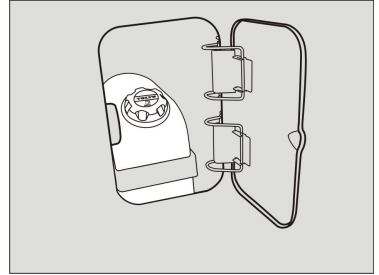

T2061890



T3014365



T3014366

Engine Block Heater

An electric engine block heater can be installed for keeping the coolant hot when the vehicle is parked. The heater is mounted through the side of the engine block with the heater coils in the coolant jacket. The heater does not interfere with normal operation and can be permanently installed.

The heater runs on 120V and has an easily accessible plug, located on the right side of the engine compartment. The plug will hook up to a normal extension cable.

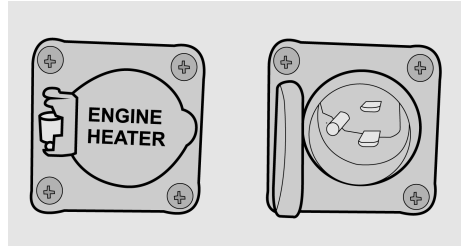

T0015492

Starting the Engine

Starting

When starting the engine, the parking brake must be engaged and the gear selector must be in neutral, i.e. N.

Starting a Cold Engine

When starting the engine at temperatures of around 10°C (50°F) and below, the air entering the engine should be heated. To prevent wear and possible damage to the engine when it is cold, gradually bring it up to operating temperature before operating at high engine speeds or full load. After starting and before moving the vehicle run the engine at 800 to 1000 rpm for 3 to 5 minutes. Operate at partial engine load until the coolant temperature reaches 75°C (167°F).



T0014333

Proceed as follows:

Turn the ignition key to the position between **II** and **III**. This starts the preheating, which can take up to about 50 seconds, depending on the temperature of the coolant. The indicator lamp is lit during preheating. Once the lamp has extinguished and the needle of the temperature gauge has moved off its lower stop, the engine can be started.

Do not race the engine when it is cold. This could damage the engine.



CAUTION

Do not let a cold engine run faster than 1000 rpm in very low temperatures (< -20 °C (-4°F)). Failure to do so may cause internal engine damage.

88 Starting and Driving

Starting a Hot Engine

Start directly by turning the key to the start position.

Stopping the Engine

To shut down the engine, turn the key to the STOP position. In an emergency situation the engine can be shut down by using the emergency stop, see “Emergency Stop”, page 31.

Note: Before turning off engine. If the engine has run at high temperature for a significant time before it is shut down, let the engine run at idle for 3 minutes to cool the engine off to avoid heat soak.

Checks After the Engine Has Been Started.

The coolant level warning lamp will stay lit for a few seconds after the engine has started. The parking brake warning lamp is lit when the parking brake is engaged. After releasing the parking brake, the lamp should remain lit until the pressure increases to about 540 kPa (78 psi). The footbrake warning lamp and the “STOP” lamp should remain lit until the pressure in the compressed air tanks reach a sufficiently high level.

DANGER

Do not drive the vehicle until the warning lamps have gone out, as the brake system needs the correct air pressure to work properly. Failure to do so may lead to an accident, resulting in serious personal injury or death.

Idling (programming)

The engine idling speed is 575–625 rpm. Keeping the idling speed constant is the task of the electronic control system, which makes manual adjustment unnecessary. When the bus is stationary, the idling speed can be temporarily raised to 1200 rpm.

Low Idle Adjustment

Before you start to adjust the idling speed, the engine must be warmed up to operating temperature. The bus must be stationary with the engine idling.

- switch (B) must be in the ON position
- the idling speed is increased by pressing the “+” side of the SET button (A). Each press on this button gives an increase of 10 rpm.
- if the idling speed becomes too high, it can be reduced by pressing the “-” side of the SET button. Each press gives a decrease of 10 rpm.

Note: The change in idling speed is only temporary. After pressing a pedal, engaging a gear or releasing the parking brake, the idling speed will return to its manufacturer settings. If new programming of idling rpm is required, keep your foot on the brake pedal and turn off the engine when the new engine rpm has been set.

Note: If the engine does not “run smoothly” at the default programmed by the manufacturer, please visit a Volvo workshop.

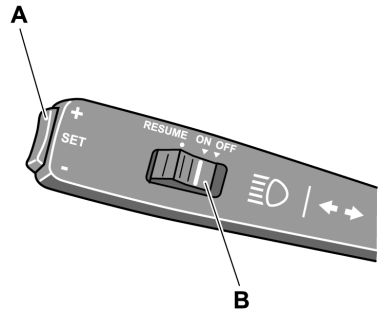

T0012078

90 Starting and Driving

Cruise Control

Cruise control is activated by moving the switch (B) to the ON position.

When the bus reached the desired speed, press the “+” or “-” side of the SET button (A). The set speed is increased or decreased by pressing the “+” or “-” side of the switch respectively.

If the speed is temporarily increased, e.g. for overtaking, the vehicle will return to the set speed when the accelerator is released.

Cruise control is deactivated if:

- the brake pedal is depressed
- the retarder stalk is moved to another position
- the switch (B) is moved to its OFF position

After cruise control has been switched off, the most recent set speed can be restored by moving the switch (B) to RESUME. This however does not apply if cruise control has been deactivated by moving switch (B) to its OFF position.

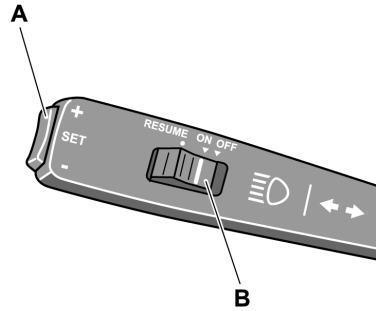

T0012078

Retarder

The function of the retarder is to supplement the main brake, and it acts as an additional brake. This function may be based on an engine brake, or a transmission brake together with the VEB (Volvo Engine Brake), which is an exhaust brake combined with a compression brake.

When the retarder stalk is in its (A) position, depressing the brake pedal will engage both the footbrake and the auxiliary brake. This mode is called “brake blending”, and means that the brake system decides how great a contribution to the total braking force will come from the auxiliary brake, and how much from the footbrake. It allows for optimal use of the auxiliary brake.

In other situations (1-3) the bus is braked by the additional brake as soon as the accelerator pedal is released. The braking force is increased by moving the lever down and decreased by moving the lever up.

Note: The retard function works together with the EBS system. See the separate driver instructions for “EBS”.



DANGER

Avoid using the retarder on slippery roads because of the risk of locking the wheels and skidding (the retarder brakes only the driving wheels). Failure to do so may lead to an accident, resulting in serious personal injury or death.

92 Starting and Driving

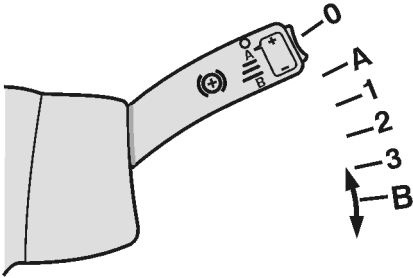

T0010263

The (B) position of the stalk is only present in buses fitted with I-shift. For additional information, see the separate Operating Instruction “I-shift”.

Speed Limiting

When the bus is driven downhill with the stalk in position (A), the retarder acts as a speed limiter. When the bus has reached the desired speed, lightly press the "+" or "-" side of the SET button (A). The retarder will maintain the speed of the bus at the setting it had when the SET button was pressed.

The set speed can be increased or decreased by pressing the plus (+) or minus (-) side of the SET button. Each pressing of the switch increases or decreases the speed by 1 km/h. If the switch is held in, the speed is adjusted by 1 km/h for each second it is held in.

Note: Buses that have a retard switch instead of a retard lever do not have this function.

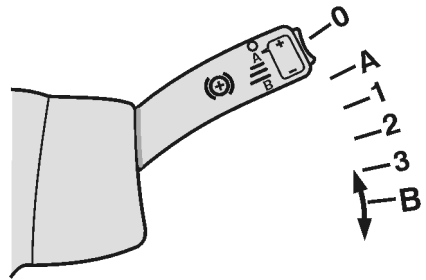

T0010263

Use the SET button on the retard switch to control the speed limitation.

Combined Cruise Control and Speed Limitation

If the bus is equipped with cruise control (see “Cruise Control”, page 90), the cruise control system will work together with the retarder. The stalk of the retarder should be in position (A).



T3008844

With cruise control active. While driving downhill with the cruise control active, the retarder will be engaged if the road speed exceeds the set speed by 5 km/h (3 mph). This overspeed value can be modified by means of the +/- button to any value in the range 3–15 km/h (2– 9 mph).

Note: The retarder is automatically deactivated if there is a risk for wheel locking.

Note: If the symbol for high retarder temperature is displayed, a lower gear range must be selected to cool it down. See separate Operating Instruction “Display”.

Power Steering

If the wheel is blocked on one side, against a curb for example, drive carefully forward and turn the steering wheel to allow the bus to move away from the kerb. Never try to force the wheels to turn.

Do not attempt to turn the bus by using excessive force on the steering wheel. Using excessive force on the steering wheel increases pressure in the power steering system, causing risk of overheating that may damage the oil pump.

If the power steering is malfunctioning it may feel as if the steering gear was blocked, this is however not the case, but steering the bus requires the use of much greater force.

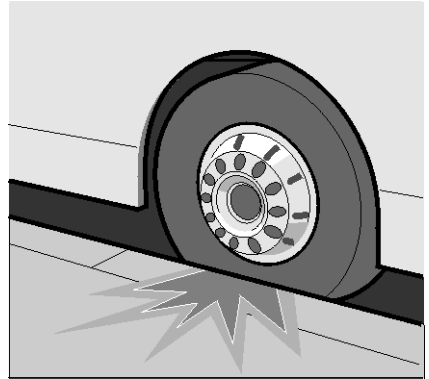

T0008960

Aftertreatment DPF with vertical SCR

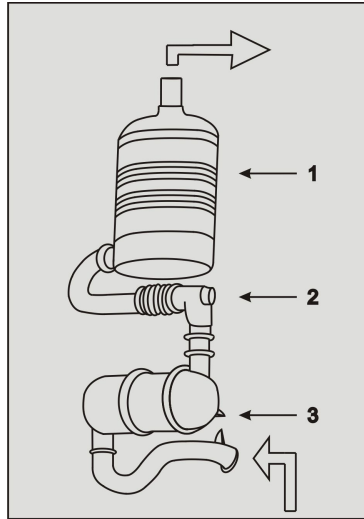

T8061296

- | | |
|---|--|
| 1 SCR (Aftertreatment Selective Catalytic Reduction) | 3 DPF (Aftertreatment Diesel Particulate Filter) |
| 2 DEF Dosing Valve (Aftertreatment Diesel Exhaust Fluid Dosing Valve) | |

Exhaust Aftertreatment System

Volvo 9700 has an exhaust aftertreatment system which includes a Aftertreatment Diesel Particulate Filter (DPF) and Aftertreatment Selective Catalytic Reduction unit (SCR). These components are part of the overall vehicle emissions control system. In normal operation, these components can experience surface temperatures as high as 350° C (662° F). It is important to periodically check to ensure there are no trapped material or substances between the DPF/SCR and the cover or shield. Failure to do so may result in fire.

New stringent standards for exhaust emissions control begin with the US 2010 engine model year. The Aftertreatment Diesel Particulate Filter (DPF) system has been developed to act in combination with ultra low sulfur diesel (ULSD) fuel to reduce particulate emissions to meet the requirement. The Exhaust Aftertreatment System (EATS) includes all the engine and exhaust emissions control components that are required to meet the stringent US 2010 standard.



DANGER

The DPF/SCR cover should not be removed while the vehicle is in use. Also, only remove the cover, once the vehicle is out of use and the SCR/DPF is sufficiently cooled. Failure to follow these instructions can result in fire, which can cause component damage, personal injury or death.

98 Starting and Driving

Note: The DPF/SCR and associated components are part of a U.S. EPA and California Air Resources Board (CARB) certified engine emissions system. These components must not be moved, altered or modified in any way. Tampering with these systems render the emissions warranty void and may result in possible tampering charges by the EPA or CARB.



CAUTION

The Aftertreatment Diesel Particulate Filter (DPF), Aftertreatment Selective Catalytic Reduction unit (SCR) and their components, can not be moved or altered from OEM installation in any fashion. Any alterations may cause component damage and is prohibited by the law.

DPF Regeneration Required Icon

If the icon “DPF Regeneration Required” lights on, means that the diesel particulate filter is becoming full and regeneration is needed; the icon flashes when the filter is full, maintain uninterrupted highway speed for an automatic regeneration or move the vehicle to a safe location and initiated a parked regeneration.

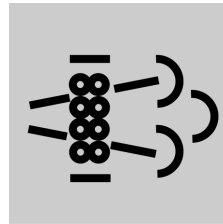

T0015482

High Exhaust System Temperature

The icon “High Exhaust System Temperature” lights on when a parked regeneration is initiated. It also indicates high exhaust gas temperature during an speed regeneration. When the high exhaust system temperature icon is light on, do not park or operate the vehicle near people, or any flammable materials, vapors, or structures.

For more information about Exhaust Aftertreatment System, see separated instruction “Exhaust Aftertreatment System”.

Note: It is important to enable regeneration as soon as possible to avoid engine problems. Long—term engine operation with regeneration disabled will result in a loss of engine performance including horsepower, torque and speed derates.

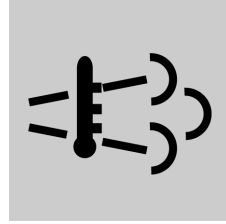

T0015483

Safe Driving

- 1 After starting, and regularly while driving, check that the instruments are giving their normal readings. If any warning lamp lights while driving, stop the bus and investigate the cause.
- 2 Never race a cold engine! Avoid idling for long periods.
- 3 Never cover the radiator! The thermostat keeps the temperature constant regardless of ambient conditions. Check the coolant level regularly and use always the correct type of coolant. Check the hoses/pipes and tensioning of the belts. Do not drive with a leaking cooling or heating system.
- 4 Never drive off before the brake system warning lamps have extinguished. Do not forget the parking brake. The ABS/EBS indicator lamps may light, but this only indicates that the ABS/EBS system is malfunctioning.
- 5 If one of the front wheels is blocked sideways, never try to force it to turn by applying excessive force to the steering wheel.
- 6 While driving downhill and for gradual braking use the retarder function. When driving in slippery conditions take special care, or disable the retarder function altogether.
- 7 When driving on slippery surfaces, e.g. in snow or heavy rain, reduce speed and avoid rapid steering wheel movements. Brake and accelerate gently, to make the journey as safe as possible for the passengers. Driving in slippery conditions requires extra caution when there are strong side winds. Side winds can produce a lifting force acting on the front axle.

Economy Driving

As the driver, you are the most important link in the chain for getting the best overall driving economy.

- 1 **Warm up the engine as quickly as possible.** A warm engine and transmission uses less fuel than a cold one (and there is less wear).
- 2 **Treat the accelerator pedal gently.** Do not “pump” the accelerator pedal. Pumping increases fuel consumption without increasing the speed. A turbo pressure gauge helps you drive economically.
- 3 **High speeds increase fuel consumption** since, among other things, air resistance increases sharply with increase of speed. Strong side and head winds increase fuel consumption even more.
- 4 **Timely and correct servicing will keep the bus in good condition. This will also contribute to preserving low fuel consumption.**

Driving in Cold Weather

Before driving in cold weather conditions (ambient temperature +40°F [5°C] or below), pay attention to the following points:

- 1 The cooling system must be protected against freezing.
- 2 The washer fluid tank must be filled with winter liquid.
- 3 Batteries must be in good condition. In low temperatures, the capacity of batteries to deliver current, e.g. when starting the engine, drops. Make sure that the poles of the batteries are thoroughly clean, with the cable terminals properly tightened and covered with grease, and that there is the correct amount of electrolyte in every cell.
- 4 Engine oil, as well as transmission and rear axle oil, must have the correct viscosity.

Fill up the tanks with winter fuel. This reduces the risk of wax settling in the fuel system. If this has already happened, change the fuel filters and fill up the tanks with winter fuel. Keep the tanks as full as possible.

The compressed air system is particularly sensitive to low temperatures. Excessive condensation in the primary tank indicates that the air drier is not working properly. Drain the tank and change the desiccator cartridge in the air drier. If none of these measures help, use an external heating source to thaw out the system.

Safety

Always make passenger safety your first priority!

If something unexpected happens you should always proceed as follows:

- 1 Stop the bus in a place which is safe for the passengers, and where the bus itself does not constitute an obstacle for other road users and switch on the hazard warning lights, see “Hazard Warning Lights”, page 29
- 2 Open the doors. If necessary use the emergency valve which is placed in the vicinity of the door.
- 3 Let the passengers out.
- 4 Set the ignition key in position 0.
- 5 Turn off the power with the main switch, see “Main Switch”, page 30.
- 6 If necessary, use the emergency stop, see “Emergency Stop”, page 31.
- 7 Place a warning triangle behind the bus. Remember that the distance between the warning triangle and the vehicle depends on local regulations.
- 8 Call the service center and describe the problem.

104 If Something Happens

If the Engine is Not Working

If the engine refuses to start, check that:

- 1 The cover of the emergency switch is down.
- 2 The main power switch on the dashboard is set to on.
- 3 The gear selector is in the neutral position, i.e. N.
- 4 The parking brake is engaged.
- 5 The switch in the control box in the engine bay is turned towards **1**.

The engine cannot be started when the battery voltage is too low (below 18 V).

The engine cannot be started if either the engine hatch or the front service hatch is open. In that case the display will show an appropriate symbol. Close the hatch before trying to start the engine.



T3018116

Punctures

There are several safety requirements that need to be considered in the event of a punctured tire. For detailed information concerning wheel changing, see the separate Operating Instruction “Jacking points and puncture”.

Punctured Air Springs

In the event of puncture of any of the suspension air springs, the speed **must** be reduced to **20 km/h (12 mph)** and the bus taken to the nearest service facility.

Towing



CAUTION

Failure to disconnect the driveshaft, remove the drive axle shaft(s) or lift the drive wheels off the ground before towing or pushing the vehicle, can cause serious transmission damage and void the transmission warranty.

Note: TCS should be turned off if one of the axles is raised during towing.

For all long distance towing, assure that the tow vehicle has the necessary equipment to reach the front axle, per Bus specifications. Refer to “Technical Specification”, page 123 for more information. It may be necessary for the tow vehicle to attach an air supply to the bus during towing. The position for attaching is available in the front of the bus. See the accompanying illustration for the general location.

Towing or moving the bus for short distances can also be performed using a towing rod or bar. Refer to the accompanying illustrations for attaching points location.

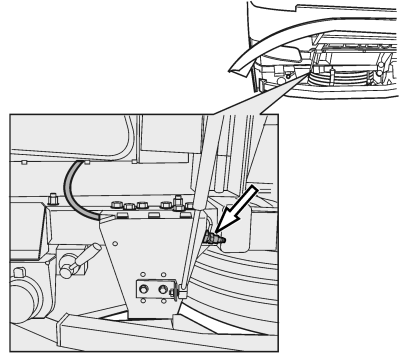

W1000252

Front Air Supply Connection Location

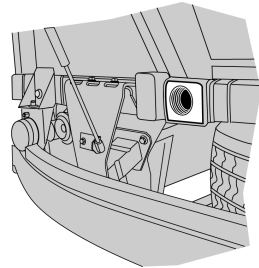

T8012390

Place for towing bar attachment (front).

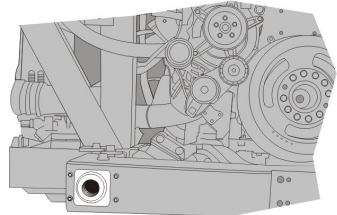

T8059309

Place for towing bar attachment (rear)

106 If Something Happens

After mechanically releasing the parking brake, the bus cannot be braked either with the main brake or with the parking brake. Block the wheels or connect to the tow vehicle, so that the bus cannot start moving after the parking brake has been released.

Towing requires either the drive shaft or both drive shafts to be removed, because otherwise the transmission may be damaged due to insufficient lubrication.

For, punctures, the tire must be repaired before towing begins.

Second Fire Detection Circuit

Bus 9700 is equipped with a second Fire Detection Circuit and in the event of fire, the STOP lamp lights up in the engine bay, an audible signal is emitted and a symbol appears on the display.



T001229
8

DANGER

Shut down the engine immediately!
Failure to do so may keep the radiator fan running which impels air into the engine bay and fans the fire. This may result in serious personal injury or death.

Releasing the Parking Brake

Release the Parking Brake with Air from the Bus Tires.

- 1 To prevent the bus from moving, block its wheels or attach it to a tow vehicle.
- 2 Connect the clamp head of the tire inflation hose to the valve of one of the tires.
- 3 Move the parking brake control to the drive position.
- 4 While pressing the other end of the tire inflation hose against the pump nipple, press in the blocking valve. Now the brake system is filled with the air from the tire. Filling can be interrupted as soon as the air flow stops.

Note: Chock the wheels to prevent the bus from moving when releasing the parking brake.

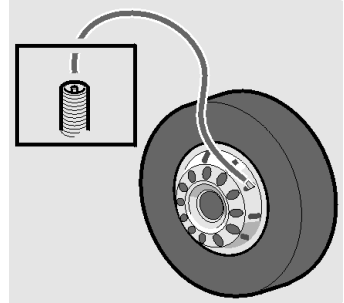

T0009182

108 If Something Happens

Mechanical Releasing of the Parking Brake

- 1 By blocking the wheels, make sure that the bus will not start rolling after releasing the parking brake.
- 2 On both drive shaft brake cylinders there are release bolts. Screw them out until a red plastic button appears out from the center of the bolt. The brakes are then released. This requires around 45 rotations. Use the designated wrench from the toolkit or the sleeve and locking handle.
- 3 The bus can now be towed. Towing should be performed using a properly equipped tow vehicle that can reach the front axle, since the bus is now completely without brakes.

Note: Do not forget to reset the bolts to their original position and attach the plastic cover after towing has been completed.



DANGER

Chock the wheels to prevent the bus from moving when releasing the parking brake. Failure to do so may result in serious personal injury or death.

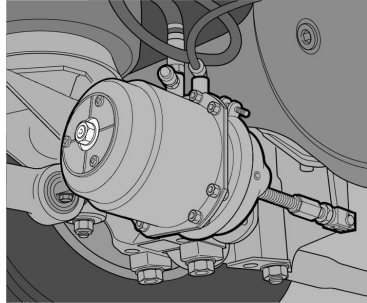

T5014634

Regarding Disc Brakes

The brake cylinder is fitted with a release screw, which does not protrude from the cylinder during manual release. When starting to release the parking brake, a red peg emerges from the centre of the nut. It is fully out after three turns. Full compression of the parking brake spring requires approximately 45 turns. Whenever possible try always to fill the parking brake cylinders with air. It makes it easier to turn the nuts of the release mechanisms.

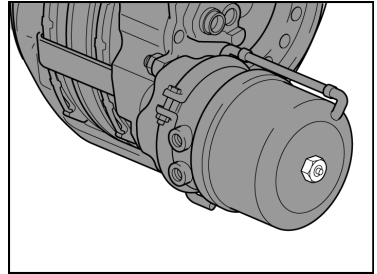

T5014635

110 If Something Happens

Changing the Batteries

When changing batteries, both batteries should have the same capacity and be of the same age. When connecting batteries correct polarity must be observed.

To change a battery:

- turn off the power with the main switch
- disconnect the cable terminal from the negative pole of the battery
- disconnect the cable terminal from the positive pole of the battery
- change the battery
- clean the cable terminals and both poles of the battery
- connect the positive cable terminal to the battery pole
- connect the negative cable terminal to the battery pole
- apply an anti-corrosive agent to the poles with terminals

If a cable clamp has been incorrectly installed, the battery terminal must be reamed to give a sufficiently large mating surface when correctly installed. Incorrect installation entails a high risk of oxidation in the space between the top of the battery terminal and the battery cable clamp.

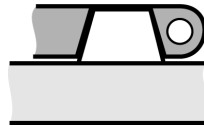
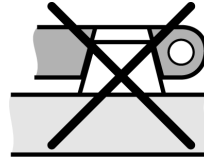

T3019198

Top: Mounted incorrectly, terminal not bottoming on the pole.

Bottom: Mounted correctly, terminal bottoming on the pole.



WARNING

Incorrect connection will seriously damage the electrical system.

Starting Assistance

In the event that the batteries are unable to start the engine, auxiliary batteries can be used to help in starting. These batteries are connected in parallel with the ordinary bus batteries.

Note: Note the polarity. Plus to plus and minus to minus.



CAUTION

Battery chargers with a start boost feature must not be used for starting assistance. Failure to do so may cause damage to the electrical system.

Battery Cut-off Switch

The battery cut-off switch is located next to the batteries and is there to completely cut off the bus power supply. To prevent battery discharge when the bus is standing for 24 hours or more, turn the battery cut-off switch to the OFF position.

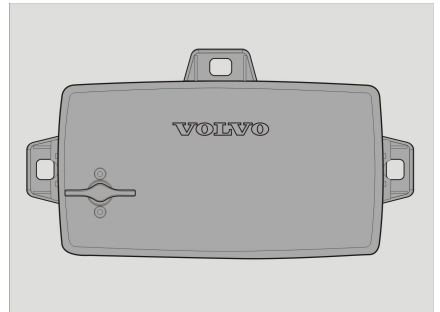

T8057553

112 If Something Happens



CAUTION

Always switch off the power with the cut-off switch when charging the batteries and when connecting an auxiliary batteries to start the engine.



CAUTION

Before using the battery cut-off switch, the power must always be switched off using the main switch on the dashboard. Failure to do so may cause damage to the electrical system.

Note: After using the battery cut-off switch, it may be necessary to re-enter the radio code.

Bulb Replacement

Headlamps

- Lift the front bumper
- Loosen the securing screws (A) and (B), delicately lower the lamp module and tilt it open
- Disconnect power supply cables
- Remove the bulb

Note: Replace it with a new bulb of the same type and power rating.

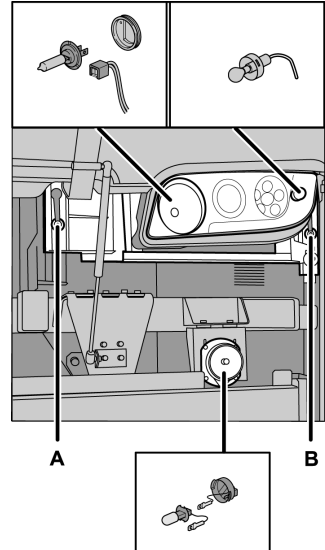

T8012393

Rear Lights

- Unscrew the five screws securing the cover
- Replace the bulb
- Before fitting the lamp check whether it is working properly

Note: Make sure that the bulb is replaced with a new bulb of the same type and power rating.

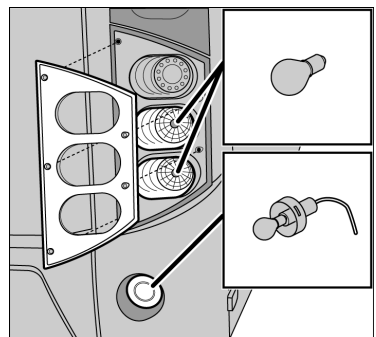

T3019941

114 If Something Happens

Xenon Lights



DANGER

Xenon lights should only be serviced at an authorized service facility. Never try to repair the lights on your own. Ignition voltage in xenon bulbs is **28,000 V**. Servicing these lights without the necessary knowledge and service information may result in serious personal injury or death.

Licence Plate Lighting

Replace the licence plate lamp as follows:

- Unscrew the screws securing the lamp
- Replace the lamp

Fuses and Relays (chassis)

The fuse and relay box is located at the front right of the bus, next to the entrance stairs and under the division wall.

116 If Something Happens

Relays

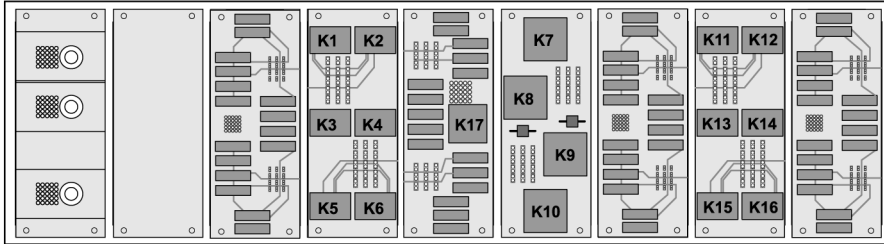

T0012034

Relays			
K1	FTM (Fuel Tank Monitor)	K11	Start inhibit relay
K2	Load indicator	K12	Starting signal, starter motor
			Luggage compartment lighting (alternative)
K3	Self-holding relay, ECS	K13	Emergency switch
K4 ¹	TCM (Transmission Control Module) GSECU (Gear Shift Electronic Control Unit) I-shift gearbox	K14 ¹	Spare
K5 ¹	Spare	K15 ¹	Spare
K6 ¹	Spare	K16 ¹	Spare
K7	Starter motor	K17	Ignition relay (+15)
K8 ¹	VECU (Vehicle Electronic Control Unit), ECM (Engine Control Module)	K48 ²	Preheating relay
K9	Interval relay, windscreen washer wiper motor	K51 ³	Main power supply relay
K10 ¹	Pre filter fuel heater		

1 Depends on version

2 This is located on the engine bay bracket near the emergency stop.

3 This is located in a steel box next to the battery box.

Fuses

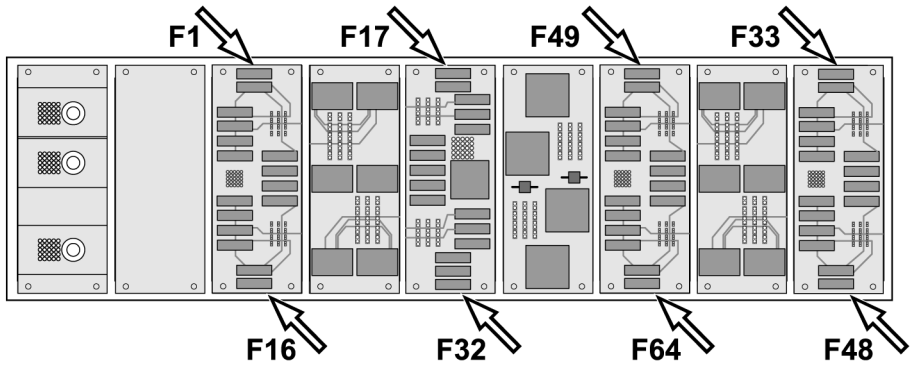

T0012035

Fuses					
F1	5A	ECS (Electronic Controlled Suspension)	F35	25A	LCM (Lighting Control Module)
F2	10A	BIC2 (instrument), control switch	F36	25A	LCM (Lighting Control Module)
F3	15A	Pre filter fuel heater	F37	25A	LCM (Lighting Control Module)
F4	20A	EBS (Electronic Brake System)	F38	—	Spare
F5	5A	Horn	F39 ¹	25A	Exhaust emissions cleaning control unit
F6	5A	Emergency release of parking brake	F40	—	Spare
	30A	Ignition switch (Early version)			
F7 ¹	15A	TCM (Transmission Control Module), GSECU (Gear Shift Electronic Control Unit)	F41 ¹	20A	Radio
				—	Spare
F8 ¹	5A	GSECU (Gear Shift Electronic Control Unit)	F42	5A	Emergency stop switch, main switch
F9	5A	Starting switch, engine compartment	F43	—	Spare
F10	5A	Fire Alarm	F44	25A	LCM (Lighting Control Module)

118 If Something Happens

Fuses					
F11 ¹	10A	FMS (Fleet Management System)	F45	25A	LCM (Lighting Control Module)
F12	5A	Supply, main switch (+30) to body-builder outlet	F46	25A	LCM (Lighting Control Module)
F13	10A	Oilmaster	F47	5A	Side position lamp, right-hand side
F14	5A	BBM (Body Builder Module)	F48	5A	Side position lamp, left-hand side
F15	15A	ECM (Engine Control Module), Control valve * (1) ¹ , radiator fan, preheating relay	F49	5A	Fuel shut-off valve
F16	5A	VECU (Vehicle Control Unit)	F50 ¹	10A	RECU (Retarder Control Unit)
F17	5A	Switch feed	F51 ²	20A	Radio, 24–12 V (+30) converter
				—	Spare
F18	5A	Alternator 1, 2, 3	F52 ¹	10A	Baggage hold lighting
F19 ¹	10A	Hymer, oilmaster, starter motor	F53 ¹	5A	Trailing axle, dehydrator heater
F20	10A	EBS (Electronic Brake System)	F54	5A	Engine hatch/luggage compartment hatch
F21	15A	Wiper motor, windscreen	F55	10A	Engine break valve, preheat relay, fan speed clutch
F22	10A	TCM (Transmission Control Module), Voith automatic gearbox	F56	5A	Preheating relay
				10A	Dehydrator heater
F23	5A	FMS (fleet management system)	F57	5A	Engine brake
F24	5A	BIC2 (instrument panel), OBD2	F58	5A	Ignition key/Start switch
F25	15A	Washer motor	F59	—	FTM (Fuel Tank Monitor)
					Spare

Fuses					
F26	5A	ECS (Electronic Controlled Suspension)	F60	10A	TCM (Transmission Control Module), ZF automatic transmission/gearbox
F27	10A	Spare	F61	10A	Baggage hold lighting
F28	10A	RECU (Retarder Control Unit)	F62	20A	Dimmed interior lighting
				—	Spare
F29	5A	Power from the ignition (+15) to body electrical system connector	F63	5A	LKS / DAS (Lane Keeping System/ Driver's Assisted System)
				—	Spare
F30	5A	Radio, 24–12 V (+15) converter ²	F64	10A	Load indicator
	20A	Fuel heater			
F31	5/10 A	Hydraulic oil level, hydraulic oil filter, exhaust emissions cleaning control unit	F80 ³	150 A	Main battery fuse (B+)
F32	5A	Tachograph	F81	80A	Power supply main fuse (+30)
F33	5A	BIC2 (instrument)	F93	5A	Alternator
F34	—	Spare			

1 Depends on version.

2 Loose fuse holder next to it.

3 This is located in a steel box next to the battery box.

120 If Something Happens

Fuses and relays (body)

The fuse and relay box is located at the front right of the bus, next to the entrance stairs and under the division wall.

Relays

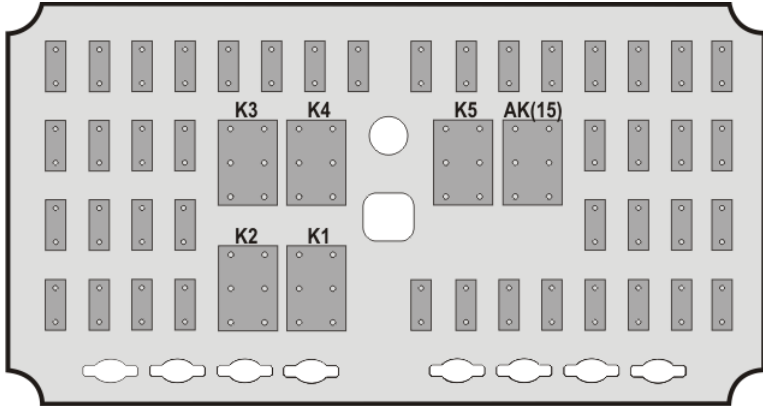

T8059319

Relays			
AK(15)	Loads +15	K3	Defroster, speed 2
K1	Over speed control 95 km/h [59 mph]	K4	Defroster, speed 3
K2	Defroster, speed 1	K5	Free relay

Fuses

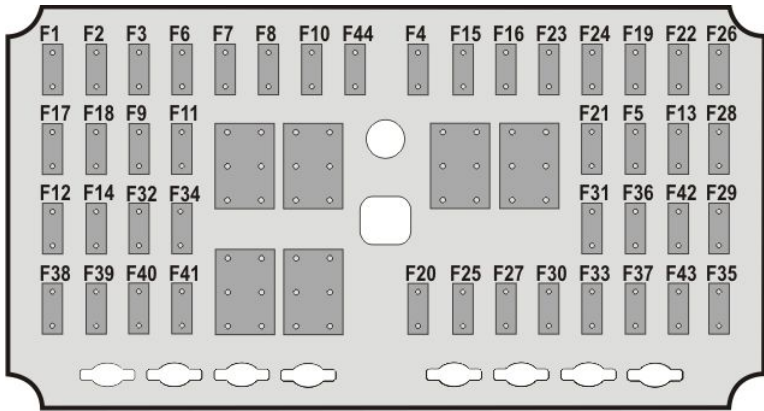

T8058916

122 If Something Happens

Fuses					
F1	3A	Power Master ID	F23	5A	Light under seats
F2	5A	Transcom	F24	5A	Middle door I/O A Module
F3	20A	Audio & Video 12V	F25	5A	Webasto Timer 3
F4	30A	Feed Relay K5	F26	5A	Dashboard I/O Module
F5	30A	Floor I/O B Module	F27	30A	24V CD Output in Driver side
F6	5A	Climate I/O A Module	F28	5A	Pressure switch
F7	5A	Climate unit I/O A	F29	3A	Copiloto/ V-Link
F8	5A	Defroster Flap	F30	5A	Control panel air
F9	5A	Red led switches	F31	3A	Feed +15 TD7
F10	20A	Defroster	F32	5A	Mobitec (+15)
F11	30A	Floor Left 2 I/O B Module	F33	15A	DRC Air Conditioning
F12	7.5A	Mobitec control & CECM MSW signal.	F34	20A	Audio & Video (+15)
F13	7.5A- /15A	Left & Middle Toilet I/O B Module/FSS	F35	10A	Park Pilot
F14	20A	Electric Window	F36	5A	Time & Temperature display
F15	30A	Wheel Chair Lift	F37		FREE
F16	30A	Roof Left I/O Module	F38	3A	V-Link
F17	5A	Webasto Timer 2	F39	7.5A	Roof Hatch Front
F18	20A	Audio & Video 24 V	F40	5A	Middle door, I/O A Module
F19	7.5A	Toilet I/O B Module	F41	5A	Webasto Timer 1
F20	15A	Dashboard converter, cigarette output	F42	15A	Electrical Binder
F21	5A	Copiloto, TD7	F43	30A	Auxiliary heater
F22	15A	CECM B	F44	15A	Free over speed relay

Technical Specification

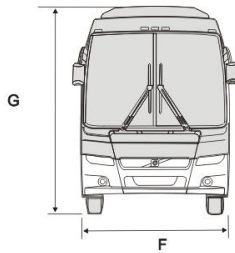
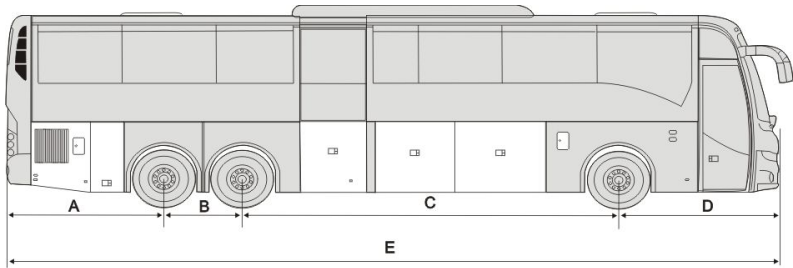

T8061190

Technical Specification	
	3-axle 13.7m
A	2,780 mm (109 in.)
B	1400 mm (55 in.)
C	6660 mm (262 in.)
D	2,850 mm (112 in.)
E	13,690 mm (539 in.)
F	2600 mm (102 in.)
G	3671 mm (145 in.)

124 Technical Data

Bulbs

Light	Rated Power	Volvo p/n
Main beam	70 W	990037
Dipped beam	35 W	21008653
Direction indicator, front	21 W	982558
Direction indicator, rear	21 W	982558
Fog lamps, front	70 W	943903
Reversing	21 W	967708

Type Plates

The vehicle identification number (VIN) is marked on an identification plate on the bus.

Identification Plate

Within its inside border, the identification plate is subdivided into a legal requirement section, as well as three boxes for the chassis number, drive and wheelbase. These latter are not used for buses, only for lorries. The identification plate is located by the driver's seat and contains the following information:

- G.V.W.R (Gross vehicle weight rating), is the maximum allowable total weight of the vehicle.
- G.A.W.R (Gross axle weight rating), is the maximum distributed weight that may be supported by an axle VIN is the same number that can be found on the frame member.
- Tires dimensions.
- Rims dimensions
- Cold inflation pressure, is the inflation pressure of the tires before the vehicle is driven and the tires warmed up.
- VIN is the same number that can be found on the frame member.



MANUFACTURED BY: VOLVO BUS CORPORATION
 FABRIQUE PAR: VIM

DATE OF MFG:
 DATE DE FAB:

G.V.W.R.: 22407 KG. (49400 LBS)
 P.N.B.Y.:

AXLES/ESSEUX	G.A.W.R./P.A.B.E.		TIRES/PNEUS	RIMS/JANTES	COLD INFLATION PRESS./PRESS. A FROID		SINGLE OR DUAL/SIMPLE OU DOUBLE
	KG	LBS			KPA	PSI	
FRONT/AVANT	7484	(16500)	315 / 80R22.5(J)	22.50,00	830	(120)	S
REAR/ARRIERE	10024	(22100)	315 / 80R22.5(J)	22.50,00	820	(90)	D
REAR TANDEM	4800	(10500)	315 / 80R22.5(J)	22.50,00	600	(85)	S

THIS VEHICLE CONFORMS TO ALL APPLICABLE U.S. FEDERAL MOTOR VEHICLE SAFETY STANDARDS AND CANADIAN MOTOR VEHICLE SAFETY REGULATIONS IN EFFECT ON THE DATE OF MANUFACTURE SHOWN ABOVE. VEHICULE EST CONFORME A TOUTES LES NORMES QUI LUI SONT APPLICABLES EN VERTU DU REGLEMENT SUR LA SECURITE DES VEHICULES AUTOMOBILES DU CANADA EN VIGUEUR A LA DATE DE SA FABRICATION INDIQUEE CI-HAUT.

VEHICLE IDENTIFICATION NO.
NO. IDENTIFICATION VEHICULE

TYPE: BUS / BIA

T0015663

126 Technical Data

Vehicle Identification (VIN)

This is stamped on the chassis at the right-hand front end of the vehicle, i.e. in the wheel arch in front of or behind the front axle.

Example: **YV3R7G62151106335**

YV3	Manufacturer
R7	Chassis version
G6	Engine version
2	Brake system
1	Check figure
5	Model year
1	Assembly factory
106335	Chassis number

Engine

Type designation, component number and serial number are punched on the top of engine block near the injector pump.

Transmission

The type designation and serial number are punched on the top of the transmission.

Rear Axle

The plate is on the right-hand side of the rear axle housing.

Retarder

Serial number and version are stamped on rear left side of retarder housing.

Service Intervals

Regular servicing in accordance with the special service schedule is required to maintain the bus to its original specifications throughout its service life.

Carry out all servicing and maintenance of the bus at a Volvo workshop or, for Prevost support vehicles, in Prevost service center/provider.

These workshops have the trained personnel, special tools and necessary service literature that are vital in ensuring high quality of servicing. This quality also depends on the use of Volvo Original parts, which are of identical quality to the components installed at the Volvo manufacturing facility.

For service intervals, see the separate service literature.

When washing the bus, only use agents that are intended for this purpose. See also: Operating Instruction "Interior maintenance".

VOLVO

Volvo Bus Corporation

Göteborg, Sweden

Driver's Handbook

Electronic Brake System (EBS)
Multiplex electrical system Version 2

VOLVO

Foreword

This manual contains information concerning the operation and function of the Electronic Brake System (EBS). The information in this manual applies to vehicles built January 2009 and later. Please keep this manual in the vehicle at all times.

Note: Illustrations in this manual are used for reference only and may differ slightly from the actual vehicle. However, key components addressed in this document are represented as accurately as possible.

Volvo Bus Corporation

Göteborg, Sweden

Order number: PV776-20196363

© 2009 Volvo Bus Corporation, Göteborg, Sweden

All rights reserved. No part of this publication may be reproduced, stored in retrieval system, or transmitted in any forms by any means, electronic, mechanical, photocopying, recording or otherwise, without the prior written permission of Volvo Bus Corporation

Contents

About EBS	1
General	1
Manually Engaged Functions	2
Antispin (Traction Control System, TCS)	2
Brake Blending	4
Engage Differential Lock	4
Automatic Engagement of Differential Lock (DLC — Differential Lock Control)	6
Hill Start Assistance	7
Automatic Functions	8
ABS	8
Electronic Stability Program (ESP)	8
Engine Torque Control	9
Emergency Braking Assistance	9
Equalizing Brake Pad Wear	9
Predicted Brake Pad Wear	10
Warning of High Brake Temperature	10
Wheel Brake Monitoring	10
Fault Codes	11
Resetting Fault Codes	11

Safety Information

IMPORTANT: Before driving this vehicle, be certain that you have read and that you fully understand each and every step of the driving and handling information in this manual. Be certain that you fully understand and follow all safety warnings.

IT IS IMPORTANT THAT THE FOLLOWING INFORMATION BE READ, UNDERSTOOD AND ALWAYS FOLLOWED.

The following types of advisories are used throughout this manual:



DANGER

Danger indicates an unsafe practice that could result in serious personal injury or death. A danger advisory banner is in **white** type on a **black** background with a **black** border.



WARNING

Warning indicates an unsafe practice that could result in personal injury. A warning advisory banner is in **black** type on a **gray** background with a **black** border.



CAUTION

Caution indicates an unsafe practice that could result in damage to the product. A caution advisory is in **black** type on a **white** background with a **black** border.

Note: Note indicates a procedure, practice, or condition that must be followed in order for the vehicle or component to function in the manner intended.

General

EBS (for multiplex electrical system Version 2) does not work in the same way as previous braking systems. In previous braking systems a particular pressure to the pedal applied a particular pressure to the braking system. With EBS a particular pressure to the pedal now gives a particular reduction in speed, while the pressure applied to the brake cylinders on the axles varies depending on the load of the axles.

The initial braking after reloading can identify differences and allows the braking system has to adjust to the new axle loading.

2 Manually Engaged Functions

Antispin (Traction Control System, TCS)

The Traction Control System (TCS) automatically reduces engine torque in the event of wheel spin. At speeds below 40 km/h (25 mph), TCS also functions as an automatic differential brake and brakes the driving wheels on one side when required.

Off-road TCS

Engage the off-road TCS in difficult conditions, such as on sand, gravel or snow. TCS then allows the wheels to spin more. The function is activated by pressing the switch. Disengage the off-road TCS by pressing the switch again. When the off-road TCS is engaged an indicator on the switch lights up, at the same time as the level for engaging Electronic Stability Program (ESP) is raised slightly.

Note: Do not use the off-road TCS during normal driving.



T3014400

Display symbol when TCS is activated.

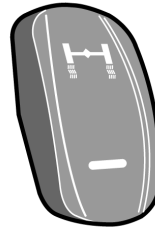

T0012059

Disengage TCS

Use the display control lever to disengage the TCS. The vehicle should be stationary. Please refer to the “Drivers Information Display (DID)” manual for more information about the display functions.

- 1 Scroll to the “Settings” menu (3 and 4)
- 2 Press “Select” (2)
- 3 Scroll to the “Traction control” menu (3 and 4)
- 4 Press “Select” (2)
- 5 Scroll to “Off” (3 and 4)
- 6 Press “Select” (2)

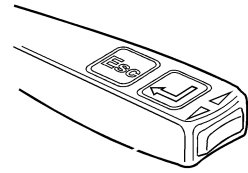

T3008810

The next time that the ignition key is turned to the drive position or the front axle rotates faster than 12 km/h (7 mph) the TCS will engage again.

Note: Switch off TCS before towing with a raised axle!

Note: Disengage the TCS during rolling brake tests!

If TCS is Activated After Changing a Wheel

If a smaller wheel is installed on the drive axle TCS may be activate.

Drive faster than 25 km/h (16 mph). The EBS system learns the difference in size between the wheels. How long for depends on how great the difference in size between the wheels is.

It may be difficult to drive because the TCS is limiting the engine torque. In this case engage terrain TCS (“Off-road TCS” page 2). Terrain TCS permits greater differences in wheel speed between the front axle and the driven axle. When Terrain TCS is engaged, it will take longer for the EBS system to learn the difference of the new wheel size.

4 Manually Engaged Functions

Brake Blending

When the retarder lever is in the “A” position, the supplementary brakes are applied together with the normal brakes when the brake pedal is pressed.

The EBS ensures that the different brakes are used in the most effective way. The supplementary brakes are used as much as possible and the normal brakes are applied as required.

Note: The “B” position for the lever is only available on vehicles built with the I-Shift transmission. This position activates a braking program that allows a higher engine speed when engine braking is applied.

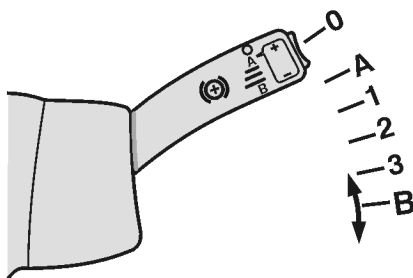

T0010263

Put the lever in position “A”

Engage Differential Lock

(This function is an option.)

On vehicles equipped with a differential lock, the differential lock can be coupled without pressing down the coupling. When the switch is pressed at speeds (below 40 km/h (25 mph)), the EBS system will slow the wheels so that they are all rotating at the same speed when the differential lock is engaged. At speeds above 40 km/h (25 mph) the EBS system waits (it does not brake the wheels) until the wheels are rotating at the same speed before engaging the differential lock.

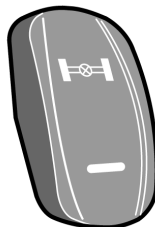

T0012041

Differential lock engaged. The light on the instrument panel flashes.

For automatic engagement of the differential lock see “Automatic Engagement of Differential Lock (DLC — Differential Lock Control)” page 6 .

- 1 Set the switch to the lower position
- 2 Wait until the indicator light on the instrument panel flashes
- 3 Accelerate **carefully** so not to damage the drive axle and gear
- 4 Drive away from the slippery area
- 5 Release the accelerator
- 6 Disengage the differential lock

Note: The differential lock is not engaged until the warning lamp on the instrument panel flashes. **And remains engaged as long as the warning lamp is flashing, even if the switch is turned off.**

6 Manually Engaged Functions

Automatic Engagement of Differential Lock (DLC — Differential Lock Control)

(This function is an option.)

Put the differential lock switch in the center position. The DLC is then activated.

The differential lock engages automatically when the drive wheels turn at different speeds and vehicle speed is below 15 km/h (9 mph).

The differential lock disengages if the vehicle speed exceeds 15 km/h (9 mph) or at the next gear shift.

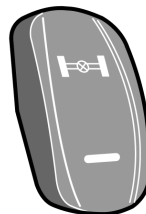

T0012041

Overview of the Switch Functions

Switch position	Function
0 (upper position)	No differential lock engaged.
1 (center position)	DLC engaged.
2 (lower position)	Differential lock manually engaged.

Manual Engagement of the Differential Lock

See “Engage Differential Lock” page 4 .

Hill Start Assistance

(This function is an option.)

The function is activated by pressing the switch. The lamp on the switch, then lights up to indicated the activation.

Note: The function works differently depending on whether the vehicle is equipped with a manual or automatic transmission.

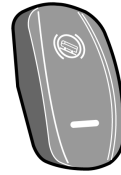

T0012045

Switch for hill start help.

- 1 Keep the bus still with the brake pedal
- 2 Release the foot brake.
The brake pressure is automatically retained for a few moments.
The symbol in the display is shown as long as the brakes are applied.
- 3 Start accelerating.

The brakes are automatically released two seconds after the brake pedal is released, or when the engine torque is sufficient.

Deactivate the function by pressing the switch again. The function is always disengaged when the engine is started.

8 Automatic Functions

ABS

ABS is part of EBS and is fully automatic.

Electronic Stability Program (ESP)

(This function is an option.)

ESP is a stabilizing system that reduces the risk of overturning and skidding.

If the system senses that the bus is going to tip over. It first cuts back the engine. If this is not sufficient, it then applies the wheel brakes to reduce the speed of the vehicle.

If the system senses a risk of skidding, it cuts back the engine and applies the wheel brakes as necessary to hold the vehicle on its course. If necessary, the supplementary brakes are also disengaged.



T0012128

The displays shows the symbol for ESP engaged because of the risk of tipping.



T3014400

Display symbol when the ESP is activated because of the risk of skidding.



WARNING

Drive the vehicle in the same way as vehicles without an ESP. ESP reduces the risk of tipping and skidding, but a bus can still tip over if the center of gravity is very high and the wheels hit a curb at high speed, or by careless driving. A bus can skid on slippery surfaces even if it is equipped with ESP.

Do not drive buses equipped with ESP through steeply banked curves (for example on a test track). Driving through steeply banked curves can cause the ESP to be engaged unnecessarily, which could be dangerous.

Engine Torque Control

(This function is an option.)

When the accelerator is released on a slippery road, the supplementary brake or the engine brake can lock the driving wheels. When this happens the supplementary brake is disengaged and the engine drives the driving wheels until they rotate at the same speed as the front wheels. This does not happen if the transmission is in neutral, the ABS is activated or the vehicle speed is less than 10 km/h (6 mph).



T3014400

Display symbol for regulation of engine torque.

Emergency Braking Assistance

(This function is an option.)

When the brake pedal is pressed quickly and forcefully the braking pressure is higher and the braking effect stronger. This function is there to enable rapid application of full braking force in emergency situations.

Equalizing Brake Pad Wear

Note: Does not apply to low entry buses.

If the brake pads wear more on one axle than another, greater braking force is distributed to the other wheels to even out the wear.

Note: This function works during gentle braking. During harder braking the braking force is divided so that braking occurs as effectively as possible.

A warning symbol is shown on the display panel when a brake shoe becomes more than 80% worn.



T5013668

Display symbol when a brake shoe is more than 80% worn.

Low Entry Buses

Buses with low entry have a wear warning, but do not perform the brake shoe wear evening function. The wear warning only applies to the drive and running axle, when the front axle has no wear sensor.

Predicted Brake Pad Wear

Note: Does not apply to low entry buses.

(This function is an option.)

The “Vehicle Data” menu displays information about when the brake linings must be replaced. This information can also be read off by a Volvo service shop.

Warning of High Brake Temperature

If the brakes become too hot the “CHECK” lamp illuminates and a symbol is shown on the display.

Note: If the temperature is allowed to rise even further, the feeling of the brakes changes so that the pedal has to be pressed harder to obtain the same braking effect as before.



T5013670

Warning symbol for high brake temperature.

Wheel Brake Monitoring

(This function is an option.)

If the braking effect on a wheel is weaker than on the other wheels, the “CHECK” lamp illuminates and a symbol is shown on the display. This does not necessarily mean that braking feels different as the other wheels brake harder. However a fault code is stored in the system and a Volvo service shop should examine the braking system.



T3014494

Warning symbol for poor braking effect.

Resetting Fault Codes

If the brake pedal is pressed when the pressure in the braking system is too low, several fault codes can be set. These codes can be removed in the following way:

- 1 Ensure that the vehicle is stationary.
- 2 Check the display to see that the air pressure is at least 9 bar (130 psi). If it is not, start the engine to allow the pneumatic system to pressurize.
- 3 Switch off the ignition so that the control unit is reset.
- 4 Start the engine without touching the foot brake.
- 5 Wait at least five seconds.
- 6 Slowly depress the foot brake until it is fully depressed (it should take at least one second to be fully applied from when it is released).
- 7 Hold the foot brake fully depressed for at least seven seconds.
- 8 Release the foot brake slowly (it should take at least one second from fully applied to when it is released).
- 9 Switch off the ignition.
- 10 Wait at least five seconds.
- 11 Switch the ignition on.
- 12 Check the fault codes.

After resetting, the fault codes should be inactive. Otherwise the fault remains.

If it takes longer than 25 seconds to carry out steps 10, 11 and 12 or the fault codes will not be deactivated.

Note: If the above procedure does not help, contact a Volvo service shop for further examination of the system.

VOLVO

Volvo Bus Corporation

Göteborg, Sweden

Driver's Handbook

Electronic Brake System (EBS)
Multiplex electrical system Version 2

VOLVO

Foreword

This manual contains information concerning the operation and function of the Electronic Brake System (EBS). The information in this manual applies to vehicles built January 2009 and later. Please keep this manual in the vehicle at all times.

Note: Illustrations in this manual are used for reference only and may differ slightly from the actual vehicle. However, key components addressed in this document are represented as accurately as possible.

Volvo Bus Corporation

Göteborg, Sweden

Order number: PV776-20196363

© 2009 Volvo Bus Corporation, Göteborg, Sweden

All rights reserved. No part of this publication may be reproduced, stored in retrieval system, or transmitted in any forms by any means, electronic, mechanical, photocopying, recording or otherwise, without the prior written permission of Volvo Bus Corporation

Contents

About EBS	1
General	1
Manually Engaged Functions	2
Antispin (Traction Control System, TCS)	2
Brake Blending	4
Engage Differential Lock	4
Automatic Engagement of Differential Lock (DLC — Differential Lock Control)	6
Hill Start Assistance	7
Automatic Functions	8
ABS	8
Electronic Stability Program (ESP)	8
Engine Torque Control	9
Emergency Braking Assistance	9
Equalizing Brake Pad Wear	9
Predicted Brake Pad Wear	10
Warning of High Brake Temperature	10
Wheel Brake Monitoring	10
Fault Codes	11
Resetting Fault Codes	11

Safety Information

IMPORTANT: Before driving this vehicle, be certain that you have read and that you fully understand each and every step of the driving and handling information in this manual. Be certain that you fully understand and follow all safety warnings.

IT IS IMPORTANT THAT THE FOLLOWING INFORMATION BE READ, UNDERSTOOD AND ALWAYS FOLLOWED.

The following types of advisories are used throughout this manual:



DANGER

Danger indicates an unsafe practice that could result in serious personal injury or death. A danger advisory banner is in **white** type on a **black** background with a **black** border.



WARNING

Warning indicates an unsafe practice that could result in personal injury. A warning advisory banner is in **black** type on a **gray** background with a **black** border.



CAUTION

Caution indicates an unsafe practice that could result in damage to the product. A caution advisory is in **black** type on a **white** background with a **black** border.

Note: Note indicates a procedure, practice, or condition that must be followed in order for the vehicle or component to function in the manner intended.

General

EBS (for multiplex electrical system Version 2) does not work in the same way as previous braking systems. In previous braking systems a particular pressure to the pedal applied a particular pressure to the braking system. With EBS a particular pressure to the pedal now gives a particular reduction in speed, while the pressure applied to the brake cylinders on the axles varies depending on the load of the axles.

The initial braking after reloading can identify differences and allows the braking system has to adjust to the new axle loading.

2 Manually Engaged Functions

Antispin (Traction Control System, TCS)

The Traction Control System (TCS) automatically reduces engine torque in the event of wheel spin. At speeds below 40 km/h (25 mph), TCS also functions as an automatic differential brake and brakes the driving wheels on one side when required.

Off-road TCS

Engage the off-road TCS in difficult conditions, such as on sand, gravel or snow. TCS then allows the wheels to spin more. The function is activated by pressing the switch. Disengage the off-road TCS by pressing the switch again. When the off-road TCS is engaged an indicator on the switch lights up, at the same time as the level for engaging Electronic Stability Program (ESP) is raised slightly.

Note: Do not use the off-road TCS during normal driving.



T3014400

Display symbol when TCS is activated.

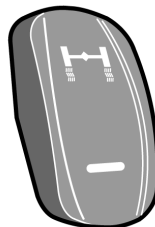

T0012059

Disengage TCS

Use the display control lever to disengage the TCS. The vehicle should be stationary. Please refer to the “Drivers Information Display (DID)” manual for more information about the display functions.

- 1 Scroll to the “Settings” menu (3 and 4)
- 2 Press “Select” (2)
- 3 Scroll to the “Traction control” menu (3 and 4)
- 4 Press “Select” (2)
- 5 Scroll to “Off” (3 and 4)
- 6 Press “Select” (2)

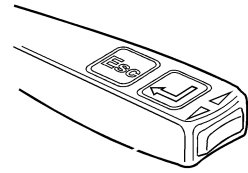

T3008810

The next time that the ignition key is turned to the drive position or the front axle rotates faster than 12 km/h (7 mph) the TCS will engage again.

Note: Switch off TCS before towing with a raised axle!

Note: Disengage the TCS during rolling brake tests!

If TCS is Activated After Changing a Wheel

If a smaller wheel is installed on the drive axle TCS may be activate.

Drive faster than 25 km/h (16 mph). The EBS system learns the difference in size between the wheels. How long for depends on how great the difference in size between the wheels is.

It may be difficult to drive because the TCS is limiting the engine torque. In this case engage terrain TCS (“Off-road TCS” page 2). Terrain TCS permits greater differences in wheel speed between the front axle and the driven axle. When Terrain TCS is engaged, it will take longer for the EBS system to learn the difference of the new wheel size.

4 Manually Engaged Functions

Brake Blending

When the retarder lever is in the “A” position, the supplementary brakes are applied together with the normal brakes when the brake pedal is pressed.

The EBS ensures that the different brakes are used in the most effective way. The supplementary brakes are used as much as possible and the normal brakes are applied as required.

Note: The “B” position for the lever is only available on vehicles built with the I-Shift transmission. This position activates a braking program that allows a higher engine speed when engine braking is applied.

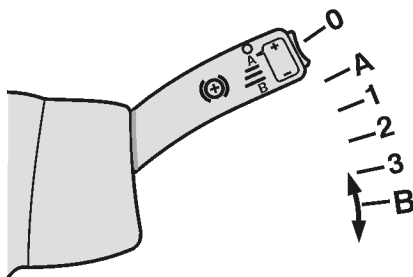

T0010263

Put the lever in position “A”

Engage Differential Lock

(This function is an option.)

On vehicles equipped with a differential lock, the differential lock can be coupled without pressing down the coupling. When the switch is pressed at speeds (below 40 km/h (25 mph)), the EBS system will slow the wheels so that they are all rotating at the same speed when the differential lock is engaged. At speeds above 40 km/h (25 mph) the EBS system waits (it does not brake the wheels) until the wheels are rotating at the same speed before engaging the differential lock.

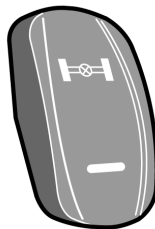

T0012041

Differential lock engaged. The light on the instrument panel flashes.

For automatic engagement of the differential lock see “Automatic Engagement of Differential Lock (DLC — Differential Lock Control)” page 6 .

- 1 Set the switch to the lower position
- 2 Wait until the indicator light on the instrument panel flashes
- 3 Accelerate **carefully** so not to damage the drive axle and gear
- 4 Drive away from the slippery area
- 5 Release the accelerator
- 6 Disengage the differential lock

Note: The differential lock is not engaged until the warning lamp on the instrument panel flashes. **And remains engaged as long as the warning lamp is flashing, even if the switch is turned off.**

6 Manually Engaged Functions

Automatic Engagement of Differential Lock (DLC — Differential Lock Control)

(This function is an option.)

Put the differential lock switch in the center position. The DLC is then activated.

The differential lock engages automatically when the drive wheels turn at different speeds and vehicle speed is below 15 km/h (9 mph).

The differential lock disengages if the vehicle speed exceeds 15 km/h (9 mph) or at the next gear shift.

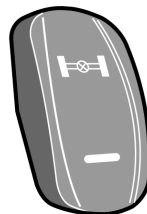

T0012041

Overview of the Switch Functions

Switch position	Function
0 (upper position)	No differential lock engaged.
1 (center position)	DLC engaged.
2 (lower position)	Differential lock manually engaged.

Manual Engagement of the Differential Lock

See “Engage Differential Lock” page 4 .

Hill Start Assistance

(This function is an option.)

The function is activated by pressing the switch. The lamp on the switch, then lights up to indicated the activation.

Note: The function works differently depending on whether the vehicle is equipped with a manual or automatic transmission.

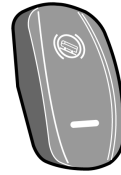

T0012045

Switch for hill start help.

- 1 Keep the bus still with the brake pedal
- 2 Release the foot brake.
The brake pressure is automatically retained for a few moments.
The symbol in the display is shown as long as the brakes are applied.
- 3 Start accelerating.

The brakes are automatically released two seconds after the brake pedal is released, or when the engine torque is sufficient.

Deactivate the function by pressing the switch again. The function is always disengaged when the engine is started.

8 Automatic Functions

ABS

ABS is part of EBS and is fully automatic.

Electronic Stability Program (ESP)

(This function is an option.)

ESP is a stabilizing system that reduces the risk of overturning and skidding.

If the system senses that the bus is going to tip over. It first cuts back the engine. If this is not sufficient, it then applies the wheel brakes to reduce the speed of the vehicle.

If the system senses a risk of skidding, it cuts back the engine and applies the wheel brakes as necessary to hold the vehicle on its course. If necessary, the supplementary brakes are also disengaged.



T0012128

The displays shows the symbol for ESP engaged because of the risk of tipping.



T3014400

Display symbol when the ESP is activated because of the risk of skidding.



WARNING

Drive the vehicle in the same way as vehicles without an ESP. ESP reduces the risk of tipping and skidding, but a bus can still tip over if the center of gravity is very high and the wheels hit a curb at high speed, or by careless driving. A bus can skid on slippery surfaces even if it is equipped with ESP.

Do not drive buses equipped with ESP through steeply banked curves (for example on a test track). Driving through steeply banked curves can cause the ESP to be engaged unnecessarily, which could be dangerous.

Engine Torque Control

(This function is an option.)

When the accelerator is released on a slippery road, the supplementary brake or the engine brake can lock the driving wheels. When this happens the supplementary brake is disengaged and the engine drives the driving wheels until they rotate at the same speed as the front wheels. This does not happen if the transmission is in neutral, the ABS is activated or the vehicle speed is less than 10 km/h (6 mph).



T3014400

Display symbol for regulation of engine torque.

Emergency Braking Assistance

(This function is an option.)

When the brake pedal is pressed quickly and forcefully the braking pressure is higher and the braking effect stronger. This function is there to enable rapid application of full braking force in emergency situations.

Equalizing Brake Pad Wear

Note: Does not apply to low entry buses.

If the brake pads wear more on one axle than another, greater braking force is distributed to the other wheels to even out the wear.

Note: This function works during gentle braking. During harder braking the braking force is divided so that braking occurs as effectively as possible.

A warning symbol is shown on the display panel when a brake shoe becomes more than 80% worn.



T5013668

Display symbol when a brake shoe is more than 80% worn.

Low Entry Buses

Buses with low entry have a wear warning, but do not perform the brake shoe wear evening function. The wear warning only applies to the drive and running axle, when the front axle has no wear sensor.

Predicted Brake Pad Wear

Note: Does not apply to low entry buses.

(This function is an option.)

The “Vehicle Data” menu displays information about when the brake linings must be replaced. This information can also be read off by a Volvo service shop.

Warning of High Brake Temperature

If the brakes become too hot the “CHECK” lamp illuminates and a symbol is shown on the display.

Note: If the temperature is allowed to rise even further, the feeling of the brakes changes so that the pedal has to be pressed harder to obtain the same braking effect as before.



T5013670

Warning symbol for high brake temperature.

Wheel Brake Monitoring

(This function is an option.)

If the braking effect on a wheel is weaker than on the other wheels, the “CHECK” lamp illuminates and a symbol is shown on the display. This does not necessarily mean that braking feels different as the other wheels brake harder. However a fault code is stored in the system and a Volvo service shop should examine the braking system.



T3014494

Warning symbol for poor braking effect.

Resetting Fault Codes

If the brake pedal is pressed when the pressure in the braking system is too low, several fault codes can be set. These codes can be removed in the following way:

- 1 Ensure that the vehicle is stationary.
- 2 Check the display to see that the air pressure is at least 9 bar (130 psi). If it is not, start the engine to allow the pneumatic system to pressurize.
- 3 Switch off the ignition so that the control unit is reset.
- 4 Start the engine without touching the foot brake.
- 5 Wait at least five seconds.
- 6 Slowly depress the foot brake until it is fully depressed (it should take at least one second to be fully applied from when it is released).
- 7 Hold the foot brake fully depressed for at least seven seconds.
- 8 Release the foot brake slowly (it should take at least one second from fully applied to when it is released).
- 9 Switch off the ignition.
- 10 Wait at least five seconds.
- 11 Switch the ignition on.
- 12 Check the fault codes.

After resetting, the fault codes should be inactive. Otherwise the fault remains.

If it takes longer than 25 seconds to carry out steps 10, 11 and 12 or the fault codes will not be deactivated.

Note: If the above procedure does not help, contact a Volvo service shop for further examination of the system.

VOLVO

Volvo Bus Corporation

Göteborg, Sweden

Driver's Handbook

Webasto Thermo Control 230/300/350



TS008841

VOLVO

Foreword

This manual contains information concerning the operation and function of the Webasto Thermo 230/300/350 water heating unit control. The information in this manual applies to vehicles built June 2008 and later. Please keep this manual in the vehicle at all times.

Note: Illustrations in this manual are used for reference only and may differ slightly from the actual vehicle. However, key components addressed in this document are represented as accurately as possible.

Volvo Bus Corporation

Göteborg, Sweden

Order number: PV776-20196677

© 2009 Volvo Bus Corporation, Göteborg, Sweden

All rights reserved. No part of this publication may be reproduced, stored in retrieval system, or transmitted in any forms by any means, electronic, mechanical, photocopying, recording or otherwise, without the prior written permission of Volvo Bus Corporation

Contents

Display	1
General Introduction	1
Display	2
Button Functions	3
Buttons for Changing Parameter Values	3
Setting of the Time and Date	3
Button for Programming Unit Start-up Time	4
Button for Starting the Unit	5
Turning off the Unit	5
Programming and Control of the Unit Time of Work	5
Setting of the Alarm Clock	6
Check the Setting of the Alarm Clock	6
Programming Unit Start-up/Shut-down Time	6
Error Messages	7
Error Messages	7

Safety Information

IMPORTANT: Before driving this vehicle, be certain that you have read and that you fully understand each and every step of the driving and handling information in this manual. Be certain that you fully understand and follow all safety warnings.

IT IS IMPORTANT THAT THE FOLLOWING INFORMATION BE READ, UNDERSTOOD AND ALWAYS FOLLOWED.

The following types of advisories are used throughout this manual:



DANGER

Danger indicates an unsafe practice that could result in serious personal injury or death. A danger advisory banner is in **white** type on a **black** background with a **black** border.



WARNING

Warning indicates an unsafe practice that could result in personal injury. A warning advisory banner is in **black** type on a **gray** background with a **black** border.



CAUTION

Caution indicates an unsafe practice that could result in damage to the product. A caution advisory is in **black** type on a **white** background with a **black** border.

Note: Note indicates a procedure, practice, or condition that must be followed in order for the vehicle or component to function in the manner intended.

General Introduction

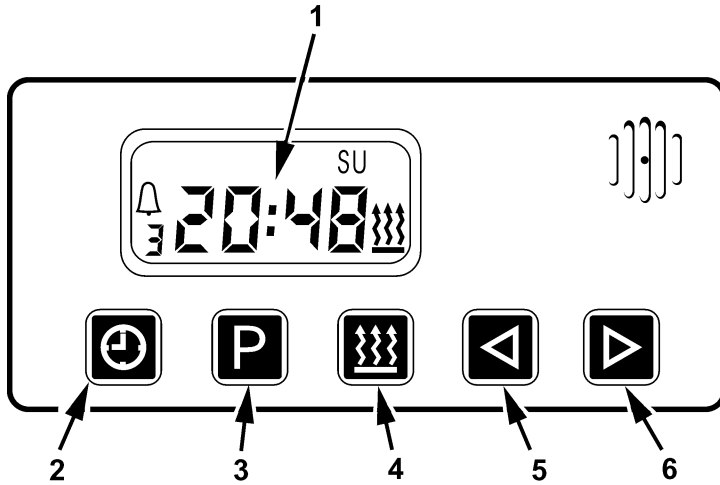

T8008842

- | | | | |
|---|--------------------------|---|---|
| 1 | Display | 5 | Button for reducing the value of the parameter selected |
| 2 | Clock button | 6 | Button for increasing the value of the parameter selected |
| 3 | Program selection button | | |
| 4 | Button for unit start-up | | |

2 Display

Display

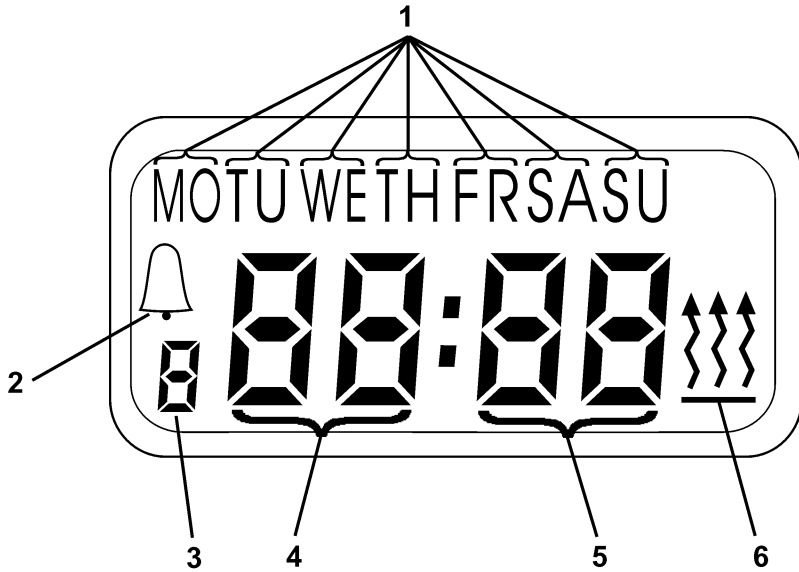

T8008844

- | | | | |
|---|--|---|---|
| 1 | Symbols for the days of the week:
MO - Monday
TU - Tuesday
WE - Wednesday
TH - Thursday
FR - Friday
SA - Saturday
SU - Sunday | 2 | Symbol for alarm clock set |
| | | 3 | Symbol for programming unit start-up time (1, 2, 3) |
| | | 4 | Symbol for hours (0, 1, 2.....22, 23) |
| | | 5 | Symbol for minutes (00, 01, 02.....58, 59) |
| | | 6 | Symbol for unit turned on |

Buttons for Changing Parameter Values

By pressing the (1) button, you can reduce the value of the selected parameter (day of the week, hour, minutes or programme of starting up the unit) and by pressing the (2) button, you can increase the value of the selected parameter. Pressing and holding either button (1) or (2) for longer than 2 seconds, will change the selected parameter at a faster rate. When the buttons are not used for longer than 5 seconds the value set is entered in the memory.



T8008839

Button 1



T8008840

Button 2

Setting of the Time and Date

By pressing the (3) button, you can set the present hour, minutes and day of the week.



T8008836

Button 3

Pressing and holding the (3) button for longer than 2 seconds and the symbols for hours and minutes begin to flash simultaneously. With the aid of the (1) or (2) button, set the present time.

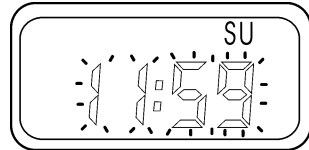

T8008851

After setting the time, wait 5 seconds and the symbol for the day of the week begins to flash. Next, with the aid of (1) or (2) button, set the present day of the week. After setting, press the button or wait 5 seconds to enter the selected values in the control memory.



T8008852

4 Button Functions

Button for Programming Unit Start-up Time

Using the (4) button you can select one of three programs for unit starting up.



T8008837

Button 4

To change the setting of the first program, press the (4) button once. To change the setting of the second program press the (4) button twice and to change the setting of the third program, press the (4) button three times. The number of the program that's selected, will be shown flashing on the display.

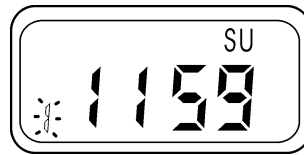

T8008854

When the (1) or (2) button is pressed, the symbol of the hours and minutes then begins to flash. Set the desired hour and minutes with the (1) or (2) button and then wait five seconds.

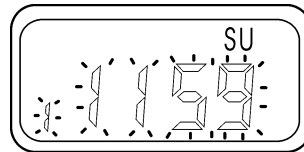

T8008853

The symbol of the day of the week begins to flash. The value can be changed with button (1) or (2). After waiting five seconds or pressing button (4), the time value for unit starting up is set and entered in the memory.



T8008855

On the display, the number of the program selected is illuminated and the background lighting of the unit start-up time button (5) begins to flash.

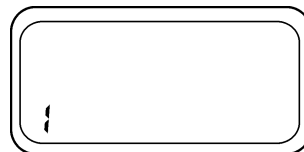

T8008856

Button for Starting the Unit

The unit can start up automatically (see subheading Button for programming unit start-up time) or manually. In order to start up the unit manually press button (5).



T8008838

Button 5

The unit turned on symbol appears on the display and the time remaining for completion of its work. If you wish to change the value of the time remaining for completion of the work, press button (1) or (2). The unit time of work can be regulated in a range of 1 to 120 minutes.



T8008857

Turning off the Unit

The unit can be turned off by pressing button (5) again. The unit start-up signal will disappear from the display. The unit will turn itself off automatically if you have pre-programmed a time for this function.

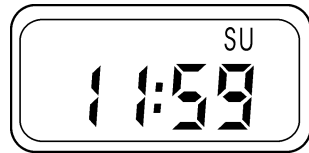

T8008858

Programming and Control of the Unit Time of Work

With the unit off, the unit time of work can be set. Press the (1) button longer than 3 seconds - on the lit screen the symbol for unit time of work begins to flash. Pressing button (1) or (2) will set the desired time of work for the unit (in program 1, 2, 3 and with manual start up). After waiting 5 seconds the selected time is entered into the memory.

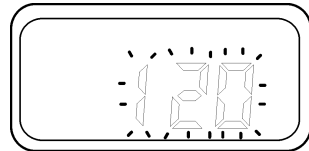

T8008846

6 Button Functions

Setting of the Alarm Clock

The setting of the alarm clock is not connected with a day of the week. Press the (4) button four times, the symbol for the alarm clock will then begin to flash on the display.



T8008847

Press either the (1) or (2) button. The symbol for hours and minutes begins to flash.

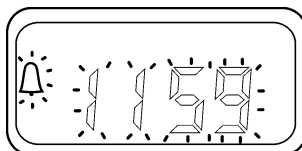

T8008848

To set the desired waking time press button (1) or (2). After waiting five seconds the waking time is entered in the memory. The symbol for the alarm clock remains illuminated on the display. The alarm sounds for 5 minutes. You can turn it off by pressing any button.

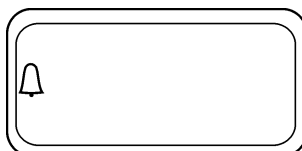

T8008849

Check the Setting of the Alarm Clock

To check the setting of the alarm clock press the (4) button four times. When alarm clock symbol begins to flash on the display, the set time for waking can read. To cancel the setting of the alarm press the (4) button a fifth time. The symbol of the alarm disappears from the display.



T8008847

Programming Unit Start-up/Shut-down Time

Pressing the (4) button once, will allow checking the setting of the first program. Pressing the (4) button twice, will allow checking the setting of the second program. Pressing the (4) button three times, will allow checking the setting of the third program. Pressing the (4) button five times, exits the program.

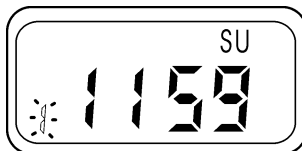

T8008854

Error Messages

Messages about errors appear on the lit display screen in the form of codes. The error code descriptions can be found in the accompanying table.

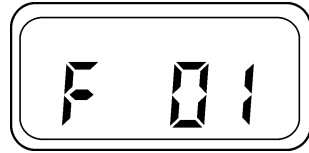

T300850

Code	Description
F01	No start up
F02	Interruption of the flame
F03	Tension too low
F04	Recognition of a foreign light in start up or run out
F05	Damage to flame sensor
F06	Damage to temperature sensor
F07	Damage to magnetic valve
F08	Damage to blower motor
F09	Damage to circulation pump
F10	Damage to/overheating of temperature limiter
F11	Damage to ignition spark generator
F12	Blocking of the appliance through repeated disturbance or repeated interruption of the flame

VOLVO

Volvo Bus Corporation

Göteborg, Sweden

Driver's Handbook

Cleaning and Maintaining the Paint Finish

9700

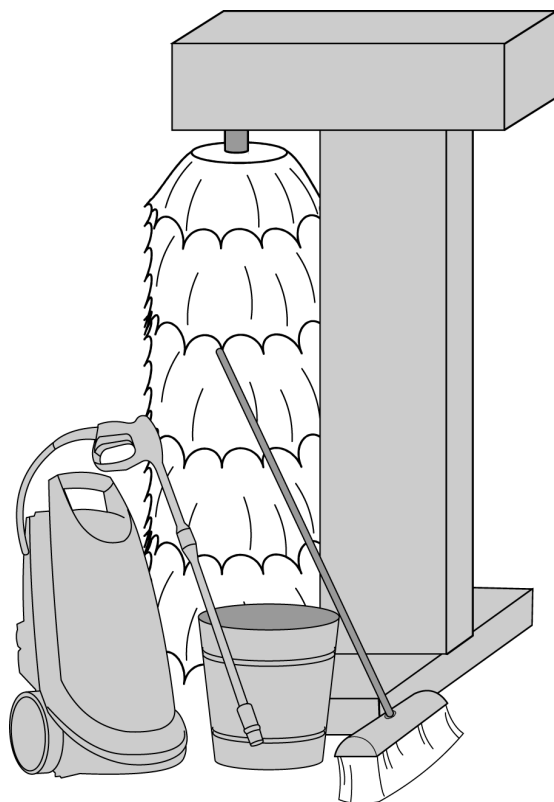

VOLVO

Foreword

This manual contains information concerning the maintenance of the bus exterior finish. The information in this manual applies to vehicles built January 2009 and later. Please keep this manual in the vehicle at all times.

Note: Illustrations in this manual are used for reference only and may differ slightly from the actual vehicle. However, key components addressed in this document are represented as accurately as possible.

Volvo Bus Corporation

Göteborg, Sweden

Order number: PV776-20196937

© 2009 Volvo Bus Corporation, Göteborg, Sweden

All rights reserved. No part of this publication may be reproduced, stored in retrieval system, or transmitted in any forms by any means, electronic, mechanical, photocopying, recording or otherwise, without the prior written permission of Volvo Bus Corporation

Contents

General Information	1
Keeping the Vehicle Clean — Overview	1
Washing and Aftercare	3
Hand Washing, Painted Finishes	3
Washing in a Car Wash	5
Washing and Waxing	5
Waxing	6
Polishing	7
Renovation of the Paint Finish	8
Renovation	8
Professional Renovation	8
Additional Information	9
Stickers	9

Safety Information

IMPORTANT: Before driving this vehicle, be certain that you have read and that you fully understand each and every step of the driving and handling information in this manual. Be certain that you fully understand and follow all safety warnings.

IT IS IMPORTANT THAT THE FOLLOWING INFORMATION BE READ, UNDERSTOOD AND ALWAYS FOLLOWED.

The following types of advisories are used throughout this manual:



DANGER

Danger indicates an unsafe practice that could result in serious personal injury or death. A danger advisory banner is in **white** type on a **black** background with a **black** border.



WARNING

Warning indicates an unsafe practice that could result in personal injury. A warning advisory banner is in **black** type on a **gray** background with a **black** border.



CAUTION

Caution indicates an unsafe practice that could result in damage to the product. A caution advisory is in **black** type on a **white** background with a **black** border.

Note: Note indicates a procedure, practice, or condition that must be followed in order for the vehicle or component to function in the manner intended.

Keeping the Vehicle Clean — Overview

The maintenance procedures described in the following instructions ensure the correct utilization and attractive appearance of the vehicle.

Maintenance Objectives:

- To ensure the cleanliness and smart appearance of the bus from the outside
- To prolong the life of the vehicle's paint finish

Equipment:

- Cloths, soft brushes, cotton cleaning cloths
- Protective clothing, rubber gloves
- Pressure washer
- Detergents, agents for washing painted surfaces, waxes, and polishing agents, as recommended by Authorized Volvo Service Outlets



T1008823

2 General Information

Using Permitted Chemical Agents



DANGER

Before using a chemical agent, read the instructions governing its use, as well as the instructions on how to proceed in a hazard situation (e.g. contact of the chemical agent with the skin or the eyes)! Care must be taken when using chemical agents - perform all operations in protective clothing and protective gloves. Failure to do so may result in serious personal injury or death.

Guidelines for Protection of the Environment

Note: The empty packages from chemical agents from washing, waxing or polishing, as well as fabric items used for cleaning and polishing, should be disposed of in an ecologically sound manner.

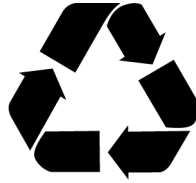

T1008770



CAUTION

The vehicle may only be washed in a place intended for this purpose. Failure to do so may result in components getting damaged.

Hand Washing, Painted Finishes

Note: Never wash the vehicle in full sunlight, as the surface is then too hot, and this causes the washed surface to suddenly dry out.

- Mix a painted surface washing agent with hot water, in the correct proportions recommended by the manufacturer.
- Before washing, rinse the entire bus surface with water.

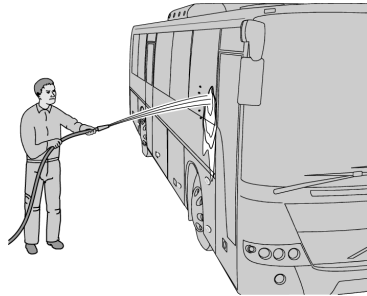

T1008816

- For washing, use the previously prepared solution of washing agent and a soft cloth or soft brush.

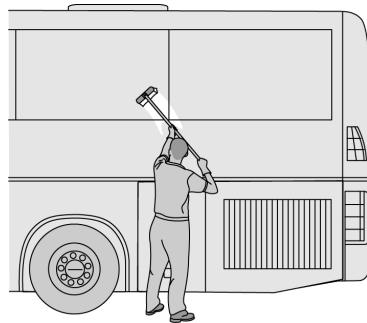

T1008817

- Immediately after washing, rinse the washed surface with clean water so that the used solution of washing agent does not dry on the vehicle surface. Rinse the vehicle with clean water from top to bottom, paying particular attention to depressions and joints. A pressure washer may be used to perform this.

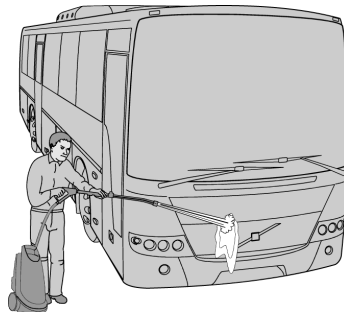

T1008818

4 Washing and Aftercare

- Wipe the water off the vehicle windows with a squeegee.

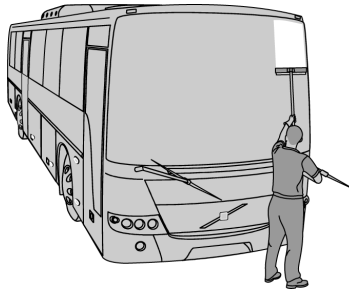

T1008819

- Dry the vehicles surface with a soft, dry, clean cloth (cleaning cloth).
- Leave the painted surfaces to dry out fully.

Note: Water used for washing the bus must have a pH from 6 to 8. The water used should be of the correct hardness – below 120ppm.

Note: Use a special cleaning cloth to wipe the vehicle down.

Note: Tar or asphalt can be removed from the painted surface using a special agent recommended by Authorized Volvo Service Outlets.

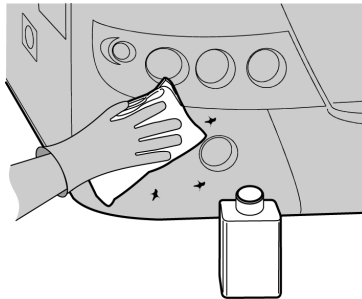

T1008821



CAUTION

Do not use sharp metal instruments, such as a scraper or knife, to clean tar or asphalt from the painted surface! Failure to do so may result in damage to the vehicles surfaces.

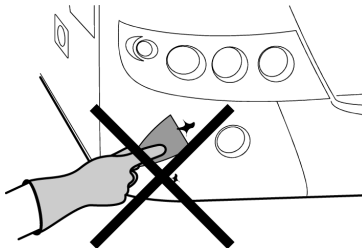

T1008822

Washing in a Car Wash



CAUTION

The bus should be washed in a car wash with vertical brushes that wash the vertical surfaces of the bus. Failure to do so may result in damage to exterior items such as; ventilation holes, hatches and roof antennas and the climate control modules.

When washing the vehicle in a car wash you should read the instructions for use and act in accordance with them.

Washing and Waxing

Note: Some washing agents contain wax. In such cases, the vehicle should be washed in accordance with the instructions for hand washing and left to dry. In such cases, no additional waxing should be carried out.

After waxing, the windows should be de-greased using a cloth and screen washing agent.

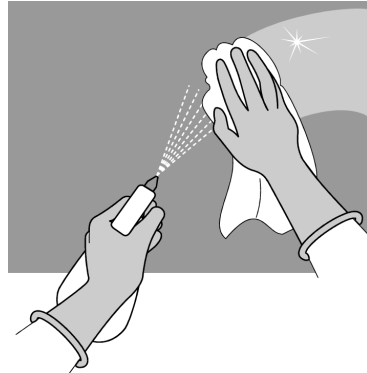

T1008824

6 Washing and Aftercare

Waxing

Note: Do not wax the vehicle within 90 days of its being supplied, as the finish may still be curing.

Waxing of the bodywork is regarded as a servicing item for the vehicle.

Note: Before waxing the paint finish, you should first wash the vehicle thoroughly.

- Do not put wax on a surface that cannot be easily buffed up.
- The optimum ambient temperature for waxing is 15-25^oC (59-77^oF).
- Apply the wax in thin layers.
- Rub out the wax coat you have applied with a soft cotton cloth to obtain a sheen.

Note: Never wax the vehicle in full sunlight as the surface will be too hot. The wax will be difficult to remove and may result in spots.



T1008820

Polishing

Note: Polishing can be carried out after proper washing of the painted surface has not removed dirt or, if small scratches exist on the painted surface resulting in reduced sheen and dulling.

- Before beginning polishing, you should thoroughly wash the vehicle surface.
- For polishing, only use pastes and polishing agents recommended by Authorized Volvo Service Outlets. Always perform the work in accordance with the instructions provided with the agents being used.
- Small fragments of the painted surface can be buffed up by hand using a soft cloth.
- Polishing of larger elements can be done using an angle grinder and suitable polishing discs.

Note: Polishing is the ultimate way of removing scratches in the painted surface, but always remember that polishing causes a reduction in the thickness of the paint layer.



T1008825

8 Renovation of the Paint Finish

Renovation

If the paint finish has been damaged, uncovering the paint primer or the panel (metal), the paint finish must be repaired.

To carry out small repairs:

- Wash the surface with a degreasing agent, an agent for removing wax, or white spirit.
- Remove the corroded surface using a fine-grade abrasive, and then collect up the dust and again degrease the surface.
- If the primer has been removed it should be reapplied.

Professional Renovation

If deeper scratches and grazes to the paint finish surface cannot be removed using these methods described above, consult an Authorized Volvo Service Facility for further information.

- Protect the remaining surfaces - those that are not to be painted.
- Before painting, check that the surface is properly dried off.
- Apply paint to a small area to make sure that the color is well-matched.
- Apply a thin layer of paint, and if a second layer is needed, wait until the first has fully dried.
- After painting, buff up the surface.

Stickers

No laminate-based decorative items and stickers should be attached to the painted surfaces for a minimum of 7 days after painting of the vehicle. The procedure for applying laminates to the surface should be in accordance with their instructions.

VOLVO

Volvo Bus Corporation

Göteborg, Sweden

Driver's Handbook

Replacing Belts B13R

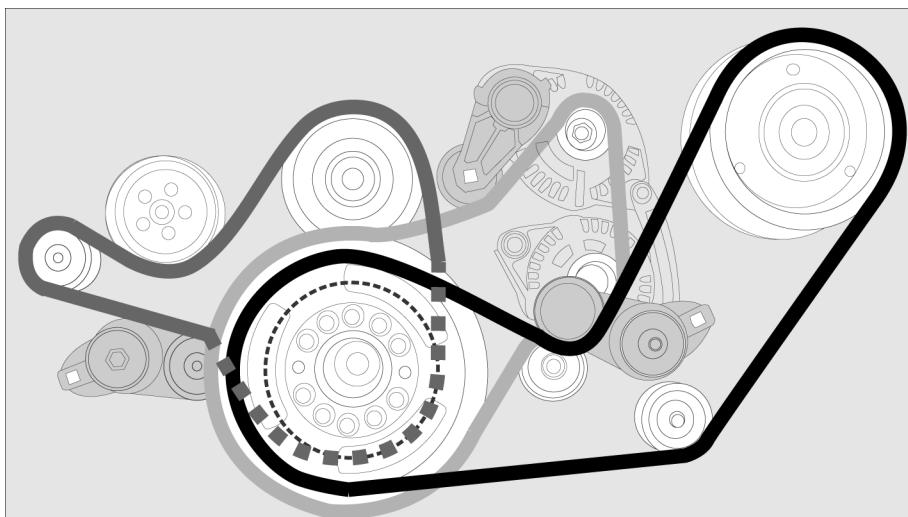

T0015452

VOLVO

Foreword

This manual contains information intended to help the driver in replacing the engine's belts (compressor, coolantpump, alternators), when one of them is broken or damaged. The information in this manual applies to vehicles built January 2009 and later. Please keep this manual in the vehicle at all times.

Note: Illustrations in this manual are used for reference only and may differ slightly from the actual vehicle. However, key components addressed in this document are represented as accurately as possible.

Volvo Bus Corporation

Göteborg, Sweden

Order number: PV776-20198553

© 2009 Volvo Bus Corporation, Göteborg, Sweden

All rights reserved. No part of this publication may be reproduced, stored in retrieval system, or transmitted in any forms by any means, electronic, mechanical, photocopying, recording or otherwise, without the prior written permission of Volvo Bus Corporation

Contents

Replacing Belts	1
Introduction	1
Compressor Belt, Removal	1
Water Pump Belt, Removal	3
Alternators Belt, Removal	4
Engine Belts, Installation	5
Alternators Belt, Installation	6
Water Pump Belt, Installation	8
Compressor Belt, Installation	9

Safety Information

IMPORTANT: Before driving this vehicle, be certain that you have read and that you fully understand each and every step of the driving and handling information in this manual. Be certain that you fully understand and follow all safety warnings.

IT IS IMPORTANT THAT THE FOLLOWING INFORMATION BE READ, UNDERSTOOD AND ALWAYS FOLLOWED.

The following types of advisories are used throughout this manual:



DANGER

Danger indicates an unsafe practice that could result in serious personal injury or death. A danger advisory banner is in **white** type on a **black** background with a **black** border.



WARNING

Warning indicates an unsafe practice that could result in personal injury. A warning advisory banner is in **black** type on a **gray** background with a **black** border.



CAUTION

Caution indicates an unsafe practice that could result in damage to the product. A caution advisory is in **black** type on a **white** background with a **black** border.

Note: Note indicates a procedure, practice, or condition that must be followed in order for the vehicle or component to function in the manner intended.

Introduction

This manual contains information intended to help the driver in replacing the engine's belts (compressor, coolant pump, alternators), when one of them is broken or damaged. To change the alternators belt (3), it is necessary to remove the compressor belt (1) and the water pump belt (2). To change the water pump belt (2), first remove the compressor belt (1).

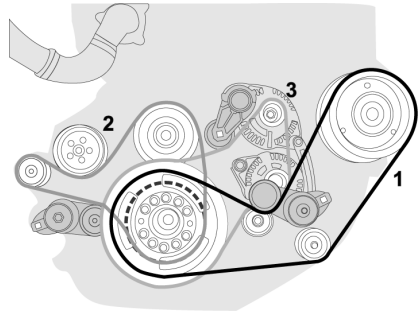

T0015453

Compressor Belt, Removal

Turn off the power supply using the main switch

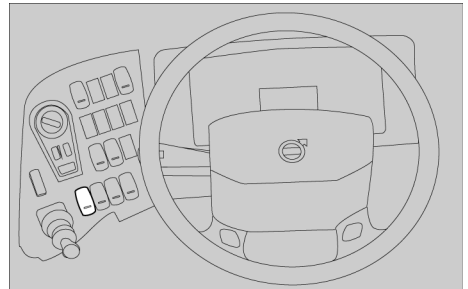

T0015454

Place the "Start Enable Switch" to the 0 position.

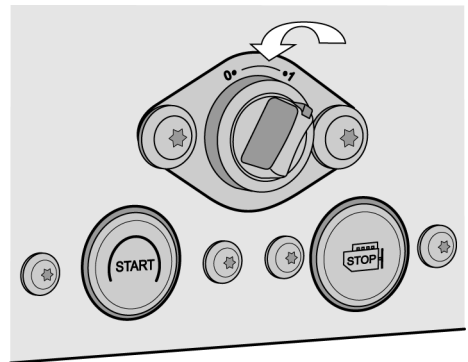

T0015455

2 Replacing Belts

Place the breaker bar inside the hole of the belt tensioner and pull clockwise to release the belt.

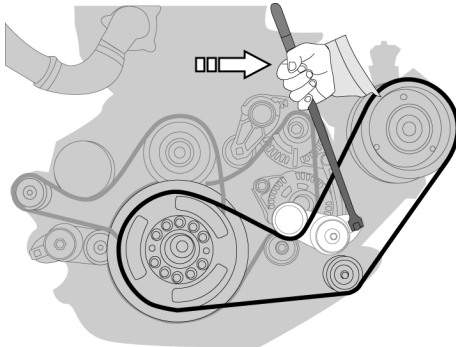

T0015457

Pull outward to unhook the belt.



T0015456

Water Pump Belt, Removal

Place the breaker bar inside the hole of the belt tensioner, pull clockwise to release the belt.

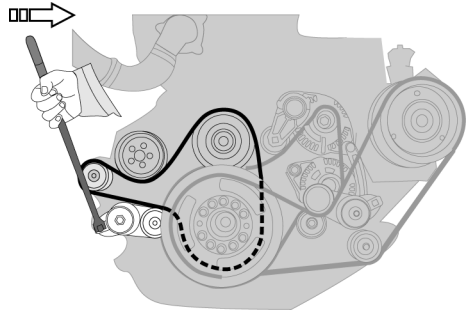

T0015458

Pull outward to free the belt from the pulley (1).

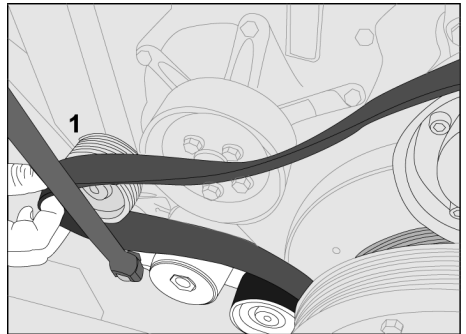

T0015459

Unhook the belt from the others pulleys and remove.

4 Replacing Belts

Alternators Belt, Removal

Place the breaker bar inside the hole of the belt tensioner, pull clockwise to release the belt. Pull the belt out from the upper and lower pulley's.

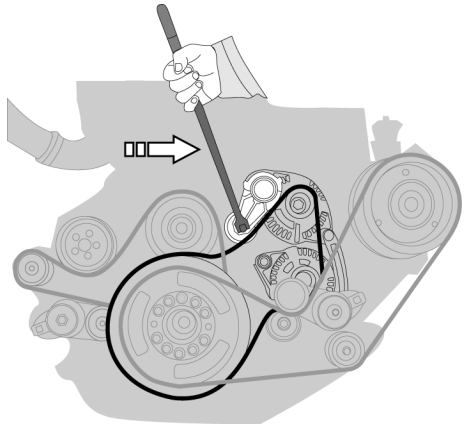

T0015460

Turn the belt and pass it through the damper and intermediate pulley, and pull down.

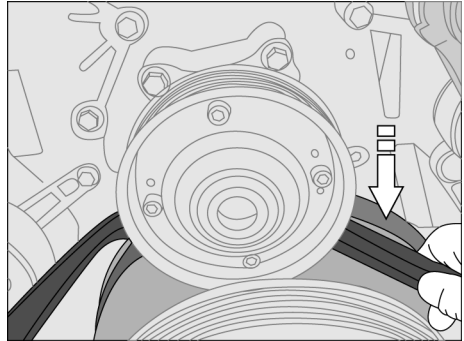

T0015461

Again, turn the belt and pass it through the intermediate and the crankshaft pulley and remove the belt.

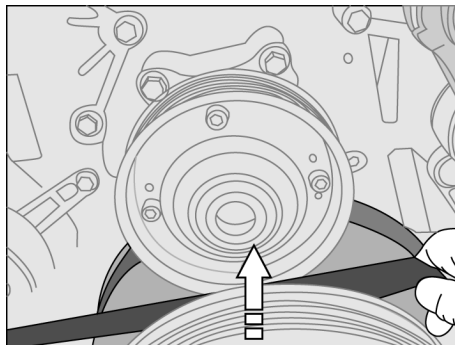

T0015462

Engine Belts, Installation

To install the belts, perform the following sequence:

- 1 Alternators belt,
- 2 Water pump belt,
- 3 Compressor belt.

6 Replacing Belts

Alternators Belt, Installation

Pass the belt through the damper and intermediate pulley. Move inwards and pull the belt up to go through the intermediate and crankshaft pulley. Position the belt into the damper pulley groove.

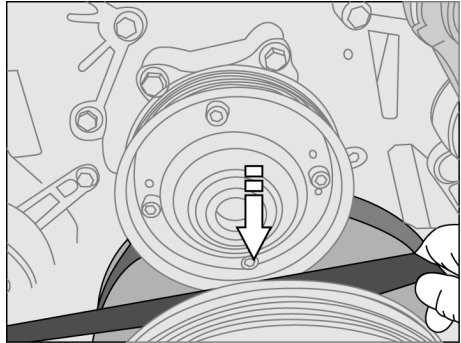

T0015463

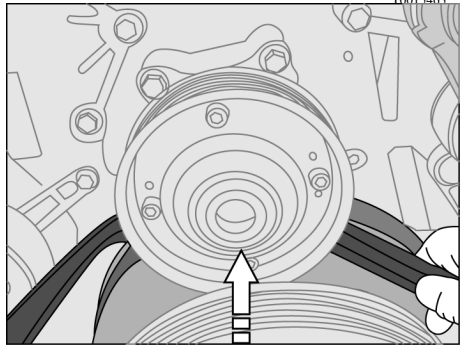

T0015464

Pull the belt towards the idler pulley (1) and position it over the pulley.



T0015465

Place the breaker bar inside the hole of the belt tensioner and pull clockwise. Position the belt over the upper alternator pulley (1).

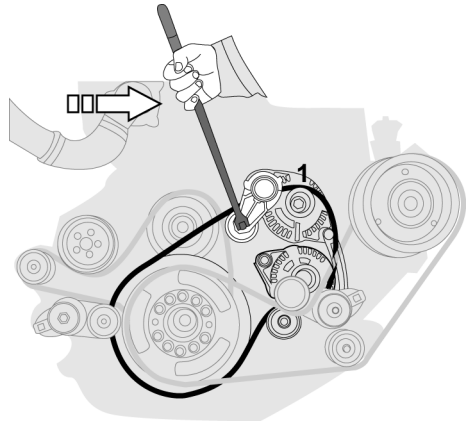

T0015466

Check and verify that the belt is under the belt tensioner (1).

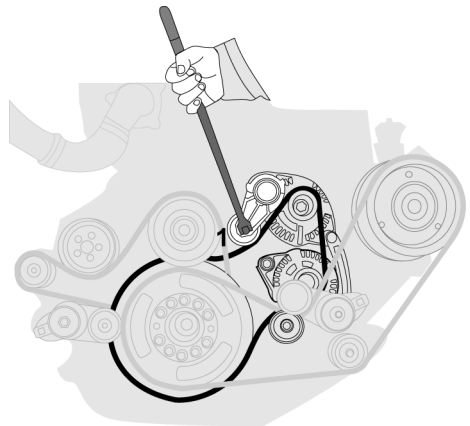

T0015467

8 Replacing Belts

Water Pump Belt, Installation

Position the belt on the crankshaft pulley (1).

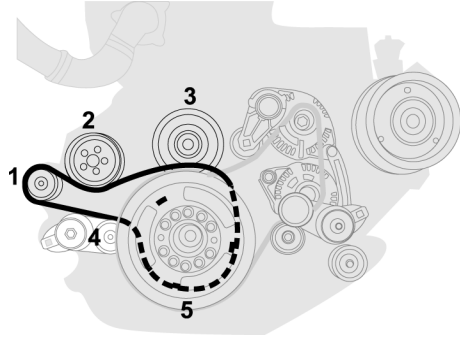

T0015468

Pass the belt under the water pump pulley (2). Place the breaker bar into the hole of the tensioner belt (4) and pull the belt up to position it over the intermediate pulley (3).

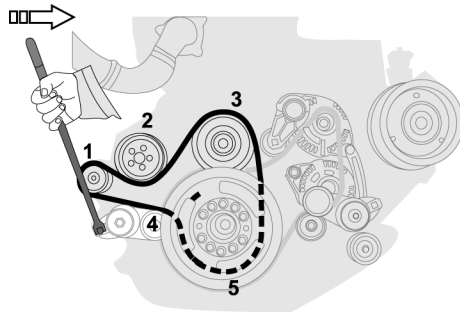

T0015469

Compressor Belt, Installation

Position the belt over the crankshaft pulley (1), under the idler pulley (2) and place it around the compressor pulley (3).

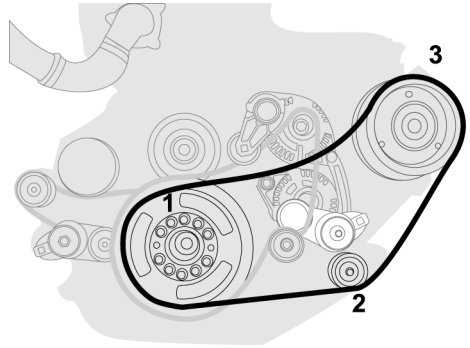

T0015470

Place the breaker bar inside of the hole of the belt tensioner, pull clockwise and push the belt in to the belt tensioner (4).

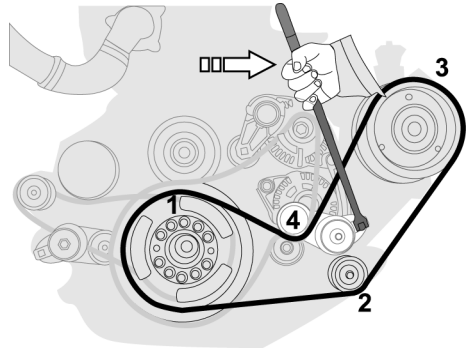

T0015471

VOLVO

Volvo Bus Corporation

Göteborg, Sweden

Driver's Handbook

Toilet Facility B13R

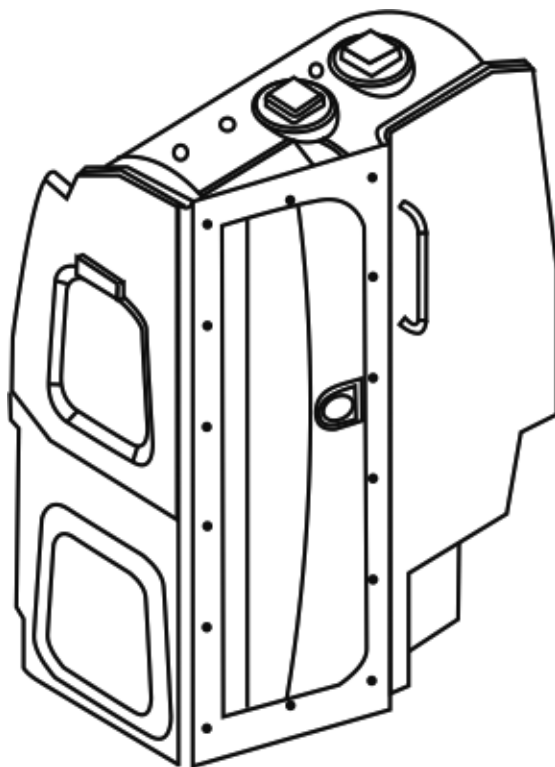

T0015349

VOLVO

Foreword

This manual contains information concerning the operation and function of the bus toilet facility. The information in this manual applies to vehicles built January 2009 and later. Please keep this manual in the vehicle at all times.

Note: Illustrations in this manual are used for reference only and may differ slightly from the actual vehicle. However, key components addressed in this document are represented as accurately as possible.

Volvo Bus Corporation

Göteborg, Sweden

Order number: PV776-20198781

© 2009 Volvo Bus Corporation, Göteborg, Sweden

All rights reserved. No part of this publication may be reproduced, stored in retrieval system, or transmitted in any forms by any means, electronic, mechanical, photocopying, recording or otherwise, without the prior written permission of Volvo Bus Corporation

Contents

Toilet Facility	1
Toilet	1
Valves and Water Tanks	2
Operation Instructions	3
To Flush the Toilet	3
Holding and Freshwater Tanks	4
Sink Operation	4
In Case of an Emergency	4
Water Tank Filling & Emptying	5
Toilet Enclosure Cleaning	5
Toilet Bowl Cleaning	5
Trash Bin	5
Soap Dispenser	6
Toilet Paper Roll Dispenser	6
Maintenance	7
Daily Routine	7
Weekly Routine	8
Quarterly Routine	9
Sticker Legend	10

Safety Information

IMPORTANT: Before driving this vehicle, be certain that you have read and that you fully understand each and every step of the driving and handling information in this manual. Be certain that you fully understand and follow all safety warnings.

IT IS IMPORTANT THAT THE FOLLOWING INFORMATION BE READ, UNDERSTOOD AND ALWAYS FOLLOWED.

The following types of advisories are used throughout this manual:



DANGER

Danger indicates an unsafe practice that could result in serious personal injury or death. A danger advisory banner is in **white** type on a **black** background with a **black** border.



WARNING

Warning indicates an unsafe practice that could result in personal injury. A warning advisory banner is in **black** type on a **gray** background with a **black** border.



CAUTION

Caution indicates an unsafe practice that could result in damage to the product. A caution advisory is in **black** type on a **white** background with a **black** border.

Note: Note indicates a procedure, practice, or condition that must be followed in order for the vehicle or component to function in the manner intended.

Toilet

The toilet is composed with the following parts:

- 1 Exhaust Fan
- 2 Mirror
- 3 Emergency switch
- 4 Sink
- 5 Trash bin
- 6 Toilet basin
- 7 Door
- 8 Internal lock
- 9 Dispenser
- 10 Baby carriers
- 11 Sensor/extractor

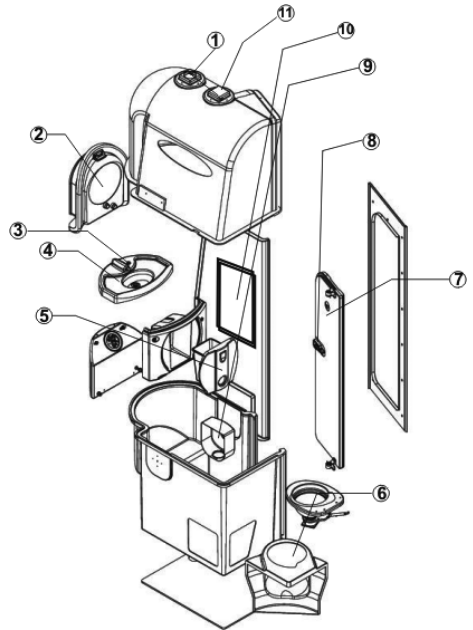

T0015348

2 Toilet Facility

Valves and Water Tanks

The fill valves for the water tanks are located on the right side of the bus, behind the rear axle. The drain valves are located under the passenger area in front of the rear axle

- 1 Sink water tank fill valve.
- 2 Flushing water tank drain valve.
- 3 Holding tank
- 4 Fresh water tank
- 5 Drain valve fresh water tank
- 6 Pumps

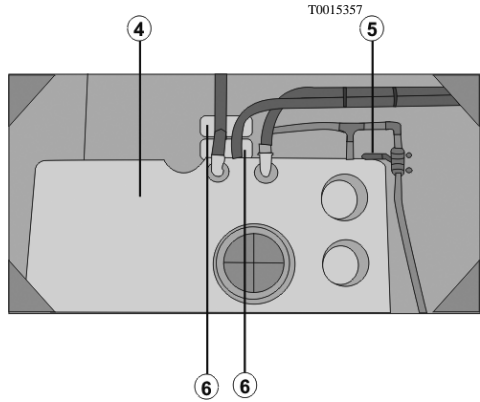
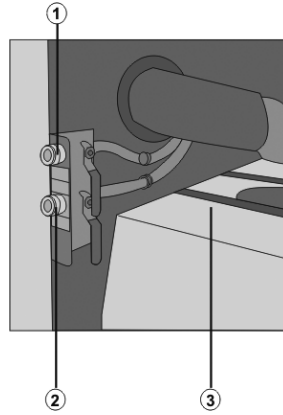

T0015358

Operation Instructions

To activate the toilet switch main power supply, push the WC button on the dashboard.

When occupying the toilet facility, the interior light will turn on. Even when closing the lock on the inside, an indicator lamp will turn it on in the passengers area.

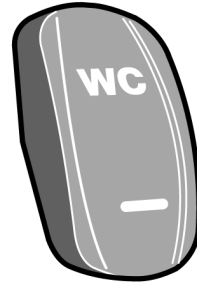

T3018183

Toilet master switch

The interior light is controlled by a movement sensor, that will turn off the light automatically shortly after the facility is vacated. The "Vacant" lamp will then illuminate.

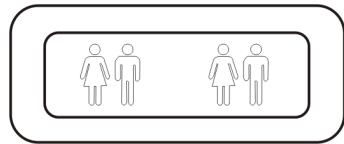

T0015272

"Occupied /Vacant" lamp

To Flush the Toilet

Push the flush button once to flush the toilet. If further flushing is required, wait for the flush cycle to complete then press the button again.

Note: The toilet will flush automatically if the facility is vacated without flushing first.

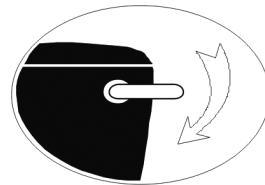

T0015351

Flush button

4 Toilet Facility

Holding and Freshwater Tanks

When the holding tank is full, a dashboard LED will illuminate and the “Occupied” lamp will signal. The toilet is now out of use until the holding tank is emptied.



T0015355

Full dashboard LED

When the fresh water tank is empty a dashboard LED will illuminate and the “Occupied” lamp will signal. The toilet is now out of use until the water tank is re-filled.

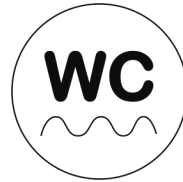

T0015356

Empty dashboard LED

Sink Operation

Press the hand wash button once to dispense a set amount of water. When the sink tank is empty a dashboard LED will illuminate to alert the driver.

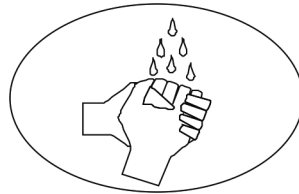

T0015353

Hand wash button

In Case of an Emergency

Pressing the red alarm button will alert the driver and sound a buzzer. The button is located on the left side of the sink.



T0015350

Water Tank Filling & Emptying

Tanks are filled via the hose connectors located in the holding tank compartment. The sinks 40 mm (1.6 in.) fill pipe is accessed by removing the litter bin and the flush tank. These are attached with a 100mm (4 in.) cap screws that can be accessed through the floor trap.

The holding tank is emptied by firmly pulling the handle on the slide valve located underneath the tank.

Toilet Enclosure Cleaning

The enclosure is manufactured from Glass Reinforced Plastic (GRP) with high gloss interior and lightly textured exterior surfaces. This surface finish is delicate and must only be washed down using a mild detergent. The use of a caustic or abrasive material is not recommended, as this will affect the appearance.

Toilet Bowl Cleaning

To protect the finish of the Stainless Steel toilet bowl, do not use abrasives of any kind. To clean the bowl, use a mild anti-bacterial detergent and a suitable brush.

Trash Bin

The enclosure features a plastic bin located in sink area. Removing this bin gives access to the 40 mm (1.6 in.) fill pipe and drain tap for the sink tank. The use of a trash bag is recommended.



6 Toilet Facility

Soap Dispenser

To fill the dispenser, unlock the mirror cabinet, lift the lid of the dispenser and fill with liquid soap.

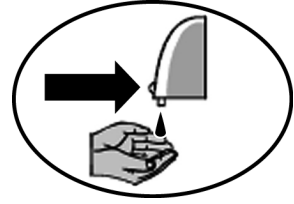

T8014110

Toilet Paper Roll Dispenser

It is recommended that a biodegradable paper is used all times. The toilet paper roll is located inside the lower vanity door. Unlock and open the door and slide the roll onto the spindle.

Note: Domestic grade toilet paper is not recommended as this can block the system.

Maintenance

Daily Routine

- Prior to the vehicle entering service the holding tank should be charged with an additive to sanitize it.
- The recommended product is **Shades Super Sani ECO**, formulated from natural essential oils. This formaldehyde-free formula is contained within a water soluble membrane. A single 16 gram bottle contains the recommended dosage for 110 liter (26 gallons) capacity holding tank and will function for a maximum of three days. To apply:
 - 1 Ensure the holding tank is empty.
 - 2 Verify that the tank evacuation valve is closed.
 - 3 Verify that the toilet clean water tank is full.
 - 4 Switch the toilet facility power on.
 - 5 Press the flush button to open the toilet valve and pour the complete bottle into the bowl.
- It is recommended that the toilet supply tank is drained and the waste holding tank is emptied at the end of every day.
- The daily addition of a couple of drops of mild detergent into water resting in the toilet bowl will lubricate the slider and protect the seal.
- The sink tank should be emptied and re-filled daily. To help maintain a clean tank and freshwater the use of a water conditioner is recommended. Use a suitable product that disinfects the water, that is safe to drink and non-irritable to the skin and eyes.

8 Toilet Facility

Weekly Routine

- Check exhaust fan function.
- Inspect faucet, door hinges and toilet seat. Check the operation of the enclosure door and lock function. Test alarm button and buzzer function.
- Open vanity door, check electrical and plumbing connections for safety and leaks.
- Verify that the water flow to the sink basin is smooth and constant.

Quarterly Routine

- Flush out holding tank with fresh water. (the holding tank must be empty and the vehicle positioned so that the holding tank evacuation valve is over a sewage drainage point)

To flush out:

- 1 Switch the toilet facility power on.
 - 2 Connect a hose to a main water supply.
 - 3 Press the flush button once to open the slide valve.
 - 4 When the valve opens, insert the end of the hose down through the bowl, into the drain pipe. When the valve closes the hose will be held into position by the paddle pressure.
 - 5 Turn on the water to the hose and fill the holding tank, being careful not to overfill.
 - 6 Switch off the water to the hose and open the evacuation valve to empty the tank.
 - 7 Press the flush button to open the valve and remove the hose when done.
- Lubricate the holding tank evacuation valve. (to be carried out immediately after flushing the holding tank).
Undo the four bolts holding the drain valve assembly together and remove the main body section. Lubricate the slide paddle using lithium grease or similar so the open/close operation is smooth. Install the drain valve.
Do not over tighten as this will restrict the operation of the valve.
 - Disinfect the sink tanks and flush with fresh water.

10 Toilet Facility

Sticker Legend

Refer to the toilet facility sticker legend to become familiar with the equipment found in the toilet facility.

- 1 Do not stand up, do not use standing up position, do not throw strange objects in the bowl.
- 2 No smoking
- 3 Left door closed
- 4 Right door closed
- 5 Flushing water
- 6 Hand wash/sink water
- 7 Emergency button
- 8 Logo
- 9 Toilet paper roll
- 10 Paper towel dispenser
- 11 Soap dispenser
- 12 Trash bin



T8014111

VOLVO

Volvo Bus Corporation

Göteborg, Sweden

Driver's Handbook

Replacement of Wheel and Air Springs

B13R

VOLVO

Foreword

This manual contains information concerning the replacement of the wheels and bellows. The information in this manual applies to vehicles built January 2009 and later. Please keep this manual in the vehicle at all times.

Note: Illustrations in this manual are used for reference only and may differ slightly from the actual vehicle. However, key components addressed in this document are represented as accurately as possible.

The National Highway Traffic Safety Administration (NHTSA) and Volvo Trucks North America should be informed immediately if you believe that the vehicle has a defect that could cause a crash, injury or death.

Contact NHTSA by calling the Auto Safety Hotline at 1 (888) 327-4236, by writing to NHTSA, U.S. Department of Transportation, Washington, DC 20590, by TTY at 1 (800) 424-9153, or visit their website at www.nhtsa.dot.gov.

Volvo Bus Corporation

Göteborg, Sweden

Order number: 88993880

©2010 Volvo Bus Corporation, Göteborg, Sweden

All rights reserved. No part of this publication may be reproduced, stored in retrieval system, or transmitted in any forms by any means, electronic, mechanical, photocopying, recording or otherwise, without the prior written permission of Volvo Bus Corporation

Contents

Replacement of Wheels.....	1
Introduction.....	1
Wheel Replacement.....	1
Before Lifting the Vehicle.....	1
Lifting Point s.....	1
Lifting Point for Wheel Change.....	2
Lowering the Spare Wheel.....	4
Lifting with the Jack.....	8
Install the Spare Wheel.....	9
Install the Spare Wheel in the Mount Position.....	11
Replacement of Air Springs.....	14
Air Springs Replacement.....	14
Before Lifting the Vehicle.....	14
Lifting Point Decal.....	14
Lifting Point, Air Springs Replacement.....	15
Air Spring Replacement.....	16
Recovery and Towing.....	17
Towing.....	17
Release the Parking Brake with Air from the Bus Tires.....	19
Tire Chains.....	20
Tire chains.....	20

Safety Information

IMPORTANT: Before driving this vehicle, be certain that you have read and that you fully understand each and every step of the driving and handling information in this manual. Be certain that you fully understand and follow all safety warnings.

IT IS IMPORTANT THAT THE FOLLOWING INFORMATION BE READ, UNDERSTOOD AND ALWAYS FOLLOWED.

The following types of advisories are used throughout this manual:



DANGER

Danger indicates an unsafe practice that could result in serious personal injury or death. A danger advisory banner is in **white** type on a **black** background with a **black** border.



WARNING

Warning indicates an unsafe practice that could result in personal injury. A warning advisory banner is in **black** type on a **gray** background with a **black** border.



CAUTION

Caution indicates an unsafe practice that could result in damage to the product. A caution advisory is in **black** type on a **white** background with a **black** border.

Note: Note indicates a procedure, practice, or condition that must be followed in order for the vehicle or component to function in the manner intended.

Introduction

This booklet is intended to help the driver about how to replace wheels and air springs properly

Wheel Replacement

Before Lifting the Vehicle

Make sure the bus is parked on a flat even surface that is not too soft. Turn on the hazard warning flashers. Place the warning triangle out.

Ask the passengers to leave the bus.

Verify that the parking brake is applied.

Lifting Point s

The bus has special jack lifting points.

These jack lifting points are marked with decals.

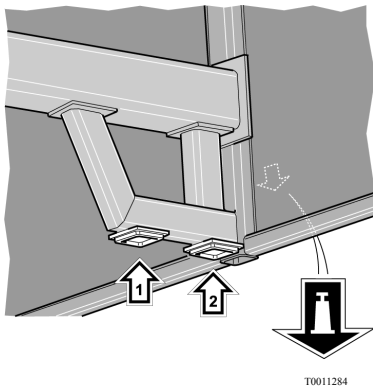

Example of lifting points.



Jack lifting point decal

2 Replacement of Wheels

Lifting Point for Wheel Change

Two Axle Bus

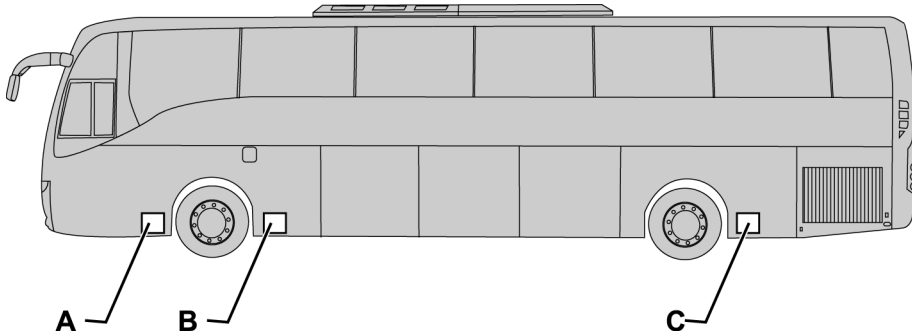

T0015373

Bus model	Chassis	Lifting point for front axle	Lifting point for rear axle
9700	B12B,B13	B	C

Three Axle Bus

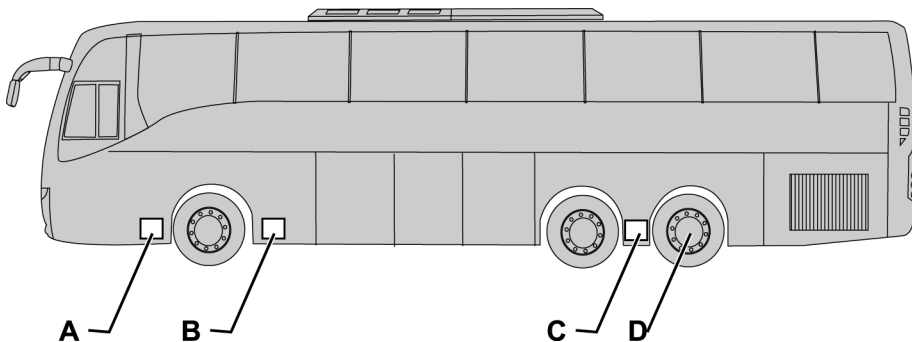

T0015374

Bus model	Chassis	Lifting point for front axle	Lifting point for driving axle	Lifting point for trailing axle
9700	B12B,B13	B	C	D Lift under the axle

Lifting Point C

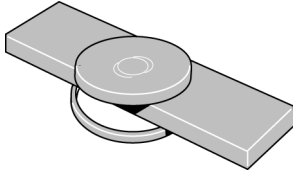

T0011285

Adapter for lifting air suspension beam

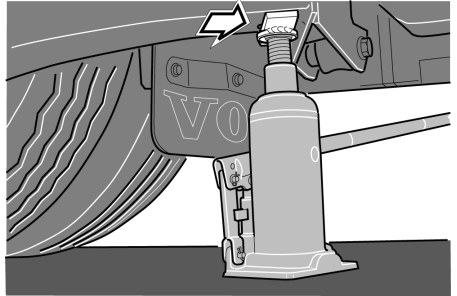

T0011286

Jack with adapter at lifting point C

Lifting Point D



DANGER

Exercise the greatest care when the trailing axle is raised. Be sure to position the jack properly so that the bus does not slide off the jack. Failure to do so may result in serious personal injury or death.

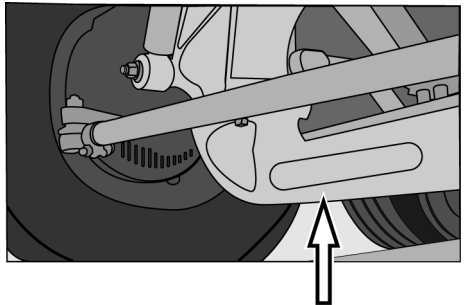

T0015389

4 Replacement of Wheels

Lowering the Spare Wheel

The Volvo 9700 is equipped with a spare wheel located behind the front bumper. To remove the spare wheel, proceed as follows:

- Unscrew and remove the two support brackets (1,2) for the front under run protection brace.

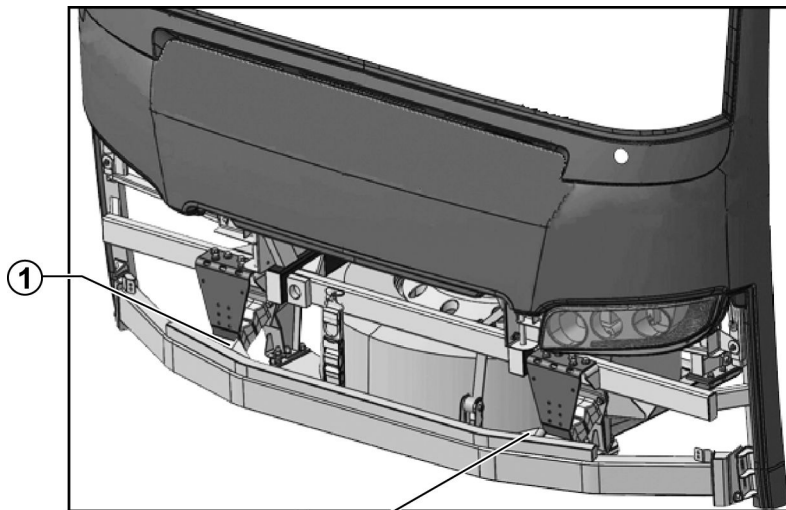

2

1

2

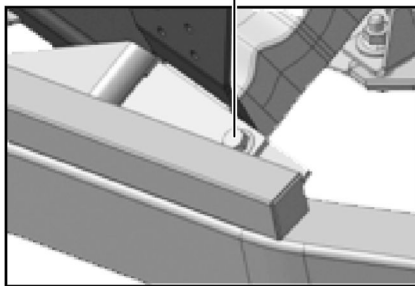
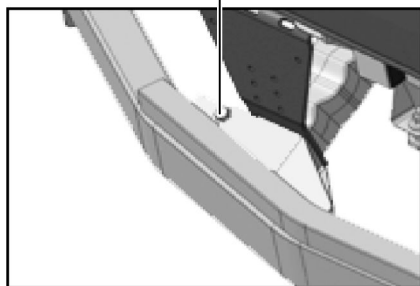

Replacement of Wheels 5

- Turn the front under run protection brace (1) downward.
- Check that the belts are tighten.
- Unscrew the security nuts (2,3)

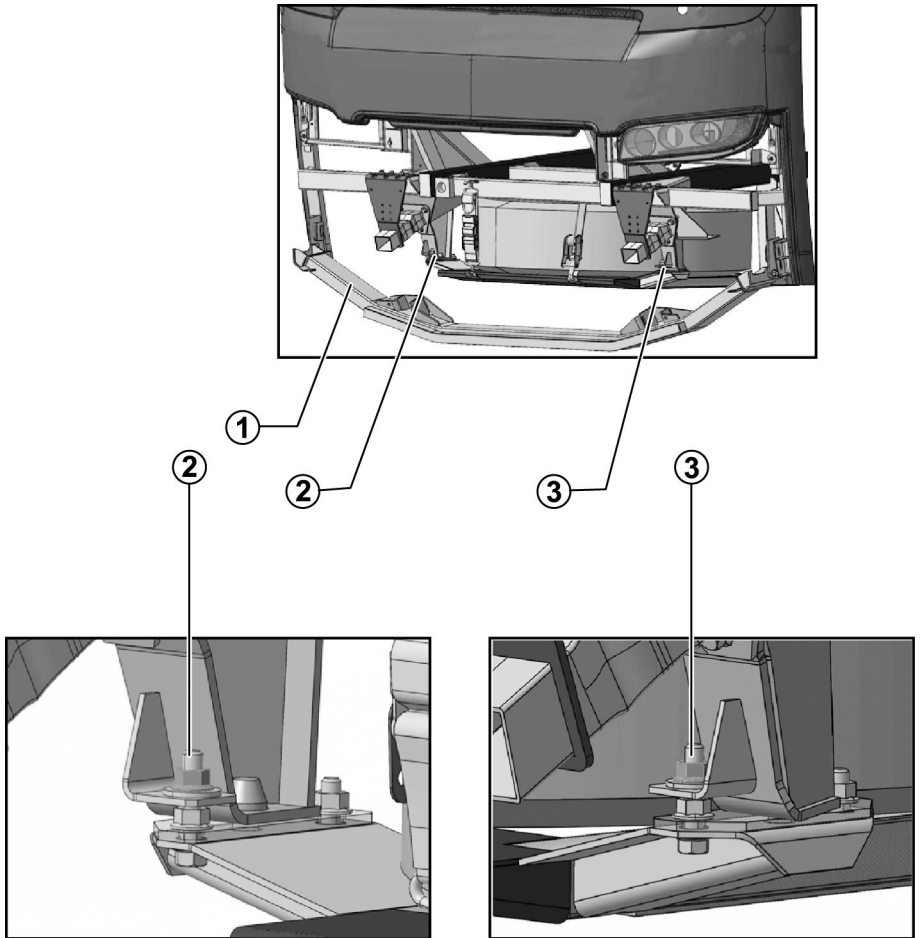

6 Replacement of Wheels

- Release and loosen the sling (1)

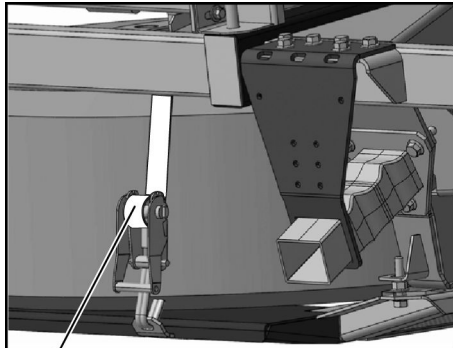

T0015377

- Loose sling slowly to down the spare wheel (2).

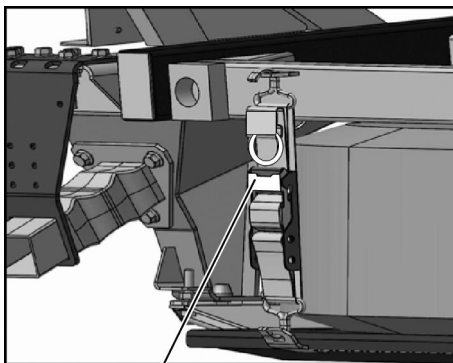

T0015378



DANGER

Keep hands clear from the underside of the tire while removing it as they may get trapped between the tire and the front under run protection brace. Failure to do so may result in serious personal injury.

- Remove the spare wheel from the support frame.

Note: The sling may be used to pull out the spare wheel.

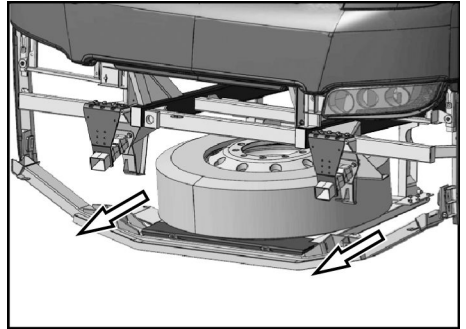

T0015379

8 Replacement of Wheels

Lifting with the Jack

DANGER

Always ensure that the bus **cannot** move. Always place stop chocks behind and in front of the wheels. Failure to do so may result in serious personal injury or death.

DANGER

Place the jack so that you do not have your arm or other body part beneath the bus when lifting is performed. Failure to do so may result in serious personal injury or death.

DANGER

Never get under a vehicle that is lifted with only a jack. Support the vehicle with jack stands or other suitable equipment if it is necessary to get under it. Failure to do so may result in serious personal injury or death.

- 1 Establish where the lifting points are. Refer to “Lifting Point for Wheel Change”, page 2 .
- 2 Place the jack directly beneath the jacking point. Assure that the jack is placed on a hard even surface.

Note: For the rear wheels, the jacking point can be a fixture on the chassis or sometimes an air suspension beam. Use the adapter if the bus is to be lifted on an air suspension beam.

- 3 Loosen the wheel nuts about two turns.
- 4 Make sure that the bus cannot slide off the jack during the lift.
- 5 Lift the bus sufficiently for the wheel to leave the ground.
- 6 Remove the wheel nuts completely and then the wheel.

Install the Spare Wheel

Before Installation

Clean the hub and spare wheel. Perform a check of the wheel contact surface with dual wheels. Check that the wheel nut threads and nut thrust washers are not damaged. Grease them lightly if possible.

Single Wheel

- 1 Lift the wheel up onto the hub so that it is centered. Install two diagonally opposite wheel nuts.
- 2 Install the remainder of the wheel nuts and tighten lightly.
- 3 Lower the bus and perform the final tightening of all nuts.

Dual Wheels

Use two guide sleeves, **9996833**.

- 1 Install the guide sleeves. Lift the inner wheel onto the hub so that it is centered.
- 2 Lift up and install the outer wheel. Make sure the valve is placed on the opposite side to the inner wheel.
- 3 Remove the guide sleeves. Install two diagonally opposite wheel nuts and tighten lightly. Install the remainder of the wheel nuts and tighten them.
- 4 Lower the bus and perform the final tightening of all nuts.

10 Replacement of Wheels

Tightening

Torque the nuts in the correct sequence, according to the tightening diagram.

Start by torquing them to **200 ± 8 Nm (148 ± 6 lb-ft)**. After that, angle torque in sequence to **90° ± 10°**.

Note: Re-torque the wheel nuts after about 200 km (124 mi).

Note: Check the tire pressure at the first service station along the road.

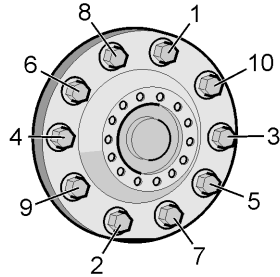

T0008985

Check Tightening at a Workshop

The torque check should not be less than **670 ± 30 Nm (494 ± 22 lb-ft)** for any wheel nut.

Note: Re-torque the wheel nuts every sixth month whether the wheel has been removed or not.

Install the Spare Wheel in the Mount Position

To install the spare wheel in the mount position proceed as follows:

- Put the spare wheel on the support frame (1).

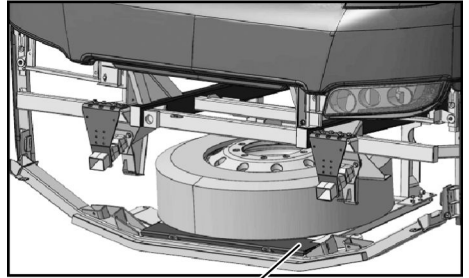

①

T0015380

- Install the sling on the left side and use the sling mechanism to lift the spare wheel up to its raised position.

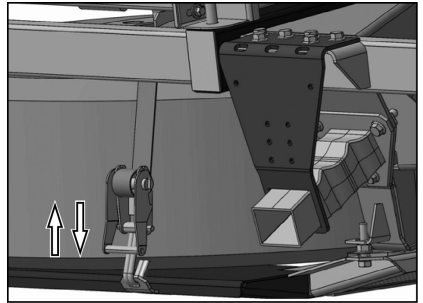

T0015381

12 Replacement of Wheels

- Install the belt on the right side and tighten the sling mechanism (1).

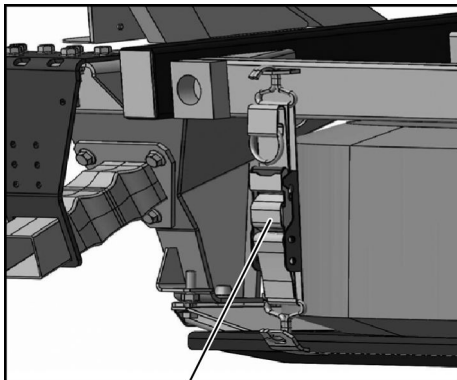

1

T0015382

- Install the two nuts and tighten them (2,3).

2

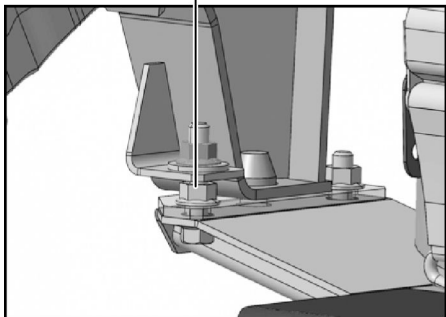

3

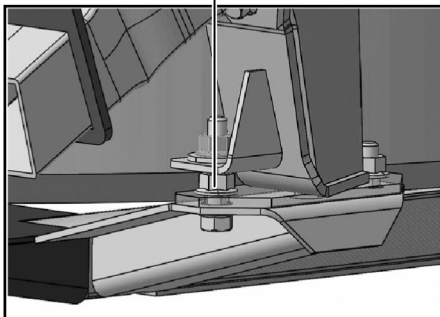

T0015383

- Rotate the front under run protection brace upward (1) and install the brackets with the screws (2,3).

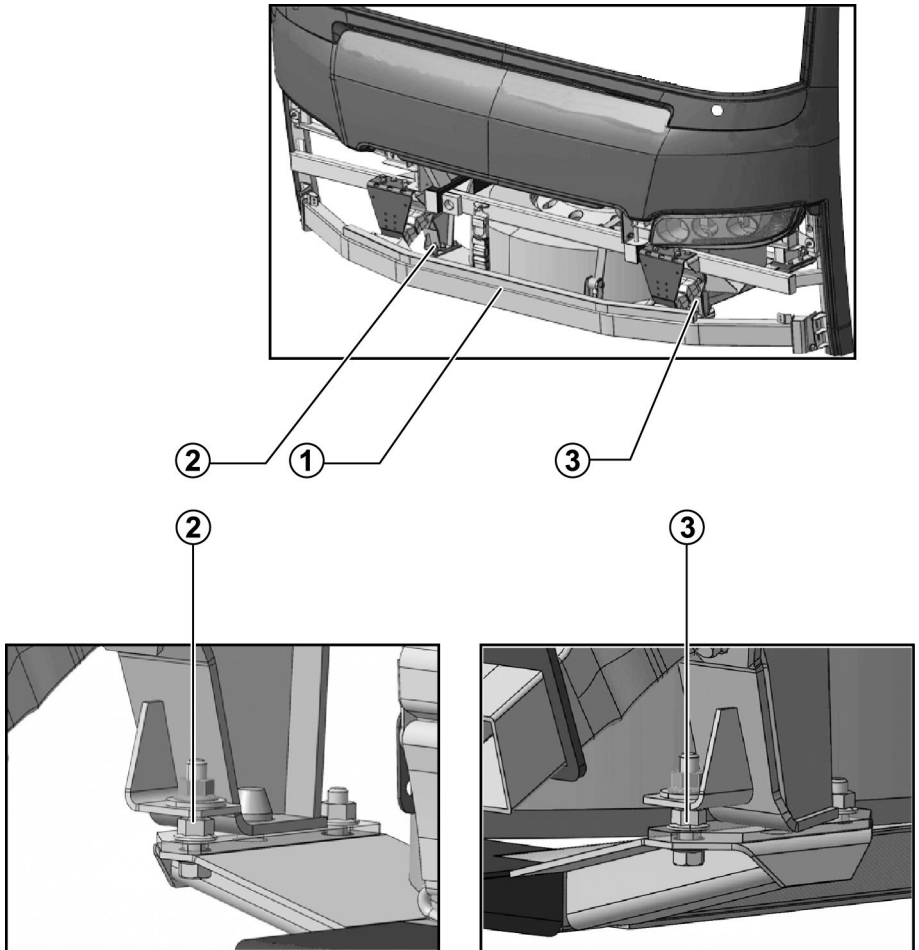

14 Replacement of Air Springs

Air Springs Replacement

Before Lifting the Vehicle

Make sure the bus is parked on a flat even surface that is not too soft. Turn on the hazard warning flashers. Place the warning triangle out.

Ask the passengers to leave the bus.

Verify that the parking brake is applied.

Lifting Point Decal

The bus has special jack lifting points. These jack lifting points are marked with decals.



T0008922

Lifting Point, Air Springs Replacement

Two Axle Bus

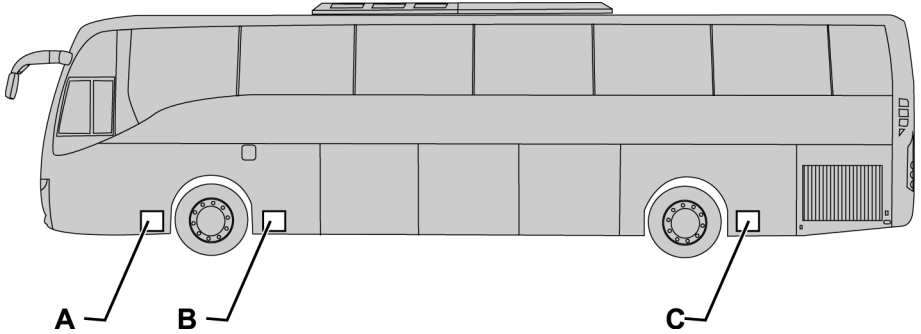

T0015373

Bus model	Chassis	Front lifting point	Rear lifting point
9700	B12B,B13	B	C

Three-axle Bus

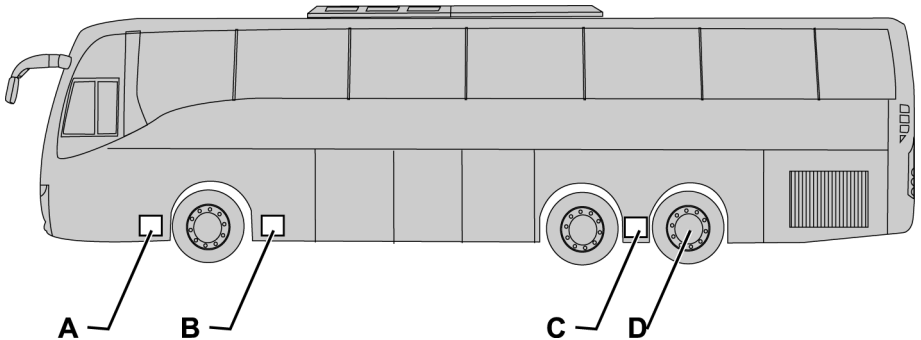

T0015374

Bus model	Chassis	Lifting point for front axle	Lifting point for driving axle	Lifting point for trailing axle
9700	B12B,B13	B	D	D

16 Replacement of Air Springs

Air Spring Replacement

DANGER

Always ensure that the bus **cannot** move. Always place stop chocks behind and in front of the wheels. Failure to do so may result in serious personal injury or death.

DANGER

Place the jack so that you do not have your arm or other body part beneath the bus when lifting is performed. Failure to do so may result in serious personal injury or death.

DANGER

Never get under a vehicle that is lifted with only a jack. Support the vehicle with jack stands or other suitable equipment if it is necessary to get under it. Failure to do so may result in serious personal injury or death.

- 1 Establish where the lifting points are. Refer to “Lifting Point, Air Springs Replacement”, page 15.
- 2 Place the jack directly beneath the jacking point. Assure that the jack is placed on a hard even surface.

Note: For the rear wheels: The jacking point can be a fixture on the chassis or sometimes an air suspension beam. Use the adapter if the bus is to be lifted on an air suspension beam.

- 3 Make sure that the bus cannot slide off the jack during the lift.
- 4 Lift the bus sufficiently to remove the air bellows.
- 5 Install a new air bellow and lower the bus.

Towing



CAUTION

Failure to disconnect the driveshaft, remove the drive axle shaft(s) or lift the drive wheels off the ground before towing or pushing the vehicle, can cause serious transmission damage and void the transmission warranty.



CAUTION

Do not run the engine while towing as this may result in transmission damaged.

The power steering will not function with the engine off. Keep in mind that this will make the bus steering very heavy.

If towing is over a longer distance, checks should be performed to verify the bus parking brake does not gradually become applied, due to the air pressure in the system dropping. If the bus's engine cannot be started to supply sufficient pressure to the braking circuit, pressurization from an external source can be used. Behind the front hatch there is a valve to which an external air supply can be connected. If it is not possible to arrange external air pressure, the parking brake can be disengaged mechanically. For more information refer to the vehicle "Operators Manual".

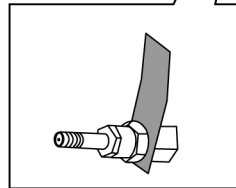
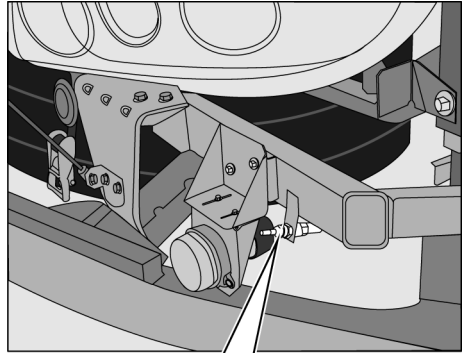

T0015390

18 Recovery and Towing

A tow bar connection should never be used for recovery (lifting), only when towing.

For more information about the connection points, refer to the vehicle “Operators Manual”.

- Use a tow bar, **NOT** a chain or rope. Install the tow bar to the correct attaching points on the vehicle.
- Ensure that the bus is attached to the towing vehicle before releasing the parking brake or removing the stop chocks from the wheels.

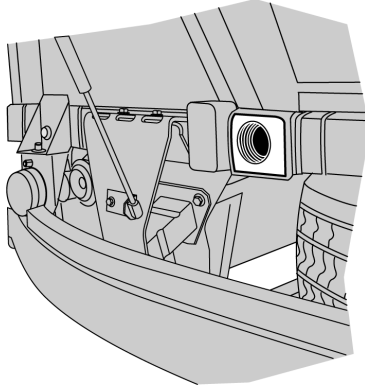

T8012390

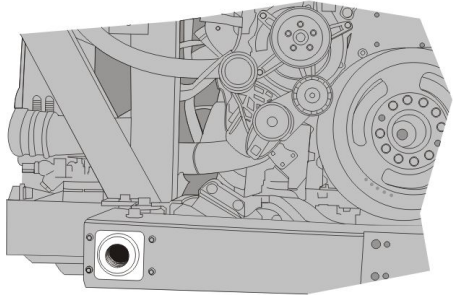

T8059309

Release the Parking Brake with Air from the Bus Tires



DANGER

Always ensure that the bus **cannot** move. Always place stop chocks behind and in front of the wheels. Failure to do so may result in serious personal injury or death.

Note: Instead of using the air pressure from tires, you can use an external supply of air compressed with at least 4 bars (58 psi).

- To prevent the bus from moving, chock the wheels.
- Connect the clamp end of the tire inflation hose to the valve of one of the tires.
- Move the parking brake control to the drive position.
- While pressing the other end of the tire inflation hose against the pump nipple, press in the blocking valve. Now the brake system is filled with the air from the tire. Filling can stop as soon as the air flow stops.

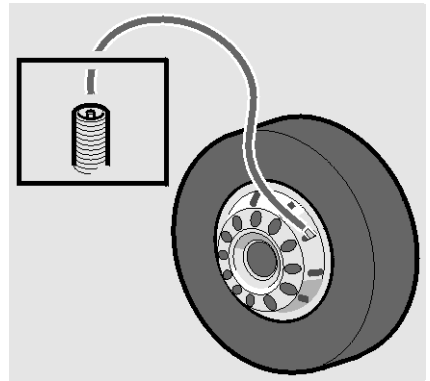

T0009182

20 Tire Chains

Tire chains

Some jurisdictions may require their use in certain weather conditions or during certain months of the year.

To install the tire chains please follow the instructions from the tire chains manufacturer.

Following a small procedure to install the tire chains on a bus tire, just as general explanation.

- Laid Chains in front of Drive Axle Tire
- Make sure that the chain links are spread out
- Drive forward onto 1/3 of the chain distance.
- Loop one side of the chains over the tires then loop the opposite side and link them together.

Note: Keep the chains as tight as possible in order to avoid damage to the coachwork

Note: Refer to laws of each State for more information related to dates an areas were the tire chains should be used, and on what axle(s) must be installed.

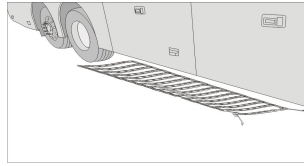

T8061480

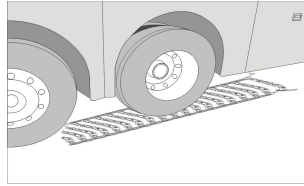

T8061481

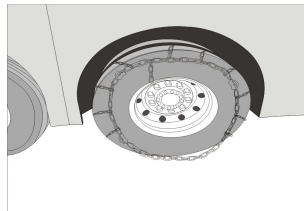

T8061482

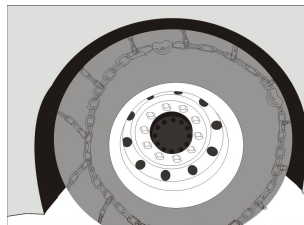

T8061483

VOLVO

Volvo Bus Corporation

Göteborg, Sweden

Operating Instructions

Manual Roof Hatch, Operation

9700 Bus

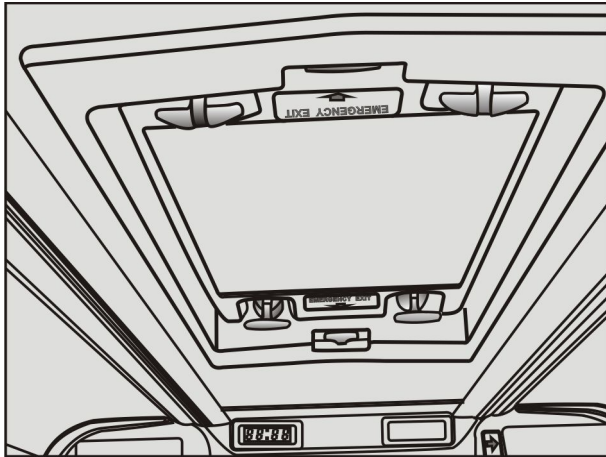

TR061505

VOLVO

Foreword

This manual contains information concerning the operation and function of the Manual Roof Hatches mounted on the 9700 US/CAN.

Illustrations in this manual are used for reference only and may differ slightly from the actual vehicle. However, key components addressed in this document are represented as accurately as possible.

The National Highway Traffic Safety Administration (NHTSA) and Prevost should be informed immediately if you believe that the vehicle has a defect that could cause a crash, injury or death.

Contact NHTSA by calling the Auto Safety Hotline at 1(888) 327-4236, by writing to NHTSA, U.S Department of Transportation, Washington, DC 20590, by TTY at 1 (800) 424-9153, or visit their web site at www.nhtsa.dot.gov.

Volvo Bus Corporation

Göteborg, Sweden

Order number: 88994761

©2010 Volvo Bus Corporation, Göteborg, Sweden

All rights reserved. No part of this publication may be reproduced, stored in retrieval system, or transmitted in any forms by any means, electronic, mechanical, photocopying, recording or otherwise, without the prior written permission of Volvo Bus Corporation

Contents

Introduction	1
Introduction	1
Manual Roof Hatches	2
Normal operation	2
Opening the Roof Hatch for an emergency	3
Reassembling the Roof Hatch	5
Index	9

Safety Information

IMPORTANT: Before driving this vehicle, be certain that you have read and that you fully understand each and every step of the driving and handling information in this manual. Be certain that you fully understand and follow all safety warnings.

It is important that the following information be read, understood and always followed.

The following types of advisories are used throughout this manual:

DANGER

Danger indicates an unsafe practice that could result in serious personal injury or death. A danger advisory banner is in **white** type on a black background with a **black** border.

WARNING

Warning indicates an unsafe practice that could result in personal injury. A warning advisory banner is in **black** type on a **gray** background with a **black** border.

CAUTION

Caution indicates an unsafe practice that could result in damage to the product. A caution advisory is in **black** type on a **white** background with a **black** border.

Note: Note indicates a procedure, practice, or condition that must be followed in order for the vehicle or component to function in the manner intended.

Introduction

This booklet is intended to help the driver about how to operate properly and take care of the manual roof hatches.

2 Manual Roof Hatches

Normal operation

Opening the hatch

When fresh air intake is required, e.g., when the Air Conditioning system is not working, it is possible to open the roof hatch from inside. To open the hatch procedure as follows:

- To unlock the roof hatch pull the two black handles towards center of the hatch
- Push up the roof hatch on the side were was unlocked
- Do the same for opposite end.

Note: Do not open the roof hatch when the Air Conditioning System is working.

Closing the hatch.

To close the hatch proceed as follows

- Take the two black handles and pull down
- Pull down again the roof hatch up to red tab appears, this means that the hatch is properly closed
- Do the same for the opposite end.

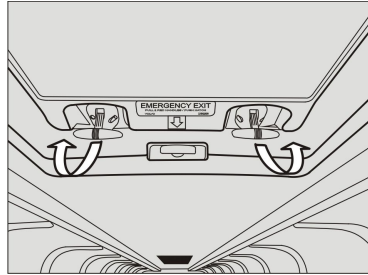

T8061506

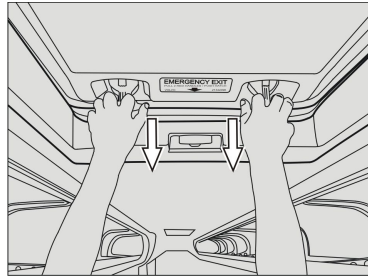

T8061507

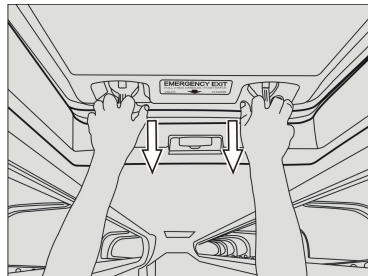

T8061507

Opening the Roof Hatch for an emergency

Interior

In case of an emergency, to open the hatch from the inside, perform the following steps:

- 1 Pull out the red emergency handle at both ends of the hatch.
- 2 Push out the roof hatch.

Note: When the roof hatch is opened because an emergency, a strip fixed at one end avoids that the hatch gets miss.

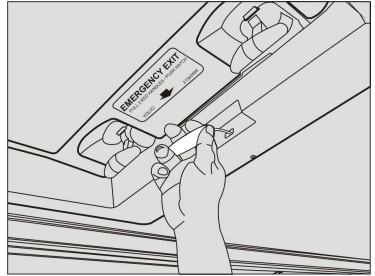

T8061509

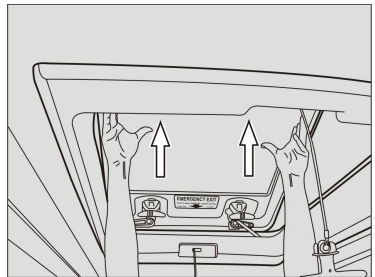

T8061510

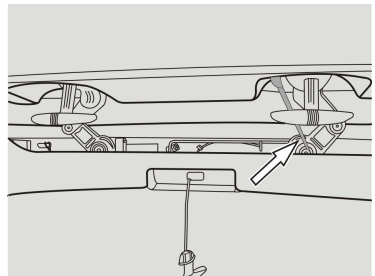

T8061511

4 Manual Roof Hatches

Exterior

In case of an emergency, to open the hatch from the outside, perform the following steps:

- 1 Pull out both red emergency handles, located at the right side of the frame of the roof hatch
- 2 Pull out the roof hatch.

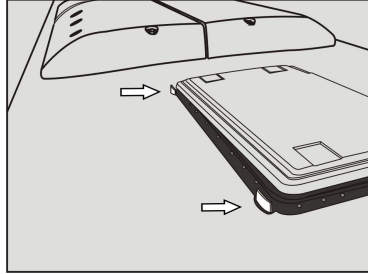

T8061298

Reassembling the Roof Hatch

To reassembly the roof hatch after it was opened for an emergency, proceed as follows:

Put the roof hatch in a position were it will possible to have access to the mechanisms.

Pull up the black handle and pull down the mechanism, do it for each mechanism

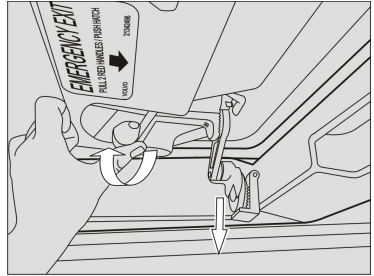

T8061512

Turn the lugs until the holes are horizontally

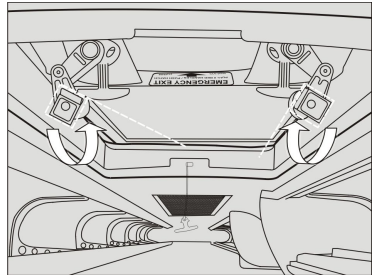

T8061513

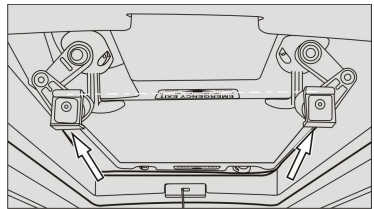

T8061514

Move the rod to allow to insert the roof hatch mechanisms in their position, do it for each end

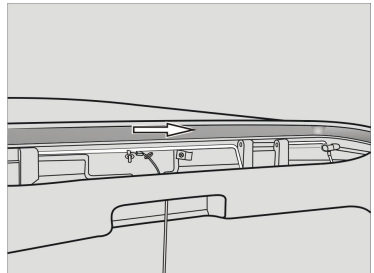

T8061515

6 Manual Roof Hatches

Place the mechanism into their positions (two by each end)

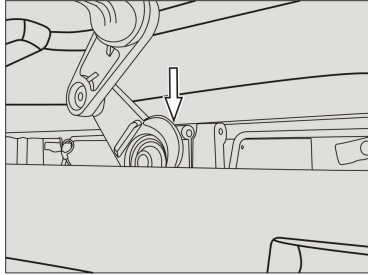

T8061516

Insert the larger end of the rod in the middle of the lug to use like a guide, do the same for the other end of the roof hatch

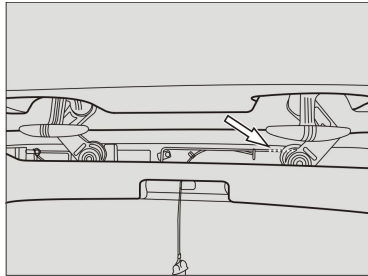

T8061517

Now, carefully insert both ends of the rod inside the holes of the frame and mechanisms

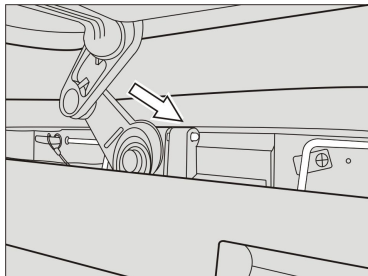

T8061568

When the rod is completely inserted in its position, secure it with the plastic bracket

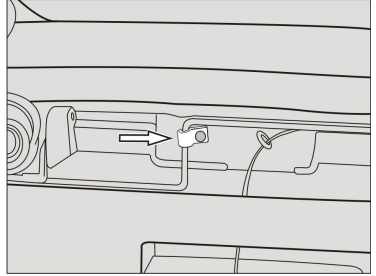

T8061518

Place the emergency red handles in their original positions



T8061519

Close the hatch as the normal closing procedure

Note: Always check that the roof hatch is close properly by checking the red tabs are visible.

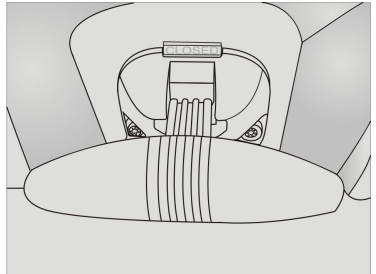

T8061520

Index

I

Introduction 1

M

Manual Roof Hatches 2

N

Normal operation 2

O

Opening the Roof Hatch for
an emergency. 3

R

Reassembling the Roof
Hatch 5

S

Safety Information 5

VOLVO

Volvo Bus Corporation

Göteborg, Sweden

Operating Instructions

Automatic Fire Supression System

9700 Bus

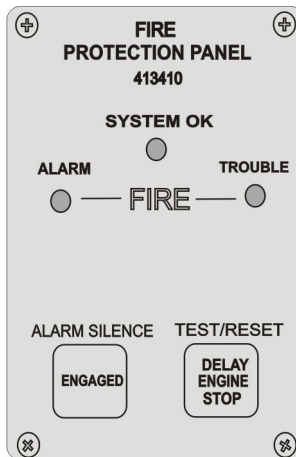

VOLVO

Foreword

This manual contains information concerning the operation and function of the Anti Fire Supression System mounted on the 9700 US/CAN.

Illustrations in this manual are used for reference only and may differ slightly from the actual vehicle. However, key components addressed in this document are represented as accurately as possible.

The National Highway Traffic Safety Administration (NHTSA) and Prevost should be informed immediately if you believe that the vehicle has a defect that could cause a crash, injury or death.

Contact NHTSA by calling the Auto Safety Hotline at 1(888) 327-4236, by writing to NHTSA, U.S Department of Transportation, Washington, DC 20590, by TTY at 1 (800) 424-9153, or visit their web site at www.nhtsa.dot.gov.

Volvo Bus Corporation

Göteborg, Sweden

Order number: 88996731

©2010 Volvo Bus Corporation, Göteborg, Sweden

All rights reserved. No part of this publication may be reproduced, stored in retrieval system, or transmitted in any forms by any means, electronic, mechanical, photocopying, recording or otherwise, without the prior written permission of Volvo Bus Corporation

Contents

Introduction	1
Introduction	1
General Information	1
System Operation	2
Protection Panel	2
Normal	3
Trouble	4
Fire Detector Activated	5
Delay AFSS button.....	5
Manual Activation switch	6
Pre-Trip Inspection	7
Pre-Trip Inspection.....	7
Index	9

Safety Information

IMPORTANT: Before driving this vehicle, be certain that you have read and that you fully understand each and every step of the driving and handling information in this manual. Be certain that you fully understand and follow all safety warnings.

It is important that the following information be read, understood and always followed.

The following types of advisories are used throughout this manual:



DANGER

Danger indicates an unsafe practice that could result in serious personal injury or death. A danger advisory banner is in **white** type on a black background with a **black** border.



WARNING

Warning indicates an unsafe practice that could result in personal injury. A warning advisory banner is in **black** type on a **gray** background with a **black** border.



CAUTION

Caution indicates an unsafe practice that could result in damage to the product. A caution advisory is in **black** type on a **white** background with a **black** border.

Note: Note indicates a procedure, practice, or condition that must be followed in order for the vehicle or component to function in the manner intended.

Introduction

This booklet is intended to help the driver about how to operate properly and take care of the Automatic Fire Suppression System (AFSS).

General Information

Automatic Fire Suppression System (AFSS) provides continuous monitoring of a vehicle's hazard areas. It responds to fires fueled by diesel, gasoline, oil, lubricants and other flammable liquids. If a fire is detected, the system will alert the driver with both audible and visual alarms while immediately shutting down the ventilation system to prevent smoke from entering the passenger area. A time delay allows the driver the capability to bring the vehicle to a safe stop prior to the activation of the fire extinguisher and engine shutdown. The system can also be manually activated immediately by the driver.

Automatic Fire Suppression System consists of three elements: Operator Controls, Detection, and Suppression.

Hazards Protected

Engine Compartment

2 System Operation

Protection Panel

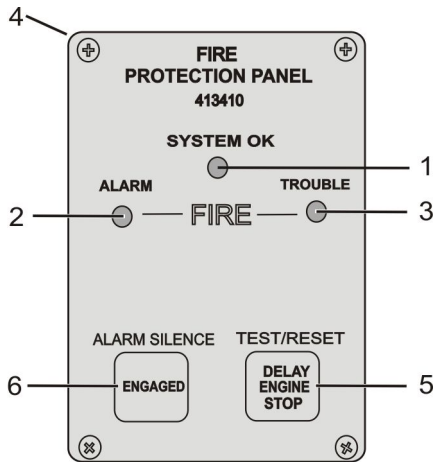

T8061693

The protection panel displays the current system status. The protection panel contains:

- 1 SYSTEM OK lamp
- 2 Fire ALARM lamp
- 3 TROUBLE lamp
- 4 Audio Alarm
- 5 TEST/RESET switch
- 6 ALARM SILENCE switch

Normal

The “SYSTEM OK” lamp indicates power is on the system and that there are no trouble conditions present.

Note: If battery power to the system is low, the “SYSTEM OK” lamp will blink

Depressing the “TEST/RESET” switch tests the protection panel lamps and audio alarm. The “ALARM SILENCE” switch will disable the audio alarm.

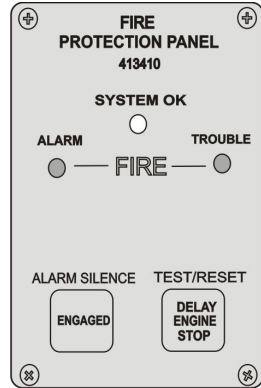

T8061694

4 System Operation

Trouble

The “TROUBLE” lamp blinks if there is a fault in the Detection Circuit due to wiring problem or sensor problem. If the fault is in the extinguisher circuitry the will illuminates solid and means that are a wiring problem or the extinguisher is discharged..

When the “TROUBLE” lamp is on, the “SYSTEM OK” lamp will be off and the audible alarm will sound intermittently.

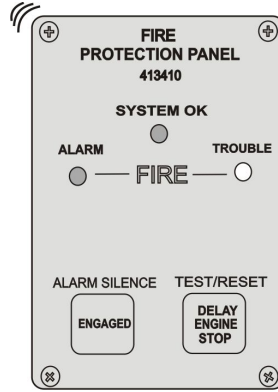

T8061695

Fire Detector Activated

When a fire detector automatically detects a fire, the audio alarm activate and the fire “ALARM” lamp illuminates solid

Note: If the vehicle is not safe to stop (i.e. on railtracks, in intersection) depress the DELAY ENGINE STOP button to delay 15 seconds that engine shutdowns and the extinguisher discharges; if is needed more time you need to deprees the button again and before the previous 15 seconds of delay finished.

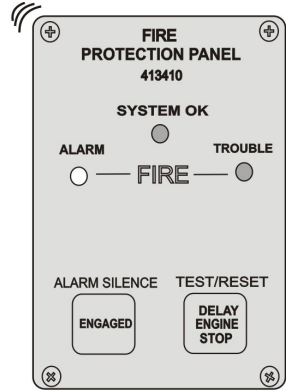

T8061696

Delay AFSS button

If it is not possible to find quickly a safe place to stop the bus, use delay AFSS button instead of the Delay Engine Stop button (described above), then, depress the delay AFSS button to stop the activation of the system up to find a safe place to stop the bus, then press to the original position the Delay AFSS button to allow that engine stops and extinguisher discharges.

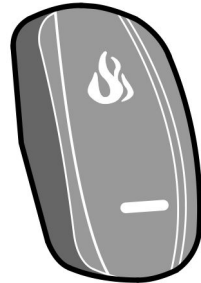

T8062854

6 System Operation

Manual Activation switch

The manual activation switch allows immediate system activation (extinguisher discharge and engine shutdown) by the operator at any time.

Activation of the switch is accomplished by twisting and pulling the tamper seal to remove, lifting the cover and pressing and holding the red “FIRE” button for more than half a second.

After the manual activation switch has been activated, the fire “ALARM” lamp blinks and the audio alarm activates. The lamp will remain blinking until power is cycled to the system.

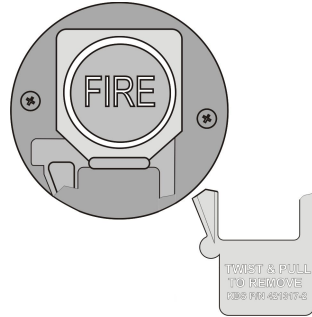

T8061697

Pre-Trip Inspection

Before starting a trip, first check the Control Panel by pressing the “TEST/RESET ”switch, and the following should occur:

- All lamps and switches should be illuminated.
- Audible Alarm should sound

As a second step, verify the tamper seal on the manual discharge switch is intact and access to the switch is unobstructed.

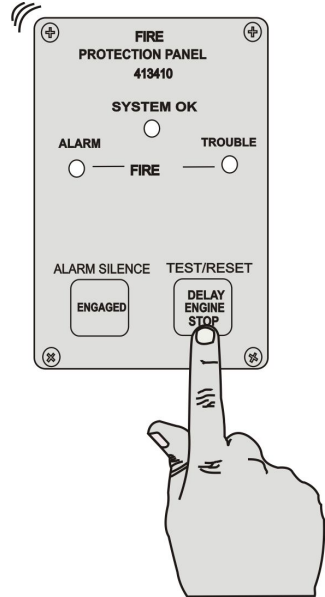

Index

D

Delay AFSS button..... 5

F

Fire Detector Activated..... 5

G

General Information..... 1

H

Hazards Protected..... 1

I

Introduction 1

M

Manual Activation Switch..... 6

N

Normal..... 3

P

Pre-Trip Inspection 7

Protection Panel..... 2

S

Safety Information 5

System Operation 2

T

Trouble 4

VOLVO

Volvo Bus Corporation

Göteborg, Sweden

Operating Instructions

WHEEL CHAIR LIFT

9700 Bus

VOLVO

Foreword

This manual contains information concerning the operation and function of the Wheel Chair Lifter mounted on the 9700 US/CAN.

Illustrations in this manual are used for reference only and may differ slightly from the actual vehicle. However, key components addressed in this document are represented as accurately as possible.

The National Highway Traffic Safety Administration (NHTSA) and Prevost should be informed immediately if you believe that the vehicle has a defect that could cause a crash, injury or death.

Contact NHTSA by calling the Auto Safety Hotline at 1(888) 327-4236, by writing to NHTSA, U.S Department of Transportation, Washington, DC 20590, by TTY at 1 (800) 424-9153, or visit their web site at www.nhtsa.dot.gov.

Volvo Bus Corporation

Göteborg, Sweden

Order number: 88997239

©2010 Volvo Bus Corporation, Göteborg, Sweden

All rights reserved. No part of this publication may be reproduced, stored in retrieval system, or transmitted in any forms by any means, electronic, mechanical, photocopying, recording or otherwise, without the prior written permission of Volvo Bus Corporation

Contents

Introduction	1
Introduction.....	1
General Safety Precautions.....	3
Major Lift Components	4
Operating Instructions	7
Operating Instructions.....	7
Daily Safety Check.....	10
Platform Motions.....	11
Controls and Indicators.....	12
Normal Lift Operation.....	19
Manual Lift Operation.....	29
Maintenance	35
Cleaning	35
Maintenance Schedule.....	35
Index	39

Safety Information

IMPORTANT: Before driving this vehicle, be certain that you have read and that you fully understand each and every step of the driving and handling information in this manual. Be certain that you fully understand and follow all safety warnings.

It is important that the following information be read, understood and always followed.

The following types of advisories are used throughout this manual:

DANGER

Danger indicates an unsafe practice that could result in serious personal injury or death. A danger advisory banner is in **white** type on a black background with a **black** border.

WARNING

Warning indicates an unsafe practice that could result in personal injury. A warning advisory banner is in **black** type on a **gray** background with a **black** border.

CAUTION

Caution indicates an unsafe practice that could result in damage to the product. A caution advisory is in **black** type on a **white** background with a **black** border.

Note: Note indicates a procedure, practice, or condition that must be followed in order for the vehicle or component to function in the manner intended.

Introduction

The bus Volvo 9700 US/CAN could be equipped with a Wheel Chair Lifter, intended to provide wheelchair access to the vehicle.

The mechanical linkages provide smooth movement to the platform, which has a rated load capacity of 600 pounds (273 kilograms). Five hydraulic cylinders are employed to move the lift components. Two cylinders are mounted within the scissors assembly to extend and retract the platform assembly. A third cylinder raises and lowers the inner barrier.

The remaining two cylinders raise and lower the platform assembly. The movement of these cylinders is multiplied by a chain lift connected between the intermediate frame (rear portion of platform assembly) and the platform itself. As the cylinders lift the intermediate frame the chain lift doubles the movement of the platform assembly.

The lift contains an electro-hydraulic pump with a built-in manual backup pump. If the lift loses electrical power, it can be raised or lowered manually. The cylinders are controlled by solenoid valves that are operated manually if there is an electrical failure.

2 Introduction

Platform movement is controlled with buttons on the hand held pendant. By using the buttons, the lift is extracted from the vehicle storage compartment and lowered to the ground level. The passenger boards the large non-skid platform and the operator uses the buttons to raise the platform to vehicle floor level. After the passengers departs, the platform is raised and retracted back into the vehicle. A similar procedure is used to exit.

This manual contains information about safety precautions, operating instructions, and maintenance. It is important to user safety that the lift operator be completely familiar with the operating instructions. Once the lift is installed, it is very important that the lift be properly maintained by following the Volvo recommended maintenance and inspection instructions.

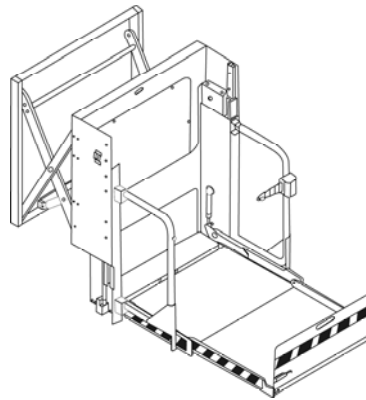

T8053922

General Safety Precautions

The following general safety precautions must be followed during operation and maintenance:

- To avoid injury, always exercise caution when operating lift and be certain that hands, feet, legs, and clothing are not in the path of product movement.
- Read and thoroughly understand the operating instructions.
- Inspect the product before each use for unsafe conditions, and unusual noises or movements. Do not use lift until any problems are corrected.
- Stand clear of doors and platform and keep others clear during operation.
- The product requires regular periodic maintenance. A thorough inspections is recommended at least once every six months. The product should be maintained at the highest level of performance.

4 Introduction

Major Lift Components

The terms used throughout are illustrated in the picture and defined in the table.

BAYLIFT TERM DEFINITIONS	
TERM	DESCRIPTION
Left, right, front, rear	Position references when installed lift is viewed from outside of vehicle.
Access panel	Provides easy access to components located behind intermediate.
Audible alarm	(not shown) Announces that something has passed through doorway threshold area and platform. Is 71” from vehicle floor level and is activated by threshold warning system (TWS). Refer to “Threshold Warning System” in chapter “Operating Instructions”.
Bridgeplate	Plate bridges gap between platform and vehicle floor when platform is at floor level. Acts as rear barrier during up and down platform motions to prevent wheelchair from rolling off of platform.
Control pendant	Hand-held device controls platform motions.
Cycle counter viewport	When platform is stowed the counter can be see here. It records number of times platform has moved from floor to ground and back to floor.
Electronic controller	Receives input signals from pendant and lift sensors and sends control signals to pump motor and hydraulic controller.
Front and rear platform sections	Lift components where wheelchair and occupant are situated during UP and DOWN platform motions. Folds and stows into platform frame.
Front rollstop	Front barrier prevents the wheelchair from inadvertently rolling off platform during platform movements.
Front rollstop latch	Manually operated latch locks front rollstop in stowed position. Rollstop is locked in upright position by dropping into slots.
Handrail	(left and right) Provides a handhold for standing passenger (standee).

Introduction 5

Handrail latch	(left and right) Manually operated latch locks handrail in outward or inward position. Push handrail downward to release latch.
Hydraulic controller	Electro-hydraulic, solenoid valve system controls distribution of hydraulic fluid to cylinders. Receives input signals from electronic controller.
Hydraulic pump and reservoir	Hydraulic pump is driven by electric motor and procedures pressure to extend and raise platform and to raise bridgeplate.
Intermediate frame	Rigid structure suspended on outer ends of scissor assembly. Platform frame is attached to front face.
Maintenance safety pin	(left and right) Maintenance item that is employed to lock platform in position on intermediate frame. Must be removed for normal operation.
Manual backup pump handle	Use to operate manual backup pump when electrical power is not available.
Manual bypass knobs	Four knobs are employed during manual operation to control distribution of hydraulic fluid to preferred lift cylinders.
Manual pressure release valve	Opening valve bleeds pressure from hydraulic system, allowing platform or bridgeplate to lower.
Pendant holders	(up to three each, depending on application) Storage clips for pendant. One clip is attached to bottom of platform.
Platform frame	Structure that platform and handrails attach to. Moves up and down on sliders fastened to intermediate frame.
Platform latch	Magnetic catch that holds folded platform sections in upright position.
Reservoir dipstick	Use to determine fluid level in reservoir.
Safety belt	Safety restraint belt that spans between handrails to confine passenger.

6 Introduction

Scissors assembly	(left and right) Telescoping components that support intermediate frame and platform, and allow horizontal movement.
Visual alarm	(not shown) Flashing red light makes it know that something has passed through doorway threshold area. Activated by threshold warning system (TWS). Refer to “Threshold Warning System”.

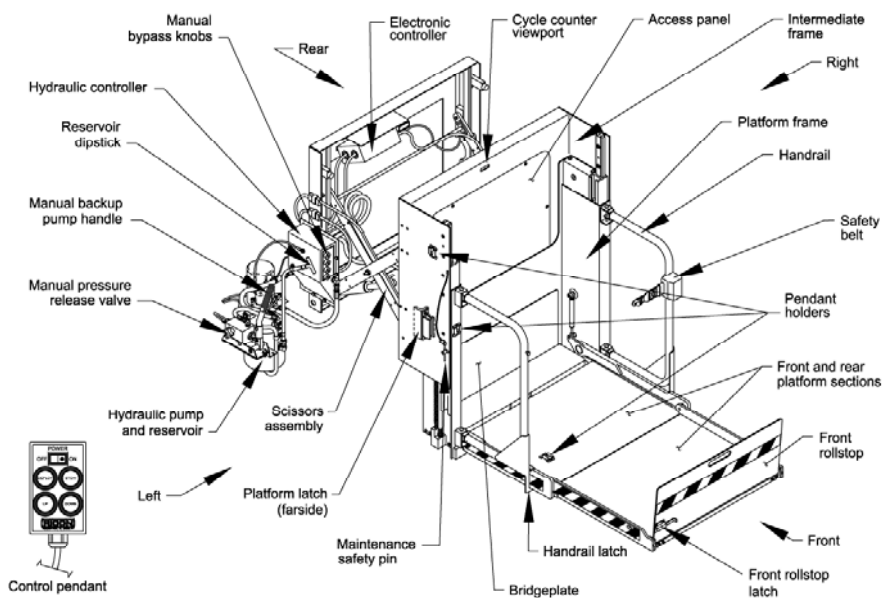

T8053923

Operating Instructions

The following safety precautions must be complied with when operating lift.

- Deploying the lift when vehicle is on sloped ground is hazardous. Operate lift with vehicle parked on level ground.
- Vehicle must be safely parked with parking brake set before using lift.
- Inspect lift before use. Do not use lift if an unsafe conditions exists, or unusual noises or movements are noticed, and contact a Volvo authorized service technician for repair.
- Read and comply with all warning labels affixed to wheel chair lift and vehicle.
- Wheelchair occupant should face outward on platform when entering or exiting vehicle to minimize the possibility of the large rear wheels rolling up and over the front rollstop.



T8053924



T8053925

8 Operating Instructions

- Do not load an oversize wheelchair into vehicle if it is too large to pivot freely inside vehicle.
- Do not place large equipment inside vehicle that can prevent pivoting of a wheelchair. Being able to pivot assures that a passenger can safely exit facing outward.
- Do not rely on a threshold-warning device (audible, or other) to confirm that is safe for a passenger to exit backwards. This device may be inoperative or unheard, and they might exit backwards when the platform is on the ground!
- When exiting vehicle, verify that platform is at same height as floor and front rollstop is upright and locked.



WARNING

Do not operate with a load in excess of 600 lbs (273 kgs).

- The upright front rollstop inhibits slow and unintentional rolling off the platform. It is not intended to stop a fast-moving wheelchair, which might tip forward if the small front wheels collide with the rollstop.
- Be certain wheelchair fits safely on platform; it must not extend beyond edges or interfere with rising and locking of front rollstop.
- Keep arms, legs, and clothing away from moving lift parts.
- The lift is intended for one wheelchair and occupant, or one standee. Do not overload lift.

Operating Instructions 9

- Do not stand in front of lift while deploying platform.
- Keep others clear while operating lift.
- Do not allow an untrained person to operate lift.
- Careful supervision is necessary if used near children.
- Lock wheelchair brakes when on platform (power chair users must turn off power and set brake).
- Use great care in wet conditions, because the wheelchair brakes are less effective if wheels or platform are wet.
- Never leave platform outside of vehicle. Return platform to stowed position after use.



T8053926

Read and understand safety precautions.
Review them periodically and ask other operators to read them.

10 Operating Instructions

Daily Safety Check

Inspect the lift before each use and check that the following conditions are met before operating:

- All functions operate properly and there are no unusual noises or movements. If problems are present, contact a Volvo authorized workshop for repair or, a Prevost service center/provider.
- Vehicle interlock is operating properly.
- No objects that may interfere with operation are present.
- General appearance and lubrication are satisfactory, and fasteners are tight.

Platform Motions

Note: The platform is an assembly comprised of the intermediate frame, platform frame, handrails, front and rear platform sections, bridgeplate, and front rollstop. Note that up and down motions operate only when platform is fully extended.

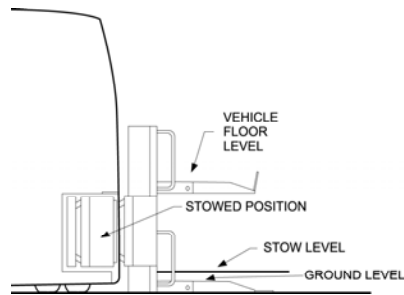

T8053932

PLATFORM MOTIONS	
MOTION	DESCRIPTION
<p>DEPLOY</p> <p>T8053927</p>	Platform moves outward from lift compartment.
<p>DOWN</p> <p>T8053928</p>	Platform lowers towards ground level. Bridgeplate automatically rises when platform drops below floor level.
<p>UP</p> <p>T8053929</p>	Platform rises towards vehicle floor level. Bridgeplate automatically lowers when platform arrives at floor level.
<p>STOW</p> <p>T8053930</p>	Platform moves downwards towards stow level and then retracts into lift compartment. If platform is below stow level, it must first be raised above stow level.

12 Operating Instructions

Controls and Indicators



WARNING

The lift is allowed to operate only when the lift and vehicle interlock circuitry requirements are met. Do not attempt to operate lift with interlock bypassed.



CAUTION

The pendant must be attached to the clip located on the bottom of the platform when the platform is stowed. The pendant can be severely damaged by the lift compartment doors if left stored on either of the other clips.

Control Pendant

The lift is operated with a hand-held, hard-wired remote-control pendant. Turn on the POWER ENABLE switch and then press an appropriate button to control each lift motion.

The POWER ENABLE switch provides power to the pendant and thereby enables the lift. When turned on, the power switch and each button illuminate.

Pressing the DEPLOY button extends the platform from the storage compartment, and pressing the STOW button retracts the platform back into the storage compartment. Pressing the DOWN button lowers the platform towards the ground, and pressing the UP button raises the platform towards the vehicle floor. A button must be held depressed until the motion is completed. Movement of the platform can be halted at any time by releasing the button.

Note: In addition to the four powered operations described above, there are several manual operations required to deploy, lower, and stow the platform. Refer to Manual Lift Operation section.

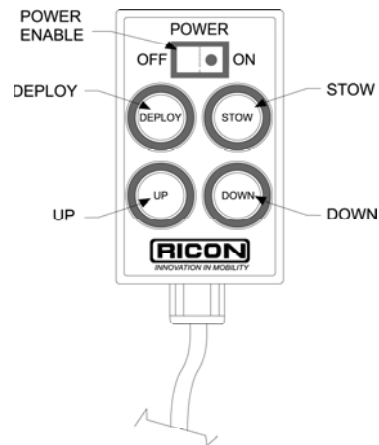

T8053933

14 Operating Instructions

Circuit Breakers

Main Circuit Breaker

The main circuit breaker is located in vehicle battery compartment and is used to interrupt electrical power to lift electrical system when a major short circuit occurs. If problems are present, contact a Volvo authorized workshop or, a Prevost service center, provider.



T8056323

Control System Circuit Breaker.

The control system circuit breaker is located on the PCB assembly, which is inside the electronic controller. The control system includes essentially all electrical components except the motor that drives the hydraulic pump

Vehicle Interlock System

The purpose of the vehicle interlock system is to prevent lift operation if it is unsafe to do so. Requirements are that the vehicle transmission be in neutral, the parking brake applied, and the passenger door be opened before power is supplied to the lift. Before the vehicle can depart, the lift must be stowed, and both the lift compartment door and passenger door must be closed.

Bridgeplate Load Sensor

A sensor switch is located in the hydraulic line connected to the bridgeplate hydraulic cylinder. When the sensor detects that an object is present on the bridgeplate it inhibits raising or lowering of the platform. This protects the passenger from possible injury when the cylinder raises the bridgeplate. It also protects the bridgeplate from damage, which could interfere later with proper operation of the lift.

16 Operating Instructions

Threshold Warning System

The threshold warning system is installed at the top of the doorway above the lift compartment. The module is powered on when the lift is powered, and the status indicator light then turns on. The acoustic sensors are enabled when the door is open and the lift-to-vehicle interlock system requirements are met.

Note: Installations provide a vehicle door closure signal to the module that will disable the sensors when the door is closed.

Acoustic sensors (transmitter and receiver) monitor the doorway threshold area for the presence of a passenger (or object, such as a wheelchair). If someone is detected in the threshold area when the platform is one inch, or more, below the floor an audible buzzer and flashing red light are actuated.

This system provides a margin of safety for lift passengers by warning them when the platform is below floor level. The platform must be at floor level when a passenger is boarding or exiting the platform.

Note: The buzzer and flashing light are disabled when the door is closed. In this case, the status indicator flashes when a passenger presence is detected.

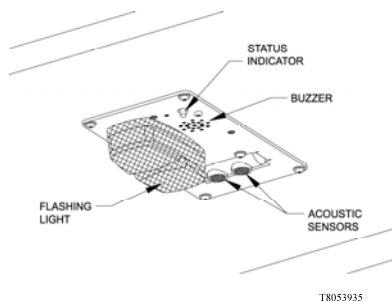

Lift Cycle Counter

The cycle counter (located near the electronic controller) is visible through a slot at the top center of the intermediate frame, just above the access panel. The platform must be fully stowed to view the counter. The counter advances each time the platform moves through a complete cycle, which consists of the platform moving from the vehicle floor to the ground and back to the floor. The number of cycles displayed is used to schedule maintenance operations.

18 Operating Instructions

Manual Backup Pump

The manual backup pump system can operate the lift if electrical power is not functional. The controls for the system consist of a pump handle (not removable) and pressure release valve, which are used in conjunction with four bypass knobs to extend, raise, lower, and retract the platform.

The four bypass knobs shown on the front face of the hydraulic controller are connected to four solenoid valves located inside the enclosure. The open or closed position of each solenoid valve determines how fluid is distributed to the five hydraulic cylinders. The knobs provide the ability open and close the valves manually.

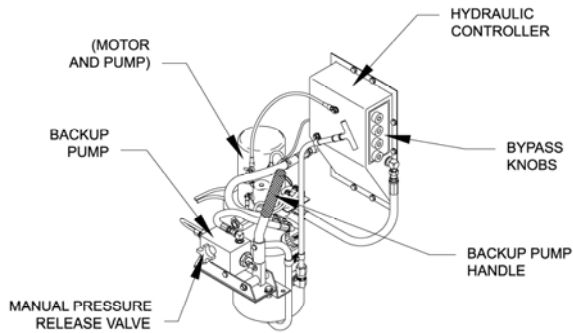

T8053954

Normal Lift Operation

- Before operating lift, be certain vehicle is safely parked on a level area away from traffic. Provide space for lift operation and passenger boarding.
- The lift operator must take special care to ensure that area is clear before deploying platform. Be certain there are no obstacles beneath platform.
- When parked adjacent to a curb, the vehicle must be within 26 inches of curb. Rear section of platform must overlap curb a minimum of eight inches.
- Engage the parking brake and turn on the vehicle.
- Turn on lift power switch located on dashboard.
- Open lift compartment door (lower) completely and secure.
- Pull handle located rear to release door lock, insert key in door lock and turn front to open.
- Open the upper door 90°.



T8055670

20 Operating Instructions

CAUTION

Before attempting to raise or lower the platform, verify the two maintenance safety pins are not inserted into intermediate frame and platform. Severe damage can occur if pins are inserted. The pins are normally stored on the side, as shown, and are for maintenance use only.

- Enable lift control pendant by turning on Power switch located on pendant.

Note: Attendant must remain near passenger to render immediate assistance when necessary.

Note: A person that uses the wheelchair lift while standing (does not require mobility aid equipment) is referred to in this manual as a Standee

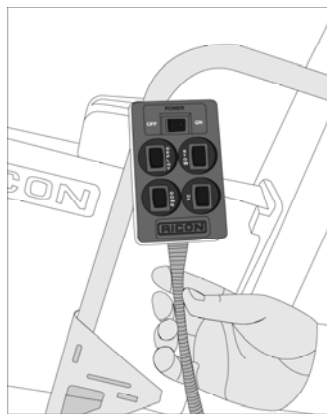

T8054862

Enter Vehicle

- Place the sliding seats in position (close to the next front seats) as follows:
 - 1 Move the seat cushion to up by pulling the lock located at side of seats.
 - 2 Release the safety locks by pulling the red levers.
 - 3 Move seats to front.
 - 4 Apply the safety locks to both seats.

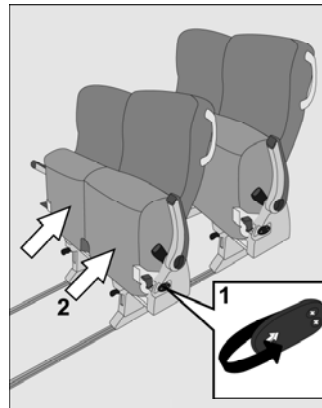

T8054860

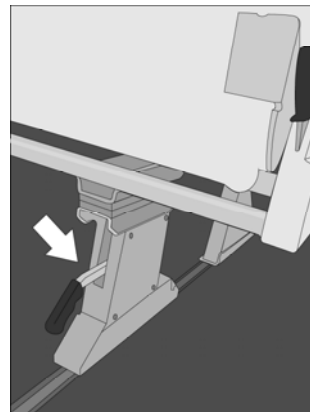

T8054869

22 Operating Instructions

Note: If any person is located under the sensor or near at door when the platform are in movement, an alarm and the red light will be activated.

CAUTION

The platform does not automatically stop when being lowered onto a curb, therefore the operator must monitor the height of the platform. Do not allow platform to tilt as shown in left panel. Use the UP button to adjust the platform height, if necessary. Also, do not lower front portion of platform onto curb as shown in right panel.

• **DEPLOY PLATFORM**

Press and hold DEPLOY button until platform is completely extended from lift compartment.

Note: Platform cannot be moved up or down unless platform is fully extended.

- Unlatch each handrail by pushing downward and then swinging outward by hand.
- Pull out on top edge of platform to release magnetic latch and lower platform sections to horizontal position; weight of platform is spring assisted.
- Unfold front platform section by grasping handle provided.
- Raise front rollstop to upright position and lock in place by allowing it to drop into the slots at rollstop pivot points.

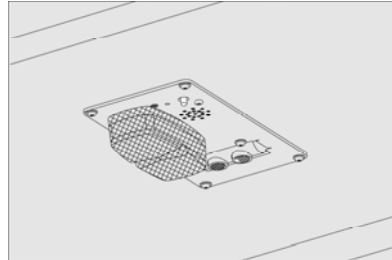

T8054868

- **LOWER PLATFORM**

Press and hold DOWN button until platform contacts ground. Verify that bridgeplate is in upright position.

- Lift front rollstop out of slots and swing forward until it rests on ground.
- Carefully place wheelchair brakes. Pull safety belt from retractor on handrail and fasten to other handrail.

Note: A standee must stand near the center of the platform, facing in the direction of travel (into vehicle), and firmly grasp handrails. Do not stand on bridgeplate.

- Raise front rollstop to upright position and lock in place by allowing it to drop into the slots at rollstop pivot points.

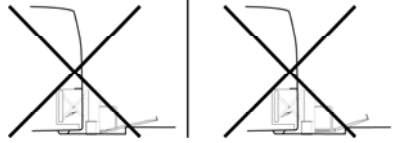

T8053936

24 Operating Instructions

- **RAISE PLATFORM**

Press and hold UP button until platform rises and stops automatically at vehicle floor level. Verify that bridgeplate lowers to horizontal position and rests flat on vehicle floor.

- Release wheelchair brakes, and carefully board passenger into vehicle.
- Place wheelchair in position, place brakes and secure with the hooks (located at lower zone from passenger's seats) placing at wheelchair frame.
- Always use the safety belt. Cross the belt from right side to left side and push it into the lock on the left side. After cross the upper belt and secure at lock from low belt.

Make sure an audible click is heard from the clasp in the lock and tug on the belt to verify it has locked.

Note: Lock could be stay at the aisle side.

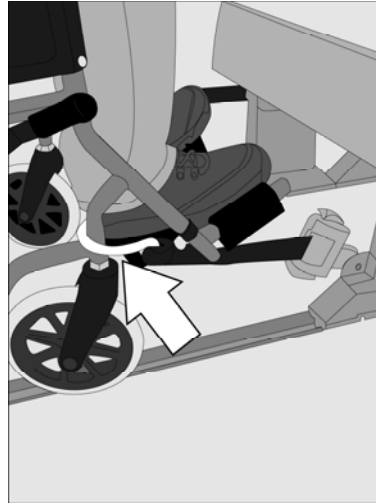

T8055403

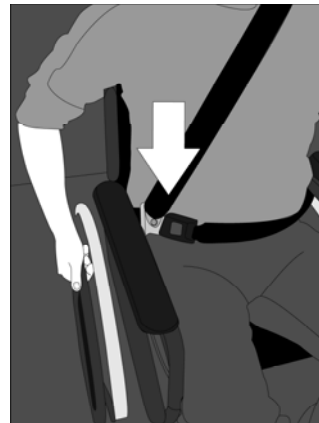

T8055400

Exit Vehicle

- To exit from vehicle, release:
 - 1 the safety belts
 - 2 the wheelchair from hooks
 - 3 brakes from wheelchair
- **DEPLOY PLATFORM**

Press and hold DEPLOY button until platform is completely extended from lift compartment.

Note: Platform cannot be moved up or down unless platform is fully extended.
- Unlatch each handrail by pushing downward and then swing outward by hand.
- Pull out on top edge of platform to release magnetic latch and lower platform sections to horizontal position; weight of platform is spring assisted.
- Unfold front platform section by grasping handle provided.
- Raise front rollstop to upright position and lock in place by allowing it to drop into the slots at rollstop pivot points.



CAUTION

Be certain wheelchair is safely within platform perimeter and does not interfere with operation of rollstop or bridgeplate.

- Carefully place wheelchair in center of platform, preferably facing outward (away from vehicle), and lock wheelchair brakes. Pull safety belt from retractor on handrail and fasten to other handrail.
- Note:** A standee must stand near the center of the platform, facing in the direction of travel (away from vehicle), and firmly grasp handrails. Do not stand on bridgeplate.

26 Operating Instructions

- **LOWER PLATFORM**

Press and hold DOWN button until platform settles at ground level. Verify that bridgeplates is in upright position before platform begins to lower.

Note: The platform does not automatically stop when being lowered onto a curb, therefore the operator must monitor the height of the platform. Do not allow platform to tilt as shown in left panel. Use the UP button to adjust the platform height, if necessary

- Lift front rollstop out of slots and swing forward until it rests on ground.
- Unfasten safety belt, release wheelchair brakes, and carefully assist passenger off platform.

Stow Platform

- Lift front rollstop out of slots and swing to rear until it rests on platform. Latch in place.
- Grasp handle on lower side of front platform section and fold section back onto rear platform section.
- Raise platform sections by hand until they engage magnetic platform latch; weight of platform is spring assisted.
- Swing handrails inward and then push downward and latch handrails into square holes in bottom edge of platform frame.
- Stow platform:
 - If platform is at floor level (or anywhere above stow level) press and hold **STOW** button until platform lowers to stow level and fully retracts into lift compartment.
 - If platform is at ground level (or anywhere above stow level) press and hold **UP** button until platform lowers to stow level and fully retracts into lift compartment.

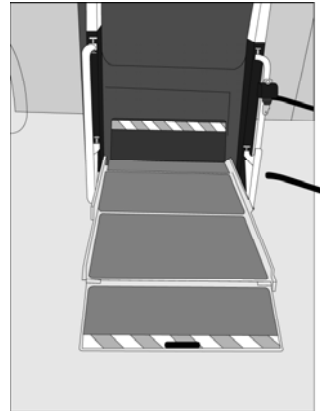

T3054866



CAUTION

Be certain platform has retracted completely. To prevent damage to lift compartment doors, do not release button until lift pump motor has stopped automatically.

28 Operating Instructions

- Turn control pendant power switch off and stow pendant on clip located on bottom of platform.

 **CAUTION**

The pendant must be attached to the clip located on the bottom of the platform when the platform is stowed. The pendant can be severely damaged by the lift compartment doors if left stored on either of the other clips.

- Close lift compartment doors releasing the locks.
- Turn off lift power switch located on dashboard.

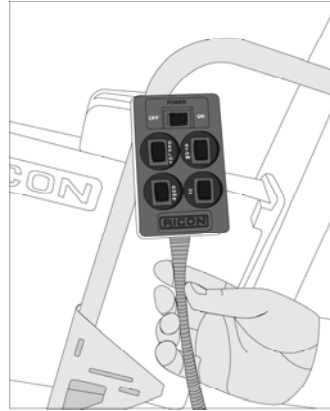

T8054862

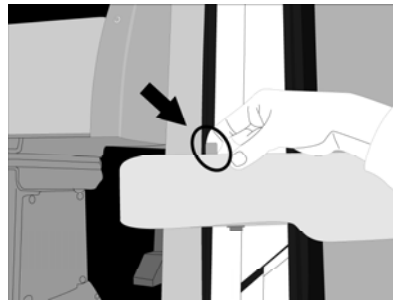

T8054864

Manual Lift Operation

The lift can be operated manually if lift electrical power is not functioning. Its recommend that manual operation be used only to exit from bus, not to enter bus.

Preparation:

- Be certain bus is on a level area and away from traffic. Allow space for platform movement plus space to exit from platform.
- The driver must summon assistance to move bus to a safe area if a break down situation exists where vehicle cannot be moved under its own power.
- Open storage compartment doors.
- The threshold warning system is not active during manual operation and cannot be used to indicate that the platform is at floor height.

The manual backup pump handle and manual pressure release valve are both referred to frequently in the following procedures. Moving its handle back and forth operates the backup pump. The release valve is closed by rotating it clockwise and opened by rotating it counterclockwise. The valve must be kept closed during normal operation.

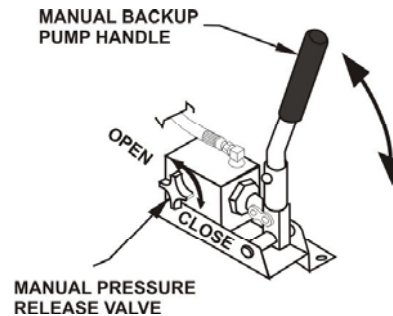

30 Operating Instructions

CAUTION

Open the pressure relief valve slowly and only far enough to result in a slow and steady movement of the platform. Avoid opening valve quickly because this will result in sudden and considerable platform movement.

The four bypass knobs shown are also referred to frequently in the following procedures. Push the destination knob inward and rotate to the setting directed in the procedure. Each knob must be in the normal position during normal operation.

CAUTION

Follow the procedure carefully. Do not open more than one valve at time.

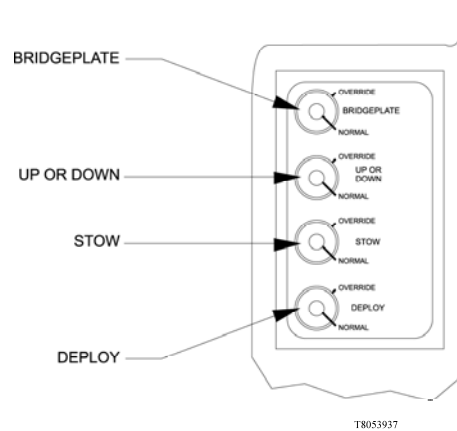

1 DEPLOY PLATFORM

- Verify that pressure release valve is closed.
- Rotate DEPLOY knob to override position.
- Operate hand pump until platform assembly is fully extended from lift compartment.
- Rotate DEPLOY knob to normal position.
- Swing both handrails outward by hand.
- Pull out on top edge of platform to release magnetic latch and lower platform sections to horizontal position; weight of platform is spring assisted.
- Unfold front platform section by grasping handle provided.
- Raise front rollstop to upright position and lock in place by allowing it to drop into the slots at rollstop pivot points.

32 Operating Instructions

2 RAISE PLATFORM

- Verify that pressure release valve is closed.
- Rotate the UP or DOWN knob to override position.
- Operate hand pump until platform rises to vehicle floor height.
- Rotate the UP or DOWN knob to normal position.
- Rotate BRIDGEPLATE knob to override position.
- Open pressure release valve and allow bridgeplate to lower to floor. Close valve.
- Rotate BRIDGEPLATE knob to normal position.
- Load passenger by carefully placing wheelchair in center of platform, preferably facing outward (away from vehicle), and lock wheelchair brakes. Pull safety belt from retractor on handrail and fasten to other handrail.

3 LOWER PLATFORM

- Verify that pressure release valve is closed.
- Rotate BRIDGEPLATE knob to override position.
- Operate hand pump until bridgeplate is in upright position.
- Rotate BRIDGEPLATE knob to normal position.
- Rotate UP or DOWN knob to override position.
- Open pressure release valve and allow platform to lower to ground level. Close valve.
- Rotate UP or DOWN knob to normal position.
- Unlock front rollstop and swing forward until it rests on ground.
- Unfasten safety belt, release wheelchair brakes, and carefully assist passenger off platform.

34 Operating Instructions

4 STOW PLATFORM

- Verify that pressure release valve is closed.
- Rotate the UP or DOWN knob to override position.
- Operate hand pump until top edge of platform frame is at same height as top edge of intermediate frame (stow level).
- Rotate the UP or DOWN knob to normal position.
- Lift front rollstop and swing to rear until it rests on platform. Latch in place.
- Grasp handle on lower side of front platform section and fold section back onto rear platform section.
- Raise platform sections by hand until they engage magnetic platform latch; weight of platform is spring assisted.
- Swing handrails inward and then push downward and latch handrails into square holes in bottom edge of platform frame.
- Rotate STOW knob to override position.
- Operate hand pump until platform assembly is fully retracted into lift compartment.
- Rotate STOW knob to normal position.

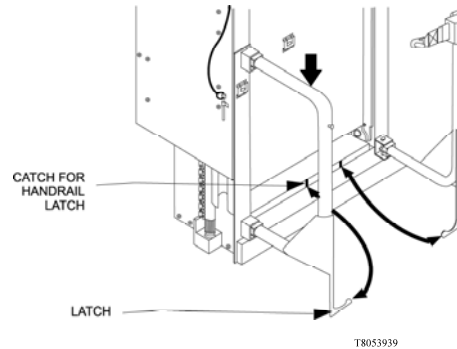

Cleaning

Regular cleaning with mild soap (i.e. liquid hand soap or car wash liquid) and drying thoroughly will protect the lifts painted surfaces. Cleaning is especially important in areas where roads are salted in winter. Make sure that lift pivot points are clean and dry prior to lubrication.

Maintenance Schedule

Refer to cycle counter located on rear side of hydraulic power unit. Under normal operating conditions, maintenance inspections are required at the frequencies listed in table. Ten cycles is considered a typical number of cycles for one days use.

36 Maintenance

MAINTENANCE SCHEDULE	
SERVICE POINT	ACTION TO PERFORM
10 CYCLES	
Overall condition	Listen for abnormal noises as lift operates (i.e. grinding or binding noises.)
Control Pendant	<ul style="list-style-type: none"> • Verify that control pendant is undamaged and cable connector is tight. • Verify that switch and buttons are illuminated.
Threshold warning system (TWS)	Verify that system reliably detects objects in doorway threshold area, when enabled, and actuates the visual and audible alarms.
Bridgeplate load sensor	Verify that sensor inhibits upward and downward movement of platform when a weight is present on the lowered bridgeplate.
150 CYCLES	
Electrical wiring	Inspect electrical wiring for frayed wires, loose connectors, etc.
Vehicle interlock	Place vehicle in non-interlock mode and verify that lift does not operate.
Decals	Verify that lift decals are properly affixed, clearly visible, and legible. Replace, if necessary.
Handrails	Verify that handrail fasteners are properly tightened, and that handrails can be latched securely in position.
Lift mounting points	<ul style="list-style-type: none"> • Verify that the vehicle mounting and support points are undamaged. • Verify that mounting bolts are sufficiently tight and free of corrosion.
	<div style="border: 1px solid black; padding: 5px;"> <p style="text-align: center;"> CAUTION</p> <p>Check and add fluid when platform is at ground level. Fluid that is added when platform is raised will overflow when platform is lowered.</p> </div>

Maintenance 37

Main lifting pivots	Verify that pins on scissor arms are properly installed, free from damage, and locked in position.
Platform pivot points	Verify that platform moves freely, without binding, and does not wobble.
Bridgeplate	<ul style="list-style-type: none"> • Verify that bridgeplate operates without binding during lift functions. • Verify that bridgeplate deploys fully when platform stops at floor level. • Verify bridgeplate rests flat against vehicle floor.
Front rollstop	Verify that rollstop pivots freely and can be latched securely in position.
Hydraulic power unit	<ul style="list-style-type: none"> • Verify that pump hydraulic fluid level is at FULL mark when platform is at ground level. Add Pentosin G002000 fluid. • Verify there are no hydraulic fluid leaks. • Verify that manual backup pump operates properly.
Cleaning and lubrication	<ol style="list-style-type: none"> 1 Clean lift with mild soap and water wipe dry. Prevent rust by coating all surfaces with a light oil. Remove excess oil. 2 Spray penetrating oil (Curtisol Red Grease 88167 or WD-40) . Remove excess grease from surrounding areas.
3600 CYCLES	
Hydraulic cylinders, hoses, and fittings	<ul style="list-style-type: none"> • Check hydraulic cylinders for evidence of leaks. • Inspect hydraulic hoses for damage. • Verify that all fittings are tight.

Index

B

Bridgeplate Load Sensor 15

C

Circuit Breakers 14
Control and Indicators 12
Control Pendant 13

D

Daily Safety Check 10

E

Enter Vehicle 21
Exit Vehicle 25

G

General Safety
Precautions 3

I

Introduction 1

L

Lift Cycle Counter 17

M

Maintenance 35

Major Lift Components 4
Manual Backup Pump 18
Manual Lift Operation 29

N

Normal Lift Operation 19

O

Operating Instructions 7

P

Platform Motions 11

S

Safety Information 5
Stow Platform 27

T

Threshold Warning
System 16

V

Vehicle Interlock System 14

VOLVO

Volvo Bus Corporation
Göteborg, Sweden

88997239 English 25.02.10

Operating Instructions

Tire Pressure Monitoring System

9700 Bus

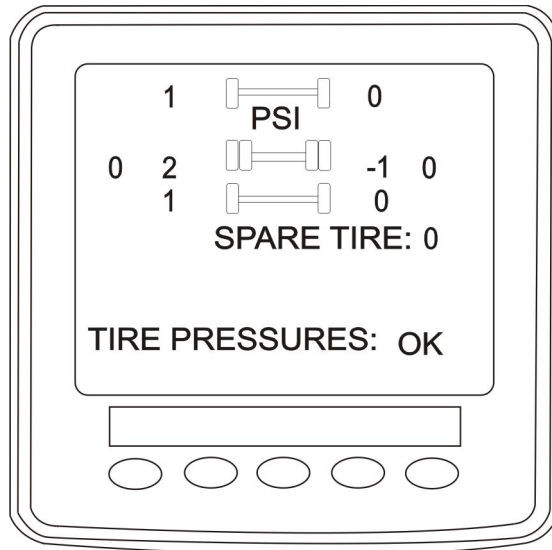

VOLVO

Foreword

This manual contains information concerning the operation and function of the Tire Pressure Monitoring System mounted on the 9700 US/CAN.

Illustrations in this manual are used for reference only and may differ slightly from the actual vehicle. However, key components addressed in this document are represented as accurately as possible.

The National Highway Traffic Safety Administration (NHTSA) and Prevost should be informed immediately if you believe that the vehicle has a defect that could cause a crash, injury or death.

Contact NHTSA by calling the Auto Safety Hotline at 1(888) 327-4236, by writing to NHTSA, U.S Department of Transportation, Washington, DC 20590, by TTY at 1 (800) 424-9153, or visit their web site at www.nhtsa.dot.gov.

Volvo Bus Corporation

Göteborg, Sweden

Order number: 88998506

©2010 Volvo Bus Corporation, Göteborg, Sweden

All rights reserved. No part of this publication may be reproduced, stored in retrieval system, or transmitted in any forms by any means, electronic, mechanical, photocopying, recording or otherwise, without the prior written permission of Volvo Bus Corporation

Contents

Introduction	1
Introduction	1
General Information	1
System Operation	2
TPMS Display	2
Operation	3
Start-up	3
Pre-Trip Check	4
Spare tire	7
Post Trip Operation	8
Index	11

Safety Information

IMPORTANT: Before driving this vehicle, be certain that you have read and that you fully understand each and every step of the driving and handling information in this manual. Be certain that you fully understand and follow all safety warnings.

It is important that the following information be read, understood and always followed.

The following types of advisories are used throughout this manual:

DANGER

Danger indicates an unsafe practice that could result in serious personal injury or death. A danger advisory banner is in **white** type on a black background with a **black** border.

WARNING

Warning indicates an unsafe practice that could result in personal injury. A warning advisory banner is in **black** type on a **gray** background with a **black** border.

CAUTION

Caution indicates an unsafe practice that could result in damage to the product. A caution advisory is in **black** type on a **white** background with a **black** border.

Note: Note indicates a procedure, practice, or condition that must be followed in order for the vehicle or component to function in the manner intended.

Introduction

This booklet is intended to help the driver about how to operate properly and take care of the Tire Pressure Monitoring System (TPMS).

General Information

Tire Pressure Monitoring System (TPMS) is a sensing device designed to identify and display tire operating data and activate an alert or warning when pressure or temperature irregularities are detected.

Note: It is the responsibility of the driver to react promptly and with discretion to alerts and warnings. Abnormal tire inflation pressures should be corrected at the earliest opportunity.

2 System Operation

TPMS Display

The TPMS display knows where the sensors are located. It receives the raw temperature and pressure readings from the TPMS receiver, it reads several signals from the vehicle and does the calculation required to generate the various screens.

When no readings have been received for a tire location or when the received data correspond to a parameter range defined as unavailable, then the reading is considered as not available and appears as two dash lines “ — ”

The TPMS display is initially configured for current bus 9700.

The TPMS display is also configured with several other parameters, including threshold levels for the alarms.

The TPMS display power supply turns OFF when the ignition key is switched OFF.

Operation

The system will monitor all vehicle tires plus the spare tire when a spare is supplied. And is configured for 8 tires total: two tires in front axle, 4 tires on drive axle and 2 tires on tag axle

Start-up

When turning the ignition switch to ON, two screen appears on the TPMS Display. Dash lines are displayed meaning that no pressure data have been received by the display..

As illustrated, the pressure readings will appear replacing the dash lines as the TPMS display starts to receive pressure data from the TPMS receiver. It can take 1 minute to get all pressure readings updated since the sensors transmit at a one minute interval.

The user can flip through the menus.

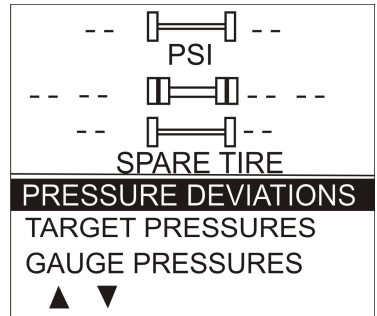

TS061960

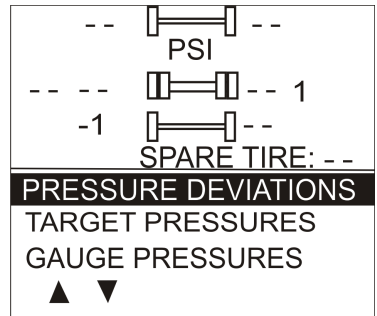

TS061961

4 System Operation

Pre-Trip Check

When one of the preconditions defined to start the pre-trip check is met, the TPM display enters into a pre-trip check routine and the screen shown below appears. The preconditions to initiate the pre-trip are: Park brake removed Or No activity on the display menu keys for a defined time (Key pressed timeout).

After a pretrip, the display is in a “drive” mode with bottom menu replaced by the alarm status. The display remains in this mode until one of the following occurs: A menu key is touched while the park brake is applied, or the park brake does a transition from released to park brake applied.

During the pre-trip check, the pressure readings for the different wheels become all available.

The pre-trip check ends, either when: the pressure readings have been received for all running wheels or the pre-trip check maximum time has elapsed. It was selected to provide sufficient time for all wheel sensors to wake-up and send a first reading.

The pre-trip check is aborted and the bottom menu reappears if the park brake was active and the user press one of the menu keys.

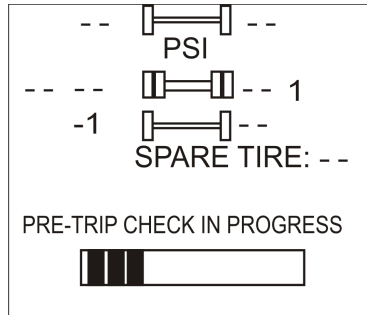

T8061962

Upon completion of the pre-trip check, the TPMS display will come up with one of the following screens:

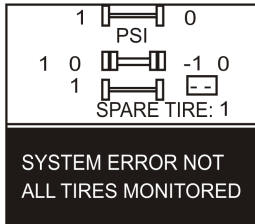
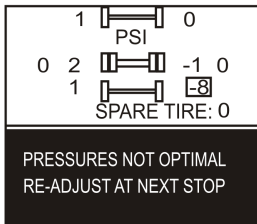
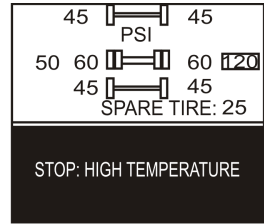
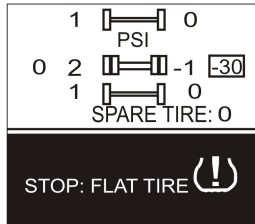
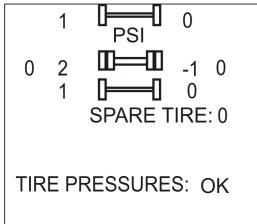

T8061963

A rectangle around each pressure/temperature reading of the tires that have an issue is blinking to draw the attention to the defective tires.

In the case of multiple errors at the same time, the highest priority error is displayed at the bottom. "Flat Tire" has the highest priority followed by "High Temperature", "Not all tires monitored" and "Tire pressure not Optimal".



DANGER

Continuing to operate the bus with a flat tire or a tire with excessively high temperatures may result in a blowout or tire fire. This could result in loss of vehicle control, vehicle crash and serious personal injury or death.

6 System Operation

To get the driver's attention to the alarms, the bottom section of the screen where the alarm message appears will blink to reverse contrast at the following rate: 0.5 sec normal contrast, 0.5 sec reverse contrast. Pressing any key will acknowledge the alarms that are considered as non critical and stop the blinking of these alarms message for the remaining of the trip. The non critical alarms are: "Pressure not optimal" and "Not all tires monitored". The "flat tires" and "high temperature" alarms are critical and will keep blinking even when a key is pressed. If a different alarm occurs, blinking will start again. The blinking rectangle around the pressure/temperature readings is not impacted by the acknowledgement and keeps blinking until the error condition disappears.

The spare tire does not contribute to alarms and so never blinks.

On the road, the TPMS display shows one of the 5 previous screens.

In the event of a temperature alarm, the display switches automatically to temperature readings.

The driver can also press any of the menu keys to momentary switch the display to temperature readings. In this case, the temperature reading appears for 15 seconds and the display returns to pressure.

The switching to temperature by pressing a key does not take place if there is an acknowledgeable alarm active, since in this case pressing the key does acknowledge the alarm.

The switching to temperature does not take place either if there is an alarm of Temperature or Flat Tire.

The switching to temperature works when the bottom message indicates either: Tire Pressure OK, Pressure Not Optimal non flashing or not all tires monitored non flashing. When the switch is done to temperature readings, the bottom portion of the screen is not affected and still shows the status message.

Note: High temperature is not likely to occur during the pre-trip.

The pressure and temperature readings are continuously updated with the displayed readings of the wheel having issues blinking. The bottom line message is automatically updated to the highest priority alarm prevailing. There is a hysteresis on the alarm levels to assure that the error conditions do not flicker ON and OFF.

On the occurrence of an alarm, a beep will sound. The alarm beep could be turned OFF in the alarm settings menu.

Spare tire

The spare tire is monitored but it is not taken into account when setting the bottom alarm messages. This is to prevent unnecessary alarms that would otherwise occur, if for example, the spare tire is removed from a vehicle.

The user will have the possibility to check the pressure of the spare tire by accessing the TPMS display menu. For vehicles that have no spare tires, the title “spare tire:“ will still appear on the screens but the pressure will remain with two dash lines at all time.

After the manual activation switch has been activated, the fire “ALARM” lamp blinks and the audio alarm activates. The lamp will remain blinking until power is cycled to the system. until power has been cycled to the system.

8 System Operation

Post Trip Operation

When parking the vehicle (park brake applied), the TPMS display keep the drive mode display active. The driver can press any keys to get the bottom lines showing the status information replaced with the menus.

The pressure readings are still displayed and updated as new readings are received and the readings are blinking if not within the optimum pressure range.

From this point the user can scroll through the menus to get more detailed information and inflate/deflate the tires to bring them back to their optimum target pressures. Scrolling through these menus is also available prior to departure.

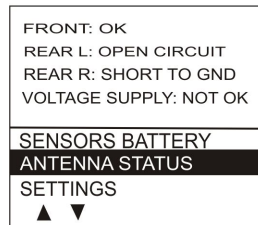
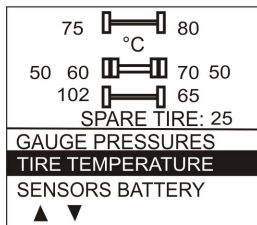
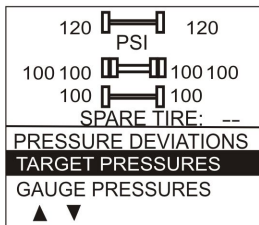
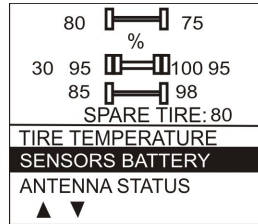
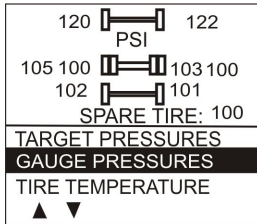
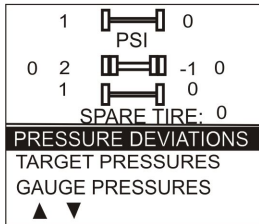

The display remains in this mode with the menus appearing at the bottom until the pre-trip check sequence starts again.

Scrolling down below the Battery life menu will show the Settings menu. Highlighting the Settings and pressing OK allows entering the settings menu.

Highlighting the Exit menu and pressing OK exits the settings and come back to the pressure display mode.

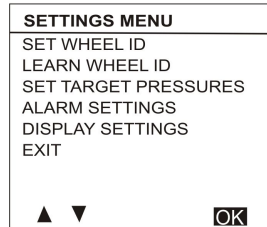
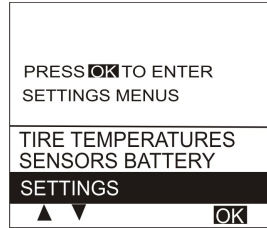

Index

G

General Information 1

I

Introduction 1

O

Operation 3

P

Post Trip Operation 8

Pre-Trip Check..... 4

S

Safety Information 5

Spare tire 7

Start-up 3

System Operation 2

T

TPMS Display 2

VOLVO

Volvo Bus Corporation

Göteborg, Sweden

Driver's Handbook

A/C Controller

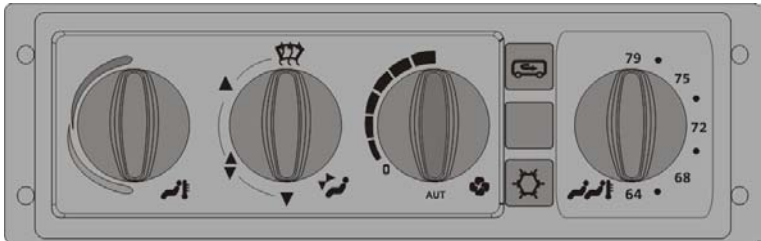

T8061140

VOLVO

Foreword

This manual contains information concerning the operation and function A/C controls. The information in this manual applies to vehicles built January 2010 and later. Please keep this manual in the vehicle at all times.

Note: Illustrations in this manual are used for reference only and may differ slightly from the actual vehicle. However, key components addressed in this document are represented as accurately as possible.

Volvo Bus Corporation

Göteborg, Sweden

Order number: 88999203

©2009 Volvo Bus Corporation, Göteborg, Sweden

All rights reserved. No part of this publication may be reproduced, stored in retrieval system, or transmitted in any forms by any means, electronic, mechanical, photocopying, recording or otherwise, without the prior written permission of Volvo Bus Corporation

Contents

.....	1
Introduction.....	1
General View.....	1
Controller Functions.....	2

Safety Information

IMPORTANT: Before driving this vehicle, be certain that you have read and that you fully understand each and every step of the driving and handling information in this manual. Be certain that you fully understand and follow all safety warnings.

IT IS IMPORTANT THAT THE FOLLOWING INFORMATION BE READ, UNDERSTOOD AND ALWAYS FOLLOWED.

The following types of advisories are used throughout this manual:



DANGER

Danger indicates an unsafe practice that could result in serious personal injury or death. A danger advisory banner is in **white** type on a **black** background with a **black** border.



WARNING

Warning indicates an unsafe practice that could result in personal injury. A warning advisory banner is in **black** type on a **gray** background with a **black** border.



CAUTION

Caution indicates an unsafe practice that could result in damage to the product. A caution advisory is in **black** type on a **white** background with a **black** border.

Note: Note indicates a procedure, practice, or condition that must be followed in order for the vehicle or component to function in the manner intended.

Introduction

This booklet is intended to help the driver about how to operate properly and take care of the A/C controller.

The A/C controller allows control of the temperature inside the bus as well as, control of additional equipment (such as the recirculation air damper and air conditioning).

General View

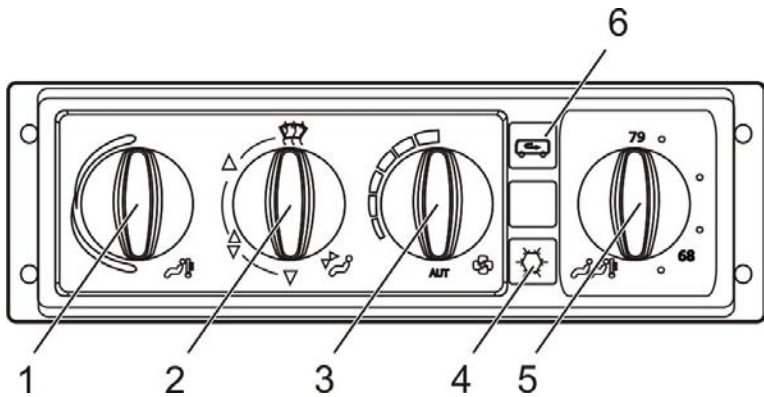

T8062094

- | | | | |
|---|--|---|--------------------------------------|
| 1 | Temperature, driver's compartment. | 4 | Air conditioning. |
| 2 | Direction of air flow, driver's compartment. | 5 | Temperature, passengers' compartment |
| 3 | Defroster fan speed. | 6 | Fresh Air/ Recirculation |

Controller Functions

- 1 Sets desired temperature in driver's compartment to a value between 64°F (18°C) and 79°F (26°C).
- 2 Sets the direction of the air flow into the driver's compartment.
 - A) to the windscreen (defroster mode)
 - B) to the windscreen
 - C) to the driver and floor
 - D) to the floor.

Note: While the defroster mode is active, warm air is blown, no matter position of knob 1.

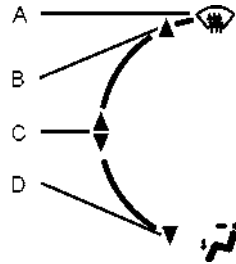

- 3 Sets the desired fan speed

Note: In "AUT" position the fan speed is controlled automatically.



-
- 4 Switches on the air conditioning. A backlit button indicates the air conditioning is on.



T3028692

- 5 Sets the desired temperature in the passengers' compartment to a value between 64°F (18°C) and 79°F (26°C).

- 6 Switches on the recirculation. A backlit button indicates the recirculation is switched on.



T3028690

VOLVO

Volvo Bus Corporation

Göteborg, Sweden

Operating Instructions

Safety seat belts

9700 Bus



VOLVO

Foreword

This manual contains information concerning the operation and function of the safety seat belts mounted on the 9700 US/CAN.

Illustrations in this manual are used for reference only and may differ slightly from the actual vehicle. However, key components addressed in this document are represented as accurately as possible.

The National Highway Traffic Safety Administration (NHTSA) and Prevost should be informed immediately if you believe that the vehicle has a defect that could cause a crash, injury or death.

Contact NHTSA by calling the Auto Safety Hotline at 1(888) 327-4236, by writing to NHTSA, U.S Department of Transportation, Washington, DC 20590, by TTY at 1 (800) 424-9153, or visit their web site at www.nhtsa.dot.gov.

Volvo Bus Corporation

Göteborg, Sweden

Order number: 89008115

©2011 Volvo Bus Corporation, Göteborg, Sweden

All rights reserved. No part of this publication may be reproduced, stored in retrieval system, or transmitted in any forms by any means, electronic, mechanical, photocopying, recording or otherwise, without the prior written permission of Volvo Bus Corporation

Contents

Introduction	1
Introduction.....	1
Seat belts	2
Safety seat belt	2
Operating two points safety belt.....	3
Operating three points safety belt	5
Maintenance	6
Inspection	6
Important Facts About Safety Belts in Buses.....	10
Index	11

Safety Information

IMPORTANT: Before driving this vehicle, be certain that you have read and that you fully understand each and every step of the driving and handling information in this manual. Be certain that you fully understand and follow all safety warnings.

It is important that the following information be read, understood and always followed.

The following types of advisories are used throughout this manual:

DANGER

Danger indicates an unsafe practice that could result in serious personal injury or death. A danger advisory banner is in **white** type on a black background with a **black** border.

WARNING

Warning indicates an unsafe practice that could result in personal injury. A warning advisory banner is in **black** type on a **gray** background with a **black** border.

CAUTION

Caution indicates an unsafe practice that could result in damage to the product. A caution advisory is in **black** type on a **white** background with a **black** border.

Note: Note indicates a procedure, practice, or condition that must be followed in order for the vehicle or component to function in the manner intended.

Introduction

This booklet is intended to help the driver about how to operate properly and take care of the safety seat belts.

Safety belts assemblies installed in this vehicle meet FMVSS 209, type 1 and type 2. They are recommended for all persons weighing over 50 lb (25 kg).

A child restrain system should also be provided for each child weighing 50 lb (25 kg) or less. It should meet the requirements of “FMVSS213 Child Restraint System”. Carefully read and follow all manufacture’s instructions on installation and use. Make certain the child remains in the restraint system at all times while the vehicle is in motion.

DANGER

Safety belts must be properly worn at all times by the driver and all passengers while the vehicle is in motion. Failure to do so can result in serious personal injury or death in the event of sudden stop or collision.

DANGER

Fasten the safety belt before starting to drive. Trying to fasten the safety belt while the vehicle is moving may lead to an accident, causing serious personal injury or death.

2 Seat belts

Safety seat belt

Using the seat belts is the single most important thing that can be done for protection in the event of a crash.

Safety belts must be properly worn at all times. Before adjusting or fastening the safety belt, move the seat forward or rearward and adjust the seat height as necessary. Sit erect and adjust the seat cushion and seat back for a comfortable driving position. In the event of a collision, a correct driving position maximizes the effectiveness of the safety belt. There are both Federal and State laws governing the use of safety belts. As laws differ from state to state, make yourself familiar with the current rules.

Tether straps are installed on all suspension-type seats. Tether straps help secure the seat to the floor and are intended to restrain the seat and safety belt in case of an accident or sudden stop. The tether straps are not adjustable and do not need any adjustment.

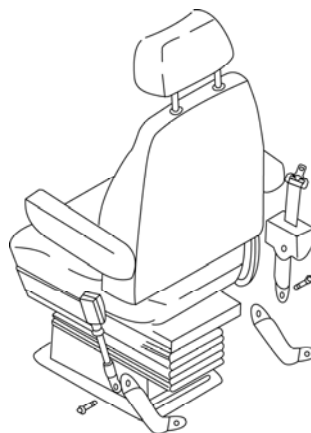

T8014323

Operating two points safety belt

You should properly adjust your seat first before fastening the seat belt. To fasten the safety belt, pull the belt out from the retractor and insert the latch into the buckle. Verify proper lock of the latch by pulling on the latch.

The buckle will click when the latch is engaged. *Always confirm that the latch is engaged by tugging on the belt at the latch.*

After confirming the latch is engaged, adjust the lap belt cross the hips below the stomach. When properly adjusted the lap belt should be snug against the body.

The lap portion of the safety belt should be worn low across the pelvic region (hip bone) and adjusted snugly. A push button on the buckle is used to release the safety latch by pushing in the button release on the buckle.



T8056398

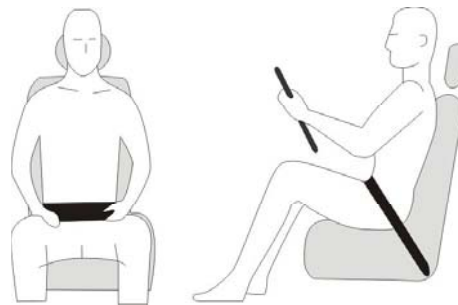

T8056402



DANGER

Never adjust the lap belt across the abdomen.

4 Seat belts

The buckle portion of the safety belt system is different depending on the seat option chosen. The national standard and comfort seat has separate buckle that is attached to a floor anchor by seat strap. This seat strap is not adjustable, and does not need to be adjusted.

The buckle will click when the latch is engaged. *Always confirm that the latch is engaged by tugging on the belt at the latch.*

After confirming the latch is engaged, adjust the belt so that the belt should be snug against the body.

The buckle for the seat is bolted to the front division wall.

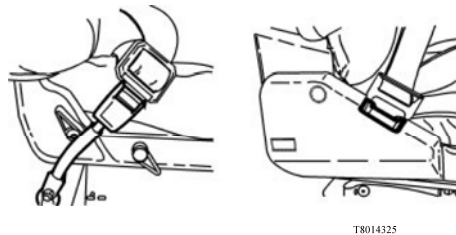

Operating three points safety belt

You should properly adjust your seat first before fastening the sea belt. To fasten the seat belt, pull de belt out from the retractor and insert the latch into the buckle.

Adjust the slack by pulling on the top part of the belt until the lower part, or the part that crosses the lap, is snugly adjusted. Release the top part and let the retractor pull the belt in.

One lap portion of the safety belt should be worn low across the pelvic region (hip bone) and adjusted snugly. The other part of the safety belt should be worn over the shoulder and cross the chest, away from the neck.



T8056398

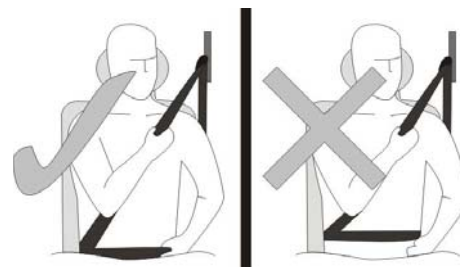

T8056401



DANGER

Never adjust the lap belt across the abdomen.



DANGER

Never place the shoulder belt behind your back or under your arm.

A push button on the buckle is used to release the safety latch.

6 Maintenance

Inspection

Check the belts, buckles, latch plates, retractors, anchorages, and guide loops to ensure that they are working properly. Look for loose/damage parts (without disassembling) that could keep the restraint system from working properly. If the safety belt, retractor and hardware were in use during a collision, they must be replaced. The restraint system anchorage fasteners must be replaced if necessary. If there is any doubt about the restraint system's effectiveness, replace the entire safety belt assembly.

 **DANGER**

Failure to properly inspect and maintain the safety belts can cause serious personal injury or death

 **DANGER**

It is critical that any time a vehicle has been involved in an accident, the entire safety belt system must be replaced in the vehicle if they were in use at the time of the accident. Failure to replace the safety belt system may result in serious injury or death

 **DANGER**

A damaged safety belt, whether visibly damaged or not, could result in serious personal injury in the event of an accident. The safety belt systems should be replaced at least every five years.

 **DANGER**

Do not bleach or re/dye the color webbing because it may cause a severe loss of belt strength. This loss of strength could allow the safety belt to break under stress, thus resulting in severe personal injury or death.

Maintenance 7

The following maintenance guidelines detail how to inspect safety belts and tethers for cuts, fraying, extreme or unusual wear of the webbing, etc., and damage of the buckle, retractor, hardware or other factors which indicate that the safety belt system replacement is necessary. Check the web wear at the buckle/latch area. The webbing must be closely examined to determine if there are any cuts, fraying or extreme wear in the webbing. Cuts, fraying or excessive wear would indicate the need for replacement of the safety belt system.

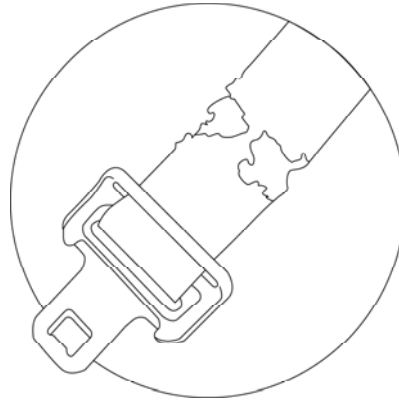

T8014326

Check the buckle by inserting the latch and verifying proper operation. Determine if the latch plate is worn or deformed. Check the buckle and latch casing for cracks or breakage



T8014327

8 Maintenance

For driver, the retractor web storage device is mounted on the B-pillar, just behind the Driver's window for 3 points seat belt, and for 2 points seat belt the retractor is mounted on the right side of the driver seat. The retractor is the heart of the safety belt system and can be damaged if abused, even unintentionally. Check the retractor web storage device operation to ensure that it is not locked and that it spools out and retracts the webbing properly.



T8065899

For passengers, the retractor web storage device is mounted into the backseat. The retractor is the heart of the safety belt system and can be damaged if abused, even unintentionally. Check the retractor web storage device operation to ensure that it is not locked and that it spools out and retracts the webbing properly.

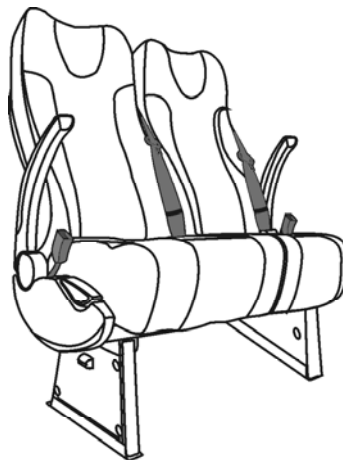

T8065952

Maintenance 9

If the tethers are being used to anchor the safety belts to the floor, make sure that they are properly attached to the seat. Tethers must also be inspected for web wear and proper tightness of mounting hardware.

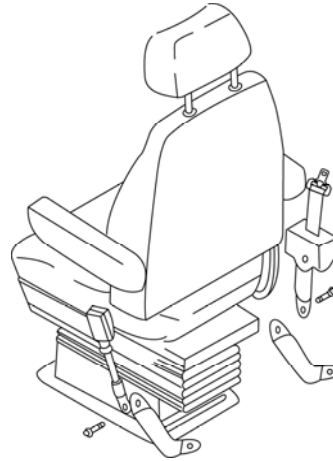

T8014323

All hardware for safety belt mounting points should be evaluated for corrosion. All attachment points of the system should be checked for tightness of mounting hardware.

Check the web in areas exposed to ultra-violet rays from the sun or extreme dust or dirt. If the original color of the web in these areas is extremely faded, the physical strength of this web may be deteriorated. If this condition exists, replace the safety belt system.

10 Maintenance

Important Facts About Safety Belts in Buses

The high mileage associated with buses and the potential exposure of this safety belt to severe environmental conditions make it crucial to inspect the seat belt system regularly. It is recommended that the system be inspected every 15,000 miles (24, 000 km) or more often if the vehicle is exposed to severe environmental or vocational conditions. Any safety belt system that shows cuts, fraying, extreme or unusual wear, significant discolorations due to ultra-violet ray exposure, dusty-dirty conditions, abrasion to the safety belt webbing or damage to the buckle, latch plate, retractor, hardware or any other obvious problem should be replaced immediately, regardless of the mileage.

Once replacement of the safety belt has been determined necessary, be certain that is replaced only with a Volvo original replacement safety belt. See your authorized Volvo or for Prevost supported vehicles, in Prevost service center/provider for replacement. Replace it only with the exact same design that the vehicle was equipped with. If the inspection indicates that any other part of the safety belt system requires replacement, the entire belt system must be replaced. It is vitally important that all components are mounted back in the same positions as the original components that were removed. This will maintain the design integrity of the mounting points for the safety belt assembly.

Index

I

Inspection6
Introduction 1

M

Maintenance.....6

O

Operating three points safety
belt5

Operating two points safety
belt3

S

Safety Information 5
Safety seat belt2
Seat belts.....2

VOLVO

Volvo Bus Corporation
Göteborg, Sweden

89008115 English 02.02.11

Driver's Handbook

Driver's seat

B13R

VOLVO

Foreword

This manual contains information concerning the operation and function of the driver's seat. The information in this manual applies to vehicles built January 2009 and later. Please keep this manual in the vehicle at all times.

Note: Illustrations in this manual are used for reference only and may differ slightly from the actual vehicle. However, key components addressed in this document are represented as accurately as possible.

The National Highway Traffic Safety Administration (NHTSA) and Volvo Trucks North America should be informed immediately if you believe that the vehicle has a defect that could cause a crash, injury or death.

Contact NHTSA by calling the Auto Safety Hotline at 1 (888) 327-4236, by writing to NHTSA, U.S. Department of Transportation, Washington, DC 20590, by TTY at 1 (800) 424-9153, or visit their website at www.nhtsa.dot.gov.

Volvo Bus Corporation

Göteborg, Sweden

Order number: 89008116

©2009 Volvo Bus Corporation, Göteborg, Sweden

All rights reserved. No part of this publication may be reproduced, stored in retrieval system, or transmitted in any forms by any means, electronic, mechanical, photocopying, recording or otherwise, without the prior written permission of Volvo Bus Corporation

Contents

Introduction	1
Important Notes.....	1
Adjusting the Seat Settings	2
Raising and Lowering the Seat	2
Adjusting the Cushion's, Rear Section.....	2
Setting the Distance from the Steering Wheel.....	3
Adjusting the Seat Backrest Position.....	3
Adjusting the Armrests.....	4
Adjusting the Lumbar Backrest	4
Safety Belt	5

Safety Information

IMPORTANT: Before driving this vehicle, be certain that you have read and that you fully understand each and every step of the driving and handling information in this manual. Be certain that you fully understand and follow all safety warnings.

IT IS IMPORTANT THAT THE FOLLOWING INFORMATION BE READ, UNDERSTOOD AND ALWAYS FOLLOWED.

The following types of advisories are used throughout this manual:



DANGER

Danger indicates an unsafe practice that could result in serious personal injury or death. A danger advisory banner is in **white** type on a **black** background with a **black** border.



WARNING

Warning indicates an unsafe practice that could result in personal injury. A warning advisory banner is in **black** type on a **gray** background with a **black** border.



CAUTION

Caution indicates an unsafe practice that could result in damage to the product. A caution advisory is in **black** type on a **white** background with a **black** border.

Note: Note indicates a procedure, practice, or condition that must be followed in order for the vehicle or component to function in the manner intended.

Important Notes

Do not use the seat before you have read these instructions on how to use it. Keep this manual in the vehicle at all times. With road traffic and passengers safety in mind, only perform adjustments to the seat when the bus is at a standstill.

2 Adjusting the Seat Settings

The National 60848 seat is designed with a wide range of adjustment options. The seat controls for adjusting the seat may be located on the left or right-hand side of the seat.

Raising and Lowering the Seat

To make getting up, down or getting out from the drivers position easier the seat has a quick-lowering function. If control **(1)** is pressed downwards, the seat lowers making it easier to get up, down and out of the drivers position. If control **(1)** is pressed upwards, the seat rises to the drivers preferred position.

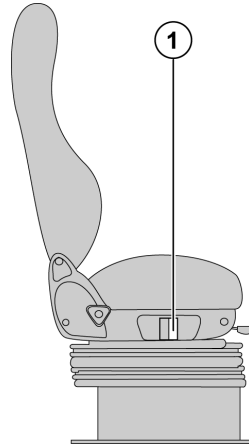

T0015365

Adjusting the Cushion's, Rear Section

If the knob **(2)** is turned in either direction, the cushion's rear section raises up or moves down.

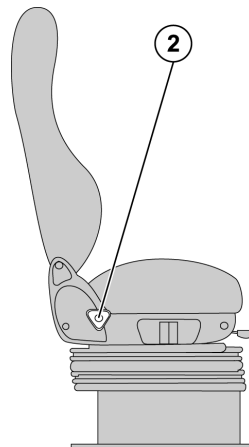

T0015366

Setting the Distance from the Steering Wheel

To move the whole seat forward or backward, push the lever (3) to the left then move the seat up to the desire position and release the lever to lock the seat again.

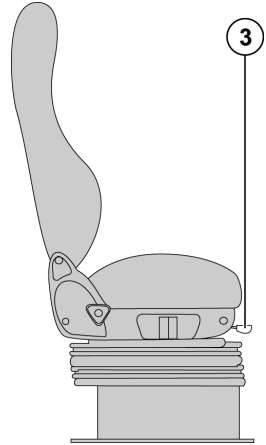

T0015367

Adjusting the Seat Backrest Position

Twist the knob (4) counterclockwise to move the backrest forward or turn the knob clockwise to move the backrest backward.

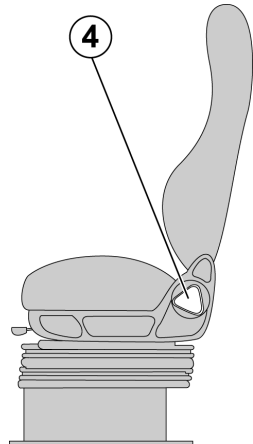

T0015368

4 Adjusting the Seat Settings

Adjusting the Armrests

The seat has two armrests, one attached on either sides. To make sitting down or getting up easier, the armrest can be tilted fully vertical. The armrests have an adjust range from 15° to 45°. To adjust the armrest angle, pull it up to the top position then down to its bottom position. From the down position, lift the armrest up to the desire position.

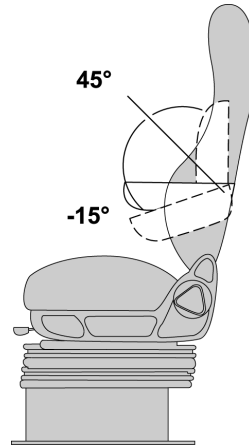

T0015369

Adjusting the Lumbar Backrest

By pulling the control (5) upward, the lumbar pressure increases while pushing down decreases pressure. When the control is released, the lumbar backrest is set.

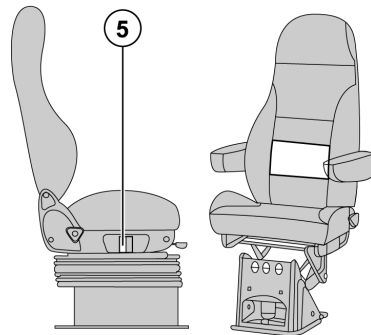

T0015370

Safety Belt

For security, always use the safety belt.

Two points safety belt

Cross the belt from the right (7) side to the left side (6) and insert the latch into the buckle on the left side an audible click is heard, verify proper lock of the latch by pulling on the latch. Safety belt should be worn low across the pelvic region (hip bone) and adjusted snugly.

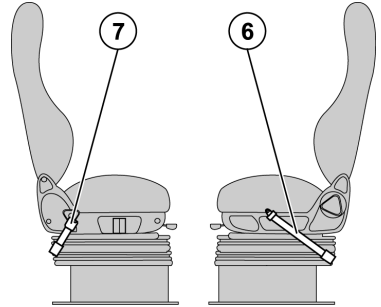

T0015371



DANGER

Never place the shoulder belt behind your back or under your arm.

A push button on the buckle is used to release the safety latch, by pushing in the button release the on the buckle

6 Adjusting the Seat Settings

Three point safety belt

To fasten the safety belt, pull the belt out from the retractor (6) and insert the latch into the buckle (7) an audible click is heard, verify proper lock of the latch by pulling on the latch. Adjust the slack by pulling on the top part of the belt until the lower part that crosses the lap, is snugly adjusted, release the top part and let the retractor pull the belt in. One lap portion of the safety belt should be worn low across the pelvic region (hip bone) and adjusted snugly, the other part of the safety belt should be worn over the shoulder and cross the chest, away from the neck.

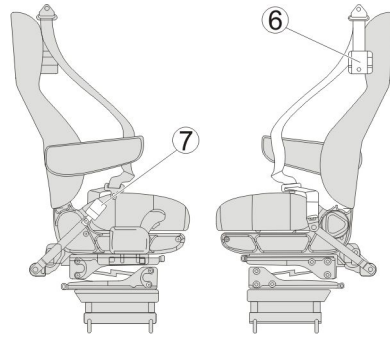

T0064067

DANGER

Never place the shoulder belt behind your back or under your arm.

A push button on the buckle is used to release the safety latch, by pushing in the button release the on the buckle

VOLVO

Volvo Bus Corporation

Göteborg, Sweden

Driver's Handbook

Prevost Liaison 2.0 Communication System

H3, X3

PREVOST
LIAISON 

VOLVO

Foreword

This manual contains information concerning the operation and function of the Telematics System. The information in this manual applies to vehicles built January 2012 and later. Please keep this manual in the vehicle at all times.

Note: Illustrations in this manual are used for reference only and may differ slightly from the actual vehicle. However, key components addressed in this document are represented as accurately as possible.

Volvo Bus Corporation

Göteborg, Sweden

Order number: 89038570

©2011 Volvo Bus Corporation, Göteborg, Sweden

All rights reserved. No part of this publication may be reproduced, stored in retrieval system, or transmitted in any forms by any means, electronic, mechanical, photocopying, recording or otherwise, without the prior written permission of Volvo Bus Corporation

Contents

General Information.....	1
System Information.....	1
Switch Control Buttons.....	2
Using the Display.....	3
Read Message	4
Send Message.....	6
Other Info.....	11
Compass Gauge	13
Location	13
Directional Arrow	13

Safety Information

IMPORTANT: Before driving this vehicle, be certain that you have read and that you fully understand each and every step of the driving and handling information in this manual. Be certain that you fully understand and follow all safety warnings.

IT IS IMPORTANT THAT THE FOLLOWING INFORMATION BE READ, UNDERSTOOD AND ALWAYS FOLLOWED.

The following types of advisories are used throughout this manual:



DANGER

Danger indicates an unsafe practice that could result in serious personal injury or death. A danger advisory banner is in **white** type on a **black** background with a **black** border.



WARNING

Warning indicates an unsafe practice that could result in personal injury. A warning advisory banner is in **black** type on a **gray** background with a **black** border.



CAUTION

Caution indicates an unsafe practice that could result in damage to the product. A caution advisory is in **black** type on a **white** background with a **black** border.

Note: Note indicates a procedure, practice, or condition that must be followed in order for the vehicle or component to function in the manner intended.

System Information

The Telematics System is a cell phone GSM communication and GPS communication from GPS satellites to the vehicle. It includes a GPS communication ECU, a combined GPS/GSM antenna and wiring harnesses. This system allows communication between web-based software on the Customer Portal and the vehicle. The driver can send and receive short text messages, which are visible through the Driver Information Display (DID) in the vehicle instrument cluster. The fleet operator can communicate with the driver through web-based software on the Customer Portal. The Telematics System also provides GPS data in the DID Gauges menu. This data indicates the location and direction the vehicle is travelling to the driver and fleet operator.

2 General Information

Switch Control Buttons

The controls for the Driver Information Display (DID) in the instrument cluster are two buttons on the left hand side of the steering wheel..

Upper one

- **ENTER** Selects message.
- **ESCAPE** Takes you back to previous menu .

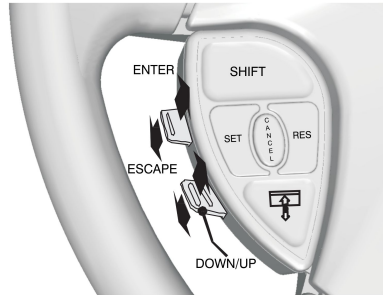

W3071911

Lower one

- **UP** Arrow scrolls up through menus, text, messages or alphabet.
- **DOWN** Arrow scrolls down through menus, text, messages or alphabet.

Using the Display

- 1 The Telematics System is seen as Prevost Liaison in system menu in the DID. Press **ESCAPE** to display the main menus in the DID.
- 2 Use the up and down button on the left hand side of steering wheel switch to scroll to the Prevost Liaison menu.
- 3 Press **ENTER** to select the Prevost Liaison menu.
- 4 After selecting Prevost Liaison, another screen pops up, offering the choice to read messages, send messages, or view other information.
- 5 For instructions on reading and sending messages, or other information, refer to:
 - “Read Message”, page 4
 - “Send Message”, page 6
 - “Other Info”, page 11

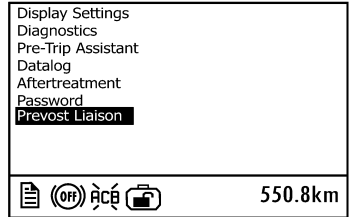

W3071907

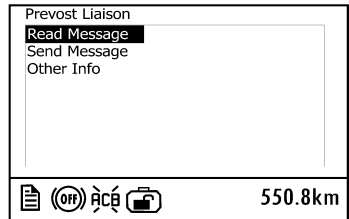

W3071908

The following menus are available:

- 1 Read message
 - Quick Response (Only available if there is a message available.)
- 2 Send message
 - Driver & Equipment
 - Dispatch Messages
 - Free Text
- 3 Other Info
 - Comm Link Info
 - Mailbox Info
 - GPS Info
 - INI Info
 - Configuration Info

4 General Information

Read Message

Incoming Message Notification

The fleet operator can send messages to the driver. When a message is received by the Telematics ECU, the driver is notified by the INFO lamp in the instrument cluster :



W3005150

and a message in the DID. One of the following two messages will appear:

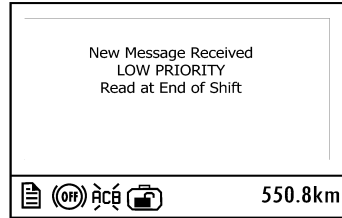

W3071909

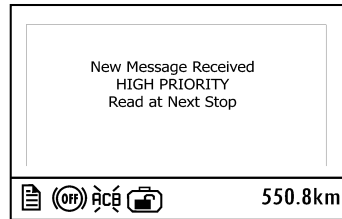

W3071910

Press **ESCAPE** on the left hand side of steering wheel switch when the message

appears to turn off the INFO lamp and message.

Viewing Messages

To view all stored messages, select Prevost Liaison, then **Read message** in the DID.

Note: Messages **can be sent (or read)** only when the vehicle is stopped.



W3072069

*2 indicates there are two unread messages in the queue.

When there are no stored messages, the following screen is displayed.

This will be seen once in life of vehicle.

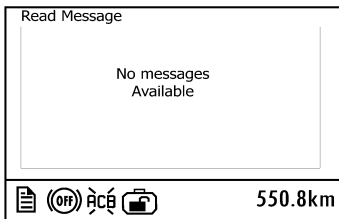

W3072070



WARNING

For safety reasons do not attempt to use the messaging feature if the vehicle is not parked, failure to do so could result in personal injury or vehicle damage.

6 General Information

Send Message

Sending Messages from the Vehicle

The driver can send messages to the fleet operator. Messages **can be sent (or read)** only when the vehicle is stopped .

The driver can send three types of messages: Driver & Equipment, Dispatch Messages, and Free text. Scroll to **Send message** in the Prevost Liaison menu and press **ENTER**.

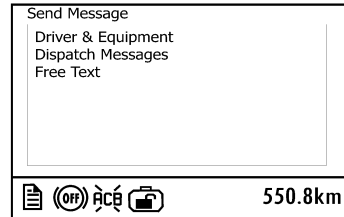

W3072076

The Driver & Equipment and Dispatch Messages menus contain standard messages.

Driver & Equipment

H3 and X3 Models
<ul style="list-style-type: none">• Driver1:Start/Resume• Off Duty For the Day• Pre-Trip Check OK• Stopped: On Duty• Stopped: Off Duty• Please Call Me ASAP• Instructions Needed• Breakdown: Stranded• Breakdown: Driveable

Note: Message “Breackdown: Stranded”, open a case with PASS. PASS will take action to contact the people they have in reference for this vehicle help. Only this message is alerting PASS.

8 General Information

Dispatch Messages

H3 and X3 Models

- Trip/Leg: Started
- Trip/Leg: Completed
- Status: Loaded
- Status: Empty
- Not Fueled/ Cleanedl
- Picked up Group
- Dropped Group
- Stop-Off
- On Time Arrival
- Late: More Than 1 h
- Send Dispatch Info

To select a message, scroll to the message and press **ENTER**. To send the message, press **ENTER**. Press **ESCAPE** to return to the menu.

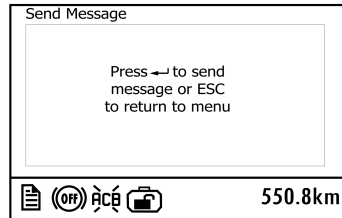

Free Text

Free text messages are sent as follows:

Use the switch button to scroll the cursor (see 1 in illustration) through the available characters. Press the UP arrow to move to the left and the DOWN arrow to move to the right. Once the cursor has highlighted the correct character, press **ENTER**. Repeat for each character.

Hold the UP or DOWN arrow to quickly move the cursor through the available characters.

Use the message movement arrows (see 5 in illustration) to move the cursor (see 4 in illustration) in the message area.

When finished with the message select X (see 6 in illustration), or press **ENTER** and hold for 3 seconds, to send the message.

Note: Press **ESCAPE** to go back to the previous character. To cancel sending a typed message, press **ESCAPE** until the message is cleared from the screen.

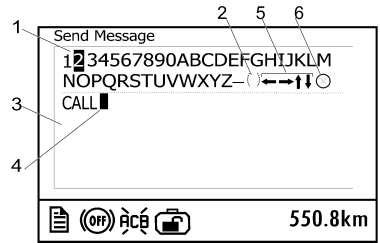

W3072077

- 1 Selection Cursor
- 2 Space
- 3 Message Area
- 4 Message Cursor
- 5 Message Movement Arrows
- 6 Send Icon

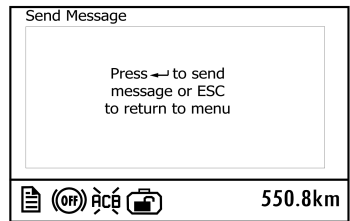

W3072073

10 General Information

After Message is Sent

After a message is sent, one of the following confirmations will appear on screen:

If **Message Placed In Outbox** is displayed, the message was received by the Telematics ECU and will be sent during the next GPS transmission.

If **Sending Not Allowed** is displayed, the message was **NOT** sent. The reason for this failure may be the system is busy or the output queue is full. Wait briefly and try sending the message again. If the error message persists, please contact your fleet operator.

Note: Sending Not Allowed is displayed if the Outbox is full or there is an antenna problem. Scroll to Mailbox Info and Comm Link Info screens for additional information.

If **Please CALL PASS (800) 463-7738** is displayed, the message was **NOT** sent. This indicates that messaging capabilities have not been activated or they have been disabled by the fleet. Please contact your fleet operator.

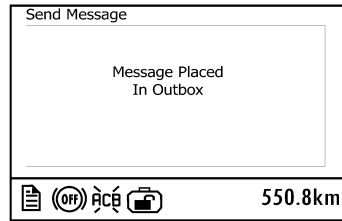

W3072080

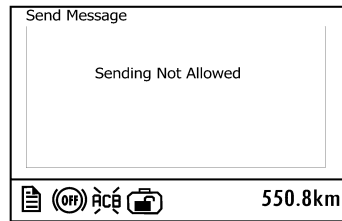

W3072081

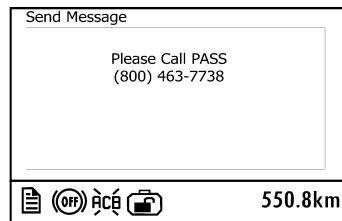

W3072082

Other Info

The **Other Info** menu displays general operational information about the Telematics System. Information includes:

- Comm Link Info
- Mailbox Info
- GPS Info
- INI Info
- Configuration Info

Use the switch buttons to scroll through each screen. To update the information in each screen, scroll to the next screen then return to the previous screen.

The **Comm Link Info** screens provide information about the Internet Protocol and International Mobile Subscriber Identity. Signal is a scale of 0 to 30, indicates quality of cell reception.

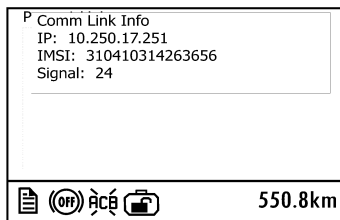

12 General Information

The **Mailbox Info** screen indicates the total number of messages sent and received. Also indicated is the number of messages currently in the outbox waiting to be transmitted and whether or not the outbox is full.

0 in Outbox means all messages were processed and sent. If in a zone where no cell coverage, and message is sent by driver, Outbox could indicate something different than 0, where a message is pending. This could be a check for driver if he wants to confirm his message has gone through.

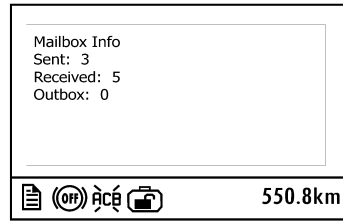

W3072083

The **GPS Info** screen provides information about the GPS signal. It displays how many satellites are in view and the type of **Fix** (3D, 2D or No Fix). **Lat** is the current latitude. **Lon** is the current longitude.

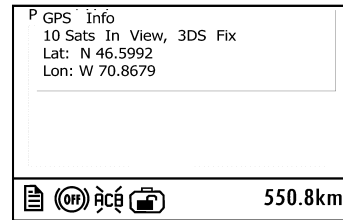

W3072079

The **INI Info** screen displays the current state of the ECU initialization (start-up) and the VIN Check status.

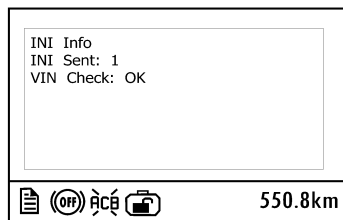

W3072084

The **Configuration Info** screen indicates the status of active schedules and driver messaging. When schedules are enabled, the number of active schedules is also displayed.

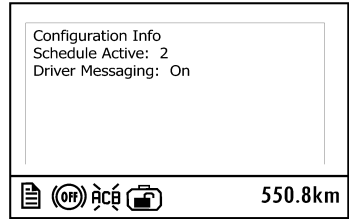

W3072085

Compass Gauge

Select **Gauges** in the DID main menu and scroll UP or DOWN to display the compass gauge.

If a GPS fix is not available, the gauge may or may not display the compass arrow, a latitude and longitude reading, a 0.0 or dashes latitude and longitude reading. Scroll to the **GPS Info** screen to check the GPS signal status.

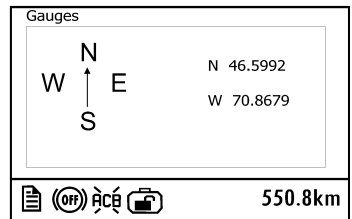

Location

The location of the vehicle is displayed in degrees latitude and longitude. The top value shows the latitude. The bottom value shows the longitude.

Directional Arrow

The compass arrow shows the direction the vehicle is travelling. After the vehicle is stopped, the arrow stays pointed in the last direction of travel.

VOLVO

Volvo Bus Corporation

Göteborg, Sweden

Driver's Handbook

Passenger, Seat Side Electrical Outlet

B13R

VOLVO

Foreword

This information provides the service information about the operation and function of the Passenger, Seat Side Electrical Outlet in Volvo buses.

Note: Illustrations in this manual are used for reference only and may differ slightly from the actual vehicle. However, key components addressed in this document are represented as accurately as possible.

Volvo Bus Corporation

Göteborg, Sweden

Order number: 89070632

©2012 Volvo Bus Corporation, Göteborg, Sweden

All rights reserved. No part of this publication may be reproduced, stored in retrieval system, or transmitted in any forms by any means, electronic, mechanical, photocopying, recording or otherwise, without the prior written permission of Volvo Bus Corporation

Contents

Passenger, Seat Side Electrical Outlet.....	1
System Overview	1
Network System Description	2
Electric Network Operation	3
Resetting Electric Network 127 V.....	4

Safety Information

IMPORTANT: Before driving this vehicle, be certain that you have read and that you fully understand each and every step of the driving and handling information in this manual. Be certain that you fully understand and follow all safety warnings.

IT IS IMPORTANT THAT THE FOLLOWING INFORMATION BE READ, UNDERSTOOD AND ALWAYS FOLLOWED.

The following types of advisories are used throughout this manual:



DANGER

Danger indicates an unsafe practice that could result in serious personal injury or death. A danger advisory banner is in **white** type on a **black** background with a **black** border.



WARNING

Warning indicates an unsafe practice that could result in personal injury. A warning advisory banner is in **black** type on a **gray** background with a **black** border.



CAUTION

Caution indicates an unsafe practice that could result in damage to the product. A caution advisory is in **black** type on a **white** background with a **black** border.

Note: Note indicates a procedure, practice, or condition that must be followed in order for the vehicle or component to function in the manner intended.

System Overview

Some vehicles can be equipped with 127 V AC passenger, seat side electrical outlets. The circuit may have up to twenty four(24) outlets.

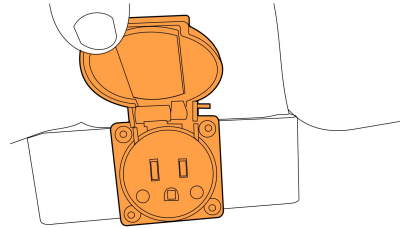

As standard, one electrical outlet, is located in front of each pair of passenger seats.

W3076818



CAUTION

Only laptop computer may be connected to the electrical network.
Connecting any other electrical device may cause a malfunction of the electrical network.

2 Passenger, Seat Side Electrical Outlet

Network System Description

Passengers can use the electrical outlets to connect their laptop computer.

A maximum of sixteen (16) laptop computers can be connected at same time.

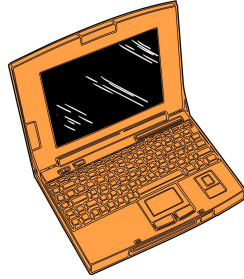

W0074155

Electric Network Operation

The following conditions must be satisfied before the electrical network can be used.

1. Engine Speed must be greater than 1000 RPM.
2. Wheel Chair Lift (WCL) must be inactive.

Note: If this required condition is not met, the operation relay will not activate and electrical network will not function.

Note: If the vehicle does not have a WCL condition 2 does not apply.

4 Passenger, Seat Side Electrical Outlet

Resetting Electric Network 127 V.

To protect the vehicle, the electrical network has a thermal circuit breaker to disconnect the power supply if the load exceeds 25A.

In the event of a circuit interruption the passengers must disconnect their laptop computer prior to resetting the circuit breaker. Leaving devices connected to the electrical network may damage the devices or cause a repeat circuit interruption.

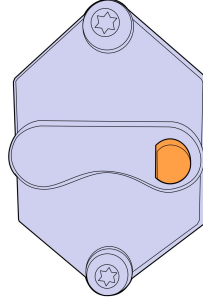

W3074156

Passenger, Seat Side Electrical Outlet 5

There is an 50A fuse protecting the electric network. This fuse is located in the fuse and relay box in the interior bus floor behind the operators seat.

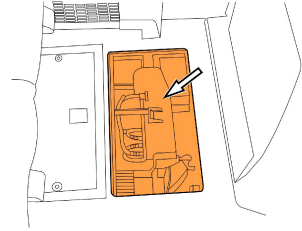

W3076819

If the fuse fails, it should be replaced by an 50A fuse. Never insert a fuse of a higher amperage rate. Replacement of this fuse should be performed **by a properly trained technician.**

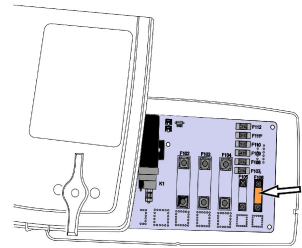

W3076817



WARNING

Failure to use proper circuit protection devices in the vehicle can result in damage to the vehicle and its components. Replace blown fuses only with fuses of the same rating. Replace fusible links only with proper replacement parts of the exact gauge and length. Failure to use proper circuit protection could overload the circuit, causing damage to the vehicle and a possible fire, and personal injury

VOLVO

Volvo Bus Corporation

Göteborg, Sweden

Operating Instructions

Display

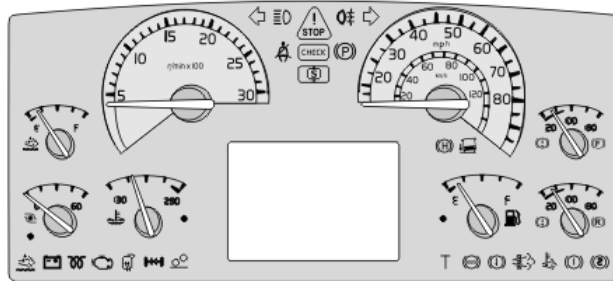

VOLVO

Contents

General	1	Average Speed	22
Display and Stalk Switch Control		Estimated Time of Arrival	23
Lever	1	Aftertreatment (ATS)	24
Getting Started	2	Aftertreatment (ATS) Enable/Disable ...	24
Navigating in the DID	3	System Conditions	25
Vehicle Messages and Symbols	4	Menu Display	27
General Information on Vehicle		Black Panel	27
Messages	4	Favorite Display	27
Status Symbols	7	Backlight	27
Use the Display Menus	8	Favorite Display, Set	28
General Information on Menus	8	Night/Day	30
Scroll Between the Menus	8	Menu Vehicle Messages	31
Changing Settings	9	Vehicle Messages	31
Menu Overview	12	Language	32
Main Menus and Sub-menus	12	Units	32
Menu Gauge	14	Time/Date	33
Gear Engaged	14	Display light	34
Temperature Outside/Inside	14	Change Password (If Password is	
Temperature Engine Oil	14	Required)	35
Voltmeter	15	Menu Vehicle Settings	36
Pressure, Primary Tank	15	Traction Control	36
Engine Oil Pressure	15	Fleet Limits (Password is Required)....	37
Brake Pressure, 3rd Circuit	15	Fleet ID (Password Required)	40
Menu Fuel Data	16	Day Running Light	40
Fuel Used	16	Menu Diagnosis	41
Average fuel consumption	17	Fault Diagnostics	41
Stage Information	17	Instrument Cluster Self Test	43
Remaining Fuel	17	Part Number	44
Menu Climate	18	Menu Vehicle Data	45
Climate System/Pause Heating,		Oil Level	45
Passenger	18	Lining Wear Prediction	45
Temperature/Roof Fan, Passenger	18	Menu Data Log	46
Roof Heat/Floor Fan, Passenger	19	Vehicle ID	46
Extra Heat, Passenger	19	Total Data	46
Floor Fan, Driver	19	Trip Data	47
Menu Time/Distance	20	Reset Trip Data (Password Required) ...	47
Clock and Date	20	Menu Password	48
Alarm Clock	21	Enter Password	48
Trip Meter	22		

Safety Information

IMPORTANT: Before driving this vehicle, be certain that you have read and that you fully understand each and every step of the driving and handling information in this manual. Be certain that you fully understand and follow all safety warnings.

IT IS IMPORTANT THAT THE FOLLOWING INFORMATION BE READ, UNDERSTOOD AND ALWAYS FOLLOWED.

The following types of advisories are used throughout this manual.



DANGER

Danger indicates an unsafe practice that could result in serious personal injury or death. A danger advisory banner is in **white** type on a **black** background with a **black** border.



WARNING

Warning indicates an unsafe practice that could result in personal injury. A warning advisory banner is in **black** type on a **gray** background with a **black** border.



CAUTION

Caution indicates an unsafe practice that could result in damage to the product. A caution advisory is in **black** type on a **white** background with a **black** border.

Note: Note indicates a procedure, practice, or condition that must be followed in order for the vehicle or component to function in the manner intended.

Display and Stalk Switch Control Lever

The Driver Information Display (DID) is located in the middle of the instrument cluster. The display shows vehicle messages and information about the bus, and from it you can control some of the bus functions.

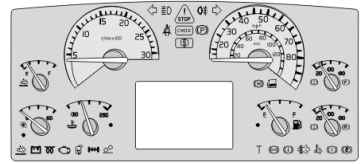

W3079694

The display is controlled via the stalk switch control lever to the right of the steering wheel. The control lever has four buttons:

- 1 **ESC**: Abort or return to previous menu.
- 2 **SELECT**: Select or confirm marked choice.
- 3 **▲**: To Scroll the cursor up or set a symbol.
- 4 **▼**: Scroll the cursor down or set a symbol.

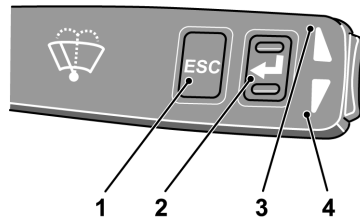

T0014701

2 General

Getting Started

Display Fields

The display is divided into three fields:

1 **Menu and message field**

Menus, stop, warning and information messages are shown.

2 **Favorite display/Clock**

Information is shown, which the driver has selected in the left area, using the “Favorite Display” menu. For buses with automatic transmissions, the selected gear is shown.

To the right, the clock is shown.

Note: Some variants do not have an adaptable Favorite Display.

3 **Status line/Odometer**

To the left, current status symbols are shown. To the right, the odometer is shown.

(1)
(2)
(3)

Navigating in the DID

The DID lights up when the starter key is turned. If there are any vehicles messages, they will be shown in the top field. The most important message is shown first. The message order number is shown in the top right corner. For example, 2/13 indicates that the message now being displayed is the second of thirteen active messages. For more information on messages see “General Information on Vehicle Messages”, page 4 .

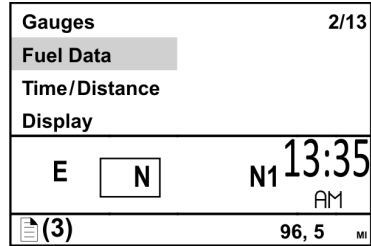

W3079748

Scroll between the various vehicle messages using the ▲ and ▼ button. Take suitable actions and then acknowledge them with **ESC**.

When the vehicle messages have been acknowledge the menus are shown. To navigate between the menus:

- 1 ▲/▼ Scroll the cursor between the menus, which are then marked. The hierarchical order for menus is shown in the top right corner (for example 2/13).
- 2 Pressing **SELECT** confirms the choice.
- 3 Pressing **ESC** exits the chosen menu. Repeated pressing on **ESC** moves the cursor back to the main menus.

For more information on menus, see “General Information on Vehicle Messages”, page 4 .

4 Vehicle Messages and Symbols

General Information on Vehicle Messages

There are three lamps above the display:

- Lamp for stop messages
- Lamp for warning messages
- Lamp for stop at the next bus stop.

When there is a fault in the bus or an incident occurs which requires attention, one of these three lamps is lit. Associated messages and symbols are shown in the Driver Information Display (DID) at the same time. Several messages may be active at the same time. The message with the highest priority is shown first in the display.

Previously shown messages can be retrieved in the DID; For more information see “Vehicle Messages”, page 31.

For more detailed technical information about vehicle messages, see “Fault Diagnostics”, page 41.

Note: For explanation of the symbols used in vehicle messages, see the driver's handbook.

Stop Messages

When the Stop telltale lights, the vehicle must be stopped immediately and the engine switched off.

A buzzer sounds at the same time as a stop message is displayed. The buzzer and stop message can be acknowledged with **ESC**, but is repeated after 10 seconds. The symbol is lit continuously.



T3014364

 WARNING
If the Stop telltale lights while driving, stop the bus immediately and turn off the engine. Continuing to drive may severely endanger the vehicle, the driver and/or passengers.

Warning Messages

If this lamp lights, the vehicle must be taken to a workshop for repair as soon as possible. There is no immediate danger of the vehicle breaking down, and under normal circumstances it should be possible to complete the journey. This lamp is also used to draw the driver's attention to problems other than vehicle failures, e.g. as a warning in the case of an open luggage compartment hatch.

Acknowledge the message with **ESC**. If the fault is still active, it will be shown again next time the starter key is turned to the starting position.



T3014365

6 Vehicle Messages and Symbols

Stop at the next bus stop Message

Simultaneously with this lamp lighting up, a new message is shown on the display. The fact that this lamp lights up does not mean that there is something wrong with the vehicle. This lamp may for example illuminate to draw the driver's attention to low fuel level.



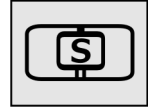

Acknowledge the message with **ESC** key. If the information message is still activate, it will be shown again next time the starter key is turned to the starting position.



W3079585

Status Symbols

Status symbols are shown in the lowest row of the display.

Symbol	Meaning
	Pre-Heat active
	Alarm clock activated
	Message active
MI	Odometer, miles
KM	Odometer, kilometers
CC	Cruise control active
AC	Climate control active
(A)	Auxiliary brake position A
(1)	Auxiliary brake position 1
(2)	Auxiliary brake position 2
(3)	Auxiliary brake position 3
(B)	Auxiliary brake position B
	Auxiliary brake in operation

8 Use the Display Menus

General Information on Menus

Using the menus you can see the status and control some of the bus functions. For reasons of safety, not all menus are available when driving. To see certain menus and to adjust certain settings, the bus must be stationary. A password is required for some menus.

Scroll Between the Menus

- 1 Scroll the cursor between menus using ▲ and ▼. The order number of the marked menu is shown in the top right corner. 2/13 indicates that there are 13 menus and that the current menu is number 2.
- 2 Go from a menu to a sub-menu using **SELECT**
- 3 Exit a sub-menu using **ESC**

Gauges	2/13
Fuel Data	
Time/Distance	
Display	
E <input type="checkbox"/> N	N1 13:35
	AM
(3)	96, 5 MI

W3079748

Changing Settings

- 1 Use ▲/▼ to change set values (for example, number of hours).
- 2 Pressing **SELECT** confirms the choice.
- 3 Use **ESC** to Scroll the cursor to the previous digit or abort the setting process.

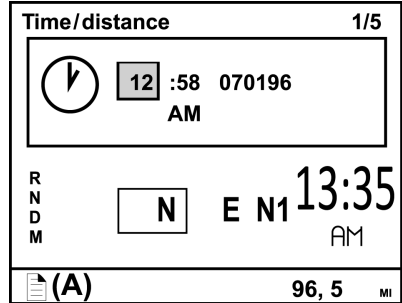

T0031652

Example: Change a Setting

The Favorite Display is shown. To set the alarm clock to go off at 02:33. Proceed as follows:

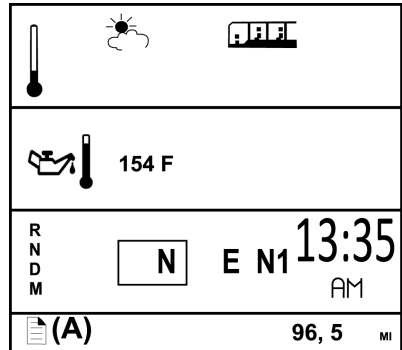

T0031653

1

Go to the menus using **SELECT** Place the cursor on Time/Distance using ▲ and ▼ .

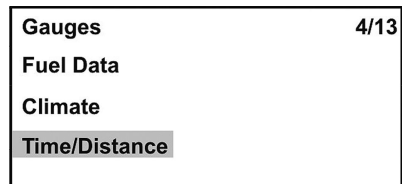

T0031654

10 Use the Display Menus

2

Press **SELECT** The current time and date are shown.

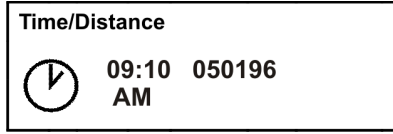

T8056484

3

Scroll to the alarm clock using **▲** and **▼**.

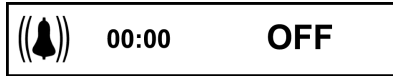

T0031656

4

Press **SELECT** Scroll down to **SET** using **▲** and **▼**.

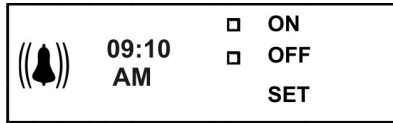

T8056483

5

Press **SELECT** The hours are marked. Scroll to the required hour using **▲** and **▼**.

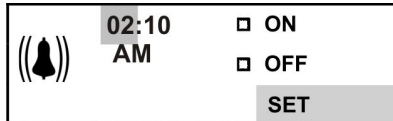

T8056482

6

Press **SELECT** The first digit for minutes is marked. Scroll to the required digit using **▲** and **▼**.

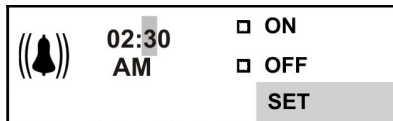

T8056481

7

Press **SELECT** The second digit for minutes is marked. Scroll to the required digit using ▲ and ▼.

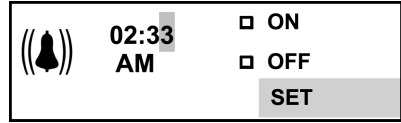

T0031660

8

Press **SELECT** "ON" is marked.

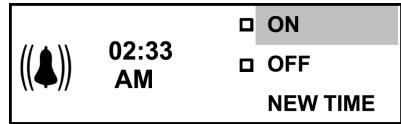

T0031661

9

Press **SELECT** A cross is placed in the box in front of "ON." The symbol for activated alarm clock is shown in the status bar. The alarm clock setting is then automatically displayed.

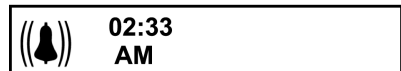
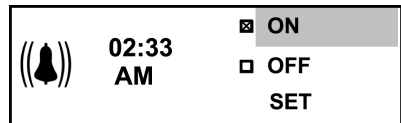

T0031662

10

Return to Favorite Display using ESC. The symbol for activated alarm clock is shown in the status bar.

To deactivate the alarm clock:

- Go into menu "Time/Distance" using **SELECT**
- Scroll to the alarm clock using ▲ and ▼.
- Press **SELECT**.
- Scroll to "OFF" with ▲ and ▼.
- Press **SELECT**.

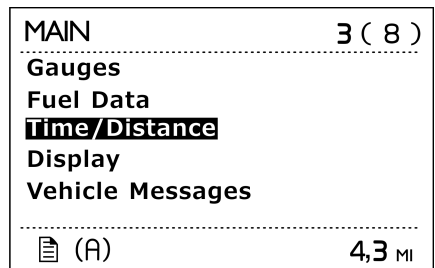

W3079745

12 Menu Overview

Main Menus and Sub-menus

The overview shows how the menus are structured.

- **Gauges**

Gear engaged

Temperature outside/inside

Temperature, engine oil

Voltmeter

Pressure, primary tank

Oil Pressure

Brake pressure, 3rd circuit

- **Fuel Data**

Average fuel consumption

Stage information

Remaining fuel

- **Climate**

Climate/Pause heating, passenger

Temperature/Roof Fan, passenger

Roof Heat/Floor Fan, passenger

Extra Heat, passenger

Floor Fan, driver

Note: Not all buses have all the menus that are shown in the overview.

- **Time/Distance**

Clock and Date

Alarm clock

Trip meter

Average speed

Estimated time of arrival

- **Display**

Black Panel

Backlight

Favorite Display, setting

Night/Day

- **Vehicle Messages**

- **DisplaySettings**

Favorite display set

Language

Clock/Date

Units

Time/Date

Display light

Change password

- **Aftertreatment System (ATS)**

Enable / Disable ATS

Regeneration request

System conditions

Soot/Ash level

- **Vehicle Settings**

Traction Control

Fleet limits

Fleet ID

Day Running Light

- **Diagnosis**

Fault diagnosis

Cluster self test

Part number

- **Vehicle Data**

Oil level

Lining wear prediction

- **Data Log**

Vehicle ID

Total data

Trip Data

Reset trip data

- **Password**

Enter password

14 Menu Gauge

Gear Engaged

(This gauge is extra equipment. Only buses equipped with an I-shift transmission.)
Information about the engaged gear, gear lever position, available gears and such like.
For further information, see separate driver instructions for "I-shift".

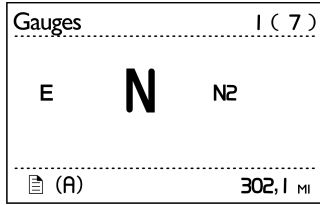

W3079551

Temperature Outside/Inside

(This gauge is extra equipment).
Outside temperature shown above. Bus inside temperature shown at the bottom.

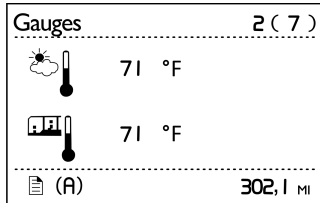

W3079552

Temperature Engine Oil

Temperature of the engine oil.

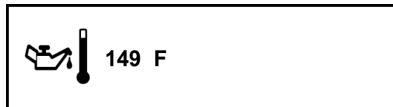

T0031666

Voltmeter

Battery voltage.

If the engine is running and the voltage drops below 20 V, a fault message is displayed together with the information/warning symbol.



T0031667

Pressure, Primary Tank

If the pressure in the primary tank drops below **100 PSI (7 bar)**, a fault message is displayed together with the information/warning symbol.

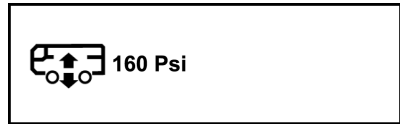

T0031668

Engine Oil Pressure

If the pressure drops below **25 PSI (1.7 bar)** a fault message is displayed together with the stop symbol and red light.

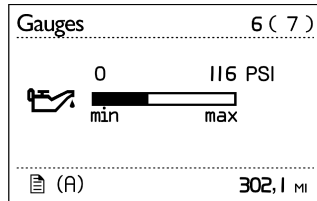

W3079554

Brake Pressure, 3rd Circuit

(only on buses with min. three axles).

If the pressure drops below **80 PSI (5.5 bar)** a fault message is displayed together with the stop symbol and red light.

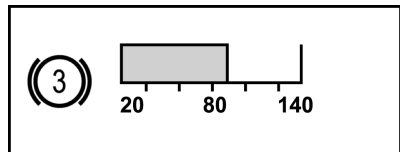

T0031669

16 Menu Fuel Data

Fuel Used

For setting the units, see “Units”, page 32.

1 **Average fuel consumption:**

The value is presented as a figure and an arrow pointing down. For a time after resetting the display “- — —” is shown while average fuel consumption is being calculated.

2 **Instantaneous fuel consumption:**

The value is presented numerically.

3 **Target fuel consumption:**

The value is presented with the symbol \wedge below the bar. For information on setting this value, see “Fuel Target”, page 39.

Note: At idle, no bar is shown and the fuel consumption is displayed in liter/hr (alternatively gallons/hr).

Resetting, fuel consumption

Press **SELECT**. To reset all fuel data, press **SELECT** for 1 second. Leg data is also reset .

Average fuel consumption

The average fuel consumption in gallons/hr (alternatively liter/hr)

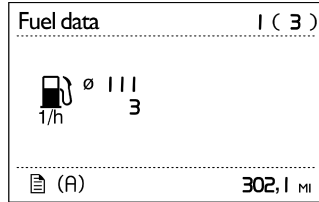

W3079553

Stage Information

The amount of fuel consumed since the last reset.



W3079993

Resetting, leg data

Press **SELECT** To reset leg data, hold **SELECT** depressed for 1 second.

Remaining Fuel

- The first value shows the distance that can be driven before the tank is empty with current fuel consumption.
- The second value shows the amount of fuel currently in the tank.

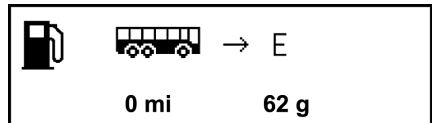

T0031671

18 Menu Climate

Climate System/Pause Heating, Passenger

Shows whether the passenger climate system or pause heating is switched on or off. Press **SELECT** once to come to "Climate system". Press **SELECT** twice to come to "Pause heating". Activate/deactivate the respective unit using the control lever buttons (**SELECT**, **ESC**, **▲** and **▼**).

Passenger:	
Climate system	ON
Pause heating	OFF

T0031672

Temperature/Roof Fan, Passenger

Shows the required temperature level or roof fan speed in the passenger compartment.

Press **SELECT** once to come to "Temperature". Press **SELECT** twice to come to "Roof Fan". Set the required temperature (between 59 and 82° F [15 and 28° C]) using the control lever buttons (**SELECT**, **ESC**, **▲** and **▼**). Set the required roof fan speed (manually between -5 and +5, alt. automatic) using the control lever buttons (**SELECT**, **ESC**, **▲** and **▼**).

Passenger:	
Temperature	62 F
Roof Fan	+1

T0031673

Roof Heat/Floor Fan, Passenger

Shows the selected level for roof heat or status for floor fan in the passenger compartment. Press **SELECT** once to come to "Roof Heat". Press **SELECT** twice to come to "Floor Fan". Set the required level for Roof Heat (manually between -5 and +5, alt. automatic) using the control lever buttons (**SELECT**, **ESC**, **▲** and **▼**). Activate/deactivate the floor fan (switched off, alt. automatic) using the control lever buttons (**SELECT**, **ESC**, **▲** and **▼**).

Passenger:	
Roof Heat	AUTO
Floor Fan	N/A

T0031684

Extra Heat, Passenger

Shows whether the extra heating in the passenger compartment is switched on or off. Activate/deactivate the extra heat using the control lever buttons (**SELECT**, **ESC**, **▲** and **▼**).

Passenger:	
Extra Heating	N/A

T0031685

Floor Fan, Driver

Shows whether the floor fan in the driver compartment is in automatic position or switched off.

Activate/deactivate the floor fan using the control lever buttons (**SELECT**, **ESC**, **▲** and **▼**).

Driver:	
Floor Fan	N/A

T0031686

20 Menu Time/Distance

Clock and Date

Shows current time and date. For setting the formats, 12 hr alt. 24 hr and date, see “Time/Date”, page 33.

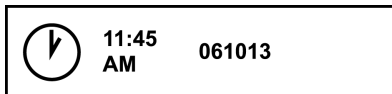

T0031687

Setting, time and date

Press **SELECT**. Set the time and date using the control lever buttons (**SELECT**, **ESC**, **▲** and **▼**). If the starter key is in stop position and it takes more than 30 seconds between button depressions, the setting process is aborted.

Note: The menu "Time and date" is available even when the starter key is in the stop position. The menu is activated by pressing any of the buttons on the control unit for at least 1 second. The menu remains active for 30 seconds after the last depression.

Alarm Clock

Alarm clock, setting

Press "SELECT". Set the alarm time using the control lever buttons (SELECT, ESC, ▲ and ▼). Finish off by selecting "ON". The symbol for the alarm is shown on the status bar to indicate that the alarm clock is active.

Note: The alarm clock cannot be set while driving. If the starter key is in stop position and it takes more than 30 seconds between button depressions, the setting process is aborted. The menu "Alarm clock" is available even when the starter key is in stop position. The menu is activated by pressing any of the buttons on the control unit for at least 1 second.

Activate Alarm Clock

Here the alarm clock can be activated without changing the alarm time. Activate the alarm using the control lever buttons (SELECT, ESC, ▲ and ▼). When the clock has been activated, the symbol for activated alarm clock is shown on the display status bar.

Switch Off the Alarm clock

When the alarm clock goes off, the word "ALARM" lights up, the current time is displayed and a warning signal is sounded. The alarm shuts off after 60 seconds or if ESC is depressed.

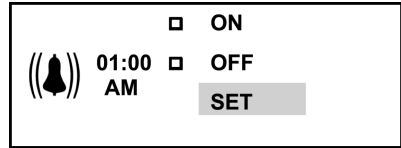

T0031688

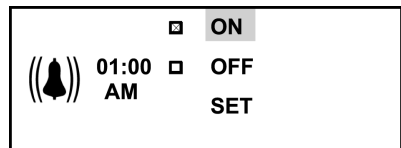

T0031689

22 Menu Time/Distance

Trip Meter

Two independent distances can be saved, for leg 1 and leg 2.

Note: The trip values must be reset before each measurement.

Reset Trip Meter Press "SELECT". Reset the trip meters 1 and 2 respectively using the control lever buttons (SELECT, ESC, ▲ and ▼).

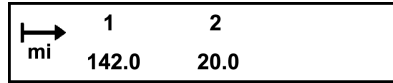

T0031690

Average Speed

The average speed is calculated as the distance driven divided by the time the engine has been running (since latest reset). Two different average speeds can be measured, average speed 1 and 2.

Note: The values must be reset before each measurement.

Reset Average Speed

Press "SELECT". Reset average speeds 1 and 2 respectively using the control lever buttons (SELECT, ESC, ▲ and ▼).

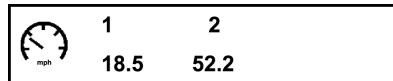

T0031691

Estimated Time of Arrival

The estimated time of arrival is calculated as the remaining distance divided by the vehicle's average speed.

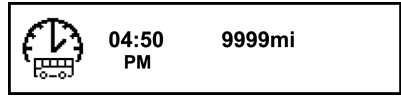

T0031692

Set Distance

Press "SELECT". Set the remaining distance in Km (alt. miles) using the control lever buttons (SELECT, ESC, ▲ and ▼).



T0031693

24 Menu Time/Distance

Aftertreatment (ATS)

For additional information about the aftertreatment system (ATS), refer to Exhaust Aftertreatment System manual.

The aftertreatment menu allows the operator to request a parked regeneration, check the status of the aftertreatment system, and cancel a regeneration.

ATS	I (4)

ATS Enable/Disable	
Request regeneration	
System conditions	
Soot/Ash level	

 (A)	4,3 MI

W3079746

Aftertreatment (ATS) Enable/Disable

To temporarily disable automatic regeneration, scroll to the Aftertreatment menu, select "ATS Enable/Disable". When automatic regeneration is disabled, the letters ATS with X through them will be displayed in the DID. Enable regeneration by scrolling to the Aftertreatment menu, selecting "ATS Enable/Disable" and selecting "Enable REGEN".

ATS Enable/Disable	I (2)

<input checked="" type="checkbox"/> Enable regeneration	
<input type="checkbox"/> Disable regeneration	

 (A)	4,3 MI

W3079740

System Conditions

The system conditions menus are used to help determine why a parked regeneration failed.

System conditions		1 (4)
Clutch Status	NA	▲
Engine Status	Check	
PTO Status	OK	▼
 (A)		4,3 MI

W3079741

System conditions		2 (4)
Acc. Pedal	OK	▲
Gear Status	OK	
Vehicle Speed	OK	▼
 (A)		4,3 MI

W3079742

System conditions		3 (4)
Park Brake	OK	▲
System Fault	OK	
Perm System Lockout	OK	▼
 (A)		4,3 MI

W3079743

26 Menu Time/Distance

System conditions	4 (4)
Temp System Lockout Inhibit Switch	▲ Check OK ▼
📄 (A)	4,3 MI

W3079744

Black Panel

When "Black panel" is activated, only the speedometer, tachometer (except the colored field) and the lowest line of the display light up. The following events light the backlighting:

- a message is activated
- a button is depressed
- the engine speed enters the red field on
- the tachometer

Favorite Display

This function is used to activate " Favorite Display".

Backlight

This menu can be used to alter the display lighting with respect to the lighting of the other instruments.

Set backlight

- 1 Increase or decrease the backlight in the display using ▲/▼.
- 2 Confirm with **SELECT**.
- 3 **ESC** aborts the setting process.

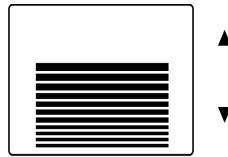











W3079738

28 Menu Display

Favorite Display, Set

Select the gauges and functions to show in "Favorite Display".



No display	
Gear engaged	
Outside temperature	
Temperature, engine oil	
Fuel used	
Stage information	
Remaining fuel	
Trip meter	

Pressure, primary tank	
Pressure, 3rd brake circuit	
Average speed	
Estimated time of arrival	

T0031745

To Select Favorite Display:

- 1 Press **SELECT**.
- 2 Press **SELECT** once more and the upper field becomes active. Select gauge or function using ▲ and ▼. Confirm with **SELECT** when the desired gauge or function is shown.
- 3 Press **SELECT** once more to activate the next field. Select gauge or function using ▲ and ▼. Confirm with **SELECT** when the desired gauge or function is shown.
- 4 Press **SELECT** or **ESC** until all the fields are active and the clock is shown.

	
 59 F	
 208 F	11:45 AM
CC	4000.00 mi

T0031746

30 Menu Display

Night/Day

This function is used to switch between white text on a black background and black text on a white background.

Press **Select** to switch between alternatives.

Vehicle Messages

If a message appears on the display, confirm to be aware by pushing ESC key, then a symbol will appear on the status bar. Enter to this menu to view the messages confirmed and not corrected.

Switch between messages using ▲ and ▼.

Press **ESC** to return to the main menu.

If a confirmed message is still active it will appear as unconfirmed message the next time the starter key will set in ON position. The message symbol will stay as long as there are unconfirmed messages.

32 Menu Vehicle Messages

Language

Select the desired language using the control lever buttons (SELECT, ESC, ▲ and ▼).

Units

Distance

Select to show distances in Km or miles using the control lever buttons (SELECT, ESC, ▲ and ▼).

Fuel Consumption

Select, using the control lever buttons (SELECT, ESC, ▲ and ▼), to show fuel consumption in Km/l, l/100 Km, miles per gallon (mpg) for IMP gallons or as miles per gallon (mpg) for US gallons.

Temperature

Select, using the control lever buttons (SELECT, ESC, ▲ and ▼), to show temperatures in Fahrenheit (F) or Celsius (C).

Time/Date

Time

Set the time format (AM/PM or 24:00) using the control lever buttons (SELECT, ESC, ▲ and ▼).

Date Display

Select, using the control lever buttons (SELECT, ESC, ▲ and ▼), from the various date formats.

- year, month, day (**yymmdd**)
- day, month, year (**ddmmyy**)
- month, day, year (**mmddyy**)

34 Menu Vehicle Messages

Display light

Contrast

Set the contrast using the control lever buttons (SELECT, ESC, ▲ and ▼).

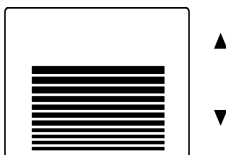

W3079738

Backlight

In this menu the display lighting can be altered in relation to the other instrument lighting, using the control lever buttons (SELECT, ESC, ▲ and ▼).

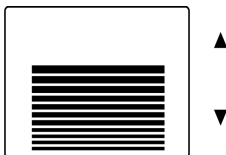

W3079738

Standard / Inverted

This function is used to switch between white text with black background and black text with white background, using the control lever buttons (SELECT, ESC, ▲ and ▼).

Change Password (If Password is Required)

First enter the current password, see “Enter Password”, page 48.

- 1 Mark the password to be changed using ▲ and ▼.
- 2 Confirm with **SELECT**.
- 3 Enter the first digit using ▲ and ▼.
- 4 Scroll to the next digit using **SELECT**.
- 5 Scroll back in the menu using **ESC**.

36 Menu Vehicle Settings

Traction Control

Select On or Off using the control lever buttons (SELECT, ESC, ▲ and ▼). When traction control is turned off, a warning symbol is shown.



T0014612

Fleet Limits (Password is Required)

Revolutions Per Minute (RPM) Limit

Only accessible if correct password is entered.

This function makes it possible for the carrier to set an engine speed limit for the fleet. If the engine exceeds this limit, it will be registered, see "Trip data" page 46.

Select **RPM Limit (max)** and set the new engine speed limit in rpm using the control lever buttons (SELECT, ESC, ▲ and ▼).

If the setting fails:

- Press **ESC** and try to do the setting once again.
- If it still fails, perform a diagnosis of the display and engine control unit, see "Fault Diagnostics", page 41.
- Contact a authorized VOLVO workshop if necessary or Prevost service center/provider.

38 Menu Vehicle Settings

Speed Limit

Only accessible if correct password is entered.

This function makes it possible to set a road speed limit for the fleet. If the bus exceeds this speed it is registered, see "Trip data" page 46. Go to "Speed Limit (max)" and set the new speed limit using the control lever buttons (SELECT, ESC, ▲ and ▼).

The message "Transfer complete" is shown

If the setting fails:

- Press **ESC** and try to do the setting once again.
- If it still fails, perform a diagnosis of the display and engine control unit, see "Fault Diagnostics", page 41.
- Contact a workshop if necessary.

Fuel Target

Only accessible if correct password is entered.

This function makes it possible to set a fuel consumption target for the fleet. For information about fuel consumption for a journey, see "Trip data" page 46.

If the setting fails:

Select "On" or "Off" using the control lever buttons (SELECT, ESC, ▲ and ▼).

- Press **ESC** and try to do the setting once again.
- If this still fails, perform a diagnosis of the display and engine control unit, see "Fault Diagnostics", page 41.
- Contact a workshop if necessary.

40 Menu Vehicle Settings

Fleet ID (Password Required)

Only accessible if correct password is entered.

Using this menu the carrier can enter the vehicle ID within the fleet if required. Data registered in the engine control unit is then registered for that ID.

Set the fuel consumption target using the control lever buttons (SELECT, ESC, ▲ and ▼). 13 digits must be entered (a space is entered for unused positions).

If the setting fails:

- Press **ESC** and try to do the setting once again.
- If it still fails, perform a diagnosis of the display and engine control unit, see “Fault Diagnostics”, page 41.
- Contact a workshop if necessary.

Day Running Light

Day running lights can be switched off in this menu. This means that if the day running lights have been set to the **OFF** position, the dipped beam must be turned on and off using the lights knob in the panel.

Select **ON** or **OFF** using the control lever buttons (SELECT, ESC, ▲ and ▼).

Fault Diagnostics

A list of the bus's control units is shown in the "Fault diagnostics" menu.

Switch between control units using ▲ and ▼. **SELECT** confirms choice of control unit. To abort press **ESC**.

- 1 During the time that the selected control unit is being called up, the display indicates that "Data transfer is taking place".
- 2 If the selected control unit has no faults "No faults" is displayed. Press **ESC** to return to the previous menu.
- 3 If the selected control unit does not reply within 5 seconds the following is shown "Operation failed" in the display.
 - Press **ESC** and try to do the setting one again, see point 1.
 - If it still fails, perform a diagnosis on the display and selected control unit.
 - Contact a workshop if necessary.
- 4 The following is shown if the selected control unit has a fault code:
 - Which control unit it applies to
 - Which parameter or component is faulty
 - Which type of fault it is
 - If the fault is active or inactive
 - How many times the fault has been registered since the last reset
- 5 If there are several fault codes or fault messages for the same control unit, you can scroll through the fault codes using ▲ and ▼. "Reset all" is shown last in the list. This resetting only clears the fault codes for the selected control unit.

42 Menu Diagnosis

- 6 A maximum of 20 fault codes/messages can be shown for a control unit. To see more than the first 20, one or more messages must be deleted.
- 7 Press **SELECT** to show more information on the fault code. Fault codes are shown numerically here. If the fault is inactive, among other things, the time and date when it occurred are shown.

MID: Identification of control unit

Instrument Cluster Self Test

Telltale Test

- 1 Select "Telltale test".
- 2 The control lamps light for approx. 5 seconds.
- 3 Abort the test using **ESC**.

Gauges test

Gauges Test

- 1 Select "Gauge test".
- 2 Gauge function is checked through the entire of the gauge. The pointers move back and forth a couple of times between the end positions. The pointers should not show a particular value; this is only a function check.
- 3 Stop the test using **ESC**.

Display Test

- 1 Select "Display test".
- 2 The whole display lights up for 3 seconds after which it blacks out for 3 seconds. After this a checkered pattern is displayed for 3 seconds. The checkered pattern is then displayed inverted for 3 seconds.
- 3 Stop the test using **ESC**.

Speaker Test

- 1 Select "Speaker test".
- 2 The ticking sound of the direction indicators is heard from the instrument panel load speakers.
- 3 Cancel the test using **ESC**.

44 Menu Diagnosis

Part Number

A list of the bus control units is shown in the menu "Part number".

- 1 Select a part using ▲ and ▼.
- 2 Confirm with **SELECT**.
- 3 Return using **ESC**.

Oil Level

The bus has an electronic oil level sensor.

The bar marked "min" and "max" shows the engine oil level. The figure in the centre shows how many gallons there are between min. and max. levels.

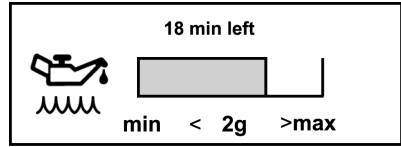

T0031743

The engine oil level is also shown when the key is turned to the ignition position. This is shown for 5 seconds or until the engine is started.

In order to show the correct value, the engine must have been turned off for at least 70 minutes. If the engine has not been turned off sufficiently long, the display shows how many minutes remain until a correct value can be shown.

If the oil level is below "min" a warning symbol is shown.

Note: There is no warning for low oil level while driving.

Lining Wear Prediction

See operating instructions Engine Braking System (EBS) for more information about lining wear prediction.

46 Menu Data Log

Vehicle ID

The bus chassis id and the vehicle number that were entered into the menu are displayed. For more information see “Fleet ID (Password Required)”, page 40.

Total Data

The total values show the engine's total values to date, logged during the lifetime of the engine control unit. The values that are saved are:

- Total distance
- Total fuel used
- Total engine hours.
- Total idle time
- Total engine revolutions

If the transfer should fail, then "No data" is shown when data is missing.

Trip Data

There are 12 different trip data stored.

- Trip distance
- Trip fuel avg
- Trip fuel acc
- Trip over revolutions
- Trip uneconomy revolutions
- Trip fuel uneconomy revolutions
- Trip average speed
- Trip overspeed:
- Trip engine hours
- Trip idle time
- Trip idle fuel
- Trip cruise

Note: In the menu "Trip data" you can find information saved since the last reset.

Switch between values using ▲ and ▼.

Return to previous menu using ESC. If the transfer should fail, then "No data" is shown when data is missing.

Reset Trip Data (Password Required)

Only accessible if correct password has been entered.

Reset all information in menu "Trip data".
Follow the instructions on the display.

48 Menu Password

Enter Password

Certain functions in the display are protected by a password. There are three passwords for the display. The factory set passwords are:

Workshop Password 1	0000
Owner Password	1234
Workshop Password 2	5678

When "Workshop, password 1" is entered, it is possible to reset values (applies to a number of functions). With both the other passwords the following menus are accessible:

- Fleet limit: engine speed
- Fleet limit: speed
- Fleet limit: fuel
- Fleet ID

When the starter key has been in the stop position for more than 60 seconds or if the battery has been disconnected, the password must be entered again in order to access all functions.

It is not possible to remove the password protection for certain functions. This can only be done at a authorized VOLVO workshop or Prevost service center/provider.

- 1 Set the first digit using **▲** and **▼**
- 2 Scroll to the next digit using **SELECT**
- 3 Scroll back using **ESC**

Note: Change password to prevent unauthorized access to menus, see "Change Password (If Password is Required)", page 35.

VOLVO

Volvo Bus Corporation

Göteborg, Sweden

Driver's Handbook

Exhaust Aftertreatment System

B13R, 9700

VOLVO

Foreword

This manual contains information concerning the operation and function of the Exhaust Aftertreatment System. The information in this manual applies to vehicles complying with US10 Emissions Standard Please keep this manual in the vehicle at all times.

Note: Illustrations in this manual are used for reference only and may differ slightly from the actual vehicle. However, key components addressed in this document are represented as accurately as possible.

The National Highway Traffic Safety Administration (NHTSA) and Prevost should be informed immediately if you believe that the vehicle has a defect that could cause a crash, injury or death.

Contact NHTSA by calling the Auto Safety Hotline at 1 (888) 327-4236, by writing to NHTSA, U.S. Department of Transportation, Washington, DC 20590, by TTY at 1 (800) 424-9153, or visit their website at www.nhtsa.dot.gov.

Volvo Bus Corporation

Göteborg, Sweden

Order number: 89090868

©2013 Volvo Bus Corporation, Göteborg, Sweden

All rights reserved. No part of this publication may be reproduced, stored in retrieval system, or transmitted in any forms by any means, electronic, mechanical, photocopying, recording or otherwise, without the prior written permission of Volvo Bus Corporation

Contents

Exhaust Aftertreatment System	1
General	1
System Overview	2
Exhaust Aftertreatment System Description	3
Filtration and Regeneration Unit	3
Passive regeneration	3
Stationary (parked) regeneration	4
Safety Information	5
Selective Catalytic Reduction	6
Instrument Cluster Icons	8
Operation	9
Aftertreatment Menu	10
DPF Regeneration	11
Aftertreatment DEF Tank Level — Driver Warning & Inducement	16
Aftertreatment DEF Quality — Driver Warning & Inducement	17
Exit conditions for DEF Quality “8Km/h (5 mph) road speed limit” Inducement:	18
Aftertreatment Tampering — Driver Warning & Inducement	19
Misfilling Diesel or Aftertreatment DEF Tanks	21
Results of misfilling DEF in Diesel Tank	21
Results of misfilling diesel en Aftertreatment DEF Tank	21
Aftertreatment System Maintenance	21
Aftertreatment System Conditions	22
Diesel Exhaust Fluid (DEF)	23
Diesel Exhaust Fluid (DEF) Handling	23
About spilled Diesel Exhaust Fluid (DEF)	24
Warranty and Maintenance	25
Exhaust Aftertreatment System Maintenance	25
Emissions Maintenance	25
Engine Gaseous Emission Control Systems	26
Emissions Control System Warranty	27
Engine Gaseous Emissions Control System Warranty	28
Federal Emission Requirements	28
Emission Control System Warranty — California	29
Emissions Control System Warranty	32
Engine Components, Service Schedules	34

Safety Information

IMPORTANT: Before driving this vehicle, be certain that you have read and that you fully understand each and every step of the driving and handling information in this manual. Be certain that you fully understand and follow all safety warnings.

IT IS IMPORTANT THAT THE FOLLOWING INFORMATION BE READ, UNDERSTOOD AND ALWAYS FOLLOWED.

The following types of advisories are used throughout this manual:



DANGER

Danger indicates an unsafe practice that could result in serious personal injury or death. A danger advisory banner is in **white** type on a **black** background with a **black** border.



WARNING

Warning indicates an unsafe practice that could result in personal injury. A warning advisory banner is in **black** type on a **gray** background with a **black** border.



CAUTION

Caution indicates an unsafe practice that could result in damage to the product. A caution advisory is in **black** type on a **white** background with a **black** border.

Note: Note indicates a procedure, practice, or condition that must be followed in order for the vehicle or component to function in the manner intended.

General

USA

Emissions Control Compliance: The Federal Clean Air Act, Section 203 (a) (3), states the following concerning the removal of air pollution control devices or modification of a certified engine to a non-certified configuration:

“The following acts and the causing thereof are prohibited:

(3) For any person to remove or render inoperative any device or element of design installed on or in a motor vehicle engine in compliance with regulations under this part prior to its sale and delivery to the ultimate purchaser, or for any manufacturer or dealer knowingly to remove or render inoperative any such design after sale and delivery to the ultimate purchaser”

Specifically, please note that no person may make such changes prior to the sale and delivery of the vehicle to the ultimate purchaser, and, in addition, no manufacturer or dealer may take such action after sale and delivery of the vehicle to the ultimate purchaser. The law provides a penalty of up to \$10,000 for each violation.

Modifications, such as reprogramming of the fuel system so the engine will exceed the certified horsepower or torque, or removing the mufflers are examples of illegal changes.

Changes should not be made to a certified engine that would result in an engine that does not match the configuration of an engine model that is currently certified to meet Federal Standards

Canada

The same conditions that apply in the USA apply to Canada, with one exception. After the vehicle is sold to a retail customer, that is, the end user, the jurisdiction controlling the emissions control devices becomes the province in which the vehicle is licensed. No changes should be made that render any or all of the devices inoperative.

Should the owner/ operator wish to make any changes to the emissions control devices, check with the provincial authority before making any such changes

Mexico

The same conditions that apply in the USA apply to Mexico. Refer to Mexican Federal Law for Emissions Control which adheres to EPA regulations. No changes Should be made that render any or all of the emissions control devices inoperative.

If the owner/operator wishes to make changes to the emission control devices, check with state authority before changes are made.

2 Exhaust Aftertreatment System

System Overview

EPA 2010 requires 83% reduction in NOx and 0% reduction in particulate relative to EPA 2007; then is retained the Diesel Particulate Filter (DPF) and is added another aftertreatment device called Selective Catalytic Reduction (SCR) catalyst. The process for reducing NOx via aftertreatment is called Selective Catalytic Reduction (SCR). It requires a catalytic converter into which is injected Diesel Exhaust Fluid (DEF). The primary component of DEF is water; the active component is urea. Urea is a nitrogen compound that turns to ammonia when heated. When a urea-and-water solution is injected into the exhaust stream and passed over a catalyst, the urea reacts with the NOx to form nitrogen and water vapor – two clean and harmless components of the air we breathe. The aftertreatment system primary function is to capture and oxidize (regenerate) the particulate matter (soot) in the engine exhaust gases and to reduce NOx. To achieve this goal, the exhaust aftertreatment system is split into two main sections: the exhaust gases first enter the Diesel Oxidation Catalyst

(DOC) and Diesel Particulate Filter (DPF) assembly to capture and regenerate the soot on a regular or passive basis, then the exhaust gases flow through the catalytic converter to reduce NOx to minimum level.

Vehicles equipped with a DPF require the use of EO-O Premium Plus (or VDS-4) specification high performance diesel engine oil and Ultra Low Sulfur Diesel (ULSD) fuel.



CAUTION

The use of Diesel fuel other than ULSD and engine oils other than EO-O Premium Plus (or VDS-4), will adversely affect performance, efficiency and durability of DPF system and the engine, to the point where the engine may not run at all. Manufacturer's warranties can also be rendered void due usage of improper fuel. None approved fuel additives (including engine oil) are NOT permitted. Blends of No. 1D and No. 2D grades of ULSD are recommended and allowable for cold weather operations.

Exhaust Aftertreatment System Description

The exhaust aftertreatment system consists of two units, the filtration and regeneration unit and the selective catalytic reduction SCR unit.

Filtration and Regeneration Unit

The main purpose of the filtration and regeneration unit is to capture and oxidize (regenerate) the particulate matter (soot) in the engine exhaust gas. The exhaust gas first enters the Diesel Oxidation Catalyst (DOC) and then flow through the Diesel Particulate

Filter (DPF); together they capture and regenerate the soot on a regular or passive basis. Through constant monitoring of the exhaust gas temperature and the system back pressure, the engine control module is able to manage regeneration.

Passive regeneration

Passive regeneration is the process by which the particulate matter is oxidized due to the heat generated by the engine internal combustion process. During normal highway

operation, exhaust temperatures alone are usually high enough to oxidize accumulating soot.

4 Exhaust Aftertreatment System

Stationary (parked) regeneration

In a small number of specific engine duty cycles, engine control module may not be capable of completing an active regeneration. In these situations, the operator will be notified that a stationary or parked regeneration may be required. A DPF telltale light will illuminate indicating the need for user interaction. The lamp gives the operator a grace period to allow this process to take place at a time when most convenient for the

operator. This process requires the vehicle to be parked while a driver or maintenance technician initiates the regeneration process using the DID menus. Once initiated, the stationary regeneration process will be complete in about 45 minutes. The driver will be notified of the need for a stationary regeneration (parked) by illumination of the DPF REGENERATION telltale light.

Safety Information

The exhaust aftertreatment system utilizes technology that oxidizes trapped particles of unburned hydrocarbons thereby reducing emissions. This oxidation occurs during the regeneration process. While regeneration is occurring, very high exhaust gas temperatures will occur when the vehicle is stationary.



WARNING

Always ensure that the vehicle is in a safe and suitable location to withstand the high temperatures that occur during the generation process. Equipment damage or personal injury may occur if combustibles are too close to the exhaust pipe or outlet.



WARNING

The temperature of the exhaust system components during the regeneration process can exceed 500 degrees C (1000 degrees F). Various factors including ambient temperature and duration of the regeneration process, determine when these components will return to normal operating temperature after regeneration has completed. Be extremely careful around these hot components. Contact with these components can result in personal injury.

6 Exhaust Aftertreatment System

Selective Catalytic Reduction

Selective Catalytic Reduction is an emissions-reduction technology with the ability to deliver near-zero emissions of nitrogen oxides (NO_x), a smog-causing pollutant and greenhouse gas. SCR's performance has been proved in millions of miles of real-world operation in other countries, as well as in long-term field tests in U.S.

SCR reduces NO_x emissions to very low levels, while at the same time delivering excellent fuel economy and reliability. The system doesn't change the design or operation of the basic engine. Rather, SCR is an aftertreatment system which converts NO_x in exhaust stream into harmless gases. Modern diesels already use exhaust aftertreatment systems, called diesel particulate filters, to control emissions of another pollutant, soot (also known as particulate matter or PM).

SCR works by injecting Diesel Exhaust Fluid (DEF) into the exhaust stream, after the DPF. DEF is a safe, simple solution of water and urea. DEF works with the heat of the exhaust and catalyst to convert NO_x into nitrogen and water vapor — two harmless and natural components of the air we breathe. The end result is cleaner air, excellent fuel efficiency and a reliable emissions control system for today's modern diesel engine.

The VOLVO SCR system is simple and effective, with few components. It consists of a Aftertreatment DEF tank plus a Aftertreatment DEF pump, Aftertreatment DEF dosing unit and SCR catalyst. The advantage of using DEF is that it enables the engine to use less EGR —and higher oxygen levels- for better combustion, while meeting EPA near-zero NOx emissions requirement of 0.2 g/hp-hr NOx. By using DEF, we avoid the disadvantages of increasing EGR to massive levels. This results in better fuel economy from your VOLVO engine.



W2055491



CAUTION

Do not put diesel fuel in the aftertreatment DEF tank. Diesel fuel, if sprayed into the hot exhaust along with the DEF, could ignite explosively causing a fire resulting in personal injury or damage to the exhaust system.

8 Exhaust Aftertreatment System

Instrument Cluster Icons

Aftertreatment icons are displayed on the instrument cluster. There are two aftertreatment icons.

- DPF Regeneration Required
- High Exhaust System Temperature (HEST)

The DPF Regeneration Required icon illuminates when the diesel particulate filter is becoming full and regeneration is needed.

The high Exhaust System Temperature icon illuminates when a parked regeneration is initiated. When the HEST icon is illuminated, do not park or operate the vehicle near people or any flammable materials, vapors and structures.

The icon flashes when the filter is full or overfull.

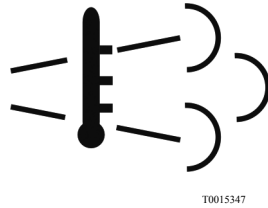
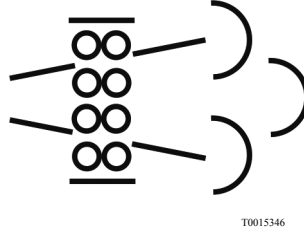

Operation

The stalk switch control lever is used to interact with the Driver Information Display (DID) in the center of the instrument cluster. The lever is located on the right-hand side of the steering wheel.

- 1 Esc or Escape button is used to return to the previous menu or display
- 2 ↵ or Enter button is used to display a list of menus, open a menu or select the highlighted area.

- 3 Up arrow button is used to scroll up through a menu
- 4 Down arrow button is used to scroll down through a menu.

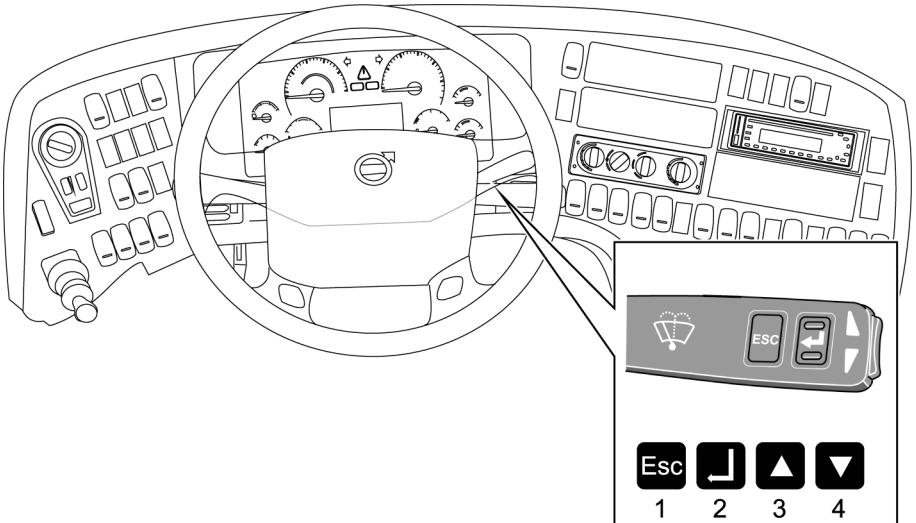

10 Exhaust Aftertreatment System

Aftertreatment Menu

- 1 The aftertreatment system (ATS) menu is in the DID.
- 2 Use the up and down buttons on the stalk switch to scroll to the Aftertreatment menu.
- 3 Press the ↵ button to select the ATS menu

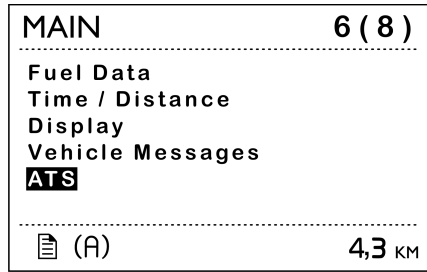

W2080635

The ATS menu has three submenus: Request regeneration, System status and ATS enable/disable.

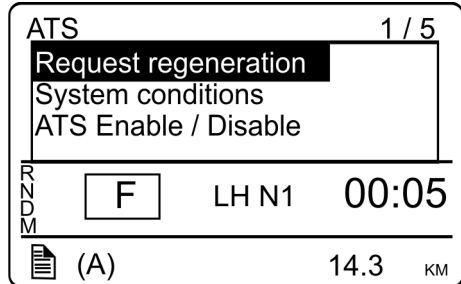

W2075117

DPF Regeneration



WARNING

Always ensure that the vehicle is in a safe and suitable location to withstand the high temperatures that occur during the generation process. Equipment damage or personal injury may occur if combustibles are too close to the exhaust pipe or outlet.

Note: If the vehicle is in a location that may be hazardous when regeneration begins, the regeneration should be stopped. If the regeneration is stopped by vehicle operator, it should be initiated at a later time when the

There are two types of regeneration:

- Passived, and

vehicle is in a safer location. Regenerations that are stopped and never restarted at a later time however, will require that the vehicle be taken to an authorized Volvo workshop (or for Prevost supported vehicles, a Prevost service center/provider) to have the regeneration manually started.



CAUTION

If the regeneration is cancelled by vehicle operator, it must be completed as soon as possible to avoid exhaust aftertreatment system damage.

- Parked

12 Exhaust Aftertreatment System

Passive regeneration only occurs when the vehicle is moving at uninterrupted highway speed. Parked regeneration is manually initiated when the vehicle is stationary. This is the standard configuration. Other configurations are available.

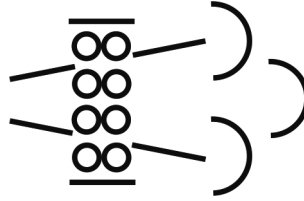

T0015346

If the regeneration process is not delayed, the regeneration process starts. The DPF Regeneration Required icon turns off and the High Exhaust System Temperature (HEST) icon may illuminate.

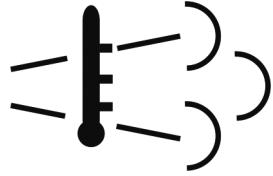

T0015347

To temporarily disable regeneration, scroll to the Aftertreatment menu in the DID, select “ATS Enable/Disable”. When regeneration is disabled, the letters ATS with X through them will be displayed in the DID. Enable regeneration by scrolling to the Aftertreatment menu, selecting “ATS enable/disable” and selecting “Enable regeneration”.

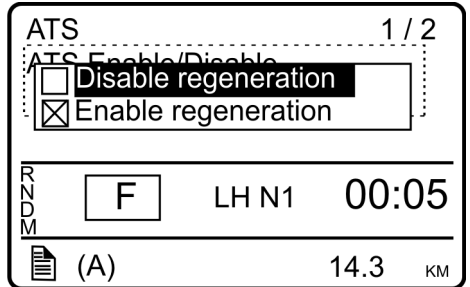

W2075110

14 Exhaust Aftertreatment System

Note: It is important to enable regeneration as soon as possible to avoid engine problems. Long-term engine operation with regeneration disabled will result in a loss of engine performance including horsepower, torque and speed derates. Also, the DPF filter will become overloaded with soot and require service.

The regeneration process can be stopped at any time by turning the ignition key to OFF, scrolling to the Aftertreatment menu in the Driver Information Display (DID)

and selecting “ATS enable/disable”, or by pressing the ↵ button on the stalk switch. Regeneration cannot be initiated if it is not required. The following conditions must be met to perform a parked regeneration:

- Parking brake on and transmission in neutral
- Minimum 10 volts battery charge
- Engine running
- Accelerator and clutch pedal released
- PTO not active

If a request for parked regeneration fails, “Regeneration failed. Check system conditions” is displayed. Scroll to the Aftertreatment menu in the Driver Information Display (DID) and select “System conditions” to determine why the regeneration failed.

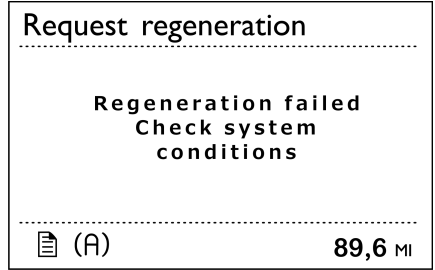

W2080636

If the DPF Regeneration icon is flashing, the diesel particulate filter is full. Maintain uninterrupted highway speed for a passive or move the vehicle to a safe location and initiate a parked regeneration.

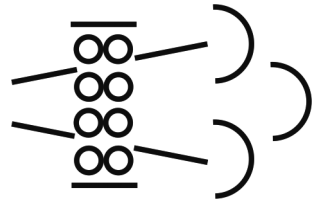

T0015346

If the Regeneration Required icon is flashing and the CHECK light illuminates, the diesel particulate filter is overfull. Engine performance will be limited. To avoid further engine derate, immediately move the vehicle to a safe location and initiate a parked regeneration, or take the vehicle to an authorized Volvo dealership (or for Prevost support vehicles, to a Prevost service center/provider).



T3014365

If the DPF Regeneration Required icon is flashing and the STOP light illuminates, a serious engine problem has occurred. The diesel particulate filter may be over its maximum capacity and the engine may shut down. The vehicle must be taken immediately to an authorized Volvo dealership (or for Prevost supported vehicles, to a Prevost service center/provider) for service.





T3014364

16 Exhaust Aftertreatment System







Aftertreatment DEF Tank Level — Driver Warning & Inducement

Aftertreatment DEF tanks are sized to have no less than two times the diesel fuel tank mileage.

The vehicle instrument cluster has an aftertreatment DEF tank level gauge.

Triggers	Aftertreatment DEF Tank Low Level Indicator	Driver Information Display Screen
100% to 12% Aftertreatment DEF Tank Level Gauge	None	None
<=12% Aftertreatment DEF Tank Level Gauge	 <p style="text-align: center; font-size: small;">W2029416</p> <p>Solid indicator</p>	Low DEF level Refill to avoid Engine derate
0% Aftertreatment DEF Tank Level Gauge (~1% DEF Remaining)	 <p style="text-align: center; font-size: small;">W2029415</p> <p>Blinking indicator</p>	DEF Tank Empty Engine in derate Refill to avoid 5 Mph
0% Aftertreatment DEF Tank Level Gauge AND either: <ol style="list-style-type: none"> 1 Vehicle stationary for 20 minutes, or 2 Diesel fuel Refueling > 15% with parking brake engaged. 	 <p style="text-align: center; font-size: small;">W2029415</p>	DEF tank empty Speed limited to 5 Mph

Aftertreatment DEF Quality — Driver Warning & Inducement

Triggers	Lamp Status	Driver Information Display Screen
Good DEF Quality	None	None
Poor DEF Quality DTC Initially Detected	 <small>W2029417</small>	SCR performance low Engine derate in < xxx mins
Poor DEF Quality DTC Initially Detected + 1 hour of operation	 <small>W2029417</small>	SCR performance low Engine derate in < xxx mins
Poor DEF Quality DTC Initially Detected +4 hours of operation	 <small>W2029417</small>	SCR performance low Engine in derate 5 Mph in < xxx mins
Poor DEF quality DTC initially detected + 4 hours of operation AND either: 1 Vehicle stationary for 20 minutes, or 2 Diesel Fuel Refueling > 15% with parking brake engaged	 <small>W2029417</small>	SCR Performance low Engine in derate 5 Mph at next stop
By means of 1 engine start or use of a service tool temporary exit from 8 Km/h (5 Mph) Inducement	 <small>W2029417</small>	SCR performance low Speed limited to 5 Mph
Ignition Key Cycle before DEF Quality Evaluation has been completed	 <small>W2029417</small>	SCR perf. check Engine in derate 5 Mph Limit removed

18 Exhaust Aftertreatment System

Exit conditions for DEF Quality “8Km/h (5 mph) road speed limit” Inducement:





Next 1 Engine Starts: Return to 25% torque reduction until there is a proper DEF quality evaluation. If poor DEF quality is detected during the next monitoring cycle then 8 Km/h (5 mph) is resumed after the vehicle is stationary for 20 minutes. After one engine start has been exhausted then a Tech Tool is required to exit the 8 Km/h (5 mph) road speed limit.

With Tech Tool DTC Clearing: Invoke 25% torque reduction until there is a proper DEF quality evaluation. If poor DEF Quality is detected during the next monitoring cycle then 8 Km/h (5 mph) is resumed after de vehicle is stationary for 20 minutes.





Aftertreatment Tampering — Driver Warning & Inducement

When the SCR tampering fault is active for one or more hours a new Driver Information Display screen appears. The text changes for the Driver Information Display (DID) screen associated with this fault are listed in the table below.

Note: Repeated acts of tampering will result in more severe inducement.

Triggers	Lamp Status	Driver Information Display Screen
No fault	None	None
<p>Tampering Fault Detect</p> <p>Note: For examples of various SCR sensor tampering types refer to the “SCR Tampering ” table below</p>	 <p style="text-align: center; font-size: small;">W2029417</p>	<p>SCR system fault Engine derate in < xxx mins</p>
<p>Second Drive Cycle with Active DTC.</p>	 <p style="text-align: center; font-size: small;">W2029417</p>  <p style="text-align: center; font-size: small;">W3031200</p>	<p>SCR System Fault Engine in derate 5Mph in <xxx mins</p>
<p>Driving with Active Fault for + 1 hour.</p>	 <p style="text-align: center; font-size: small;">W2029417</p>  <p style="text-align: center; font-size: small;">W3031200</p>	<p>SCR system fault Engine in derate 5 Mph in < mins</p>

20 Exhaust Aftertreatment System

<p>Driving with Active Fault for + 4 hours</p>	 <p style="text-align: center;">W2029417</p>  <p style="text-align: center;">W3031200</p>	<p>SCR system fault Engine in derate 5 Mph at next stop</p>
<p>Active tampering DTC initially detected + 4 hours of operation AND either:</p> <ol style="list-style-type: none"> 1 Vehicle stationary for 20 minutes, or 2 Diesel Fuel Refueling > 15% with parking brake engage 	 <p style="text-align: center;">W2029417</p>  <p style="text-align: center;">W3031200</p>	<p>SCR system fault Speed limited to 5 Mph.</p>

SCR Tampering

Aftertreatment Control Module (ACM)
Disconnected

Aftertreatment Inlet NOx Sensor
Disconnected

Aftertreatment Outlet NOx Sensor
Disconnected

DEF Pump Disconnected

DEF Dosing Valve Disconnected

DEF Tank Lever Sensor Disconnected

DEF Dosing valve or line blocked

DEF Pump pressure build up failure

DEF Return Line Blocked or Plugged

Note: For additional DID information refer to the Driver Information Display Manual.

Misfilling Diesel or Aftertreatment DEF Tanks

Although diesel fuel and Aftertreatment DEF caps are clearly labeled and filler necks and nozzles are different accidents can happen.

Contamination of fluids by- misfilling of diesel or DEF in the wrong tank may result in vehicle malfunction

Results of misfilling DEF in Diesel Tank

- Engine may run poorly or not at all
- Injectors may be damaged
- Exhaust system corrosion may occur between turbocharger and Aftertreatment DPF
- On Board Diagnostic (OBD) Diagnostic Trouble Codes (DTC)
- Costly repair

Results of misfilling diesel en Aftertreatment DEF Tank

- Aftertreatment SCR system may be damaged by Diesel
- SCR Catalyst may be damage by diesel (chemical damage)
- Emissions may be non-compliant
- On Board Diagnostic (OBD) Diagnostic Trouble Codes (DTC)
- Costly repairs

Aftertreatment System Maintenance

The vehicle must be taken to an authorized Volvo workshop (or for Prevost supported vehicles, to a Prevost service center/provider) to remove the ash from the diesel particulate filter and clean the aftertreatment fuel injector.

- The ash cleaning interval is 400 000 km (250,000 miles) or 4,500 hours, which ever occurs first.
- The aftertreatment fuel injector cleaning interval is 240 000 km (150,000 miles) or 4500 hours, which ever occurs first.

22 Exhaust Aftertreatment System

Aftertreatment System Conditions

When ATS System conditions is selected, the following submenus are available:

System conditions		1 (4)

Clutch Status	NA	▲
Engine Status	Check	
PTO Status	OK	▼

(A)		4,3 MI

W3079741

System conditions		2 (4)

Acc. Pedal	OK	▲
Gear Status	OK	
Vehicle Speed	OK	▼

(A)		4,3 MI

W3079742

System conditions		3 (4)

Park Brake	OK	▲
System Fault	OK	
Perm System Lockout	OK	▼

(A)		4,3 MI

W3079743

System conditions		4 (4)

Temp System Lockout	Check	▲
Inhibit Switch	OK	

(A)		4,3 MI

W3079744

Diesel Exhaust Fluid (DEF)

Diesel Exhaust Fluid (DEF) is a reactant that's key to the SCR process. It's nontoxic, aqueous solution of 32.5% urea and 67.5% water. Urea is a compound of nitrogen that turns to ammonia when heated. It is used in a variety of industries, perhaps most commonly

as fertilizer in agriculture. The fluid is not flammable, nor is it dangerous when handled normally. However, it is corrosive to metal, particularly copper or aluminium. Read the separate section concerning the handling of DEF solution.

Diesel Exhaust Fluid (DEF) Handling

When handling DEF solution, it is important that electrical connectors to be connected or well encapsulated. Otherwise there is a risk that the DEF will cause oxidation that cannot be removed. Water or compressed air do not help, since DEF quickly oxidizes metal. If a

connector comes into contact with the DEF solution it must be replaced immediately to prevent the DEF solution from creeping further into the copper wiring, which takes place at a speed of about 60 mm (2.4 in) per hour.



CAUTION

When detaching hoses and components, do not spill DEF on disconnected connectors. If DEF is spilled on a connector, the connector must be replaced immediately.

24 Exhaust Aftertreatment System

About spilled Diesel Exhaust Fluid (DEF)

Things to know about spilled Diesel Exhaust Fluid (DEF)

- If urea solution comes into contact with the skin, rinse with plenty of water and remove contaminated clothing.
- If urea solution comes into contact with eyes rinse for several minutes and call for medical help if necessary
- If inhaled breathe fresh air and call for medical help if necessary
- Do not allow the DEF solution to come into contact with other chemicals
- The DEF solution is not flammable. If the DEF solution is exposed to high temperatures for long periods of time, it breaks down into ammonia and carbon dioxide
- The DEF solution is corrosive to certain metals, including copper and aluminium. This is similar to the corrosion caused by salt water
- If the DEF solution is spilled onto the vehicle, wipe off the excess and rinse with water. Spilled DEF solution can form concentrated white crystals on the vehicle. Rinse off these crystals with water.

Note: Do not flush DEF into the normal drain system.



WARNING

DEF split onto hot components will quickly vaporize. Turn your face away!

Warranty and Maintenance

Exhaust Aftertreatment System Maintenance

The vehicle must be taken to an authorized Prevost Service Center to remove the ash from the Aftertreatment Diesel Particulate Filter and clean the Aftertreatment Doser.

Emissions Maintenance

1. If owner's manual recommends Aftertreatment DPF replacement within useful life, the manufacturer must pay for the replacement; however, a random failure within the useful life is covered only per the above warranty provisions.
2. First maintenance interval in life of the engine is allowed at 160 000 kilometers (100,000 miles), 3000 hours.

26 Exhaust Aftertreatment System

Engine Gaseous Emission Control Systems

WARRANTY MAINTENANCE

GASEOUS EMISSION CONTROL SYSTEMS WARRANTY

Prevost warrants the Emission Control Systems on each new VOLVO diesel engine in a new Prevost coach to comply with all United States Federal and Canadian emissions regulations applicable at the time of manufacture of the engine, and to be free from defects in material and workmanship under normal use and service up to 60 months, or 100,000 miles, whichever occurs first, provided all Prevost, maintenance requirements are followed as described in this manual. All warranty periods are calculated from the date-in-service of the new vehicle. The repair or replacement of defective parts will be made without charge for the cost of parts and, if repairs are made at an authorized Prevost Service Center, there will be no charge for labor. Prevost's obligation under this warranty is limited to the repair or replacement, at Prevost's option, of any part(s) of the Emission Control Systems of such engine and/or vehicle found to be defective upon examination by Prevost and provided that such part(s) were returned to Prevost or its nearest authorized Service Center within a reasonable period of time.

Qualifications and Limitations:

Note: Not covered by the Emissions Control Systems Warranty:

- Malfunctions caused by misuse, improper adjustments, modification, alteration, tampering, disconnection, improper or inadequate maintenance and use of improper diesel fuel or DEF.
- Damage resulting from accident, acts of nature or other events beyond the control of Prevost.
- Inconvenience, loss of use of the vehicle, commercial loss of any kind including, but not limited to, consequential or incidental damages
- Any vehicle in which the odometer has been altered or damaged so that mileage cannot be readily determined.

THIS WARRANTY IS EXPRESSLY IN LIEU OF ALL OTHER WARRANTIES AND REPRESENTATIONS OR CONDITIONS, STATUTORY OR OTHERWISE, EXPRESSED OR IMPLIED INCLUDING, BUT NOT LIMITED TO, IMPLIED WARRANTY OF MERCHANTABILITY OR FITNESS FOR A PARTICULAR PURPOSE.

Emissions Control System Warranty

The following engine components are covered by the supplemental emissions control system warranty policy as required by the Federal code of emission regulations.

- 1 Engine Turbocharger Assembly
 - Engine VGT Actuator
 - 2 Engine Charge Air Cooler (CAC)
 - CAC Pipes (Air inlet to/from CAC)
 - CAC Hoses
 - 3 Engine Control Module (ECM)
 - 4 Engine Injectors
 - 5 Engine and Vehicle Wire harness (repair to circuits related to Emissions Warrantable Components)
 - 6 Exhaust Gas Recirculation (EGR) Mixer Tube
 - 7 EGR Cooler
 - 8 EGR Valve and EGR Valve Control
 - 9 EGR Pipes - Engine Exhaust Manifold to EGR Cooler
 - 10 EGR Pipes - EGR Cooler to Inlet Manifold
 - 11 Crankcase Breather (CCB)
 - 12 Crankcase Breather Oil Separator
 - 13 Crankcase Tubing and Hoses before CCB Oil Separator
 - 14 Aftertreatment Wiring Harness
 - 15 Aftertreatment Control Module (ACM)
 - 16 Aftertreatment Diesel Particulate Filter (DPF) Assembly
 - A. Aftertreatment DPF Assembly with Aftertreatment Diesel Oxidation Catalyst (DOC)
 - Aftertreatment Hydrocarbon Doser (HCD)
 - Diffuser Pipe (Aftertreatment Hydrocarbon Doser Mounting)
 - Fuel lines to Aftertreatment Hydrocarbon Doser
 - Aftertreatment Fuel Shutoff Valve
 - Aftertreatment Fuel Pressure Sensor
 - Discharge Recirculation Valve (DRV) (Heat Mode)
 - Discharge Recirculation Valve (DRV) Solenoid
 - Engine Turbocharger Compressor Bypass Actuator (Heat Mode)
 - Engine Turbocharger Compressor Bypass Actuator Solenoid
 - Engine Exhaust Gas Temperature (EGT) Sensor
 - Aftertreatment DPF Intake Temperature Sensor
 - Aftertreatment DPF Outlet Temperature Sensor
 - Aftertreatment DPF Differential Pressure Sensor
 - Aftertreatment Hydrocarbon Doser Air Supply Regulator (if applicable), Supply Lines, and Fittings
- 17 Sensors:
- Crankshaft Position (CKP) Sensor
 - Camshaft Position (CMP) Sensor
 - Engine Coolant Temperature (ECT) Sensor
 - Intake Manifold Air Temperature/Pressure Sensor
 - EGR Temperature Sensor
 - Aftertreatment Outlet NOx Sensor
 - Aftertreatment Intake NOx Sensor
 - EGR Differential Pressure
 - Ambient Air Temperature (AAT)
- 18 SCR

28 Exhaust Aftertreatment System

- Aftertreatment Selective Catalytic Reduction (SCR) Catalyst
 - Aftertreatment Diesel Exhaust Fluid (DEF) Pump
 - Aftertreatment DEF Dosing Absolute Pressure Sensor
 - Aftertreatment DEF Return Valve
 - Aftertreatment DEF Dosing Valve
 - Aftertreatment DEF Tank
 - Aftertreatment DEF Tank Heater/Sender
 - Aftertreatment DEF Tank Heater
 - Aftertreatment DEF Tank Heater Valve
 - Aftertreatment DEF Tank Temperature Sensor
 - Aftertreatment DEF Level Sensor
 - Aftertreatment DEF Heated Lines
19. Instrument Cluster (Repair of microprocessor , OBD MIL, Real Time Clock, Aftertreatment DEF Tank Gauge and, Aftertreatment DEF Tank Low Level Indicator)
 20. Exhaust Gas Piping (from Turbocharger to Aftertreatment System)
 21. Data Link Connector (DLC)

Engine Gaseous Emissions Control System Warranty

The emission warranty for the diesel particulate filter and SCR Systems covers defects in workmanship only. Normal maintenance, such as cleaning ash from the filter at regular maintenance intervals and cleaning the Aftertreatment fuel injector on Diesel Oxidation Catalyst (DOC) DPF systems, is not covered by the emission warranty. With the Thermal Regeneration DPF system, cleaning the ignition electrodes and fuel injection nozzle at the regular maintenance intervals is considered normal maintenance and not covered by the emission warranty.

Federal Emission Requirements

This section covers the requirement of the United States Clean Air Act which states: “The manufacturer shall furnish with each new motor vehicle or motor vehicle engine such written instructions for the maintenance and use of the vehicle or engine by the ultimate purchaser as may be reasonable and necessary to assure the proper functioning of emission control devices and systems. ”This section also covers the requirements of the emissions regulations promulgated under the Motor Vehicle Safety Act in Canada.

TAMPERING WITH GASEOUS EMISSION CONTROL SYSTEMS PROHIBITED

The Federal Clean Air Act prohibits the removal or rendering inoperative of any device or element of design installed on or in a motor vehicle or motor vehicle engine in compliance with Federal Emission Regulations by:

- 1 Any person prior to its sale and delivery to the ultimate purchaser, or
- 2 Any manufacturer or distributor after its sale and delivery to the ultimate purchaser, or
- 3 Any person engaged in the business of repairing, servicing, selling, leasing, or trading motor vehicles or motor vehicle engines following its sale and delivery to the ultimate purchaser, or
- 4 Any person who operates a fleet of motor vehicles following its sale and delivery to the ultimate purchaser.

Emission Control System Warranty — California

The California Air Resources Board and Prevest. are pleased to explain the California emission control system warranty on your new motor vehicle engine. In California, new motor vehicle engines must be designed, built and equipped to meet the State's stringent anti-smog standards. Prevest. must warrant the emission control system on your engine for the period of time listed below provided there has been no abuse, neglect, or improper maintenance of your engine. Your emission control system may include parts such as the fuel-injection system, turbocharger assembly, electronic control module and other emission-related assemblies.

Where a warrantable condition exists, Prevest will repair your engine at no cost to you including diagnosis, parts, and labor. **MANUFACTURER'S WARRANTY COVERAGE:** If an emission-related part of your engine is defective, the part will be repaired or replaced by Prevest. This is your emission control system DEFECTS WARRANTY.

30 Exhaust Aftertreatment System

OWNER'S WARRANTY RESPONSIBILITIES:

As the motor vehicle engine owner, you are responsible for the performance of the required maintenance listed in this manual. Prevost recommends that you retain all receipts covering maintenance of your vehicle, but Prevost cannot deny warranty solely for the lack of receipts or for your failure to ensure the performance of all scheduled maintenance listed in other manuals which were supplied with your vehicle. You are responsible for presenting your motor vehicle engine to a Prevost Service Center as soon as a problem exists. The warranty repairs should be completed in a reasonable amount of time, not to exceed 30 days. As the motor vehicle engine owner, you should also be aware that Prevost may deny you warranty coverage if your vehicle or a part has failed due to abuse, neglect, improper maintenance, or unapproved modifications. If you have any questions regarding your warranty rights and responsibilities, you should contact the Prevost Department 850 Chemin Olivier, St-Nicolas, Qc, G7A 2N1, Canada, Fax 418-831-9301, or the California Air Resources Board at 9480 Telstar Avenue, El Monte, California 91731. **(Applicable only to vehicles and/or engines certified for sale and registered in the State of California)** Prevost warrants the Emission Control Systems on each new VOLVO diesel engine in a new Prevost coach to comply with all State of California emissions regulations applicable at the time of manufacture of the engine, and to be free from defects in material and workmanship under normal use and service up to 60 months or 160 000 km (100,000 miles), whichever occurs first, provided all Prevost maintenance requirements are followed as described in this manual. All warranty periods are calculated from the date-in-service of the new vehicle. The repair or replacement of defective parts will be made without charge for the cost of parts and, if repairs are made at an authorized Prevost Service Center, there will be no charge for labor. Prevost's obligation under this warranty is limited to the repair or replacement, at Prevost's option, of any part(s) of Emission Control Systems of such engine and/or vehicle found to be defective upon examination by Prevost and provided that such part(s) were returned to Prevost or its nearest authorized Dealer within a reasonable period of time.

Qualifications and Limitations:

Not covered by the Emissions Control Systems Warranty:

- Malfunctions caused by misuse, improper adjustments, modification, alteration, tampering, disconnection, improper or inadequate maintenance and use of improper diesel fuel or DEF.
- Damage resulting from accident, acts of nature or other events beyond the control of Prevost
- Inconvenience, loss of use of the vehicle, commercial loss of any kind including, but not limited to, consequential or incidental damages.
- Any vehicle in which the odometer has been altered or damaged so that mileage cannot be readily determined.

THIS WARRANTY IS EXPRESSLY IN LIEU OF ALL OTHER WARRANTIES AND REPRESENTATIONS OR CONDITIONS, STATUTORY OR OTHERWISE, EXPRESSED OR IMPLIED INCLUDING, BUT NOT LIMITED TO, IMPLIED WARRANTY OF MERCHANTABILITY OR FITNESS FOR A PARTICULAR PURPOSE.

32 Exhaust Aftertreatment System

Emissions Control System Warranty

The following engine components are covered by the supplemental emissions control system warranty policy as required by the California code of regulations.

- 1 Engine Turbocharger Assembly
 - Engine VGT Actuator
- 2 Engine Charge Air Cooler (CAC)
 - CAC Pipes (Air inlet to/from CAC)
 - CAC Hoses
- 3 Engine Control Module (ECM)
- 4 Engine Injectors
- 5 Engine and Vehicle Wire harness (repair to circuits related to Emissions Warrantable Components)
- 6 Exhaust Gas Recirculation (EGR) Mixer Tube
- 7 EGR Cooler
- 8 EGR Valve and EGR Valve Control
- 9 EGR Pipes - Engine Exhaust Manifold to EGR Cooler
- 10 EGR Pipes - EGR Cooler to Inlet Manifold
- 11 Crankcase Breather
- 12 Engine Crankcase Breather Oil Separator
- 13 Crankcase Tubing and Hoses before Separator
- 14 Aftertreatment Wiring Harness
- 15 Aftertreatment Control Module (ACM)
- 16 Aftertreatment Diesel Particulate Filter (DPF) Assembly
 - A. Aftertreatment DPF Assembly with Aftertreatment Diesel Oxidation Catalyst (DOC)
 - Aftertreatment Hydrocarbon Doser (HCD)
 - Diffuser Pipe (Aftertreatment Hydrocarbon Doser Mounting)
 - Fuel lines to Aftertreatment Hydrocarbon Doser
 - Aftertreatment Fuel Shutoff Valve
 - Aftertreatment Fuel Pressure Sensor
 - Discharge Recirculation Valve (DRV) (Heat Mode)
 - Discharge Recirculation Valve (DRV) Solenoid
 - Engine Turbocharger Compressor Bypass Actuator (Heat Mode)
 - Engine Turbocharger Compressor Bypass Actuator Solenoid
 - Engine Exhaust Gas Temperature (EGT) Sensor
 - Aftertreatment DPF Intake Temperature Sensor
 - Aftertreatment DPF Outlet Temperature Sensor
 - Aftertreatment DPF Differential Pressure Sensor
 - Aftertreatment Hydrocarbon Doser Air Supply Regulator (if applicable), Supply Lines and Fittings

17 Sensors:

- Crankshaft Position (CKP) Sensor
- Camshaft Position (CMP) Sensor
- Engine Coolant Temperature (ECT) Sensor
- Intake Manifold Air Temperature/Pressure Sensor
- EGR Temperature Sensor
- Aftertreatment Outlet NOx Sensor
- Aftertreatment Intake NOx Sensor
- EGR Differential Pressure Sensor
- Ambient Air Temperature (AAT) Sensor

18 SCR

- Aftertreatment Selective Catalytic Reduction (SCR) Catalyst
- Aftertreatment Diesel Exhaust Fluid (DEF) Pump
 - Aftertreatment DEF Dosing Absolute Pressure Sensor

- Aftertreatment DEF Return Valve
- Aftertreatment DEF Dosing Valve
- Aftertreatment DEF Tank
- Aftertreatment DEF Tank Heater/Sender
- Aftertreatment DEF Tank Heater
- Aftertreatment DEF Tank Heater Valve
- Aftertreatment DEF Tank Temperature Sensor
- Aftertreatment DEF Level Sensor
- Aftertreatment DEF Heated Lines

19. Instrument Cluster (Repair of microprocessor , OBD MIL, Real Time Clock, Aftertreatment DEF Tank Gauge and, Aftertreatment DEF Tank Low Level Indicator)

20. Exhaust Gas Piping (from Turbocharger to Aftertreatment System)

21. Data Link Connector (DLC)

34 Exhaust Aftertreatment System

Engine Components, Service Schedules

Component	Operation	Km (Miles)/Maximum Months/Hours
Engine Fuel Filter	Change	Each oil change *
Water Separator	Filter change	Each oil change *
Air Filter US 2010	Change	160 000 (100,000) or 12 months, whichever comes first
Engine Coolant	Change	500 000 (300, 000) or 24 months, whichever comes first
Engine Coolant (ELC)	Change	1 000 000 (600,000) or 48 months, whichever comes first
Coolant Filter US 2010	Change	80 000 (50,000) or 6 months, whichever comes first
Engine Coolant Filter (ELC) US 2010	Change	240 000 (150,000) or 12 months, whichever comes first
Valves/Engine Injectors **	Initial Adjust	200 000 (125,000) or 12 months, whichever comes first
Valves/Engine Injectors **	Adjust	400 000 (250,000) or 24 months, whichever comes first
Catalyzed DPF Filter (If equipped)	Change	400 000 (250,000) or 4,500 hours, whichever comes first.
Aftertreatment Diesel Exhaust Fluid Dosing Valve	Clean	240 000 (150,000) or 4,500 hours, whichever comes first.
Aftertreatment Diesel Exhaust Fluid (DEF) Pump Filter	Change	First Change; 161 000 (100,000), 3200 hours or three (3) years. Then every 241 000 (150,000) 4800 hours or three (3) years, whichever comes first.
Diesel Exhaust Fluid (DEF) Tank Filler Neck Filter Cleaning	Clean	280 000 (175,000) or 12 months, whichever comes first.

*Under certain conditions (for example, irregular fuel quality), the fuel/water separator filters may require more frequent replacement.

**Valves must be adjusted whenever the rocker shaft has been removed and reinstalled for any reason.

VOLVO

Volvo Bus Corporation

Göteborg, Sweden

Driver's Handbook

**VOLVO D13H Engine Operator's
Manual**

PREVH, PREVX

VOLVO

Foreword

This manual contains information concerning the safe operation of your vehicle. It is extremely important that this information is read and understood before the vehicle is operated. This manual also contains a considerable amount of information concerning the vehicle, such as vehicle identification, Preventive Maintenance recommendations and a log for your service records. Please keep this in the vehicle at all times. Information from other component manufacturers is supplied in separate manuals in the Owners Package.

Illustrations in this manual are used for reference only and may differ slightly from the actual vehicle. However, key components addressed in this document are represented as accurately as possible.

The National Highway Traffic Safety Administration (NHTSA) and Prevost should be informed immediately if you believe that the vehicle has a defect that could cause a crash, injury or death.

Contact NHTSA by calling the Auto Safety Hotline at 1(888) 327-4236, by writing to NHTSA, U.S Department of Transportation, Washington, DC 20590, by TTY at 1 (800) 424-9153, or visit their web site at <http://www.safercar.gov>

Volvo Bus Corporation

Göteborg, Sweden

Order number: 89134337

©2013 Volvo Bus Corporation, Göteborg, Sweden

All rights reserved. No part of this publication may be reproduced, stored in retrieval system, or transmitted in any forms by any means, electronic, mechanical, photocopying, recording or otherwise, without the prior written permission of Volvo Bus Corporation

Contents

VOLVO Engines	1
Information For the Owner	1
General	3
Federal Emission Requirements	4
Tampering with exhaust emission control systems Prohibited	5
Noise Emissions	5
Safety Information	11
Proper Maintenance Procedure	11
During Maintenance.....	13
Compressed Air and Water	14
Asbestos Information	14
Fluid Penetration.....	14
Injury Prevention	15
Burn Prevention	15
Fire or Explosion Prevention	17
Engine Damage Prevention.....	23
Before Starting the Engine.....	23
Engine Starting.....	23
Electric and Electronic Systems.....	25
Reporting Safety Defects	26
USA.....	26
Canada.....	27
On-Call Assistance.....	27
Introduction.....	27
Fuel	28
Engine Oil	29
Engine Operation	30
Engine Overview, D13H Left Side View.....	32
Engine Overview, D13H Right Side View	33
Exhaust Emissions and Aftertreatment Diesel Particulate Filters (DPFs).....	34
Exhaust Aftertreatment System	36
DPF Systems	38
Selective Catalytic Reduction (SCR)	39
Aftertreatment Hydrocarbon Dosing System.....	42
Diesel Exhaust Fluid (DEF).....	43
Aftertreatment Control Module (ACM).....	45
Smart NOx Sensor	46
Aftertreatment Inducement Screens.....	48
Aftertreatment DEF Tank Level - Driver Warning & Inducement.....	48
Aftertreatment DEF Quality - Driver Warning & Inducement	49
Aftertreatment Tampering - Driver Warning & Inducement	51
Misfilling Diesel or Aftertreatment DEF Tanks.....	54
Warranty and Maintenance	54
Exhaust Aftertreatment System Maintenance.....	54
Emissions Maintenance	55

Engine Maintenance Intervals.....	56
Engine Gaseous Emission Control Systems	56
Emissions Control System Warranty	57
Engine Gaseous Emissions Control System Warranty	58
Federal Emission Requirements	58
Emission Control System Warranty — California.....	59
Emissions Control System Warranty	62
Emission Green House Gas Component Warranty (If Equipped)	64
Engine Brake.....	65
Engine Components, Service Schedules.....	66
Cooling System.....	67
General Coolant Information.....	67
Regular Coolant Change Interval.....	70
Extended Life Coolant Change Interval	70

Safety Information

IMPORTANT: Before driving this vehicle, be certain that you have read and that you fully understand each and every step of the driving and handling information in this manual. Be certain that you fully understand and follow all safety warnings.

IT IS IMPORTANT THAT THE FOLLOWING INFORMATION BE READ, UNDERSTOOD AND ALWAYS FOLLOWED.

The following types of advisories are used throughout this manual:



DANGER

Danger indicates an unsafe practice that could result in serious personal injury or death. A danger advisory banner is in **white** type on a **black** background with a **black** border.



WARNING

Warning indicates an unsafe practice that could result in personal injury. A warning advisory banner is in **black** type on a **gray** background with a **black** border.



CAUTION

Caution indicates an unsafe practice that could result in damage to the product. A caution advisory is in **black** type on a **white** background with a **black** border.

Note: Note indicates a procedure, practice, or condition that must be followed in order for the vehicle or component to function in the manner intended.

Information For the Owner

If there are questions on the maintenance and performance of your vehicle, please discuss them with your Prevost Service Manager or Prevost Service Center. Your authorized Prevost Service Center is required to have trained mechanics, special tools and spare parts to fully service your vehicle.

In addition to this Operator's Manual, there may be additional instruction/operators manuals supplied by component manufacturers. These manuals are placed in the Owners Package and placed in the vehicle. Be sure to read all the manuals thoroughly before operating the vehicle.

Also, various safety labels may be placed on components by the component manufacturer. Be sure to read and follow these labels to prevent damage to the vehicle, personal injury or even death.

Information in this manual refers to VOLVO components and VOLVO drivetrain. For detailed information on non-VOLVO drivetrains contact your nearest Prevost Service Center.

Establish a Preventive Maintenance Program with the help of your Prevost Service Center/ Provider. A Preventive Maintenance Program makes it possible to maximize the amount of time your vehicle is up and running, resulting in longer component life. This makes for a safer vehicle by reducing any mechanical failures due to poor maintenance practices.

Note: Federal law requires manufacturers to notify owners of its products in the event of a Federal Motor Vehicle Safety Standard or if a safety related defect is discovered. If you are not the original owner of this vehicle, please notify us about the change in ownership at the address below or through an authorized Prevost Service Center. This is the only way we will be able to contact you if necessary.

Prevost Warranty Departement
850 Chemin Olivier
St-Nicolas, Qc
G7A 2N1
Canada
Fax: 418-831-930

2 VOLVO Engines

This Operator's Manual covers all VOLVO vehicles manufactured by Prevost or Volvo Bus, including the whole chassis and all VOLVO manufactured components. For specific maintenance information on vendor components, manufactured by, for example: Fuller, Meritor, etc., see the respective manufacturers service and maintenance literature.

This manual, together with manuals for specific components contain important information to be able to operate this vehicle safely. They contain advice and instructions which will enable you to get the operating economy and performance that you expect from this quality vehicle.

All information, illustrations and specifications contained in this manual are based upon the latest product information available at the time of publication. If any questions arise concerning the current status of Federal or state laws, the appropriate Federal or state agency should be contacted.

Note: Illustrations are used for reference only and may differ slightly from the actual vehicle, however, key components addressed in this manual are represented as accurately as possible.

VOLVO Bus Corporation reserves the right to make changes at any time or to change specifications or design without notice and without incurring obligation.

General

USA

USA

The Federal Clean Air Act, Section 203 (a) (3), states the following concerning the removal of air pollution control devices or modification of a certified engine to a non-certified configuration:

CAA, Section (a) (3) (A) prohibits any person from removing or rendering inoperative any emission control device or element of design installed on or in a motor vehicle or motor vehicle engine in compliance with federal regulations under the Clean Air Act prior to the sale and delivery of the vehicle to the ultimate purchaser. The statute also prohibits any person from knowingly removing or rendering inoperative any emission control device or element of design after sale and delivery of a vehicle or engine to the ultimate purchaser. Any person who violates these provisions either by removing or rendering inoperative emissions control devices prior to the sale or delivery of an engine or vehicle to an ultimate purchaser, or by knowingly removing or rendering inoperative such devices after the sale and delivery of an engine or vehicle to an ultimate purchaser, can be subject to penalties of up to \$3,750 per incident. Any dealer or manufacturer who violates these provisions can be subject to penalties of up to \$37,500 per incident.

Canada

The same conditions that apply in the USA apply to Canada, with one exception. After the vehicle is sold to a retail customer, that is, the end user, the jurisdiction controlling the emission control devices becomes the province in which the vehicle is licensed. No changes should be made that render any or all of the devices inoperative.

Should the owner/operator wish to make any changes to the emission control devices, check with the provincial authority before making any such changes.

Mexico

The same conditions that apply in the USA apply to Mexico. Refer to the Mexican Federal Law for Emission Control which adheres to EPA regulations. No changes should be made that render any or all of the emissions control devices inoperative.

Should the owner/operator wish to make any changes to the emission control devices, check with the state authority before making any such changes.

4 VOLVO Engines

Federal Emission Requirements

This section covers the requirement of the United States Clean Air Act which states:

The manufacturer shall furnish with each new motor vehicle or motor vehicle engine such written instructions for the maintenance and use of the vehicle or engine by the ultimate purchaser as may be reasonable and necessary to assure the proper functioning of emission control devices and systems.

This section also covers the requirements of the emissions regulations promulgated under the Motor Vehicle Safety Act in Canada.

Tampering with exhaust emission control systems Prohibited

The Federal Clean Air Act prohibits the removal or rendering inoperative of any device or element of design installed on or in a motor vehicle or motor vehicle engine in compliance with Federal Emission Regulations by:

- 1 Any person prior to its sale and delivery to the ultimate purchaser, or
- 2 Any manufacturer or distributor after its sale and delivery to the ultimate purchaser, or
- 3 Any person engaged in the business of repairing, servicing, selling, leasing, or trading motor vehicles or motor vehicle engines following its sale and delivery to the ultimate purchaser, or
- 4 Any person who operates a fleet of motor vehicles following its sale and delivery to the ultimate purchaser.

Note: For specifics of the prohibited vehicle/engine modifications refer to the Volvo Bus or Prevest documentation.

Noise Emissions

Prevest warrants to the first person who purchases this vehicle for purposes other than resale and to each subsequent purchaser, that this vehicle as manufactured by Prevest was designed, built and equipped to conform, at the time it left the control of Prevest, with all applicable U.S. EPA Noise Control Regulations.

This warranty covers this vehicle as designed, built and equipped by Prevest, and is not limited to any particular part, component or system of the vehicle manufactured by Prevest Defects in design, assembly or in any part, component or system of the vehicle as manufactured by Prevest, which, at the time it left the control of Prevest caused noise emissions to exceed Federal standards, are covered by this warranty for the life of the vehicle.

6 VOLVO Engines

Noise Control System, Operator Inspection and Maintenance Requirements

A Noise Control System Maintenance Log is located in this manual. This log should be used to document all Noise Control System related maintenance, whether the maintenance results from a specific noise control system inspection, or a deficiency identified during another general maintenance event.

If additional log space is needed, further entries may be added on a separate sheet of paper. Store these additions with the main log to preserve a comprehensive record. It is recommended that copies of all noise emissions related maintenance invoices be retained.

The following Noise Control System inspection and maintenance instructions contain suggested maintenance intervals. These intervals may need adjustment in order to best accommodate the specific vehicle usage. The following instructions only concern Noise Emissions related items and do not address or modify any general vehicle maintenance requirements.

The following elements make up the Noise Control System:

- Noise Shielding and Insulation Devices
- Cooling System
- Exhaust System/DPF System
- Air Intake/Air Induction System
- Engine Control, EGR and Fuel Systems
- Selective Catalytic Reduction (SCR)

Tampering with Noise Control System

Federal law prohibits the following acts or the causing thereof:

(1) The removal or rendering inoperative by any person, other than for purposes of maintenance, repair, or replacement, of any device or element of design incorporated into any new vehicle for the purpose of noise control prior to its sale or delivery to the ultimate purchaser or while it is in use;

or

(2) the use of the vehicle after such device or element of design has been removed or rendered inoperative by any person.

Among the acts that constitute tampering are the acts listed below:

- Removal, or rendering inoperative, of any exhaust components, including mufflers, heavy or double-wall exhaust tubing, flexible tubing or exhaust pipe clamping.
- Removal, or rendering inoperative, of the temperature-modulated cooling fan system.
- Removal of the cooling fan shroud.
- Removal, or rendering inoperative, of the air cleaner or air intake in-line silencer.
- Removal or rendering inoperative any vehicle body mounted sound insulation components.
- Removal, or rendering inoperative, of the engine speed governor so as to allow engine speed to exceed the manufacturers specifications.
- Removal of splash shields located inside the wheel housings.
- Removal of engine block shields.
- Removal of engine crankcase shields or insulation.
- Removal of insulated rocker arm covers.
- Removal of transmission noise shields.

Noise Shielding and Insulation Devices

Maintenance

Ensure sound shielding and insulating devices are intact. Inspect components for damage. Primary system components requiring noise related inspection include the engine compartment insulating materials (including engine covers, hatches insulation) wheel housings, fenders, and body panels. Inspect all related fasteners, brackets, and clamps for damage and tightness.

8 VOLVO Engines

Regulatory Compliance

Acts that constitute tampering with the Noise Shielding and Insulation Devices:

Removing or rendering inoperative the engine and/or transmission noise deadening panels, shields or insulating materials.

Removing or rendering inoperative any vehicle body mounted sound insulation components and/or shields (fender shields, skirts, wheel housing splash shields, etc.).

Cooling System



WARNING

DO NOT work near the fan with the engine running or the ignition in the ON position. The engine fan can engage at any time without warning. Anyone near the fan when it turns on could be seriously injured.

Maintenance

Visually inspect cooling system components for damage, and/or misalignment.

Primary system components requiring noise related inspection include fan blades, fan clutch, fan shroud, fan ring, and recirculation shields. Check fan blades, fan ring, fan shroud, belt tensioner and recirculation shields for any damage. Verify that fan blades clear the fan ring. Inspect all related fasteners, brackets, and clamps for damage and tightness. Confirm operation of temperature modulated fan clutch.

Regulatory Compliance

Acts that constitute tampering with the Cooling System:

Removing or rendering inoperative cooling system components (such as the temperature modulated fan clutch, fan shroud, fan ring, recirculation shields, etc.).

Exhaust System

**WARNING**

Hot engine! Avoid all movable parts or hot engine parts, exhaust gases, and/or fluids. A hot engine, exhaust, and/or fluids can cause burns.

Maintenance

Make sure the exhaust system is intact. Inspect for damage, misalignment and/or leakage. Primary system components requiring noise related inspection include exhaust manifold, turbocharger, and all exhaust system (rigid and flexible) piping. Closely check the system for exhaust leaks. Special attention should be given to all welds, seams, gaskets, support points, clamps, couplings and connections.

Inspect all exhaust system fasteners, brackets, and clamps for damage and tightness.

Regulatory Compliance

Acts that constitute tampering with the Exhaust System:

Removing or rendering inoperative exhaust system components (such as the pipes, clamps, etc.).

Air Intake/Air Induction System

Maintenance

Make sure the air intake system is intact. Inspect components for damage, misalignment and/or leakage. Primary system components requiring noise related inspection include the air cleaner housing, air cleaner element, turbocharger, charge air cooler and intake manifold.

Also inspect all ducts, pipes, hoses, tubing and elbows used to interconnect the system. Special attention should be given to all welds, seams, gaskets, support points, clamps, couplings and connections.

Inspect all intake system fasteners, brackets, and clamps for damage and tightness.

10 VOLVO Engines

Regulatory Compliance

Acts that constitute tampering with the Air Intake/Air Induction System:

Removing or rendering inoperative air intake/induction system components (filter, filter housings, ducts, etc.).

Engine Control, EGR and Fuel Systems

Acts that constitute tampering with Engine Control, EGR and Fuel Systems:

Removing rendering inoperative, or modifying the engine control system such as the ECU, EGR system components, or fuel system components, in order to allow the engine to operate outside of the manufacturers specifications is not allowed and violates both warranty and legislation.

Safety Information

Proper Maintenance Procedure



DANGER

Before working on a vehicle, set the parking brakes, place the transmission in neutral, and chock the wheels. Failure to do so can result in unexpected vehicle movement and can cause serious personal injury or death.



DANGER

Exhaust gases contain carbon monoxide. Always run the engine outdoors or use a properly vented exhaust hose. Prolonged or excessive exposure may cause serious illness or death.



DANGER

Never operate the engine in an area where hydrocarbon vapors (gasoline, for example) are present or are suspected to be present. Hydrocarbon vapors can enter the air intake and over speed the engine, causing severe engine damage and/or an explosion and fire. Serious personal injury or death could occur.



DANGER

Never try to operate or work on this vehicle while under the influence of alcohol. Your reflexes can be affected by even a small amount of alcohol. Drinking and operating this vehicle can lead to an accident, causing serious personal injury or death.

12 VOLVO Engines



WARNING

DO NOT attempt to repair or service this vehicle without having sufficient training, correct service literature and the proper tools. Failure to follow this could lead to personal injury or making your vehicle unsafe.



WARNING

Diesel engine exhaust and some of its constituents are known to the state of California to cause cancer, birth defects and other reproductive harm.

During Maintenance

Remove key from ignition while working on vehicle or engine.

DO NOT allow unauthorized personnel on, around or in the vehicle when maintenance or repair is being performed.

- When operating the engine in an enclosed area, vent the exhaust to the outside.
- Before servicing your vehicle, apply the parking brakes and adequately chock the wheels in order to prevent unintended vehicle movement. If the service procedure requires the parking brakes to be released recheck to ensure that the wheels are adequately chocked to prevent any forward and/or rearward movement.
- DO NOT use combustible substances in or around the engine either during repair or maintenance or when running the engine.
- DO NOT wear loose clothing or jewelry that can catch or get snagged by parts or moving components on the engine. Also wear all protective equipment required by the job conditions, such as protective glasses, hearing protection, etc.
- Make certain that all protective covers and guards are in place and properly secured.
- Never put maintenance fluids into glass containers since glass containers can break.
- Report all problems in a timely manner before they threaten the safety of operating the vehicle.
- DO NOT work on the engine while it is running.
- Make sure protective locks and covers are in their proper place.
- DO NOT use high amperage electronic starting devices for jump-starting the engine. Rely on conventional battery charging for charging the batteries or jump-start with the help of a start battery.
- DO NOT attempt repairs you do not understand. If you do not have the proper tools/knowledge to perform the repairs correctly, Prevost recommends contacting your nearest Prevost Service Center for all necessary repairs.
- When starting an engine after repairs have been made to the fuel or injection system, prepare equipment for shutting off the engine intake air and/or fuel supply (to stop the engine), in case there is an over speed on start-up.
- Start the engine only from the driver seat. Never operate the starter motor across the starter terminals or the batteries as this could bypass the engine neutral-start system as well as causing damage to the electrical or electronic systems.

Compressed Air and Water



DANGER

Compressed air can cause serious personal injury. When using compressed air for cleaning, wear a protective face shield, protective clothing and protective shoes. Pressurized water could cause particles and/or hot water to be sprayed in your direction and cause personal injury. The maximum air pressure must be below 30 psi (200 kPa) for cleaning purposes.

Asbestos Information

Note: The VOLVO engine and replacement parts for it shipped from the factory are asbestos free. VOLVO recommends the use of only genuine VOLVO spare parts.

Never use any parts that contain or are thought to contain asbestos. Exposure to asbestos fibers can create serious health risks, including death.

Fluid Penetration



DANGER

Always use a piece of paper or cardboard when checking for a leak. Escaping fluid under high pressure, even a pin-hole sized leak, can penetrate body tissue, causing serious injury or death. If fluid is injected into your skin, immediate treatment must be administered by a doctor familiar with this type of injury.

Injury Prevention

Burn Prevention

Engine Parts



WARNING

Hot engine. Keep yourself clear of all hot engine parts and/or fluids. A hot engine and/or fluid can cause serious burns.



WARNING

DO NOT raise the engine hood if you see or hear steam or coolant escaping from the engine compartment. Wait until steam or coolant cannot be seen or heard any longer before raising the hood.

DO NOT remove the coolant fill cap if the coolant in the surge tank is boiling. Also, do not remove the cap while the engine and radiator are still hot. Scalding fluid and steam may be blown out under pressure if the cap is taken off too soon, which can cause personal injury and damage to engine components.

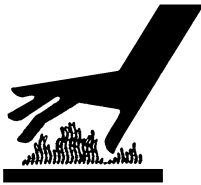

W0001525

DO NOT touch any part of the engine while it is hot. Allow the engine to cool before any repair or maintenance is performed on the engine.

Relieve all pressure in air, oil, fuel or cooling systems before any lines, fittings or related items are disconnected or removed.

16 VOLVO Engines

Coolant



WARNING

Coolant may be combustible. Coolant leaked or spilled onto hot surfaces or electrical components can cause a fire. Clean up coolant spills immediately.



W0001527

To prevent personal injury, use suitable, properly positioned ladder to reach and remove the filler cap. At normal operating temperature, the engine coolant is very hot and under pressure. If pressure is relieved rapidly in a hot cooling system, the hot coolant can turn into steam. Any contact with hot coolant or steam can cause severe burns. The radiator and all heating system and radiator lines and hoses contain hot coolant.

Verify coolant level only by the markings on the expansion tank. Open the filler cap only after the engine is stopped and cooled down. Remove the filler cap slowly to relieve pressure.

Oils



WARNING

Hot engine. Keep yourself clear of all hot engine parts and/or fluids. A hot engine and/or fluid can cause serious burns.

Hot oil can cause severe burns. DO NOT allow hot oil to contact the skin. When changing oil, wear protective gloves.

Batteries



WARNING

Always wear eye protection when working around batteries to prevent the risk of injury due to contact with sulfuric acid or an explosion.



WARNING

Battery posts, terminals and related accessories contain lead and lead compounds, chemicals known to the State of California to cause cancer and reproductive harm. Wash hands after handling.

Battery electrolyte contains acid and can cause injury. Avoid contact with the skin and eyes. Wash hands after touching batteries and connectors. Use of gloves is recommended. Always wear protective glasses when working with batteries.

Fire or Explosion Prevention



DANGER

The diesel engine will operate on any fuel which enters the cylinder, whether it is from the injectors or from the air intake system. Therefore, if any solvent is used to flush out the air cleaner element, the engine may over speed during start-up. Engine damage and severe injury and/or death from burns or explosion can occur.



DANGER

Excessive heat may cause the pressurized components of the air conditioned system to explode. Some mixtures of R134a refrigerant can become combustible at elevated pressures. Never weld, solder, steam clean or use a gas torch near any part of the air conditioning system. Severe injury or death may occur from an explosion.



W0001526



DANGER

DO NOT service any part of the fuel system while smoking or in the presence of flames, sparks or hot surfaces. Failure to follow these precautions can result in fire, which can cause serious injury or death.



WARNING

DO NOT store fuel containers in the vehicle. They may leak, explode and cause or feed a fire. Empty or full, they present a hazard that may lead to burns in the event of a fire.



W0001527

The engine should not be operated in an area where combustible gases are suspected to be in the air. These could be drawn into the engine through the engine air intake system and could cause the engine to over speed with possible serious damage to the engine and bodily injury or property damage.

Make provisions for shutting off the engine intake air or fuel supply to stop the engine if there is an over speed on start-up after performing repair or maintenance on it.

Contact your nearest authorized Prevost Service Center for any necessary air conditioning testing or repairs.

All fuels, most lubricants and some coolant mixtures are flammable. Diesel fuel is flammable. Gasoline is flammable. The mixture of diesel and gasoline fumes is extremely explosive. DO NOT smoke while refueling or when in a refueling area.

Keep all fuels and lubricants stored in properly marked containers and away from all unauthorized personnel. Store oily rags or other flammable material in a protective container, in a safe place.

Remove all flammable material such as fuel, oil and other substances before they accumulate on the engine.

DO NOT expose the engine to flames, driving over burning ground.

DO NOT weld or flame cut on or around pipes or tubes that contain flammable fluids.

Exhaust heat shields may be installed to protect oil or fuel carrying lines and pipes from hot exhaust parts. To protect from pipe or seal failure, install heat shields correctly.

Provide adequate and proper waste oil disposal. Always dispose of waste liquids according to Federal and local regulations. Oil and fuel filters should be properly installed and housing covers tightened to the proper torque when being changed.

Fire Extinguisher

Anytime work is being done to the fuel system or any other area where flammable substances are being used, have a fire extinguisher available and know how to use it. Inspect and have it serviced as recommended on its instruction label.

20 VOLVO Engines

Respiratory Hazard Prevention



DANGER

Exhaust gases contain carbon monoxide. Always run the engine outdoors or use a properly vented exhaust hose. Prolonged or excessive exposure may cause serious illness or death.



WARNING

Diesel engine exhaust and some of its constituents are known to the state of California to cause cancer, birth defects and other reproductive harm.

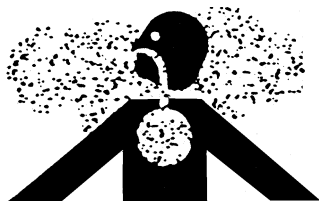

W0001523

Always work in a well ventilated space if the engine needs to be running and use a hose to route the exhaust to the outside.

Poisonous Substances



DANGER

Coolant is toxic; risk of poisoning.
DO NOT drink coolant. Use proper hand protection when handling. Keep coolant out of reach of children and animals. Failure to follow these precautions can cause serious illness or death.

Cooling system supplemental additive contains alkali. To prevent personal injury, avoid contact with the skin and eyes.

DO NOT drink coolant of any concentration.

Crushing or Cutting Prevention



DANGER

Before working on a vehicle, set the parking brakes, place the transmission in neutral and chock the wheels. Failure to do so can result in unexpected vehicle movement and can cause serious personal injury or death.



WARNING

DO NOT work near the fan with the engine running or the ignition in the ON position. The engine fan can engage at any time without warning. Anyone near the fan when it turns on could be seriously injured.



W0001524

Never attempt adjustments or repairs while the engine is running, see your authorized Prevost Service Center.

Inspect the fan blade assembly before service for cracks or loose mounting before starting the engine. *Never* stand alongside a rotating fan assembly, particularly at high fan speeds.

Wear protective glasses when striking objects to avoid injury to your eyes. Chips or other debris can fly off objects that are struck. Make sure no one can be injured by flying debris before striking any object.

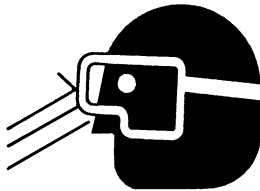

W0001528

Climbing Up and Down



DANGER

Always use a three-point stance (one foot and two hands or two feet and one hand) whenever climbing up or down. Failure to follow this warning can result in serious personal injury or death.

DO NOT climb up on or jump off from the engine or stand on components that cannot support your weight. Use an adequate ladder or scaffolding, suitably situated.

Clean steps, handholds and areas of the vehicle on which you will be working or are around. Refer to the Operators Manual for proper entry and exit procedures.

Engine Damage Prevention

Before Starting the Engine



DANGER

Before working on a vehicle, set the parking brakes, place the transmission in neutral and chock the wheels. Failure to do so can result in unexpected vehicle movement and can cause serious personal injury or death.

Inspect engine for potential hazards. Make sure all protective guards and covers are properly installed if an engine needs to be started to make adjustments or checks. To help prevent an accident by moving parts, work carefully around them.

DO NOT disable or bypass automatic alarm/shutoff circuits. They are provided to prevent personal injury and engine damage.

Only properly trained and authorized Prevost Service Technicians may attempt repairs on this vehicle.

Engine Starting

DO NOT start the engine or move any of the controls or disengage the parking brake if the warning tag DO NOT OPERATE is attached to the ignition key or located on the dash. Check with the person who attached the tag before starting.

Make sure no one is working on or close to the engine or components driven by the engine before starting it. Always make an inspection of the engine before and after starting.

Diesel engine exhaust contains products of combustion which may be harmful to your health. Always start and operate the engine in a well-ventilated area, and if in an enclosed area, vent the exhaust to the outside.

Start the engine only from the driver seat in the cab. Never start the engine by shorting across the starter motor terminals or batteries to start the engine as this could bypass the engine neutral-start system as well as damage the electrical and electronic system. Always start the engine according to the required engine starting procedure described in this operators manual to prevent major engine component damage and personal injury.

24 VOLVO Engines

Starting Aids



DANGER

DO NOT use ether or other combustibile starting aids on any engine equipped with a preheater. If the engine is equipped with a preheater, introduction of ether or similar starting aids could cause a fire or explosion resulting in severe property damage, serious personal injury or death.

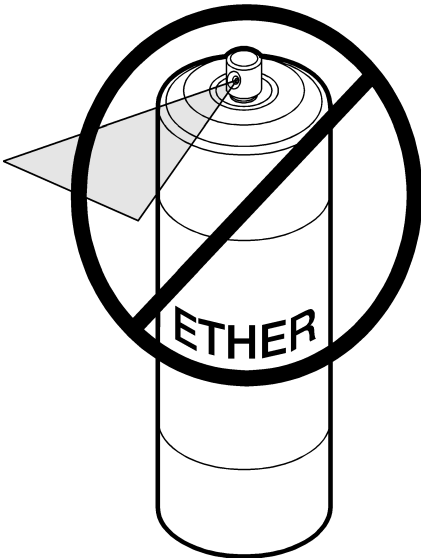

W0001484

Electric and Electronic Systems



WARNING

Always wear eye protection when working around batteries to prevent the risk of injury due to contact with sulfuric acid or an explosion.



W0001526

Never disconnect any charging unit circuit or battery circuit cable from the battery when the charging unit is operating. A spark can cause the flammable vapor mixture of hydrogen and oxygen to explode.

To prevent potential sparks from igniting combustible gases produced by some batteries, attach the negative (-) terminal last when hooking up and remove the negative terminal first after the engine has started. Check regularly around the engine and engine compartment for loose or frayed wires. Have all loose or frayed electrical wires tightened, repaired or replaced before operating the vehicle.

Grounding Practices

Proper grounding for vehicle and engine electrical and electronic systems is necessary for proper vehicle and engine performance and reliability. Improper grounding will result in uncontrolled and unreliable electrical paths.

Uncontrolled engine electrical circuit paths can result in damage to main bearings, crankshaft journals surfaces and aluminum components. Uncontrolled electrical circuit paths can also cause electrical noise which may degrade vehicle and radio performance.

Operating engines without the engine-to-frame ground strap installed can cause damage to the engine. To prevent electrical discharge damage, check to make sure the engines electrical system has an engine-to-frame ground strap. All ground connections should be tight and free of corrosion.

Electronic Engine Control System



DANGER

The engine uses high voltage to the electronic unit injectors. **DO NOT** come in contact with the unit injector terminals while the engine is running. An electric shock can cause an involuntary muscle spasm and cause loss of balance and falls leading to severe personal injury or death.



W0001522

Tampering with the electronic system installation can be dangerous and could result in personal injury or death and/or engine damage. It is very important to take the proper precautions with the electrical and electronic system when charging the batteries, jump-starting or performing electric welding on the vehicle. See the vehicle operator's manual for correct procedures.

This engine is equipped with monitoring features that may cause reduced power or shutdown under certain conditions. The power output, monitoring and idling features can only be programmed and/or changed with electronic service tools and passwords.

Certain features, such as low oil pressure, high coolant temperature or low coolant level could cause the engine power and/or vehicle speed to be limited and the engine may also shut down. The shutdown will take approximately 30 seconds from the time the warning feature is activated. See the vehicle operator's manual for more information.

Reporting Safety Defects

USA

The National Highway Traffic Safety Administration (NHTSA) and PrevoSt should be informed immediately if you believe that the vehicle has a defect that could cause a vehicle accident, injury or death.

Contact NHTSA by calling the Auto Safety Hotline at 1 (888) 327-4236, by writing to NHTSA, U.S. Department of Transportation, Washington, DC 20590, by TTY at 1 (800) 424-9153, or visit their website at <http://www.safercar.gov>.

Canada

Refer customer complaints to Prevost — Customer Service.

850 Chemin Olivier

St-Nicolas, Qc

G7A 2N1 Canada

Fax: 418-831-9301

Canadian customers who wish to report a safety-related defect to Transport Canada, Defect Investigations and Recalls, may telephone the toll free hotline 1 (800) 333-0510 (within Canada only) or call 1 (613) 993-9851 (from Ottawa region or outside Canada). Contact Transport Canada by mail at: Transport Canada, ASFAD, Place de Ville Tower C, 330 Sparks Street, Ottawa ON K1A 0N5.

For additional road safety information, please visit the Road Safety website at: <http://www.tc.gc.ca/roadsafety/menu.htm>

On-Call Assistance

Prevost Action Service, provides on-call assistance. For help contact Prevost Action Service directly: 24 hours a day at 1 800 463 7738.

Introduction

The US2010 VOLVO D13H engines meet the very stringent new emissions standards which apply to all heavy-duty diesel engines built after January 1, 2010 for on-highway coaches. The new standards for US 2010 requires 83% reduction in nitrogen oxides (NOx). This represents a total reduction of 99% of all emissions from original levels.

Key Features of the VOLVO engines:

- Improved Fuel Economy
- Extended Oil Drain Intervals
- Improved Cooling Capacity
- Low Maintenance Catalyzed Aftertreatment Diesel Particulate Filter (DPF)
- Enhanced Engine Brake Performance
- Selective Catalytic Reduction (SCR)

Fuel



CAUTION

Diesel engines for US 2010 vehicles are designed to operate only with ultra low sulfur diesel (ULSD) fuel. Use of fuel other than ULSD will reduce the efficiency and durability of the engine, permanently damage the advanced emission control systems, reduce fuel economy and possibly prevent the engine from running at all. Manufacturer's warranties are likely to be rendered void by usage of improper or incorrect fuel, and usage of fuels other than ULSD fuel in diesel-powered vehicles is illegal and punishable with civil penalties. Use of fuel additives to compensate for the lower sulfur content is NOT recommended by Volvo.

Fuel sold for use in diesel-powered engines for US 2010 vehicles may only contain a maximum sulfur content of 0.0015% by weight. This was done to reduce particle emissions in the exhaust.

**Ultra Low Sulfur
Diesel Fuel Only**

20836671

W2059486

Diesel Fuel Only Decal

Engine Oil

EO-O Premium Plus (or VDS-4) diesel engine oil is mandatory for use in all US 2010 emission compliant VOLVO engines. Chassis equipped with a US 2010 emission compliant engine, which can be identified by the presence of an Aftertreatment Selective Catalytic Reduction (SCR) system, also require the use of ultra low sulfur diesel (ULSD) fuel. EO-O Premium Plus oils exceed the new API service category CJ-4.

Engine Operation

DANGER

Do not use ether or other combustible starting aids in any VOLVO engine. Introduction of ether or similar starting aids could cause a fire or explosion resulting in severe property damage, serious personal injury or death.

CAUTION

DO NOT crank the engine for more than 30 seconds at a time; wait two minutes after each try to allow the starter to cool. Failure to follow these instructions could cause starter damage.

Note: Some starters are equipped with starter protection. If the engine is running, the starter temperature is too high or the transmission is not in neutral, starter engagement is inhibited.

Allow the engine to slow down and idle for 3 to 5 minutes before shutting it off. This allows the turbo to slow down and the cooling system to dissipate the engine heat. Switch the engine off by turning the ignition key to the OFF position.

CAUTION

Shutting off an engine immediately after high speed or full load operation can damage the turbo and cause heat stress in the engine. Always let the engine idle for 3 to 5 minutes before shutting it off.

Engine Shutdown System



DANGER

Failure to take the necessary precautions when the STOP telltale is ON can result in automatic engine shutdown and the loss of power steering. Vehicle crash can occur.

The engine shutdown system will automatically derate or stop the engine when one or more of the conditions listed below reaches a critical stage:

- High Engine Coolant Temperature (ECT)
- Low Engine Oil Pressure (EOP)
- Low Engine Coolant Level (ECL)
- High Crankcase Pressure (CCP)

When the shutdown is activated, the telltales come on along with display symbols and the buzzer is also activated. After a brief time, the engine shuts down. Find a safe place to pull off the road as soon as possible.

After the engine has been shut down by the system, turn the ignition key to the OFF position. If necessary, the engine can be restarted for a brief time so that the vehicle may be pulled off the road.

The alarm will remain activated until repairs have been made to correct the problem that caused the shutdown.



CAUTION

Continuously restarting the engine once the shutdown system is active may result in severe engine damage.

Refer to the Driver Information Display manual for information about the display symbols.



W3005171

32 VOLVO Engines

Engine Overview, D13H Left Side View

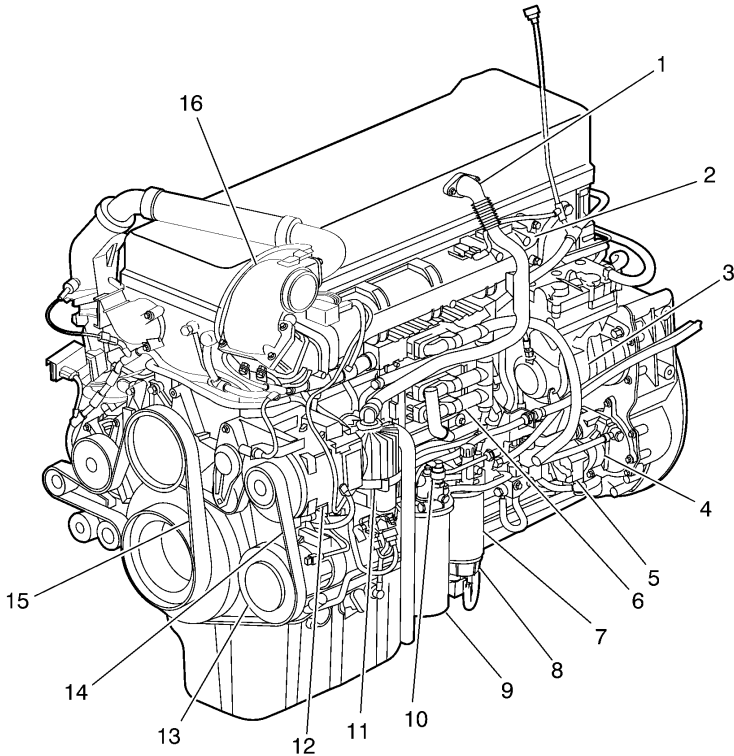

W2006034

D13H Engine

Note: Illustration is used for reference only and may differ slightly from the actual vehicle.

1. Breather Tube	9. Fuel Filter
2. Intake Manifold	10. Hand-Priming Pump
3. Air Compressor	11. Crankcase Ventilator
4. Power Steering Pump	12. Alternator
5. Fuel Pump	13. AC Compressor
6. Engine Control Module (ECM)	14. Alternator/AC Compressor Belt
7. Fuel Filter	15. Fan/Coolant Pump Belt
8. Fuel/Water Separator	16. EGR Mixing Chamber

Engine Overview, D13H Right Side View

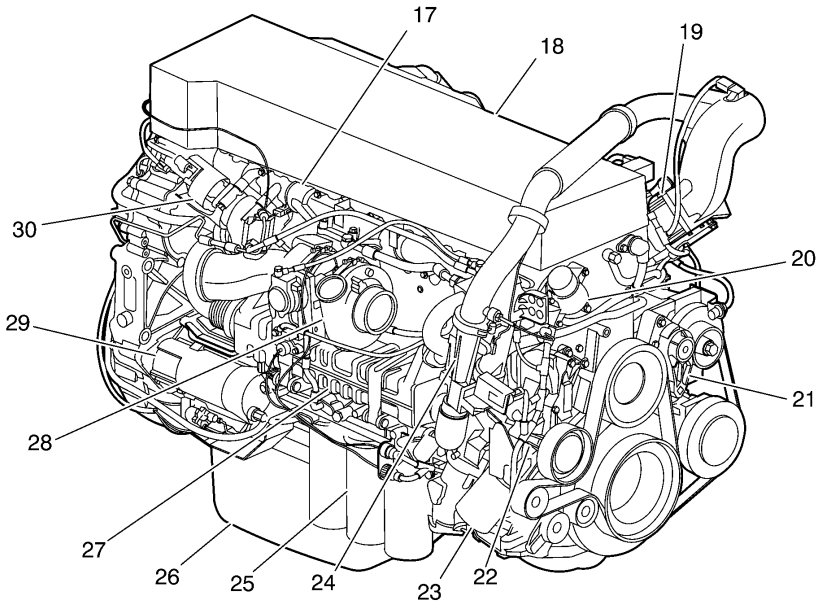

W2006035

D13H Engine

Note: Illustration is used for reference only and may differ slightly from the actual vehicle.

17. Exhaust Manifold	24. Venturi Pipe
18. Valve Cover	25. Oil Filters
19. Intake Air Heater (IAH) optional	26. Oil Pan
20. Thermostat	27. EGR Cooler
21. Belt Tensioner	28. Turbocharger
22. Coolant Pump	29. Starter Motor
23. Coolant Filter	30. EGR Valve

Exhaust Emissions and Aftertreatment Diesel Particulate Filters (DPFs)

General

USA

Emissions Control Compliance: The Federal Clean Air Act, Section 203 (a) (3), states the following concerning the removal of air pollution control devices or modification of a certified engine to a non-certified configuration:

“The following acts and the causing thereof are prohibited:

(3) For any person to remove or render inoperative any device or element of design installed on or in a motor vehicle or motor vehicle engine in compliance with regulations under this part prior to its sale and delivery to the ultimate purchaser, or for any manufacturer or dealer knowingly to remove or render inoperative any such design after sale and delivery to the ultimate purchaser.”

Specifically, please note that no person may make such changes prior to the sale and delivery of the vehicle to the ultimate purchaser, and, in addition, no manufacturer or dealer may make take such action after sale and delivery of the vehicle to the ultimate purchaser. The law provides a penalty of up to \$10,000 for each violation.

Modifications, such as reprogramming of the fuel system so the engine will exceed the certified horsepower or torque, or removing the mufflers are examples of illegal changes.

Changes should not be made to a certified engine that would result in an engine that does not match the configuration of an engine model that is currently certified to meet Federal Standards.

Mexico

The same conditions that apply in the USA apply to Mexico. Refer to the Mexican Federal Law for Emission Control which adheres to EPA regulations. No changes should be made that render any or all of the emissions control devices inoperative.

If the owner/operator wishes to make changes to the emission control devices, check with the state authority before changes are made.

Canada

The same conditions that apply in the USA apply to Canada, with one exception. After the vehicle is sold to a retail customer, that is, the end user, the jurisdiction controlling the emission control devices becomes the province in which the vehicle is licensed. No changes should be made that render any or all of the devices inoperative.

Should the owner/operator wish to make any changes to the emission control devices, check with the provincial authority before making any such changes.

Exhaust Emissions and Aftertreatment DPF with Vertical SCR Catalyst

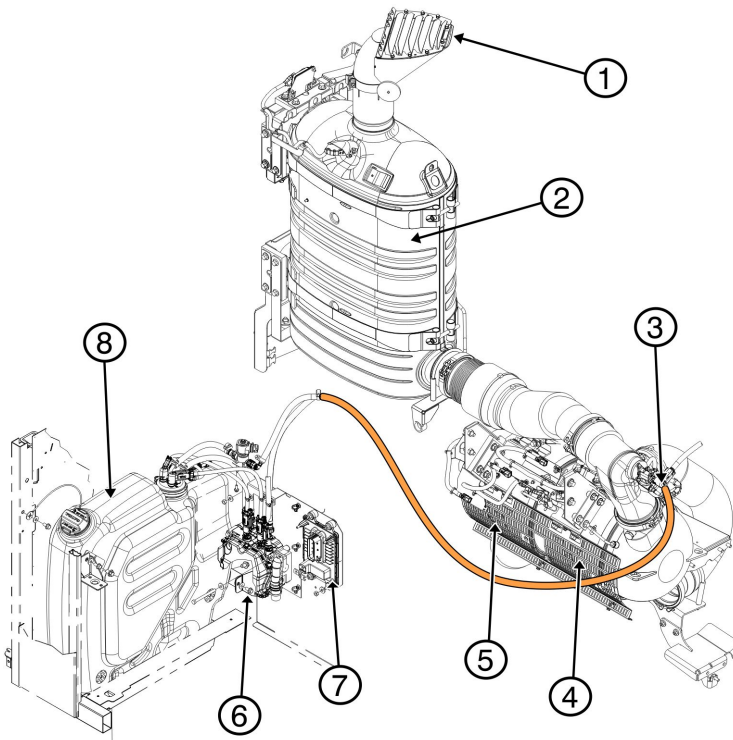

W2081002

1. Diffuser AssemblyAftertreatment
2. Catalytic Converter
3. DEF Injection Nozzle
4. Diesel Particulate Filter (DPF)
5. Diesel Oxidation Catalyst (DOC)
6. DEF Pump
7. Aftertreatment Control Module
8. Aftertreatment DEF Tank

Exhaust Aftertreatment System

DANGER

The DPF/SCR shield should not be removed while the vehicle is in use. Also, only remove the shield, once the vehicle is out of use and the SCR/DPF is sufficiently cooled. Failure to follow these instructions can result in fire, which can cause component damage, personal injury or death.

CAUTION

The Diesel Particulate Filters (DPF), Selective Catalytic Reduction unit (SCR) and their components, **can not** be moved or altered from the OEM installation in any fashion. Any alterations may cause component damage and is prohibited by the law.

These components are part of the overall vehicle emissions control system. In normal operation, these components can experience surface temperatures as high as 350° C (662° F). It is important to verify the temperature at which the material or substance in, or associated with, the body can ignite. If it is possible for the material or substance to fall or leak from the body, take steps to prevent them from contacting or collecting on the DPF or SCR. Failure to do so may result in fire.

It is important to note that additional shielding may, depending upon conditions and the material or substance, trap flammable substances between the additional shield and the DPF/SCR. If this condition can develop, advise the user of the vehicle to periodically check to ensure there are no trapped substances.

Note: The DPF/SCR and associated components are part of a U.S. EPA and California Air Resources Board (CARB) certified engine emissions system. These components must not be moved, altered or modified in any way. Tampering with these systems render the emissions warranty void and may result in possible tampering charges by the EPA or CARB.

New stringent standards for exhaust emission control begin with the US 2010 engine model year. The Diesel Particulate Filter (DPF) system has been developed to act in combination with ultra low sulphur diesel (ULSD) fuel to reduce particulate emissions to meet the requirement. The Exhaust After-Treatment System (EATS) includes all the engine and exhaust emissions control components that are required to meet the stringent US 2010 standard.

Particulate matter consists of soot and ash in the exhaust that engines with an EGR system alone, are not equipped to handle. The particulate matter is considered a contaminant that contains undesirable elements. The DPF system reduces the unwanted elements to a more acceptable level defined in the regulations. There are multiple methods of reducing these emissions. VOLVO has selected to use a Diesel Oxidation Catalyst (DOC) with a catalyzed diesel particulate filter. The other uses a diesel particulate filter of a different kind without a DOC and in its place uses a combustion chamber to heat the exhaust mixture thus causing active regeneration.

The particulate matter removed from the exhaust collects on the filter surfaces. To avoid eventual blockage, which would increase exhaust back pressure and affect power and fuel economy, the filter must be cleaned. The DPF is cleaned automatically. The soot breaks down to safer substances before being released to the atmosphere. Some of the ash remains, but takes a long time to reach the point where ash clogs the filter.

Cleaning a filter so it can continue to function is called “regeneration.” Depending on vehicle usage, the engine utilizes a passive or parked regeneration system. Either system uses high heat to break down the chemical properties.

In “passive regeneration,” the exhaust produces enough heat continuously to convert the soot, with approximately 260 °C (500 °F) being required. The process is slow and continues indefinitely. Passive regeneration is possible only in vehicle applications where the temperature is likely to remain at or above the required temperature level, making active regeneration unnecessary.

Parked regeneration is initiated manually by the driver when alerted by the dash. The vehicle must be stationary to begin the regeneration, and remain stationary to complete. The Aftertreatment DPF Regeneration system is self-monitoring. Under certain duty cycles driver action is needed to perform a parked regeneration. When driver action is needed to perform a parked regeneration the Aftertreatment DPF Regeneration Needed icon on the instrument cluster flashes and the message “Parked REGEN Needed” is displayed. Initiate a parked Aftertreatment DPF regeneration at the next stop.



WARNING

Prior to ever working on the exhaust, allow time for the entire exhaust system to cool. Failure to do so may result in personal injury. Severe burns can occur.

DPF Systems

The VOLVO systems chemically alters soot by high heat into a harmless gas which passes out through the stack pipe. At these high temperatures, the process is relatively rapid (10–12 minutes). Eventually, the filter must be removed to permit clearing away of the ash with special equipment.

The DPF-muffler has an integrated heat insulation that covers most areas of the muffler. The DPF mufflers are un-insulated at the V-clamp body connections, inlet and outlet pipes. The following surface temperatures have been measured with the muffler freely positioned in a room temperature environment with no forced cooling or wind (only self convection).

Note: These are **not** maximum temperatures! The surface temperature in a certain vehicle installations, is dependent on the degree of encapsulation and the airflow around the muffler.

Compact DPF Temperatures

Position	Thickness of Heat Insulation	at exhaust temperature of 350 °C (662 °F) at the DPF-muffler inlet (no regeneration)	at exhaust temperature 450 °C (842 °F) at the DPF-muffler inlet (no regeneration)
Inlet section — top	10 mm (0.4 in.)	170 °C (338 °F)	190 °C (374 °F)
Inlet section — side	No insulation	260 °C (550 °F)	320 °C (608 °F)
DOC section	9 mm (0.35 in.)	175 °C (347 °F)	215 °C (419 °F)
DPF section	10.5 mm (0.41 in.)	145 °C (293 °F)	190 °C (374 °F)
Outlet section — side	4.5 mm (0.18 in.)	100 °C (212 °F)	150 °C (302 °F)
Outlet section — bottom	4.5 mm (0.18 in.)	120 °C (248 °F)	170 °C (338 °F)
Clamping area — side	No insulation	230 °C (446 °F)	300 °C (572 °F)

Selective Catalytic Reduction (SCR)

Selective Catalytic Reduction (SCR) is an emissions-reduction technology with the ability to deliver near-zero emissions of nitrogen oxides (NO_x), a smog-causing pollutant and greenhouse gas. SCR's performance has been proved in millions of miles of real-world truck operations in other countries, as well as in long-term field tests in the U.S.

SCR reduces NO_x emissions to very low levels, while at the same time delivering excellent fuel economy and reliability. The system doesn't change the design or operation of the basic engine. Rather, SCR is an aftertreatment system which converts NO_x in the exhaust stream into harmless gases. Modern diesels already use exhaust aftertreatment systems, called diesel particulate filters, to control emissions of another pollutant, soot (also known as particulate matter or PM).

SCR works by injecting Diesel Exhaust Fluid (DEF) into the exhaust stream, after the DPF. DEF is a safe, simple solution of water and urea. DEF works with the heat of the exhaust and a catalyst to convert NO_x into nitrogen and water vapor - two harmless and natural components of the air we breathe. The end result is cleaner air, excellent fuel efficiency and a reliable emissions control system for today's modern diesel engine.

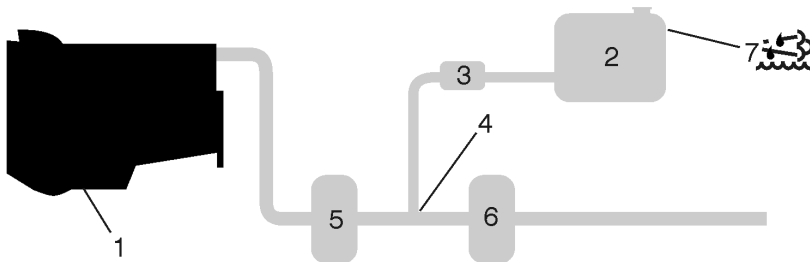

W2031651

1. Diesel Engine
2. Aftertreatment DEF Tank
3. Aftertreatment DEF Pump
4. Aftertreatment DEF Dosing Unit
5. Aftertreatment Diesel Particulate Filter (DPF)
6. Selective Catalytic Reduction (SCR) Catalyst
7. Aftertreatment DEF Tank Sending Unit and DEF Low Level Indicator

40 VOLVO Engines

SCR Surface Temperatures

Position	Thickness of Heat Insulation	at exhaust temperature of 350 °C (662 °F) at the SCR-muffler inlet	at exhaust temperature 450 °C (842 °F) at the SCR-muffler inlet
Casing – all round	Muffler filled with insulation	75 °C (167 °F)	125 °C (257 °F)
End wall – in/outlet side	20 mm (0.78 in.)	100 °C (212 °F)	150 °C (302 °F)
End wall – other side	20 mm (0.78 in.)	125 °C (257 °F)	200 °C (392 °F)
Mounting strap area	No insulation	225 °C (437 °F)	300 °C (572 °F)



CAUTION

Do not put diesel fuel in the Aftertreatment DEF tank. Diesel fuel, if sprayed into the hot exhaust along with the DEF, could ignite explosively causing a fire resulting in personal injury or damage to the exhaust system.

The VOLVO SCR system is simple and effective, with few components. It consists of a Aftertreatment DEF tank positioned near the standard diesel tank, plus a Aftertreatment DEF pump, Aftertreatment DEF Dosing unit and SCR catalyst. The advantage of using DEF is that it enables the engine to use less EGR -- and higher oxygen levels -- for better combustion, while meeting the EPA near-zero NOx emissions requirement of 0.2 g/hp-hr NOx. By using DEF, we avoid the disadvantages of increasing EGR to massive levels. This results in better fuel economy from your VOLVO engine.



W2055491

Vertical SCR, vertical inlet

Aftertreatment Hydrocarbon Dosing System

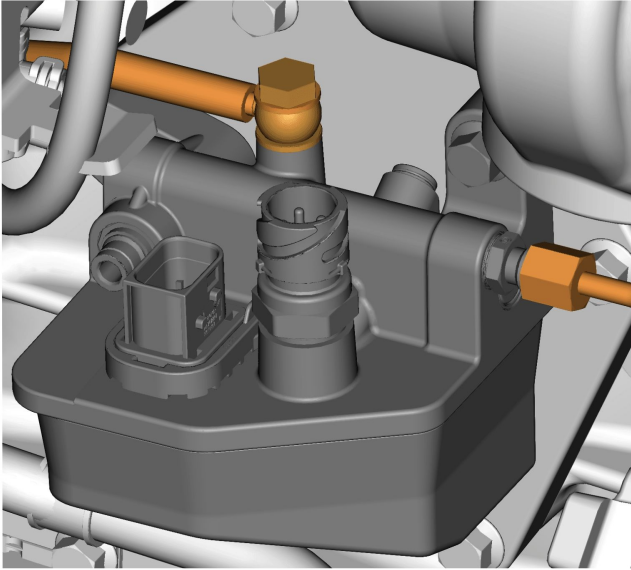

W2064634

The aftertreatment hydrocarbon dosing system is a part of the exhaust aftertreatment system and is used to increase the exhaust gas temperature (EGT) needed for the aftertreatment system.

The dosing system allows diesel fuel to be injected into the exhaust system of the engine to increase the amount of hydrocarbon (HC) released.

The injected fuel will increase the EGT by oxidation of hydrocarbon. An aftertreatment diesel oxidation catalyst (DOC) is mounted upstream of the aftertreatment diesel particulate filter (DPF). This elevated temperature is needed for the aftertreatment selective catalytic reduction (SCR) system and DPF. The HC-system shall be governed by the engine control module (ECM).

The dosing system has interfaces with a most of the vehicle's, major control systems including the fuel system, compressed air system, exhaust system, electrical system, control system and external mechanical interfaces.

Diesel Exhaust Fluid (DEF)

Diesel Exhaust Fluid (DEF) is a reactant that's key to the SCR process. It's a nontoxic, aqueous solution of 32.5% urea and 67.5% water. Urea is a compound of nitrogen that turns to ammonia when heated. It is used in a variety of industries, perhaps most commonly as a fertilizer in agriculture. The fluid is not flammable, nor is it dangerous when handled normally. However, it is corrosive to metal, particularly copper and aluminium. Read the separate section concerning the handling of DEF solution.

Diesel Exhaust Fluid (DEF) Handling

When handling DEF solution, it is important that electrical connectors to be connected or well encapsulated. Otherwise there is a risk that the DEF will cause oxidation that cannot be removed. Water or compressed air do not help, since DEF quickly oxidizes metal. If a connector comes into contact with the DEF solution it must be replaced immediately to prevent the DEF solution from creeping further into the copper wiring, which takes place at a speed of about 60 cm (2.4 in) per hour.



CAUTION

When detaching hoses and components, do not spill DEF on disconnected connectors. If DEF is spilled on a connector, the connector must be replaced immediately



W2059485

44 VOLVO Engines

Things to know about spilled Diesel Exhaust Fluid (DEF)

If urea solution comes into contact with the skin, rinse with plenty of water and remove contaminated clothing.
If urea solution comes into contact with the eyes rinse for several minutes and call for medical help if necessary.
If inhaled breathe fresh air and call for medical help if necessary.
Do not allow the DEF solution to come into contact with other chemicals.
The DEF solution is not flammable. If the DEF solution is exposed to high temperatures for long periods of time, it breaks down into ammonia and carbon dioxide.
The DEF solution is corrosive to certain metals, including copper and aluminium. This is similar to the corrosion caused by salt water.
If the DEF solution is spilled onto the vehicle, wipe off the excess and rinse with water. Spilled DEF solution can form concentrated white crystals on the vehicle. Rinse off these crystals with water.

Note: Do not flush DEF spills into the normal drain system.



WARNING

DEF spilt onto hot components will quickly vaporize. Turn your face away!

Diesel Exhaust Fluid (DEF) Consumption

DEF consumption is related to fuel consumption. A bus may travel 225-300 miles (360 — 480 kilometers) or more on one gallon (3.8 liters) of DEF. A gauge much like a fuel gauge will indicate the level of DEF in the tank. A DEF low-level warning activates when DEF is low. If a driver runs out of DEF completely, vehicle power will be reduced to derate mode. When the DEF tank is refilled, the engine will resume normal power.

Note: DEF tanks are sized for a two to one fuel to DEF ratio in order to meet US 2010 requirements.

Diesel Exhaust Fluid (DEF) Availability

DEF is available in 2.5 gallon (9.6 liters) containers, 55 gallon (200 liters) drums, 275 gallon (1000 liters) IBC and in bulk storage for fleet locations, truck stops and dealerships. All major truck stops, dealers and distributors carry DEF. For more information on DEF and availability please visit the website www.volvoscr.com.

Aftertreatment Control Module (ACM)

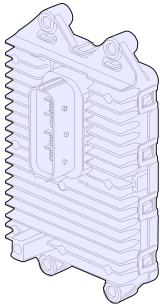

W2038621

The ACM controls the following components in the exhaust aftertreatment system:

- Aftertreatment DEF Dosing Unit
- Aftertreatment DEF Tank Heater Valve
- Aftertreatment DEF Line Heaters
- Aftertreatment DEF Pump
- Aftertreatment DEF Return Valve
- Aftertreatment DEF Tank Level Sensor

The ACM also monitors the following values in the exhaust aftertreatment system:

- Aftertreatment DEF Dosing Absolute Pressure
- Aftertreatment DEF Tank Temperature
- Aftertreatment DEF Tank Level
- Aftertreatment DPF Inlet/Outlet Temperature
- Aftertreatment DPF Differential Pressure
- NOx Sensors

The ACM is a stand alone module. Depending on your configuration it may be mounted as part of the DEF tank (as shown above) or on a bracket near the DEF tank.

Smart NOx Sensor

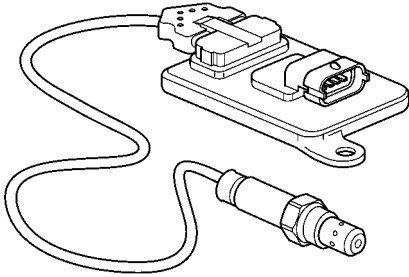

W9000948

The Smart NOx- sensor is used to monitor the emission reduction system. Two NOx sensors are needed for US 2010 vehicles. One sensor is positioned on the DPF/muffler outlet, the other on the exhaust pipe after the SCR-muffler on the SCR-muffler outlet (vertical version).

Note: The Smart NOx sensors should not be moved or modified in anyway. To do so would inhibit the proper operation of the Aftertreatment system

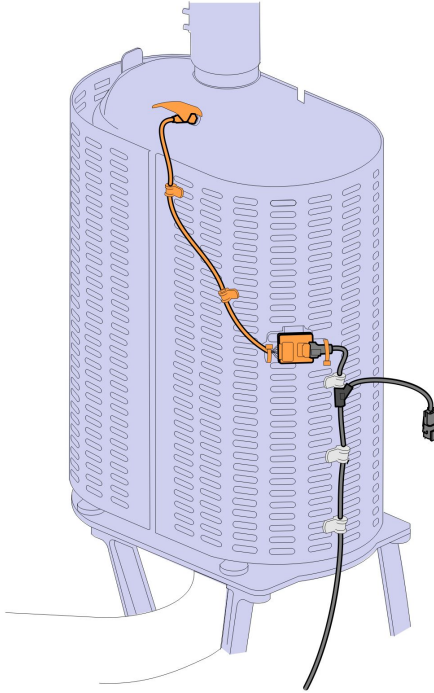

W2081003



NOx Sensor Locations for Vertical SCR

Aftertreatment Inducement Screens







Aftertreatment DEF Tank Level - Driver Warning & Inducement

Aftertreatment DEF tanks are sized to have no less than two times the diesel fuel tank mileage.

The vehicle instrument cluster has an aftertreatment DEF tank level gauge.

Triggers	Aftertreatment DEF Tank Low Level Indicator	Driver Information Display Screen
100% to 12% Aftertreatment DEF Tank Level Gauge	None	None
<p><=12% Aftertreatment DEF Tank Level Gauge</p>	 <p style="text-align: center; font-size: small;">W2029416</p> <p>Solid indicator</p>	<p>Low DEF level Refill to avoid Engine derate</p>
<p>0% Aftertreatment DEF Tank Level Gauge (~1% DEF Remaining)</p>	 <p style="text-align: center; font-size: small;">W2029415</p> <p>Blinking indicator</p>	<p>DEF Tank Empty Engine in derate Refill to avoid 5 Mph</p>
<p>0% Aftertreatment DEF Tank Level Gauge AND either:</p> <ol style="list-style-type: none"> 1 Vehicle stationary for 20 minutes, or 2 Diesel fuel Refueling > 15% with parking brake engaged. 	 <p style="text-align: center; font-size: small;">W2029415</p>	<p>DEF tank empty Speed limited to 5 Mph</p>

Aftertreatment DEF Quality - Driver Warning & Inducement

Triggers	Lamp Status	Driver Information Display Screen
Good DEF Quality	None	None
Poor DEF Quality DTC Initially Detected	 W2029417	SCR performance low Engine derate in < xxx mins
Poor DEF Quality DTC Initially Detected + 1 hour of operation	 W2029417	SCR performance low Engine derate in < xxx mins
Poor DEF Quality DTC Initially Detected +4 hours of operation	 W2029417	SCR performance low Engine in derate 5 Mph in < xxx mins
Poor DEF quality DTC initially detected + 4 hours of operation AND either: 1 Vehicle stationary for 20 minutes, or 2 Diesel Fuel Refueling > 15% with parking brake engaged	 W2029417	SCR Performance low Engine in derate 5 Mph at next stop
By means of 1 engine start or use of a service tool temporary exit from 8 Km/h (5 Mph) Inducement	 W2029417	SCR performance low Speed limited to 5 Mph
Ignition Key Cycle before DEF Quality Evaluation has been completed	 W2029417	SCR perf. check Engine in derate 5 Mph Limit removed

Exit conditions for DEF Quality "8 Km/h (5 mph) road speed limit" Inducement:





Next 1 Engine Starts: Return to 25% torque reduction until there is a proper DEF quality evaluation. If poor DEF quality is detected during the next monitoring cycle then 8 Km/h (5 mph) is resumed after the vehicle is stationary for 20 minutes. After one engine start has been exhausted then a Tech Tool is required to exit the 8 Km/h (5 mph) road speed limit.

With Tech Tool DTC Clearing: Invoke 25% torque reduction until there is a proper DEF quality evaluation. If poor DEF Quality is detected during the next monitoring cycle then 8 Km/h (5 mph) is resumed after the vehicle is stationary for 20 minutes.





Aftertreatment Tampering - Driver Warning & Inducement

When the SCR tampering fault is active for one or more hours a new Driver Information Display screen appears. The text changes for the Driver Information Display (DID) screen associated with this fault are listed in the table below.

Note: Repeated acts of tampering will result in more severe Inducement.

Triggers	Lamp Status	Driver Information Display Screen
No fault	None	None
Tampering Fault Detect Note: For examples of various SCR sensor tampering types refer to the “SCR Tampering ” table below	 <small>W2029417</small>	SCR system fault Engine derate in < xxx mins
Second Drive Cycle with Active DTC.	 <small>W2029417</small>  <small>W3031200</small>	SCR System Fault Engine in derate 5Mph in <xxx mins
Driving with Active Fault for + 1 hour.	 <small>W2029417</small>  <small>W3031200</small>	SCR system fault Engine in derate 5 Mph in < mins

52 VOLVO Engines

<p>Driving with Active Fault for + 4 hours</p>	 <p>W2029417</p>  <p>W3031200</p>	<p>SCR system fault Engine in derate 5 Mph at next stop</p>
<p>Active tampering DTC initially detected + 4 hours of operation AND either:</p> <ol style="list-style-type: none">1 Vehicle stationary for 20 minutes, or2 Diesel Fuel Refueling > 15% with parking brake engage	 <p>W2029417</p>  <p>W3031200</p>	<p>SCR system fault Speed limited to 5 Mph.</p>

SCR Tampering
Aftertreatment Control Module (ACM) Disconnected
Aftertreatment Inlet NOx sensor disconnected
Aftertreatment Oulte NOx sensor disconnected
DEF Pump Disconnected
DEF Dosing Valve Disconnected
DEF Tank Level Sensor Disconnected
DEF Dosing valve or line blocked.
DEF Pump pressure build up failure
DEF Return Line Blocked or Plugged

Note: For additional DID information refer to the Driver Information Display Manual.

Misfilling Diesel or Aftertreatment DEF Tanks

Although diesel fuel and Aftertreatment DEF caps are clearly labeled and filler necks and nozzles are different accidents can happen.

Contamination of fluids by- misfilling of diesel or DEF in the wrong tank may result in vehicle malfunction.

Results of Misfilling DEF in Diesel Tank

- Engine may run poorly or not at all
- Engine injectors may be damaged
- Exhaust system corrosion may occur between engine turbocharger and Aftertreatment DPF
- On Board Diagnostic (OBD) Diagnostic Trouble Codes (DTC)

- Costly repairs

Results of Misfilling Diesel in Aftertreatment DEF Tank

- Aftertreatment SCR system may be damaged by diesel
- SCR Catalyst may be damaged by diesel (chemical damage)
- Emissions may be non-compliant
- On Board Diagnostic (OBD) Diagnostic Trouble Codes (DTC)
- Costly repairs

Warranty and Maintenance

Exhaust Aftertreatment System Maintenance

The vehicle must be taken to an authorized Prevost Service Center to remove the ash from the Aftertreatment Diesel Particulate Filter and clean the Aftertreatment Doser.

Emissions Maintenance

1. If owner's manual recommends Aftertreatment DPF replacement within useful life, the manufacturer must pay for the replacement; however, a random failure within the useful life is covered only per the above warranty provisions.
2. First maintenance interval in life of the engine is allowed at 160 000km (100,000 miles), 3000 hours.

Engine Maintenance Intervals

For specific engine maintenance intervals reference the “Maintenance Manual PREVH, PREVX.”

Engine Gaseous Emission Control Systems

WARRANTY MAINTENANCE

GASEOUS EMISSION CONTROL SYSTEMS WARRANTY

Prevost warrants the Emission Control Systems on each new VOLVO diesel engine in a new Prevost coach to comply with all United States Federal and Canadian emissions regulations applicable at the time of manufacture of the engine, and to be free from defects in material and workmanship under normal use and service up to 60 months, or 100,000 miles, whichever occurs first, provided all Prevost, maintenance requirements are followed as described in this manual. All warranty periods are calculated from the date-in-service of the new vehicle. The repair or replacement of defective parts will be made without charge for the cost of parts and, if repairs are made at an authorized Prevost Service Center, there will be no charge for labor. Prevost’s obligation under this warranty is limited to the repair or replacement, at Prevost’s option, of any part(s) of the Emission Control Systems of such engine and/or vehicle found to be defective upon examination by Prevost and provided that such part(s) were returned to Prevost or its nearest authorized Service Center within a reasonable period of time.

Qualifications and Limitations:

Note: Not covered by the Emissions Control Systems Warranty:

- Malfunctions caused by misuse, improper adjustments, modification, alteration, tampering, disconnection, improper or inadequate maintenance and use of improper diesel fuel or DEF.
- Damage resulting from accident, acts of nature or other events beyond the control of Prevost.
- Inconvenience, loss of use of the vehicle, commercial loss of any kind including, but not limited to, consequential or incidental damages
- Any vehicle in which the odometer has been altered or damaged so that mileage cannot be readily determined.

THIS WARRANTY IS EXPRESSLY IN LIEU OF ALL OTHER WARRANTIES AND REPRESENTATIONS OR CONDITIONS, STATUTORY OR OTHERWISE, EXPRESSED OR IMPLIED INCLUDING, BUT NOT LIMITED TO, IMPLIED WARRANTY OF MERCHANTABILITY OR FITNESS FOR A PARTICULAR PURPOSE.

Emissions Control System Warranty

The following engine components are covered by the supplemental emissions control system warranty policy as required by the Federal code of emission regulations.

- 1 Engine Turbocharger Assembly
 - Engine VGT Actuator
 - 2 Engine Charge Air Cooler (CAC)
 - CAC Pipes (Air inlet to/from CAC)
 - CAC Hoses
 - 3 Engine Control Module (ECM)
 - 4 Engine Injectors
 - 5 Engine and Vehicle Wire harness (repair to circuits related to Emissions Warrantable Components)
 - 6 Exhaust Gas Recirculation (EGR) Mixer Tube
 - 7 EGR Cooler
 - 8 EGR Valve and EGR Valve Control
 - 9 EGR Pipes - Engine Exhaust Manifold to EGR Cooler
 - 10 EGR Pipes - EGR Cooler to Inlet Manifold
 - 11 Crankcase Breather (CCB)
 - 12 Crankcase Breather Oil Separator
 - 13 Crankcase Tubing and Hoses before CCB Oil Separator
 - 14 Aftertreatment Wiring Harness
 - 15 Aftertreatment Control Module (ACM)
 - 16 Aftertreatment Diesel Particulate Filter (DPF) Assembly
 - A. Aftertreatment DPF Assembly with Aftertreatment Diesel Oxidation Catalyst (DOC)
 - Aftertreatment Hydrocarbon Doser (HCD)
 - Diffuser Pipe (Aftertreatment Hydrocarbon Doser Mounting)
 - Fuel lines to Aftertreatment Hydrocarbon Doser
 - Aftertreatment Fuel Shutoff Valve
 - Aftertreatment Fuel Pressure Sensor
 - Discharge Recirculation Valve (DRV) (Heat Mode)
 - Discharge Recirculation Valve (DRV) Solenoid
 - Engine Turbocharger Compressor Bypass Actuator (Heat Mode)
 - Engine Turbocharger Compressor Bypass Actuator Solenoid
 - Engine Exhaust Gas Temperature (EGT) Sensor
 - Aftertreatment DPF Intake Temperature Sensor
 - Aftertreatment DPF Outlet Temperature Sensor
 - Aftertreatment DPF Differential Pressure Sensor
 - Aftertreatment Doser Air Supply Regulator (if applicable), Supply Lines, and Fittings
- 17 Sensors:
- Crankshaft Position (CKP) Sensor
 - Camshaft Position (CMP) Sensor
 - Engine Coolant Temperature (ECT) Sensor
 - Intake Manifold Air Temperature/ Pressure Sensor
 - EGR Temperature Sensor
 - Aftertreatment Outlet NOx Sensor
 - Aftertreatment Intake NOx Sensor
 - EGR Differential Pressure Sensor
 - Ambient Air Temperature (AAT) Sensor
- 18 SCR

- Aftertreatment Selective Catalytic Reduction (SCR) Catalyst
 - Aftertreatment Diesel Exhaust Fluid (DEF) Pump
 - Aftertreatment DEF Dosing Absolute Pressure Sensor
 - Aftertreatment DEF Return Valve
 - Aftertreatment DEF Dosing Valve
 - Aftertreatment DEF Tank
 - Aftertreatment DEF Tank Heater/Sender
 - Aftertreatment DEF Tank Heater
 - Aftertreatment DEF Tank Heater Valve
 - Aftertreatment DEF Tank Temperature Sensor
 - Aftertreatment DEF Level Sensor
 - Aftertreatment DEF Heated Lines
19. Instrument Cluster (Repair of microprocessor , OBD MIL, Real Time Clock, Aftertreatment DEF Tank Gauge and, Aftertreatment DEF Tank Low Level Indicator)
 20. Exhaust Gas Piping (from Turbocharger to Aftertreatment System)
 21. Data Link Connector (DLC)

Engine Gaseous Emissions Control System Warranty

The emission warranty for the diesel particulate filter and SCR Systems covers defects in workmanship only. Normal maintenance, such as cleaning ash from the filter at regular maintenance intervals and cleaning the Aftertreatment fuel injector on Diesel Oxidation Catalyst (DOC) DPF systems, is not covered by the emission warranty. With the Thermal Regeneration DPF system, cleaning the ignition electrodes and fuel injection nozzle at the regular maintenance intervals is considered normal maintenance and not covered by the emission warranty.

Federal Emission Requirements

This section covers the requirement of the United States Clean Air Act which states: “The manufacturer shall furnish with each new motor vehicle or motor vehicle engine such written instructions for the maintenance and use of the vehicle or engine by the ultimate purchaser as may be reasonable and necessary to assure the proper functioning of emission control devices and systems. ”This section also covers the requirements of the emissions regulations promulgated under the Motor Vehicle Safety Act in Canada.

TAMPERING WITH GASEOUS EMISSION CONTROL SYSTEMS PROHIBITED

The Federal Clean Air Act prohibits the removal or rendering inoperative of any device or element of design installed on or in a motor vehicle or motor vehicle engine in compliance with Federal Emission Regulations by:

- 1 Any person prior to its sale and delivery to the ultimate purchaser, or
- 2 Any manufacturer or distributor after its sale and delivery to the ultimate purchaser, or
- 3 Any person engaged in the business of repairing, servicing, selling, leasing, or trading motor vehicles or motor vehicle engines following its sale and delivery to the ultimate purchaser, or
- 4 Any person who operates a fleet of motor vehicles following its sale and delivery to the ultimate purchaser.

Note: For specifics of the prohibited vehicle/engine modifications refer to the VOLVO Body Builders documentation .

Emission Control System Warranty — California

The California Air Resources Board and Prevost. are pleased to explain the California emission control system warranty on your new motor vehicle engine. In California, new motor vehicle engines must be designed, built and equipped to meet the State's stringent anti-smog standards. Prevosti. must warrant the emission control system on your engine for the period of time listed below provided there has been no abuse, neglect, or improper maintenance of your engine. Your emission control system may include parts such as the fuel-injection system, turbocharger assembly, electronic control module and other emission-related assemblies.

Where a warrantable condition exists, Prevost will repair your engine at no cost to you including diagnosis, parts, and labor. **MANUFACTURER'S WARRANTY COVERAGE:** If an emission-related part of your engine is defective, the part will be repaired or replaced by Prevost. This is your emission control system DEFECTS WARRANTY.

OWNER'S WARRANTY RESPONSIBILITIES:

As the motor vehicle engine owner, you are responsible for the performance of the required maintenance listed in this manual. Prevost recommends that you retain all receipts covering maintenance of your vehicle, but Prevost cannot deny warranty solely for the lack of receipts or for your failure to ensure the performance of all scheduled maintenance listed in other manuals which were supplied with your vehicle. You are responsible for presenting your motor vehicle engine to a Prevost Service Center as soon as a problem exists. The warranty repairs should be completed in a reasonable amount of time, not to exceed 30 days. As the motor vehicle engine owner, you should also be aware that Prevost may deny you warranty coverage if your vehicle or a part has failed due to abuse, neglect, improper maintenance, or unapproved modifications. If you have any questions regarding your warranty rights and responsibilities, you should contact the Prevost Department 850 Chemin Olivier, St-Nicolas, Qc, G7A 2N1, Canada, Fax 418-831-9301, or the California Air Resources Board at 9480 Telstar Avenue, El Monte, California 91731. **(Applicable only to vehicles and/or engines certified for sale and registered in the State of California)** Prevost warrants the Emission Control Systems on each new VOLVO diesel engine in a new Prevost coach to comply with all State of California emissions regulations applicable at the time of manufacture of the engine, and to be free from defects in material and workmanship under normal use and service up to 60 months or 160 000 km (100,000 miles), whichever occurs first, provided all Prevost maintenance requirements are followed as described in this manual. All warranty periods are calculated from the date-in-service of the new vehicle. The repair or replacement of defective parts will be made without charge for the cost of parts and, if repairs are made at an authorized Prevost Service Center, there will be no charge for labor. Prevost's obligation under this warranty is limited to the repair or replacement, at Prevost's option, of any part(s) of Emission Control Systems of such engine and/or vehicle found to be defective upon examination by Prevost and provided that such part(s) were returned to Prevost or its nearest authorized Dealer within a reasonable period of time.

Qualifications and Limitations:

Not covered by the Emissions Control Systems Warranty:

- Malfunctions caused by misuse, improper adjustments, modification, alteration, tampering, disconnection, improper or inadequate maintenance and use of improper diesel fuel or DEF.
- Damage resulting from accident, acts of nature or other events beyond the control of Prevost
- Inconvenience, loss of use of the vehicle, commercial loss of any kind including, but not limited to, consequential or incidental damages.
- Any vehicle in which the odometer has been altered or damaged so that mileage cannot be readily determined.

THIS WARRANTY IS EXPRESSLY IN LIEU OF ALL OTHER WARRANTIES AND REPRESENTATIONS OR CONDITIONS, STATUTORY OR OTHERWISE, EXPRESSED OR IMPLIED INCLUDING, BUT NOT LIMITED TO, IMPLIED WARRANTY OF MERCHANTABILITY OR FITNESS FOR A PARTICULAR PURPOSE.

Emissions Control System Warranty

The following engine components are covered by the supplemental emissions control system warranty policy as required by the California code of regulations.

- 1 Engine Turbocharger Assembly
 - Engine VGT Actuator
- 2 Engine Charge Air Cooler (CAC)
 - CAC Pipes (Air inlet to/from CAC)
 - CAC Hoses
- 3 Engine Control Module (ECM)
- 4 Engine Injectors
- 5 Engine and Vehicle Wire harness (repair to circuits related to Emissions Warrantable Components)
- 6 Exhaust Gas Recirculation (EGR) Mixer Tube
- 7 EGR Cooler
- 8 EGR Valve and EGR Valve Control
- 9 EGR Pipes - Engine Exhaust Manifold to EGR Cooler
- 10 EGR Pipes - EGR Cooler to Inlet Manifold
- 11 Crankcase Breather
- 12 Engine Crankcase Breather Oil Separator
- 13 Crankcase Tubing and Hoses before Separator
- 14 Aftertreatment Wiring Harness
- 15 Aftertreatment Control Module (ACM)
- 16 Aftertreatment Diesel Particulate Filter (DPF) Assembly
 - A. Aftertreatment DPF Assembly with Aftertreatment Diesel Oxidation Catalyst (DOC)
 - Aftertreatment Hydrocarbon Doser
 - Diffuser Pipe (Aftertreatment Hydrocarbon Doser Mounting)
 - Fuel lines to Aftertreatment Hydrocarbon Doser
 - Aftertreatment Fuel Shutoff Valve
 - Aftertreatment Fuel Pressure Sensor
 - Discharge Recirculation Valve (DRV) (Heat Mode)
 - Discharge Recirculation Valve (DRV) Solenoid
 - Engine Turbocharger Compressor Bypass Actuator (Heat Mode)
 - Engine Turbocharger Compressor Bypass Actuator Solenoid
 - Engine Exhaust Gas Temperature (EGT) Sensor
 - Aftertreatment DPF Intake Temperature Sensor
 - Aftertreatment DPF Outlet Temperature Sensor
 - Aftertreatment DPF Differential Pressure Sensor
 - Aftertreatment Hydrocarbon Doser Air Supply Regulator (if applicable), Supply Lines and Fittings
 - Engine Exhaust Gas Temperature (EGT) Sensor

17 Sensors:

- Crankshaft Position (CKP) Sensor
- Camshaft Position (CMP) Sensor
- Engine Coolant Temperature (ECT) Sensor
- Intake Manifold Air Temperature/ Pressure Sensor
- EGR Temperature Sensor
- Aftertreatment Outlet NOx Sensor
- Aftertreatment Intake NOx Sensor
- EGR Differential Pressure Sensor
- Ambient Air Temperature (AAT) Sensor

18 SCR

- Aftertreatment Selective Catalytic Reduction (SCR) Catalyst
- Aftertreatment Diesel Exhaust Fluid (DEF) Pump
 - Aftertreatment DEF Dosing Absolute Pressure Sensor

- Aftertreatment DEF Return Valve
- Aftertreatment DEF Dosing Valve
- Aftertreatment DEF Tank
- Aftertreatment DEF Tank Heater/Sender
- Aftertreatment DEF Tank Heater
- Aftertreatment DEF Tank Heater Valve
- Aftertreatment DEF Tank Temperature Sensor
- Aftertreatment DEF Level Sensor
- Aftertreatment DEF Heated Lines

19. Instrument Cluster (Repair of microprocessor , OBD MIL, Real Time Clock, Aftertreatment DEF Tank Gauge and, Aftertreatment DEF Tank Low Level Indicator)

20. Exhaust Gas Piping (from Turbocharger to Aftertreatment System)

21. Data Link Connector (DLC)

Emission Green House Gas Component Warranty (If Equipped)

Critical Emissions-Related Maintenance

Source of parts and repair: A repair shop or person of the owner's choosing must maintain, replace, or repair emission control devices and systems per manufacturer's recommendations.

Replacement of tires that are GHG certified: The original equipment tires installed on this vehicle at the factory were certified to the U.S. EPA Greenhouse Gas (GHG) and National Highway Traffic Safety Administration (NHTSA) Fuel Efficiency regulations. Replacement of these tires should be with a tire of equal or lower rolling resistance levels (TRRL or Crr). Please consult your tire supplier(s) for appropriate replacement tires.

Maintaining a GHG certified tire: In order to maintain the certified rolling resistance of the tires which optimize fuel economy, the maintenance procedures provide by the tire manufacturer must be followed.

Please visit PrevoSt Web Site for further information about Warranty.

Engine Brake

The engine brake is operated by the Engine Brake buttons on the steering wheel. It works together with the exhaust brake to provide two levels of braking power. There are three Engine Brake buttons on the steering wheel: OFF, (1) LOW and (2) HIGH. When the Engine Brake button (1) LOW is depressed, only the exhaust brake is engaged. When the Engine Brake button (2) HIGH is depressed, both the exhaust brake and the compression brake are activated. The following conditions must be met:

- Engine Brake button (1) LOW or (2) HIGH depressed
- Engine Brake/Transmission Retarder selector switch is set to Engine Brake position (selector switch can be found on the dashboard only if the vehicle is equipped with both systems)
- Vehicle speed over 12 km/h (7.5 mph)
- Engine temperature over 43°C (110°F)
- Accelerator pedal is released
- Engine speed exceeds 1150 rpm

Engine Components, Service Schedules

Component	Operation	Km (Miles)/Maximum Months/Hours
Engine Fuel Filter	Change	Each oil change *
Water Separator	Filter change	Each oil change *
Air Filter US 2010	Change	160 000 (100,000) or 12 months, whichever comes first
Engine Coolant	Change	500 000 (300, 000) or 24 months, whichever comes first
Engine Coolant (ELC)	Change	1 000 000 (600,000) or 48 months, whichever comes first
Coolant Filter US 2010	Change	80 000 (50,000) or 6 months, whichever comes first
Engine Coolant Filter (ELC) US 2010	Change	240 000 (150,000) or 12 months, whichever comes first
Valves/Engine Injectors **	Initial Adjust	200 000 (125,000) or 12 months, whichever comes first
Valves/Engine Injectors **	Adjust	400 000 (250,000) or 24 months, whichever comes first
Catalyzed DPF Filter (If equipped)	Change	400 000 (250,000) or 4,500 hours, whichever comes first.
Aftertreatment Diesel Exhaust Fluid Dosing Valve	Clean	240 000 (150,000) or 4,500 hours, whichever comes first.
Aftertreatment Diesel Exhaust Fluid (DEF) Pump Filter	Change	First Change; 161 000 (100,000), 3200 hours or three (3) years. Then every 241 000 (150,000) 4800 hours or three (3) years, whichever comes first.
Diesel Exhaust Fluid (DEF) Tank Filler Neck Filter Cleaning	Clean	280 000 (175,000) or 12 months, whichever comes first.

*Under certain conditions (for example, irregular fuel quality), the fuel/water separator filters may require more frequent replacement.

**Valves must be adjusted whenever the rocker shaft has been removed and reinstalled for any reason.

Cooling System

General Coolant Information



DANGER

Coolant is toxic; risk of poisoning. DO NOT drink coolant. Use proper hand protection when handling. Keep coolant out of reach of children and animals. Failure to follow these precautions can cause serious illness or death.



WARNING

Coolant may be combustible. Coolant leaked or spilled onto hot surfaces or electrical components can cause a fire. Clean up coolant spills immediately.



WARNING

DO NOT raise the engine hood if you see or hear steam or coolant escaping from the engine compartment. Wait until steam or coolant cannot be seen or heard before raising the hood.

DO NOT remove the coolant fill cap if the coolant in the surge tank is boiling. Also, DO NOT remove the cap while the engine and radiator are still hot. Scalding fluid and steam may be blown out under pressure if the cap is taken off too soon and can cause personal injury.



CAUTION

Prevost and Volvo Bus Corporation does not recommend using plain water in the cooling system. Water alone is corrosive at engine operating temperatures and does not provide adequate boiling protection. The engine may develop corrosion and cavitation problems in the engine and radiator, and the boiling point of the coolant is lowered compared to a proper antifreeze and water mixture. Failure to follow Prevost and Volvo Bus Corporation cooling system care/maintenance recommendations can render the warranty invalid.

The main purpose of coolant is to transport heat from the hot parts of the engine to the radiator and to protect the cooling system from corrosion.

In addition to this, the coolant must:

- Protect against pitting and cavitation erosion damage of the water pump and cylinder liners.
- Protect against freezing and boiling.
- Prevent formation of scale, sludge deposits and clogging.
- Be harmless to polymer materials and seals in the cooling system.
- Maintain its liquid properties in cold climates.

Many engine failures can be traced back to a problem in the cooling system. If the coolant level is allowed to go below the bottom of the tank, there is the risk of the engine shutting down. See the operators manual for more information on the warning functions.

Note: Always dispose of coolant according to Federal or local regulations. Take all used coolant to a recycling or waste collection center.

Coolant mixture consisting of an antifreeze solution in water should be used year-round to provide freeze and boil-over protection as well as providing a stable environment for seals and hoses.

Note: DO NOT use antifreeze formulated for automobile gasoline engines. These have a very high silicate content that will clog the radiator and leave unwanted deposits in the engine.

Freeze Protection Down To:	Percentage of Antifreeze in Mixture
– 25°C (– 13°F)	40%
– 30°C (– 22°F)	46%
– 38°C (– 36°F)	54%
– 46°C (– 51°F)	60%

A well functioning and maintained cooling system is as important to the engine as performing regular oil changes or using good fuel. To get the best result use quality products and service the system at the correct intervals. Please read this section carefully.

Keep the radiator (including charge air cooler) and the frontal area free from bugs, dirt, leaves, etc.

Check the coolant level in the tank regularly. Fill the tank as necessary with the correct coolant.

Inspection of the whole cooling system is important. Check for swollen or deteriorated heater and radiator hoses, loose hose clamps and connections, and radiator leaks.



DANGER

DO NOT work near the fan with the engine running. The engine fan can engage at any time without warning. Anyone near the fan when it turns on could be seriously injured. Before turning on the ignition, be sure that no one is near the fan.



CAUTION

Never add coolant to a hot or overheated engine. Engine damage can result. Allow the engine to cool first.

Additives

Additives help prevent rust, scale and mineral deposits from forming. Additives also protect metals from corrosion, prevent water pump and cylinder liner cavitation and contain anti-foaming agents. Additives are depleted during normal engine operation and need to be **replaced**. For non-extended life coolant mixture, this means the addition of **Supplemental Coolant Additives (SCA)** at any time the additive goes below the recommended level. For extended life coolant mixture, this means an extender package added halfway through the coolant lifetime.

70 VOLVO Engines

Regular Coolant Change Interval

Coolant SCA level must be tested at least twice per year or whenever coolant loss occurs. For maximum coolant system efficiency, test the system at every engine oil change interval, every 1,000 hours or every 6 months (whichever comes first). For proper SCA levels, consult Service Manual.

Regular Coolant Filter Change Intervals



WARNING

Hot engine. Keep clear of all hot engine parts and fluids. A hot engine and fluids can cause serious burns.

The charged coolant filter contains 8 units of SCA that are released slowly over time to maintain the recommended level during operation. Consult engine service manual for proper SCA level and change intervals.

Extended Life Coolant Change Interval



WARNING

Hot engine. Keep clear of all hot engine parts and fluids. A hot engine and fluids can cause serious burns.



CAUTION

Extended life coolant will test as out of additives (SCA), but SCA should not be added. Shortened engine life may be the result of adding SCA.



CAUTION

DO NOT use a filter that contains SCA. Damage to components can result.

Note: DO NOT add supplement coolant additives (SCA) to extended life coolant.

Should the extended life coolant system become contaminated with regular coolant exceeding 10% of the systems total capacity or if SCA is added to extended life coolant, drain the system and refill with new extended life coolant or regular coolant.

VOLVO

Volvo Bus Corporation

Göteborg, Sweden

Addendum, Driver's Handbook 9700 US/CAN

Instruments and controls, 9700 US/CAN

Please read the following updated information regarding Instruments and Controls. Disregard information on page 27 of the current Driver's Handbook 9700 US/CAN, B13R, Publication no. PV776–89052801 (04.2013).

This document applies for following chassis ID:

- 162000
- 162492 — 162501
- 162609 — 162610
- 163096 — 163103
- 163728 — 163729
- 164039 — 164044
- 164349 — 164357
- 164470 — 164471
- 165054
- 165368 — 165382
- 165476 — 165486
- 166746 — 166757
- 166926 — 166937
- 167451 — 167455
- 167539 — 167543
- 168149
- 168560 — 168569
- 169565
- 169811
- 170076
- 170237 — 170240
- 170550 — 170555
- 171277 — 171280
- 171281 — 171284
- 171371 — 171372
- 171375
- 171421 — 171422

















Reason for updating:

For symbol current meaning is “**Hill Start Assistance**”, should be “**Door Brake Activated**”.

For symbol current meaning is “**Brake Air Pressure Circuit 1**”, should be “**Brake Air Pressure Circuit 2**”.

See following table:

2 Instruments and controls 27

	Stop at the next bus stop		
	Door brake activated		Kneeling activated (for easier access)
	DEF Low Level		Battery not charging
	Pre-heating ON		OBD – On-Board Diagnostics
	Screen / mirrors heating activated		Differential lock activated
	The switch for increasing load on the drive axle (bogie lift) of the bogie is on		
	Tachograph event		ABS not functioning
	Brake Air Pressure Low		DPF Regeneration Required
	High Exhaust System Temperature (HEST)		Brake Air Pressure Circuit 1
	Brake Air Pressure Circuit 2		