

# Driver's Handbook

## Volvo 9700 US/CAN

B13R, EPA14



W0110945

# **VOLVO**

# Foreword

The following levels of observations, cautions and warnings are used in this Service Documentation:

**Danger:** Indicates an unsafe practice where serious personal injury or death could occur.

**Warning:** Indicates an unsafe practice where personal injury or severe damage to the product could occur.

**Caution:** Indicates an unsafe practice where damage to the product could occur.

**Note:** Indicates a procedure, practice, or condition that must be followed in order to have the vehicle or component function in the manner intended.

This manual contains information concerning the operation and function of the Volvo 9700 “US/CAN” version. Equipped with 3rd generation of the multiplex electrical system **BEA-3** (Bus Electrical Architecture, version 3) and the diagnostic protocol **OBD 16** (*On Board Diagnostics, 2016*).

The information in this manual applies to vehicles complying with **EPA 14** Emissions level standard.

This manual contains general information about instruments and controls, as well as driving instructions. In case a bus is not equipped with all functions described in this manual, it is due to the custom adaptation and different levels of equipment.

## Volvo Bus Corporation

Göteborg, Sweden

**Order number: 89253584**

©2016 Volvo Bus Corporation, Göteborg, Sweden

All rights reserved. No part of this publication may be reproduced, stored in retrieval system, or transmitted in any forms by any means, electronic, mechanical, photocopying, recording or otherwise, without the prior written permission of Volvo Bus Corporation



# Foreword

For service information, please refer to our service manuals and other service literature. The section “If something happens”, page 143 provides information and instructions to be followed when something unexpected happens.

Technical data, construction information, descriptions and illustrations in this driver’s handbook, that were current when the book was published, can have been changed. The Volvo company reserve the right to make changes without prior notice.

The National Highway Traffic Safety Administration (NHTSA) and Prevost should be informed immediately if you believe that the vehicle has a defect that could cause a crash, injury or death.

Contact NHTSA by calling the Auto Safety Hotline at 1 (888) 327-4236, by writing to NHTSA, U.S. Department of Transportation, Washington, DC 20590, by TTY at 1 (800) 424-9153, or visit their website at: [www.nhtsa.dot.gov](http://www.nhtsa.dot.gov).

Please keep this manual in the vehicle at all times.

**Note:** Illustrations in this manual are used for reference only and may be differ slightly from the actual vehicle. However, key components addressed in this document are represented as accurately as possible.

## Volvo Bus Corporation

Göteborg, Sweden

**Order number: 89253584**

©2016 Volvo Bus Corporation, Göteborg, Sweden

All rights reserved. No part of this publication may be reproduced, stored in retrieval system, or transmitted in any forms by any means, electronic, mechanical, photocopying, recording or otherwise, without the prior written permission of Volvo Bus Corporation



---

# Contents

<b>Introduction</b> .....	<b>1</b>
Driver's responsibility .....	1
Keys .....	2
Key and cylinder replacement .....	3
Entering the bus .....	4
Emergency stop.....	5
Protection against batteries discharge.....	5
<b>Doors and hatches</b> .....	<b>6</b>
Doors.....	6
Opening the bus from inside .....	7
Closing the bus.....	8
Hatches and doors opened warning .....	9
Doors and hatches configurations .....	9
Doors and hatches configuration.....	10
Doors and hatches configuration (bus with WCL) .....	11
Roof Hatches.....	12
<b>Driver's area</b> .....	<b>13</b>
Driver's area .....	13
Driver's seat.....	14
Driver's seat features label.....	15
Horn .....	16
Dashboard .....	17
<b>Instruments and controls</b> .....	<b>18</b>
Faults and warnings .....	18
Accelerator pedal deactivated.....	19
STOP message .....	20
Warning message .....	20
Stop at the next bus stop message.....	20
Instrumentation .....	21
Types of instruments .....	21
Instrument panel lamps and symbols.....	27
Lights switch.....	29
Switches .....	31
Emergency stop switch .....	31
Kneeling system.....	32
Level control .....	33
Increasing load on the drive axle (bogie lift).....	34
Traction Control System (TCS).....	34
Differential lock .....	35
Hill start assistance (optional).....	35
Retarder enabled (if installed).....	36
Passenger compartment lighting .....	36
Night lighting (optional).....	36

Half-light lighting .....	37
Driver compartment lighting.....	37
Passenger’s individual lighting .....	37
Position lights .....	38
Destination sign lighting (optional) .....	38
Electrically heated rear view mirrors .....	39
Driver window heating .....	39
Driver blower .....	39
Central locking.....	40
Sun visor .....	40
Toilet activation .....	40
Audio system .....	41
Opening service door from the outside.....	41
Wheel Chair Lift (WCL) system; (optional).....	42
Emergency window in use indicator lamp.....	43
Wheel Chair Lift (WCL) system indicator light.....	43
Switches into the electrical center.....	44
Controls.....	46
Ignition switch .....	46
Adjusting external rear view mirrors .....	48
Open door brake.....	49
Steering wheel adjustment.....	51
Directional indicator, dipped/full beam changer.....	52
Windscreen wipers, windscreen headlight washer .....	53
Transmission.....	54
I-Shift transmission lever selector (optional).....	54
I-Shift transmission pad selector.....	55
Allison automatic transmission (optional).....	56
Allison transmission shifter .....	57
Allison transmission, mode function .....	58
Transmission overheating.....	59
Retarder (if installed).....	60
Retarder overheating.....	61
Brakes .....	62
Parking brake .....	62
Blocking valve .....	64
Service brakes.....	65
EBS (Electronically-controlled Braking System).....	67
Compensating for differences in the wear of the brake pads.....	68
High brake temperature warning .....	69
A/C Controller (multiplexing system).....	70
Destination sign (optional).....	71
Destination sign Innova .....	72
Destination sign Mobitec .....	73
<b>Interior equipment.....</b>	<b>74</b>

---

Interior equipment.....	74
Toilet.....	75
Rear trash bin.....	75
Passengers thermometer and clock display.....	76
Passengers panel.....	77
Passengers AC (alternate current) 110 V power outlets.....	78
TGW (Telematics Gate Way) system and Liaison communication system.....	80
Passengers sliding seats.....	81
Control pendant (for Wheel Chair Lift equipment).....	82
<b>Audiovisual system.....</b>	<b>83</b>
Audiovisual system.....	83
Audiovisual control panel.....	84
Video system.....	84
Audio system.....	85
Guide or driver microphone (optional).....	86
<b>Emergency and safety equipment.....</b>	<b>87</b>
Overview.....	87
Fire extinguisher.....	88
Automatic Fire Suppression System (AFSS).....	89
Park pilot system.....	91
Tire Pressure Monitoring System (TPMS).....	92
Warning triangle.....	94
First aid kit.....	94
Tire inflation valve.....	95
External air supply connection.....	95
Hydraulic jack.....	96
Toolbox.....	97
Engine control panel in engine bay.....	98
Emergency exits.....	99
Doors.....	99
Roof hatches.....	100
Emergency windows.....	101
<b>Starting and driving.....</b>	<b>102</b>
Checking before driving.....	102
Bus interior and exterior cleaning and maintenance.....	103
Check the warning lights.....	104
Daily inspection.....	105
Engine oil level.....	105
Hydraulic level fluid for the engine coolant fan.....	106
Power steering hydraulic oil level.....	106
Engine coolant system fluid level.....	106
Windshield washer fluid.....	107
Fuel replenishment.....	108

---

Diesel Exhaust Fluid (DEF) tank.....	110
Engine block heater.....	112
Starting the engine.....	113
Starting.....	113
Indicator lights on after the engine has been started.....	115
Engine idle speed adjustment.....	116
Cruise control activation.....	118
Retarder (if installed).....	120
Power steering.....	125
Exhaust Aftertreatment System (EATS) components.....	126
Exhaust Aftertreatment System (EATS), warnings.....	127
Diesel Particulate Filter (DPF) regeneration required icon.....	128
High engine exhaust system temperature.....	129
Emission green house gas component warranty.....	130
I-Start system.....	131
I-Start system (continue).....	132
I-Start system failure detection.....	133
ARMS (Automatic Reset Main Switch).....	135
I-Start system power relays.....	136
Batteries charger.....	137
Bulk charge time estimation.....	138
<b>Some advice for driving.....</b>	<b>139</b>
Safe driving.....	139
Economy driving.....	140
Driving in cold weather.....	141
QR code labels.....	142
<b>If something happens.....</b>	<b>143</b>
Assistance and rescue on highway.....	143
Safety.....	144
If the engine is not working.....	145
Punctures.....	147
Punctured air bellows.....	147
Towing.....	148
Towing (continue).....	149
Bus towing considerations.....	150
Alternative towing procedure.....	151
Additional fire detection system (multiplexed).....	153
Releasing the parking brake.....	154
Release the parking brake with air from the bus tires.....	154
Parking brake mechanical releasing.....	155
Parking brake on disc brakes mechanical releasing.....	156
Change the batteries.....	157
Starting assistance.....	159
Jump start batteries procedure.....	160

---

Jump start batteries procedure warnings.....	161
Ground stud for jump start batteries .....	162
Batteries cut-off switch.....	163
Bulb replacement .....	165
Headlamps.....	165
Xenon lights.....	166
Rear lights.....	166
License plate lighting.....	167
Electrical fault general lookup.....	168
Bus electrical center.....	169
Chassis electric circuit relays.....	170
Chassis electric circuit fuses.....	173
Body electric circuit relays.....	179
Body electric circuit fuses.....	180
Fuse boxes inside to the batteries compartments.....	182
Fuses and relays electrical box inside to the right hand side batteries compartment .....	183
Mini fuse box holder inside to the left hand side batteries compartment.....	186
Wheels replacement.....	187
Spare wheel.....	188
Recommendations to avoid unnecessary tire wear .....	189
Recommended tire pressures .....	190
Check of tire wear.....	191
<b>Technical data.....</b>	<b>196</b>
General dimensions.....	196
9700 US/CAN (6x2 only) .....	196
Electrical system specifications .....	197
Bulbs for lighting lamps .....	198
Engine specifications .....	199
Automatic gearbox specifications.....	200
Transmission ratios .....	200
Rear axle specifications.....	201
Wheels and tires specifications .....	202
Front wheels alignment specifications.....	203
Diesel Emission Fluid (DEF) tank specification.....	204
Vehicle identification .....	205
Bus identification plate .....	206
Vehicle Identification Number (VIN) .....	207
Engine identification labels.....	208
Vehicle emission control information label.....	209
I-Shift transmission identification plate (if installed).....	210
Allison transmission (identification plate).....	211
Rear axle identification plate .....	212
Retarder identification plate (if installed).....	213
Service intervals.....	214

---

<b>Index.....</b>	<b>215</b>
-------------------	------------



---

# Safety information

**IMPORTANT:** Before driving this vehicle, be certain that you have read and that you fully understand each and every step of the driving and handling information in this manual. Be certain that you fully understand and follow all safety warnings.

IT IS IMPORTANT THAT THE FOLLOWING INFORMATION BE READ, UNDERSTOOD AND ALWAYS FOLLOWED.

The following types of advisories are used throughout this manual:



## DANGER

Danger indicates an unsafe practice that could result in serious personal injury or death. A danger advisory banner is in **white** type on a **black** background with a **black** border.



## WARNING

Warning indicates an unsafe practice that could result in personal injury. A warning advisory banner is in **black** type on a **gray** background with a **black** border.



## CAUTION

Caution indicates an unsafe practice that could result in damage to the product. A caution advisory is in **black** type on a **white** background with a **black** border.

**Note:** Note indicates a procedure, practice, or condition that must be followed in order for the vehicle or component to function in the manner intended.

---

## Driver's responsibility

- As the driver, you are responsible for the safety and comfort of the passengers during the journey. Therefore, do not drive the bus before you have read this driver's manual. You must be familiar with all the indicators and warning lights and know what to do if something unexpected happens.
- As the driver of the vehicle, you should be aware of the vehicle weight and loading capacity. See instructions on warning stickers, the vehicle registration book and on the identification plate.
- As the driver of the vehicle, it is your responsibility to foresee any hazards that could threaten your passengers.
- It is also your responsibility to ensure that all the safety equipment of the bus is in place. Therefore check regularly the working order of safety belts, emergency door and window opening, door sensitive edges, fire extinguishers and first aid equipment.
- The brakes on the bus are operated by compressed air. Never drive if the air pressure is too low or if you discover other problems with the brakes.
- Pay attention to any steering faults. The vehicle can be steered even if the power steering is not working, although the steering will be heavy.
- Never crawl under the bus if it is supported by a “hydraulic jack”. Use approved vehicle supports or a solid pallet in case of punctures or wheel changes.
- Lifting devices and supports should stand securely on a horizontal surface. The wheels that are not to be lifted should be blocked to ensure that the vehicle will not start to move.
- Re-tighten the wheel nuts after approximately **125 mi (200 km)** if the wheels have been removed.
- Tighten the wheel nuts every **6 months** regardless of whether the wheels have been removed or not.
- Follow the recommended service and maintenance program to maintain the bus's condition and safety.
- Pay attention to exhaust and fuel smells. Any leaks should be taken care of immediately at the garage.
- The bus tires and rims should be approved for the intended load and speed in accordance with current legal requirements.

## 2 Introduction

---

### Keys

The following keys are delivered with the bus:

- 1 Ignition key.
- 2 Exterior and interior hatches and doors.
- 3 Right hand side rear service hatch and radiator service access hatch.

**Note:** There may be alternative versions of the keys, depending on the types of locks that are fitted.

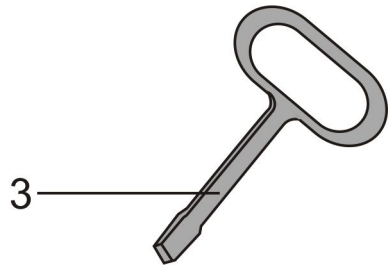
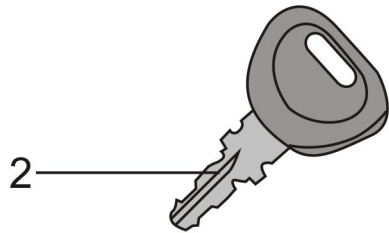
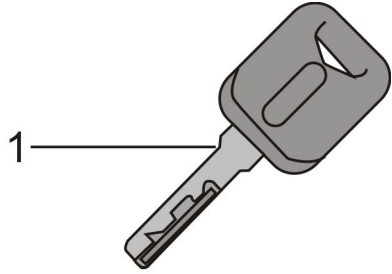

W0089523

**Note:** Note the number of the ignition key to facilitate ordering of spare keys.

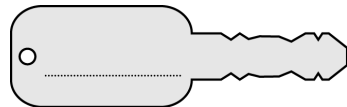

T0013333

---

## Key and cylinder replacement

In the following table its provide the part number of cylinders and keys for replacement.

Key and Cylinder Replacement	
Location	Part Number
Exterior and interior hatches and doors.	70348099 (cylinder) 70364098 (key). <sup>1</sup>
Ignition key.	8159908 (1 ignition lock + switch, 2 door locks, 2 keys).
Right hand side rear service hatch and radiator service access hatch.	70348255 (cylinder) 70319047 (key).

<sup>1</sup> Both parts (cylinder and key) must be ordered.

## 4 Introduction

---

### Entering the bus

To open the front service door proceed as follows:

- Turn the key in the lock to the horizontal position.
- Turn the knob to the vertical position.
- Push the pneumatic door opening button.

The button for the pneumatic opening of the first door is placed in the door handle.

**Note:** In case of total or partial emptying of the door pneumatic system, open the door by pushing the right side of the door.

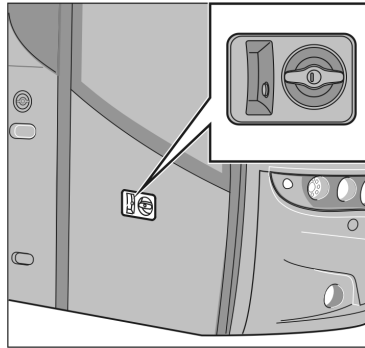

T8012405

## Emergency stop

An emergency switch is located on the left side of the dashboard. Depending on the market specification, the emergency switch may disconnect the bus electrical power supply, cut **OFF** the fuel supply and activate the hazard warning lights.

**Note:** Only use the emergency cut out in an emergency situation.

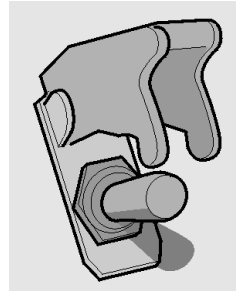

T0009170

## Protection against batteries discharge

In order to prevent battery discharge while the bus is standing, the Volvo 9700 US/CAN bus is equipped with an Automatic Reset Main Switch (ARMS; see the following section in this manual: “ARMS (Automatic Reset Main Switch)”, page 135) function that disconnects the supply to major electrical consumers such as: electric heaters, some external lighting, etc.

If the ignition switch is in position **I** + a **click**, power to these consumers is switched off around **120 seconds** (for Starter batteries it is **120 seconds** after voltage is below **23.5 V** and for Consumer batteries it is **130 seconds** after voltage is below **23 V**).

**Note:** Turn **OFF** the ignition switch to position **0**, each time the bus is out of service.

For more information about ARMS function refer to this section in this manual “I-Start system”, page 131 and “ARMS (Automatic Reset Main Switch)”, page 135.

Also see the separate operating instructions: “I-Start”.



T0014333

## 6 Doors and hatches

---

### Doors

The Volvo 9700 US/CAN bus is equipped with one single-leaf door opening outwards. The door is normally operated by pneumatic cylinders.

The door may be equipped with a system protecting passengers from being trapped in the doorway during opening or closing, this system has sensors measuring the air pressure in the door system.



T0012008

**Note:** In the case of excessive drop of the door pneumatic system air pressure, the “Door failure” warning lamp lights in the lower right corner of the bus instrument cluster.



## Opening the bus from inside

There is a button for door opening on the right hand side of the driver's dashboard. Pushing the button causes the door to open. The button indicator lamp is lit when the door is open.



### CAUTION

Before closing the door ensure that there are no passengers standing in the doorway.

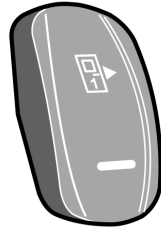

T3018176

## 8 Doors and hatches

---

### Closing the bus

To close the bus proceed as follows:

- 1 Select neutral position on the gear selector.
- 2 Engage the parking brake.
- 3 Turn on the switch that activates the door opening push-button in the door handle.
- 4 Open the door.
- 5 Turn **OFF** the power supply with the ignition key in position **0**, to refer see the following section in this manual: “Ignition switch”, page 46.
- 6 Leave the bus and close the door using the push-button in the door handle.
- 7 Lock the door with the key.

**Note:** After locking the door with the key, the push-button in the door handle becomes inactive.

After turning off the power supply with the ignition switch, the light above the entrance door remains on for about **90 seconds**.

If the button activating the button in the handle for opening the door **is not switched on**, in order to enter the bus again, the emergency valve must be used.

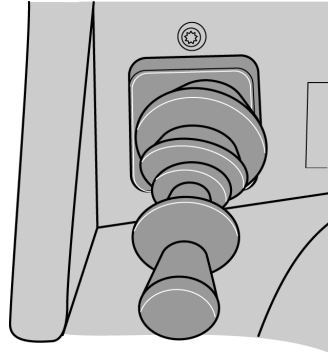

T5014881

Parking brake lever control.

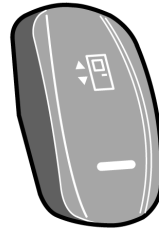

T1008555

Button for outside opening of the service door.

## Hatches and doors opened warning

If any of the bus hatches are open or not properly closed, a “hatch open” symbol will appear on the driver’s information display.

**Note:** The engine cannot be started unless the engine hatch is closed.

**Note:** With the engine hatch open, the engine can be started by means of a button in the control box, see the following section in this manual: “Engine control panel in engine bay”, page 98



T3018116

## Doors and hatches configurations

The configuration of the service doors, hatches and luggage compartment hatches depends on the bus version.

Possible configurations according to the bus version are shown in the next page. The description placed refers to items located behind the door or hatch.

# 10 Doors and hatches

## Doors and hatches configuration

### 9700 US/CAN UWCL (without Wheel Chair Lift)

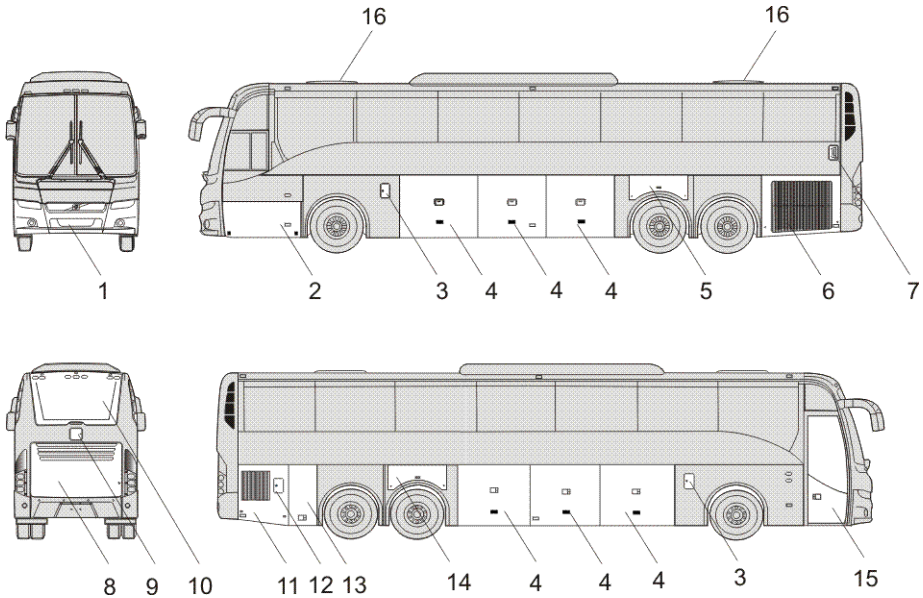

W0100254

- 1 Compartment hatch for external air valve, front towing point and spare wheel access.
- 2 Compartment hatch for tool box and washer fluid reservoir access.
- 3 Fuel filler (*left and right side*) hatches.
- 4 Luggage compartment hatches (*left and right side*).
- 5 Compartment hatch for “I-Start” battery box (*consumer side*) and fuse box access.
- 6 Radiator service hatch access.
- 7 DEF\* injector service hatch access.
- 8 Engine compartment hatch and rear towing point access.
- 9 Coolant filler hatch access.
- 10 Aftertreatment catalyst compartment panel cover for service access.
- 11 Auxiliary heater service hatch access.
- 12 DEF\* filler hatch.
- 13 Septic tank compartment hatch access.
- 14 Compartment hatch for “I-Start” battery box (*starter side*), battery cut-off switch (“*general switch*”) and fuse box access.
- 15 Service door (*passengers access*).
- 16 Roof hatches (*ventilation/emergency exits*).

\* Diesel Emission Fluid, (urea or also AdBlue®).

## Doors and hatches configuration (bus with WCL)

### 9700 US/CAN WCL (with Wheel Chair Lift)

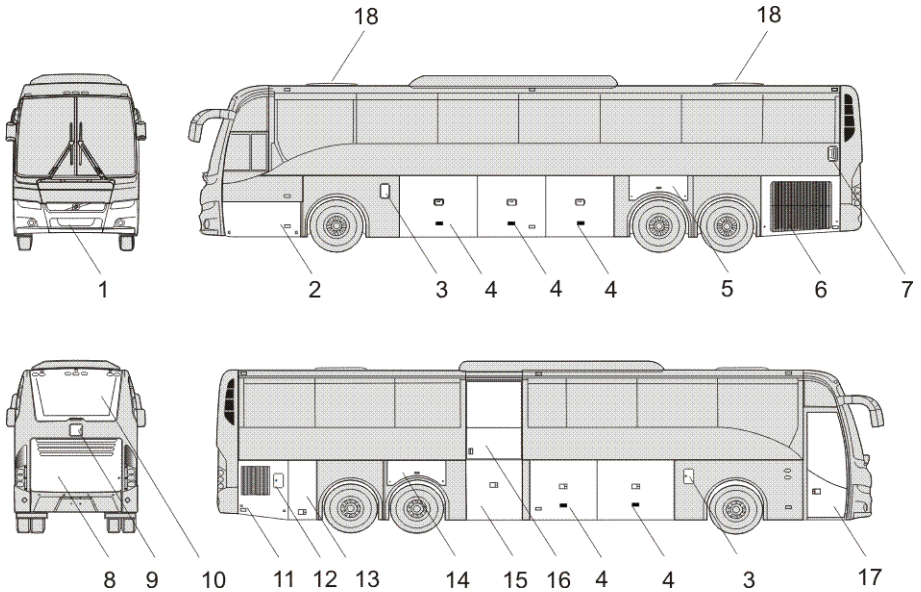

W0100253

- |   |  |
|---|--|
| <ul style="list-style-type: none"> <li>1 Compartment hatch for external air valve, front towing point and spare wheel access.</li> <li>2 Compartment hatch for tool box and washer fluid reservoir access.</li> <li>3 Fuel filler (<i>left and right side</i>) hatches.</li> <li>4 Luggage compartment hatches (<i>left and right side</i>).</li> <li>5 Compartment hatch for “I-Start” battery box (<i>consumer side</i>) and fuse box access.</li> <li>6 Radiator service hatch access.</li> <li>7 DEF* injector service hatch access.</li> <li>8 Engine compartment hatch and rear towing point access.</li> <li>9 Coolant filler hatch access.</li> <li>10 Aftertreatment catalyst compartment panel cover for service access.</li> </ul> | <ul style="list-style-type: none"> <li>11 Auxiliary heater service hatch access.</li> <li>12 DEF* filler hatch.</li> <li>13 Septic tank compartment hatch access.</li> <li>14 Compartment hatch for “I-Start” battery box (<i>starter side</i>), battery cut-off (“<i>general switch</i>”) switch and fuse box access.</li> <li>15 Compartment door for WCL* elevator system and WCL* control device access.</li> <li>16 Wheel chair door access.</li> <li>17 Service door (<i>passengers access</i>).</li> <li>18 Roof hatches (<i>ventilation/emergency exits</i>).</li> </ul> |
|---|--|

\* Diesel Emission Fluid, (urea or also AdBlue®).

\* (WCL) Wheel Chair Lift).

## 12 Doors and hatches

### Roof Hatches

The Volvo 9700 US/CAN bus is equipped with up to two roof hatches manually operated.

These hatches are manually opened by the handles on each side of the hatch to push it upward to open and allow the ventilation. In addition, the roof hatches can be used as an emergency exit.

To know how to operate the emergency exit mechanism, see the following section in this manual: “Roof hatches”, page 100 and for more roof hatches information, see separate operating instructions: “Manual roof hatch operation”.

**Note:** When the A/C is activated in the bus, its hatches should be closed, since the air coming in from outside may interfere with the operation of the equipment controlling the temperature inside the bus.

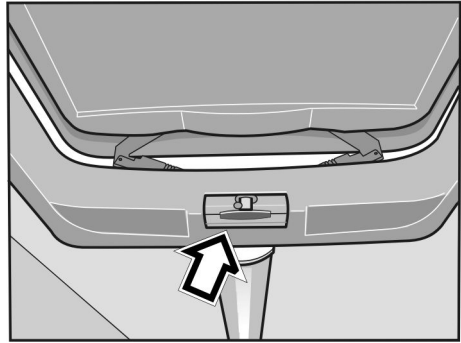

T8010110



#### CAUTION

Make sure that the hatches are closed when it's raining and when you leave the bus for a longer period of time.

## Driver's area

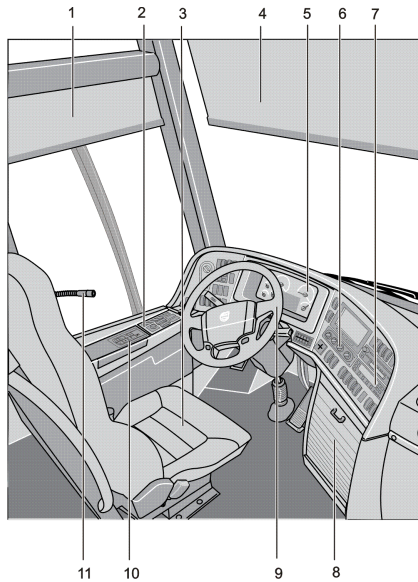

W0089969

- 1 Side sun visor.
- 2 Side panel.
- 3 Driver's seat.
- 4 Front sun visor.
- 5 Dashboard, instrument cluster.
- 6 Controller, A/C.
- 7 Controllers, audiovisual system.
- 8 Locker, audio equipment.
- 9 Steering wheel.
- 10 Gear selector pad.
- 11 Driver's microphone.

## 14 Driver's area

---

### Driver's seat

The Volvo 9700 US/CAN bus is equipped with "National Seating" driver's seat type. In some 9700 US/CAN buses a microphone is installed in the driver seat head rest. See the following section on this manual: "Guide or driver microphone (optional)", page 86, for more information.

For more driver's seat information see separate operating instructions: "Driver's seat".



W0089527

#### DANGER

Adjusting seat position or fastening a seat belt should only be performed when the vehicle is stationary. Attempting this while the vehicle is moving may be lead to an accident, causing serious personal injury or death.

**Note:** The safety belt should not be twisted or blocked when properly fastened.

**Note:** Before adjusting, check whether there are any objects in front of the seat or behind it, that could hinder adjustment.



## Driver's seat features label

On the side panel in the driver's area an informative label (A) is placed to provide ergonomic features information to the driver; the label is placed as shown on the image (B). For more information how to use the driver's seat, see separate operating instructions: "Driver's seat".

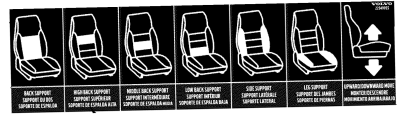

(A) Driver's seat features label.

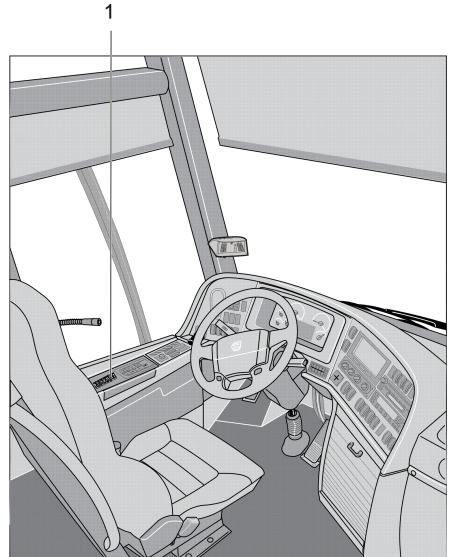

W0101026

(B) Driver's seat features label location on driver's area (1).

## 16 Driver's area

---

### Horn

The Volvo 9700 US/CAN bus is equipped with one electrical horn (diaphragm) and one operated by compressed air. Pushing the central part of the steering wheel activates the electrical horn, while pushing one of the two small buttons beneath activates the air horn.

**Note:** Remember that the use of horns is subject to regulations.

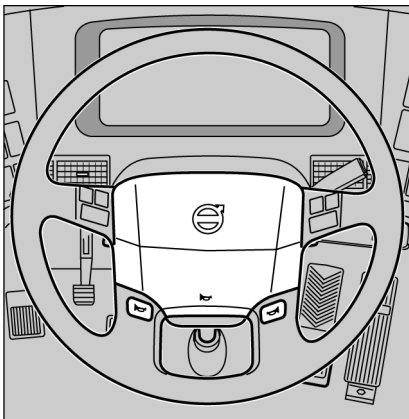

T6010187

## Dashboard

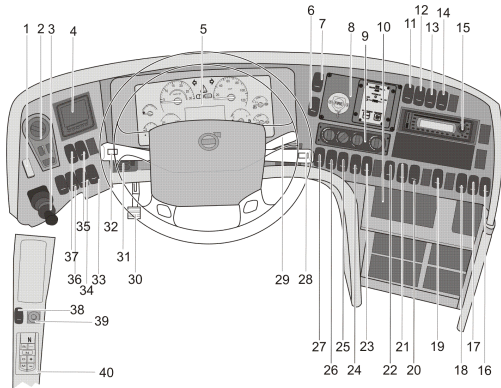

W0101128

- |  |  |
|--|--|
| 1 Emergency stop switch.                         | 22 Service first door.   |
| 2 Light switch.                                  | 23 Door lock.  |
| 3 Parking brake.                                 | 24 Night light under seats.  |
| 4 Tire monitoring system.                        | 25 Interior lights.  |
| 5 Instrument cluster.                            | 26 Reading light.  |
| 6 Delay automatic fire suppression system.       | 27 Night light.  |
| 7 Emergency windows open warning.                | 28 Display control stalk, wipers and washers control stalk.                          |
| 8 Automatic fire suppression system.             | 29 Retarder.   |
| 9 A/C controller.                                | 30 Steering wheel adjustment pedal.  |
| 10 Spare.  | 31 Air inlet.  |
| 11 Light for driver's position.                  | 32 Control stalk at the steering wheel, direction indicators and cruise control.     |
| 12 Front sun visor.                              | 33 Traction control system.  |
| 13 Wheel chair lift system enable and door ajar. | 34 Hill start auxiliary.   |
| 14 Wheel chair lift main switch.                 | 35 Bogie.  |
| 15 Audio and video system.                       | 36 Bus level.  |
| 16 Toilet activation.                            | 37 Kneeling.   |
| 17 Driver's fan.                                 | 38 Mirror heater.  |
| 18 Spare.  | 39 Mirror adjustment.  |
| 19 Central lock.                                 | 40 I-Shift selector pad or Allison transmission shifter (depends bus configuration). |
| 20 Driver's microphone enabled.                  |  |
| 21 Position lights.                              |  |

# 18 Instruments and controls

---

## Faults and warnings

There are three different types of signals that give the driver all the necessary information on the vehicle:

- **STOP** message.
- **WARNING** message.
- **Stop at the next bus stop** message.

Above the display there are three lamps for (*Stop at the next bus stop*, **WARNING** and **STOP** messages), that alert the driver's attention when necessary.

Messages with appropriate symbols are shown automatically on the display. Several messages can be active simultaneously. A new message will only replace the current message on the display if it is of higher priority. This means that the display always shows the message with the highest priority.

For more detailed information about display functions, see separate operating instructions: "Display".



T3014364

Stop message.



T3014365

Warning message.

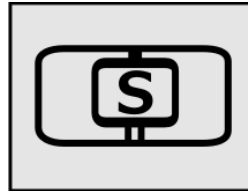

W3079585

Stop at the next bus stop message.

## Accelerator pedal deactivated

The 9700 US/CAN bus is fitted with prioritized brake function.

This function deactivates a request for acceleration if **both** the accelerator pedal and the foot brake pedal or parking brake have been activated simultaneously.

If above it happens, the accelerator pedal remains deactivated until it is reset deactivating this function (prioritized brake function), for deactivate must be fully release the service foot brake pedal or in tis case release the parking brake (see also the following section in this manual: “Parking brake”, page 62).

For additional information on this function, see separate operating instructions: “EBS system”.

**Note:** The symbol shown in the driver display when the prioritized brake function is active, also occurs; when the bus speed exceeds the permitted limit when the bus air suspension is in the highest or lowest position (see the following section in this manual: “Level control”, page 33).

For more information, see also the separate operating instructions: “display”.



T0013511

Symbol shown in the driver display when the prioritized brake function is active..

### STOP message



If this lamp lights while driving, stop the bus immediately and turn off the engine. Continuing to drive may be severely endanger the vehicle, the driver or passengers. If appears the **STOP** message while the engine is running, also its heard an audible warning buzzer.

**Note:** If the **STOP** message appears while the engine is running, it is accompanied by activation of the audible warning buzzer. °



T3014364

### Warning message

If this lamp lights, the vehicle must be taken to a workshop for repair as soon as possible. There is no immediate danger of the vehicle breaking down, and under normal circumstances it should be possible to complete the journey. This lamp is also used to draw the driver's attention to problems other than vehicle failures, e.g. as a warning in the case of an open luggage compartment hatch. °



T3014365

### Stop at the next bus stop message

Simultaneously with this lamp lighting up, a new message is shown on the display. The fact that this lamp lights up does not mean that there is something wrong with the vehicle. This lamp may for example illuminate to draw the driver's attention to low fuel level.

Acknowledge the message with **ESC** key. If the information message is still activate, it will be shown again next time the starter key is turned to the starting position. °

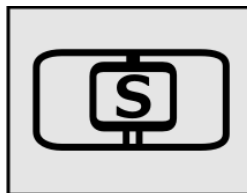

W3079585

° For more detailed information about display functions, see separate operating instructions: "Display".

## Instrumentation

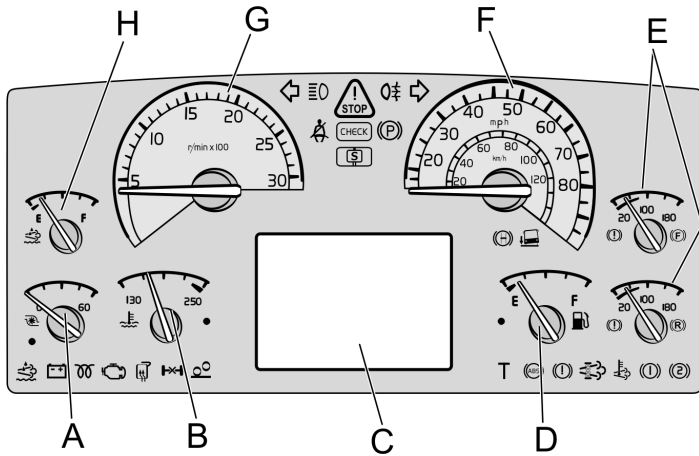

W3081293

## Types of instruments

- A Turbo pressure gauge.
- B Coolant temperature gauge.
- C For the display, see separate operating instructions: "Display".
- D Fuel gauge.
- E Air pressure gauge for circuit brakes.
- F Speedometer.
- G Tachometer.
- H Diesel exhaust fluid gauge.

## 22 Instruments and controls

### Turbo pressure gauge (A)

The turbo pressure gauge indicates the pressure in the intake manifold. A high turbo pressure increases fuel consumption. This gauge helps you drive in the most economical manner. When driving on level roads at constant speed, the pointer should remain still within the green zone.

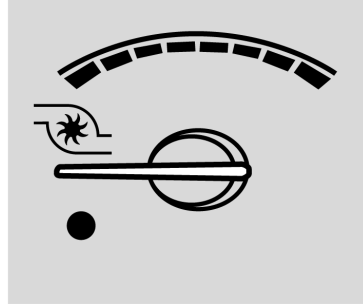

T0082692

### Engine coolant temperature gauge (B)

This gauge indicates the temperature in the engine's coolant system. Under normal driving conditions, the pointer should stay just below the red zone (normal operating temperature is between **80°C (176°F)** and **100°C (212°F)**).

The engine is fitted with overheating protection, that reduces the engine power output to **50%** if the temperature reaches the red zone. The bus can still be driven even after activation of the overheating protection.

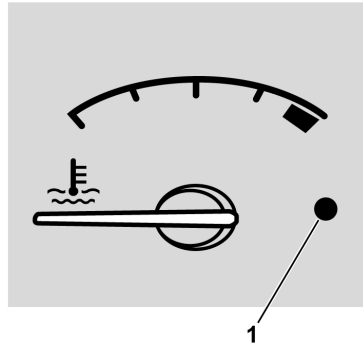

T0082691

1 Warning lamp, red.



### CAUTION

The bus must not be driven if the temperature rises even higher as this can result in damage to the engine.

An indicator signals when the cooling system temperature is too high.

- Warning lamp light (1).
- **STOP** lamp light.
- The acoustic signal sound (if the engine is running).



## Driver display (C)

The driver display consists of the main menu and several submenus with their relevant functions.

For additional information, see separate operating instructions: “Display”.

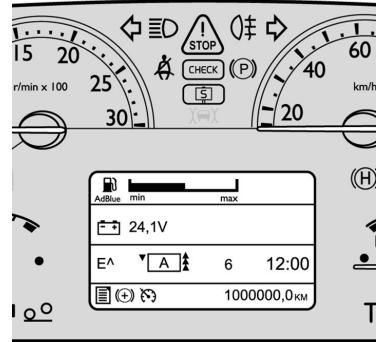

T0098814

## Fuel gauge (D)

The fuel gauge shows the amount of fuel in the tank. The red zone and the warning lamp (1) give a warning of low fuel level.

The display gives considerable information on the fuel situation, i.e. fuel consumption, **A** to **B** information and remaining fuel.

For more information, see separate operating instructions: “Display”.

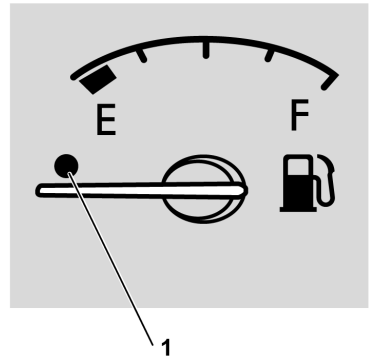

T0082696

## 24 Instruments and controls

### Pneumatic system pressure gauge (E)

#### DANGER

Stop the bus immediately if any of the warning lamps illuminate! A warning lamp will illuminate if there is an excessive pressure drop in the braking system. Investigate the cause of the fall in pressure. Failure to do so may result in failure of the vehicles brakes that may cause an accident, leading to serious personal injury or death.

If the engine remains switched off for a long time, the compressed air pressure may fall to a level which will prevent the bus being started immediately. The warning lamp remains lit until the pressure in the pneumatic system rises to a sufficiently high level. If the compressed air in the braking system has been completely exhausted, it may take quite a long time before the pressure starts to rise. During driving, the gauge pointer should remain within the green zone, but it can temporarily drop below that zone during braking.

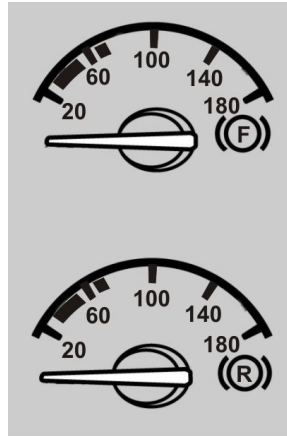

T0015292

**F** — Air pressure for front brake circuit.

**R** — Air pressure for rear brake circuit.

## Speedometer (F)

The speedometer indicates the speed of the bus in mph. For some markets, speedometers are also available that indicate speed both in mph and km/h.

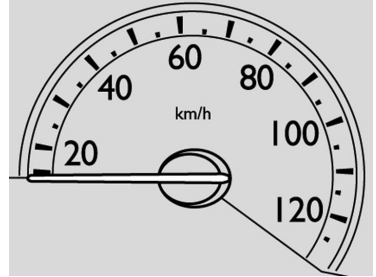

T0082695

## Tachometer (G)

The tachometer scale is divided into three zones. During normal driving you should stay within the green zone, which gives the best fuel economy.

 <b>CAUTION</b>
Avoid operating the vehicle with the tachometer in the red zone. Such high engine speeds can result in damage to the engine and the transmission.

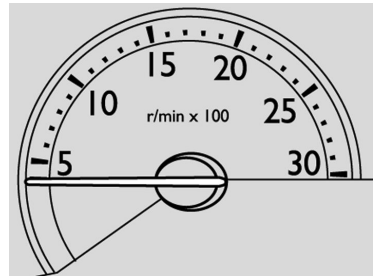

T0082694

## 26 Instruments and controls

### Diesel exhaust fluid gauge (H)

The Diesel Exhaust Fluid (DEF) gauge shows the amount of **DEF** in the tank. The red zone and warning lamp (1) give a warning of low **DEF** level.

The following will be indicate if the **DEF** level drops too low:

- If level is equal or less than about **12%** tank volume the dash lamp will light constantly, it warns drivers to fill the tank.
- If the warning was ignored and the gauge reads empty, the dash lamp starts flashing and the engine will experience a **25%** torque reduction.
- If driver continues to ignore warnings and the bus becomes stationary, the bus speed will be limited to **5 mph**.

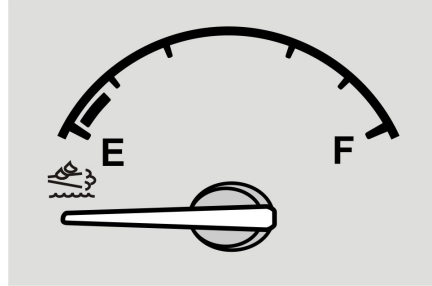

T0061352

**DEF** fluid gauge in the instrument cluster.









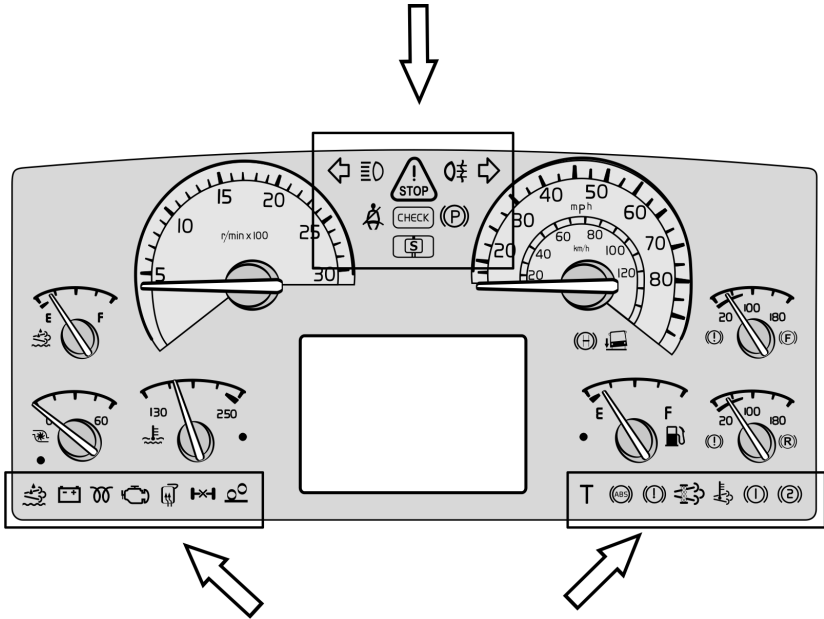



T8061207

Low **DEF** fluid symbol indicator in the instrument panel lamps.

Instrument panel lamps and symbols

















W3081294

Symbol	Meaning	Symbol	Meaning
	Left indicator ON.		Main beam.
	If there is a problem with the bus you must stop.		Fog Light Rear.
	Right indicator ON.		Safety belt reminder.
	Check.		Parking brake applied.
	Stop at the next bus stop.		Kneeling activated (for easier access).

## 28 Instruments and controls

### Instrument panel lamps and symbols (continue)

Symbol	Meaning	Symbol	Meaning
	Door brake activated.		Battery not charging.
	DEF low level.		Engine, Malfunction Indicator Light (MIL).
	Pre-heating ON.		Differential lock activated.
	Screen / mirrors heating activated.		ABS not functioning.
	The switch for increasing load on the drive axle (bogie lift) of the bogie is on.		DPF regeneration required.
	Tachograph event.		Brake air pressure circuit 1 low.
	Brake air pressure low.		Brake air pressure circuit 2 low.
	High exhaust system temperature (HEST).		

## Lights switch

- a Lights OFF or automatic activation of Dipped Beam
- b Parking Lights
- c Dipped Beam
- d Auxiliary Spotlights
- 1 Lighting Switch  
Pressing the switch turns the front fog lights on and off. Pulling it turns the rear fog lights **ON** and **OFF**.
- 2 Indication (Repeater) Lamp, Front Fog Light.
- 3 Indicator Light, Fog Light, Rear.
- 4 Instrument Lighting Rheostat.
- 5 Hazard Warning Lights.

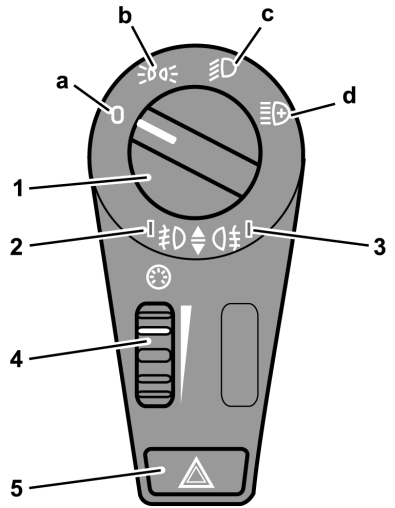

# 30 Instruments and controls

## Hazard warning lights

Pressing this button in will turn on all the bus hazard warning lights (both sets of direction indicators). The hazard warning lights will work even if both the ignition and power supply are turned **OFF** (with the main power switch through by the ignition key in position **D**).

 **DANGER**

Use the hazard warning lights if the bus is stopped in a manner that may put other road users at risk. Failure to do so may lead to an accident, resulting in serious personal injury or death.

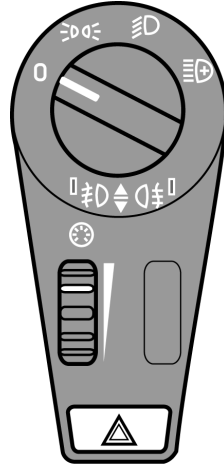

T0014325

Two rear upper lights (**A**; at each side of the bus) works as direction indicators and hazard warning lights  
When exterior lights switch is at **ON** position, five upper rear lamps (**B**) turns on.

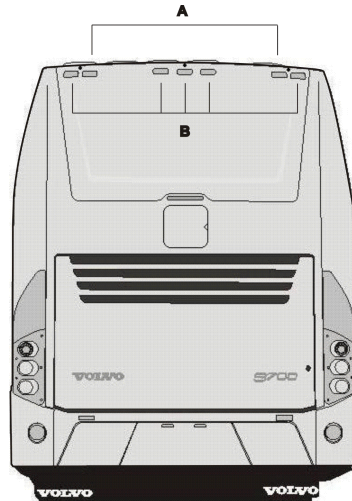

W0089559



## Switches

The number of switches depends on the bus specification.

### Emergency stop switch

**Note:** Only use the emergency stop switch only in an emergency situation as: A fire, collision or accident; **to switch off the bus electrical feed in normal conditions place the ignition key in 0 position** (see the following section in this manual: “Ignition switch”, page 46).

When the emergency stop is activated the following occurs (can vary from country to country):

- Air is exhausted from the door system.
- Engine is stopped.
- Power supply to the main electrical consumers is cut **OFF**.
- Fuel supply to the engine is cut **OFF** and so is outflow of fuel from the tanks.
- Hazard lights are switched **ON**.
- Lights above the doors are switched **ON**.

Activate the emergency cut out by lifting the cover (in red color) upwards and pressing up the switch. When the red color cover is closed the power switch automatically is pressed down to the disconnected position.

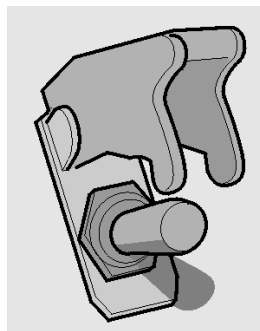

T0009170



#### CAUTION

If use the emergency stop switch to turn **OFF** the bus electrical power, may be have a batteries or accumulators fully electrical charge consuming risk, due when turn this switch some bus components are put into operation for the emergency mode and remaining active until emergency stop switch its turned **OFF**. To avoid this, place the ignition key in position **0** (to refer see the following section in this manual: “Ignition switch”, page 46 or use **only under a normal conditions the cut-off switch** (to refer see the following section in this manual: “Batteries cut-off switch”, page 163 to disconnect the bus electrical power.

## 32 Instruments and controls

### Kneeling system

The Volvo 9700 US/CAN is equipped with a kneeling system to facilitate the entering in the bus, which is controlled by a switch located in the dashboard. This switch allows the right-hand side of the bus to be lowered (*kneeling*) to a level that facilitates passenger entry and exit.

There are two possible operating modes for the kneeling switch:

- 1 The bus lowers while the kneeling switch is depressed. After reaching the lowest level, i.e. entry/exit level, kneeling stops and the switch can be released. Releasing the switch prior to reaching the lowest level causes the bus to return to the normal ride height.
- 2 Pressing the switch once lowers the bus to its lowest level for entry/exit.

When kneeling function is active, an icon in the instrument cluster lit and a blinking lamp is activated at the door as well an acoustic signal.

#### Various ways to resume normal riding height:

- Pressing the upper part of the switch.
- Closing the door.
- Starting the bus and accelerating beyond **3 mph (5 km/h)** road speed (only buses without door brake function).
- Restarting the engine.

#### Conditions for kneeling:

- Engine idle running (vehicle stopped).
- Bus without courtesy step.

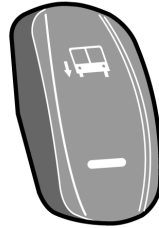

T0012054

Switch in the dashboard.

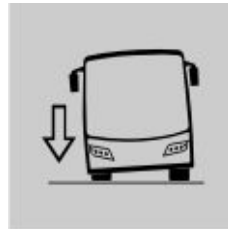

W0081879

Icon lit in the dashboard.



#### WARNING

Ensure that the bus can kneel without the risk of trapping passengers' feet between the door sill and the curb. Failure to do so may result in serious personal injury.

## Level control

The ground clearance of the bus (suspension height) can be adjusted with this switch.

- To lower the bus press the lower part of the switch, e.g. while passing under a low bridge.
- To raise the bus press the upper part of the switch, e.g. while driving onto a ferry.

**Note:** Levelling control should only be used temporarily. During normal driving the switch **must** be in the middle position.

When the bus reaches the selected level a symbol is shown on the display panel. The suspension system attempts to keep the bus at a constant ride height independent of the load. Any faults in the system are indicated by a symbol on the display panel.

**Note:** If the air suspension of the bus is in the highest or lowest position and the bus speed exceeds **12 mph (20 km/h)**, a message alert is sent to the display driver, therefore, the acceleration pedal is deactivated (Showing the corresponding symbol on the driver display, see the following section on this manual: “Accelerator pedal deactivated”, page 19).

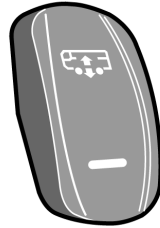

T0012058

Switch in the dashboard.



W0108964

Air suspension system is working.



T0012224

Low pressure in the air suspension system.



W0108966

Fault in the air suspension system.

## 34 Instruments and controls

### Increasing load on the drive axle (bogie lift)

The drive axle load is increased by pressing this switch. Increase in drive axle load is often an advantage when moving on slippery surfaces.

Pressing this switch increases the load on the driving axle by removing the suspension load on the trailing (non-driving) axle.

**The unweighting continues until one of the following takes place:**

- Speed of the bus rises above **20 mph (30 km/h)**.
- The switch is pressed again.

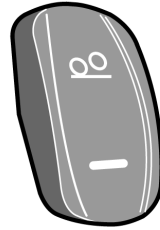

T0012046

Switch on the dashboard.

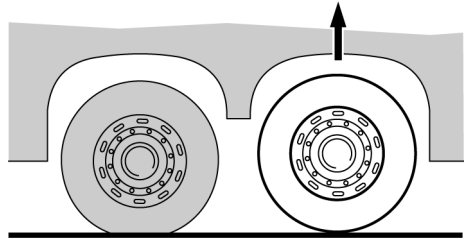

T6009559

Tag axle lift.

### Traction Control System (TCS)

The TCS system automatically reduces the driving torque of the engine if the drive wheels start to spin.

At speeds below **25 mph (40 km/h)** the TCS system also acts as an automatic differential brake, braking the driving wheel that begins to spin.

For more information, see separate operating instructions: “EBS system”.

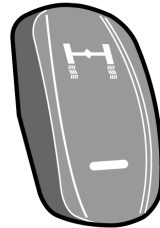

T0012059



#### CAUTION

Turn off the TCS before towing. Failure to do so may result in damage to the system components.

## Differential lock

Differential lock allows drive axle shafts to be connected together. The wheels then rotate at the same speed, which makes driving on slippery surfaces easier.

The differential lock is only to be used on slippery surfaces. Engage as soon as the bus is on the slippery surface. It can be coupled in during driving, at any speed, but will not actually engage until the bus is travelling at less than **10 mph (15 km/h)**.

**Note:** Do not forget to disengage the differential lock when you have left the slippery surface! For more information, see separate driver instructions “EBS system”.

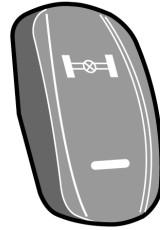

T0012041

3 stage switch for the manual/automatic coupling of the differential lock.

 <b>CAUTION</b>
<p>The differential lock is only to be used on slippery surfaces. Other uses may result in damage to the drive axle.</p>

## Hill start assistance (optional)

The Volvo 9700 US/CAN bus may be equipped with the hill start assistance function. This function helps the driver to pull away on inclines by holding the bus still until the required torque at the wheels is applied.

This function's mode of operation depends on whether the bus is equipped with a manual or automatic transmission.

For more information, see separate operating instructions: “EBS system”.

**Note:** This function not apply in buses equipped with **Allison** transmission.

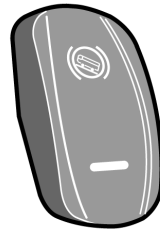

T0012045

## 36 Instruments and controls

### Retarder enabled (if installed)

The Volvo 9700 US/CAN bus may be equipped with a retarder, which (if installed) is an auxiliary brake component and its operation is enabled by a switch located in the dashboard.

This switch enables the retarder control using the brake pedal or by manipulating a lever located at the right side on the steering column.

For more information about retarder, see the following section on this manual: “Retarder (if installed)”, page 120.

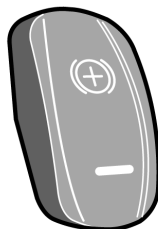

T1008547

### Passenger compartment lighting

This switch turns on the passenger compartment lighting as follows:

- Press button once— after **3 seconds**, all lamps will illuminate at **50%** intensity.
- Press twice— after **3 seconds**, all the passenger compartment lights will illuminate at **100%** intensity.
- Press three or more times — switching between interval of **3 seconds** the light intensity decreases from **100% to 50%** and vice versa.
- Press and hold button for **3 seconds** — to turn off passenger compartment lighting.

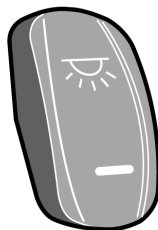

T1008556

### Night lighting (optional)

The Volvo 9700 US/CAN bus may be equipped with a night light for passengers compartment activated by a switch located in the dashboard. This switch has two positions, **ON and OFF**. Activation of the night lighting turns on the lamps illuminating the gangway, which are located under the seats.

When the night lighting is **ON**, the passenger compartment lighting level is dimmed to **30%** regardless of the positions of the other switches.

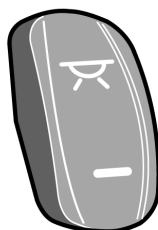

T1008549

## Half-light lighting

This switch turn on the half—light lighting in the passengers compartment and also turn on the blue lights around at the reading lights.

This switch works as follows:

- Press once — to turn **ON** only the blue lights in the passenger compartment.
- Press twice — to turn **ON** the blue lights in the driver's compartment.
- Press three times — to turn **ON** all the blue lights.
- Press and hold for **3 seconds** — to turn **OFF** all the blue lights.

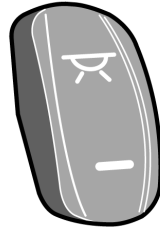

T1008549

## Driver compartment lighting

This switch has three positions as follows:

- Position I — or bottom position, all lighting is **OFF**.
- Position II — or middle position, the lighting is **OFF** if the door is closed, but the lighting is on if the door is open.
- Position III — or top position, the lighting turns on without any restriction.

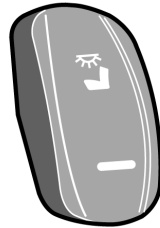

T1008557

## Passenger's individual lighting

Enabling/disabling of the passenger's individual lighting. The lamps are located in the panels above the passenger seats.

See the following section on this manual: "Passengers panel", page 77.

This switch has three positions as follows:

- Position I — or bottom position all lamps are turned **ON**.
- Position II — or middle position all lamps are turned **OFF**.
- Position III — or top position every passenger can individually turn on the lighting with the push-button on the panel.

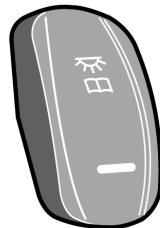

T1008548

## 38 Instruments and controls

---

### Position lights

The position lights switch turn **ON** or **OFF** the bus position lights and operate as follows:

- If the position lights are **OFF**, press and hold the switch to turn on the position lights.
- If the positions lights are **ON**, press and hold the switch to turn **OFF** the position lights.
- Press and depress and so on for position lights blinking.

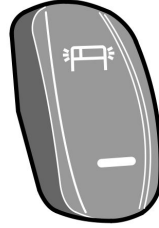

W011159

### Destination sign lighting (optional)

The Volvo 9700 US/CAN bus may be equipped with a destination sign activated by a switch.

This switch has three positions as follows:

- Position I — or bottom position, destination sign lighting is **OFF**.
- Position II — or middle position, destination sign lighting turns **ON** when parking lights are on.
- Position III — or top position, lighting turns **ON** when the ignition switch is in position **II**.

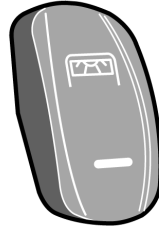

T1008545

For more information for the destination sign, see the following section on this manual: “Destination sign (optional)”, page 71.



## Electrically heated rear view mirrors

The Volvo 9700 US/CAN bus is equipped with a electrically heated rear view mirrors, controlled by a switch located in the side panel.

This switch operates as follows:

- A short press of the button (less than **1 second**) turns heating for **8 minutes**.
- Press for more than one second turns **ON** the permanent heating until the button is pressed again.

Heating can be used to remove water droplets and ice from the mirror glass. **Make sure the mirrors are free of mist or ice when driving.**

**Note:** On some buses this switch, besides heating the rear-view mirrors, also switches on heating of the driver's window and front door window.

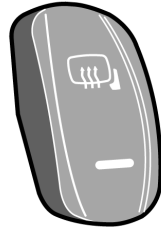

T1008551

## Driver window heating

The Volvo 9700 US/CAN bus is equipped with a driver window heating controlled by a switch located in the dashboard.

This switch operates as follows:

- Pressing the button switches **ON** the heating for **8 minutes**.
- Pressing the button again switches **OFF** the heating.

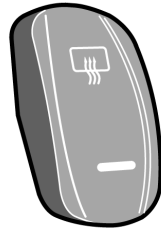

T1008580

## Driver blower

This switch turns **ON** or turn **OFF** two small fans located on the top of the driver and guide seats.

This switch operate as follows:

- Push the switch to turn **ON** both fans.
- Push it again this switch to turn it **OFF** the driver blower.

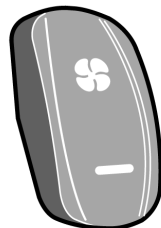

T1008550

## 40 Instruments and controls

### Central locking

This switch locks or unlocks all luggage compartment hatches.

Additionally this switch turns **ON** the luggage compartment lights (*Luggage compartment lighting turns off after 10 minutes of luggage hatches stills opened*).



T1008543

### Sun visor

This switch facilitates lowering and raising the front windscreen sun visor as follows:

- Lowering — Press at the bottom to low the sun visor, depress to stop the movement.
- Raising — Press at the top to raise the sun visor, depress to stop the movement.



T3018180

### Toilet activation

The driver can enabled or disabled the toilet function through by a switch located in the dashboard, which; turn **ON** or turn **OFF** the power supply to the all toilet functions and disengaged the door lock.

For more information see the following section in this manual: “Toilet”, page 75 and the separate operating instructions: “Toilet”.

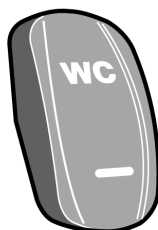

T3018183



#### CAUTION

Check that this switch or switches is always in the turn **OFF** position before shutting down the engine, **Do not turn ON this switch, if the engine is not running.**

## Audio system

In the dashboard is placed a switch to enable or disable the audio system of the bus. This switch has two positions and works as follows:

- Position I — or bottom position, enabled radio, CD or mp3 audio for passengers (microphones disabled).
- Position II — or top position, enabled microphones (for driver or guide).



W0082466

## Opening service door from the outside

This switch placed in the dashboard, allows the opening or not of the service door from the exterior using the external “push-button” located in the service door handle.

The switch count with an indicator lamp to this function is enabled or disabled. The switch works as follows:

- Enabled (indicator lamp **ON**) — Doesn't allow the service door opening from the exterior through by the handle “push-button”.
- Disabled (indicator lamp **OFF**) — Allow the service door opening from the exterior without any restriction.

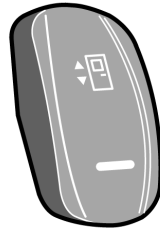

T1008555



### CAUTION

Always press this switch to leave the bus.

## 42 Instruments and controls

---

### Wheel Chair Lift (WCL) system; (optional)

The Volvo 9700 US/CAN bus may be equipped with a Wheel Chair Lift (WCL) system to be operated by its remote pendant. The system can be enable or disable with a switch located in the dashboard. This switch operate as follows:

- Position I — or switch downwards, the Wheel Chair Lift (WCL) system its deactivated.
- Position II — or switch upwards, the Wheel Chair Lift (WCL) system its activated.

**Note:** For more information related to Wheel Chair Lift (WCL) system operation, see separate operating instructions provided by the equipment manufacturer “RICON”.



W3081609

## Emergency window in use indicator lamp

The Volvo 9700 US/CAN bus is equipped with some side windows provided with a opening mechanism used to a emergency exit only.

This lamp lights up to indicate that one or more of the emergency windows has been opened.

For more information about for this type of the emergency windows, see the following section in this manual: “Emergency windows”, page 101.

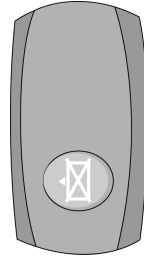

T0015524

## Wheel Chair Lift (WCL) system indicator light

This indicator light provide to the driver the status operation related of the Wheel Chair Lift (WCL) system.

This indicator light works as follows:

- Upper light indicates the Wheel Chair Lift (WCL) system is enabled.
- Bottom light indicates Wheel Chair Lift (WCL) door is ajar.

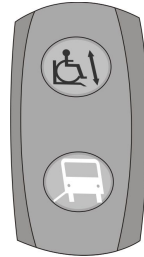

W0110531

**Note:** For more information related to Wheel Chair Lift (WCL) system operation, see separate operating instructions provided by the equipment manufacturer “RICON”.

## 44 Instruments and controls

### Switches into the electrical center

The Volvo 9700 US/CAN bus is equipped with additional “push button type” switches into the electrical center.

This additional switches are:

#### Air conditioning test

Using this switch the driver can check if the air condition is working.

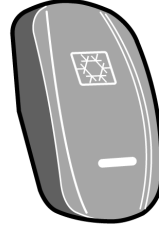

T3018175

#### MCM (Master Control Module) service switch

There is a switch in the electrical center compartment (with a lock symbol) that needs to be activated when the MCM is being programmed. It is only intended to be used when an update on MCM software is needed. This switch was added because during programming, MCM doesn't have control over its output signals. In this case, the body relay (**K400**) keeps opening and closing, not allowing the MCM programming process. If this switch is activated, the start is disable and an indicator is displayed in the cluster (to refer related with this symbol, see separate operating instructions: “Driver information display”).

To refer about **K400** power relay, see the following section in this manual: “I-Start system”, page 131.



T1008543

MCM (Master Control Module) service switch.

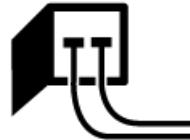

T0014716

MCM (Master Control Module) service switch activated symbol displayed in the driver's information display.

## Door brake switch

A two position “toggle switch” with a protective cover (in red color) is installed into the electrical center to enable or disable the door brake function.

The switch working as follows:

- With the switch in the up position, the door brake is enabled.
- With the switch in the down position, the door brake is disabled.

For more information of the door brake function, see the following section in this manual: “Open door brake”, page 49.

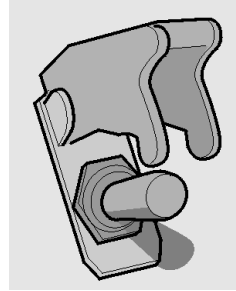

T0009170

### Controls

#### Ignition switch

The ignition switch is located on the right side of the steering column just under the steering wheel.

Standard equipment is a normal ignition switch. A steering wheel lock is available as an option. When the key is removed it actuates a detent pin that prevents the steering shaft from turning.

**Note:** The vehicle is delivered with 2 identical keys. If more keys are needed, order them through your Volvo authorized dealer.

**The keys are laser cut and require a special machine for copying, available through your Volvo dealer. Record the key code and keep in a secure place. A new key can be made, using a key code, if the key are lost.**, for more reference, see the following section on this manual: “Keys”, page 2.



T0014333

Ignition key switch:

- Main switch function replaced by the ignition key in position **I**.
- ARMS (*Automatic Reset Main Switch*) function is working at ignition key position **I** + **a click**.



## Ignition switch (continue)

The ignition switch has four positions:

- 0 **Stop position.** The electric power supply is **OFF**.
- I **Electrical accessories / radio position.** +30 power source, in this position electrical devices can be used (radio and accessories).  
— In position **I** also have a “I + a click” position for ARMS (*Automatic Reset Main Switch*) function, in this position the ARMS is enable for save batteries charge to avoid drained.
- II **Drive position.** +30 power source, +DR power source (instrument cluster turns **ON**).  
Between positions **II** and **III** there is a return spring position for preheating (for more information about pre-heating, see the following section in this manual: “I-Start system”, page 131).  
**Note:** At this position, starter and consumer batteries are put in parallel.
- III **Start position.** Start / cranking and spring-return to position **II**.

The main switch (*located in the dashboard*) was removed and a cover was placed instead, with this switch was enable +30 power source, now +30 power source enabled by the ignition key in position **I** (Accessories/ Radio position), in this position to be able to use the bus accessories while engine is **OFF**, the ignition key shall be kept on this position.

**Note:** +30 power source (*for body loads*) can be disconnected by the MCM (*Master Control Module*) that opens K400 power relay when a low voltage is detected, for starter batteries it is done by ARMS relay. To refer this function see the following section in this manual: “I-Start system”, page 131.

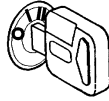

W3001302

Ignition key positions.



### DANGER

The ignition switch has a restart inhibitor locking out the start position after one try, which means that the key must be turned back to **0** before a new attempt at starting can be made.

Removing the key from the starting switch activates the steering lock.

The key can only be removed from the starting switch when it is in the stop position (**0** or **OFF** position).

Do not remove the key from the starting switch when the bus is being towed!

Always remove the key from the starting switch when leaving the bus.

### Adjusting external rear view mirrors

Both rear view mirrors are adjusted using the same switch. The switch can be turned to one of the two positions (adjustment of the right or left mirror). The arrow shows which of the mirrors has been selected. The selected mirror is adjusted by moving the switch in the appropriate direction.

**Note:** Rear view mirrors should be adjusted before starting to drive.

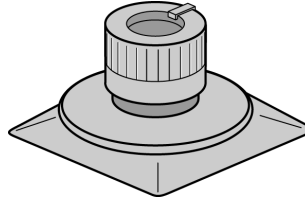

T0014718

## Open door brake

The Volvo 9700 US/CAN is equipped with the open door brake function.

This function works as follow:

- If the bus is stopped and the service door are open. The bus will not be able to move (because the throttle signal will be deactivated and also the gear selector in the transmission will locked, this previously only applies for buses that are equipped with **I-Shift** transmission, or any transmission multiplexed to the bus electrical system). Also too, the parking brakes will remain applied. So that should be close to the service door to be able move the bus.
- If the bus is in motion, the service doors may not be open until the bus is totally stopped.

The open door brake function goes active only when it has the following conditions:

- Must be activated the open door brake general activation button which located within to the bus electric central (see the following section in this manual: “Door brake switch”, page 45).

- The bus must be go at speeds below to **3 mph (5 km/h)**, even though the open door brake general activation button is activated and the bus speed greater than that indicated speed, the indicator light on the dashboard will not lit, indicating that the open door brake function is not active.
- The bus must be go at maximum speed of **3 mph (5 km/h)**, for the open door brake function may enter in active and ready to enter in a function once the bus is totally stopped (this is indicated when the indicator light lit in the dashboard).

**Note:** The open door brake does **not** engage at speeds over **3 mph (5 km/h)**.



### CAUTION

The open door brake does **not** engage if the brake system registers poor traction when the bus is stopping on a slippery surface. This prevents the bus skidding when stopping on a slippery surface.

## 50 Instruments and controls

---

### Open door brake deactivation

For open door brake deactivation do the following:

- 1 The accelerator must not be active (fully release the accelerator).
- 2 The specified door(s) must be completely closed.
- 3 The accelerator must be activated again (depress the accelerator again).

In the event that, due to the bus stopping on a slippery surface, the brake system has not activated the door brake, you must brake again (in a place where no slippery surface is detected) to enable this brake to be reactivated.

### Door brake general deactivation

The electrical center is equipped also with a *toggle switch* used to general disengage the door brake function (“By-pass switch”). This switch only disabled the door brake function, independently of the other functions of the bus (see also the following section in this manual: “Door brake switch”, page 45).

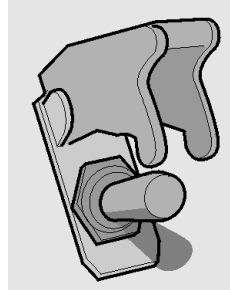

T0009170



#### WARNING

The switch for disengaging the door brake function must only be used in emergency, if the bus cannot be moved in the usual way. The door brake function normally must be **always** turn **ON**. The bus can not be able to move until the service door be closed.

## Steering wheel adjustment

Both the steering wheel height and its tilt allow of continuous adjustment.

Adjust the steering wheel as follows:

- Depress the pedal to which the arrow points.
- Setting the steering wheel.
- After releasing the pedal the steering wheel is locked in its new position.



### **DANGER**

Steering wheel adjustments should only be performed while the bus is stationary. Adjustments with the vehicle is moving may lead to an accident, resulting in serious personal injury or death.

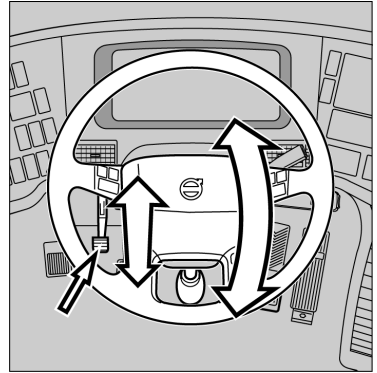

T6010216

## 52 Instruments and controls

### Directional indicator, dipped/full beam changer

#### 1 Location of point of resistance.

When making maneuvers requiring only slight movements of the steering wheel (changing lanes, overtaking), move the stalk up or down and hold it there. After releasing the stalk, it will immediately return to its neutral position.

#### 2 Move the stalk beyond the resistance point. .

The directional indicators will continue to flash until the stalk is manually moved back to the neutral position, or the steering wheel is returned to the straight ahead position after the turn.

#### 3 Main beam “flash”.

Pull the stalk towards the steering wheel (until you feel slight resistance).

The main beam will stay lit until the stalk is released.

**Main/dipped beam switching (lights on).**

Pull the stalk towards the steering wheel beyond the “flashing point” and release it.

Each time you do this, the headlamps will toggle between main and dipped beam.

In addition, engine idling speed can be controlled with this stalk. See: “Idle speed adjustment”, page 116.

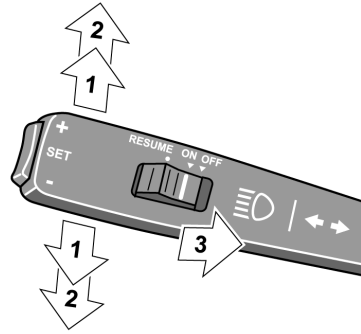

T0012077

Control lever for beam lights change and directional lights.

## Windscreen wipers, windscreen headlight washer

**Note:** This stalk also provides control of the display, for additional information about display control, see separate operating instructions: “Display”.

### 1 Interval wiping

Used when driving in mist or drizzle conditions.

The wipers make one sweep every **10 seconds**. To reduce the time between sweeps, move the stalk to the normal position, and then, after the desired time interval, back to the interval wiping position. This permits the wiping interval to be set to any value between **1 and 10 seconds**.

### 2 Flick wipe position.

If you want the wiper to make only one or two strokes (e.g. drizzle), move the lever to the flick wipe position and keep it there with your finger. The wipers will stop in parking position after releasing the lever.

### 3 Windscreen wipers, normal speed.

### 4 Windscreen wipers, high speed.

### 5 Windscreen washers + headlight washers.

Moving the stalk to this position will also activate the windscreen wipers, which will make an additional **2-3 sweeps** after the stalk has been released.

The headlight washers and windscreen washers have a common fluid reservoir.

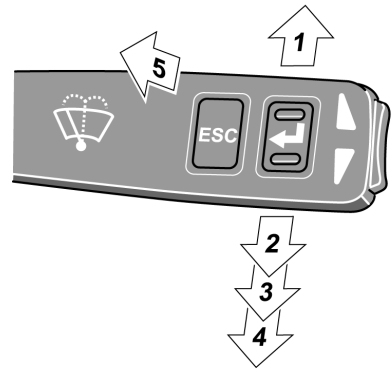

T0012079

### Transmission

#### I-Shift transmission lever selector (optional)

The Volvo 9700 US/CAN bus may be fitted with an **I-Shift** transmission lever selector for gear shifts management in this automatized transmission, generally located at the right bottom side from the driver seat.

In this transmission, both clutch operation and gear shifts are performed fully automatized.

If necessary, the gears can be changed manually by placing the lever in the **M** position and pressing the “+” and “-” buttons located at the side in the lever selector.

The level selector has at its grip upper the “FOLD” button. When pressing and hold this button you can tilting the lever downwards to the position where the lever is on a level with the seat, this is; for provide more space in the driving position.

For more information, see separate operating instructions: “I-Shift”.

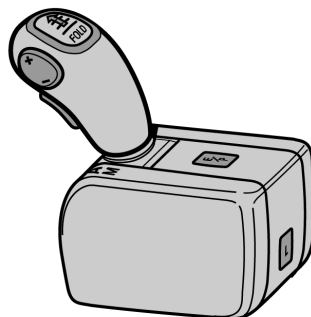

T4021276



## I-Shift transmission pad selector

The Volvo 9700 US/CAN bus is fitted with an **I-Shift** transmission pad selector located in the side panel for gear shifts management in this automatized transmission.

In this transmission, both clutch operation and gear shifts are performed fully automatized.

If necessary, the gears can be changed manually through by the “+” and “-” buttons. The push-button shift selector has six buttons: R, N, D, M and “+” and “-”. Described below:

- R — Reverse: Vehicle must be stopped when selecting this gear.
- N — Neutral: No gear engaged.
- D — Drive: Automatic drive mode. The transmission will select most suitable gear for running conditions such as load, speed, accelerator pedal position, hill climbing, etc.
- M — Manual mode: The driver can be changing up and down gears totally manual, according of his driving style through by use the “+” and “-” buttons, on the pad selector.

For more information, see separate operating instructions: “I-Shift pad gear selector”.

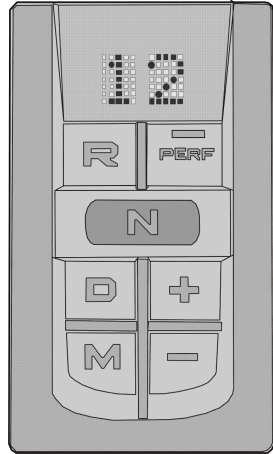

W0089562

### Allison automatic transmission (optional)

The Volvo 9700 US/CAN bus can optionally be equipped with an automatic transmission: *Allison 4000 Series model 6B500*, which is an automatic transmission with 6 forward speeds and reverse.

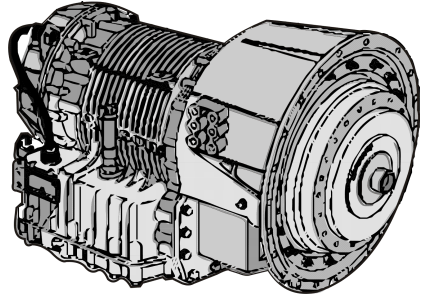

W0095730

## Allison transmission shifter

The Volvo 9700 US/CAN bus may be fitted with an Allison transmission shifter, if the Allison automatic transmission is installed in the bus.

The Allison transmission shifter has a six “push-buttons” as: R, N, D, Mode and “+” and “-”. Which described below:

- R — Reverse: Vehicle must be stationary when selecting **R**.
- N — Neutral: No speed coupled.
- D — Drive: Press this button to select Drive function, the highest forward range available will appear in the digital display window under **SELECT**. The transmission will start out in the lowest available forward range, displayed under **MONITOR**, and advance automatically to the highest range.
- Mode — The **MODE** button can allow the driver to enable a secondary shift mode that has been programmed into the **TCM** (Transmission Control Module) unit. Pressing the **MODE** button activates the **PERFORMANCE** shift schedule and illuminates the mode indicator (*LED*).
- + or — buttons: Press respectively the (“Upshift”) or (“Downshift”) arrow button when in **DRIVE** to request the next higher or lower range. One press changes speeds by one range. If the button is held down, the selection will scroll up or down until the button is released or until the highest or lowest possible range is selected. Protection mechanisms inhibit selecting ranges that are not appropriate for the current speed or which may damage driveline components.



W0095731

### Allison transmission, mode function

The **MODE** button have the following function. Both **ECONOMY** (default mode at starting of the engine) and **PERFORMANCE** (secondary shift mode) modes are equivalent from the first to the fourth gear as the transmission upshifts at around **2000 rpm**.

The **ECONOMY** mode allows for upshifts in fifth and sixth gear at around **1700 rpm**. This is a more efficient operation of the transmission and thereby helps improve fuel economy.

The **PERFORMANCE** mode keeps upshifts at **2000 rpm** in fifth and sixth gears. This makes for better performance than the economy mode but with higher fuel consumption. It is recommended this mode be selected while driving up or down grades. The mode indicator (*LED*) is illuminating when **PERFORMANCE** mode is selected. When a button is depressed on the transmission control pad, the corresponding letter or number is displayed indicating the transmission is ready to operate in the selected range. If the transmission control module (**TCM**) detects a serious problem in the transmission, the “CHECK” telltale light will illuminate on the dashboard. For more information see separate operating instructions: “Allison Bus Series Operator’s Manual ” provide by the transmission manufacturer.

## Transmission overheating

If the transmission overheats, the “CHECK” lamp will light and the display will show a red symbol.

If the temperature rises further, the red “STOP” lamp will light. Slow down and stop the bus as soon as it is safe to do so.

Contact an Volvo authorized service center to request the assistance road rescue service (see the following section on this manual “Assistance and rescue on highway”, page 143.



T3014365

CHECK icon lit in the dashboard.



T3014364

STOP icon lit in the dashboard.



T0008817

Symbol shown in the driver display.

## Retarder (if installed)

The Volvo 9700 US/CAN gearbox may be equipped with a “compact hydraulic” retarder type. If equipped, the retarder helps to decrease the bus speed and the load on the service brakes. Its automatically engaged by the initial movement of the brake pedal (even before that the wheel brakes are applied) or by a control lever at the right side of the steering column.

The retarder operation can be general enable or disable, through by a switch placed in the dashboard (see the following section in this manual: “Retarder enabled (if installed)”, page 36).

This switch has two positions as follows:

- Position I — Switch downwards, the retarder is disabled.
- Position II — Switch upwards, the retarder is enabled.

When the retarder its active, a symbol is shown in the display.

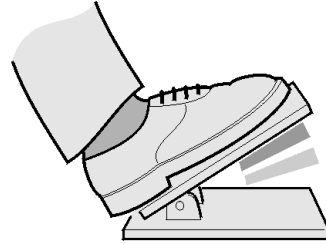

T0009004

Retarder activation area in the brake pedal (optional).



T3018117

Symbol shown in the driver display.

 **DANGER**

Avoid using the retarder on slippery roads because of the risk of locking the wheels and skidding (the retarder brakes only the driving wheels). Failure to do so may lead to an accident, resulting in serious personal injury or death.

**Note:** The retarder brake the main shaft to connecting the drive axle with the transmission and in this way, obtain a delay effect on the drive wheels. If the bus is; equipped with anti-lock brake system (ABS), the retarder is automatically disengaged on any signs of the wheels locking.

**Note:** Under normal driving conditions, the retarder should not be disabled.

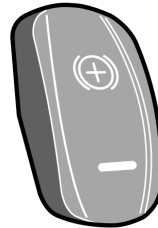

T1008547

Retarder enabled or disabled switch located in the dashboard.

## Retarder overheating

**Note:** Only apply, if the coach equipped with the hydraulic retarder.

If the retarder remains engaged for a long time (e.g. during a long downhill stretch) it may be overheat, causing an increase in retarder oil temperature.

The first indication of retarder overheating is the “CHECK” lamp lighting and the temperature symbol showing up on the display. If this happens, select a lower gear and make greater use of the main brakes.

If the temperature continues to rise, the red “STOP” lamp will light and there will be an increase in the temperature accompanying the symbol on the display. Stop the bus as soon as possible and select neutral, i.e. N. To increase the circulation of the coolant run the engine at higher idle until the temperature returns to the normal level.

 <b>CAUTION</b>
<p>Do not switch off the engine before the temperature is back to normal. Failure to do so may be result in component damage.</p>



T3014365

CHECK icon lit in the dashboard.



T3008844

Symbol shown in the driver display.



T3014364

STOP icon lit in the dashboard.

### Brakes

#### Parking brake

The parking brake acts on the drive wheels. When the hand control is in the forward position with the compressed air system charged and the blocking valve depressed, the parking brake is released.

When the parking brake hand control is moved backwards, the parking brake is gradually applied. It is fully applied when the hand control is in its backmost, locked position.

To release the parking brake hand control from the locked position, lift the ring upwards and move the lever forwards.

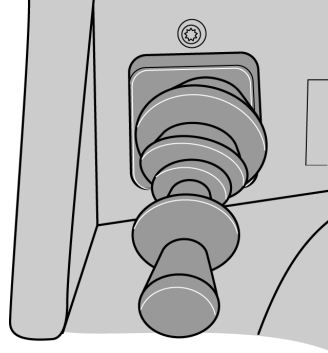

T5014881

#### DANGER

Pay attention to the following advises:

- Never leave the bus without engaging the parking brake.
- Never start driving while the brake system warning lamp is still lit.
- If the warning lamp lights while driving, stop the bus immediately.

Failure to do so may result in serious personal injury or death.



## Emergency brake

To use the parking brake as an emergency brake, move the lever gradually backwards to the parking position. Keep the catch pulled in all the time, or the control will fasten in the locked position.



### DANGER

The parking brake is only to be used for parking or as an emergency brake in case of malfunction of the service brake system. Due to the parking brake only brakes the drive wheels, there is a high risk of bus skidding, resulting in a more braking distance than to avoid wheels locking by using the service brakes. Did not take care in the proper use of emergency brake, may be induce to an accident resulting in serious injury or death.

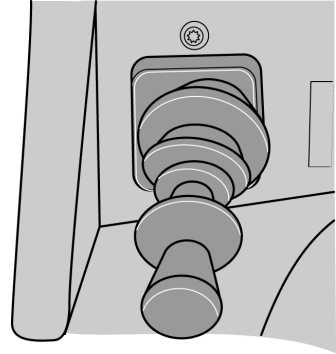

T5014881

### Blocking valve

The function of this valve is activate the parking brake blocking by the pneumatic control valve supply blocking, inhibiting the parking brake valve function. Its happened, if the pneumatic circuit pressures to low in the bus, causing; that the blocking valve is automatically activated (the valve is thrown). To release the parking brake do the following:

- 1 Start the engine and charge the pneumatic system of the bus (until the air brake system warning lamp in the instrument panel is turn **OFF**).
- 2 Press the blocking valve.
- 3 Put the parking brake control lever in the brake release position (see the following section on this manual: “Parking brake”, page 62).

**Note:** Once the blocking valve activated, the parking brake can not release although the parking brake control lever is in its forward position (brake released). To release the parking brake, it should restore the pneumatic circuits pressure of the bus and press the blocking valve.

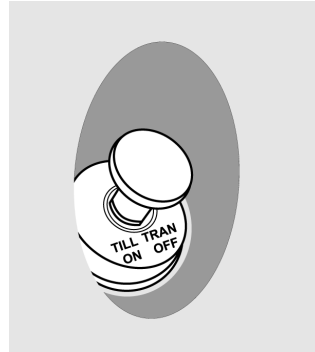

T0015484

## Service brakes

The Volvo 9700 US/CAN bus is equipped with an EBS brake system (Electronically-controlled Braking System). This system monitors and controls the brake operation (also, refer to this section on this manual: “EBS (Electronically-controlled Braking System)”, page 67).

If the service brakes are used without care when driving down steep and long inclines, they will heat up very quickly to extreme temperatures. The low speed that is generally the rule in such cases means that the brakes are not cooled as efficiently as when driving on level roads. When driving downhill, in the first instance use the retarder brake, and only supplement this with the main brakes as necessary.

For additional information about the retarder, see the following section on this manual: “Retarder (if installed)”, page 120.

If you have to use the service brakes while driving downhill, **DO NOT** pump the service brake, as this will only use up compressed air, what cause trigger the blocking valve activating the parking brake unexpectedly, raising the risk of a rollover (for information about the valve block, see the next section in this manual: “Blocking valve”, page 64).

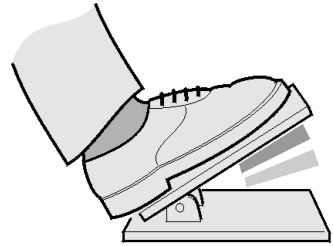

T0009004

Dark zone — only retarder.  
Light zone — retarder and foot brake.



T0009682

Symbol shown in the driver display.



T3008834

Icon lit in the dashboard.

## 66 Instruments and controls

---

### Service brakes use

When driving downhill, brake sufficiently hard and then release the brake pedal completely, or just to the pedal position where only the retarder is engaged. Heat builds up very quickly in the brakes, causing increased wear of the brake linings and reduced brake efficiency.



### **DANGER**

Do not start driving if the pneumatic low pressure lamp is turn on in the dashboard. Fully charge the pneumatic system and wait the warning lamp turn off in the dashboard before starting the trip.

If the pneumatic low pressure lamp comes on while driving. Stop the bus immediately and parking in a safe place because the risk that the parking or emergency brake applies unexpectedly raising the risk of a rollover.

## EBS (Electronically-controlled Braking System)

The main purpose of the Electronically Braking System (EBS) is to increase the effectiveness and efficiency of the service brake (by shortening braking distances) and so increase the safety while driving. The Electronically Braking System (EBS) controlled the Antilock Brake System (ABS) and Antislip System Reduction (ASR). The Electronically Braking System (EBS) its fitted on buses equipped with disc brakes, being the Antilock Brake System (ABS) a part of the Electronically Braking System (EBS) control and works completely automatically. The Antilock Brake System (ABS) prevents the wheels from locking up during braking. In case of Antilock Brake System (ABS) failure, the appropriate symbol appears on display in the dashboard.

**Note:** Antilock Brake System (ABS) efficiency is limited. Remember, that on slippery surfaces Antilock Brake System (ABS) will not shorten the braking distance significantly. It can nevertheless help in avoiding obstacles during braking.

For more information of the Electronically Braking System (EBS), see separate operating instructions: “EBS”.



T0009682

Symbol shown in the driver display.



T3008834

Icon lit in the dashboard.

### Compensating for differences in the wear of the brake pads

If the brake pads on one of the axles wear down faster than those on the other, braking force is redistributed so that a greater portion of the braking force is applied to the wheels on the axle with less wear.

When the thickness of the brake pads is reduced to **20%** of the thickness of new pads, a warning symbol is shown on the display.

**Note:** This function activates when braking lightly. During in a hard braking the braking force is distributed so as to achieve the most efficient braking.



T5013668

#### **DANGER**

When brake pad warning symbol is displayed, immediately proceed to the nearest service station to replace the brake pads with new ones. Driving any further with worn out brake pads may be lead to losing control of the vehicle and cause an accident resulting in serious personal injury or death.

## High brake temperature warning

If the temperature of the brakes increases too much, the lamp on the dashboard “CHECK” turn on and the same time the relevant symbol is shown on the display.

**Note:** If the temperature is allowed to rise further, maintaining the same braking force will require increased pressure on the brake pedal.



T5013670

Symbol shown in the driver display.



T3014365

Icon lit in the dashboard.

## 70 Instruments and controls

### A/C Controller (multiplexing system)

The Volvo 9700 US/CAN bus is equipped with an A/C controller “AQuattro” for controlled the multiplexed A/C system. With this control the driver maintains a constant temperature inside the bus.

For more information of the “AQuattro” A/C multiplexing system control, see separate operating instructions: “AQuattro, A/C controller”.

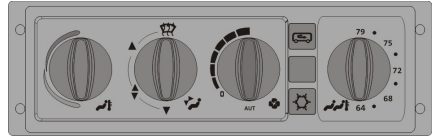

T8061140



## **Destination sign (optional)**

The Volvo 9700 US/CAN bus may be fitted with a two optional high definition destination signs, “Mobitec” or “Innova” brands.

For use, follow then instructions in the next pages:

## 72 Instruments and controls

### Destination sign Innova

“Innova” destination sign control pad has the following buttons, its function is described for each one:

- **Destination text:** Press the (1) button and then use the buttons (2) or (3) until the route message adjust function appears in the display with the following name “RUTA”; Then press the (4) button to enter this function. In this function, use the buttons (2) or (3) to select the wanted destination text and press the (4) button for insert your selection. Press the (1) button to return the main menu.
- **Extra text:** Press the (1) button and use the buttons (2) or (3) until the extra text function appears in the display with the following name “EXTRA”. Then press (4) button to enter the function. The "P-01" message in the display will appear, press (4) button to confirm the selection then "P-ON" message will appear in the display, use the buttons (5) and (6) to insert the wanted extra text that you want. Press (4) button and the message “01:ON” will appear. Use the buttons (5) and (6) to adjust the exposure time for the extra text. Press button (4) for apply the adjustments and return to the main menu.
- **Departure time:** Press the (1) button and use the buttons (2) or (3) until the departure hour function appears in the display by the following name “HrSd”. Then press the (4) button to select the function and use (2) and (3) buttons to adjust the time hour, press (4) button to entered the time hour, now again use the (2) and (3) buttons to adjust the time minutes, press (4) button to entered the time minutes and return to the main menu.

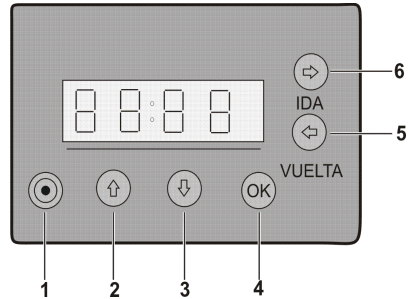

“Innova” destination sign digital control.

For more information see the separate user manual provided by “**Innova**”.

## Destination sign Mobitec

“Mobitec” destination sign control pad has the following buttons; its function is described for each one:

- Destination text selection: Press the “check mark” button, the digit value to be changed will flash. Use the “up” and “down” buttons for increase or decrease the digit value to be changed. Use the “left” and “right” buttons in order to change the button to be modified.
- Extra text selection: Press the “check mark” button for enter to the destination text selector mode. Press the “right” button for change the extra text. Use the “up” and “down” buttons to increase or decrease the value of the digit to be changed. Use the “right” or “left” buttons to change the digit to be modified.
- Departure time selection: Press the “check mark” button for enter to the destination text selector mode. Press the “right” button for change the departure time text. Use the “up” and “down” buttons to increase or decrease the value of the digit to be changed. Use the “right” or “left” buttons to change the digit to be modified.

After each configuration (departure time, destination and extra text informations), press the “check mark” button to confirm or the “cross” button to cancel.

For more information see the separate user manual provided by “**Mobitec**”.

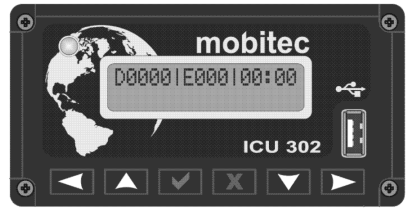

W0097186

“Mobitec” destination sign digital control.

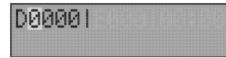

W0097187

Destination display selector.

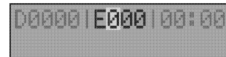

W0097188

Extra text display selector.



W0097189

Departure time display selector.

## 74 Interior equipment

### Interior equipment

To enhance travel comfort, the Volvo 9700 US/CAN bus is fitted with additional interior equipment such as:

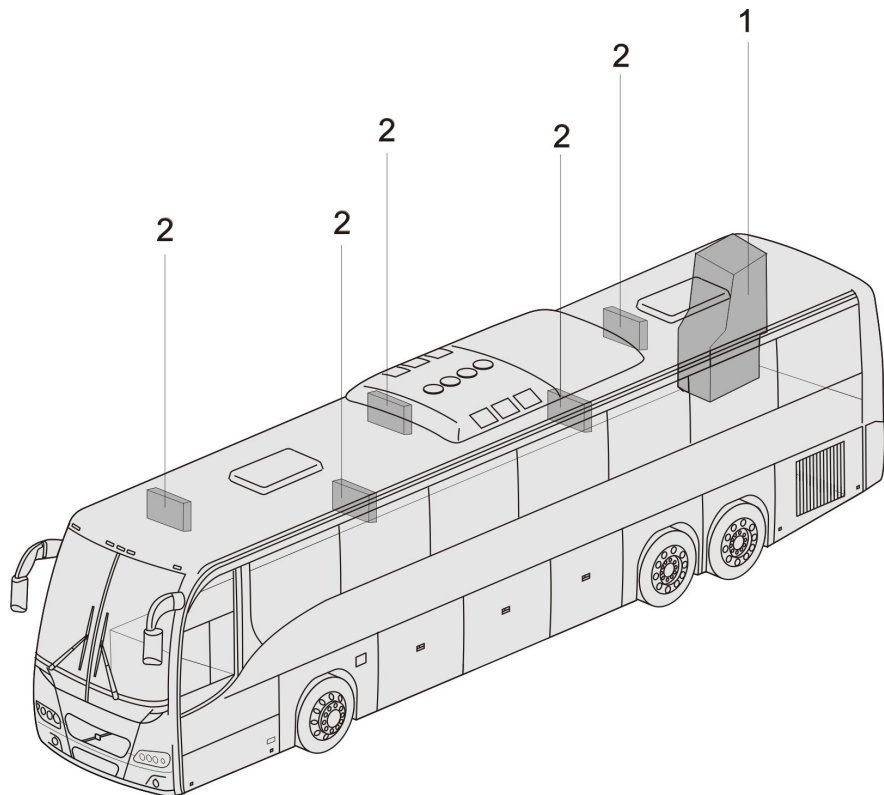

W0089616

- 1 Toilet.
- 2 Monitors.

## Toilet

The Volvo 9700 US/CAN bus is equipped with a toilet, located on the right-hand side at the rear of the vehicle. Pressing a switch on the dashboard enables the toilet to be used, by releasing its central lock and switching on the toilet power supply.

While the toilet is occupied (after locking the door) a sign lights up in the passenger compartment.

In the toilet compartment there is an emergency push-button with backlight. After it has been pressed, the toilet indicator lamp flashes on the dashboard.

For additional information and instructions regarding the servicing and maintenance of the toilet, see separate operating instructions: "Toilet".

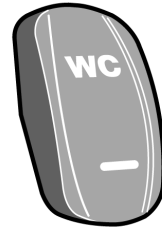

T3018183

Enabled switch located in the dashboard.

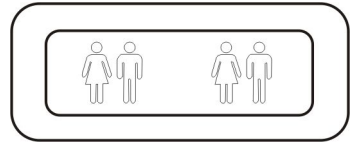

T0015272

Indicator lamp in the toilet cabinet.

## Rear trash bin

The Volvo 9700 US/CAN bus is equipped with a trash bin integrated to the interior rear panel, located at the bottom of passengers compartment, beside the toilet.

For more information regarding access and maintenance of the rear trash bin, see separate operating instructions: "Toilet".



W0095904

## 76 Interior equipment

---

### Passengers thermometer and clock display

The Volvo 9700 US/CAN bus is equipped with a thermometer and clock display located on the front of the passengers compartment (at the cabin roof).

The display shown the following information:

- Time.
- Date.
- Toilet occupied.
- Toilet unoccupied.

For more information, see separate operating instructions: “Passenger compartment clock display”.

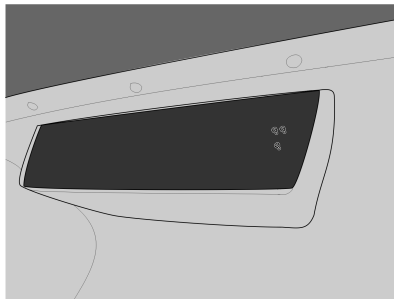

W3081817

## Passengers panel

The Volvo 9700 US/CAN bus is feature with a passenger panels above in each pair of passenger seats.

On each panel there are the following elements:

- 1 Left seat reading light **ON/ OFF** switch.
- 2 Right seat reading light **ON/ OFF** switch.
- 3 Loudspeaker **ON/OFF** switch.
- 4 Not in use.
- 5 Reading lights (one for each passenger seat).
- 6 Ventilation and A/C outlet grills (one for each passenger seat).

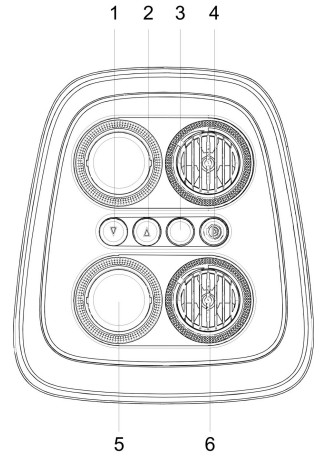

W3081339

## LED lighting stripe

The Volvo 9700 US/CAN bus is equipped with a LED lighting stripe (1) mounted on each passengers panel. The lighting stripe illuminate at **100%** when the ignition key is turned **ON** in its position **I** and when the parking brake is released and start the driving, the lighting stripes dim automatically at **50%**.

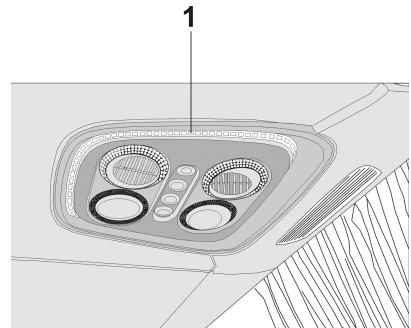

W0089617

## 78 Interior equipment

### Passengers AC (alternate current) 110 V power outlets

The Volvo 9700 US/CAN bus is equipped with passengers AC (alternate current) **110 V** power outlets. For each pair of passengers there is a electrical contact located at the center of the front lower frame from each pair of passenger seats to connect electrical devices as:

- Cell phone charger.
- Lap Tops.
- mp3 players.

For more information about use and care of the bus power outlets, see separate operating instructions: “110 V CA passengers power outlets”.

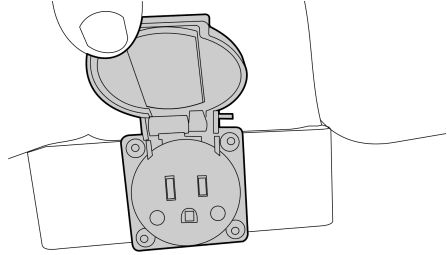

W0096345

Power outlet in the bottom of each pair of passenger seats.



#### **WARNING**

Under no circumstances should introduce any objects into the electrical outlets slots. Failure to following this warning result in to a high risk of serious personal injury and possible irreversible damage of the bus electrical system.



## Passenger AC 110 V power outlets circuit breaker

In case of an electrical overload, the power outlets circuit is equipped with a thermally protected circuit breaker, which disables the electrical power outlet system. The driver can reset the system by pressing the blue button (1) integrated into the protection device located in the lower center console of the dashboard.

For more information about use of the thermal circuit breaker to the bus power outlets circuit, see separate operating instructions: “110 V AC passengers power outlets”.

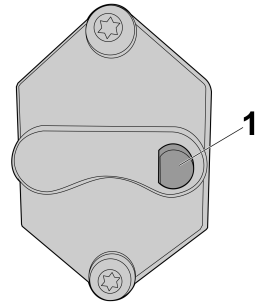

W3081815

Circuit breaker button on thermal protector device.



### CAUTION

Should not be allowed to the passengers connect high power consumption electrical devices such as: Hair dryers, curling iron or similar electrical devices, if this equipment is connected to the power outlets, cause a irreversible damage to the bus electrical system.

## 80 Interior equipment

---

### TGW (Telematics Gate Way) system and Liaison communication system

The Volvo 9700 US/CAN bus is equipped with a TGW system using the new 3G protocol communication.

For USA and Canada markets the coach using the Liaison communication software, which use the TGW-3G system architecture components.

The TGW-3G is an electronic control module used for data logging and communication between the vehicle and fleet manager computer.

The main functions for TGW are as follows:

- Functions as a gateway for remote services. GSM (Global System for Mobile Communications) / GPRS (General Packet Radio Services) / 3G and WLAN.
- Gather and transmit vehicle and driver data that has been logged in other vehicle units.
- Geographic positioning of the vehicle (GPS).
- Functions as a computer interface for third party file transfers.
- Functions as a gateway for AIC to the vehicle network.

TGW also has a SIM (Subscriber Identity Module) reader and a USB interface. TGW is connected to:

- The vehicle's electrical and electronic systems.
- AIC

**Note:** For more information to the Liaison communication system, see separate operating instructions: "Liaison 2.0 Communication system".

## Passengers sliding seats

**Note:** Apply only for a Wheel Chair Lift (WCL) 9700 US/CAN bus version.



### CAUTION

The edges of the pedestal need to be aligned with the arrows on the lateral plate, to properly secure the seat retainers pressing pedestal pedals. Do not try to press down the pedestal pedals if the pedestal is not aligned with the arrows, because the seat retainers does not applies properly.

Only 9700 US/CAN buses equipped with WCL (Wheel Chair Lift) have four pairs of folding and sliding passenger's seats and two pairs of folding passenger's seats, which use when required accommodate a person in a wheelchair.

For more information to operate the folding and sliding passenger's seats, see separate operating instructions: "Wheel Chair Lift equipment".



W0089974

## 82 Interior equipment

### Control pendant (for Wheel Chair Lift equipment)

The wheel chair lift is operated with a hand-held, hard-wired remote-control pendant. This control pendant is located on the left side from the Wheel Chair Lift (WCL) compartment.

The control pendant for Wheel Chair Lift (WCL) have the following control buttons:

- Power switch — Turn ON the Wheel Chair Lift equipment.
- Deploy — Extends the platform from the storage compartment.
- Stow — Retracts the platform back into the storage compartment.
- Down — Lowers the platform towards the ground.
- Up — Raises the platform towards the vehicle floor.

For more information about the Wheel Chair Lift (WCL) equipment operation, see separate operating instructions: “Wheel Chair Lift equipment”.

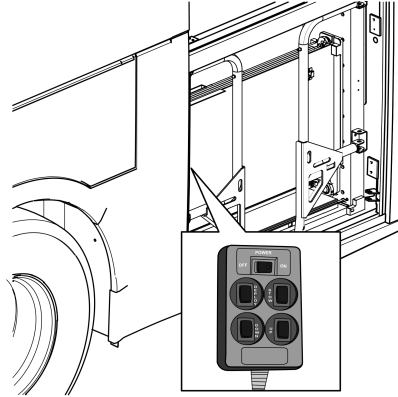

W9089525

Locate of control pendant into the Wheel Chair Lift (WCL) bus compartment.



W0095900

Control pendant.

## Audiovisual system

To enhance the comfort of the passengers during journeys, the Volvo 9700 US/CAN bus is equipped with an audiovisual system, whose main components are:

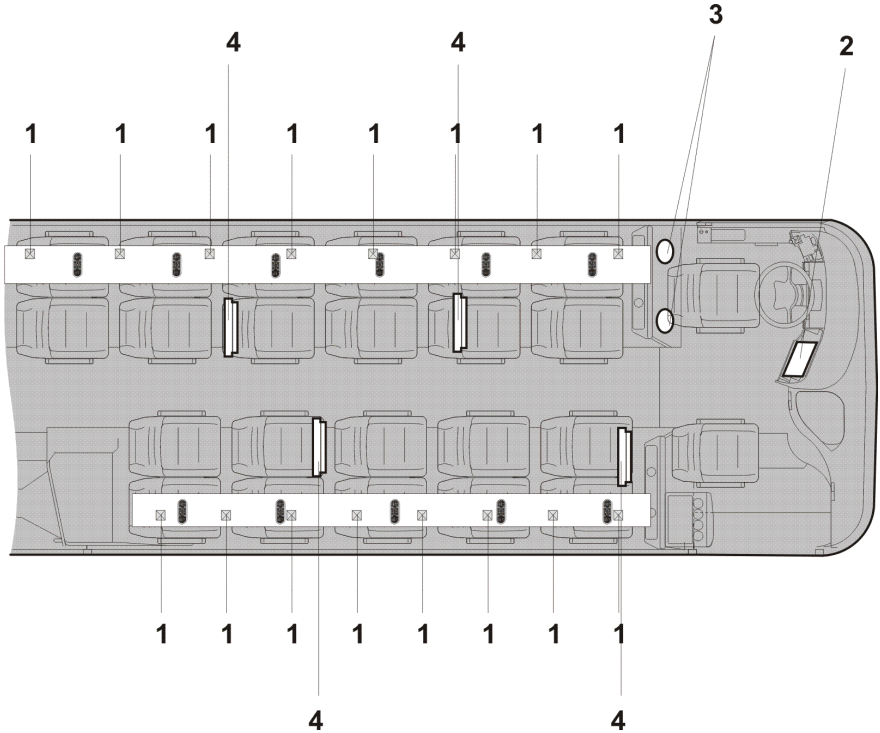

W0089970

- 1 Loudspeakers in the luggage racks.
- 2 CD, DVD player.
- 3 Drivers loudspeakers.
- 4 LCD monitors (mounted in the luggage rack, up to 5 maximum).

## Audiovisual control panel

The Volvo 9700 US/CAN bus could be equipped with main unit, giving the driver complete control of the system.

For more information, see separate operating instructions provided by the manufacturer depends which audiovisual system is installed in the bus: “Bosch” or “Blaupunkt”.

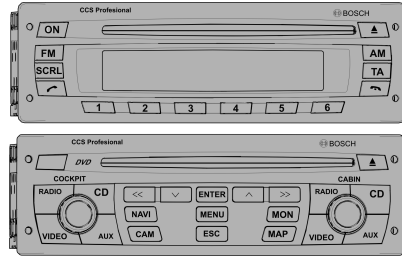

W8081374

“Bosch” control panel.



T8057538

“Blaupunkt” control panel.

## Video system

The Volvo 9700 US/CAN is equipped as standard with a video system for the passengers either four or five LCD monitors in the bus. this LCD video monitors are installed in the luggage rack.

The video system monitors are activated by selecting the **VIDEO** signal source on the audiovisual controller.

For more information, see separate operating instructions provided by the manufacturer depends which audiovisual system is installed in the bus: “Bosch” or “Blaupunkt”.

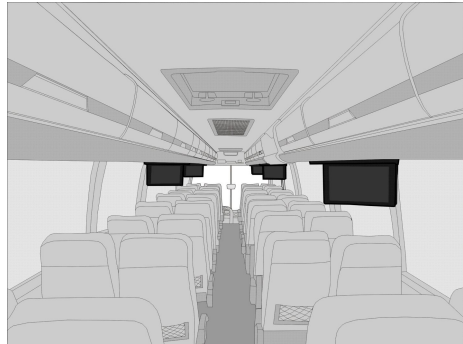

W0089755

LCD video monitors mounted in the luggage rack (up to 5 maximum).

## Audio system

The Volvo 9700 US/CAN bus is equipped as standard with an audio system for the passengers.

The main elements of the audio system are:

- Radio.
- CD player.
- USB port for mp3 player input.
- Loudspeakers.
- Gadgets cable connection.

**Note:** The USB port and the gadgets cable connection are located into the glove compartment in the middle of the dashboard, as shown on the images (A) and (B).

The audio system its activated by a switch located in the dashboard (see the following section in this manual: “Audio system”, page 41) and controlled by selecting the “AUDIO” signal source on the own audio system control panel installed on the bus.

For more information, see separate operating instructions provided by the manufacturer depends which audio system is installed in the bus: “Bosch” or “Blaukpunkt”.

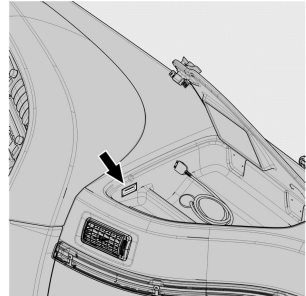

W0101223

(A) USB port to connect a pendrive with mp3 or a plug to charging other electronic devices.

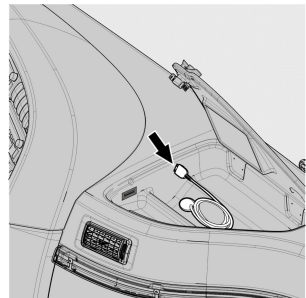

W0101195

(B) Cable connection for gadgets devices.

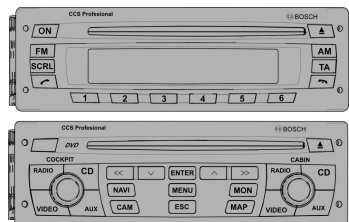

W8081374

“Bosch” control panel.

### Guide or driver microphone (optional)

The Volvo 9700 US/CAN bus may be equipped with one or two microphones (for the driver or guide or both) and so give information messages to the passengers along the trip.

For enabled the microphone(s) selecting the “MICROPHONE” signal source on the own audio system control panel installed on the bus.

By doing this, other signal sources in the passenger loudspeakers are silenced and only the microphone(s) signal is heard.

For more information, see separate operating instructions provided by the manufacturer depends which audio system is installed in the bus: “Bosch” or “Blaukpunkt”.

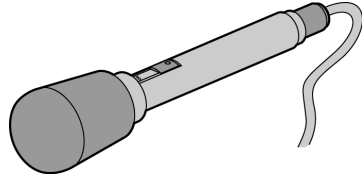

T3019220

Microphone device located in the lower center console of the dashboard.



W0089527

Microphone device placed in the driver seat head rest.



## Overview

As the driver you must always be familiar with the location of the emergency equipment in the bus, and how to use it.

It is essential that all emergency equipment is checked on a regular basis to make sure that it is in working condition and in place. The location of the safety equipment and its scope can vary, depending on the regulations in the country in question. Therefore make sure that you know where the equipment is and check that nothing is missing.

## 88 Emergency and safety equipment

### Fire extinguisher

The fire extinguisher is located in the front of the bus (most often mounted under dashboard on the right-hand side).

The fire extinguisher can be used to put out fires in volatile fluids, wood, fabric, paper and electrical equipment. Check regularly that the pressure gauge indicator is in the green zone.

How to use the fire extinguisher:

- 1 Remove the fire extinguisher from its holder.
- 2 Hold the extinguisher by its handle with one hand, and pull the safety pin with the other.
- 3 Point the rubber hose at the heart of the fire and press the trigger.

To refer a first aid kit, see the following section in this manual: “First aid kit”, page 94.

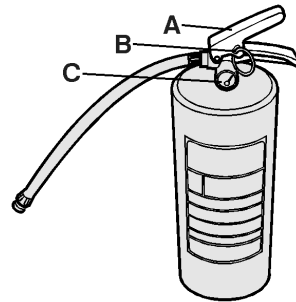

T0008196

- A Trigger.
- B Safety pin.
- C Pressure gauge.

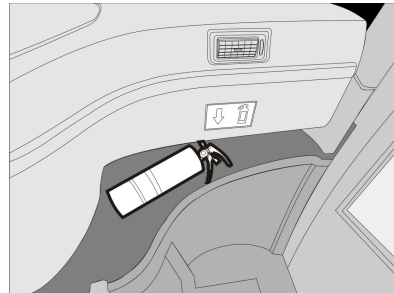

W011065

Fire extinguisher location in the bus.

## Automatic Fire Suppression System (AFSS)

The Volvo 9700 US/CAN bus is equipped with an Automatic Fire Suppression System (AFSS). This system provides continuous monitoring of the hazard areas of the engine bay. It responds to fires fueled by diesel, oil, lubricants and another flammable liquids.

If a fire is detected, the system will alert the driver with both audible and visual alarms while immediately shutting down the air conditioning system. A time delay allows the driver the capability to bring the vehicle to a safe stop prior of the activation of the fire extinguisher and engine shutdown.

**Note:** If additional time is required the timer can be reset by pressing the “delay engine stop button” placed in the **fire protection panel** located in the dashboard.

For more information related to the Automatic Fire Suppression System (AFSS) operation, see separate operating instructions: “Automatic Fire Suppression System (AFSS)”.

Also, for more information about additional multiplexed fire detection system in the engine bay, see the following section in this manual: “Additional fire detection system (multiplexed)”, page 153.

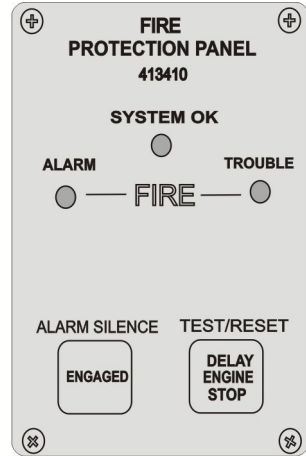

T8061163

Fire protection panel.

# 90 Emergency and safety equipment

---

## Automatic Fire Suppression System (AFSS) manual discharge

In the event of fire do the following:

- 1 Twist and pull tamper seal to remove.
- 2 Lift the cover.
- 3 Push the red button.

If the driver activates the manual discharge switch the following will occur:

- 1 The “FIRE” alarm lamp will illuminate and the alarm buzzer will sound.
- 2 The extinguisher will discharge.
- 3 The engine will shutdown.

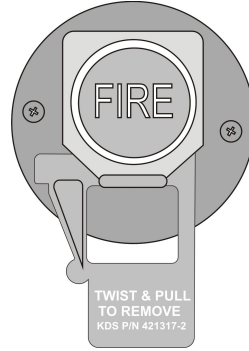

T8061299

Manual discharge (red color) button.



### CAUTION

Service the Automatic Fire Suppression System (AFSS) before restarting equipment.

## Park pilot system

The Volvo 9700 US/CAN bus is equipped with the park pilot system. This system is a bus parking assistant with four ultrasonic sensors and helps the driver to reduce the potential collision risk with the obstacles or other vehicles when parking maneuvers are performed.

The park pilot system consist of the following elements:

- Electronic control unit (ECU).
- Driver display (mounted in a base located in the left “A” pillar).
- Four ultrasonic sensors (mounted on the rear bumper).

The system detects the distance between the rear bumper an a obstacle through its four ultrasonic sensors (mounted in the rear bumper). These sensors generate a signal, which is showed on the driver’s display and inform the driver the distance with respect to an obstacle, also and a visual LED bars indicator on the display providing graphical information of the distance between the rear bumper an obstacle and a warning alarm will be heard when the distance to the obstacle is less than 2 meters.

For more information, see separate operating instructions manual provided by the manufacturer “Actia”.

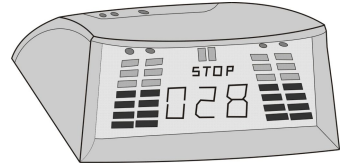

W0095901

Park pilot driver’s display.



W0090067

Park pilot driver’s display location (1).



### WARNING

The park pilot system does not replace the use of the rear view mirrors and drive the vehicle so cautious.

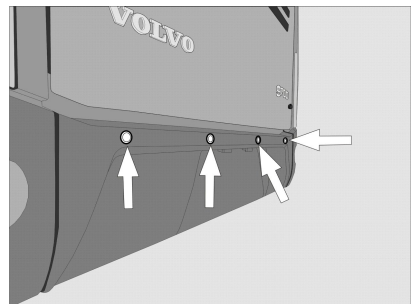

W0090016

Park pilot system ultrasonic sensors located on the rear bumper.

## 92 Emergency and safety equipment

---

### Tire Pressure Monitoring System (TPMS)

The Tire Pressure Monitoring System (TPMS) is a sensing device (1) designed to identify and display tire operating data and activate an alert or warning when pressure or temperature irregularities are detected.

The system will monitor all vehicle tires plus the spare tire when a spare is supplied.

For more information of the Tire Pressure Monitoring System (TPMS) operation, see separate operating instructions: “Tire Pressure Monitoring System”.

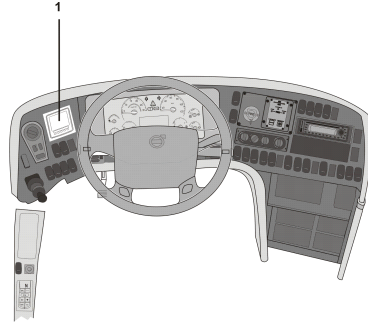

W0089756

**Note:** Is it driver responsibility to react promptly and with discretion to alerts and warnings. Abnormal tire inflation pressures should be corrected at the earliest opportunity.

(1) Tire Pressure Monitoring System (TPMS) display location in the dashboard.

## Tire Pressure Monitoring System (TPMS) display

The Tire Pressure Monitoring System (TPMS) display knows where the sensor are located. It receives the raw temperature and pressure readings from the TPMS receiver, it reads several signals from the vehicle and does the calculation required to generate the various screens.

When no readings have been received for a tire location or when the received data correspond to a parameter range defined as unavailable and appears as two dash lines “\_ \_”.

Also characteristics to the Tire Pressure Monitoring System (TPMS) display are:

- The TPMS display is initially configured to define how many axles and running tires are present on the vehicle.
- The TPMS display is also configured with several other parameters, including threshold levels for the alarms.
- The TPMS display power supply turns **OFF** when the ignition key is switched **OFF**.



W0089757

Tire Pressure Monitoring System (TPMS) display.

# 94 Emergency and safety equipment

## Warning triangle

The warning triangle is located either in the toolbox located inside of the luggage compartment, or in a holder to the right of the driver.

The warning triangle is used whenever a fault forces the bus to stop in a hazardous location. Switch on the hazard warning lights and place the warning triangle at a distance stipulated by the traffic regulations of the country in question.

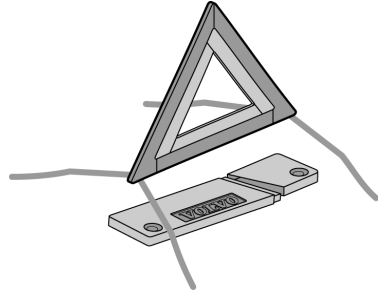

T8011683

## First aid kit

The first aid kit contains basic first aid materials.

The first-aid kit is located into a compartment placed inside to the right luggage rack first compartment from the passengers area (for the fire extinguisher, see the following section in this manual: “Fire extinguisher”, page 88).

**Note:** The first-aid kit compartment is identified with the corresponding labels.

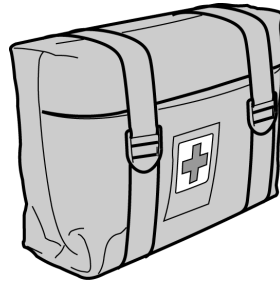

T1008716

First-aid kit.

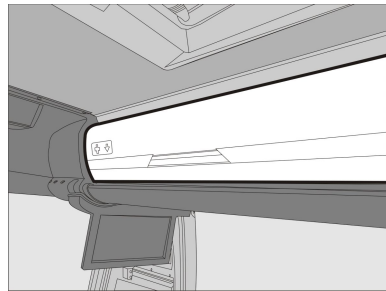

W011066

First-aid kit location in the bus.



## Tire inflation valve

The Volvo 9700 US/CAN bus is equipped with output pneumatic valve located next to the driver's seat or inside the first service hatch.

The Valve release the parking brake when is necessary as engine breakdown for instance , e.g. engine breakdown.

The bus toolbox contains a hose that connects between the tire and the tire inflation valve.

Tire inflation valve be used to:

- Inflate a tire using the bus pneumatic system.
- Release the parking brake using the air from a tire.

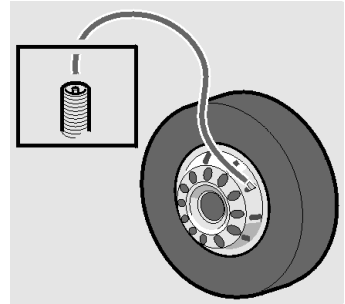

T0009182

## External air supply connection

In the Volvo 9700 US/CAN bus, behind the front hatch there is a valve to which an external air supply can be connected. This could be used when parking the bus overnight, to prevent emptying of the air system.

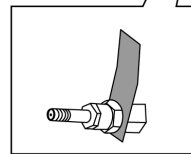
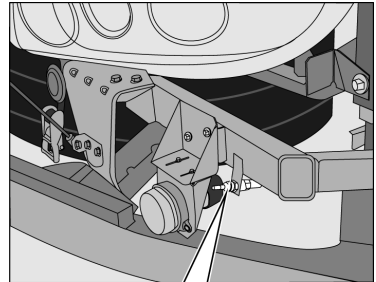

T0015390

### Hydraulic jack

The bus is fitted with special jacking points to comply with safety regulations. For detailed information concerning the use of the hydraulic jack and wheel replacement, see separate operating instructions: “Replacement of wheels”.

**Note:** The hydraulic jack supplied with the bus used to lift the bus over intended lifting points (see the following section in this manual: “Wheels replacement”, page 187) to change a wheel at a time.

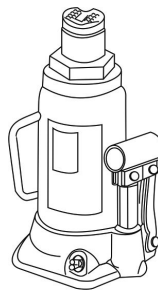

T0015345

#### **DANGER**

Always ensure that the bus is standing on a level surface and chock the wheels so it cannot move. Failure to do so may result in serious personal injury or death.

## Toolbox

The toolbox and tools can be purchased from your local dealer. A complete toolbox contains:

Toolbox	
Item	Part Number
Hydraulic jack (2 units).	3124497
Adaptor for the hydraulic jack.	3178753
Wheel wrench.	9521826
Towing kit.	205465449
Hammer.	962207
Pumping hose.	942868
Warning triangle.	3176488
Key for the hatches.	70319047
Female key.	70344906
Male key.	70344905
Pliers.	962042
Adjustable wrench.	755
Screwdriver with bits.	978201
Spare wheel wrench.	1062412
Winch handle.	1590997
Extension for pumping valve.	1621456
Socket wrench 19 & 24 mm.	8189085
Hydraulic jack extension.	1586079
Hydraulic jack extension.	1577686
Wheel wrench extension.	20592217
Tool bag.	1577384
Wheel chocks (2).	8158698

### Engine control panel in engine bay

The engine control panel is located behind the engine hatch in the back of the bus. It is used in conjunction with servicing.

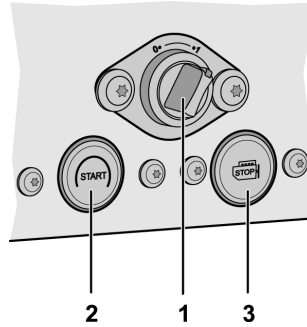

T2023998



#### CAUTION

To avoid accidental engine turning on while you are in the engine bay, the switch (1) must be in position 0.

The control panel has three controls:

#### 1 Start switch.

When the switch (1) is turned to position 1, the engine can be started from the start button on the control panel, or the key ignition on the dashboard. When the switch (1) is turned to position 0, the engine cannot be started from the engine bay, nor from the dashboard.

#### 2 Start button.

When switch (1) is turned to position 1, when pressing this button (2) starts the engine. The transmission must be in neutral position to start the engine from engine control panel. (N), and the ignition key must be in “DRIVE” position.

#### 3 Emergency stop button.

Press the red button to stop the engine (3).

## Emergency exits

### Doors

There is a valve for emergency door opening above to the service door, turning the knob cuts off the compressed air supply to the door and can be opened manually.

After turning the valve knob and hence cutting off the compressed air supply, a warning lamp lights up and a buzzer sounds.

To return the compressed air system to normal state, turn the knob back to initial position and press the appropriate open door button on the dashboard (see the following sections in this manual: “Opening the bus from inside”, page 7).

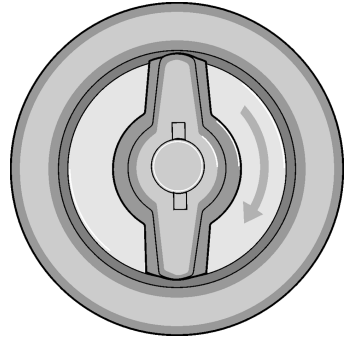

T8009617

# 100 Emergency and safety equipment

---

## Roof hatches

The Volvo 9700 US/CAN bus is equipped with 2 roof hatches used for ventilation and as emergency exits. To open the roof hatches in case of emergency, pull the hatch red handles and push the hatch upwards.

- From inside, pull the hatch red handles and push the hatch upwards.
- From outside, pull the hatch red handles and pull the hatch.

For more information, see separate operating instructions: “Manual roof hatch operation”.

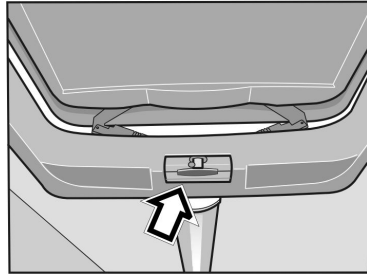

T8010110

Opening roof hatch from inside.

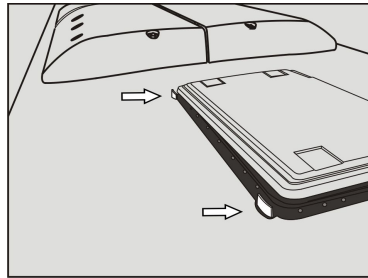

T8061298

Opening roof hatch from outside.

## Emergency windows

The Volvo 9700 US/CAN bus is equipped with this mechanical type of the emergency windows distributed along the passengers compartment. These windows can be opened from inside the vehicle as emergency exits. A decal on window sills indicates the location of the emergency windows.

To open an emergency window, lift the window release bar (sill) and push the window from the bottom to open. To close, lift the release bar and pull the window into position. Push down the release bar to lock the window shut.

For exit from the bus do the following:

- 1 Pull the red bar located at the bottom of each emergency window.
- 2 Push and hold the window with both hands.
- 3 Exit carefully.



TS061781

Emergency windows with the opening mechanism at the bottom of the window glass.

# 102 Starting and driving

## Checking before driving

Before starting the bus and driving off, check the pressure sensitive edges on the doors. If the door leaf during opening encounters an obstacle, the door should stop. If the door leaf encounters an obstacle during closing, the door should open again. It should not be possible to open the doors by hand while the engine is running.

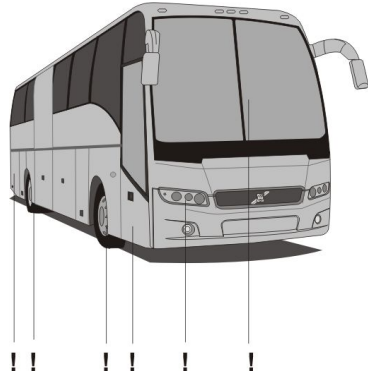

T0015270



### WARNING

Make sure that the sensitive edges on the door work prior to vehicle use. Failure to do so may lead to personal injury of passengers.

Always make sure of the following:

- All the hatches are closed.
- All the lighting is working properly.
- The windshield wipers and washers working properly.
- The safety equipment its in corresponding place.
- The direction lights indicators and the horn are working properly.
- The tires air pressure is correct and any object this stuck between the dual rear wheels.
- The destination sign information and the line number are correct.
- The service doors emergency opening system are working properly.



## Bus interior and exterior cleaning and maintenance

It is recommended to perform daily bus cleaning will keep the attractive look of the vehicle to ensure that the service life and durability for optimal operation conditions. For more information about care and precautions when is performed the cleaning of bus interior, see separate operating instructions: “Interior cleaning and maintenance”.

When washing the outside of the bus, only use agents that are intended for this purpose, see the separate operating instructions: “Exterior cleaning and maintenance”.

**Note:** The areas subjected to intensive use by passengers require more attention.

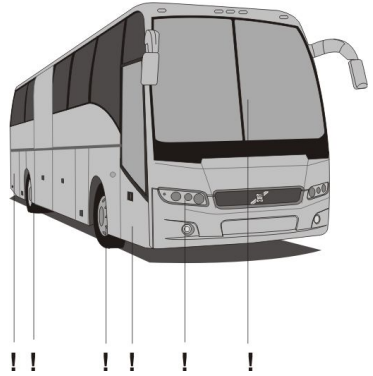

T0015270

## Check the warning lights

When the ignition key is in the **I** position, the control system verify that all warning lights are working properly.

All warning indicator lights in the dashboard turn on by approximately **5 seconds**. The ABS system warning indicator turn on some more time than the other indicator lights.



T3014364

Stop message.



T3014365

Warning message.

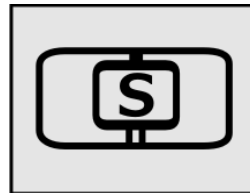

W3079585

Stop at the next bus stop message.

 <b>CAUTION</b>
If the ABS system warning lights on, the malfunction indicator light (MIL) or the "CHECK" light continue turn on after <b>5 seconds</b> of turn the ignition key to the <b>I</b> position, indicates that one or many electronic problems in the bus systems. If this happens, you must go immediately to an authorized Volvo service center, to correct the existing problems.

## Daily inspection

The fluid levels on the bus as engine oil, power steering fluid and the coolant, should be reviewed daily. This checking must be made with the **warm** and engine **OFF**. All the fluid reservoirs are located at the rear of the bus.

**Note:** Its recommended make these checks after a trip, when the engine is at normal operation temperature.

## Engine oil level

To check the engine oil level, do the following:

- Park the bus over leveled ground and open the engine hatch compartment (use the appropriate key, see the following section on this manual: “Keys”, page 2).
- If the engine is cold, leave in idle speed at least by **1-3 minutes**.
- Shut off the engine. Wait at least **5 minutes** before carry out the inspection.
- Get out the oil dipstick.
- Check the engine oil level in the oil dipstick marks. The engine oil level must be between of the “**MAX**” and “**MIN**” marks and clean up the oil dipstick with a clean cloth.
- Add oil if necessary.
- Close the oil pipe with their cap.
- Close the engine compartment hatch.

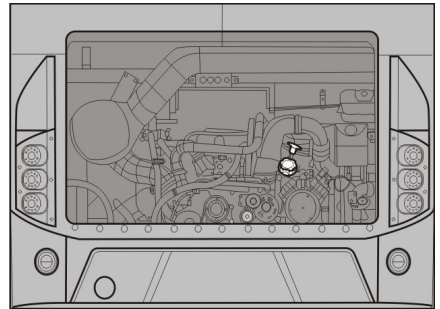

T8050919

## 106 Starting and driving

### Hydraulic level fluid for the engine coolant fan

Park the bus over leveled ground, open the engine compartment hatch (use the appropriate key, see the following section on this manual: “Keys”, page 2) and check that the hydraulic oil level its between of the “MAX” and “MIN” marks on the fluid reservoir for the engine coolant system fan. Add hydraulic oil if necessary and close the corresponding fluid reservoir and the engine compartment hatch.

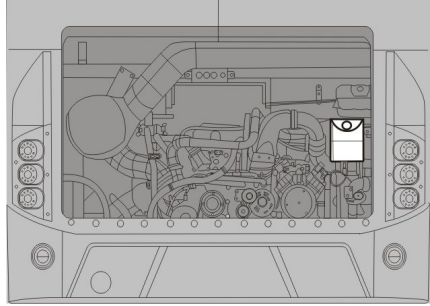

T8056920

### Power steering hydraulic oil level

Park the bus over leveled ground and open the engine compartment hatch (use the appropriate key, see the following section on this manual: “Keys”, page 2) and check that the power steering hydraulic oil level its between of the “MAX” and “MIN” marks on the corresponding fluid reservoir. Add hydraulic oil fluid if necessary and close the fluid reservoir and the engine compartment hatch.

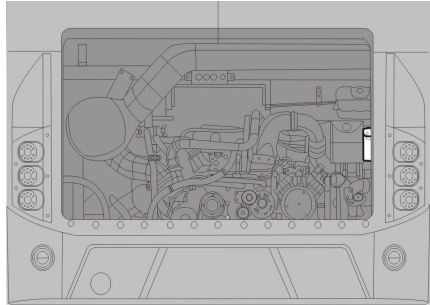

W0108035

### Engine coolant system fluid level

Park the bus over leveled ground and open the coolant reservoir compartment hatch (as refer, see the following sections on this manual: “Doors and hatches configuration”, page 10 or “Doors and hatches configuration (bus with WCL)”, page 11) and check the engine coolant system fluid level its between of the “MAX” and “MIN” marks on the corresponding fluid reservoir. Add coolant if necessary and close the fluid reservoir and the engine compartment hatch.

**Note:** The reservoir is located over the rear engine door.

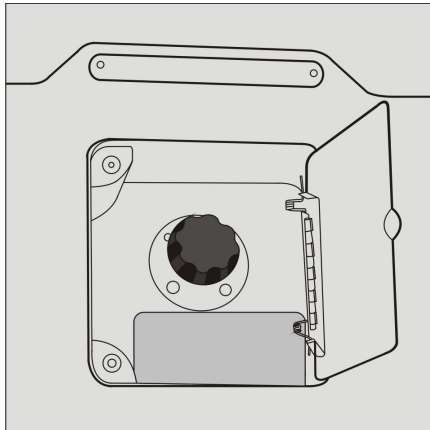

T8061297

## Windshield washer fluid

Check the level of the washer fluid in the reservoir. Top up if necessary.

For add the washer fluid, do the following:

- Open the front left lower side hatch (to refer, see the following sections on this manual: “Doors and hatches configuration”, page 10 or “Doors and hatches configuration (bus with WCL)”, page 11).
- Lid the fluid reservoir cap.
- Place a funnel in the fluid reservoir filler neck and pour the washer fluid.
- Add a washer fluid up to its between of the “**MAX**” and “**MIN**” marks on the corresponding fluid reservoir.
- Close the washer fluid reservoir.
- Close the front left lower side hatch.

**Note:** In winter use a washer fluid for lower temperatures to avoid the fluid freezing inside reservoir.

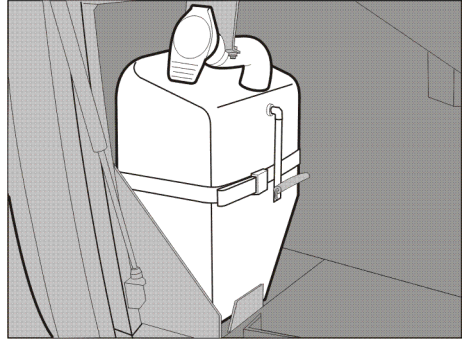

W0100282

## Fuel replenishment

The Volvo 9700 US/CAN bus has two tanks with **105 gallons (400 liter)** capacity each one.

For bus fuel replenishment, do the following:

- Open the fuel filler cap hatch (use the appropriate key, see the following section on this manual: “Keys”, page 2).
- Open the filler cap of the fuel tank. To open press firmly with the entire palm hand whole to release the latch of your lock and release the filler cap.
- Insert the end of the fuel dispenser hose within the fuel tank filler neck.
- Fill the fuel tank with diesel fuel. The fuel tank must be filling up to **95%** as maximum to leave space at the top of the fuel tank for the originated fuel vapors and prevent spillage during the trip.
- After filling the fuel tank, remove the fuel dispenser hose and put it in the fuel dispenser pump.
- Close the fuel tank filler cap. To close the filler cap, press firmly with the entire palm hand the filler cap over the fuel tank filler neck to place the latch in the lock to then release the filler cap.
- Close the fuel filler cap hatch.

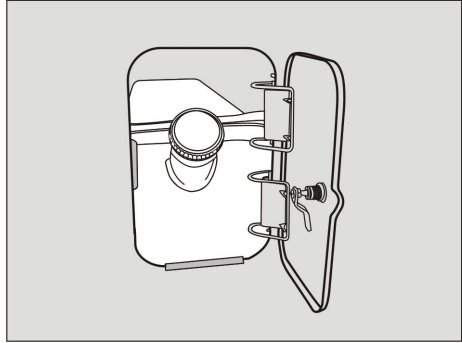

T2061889

## Fuel replenishment warnings



### CAUTION

The use of Diesel fuel other than ULSD, will adversely affect performance, efficiency and durability of the DPF system and the engine, to the point where the engine may not run at all. Manufacturer's warranties can also be rendered void due to usage of improper fuel. None approved fuel additives (including engine oil) are NOT permitted. Blends of No. **1D** and No. **2D grades of ULSD** are recommended and allowable for cold weather operations.



### CAUTION

Use only fuel that meets the recommended Volvo specifications. Contact to Volvo technical advisor to meet the appropriate fuel specifications for the engine installed in the bus.



### CAUTION

When filling the fuel tank, don't spill a fuel on the painted surfaces to avoid damaging the paint finish.



### WARNING

For your safety and the passengers, only replenishment fuel only in designated locations.

# 110 Starting and driving

## Diesel Exhaust Fluid (DEF) tank

On the right side and on the rear is the Diesel Exhaust Fluid (DEF) tank. To DEF tank fill cap access, open a lid hatch on the rear right side hatch compartment using the appropriate key (see the following section on this manual: “Keys”, page 2).

The DEF tank can hold **60 liters** capacity. As a guide, use **5 — 7%** DEF in relation to the fuel for after treatment systems “EPA 14”.

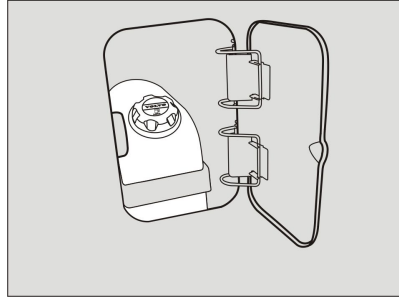

T2061890

**Note:** Avoid spilling DEF on to painted surfaces. In case of spilling, rinse the painted surfaces immediately.



### WARNING

Use only pure certified DEF from an approved dispenser or sealed container.



### CAUTION

Do not put diesel fuel in the DEF tank. Diesel fuel, if sprayed into the hot exhaust along with the DEF, could ignite explosively causing a fire resulting in personal injury or damage to the exhaust system.



## Diesel Exhaust Fluid (DEF) level related messages

The Diesel Exhaust Fluid (DEF) level is shown in the driver display in the dashboard, on the “Gauges” menu, then in the sub-menu “DEF tank, level”.

If the Diesel Exhaust Fluid (DEF) level fall down of a defined level (**20% reservoir capacity**), in the driver display shown a warning message in the dashboard, if this warning message appears fill the Diesel Exhaust Fluid (DEF) tank as soon as possible. If a fault condition occurs in the aftertreatment system, will display the corresponding malfunction icon in the driver display in the dashboard and the indicator light will flashes in the cluster, indicating that a problem relates to the emissions control system.

For more information related with the exhaust aftertreatment system to the emissions control used in “EPA 14” engines, see separate operating instructions: “Exhaust aftertreatment system”.



T3014365

Indicator light “CHECK” on in the cluster, when occurs the Diesel Exhaust Fluid (DEF) lower fluid tank level.

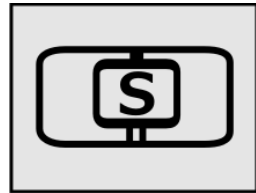

W3079585

Indicator light “Stop at the next bus stop” on in the cluster, when occurs the Diesel Exhaust Fluid (DEF) lower fluid tank level.

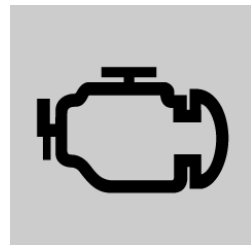

T3019966

Malfunction icon indicator shown in the driver display if the Diesel Exhaust Fluid (DEF) fluid tank level is below of **20%**.

## 112 Starting and driving

---

### Engine block heater

An electric engine block heater can be installed for keeping the coolant hot when the vehicle is parked

This equipment has the following features:

- The heater is mounted through the side of the engine block with the heater coils in the coolant jacket.
- The heater does not interfere with normal operation and can be permanently installed.
- The heater runs on **120 V** and has an easily accessible plug, located on the right side of the engine compartment.

**Note:** The plug will hook up to a normal extension cable.

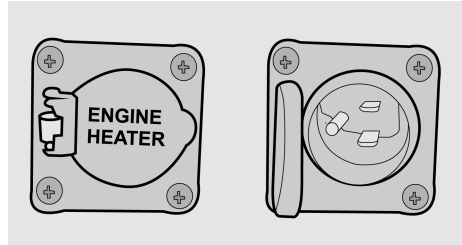

T0015492

## Starting the engine

### Starting

When engine starts, the parking brake must be engaged and the gear selector must be in neutral N, turn the ignition switch up to **III** position “starting position” and once the engine starts, release the key switch.

For more information about the ignition switch positions, see the following section on this manual: “Ignition switch”, page 46.

### Start a cold engine

When starting the engine at temperatures around **50 °F (10 °C)** and below, the air entering the engine should be heated. To prevent wear and possible damage to the engine when it is cold, gradually bring it up to operating temperature before high engine speed operations or full load. After starting and before moving the vehicle run the engine at **800 to 1000 rpm** for **3 to 5 minutes**.

Operate at partial engine load until the coolant temperature reaches **167 °F (75 °C)**.

For an engine cold start, **proceed as follows:**

- Turn **ON** the ignition key switch between **II** and **III** positions, this starts the preheating.
- The indicator light of the preheating relay turn on in the dashboard during the preheating which can take up to **50** seconds, it depends of coolant temperature.
- Once the pre-heater indicator has turn **OFF** and the needle of the temperature gauge has moved out lower limit, the engine can be started.



T0014333



#### CAUTION

Do not let a cold engine run faster than **1000 rpm** in very low temperatures (**< -68 °F (-20 °C)**). Failure to do so may be cause internal engine damage.

# 114 Starting and driving

---

## Starting a warm engine

Engine starts when key switch turned on start position (**III**).

For more information about the ignition switch positions, see the following section on this manual: “Ignition switch”, page 46.

## Shutdown the engine

To shut down the engine, turn the ignition switch key to the **0** position.

For more information about the ignition switch positions, see the following section on this manual: “Ignition switch”, page 46.

In an emergency situation the engine can be shut down by using the emergency stop switch.

For more information related to the emergency stop switch see the following section on this manual: “Emergency stop switch”, page 31.



### CAUTION

Before turning **OFF** engine. If the engine has run at high temperature for a significant time before it is shut down, let the engine run at idle for **3 minutes** to cool the engine **OFF** to avoid heat soak.

## Indicator lights on after the engine has been started.

Indicator lights on when the engine starts:

- The coolant level warning lamp lights up for second when the engine starts.
- The parking brake warning lamp lights up when the parking brake is engaged.
- After releasing the parking brake, the lamp should remain lit until the pressure increases to roughly **78 psi (540 kPa)**.
- The foot brake warning lamp and the “STOP” lamp should remain lit until the pressure in the compressed air tanks reach a sufficiently high level.



### **DANGER**

Do not drive the vehicle until the warning lamps have gone out, as the brake system needs the correct air pressure to work properly. Failure to do so may be lead to an accident, resulting in serious personal injury or death.

## Engine idle speed adjustment

The normal engine idling speed is **575–625 rpm**. Keeping the idling speed constant is the task of the engine electronic control system, which makes manual adjustment unnecessary. When the bus is stationary, the idling speed can be temporarily raised to **1200 rpm** adjusting as follows.

### Idle speed adjustment

Before you start to adjust the engine idling speed, the engine must be warmed up to operating temperature, adjust the idle speed as follows:

- The switch (B) in the control lever at the steering column left side, should be in **ON** position.
- Press the “SET” button (A, located at the end on the same lever) to the “+” position. Each time this button is pressed to this position is obtained by an increase of **10 rpm** on the idle speed.
- If the idle speed torn high, can be reduce by press the “SET” button (A) to the position “-”. Each time this button is pressed to this position is obtained by an decrease of **10 rpm** on the idle speed.

**Note:** The change in idling speed is only temporary. After pressing a pedal, engaging a gear or releasing the parking brake, the idling speed will return to its manufacturer settings (**575–625 rpm**).

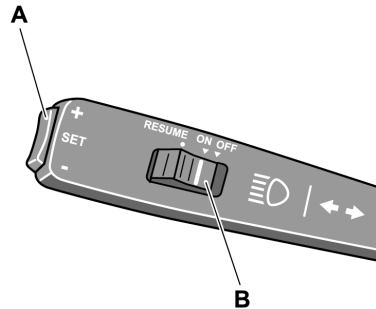

T0012078

## Engine idle speed adjustment (continue)

If new programming of idling rpm is required, proceed as follows:

- Maintain your foot on the brake pedal.
- Adjust the new idle speed according to the previous procedure.
- Move the switch **B** in the control lever at the steering column left side to the **RESUME** position when the idle speed is the desired and release the switch.
- Shut down the engine for programming this idle speed.

The next time to start the engine and you want that the engine runs to the last idle speed programming do the following:

- Start the engine.
- Let stabilize the default idle speed.
- Move the switch **B** in the same control lever to the **RESUME** position and release the switch.

The engine runs to the last programmed idle speed (this function non counts with a historical programming), to quit the programmed idle speed for the engine runs to the default idle speed, do the following:

- Press the throttle pedal.
- Press the brake pedal.
- Move the switch **B** in the control lever to the **OFF** position.

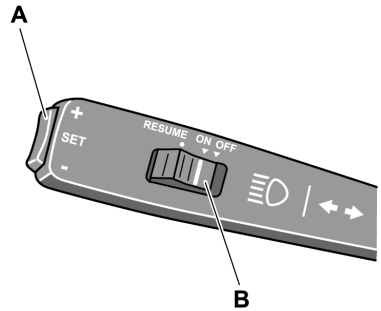

T0012078

**Note:** If the engine do not “runs smoothly” at the default programmed by the manufacturer, please visit an authorized Volvo service center.

# 118 Starting and driving

## Cruise control activation

To activated the cruise control do the following:

- Move the switch **B** in the control lever at the steering column left side to the **ON** position.
- When the bus reached the desired speed, press the “SET” button **A** located in the same lever to the “+” or “-” position for idle speed established.
- Press the “SET” button **A** in the same lever to the “+” position for increase established idle speed.
- Press the “SET” button **A** in the same lever to the “-” position for decrease established idle speed.

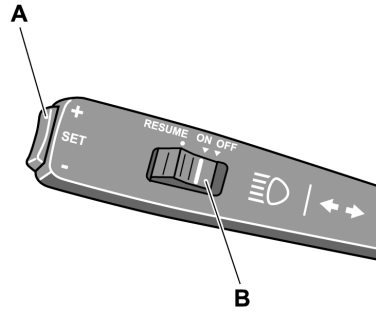

T0012078

**Note:** If the speed is desired to increase temporarily, for example; to pass other vehicle, accelerate the bus and when you finish the maneuver, release the throttle and move the switch **B** in the control lever at the steering column left side to the **RESUME** position and release the button. The bus return to the established speed.



## Cruise control deactivation

Cruise control is deactivated if do the following:

- The brake pedal is pressed.
- The clutch pedal is pressed.
- The retarder control lever its move to the other position.
- The switch **B** in the control lever at the steering column left side to the **OFF** position.

**Note:** After cruise control has been switched off, the most recent set speed can be restored by moving the switch **B** to **RESUME**. This however does not apply if cruise control has been deactivated by moving switch (**B**) to its **OFF** position.

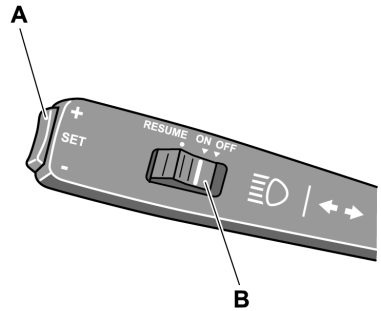

T0012078

## 120 Starting and driving

### Retarder (if installed)

The Volvo 9700 US/CAN bus may be equipped with an auxiliary brake equipment called “retarder”. The function of the retarder is to supplement the service brake acting directly on the main drive shaft that connects the shaft from transmission output with the carrier decreasing its speed, and thus serve an additional assistance brake.

The retarder works without a problem together with the **VEB** (engine brake patented by Volvo), **EPG** (exhaust gasses shutter) and the service brake for obtain a longer delay effect to braking more efficient, preventing it from overheating the service brake.

To completely retarder enable or disable, its count with a switch in the dashboard. But, to retarder activated or deactivated while driving use the control lever located at the steering column right side slightly above to the wipers control lever.

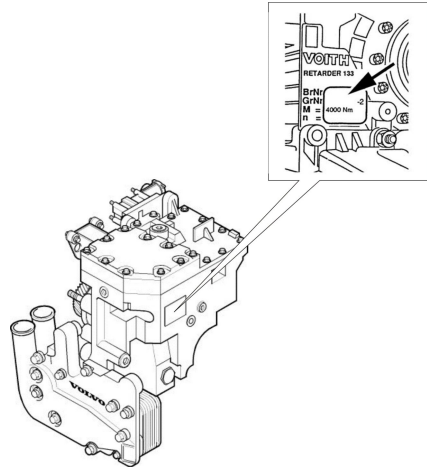

W0089959

## Retarder use (if installed)

This control lever count with many positions which are:

- Position **0**: The retarder is deactivated.
- Position **A**: The retarder is coupled in the automatic mode, this is that the retarder is matched every time the driver press the brake pedal by the time the **RECU** (retarder electronic control unit) select the appropriate intensity braking level depending the operational parameters obtained in real time. This function allows the optimal use of the retarder.
- Position **1**: Softly retarder brake intensity.
- Position **2**: Medium retarder brake intensity.
- Position **3**: Highest retarder brake intensity.
- Position **B**: In this position the control lever have a spring backward, when select it activated a braking program which combine automatically the retarder brake together with the engine and the exhaust brakes (if this auxiliary brake systems are installed in the engine) with brake intensities automatically adjusting by the **EBS** system according to vehicle speed, weight, tilt, engine speed and other more operational parameters. This braking function should be use when you want decrease quickly the bus speed without apply service brakes.

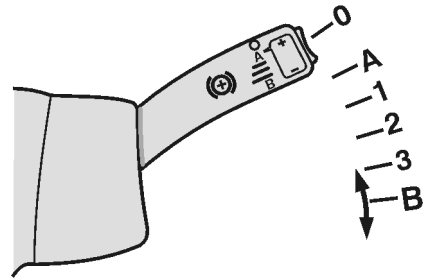

T0010263

**Note:** The **B** position for the retarder control lever only appears in buses equipped with **I-Shift** transmission.

For more information, see separate operating instructions: “EBS”.

## 122 Starting and driving

### Retarder use (continue)

When you place the retarder control lever in either **1 to 3** positions, the bus is braked by the retarder with the corresponding brake intensity as soon as release the throttle pedal. The retarder power brake is gradually increase by sequentially moving down the retarder control lever and the retarder power brake is gradually decrease by sequentially moving up the same control lever.

In some coaches the retarder may be activated or deactivated by brake pedal.

For more information, see the following section on this manual: “Service brakes”, page 65.

Its important to mention while driving if maintain the retarder continuously operated and in this moment apply a panic or emergency brake, the **ABS** system enter and turn on the indicator light in the dashboard. When occurs this, the retarder function its automatically deactivated. This is completely normal to avoid damages on any brake system component.

The retarder operation and control functions are integral managed by the **EBS** system. For more information, see separate operating instructions: “EBS”.

**Note:** The bus minimum speed for retarder can activated is of **19 mph (30 km/h)**. Below this speed the retarder its automatically deactivated.

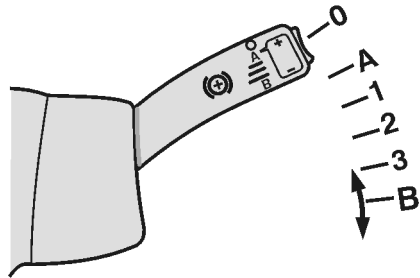

T0010263

### DANGER

Avoid using the retarder on slippery roads because of the risk of locking the wheels and skidding because the reason that the retarder brakes only the driving wheels, in these conditions drive with sufficient safety margins. Failure to do so may lead to an accident, resulting in serious personal injury or death.

## Speed limiting

When the bus is driven downhill with the retarder stalk in position **A**, the retarder acts as a speed limiter.

For use the retarder in this operating mode, do the following:

- When the bus has reached the desired speed, lightly press the adjusting “SET” button **A** Located at the retarder control lever end (in the steering wheel column right side) to the “+” or “-” positions. The retarder keep the bus speed on the last adjustment when press the “SET” button **A**.
- The established speed may be can increase or decrease, pressing the “SET” button **A** in the same control lever to the “+” or “-” positions. Each time press the button increase or decrease the speed in relation of **0.6 mph (1 km/h)**.
- If maintain pressing the “SET” button **A** in the same control lever, the speed is adjust in relation of **0.6 mph (1 km/h)** per second that maintain pressed the button.

**Note:** The buses that have a switch for retarder activation in place of the control lever, the retarder not count with this function.

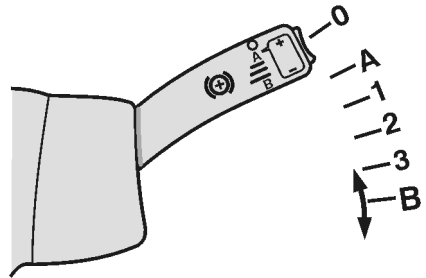

T0010263

Use the “SET” button **A** in the retarder control lever to control the speed limiter.

## 124 Starting and driving

### Combined cruise control and speed limiting

If the bus is equipped with the cruise control (see the section on this manual “Cruise control activation”, page 118), This system can operate together with the retarder. For this its possible, the retarder control lever should be in the “A” position. With the activated cruise control system the retarder will engaged if the bus speed exceed the established cruise control speed by **3 mph (5 km/h)**. This speed adjust value may be modified at any moment by press the “SET” button **A** located at the end in the control lever at the steering wheel left side to the “+” or “-” position. This over speed value can be modified to any value in the range **2 to 9 mph (3 to 15 km/h)**.

**Note:** The retarder is automatically deactivated if there is a risk for wheel locking, this is completely normal.

For more information, see the following in this manual: “Retarder (if installed)”, page 120.



T3008844



#### CAUTION

If the symbol for high retarder temperature is displayed, a lower gear range must be selected to cool it down.

For more information, see separate operating instructions: “Display”.

## Power steering

The Volvo 9700 US/CAN bus is equipped with a servo assisted, increasing the driving comfort specially when performing maneuvers in yard or parking.

If the wheel is blocked on one side, i. e. against a curb, drive carefully forward and turn the steering wheel to allow the bus to move away from the kerb. Never try to force the wheels to turn.

Do not attempt to turn the bus by means of the use of excessive force on the steering wheel. Use excessive force on the steering wheel increases the pressure in the cooling system, causing a risk of overheating that can damage the hydraulic steering pump.

If the power steering is malfunctioning it may be feel as if the steering gear was blocked or a steering gear excessively hard, if this happens, do not start the trip and immediately contact an authorized Volvo service center to request the assistance road rescue service to move the bus and fix the problem (see the following section on this manual “Assistance and rescue on highway”, page 143).

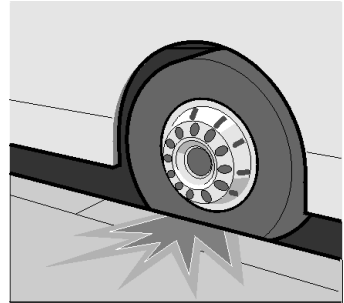

T0008960



### **DANGER**

Never drive with the steering system in malfunction condition or damaged. Failure to do so may be lead to an accident, resulting in serious personal injury or death.

### Exhaust Aftertreatment System (EATS) components

The Volvo 9700 US/CAN bus has an exhaust gasses aftertreatment system which complies with the environment emissions regulation **EPA 14**.

The Exhaust Aftertreatment System (EATS) complies with the emissions regulation **EPA 14** have the following main components:

- 1 Diesel Particulate Filter (DPF).
- 2 Diesel Emission Fluid (DEF) dosing valve.
- 3 Catalytic converter.

In normal operation, the catalyst surface can reach high temperatures around by **662° F (350° C)** so you have to take extreme precautions to avoid a burn, if for any reason its required an inspection in nearest catalyst or DPF areas specially when the engine is in operation or just getting to a certain destination.

Inspection of the **Exhaust Aftertreatment System (EATS)** components to detect a possible failure and fixed by authorized technicians as soon as possible. Its also important to check in the catalyst or in the DPF surfaces does not have substance traces that may be potentially flammable and may be cause fire due to the high system temperatures during normal operation.

New stringent standards for exhaust emissions control begin with the US 2017 engine model year. The Diesel Particulate Filter (DPF) system has been developed to act in combination with ultra low sulfur diesel (ULSD) fuel to reduce particulate emissions to meet the requirement. The Exhaust Aftertreatment System (EATS) includes all the engine and exhaust emissions control components that are required to meet the stringent **EPA 14** standard.

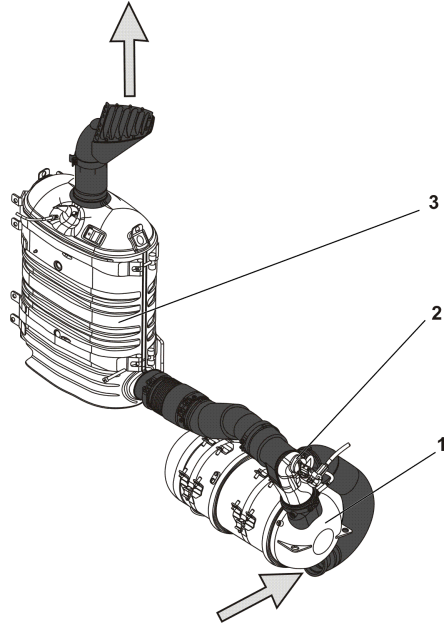

W0100283



## Exhaust Aftertreatment System (EATS), warnings



### CAUTION

The Diesel Particulate Filter (DPF), Diesel Emission Fluid (DEF) Dosing Valve, Catalytic reducer and associated components are part of a U.S. EPA and California Air Resources Board (CARB) certified engine emissions system. These components **must no be moved, altered or modified from OEM installation in any way** any alterations may cause component damage and is prohibited by the law. Tampering with these systems render the emissions warranty void and may result in possible tampering charges by the EPA or CARB.



### WARNING

When you arrive from a trip or the engine is in operation and the exhaust system is warm, do not stay nearest to the Diesel Particulate Filter (DPF) area, if it is necessary to perform an inspection on nearby components or the Exhaust Aftertreatment System (EATS). Must wait for the engine exhaust system to cool to avoid the risk burn.



### DANGER

The DPF and the Catalytic reducer cover should not be removed while the vehicle is in use. Also, only remove the cover, once the vehicle is out of use and the Catalytic Reduction and the DPF is sufficiently cooled. Failure to follow these instructions can result in fire, which can cause component damage, personal injury or death.

## 128 Starting and driving

---

### Diesel Particulate Filter (DPF) regeneration required icon

If the icon “DPF Regeneration Required” lights on, means that the diesel particulate filter is becoming full and regeneration is needed; the icon flashes when the filter is full, maintain uninterrupted highway speed for an automatic regeneration or move the vehicle to a safe location and initiated a parked regeneration.

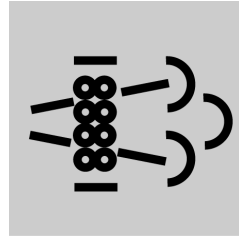

T0015482

---

## High engine exhaust system temperature

The icon “High engine exhaust system temperature” lights on when a parked regeneration is initiated. It also indicates high exhaust gas temperature during an speed regeneration. When the high exhaust system temperature icon is light on, do not park or operate the vehicle near people, or any flammable materials, vapors, or structures. For more information about Exhaust Aftertreatment System (EATS), see separate operating instructions: “Exhaust Aftertreatment System”.

**Note:** It is important to enable regeneration as soon as possible to avoid engine problems. Long—term engine operation with regeneration disabled will result in a loss of engine performance including horsepower, torque and speed decrease.

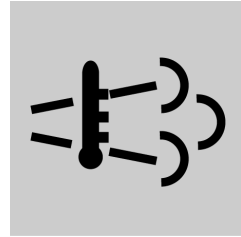

T0015483

### Emission green house gas component warranty

#### *Critical emissions related maintenance*

- **Source of parts and repair:** A repair shop or person of the owner's choosing must maintain, replace, or repair emission control devices and systems per manufacturer's recommendations.
- **Replace of the tires that are GHG certified:** The original equipment tires installed on this vehicle at the factory were certified to the U.S. EPA Greenhouse Gas (GHG) and National Highway Traffic Safety Administration (NHTSA) fuel efficiency regulations. Replacement of these tires should be with a tire of equal or lower rolling resistance levels (TRRL or Crr). Please consult tire supplier(s) for appropriate replacement tires.
- **Maintaining a GHG certified tire:** In order to maintain the certified tilling resistance of the tires which optimize fuel economy, the maintenance procedures provide by the tire manufacturer must be followed. *Please visit PrevoSt Web Site for further information about Warranty.*

## I-Start system

The Volvo 9700 US/CAN bus is equipped with the I-Start system, which is a dual battery system where divide the starter batteries from the consumer batteries.

The I-Start system is designed to improve and secure cranking also to provide a longer service life for the batteries even if deep-cycled by the consumers.

The I-Start system avoid discharge the batteries when the bus is not used for a time, this is supported by the main switch function when the ignition key is in **(I)** position.

With I-Start system the body loads can be active for a longer period without the risk of affecting the crank ability because the starter batteries are protected from draining. For more information related to I-Start system, see separate operating instructions: "I-Start".

The electric circuit loads for the bus are split in two circuits which are the following:

- Chassis electronics connected to the starter batteries (*right hand side batteries compartment*).
- Body electronics connected to consumer batteries (*left hand side batteries compartment*).

**Note:** Inside of the right side batteries compartment is installed the cut-off batteries switch ("*General switch*"), for more about this switch, see the following section in this manual: "Batteries cut-off switch", page 163.

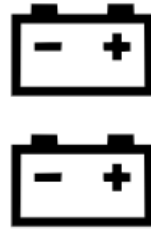

C0080351

I-Start system symbol.

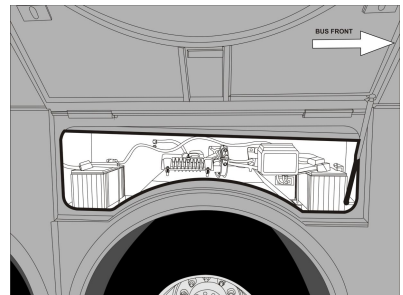

W0110919

Starter batteries compartment (*right hand side batteries compartment*).

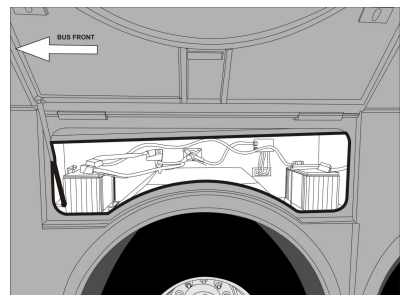

W0110920

Consumer batteries compartment (*left hand side batteries compartment*).

# 132 Starting and driving

## I-Start system (continue)

Inside on each batteries compartments placed a fuse box, this fuse boxes are identified with a decal placed on each fuse box showing which batteries are placed in the compartment:

- Chassis fuse box in the starter batteries compartment.
- Body fuse box, in the consumer batteries compartment.

For more information related relays and fuses positions inside in these electrical boxes, see the following sections in this manual:

- “Relays in the electrical distribution box corresponding to the I-Start system”, page 183.
- “Fuses in the electrical distribution box corresponding to the I-Start system”, page 184.
- “Mini fuse box holder inside to the left hand side batteries compartment”, page 186.

A decal with the system description in three languages is placed on the right hand side batteries compartment hatch backside.

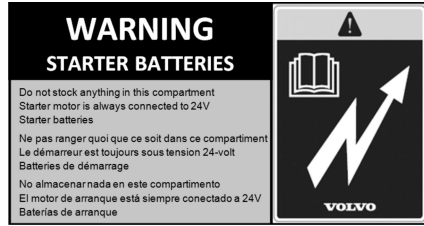

W0111068

Starter batteries decal.

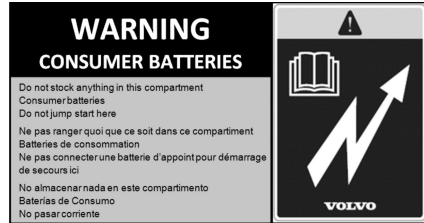

W0111069

Consumer batteries decal.

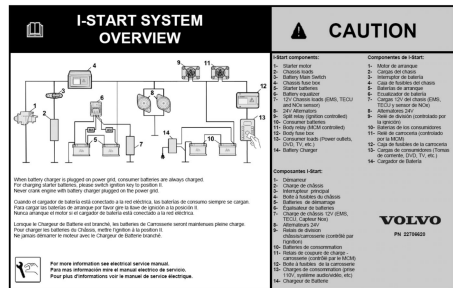

W0111070

I-Start system description decal.

---

## I-Start system failure detection

Due to the reason the I-Start system is multiplexed to the bus electrical architecture bus (*BEA2*), the system operation is continuous monitored by the auto-diagnostic system which informs the driver (through by the driver's information display located in the instrument cluster) of the following conditions (which are the most common):

- MCM (*Master Control Module*) will check and warn if the batteries reach a voltage level higher than **28 V** when the engine is **OFF**. With the engine is **ON**, the voltage threshold was set in **23.5 V** (*low*) and **31 V** (*high*).
- Two messages were also created to inform if there is a problem in the K300 (*PID 158 FMI 1*) or K400 (*PID158 FMI 12*) relays. The messages below will appear on the LCD (*Liquid Crystal Display*) screen of the driver's information display in the instruments cluster whenever MCM (*Master Control Module*) sends the fault codes to BIC (*Bus Instrument Cluster*).

For more information about K300 and K400 relays, see the following section in this manual: "I-Start system power relays", page 136

- MCM sends the information to BBM (*Body Builder Module*) through the *CAN Bus*, and BBM (*Body Builder Module*) sends the fault codes to the driver's information display in the instrument cluster.

For more information related to the MCM (*Master Control Module*), see the following section in this manual: "MCM (Master Control Module) service switch", page 44.

**Note:** For more information related to I-Start fault codes and symbols displayed in the driver's information display related to this system; see separate operating instructions: "I-Start".

# 134 Starting and driving

---

## Starter and consumer batteries failure detection

For the starter batteries, the state of charge is monitored by the BIC (*Bus Instrument Cluster*) module. The BIC (*Bus Instrument Cluster*) module will check and warn in case of high or low voltage being detected in the starter batteries.

In case for the consumer batteries, in order to protect the consumer batteries from draining and prolong their service life, a system based on ARMS (*Automatic Reset of Main Switch*), the MCM (*Master Control Module*) monitored the consumer batteries voltage and opens the **K400** power relay (also see: “I-Start system power relays”, page 136) when **23 V** is detected for more than **130 seconds**, shutting down the + **30** body power source.

**Note:** For the consumer batteries voltage control, this function will only act if the ignition key is on position **I** (for ignition key positions, see the following section in this manual: “Ignition switch”, page 46).

**Note:** For more information related to I-Start fault codes and symbols displayed in the driver’s information display related to this system; see separate operating instructions: “I-Start”.



## ARMS (Automatic Reset Main Switch)

The I-Start system in order to secure energy for cranking, the ARMS (*Automatic Reset of Main Switch*) relay was introduced. The ARMS relay is responsible for shutting down +30 power source to prevent starter batteries from getting drained when **23,5 V** are detected for more than **120 seconds**. The control is made by BBM (*Body Builder Module*) through ARMS (*Automatic Reset of Main Switch*) relay, located in the fuse box inside to the right hand side batteries compartment.

This function will only act if the ignition key is on position **I + a click**, to refer the ignition key positions, see the following section in this manual: “Ignition switch”, page 46.

### ARMS failure detection

When a fault is detected on the ARMS (*Automatic Reset of Main Switch*) relay output the BBM (*Body Builder Module*) will generate a fault code in case of an ARMS (*Automatic Reset Main Switch*) relay open circuit and an icon and/or lamp and text shall be displayed in the driver’s information display.

**Note:** For more information related to I-Start fault codes and symbols displayed in the driver’s information display related to this system; see separate operating instructions: “I-Start”.

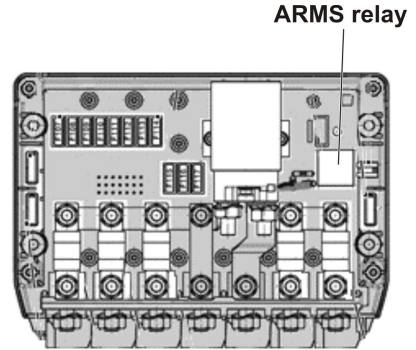

W0111465

ARMS relay inside to the chassis fuse box, located in the right side batteries compartment (*starter side batteries*).

## 136 Starting and driving

### I-Start system power relays

The I-Start system have a two power relays that are part of the system: .

- Body relay (**K400**) which doing the separation between consumer batteries and body loads. This power relay its controlled by MCM (*Master Control Module*).
- Split relay (**K300**) which connecting both chassis and body electronics. This power relay its activated by the ignition key position **II** to refer the ignition key positions, see the following section in this manual: “Ignition switch”, page 46.

Due to **K300** power relay control by the ignition key position **II**, the batteries sets will be put in parallel before starting, providing a higher CCA (*Cold Cranking Amps*), helping with the cranking.

**Note:** Both power relays have a decal in three languages for a better identification.



W011071

**K300** power relay decal.



W011072

**K400** power relay decal.

## Batteries charger

The Volvo 9700 US/CAN bus is equipped with a batteries charger (**120 V AC  $\pm$  10%, 60 Hz  $\pm$  10%** ), installed in the luggage bay, on the left side.

In the right hand side batteries compartment hatch there is installed an electrical outlet for connecting the charger to the power grid.

The batteries charger has the following charging modes:

- If ignition key is **OFF**, on position **0** or **I**, only the consumer batteries are charged.
- If Ignition key is on position **II**, starter and consumer batteries are charged.

**Note:** The bus must not be started with the battery charger connected to the power grid.

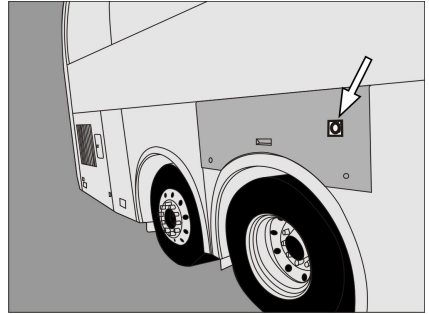

W0111073

Batteries charger electrical outlet location in the bus.

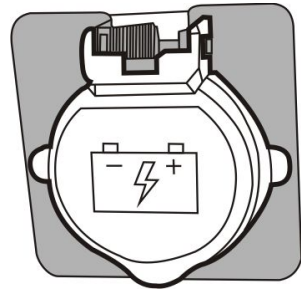

W0111074

Batteries charger electrical outlet.

# 138 Starting and driving

## Bulk charge time estimation

Consumer batteries charging (ignition key **OFF**, position **0** or position **I**) :

- State of charge from **50% to 80%**:  
Around **45 minutes**.\*
- State of charge from **60% to 80%**:  
Around **30 minutes**.\*
- State of charge from **70% to 80%**:  
Around **15 minutes**.\*

Consumer batteries and starter batteries charging (ignition key on position **II**), at this position **+DR** power line is activated causing a higher consumption (*lower current charging the batteries*):

- Starter and Consumer Batteries with state of charge from **50% to 80%**: Around **6 hours**.\*
- Starter and Consumer Batteries with state of charge from **60% to 80%**: Around **4 hours**.\*
- Starter and Consumer Batteries with state of charge from **70% to 80%**: Around **2 hours**.\*

\* Considering SOH (State Of Health) **100%** and **25 °C**.

The values were estimated and may vary according to specific conditions.

To refer about ignition key positions, see the following section in this manual: “Ignition switch”, page 46.

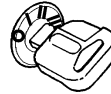
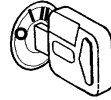
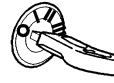

W3001302

Ignition key positions.

## Safe driving

Attend and follow this advises to obtain a safe driving all the trip:

- 1 After starting, and regularly while driving, check that the instruments are giving their normal readings. If any warning lamp lights while driving, stop the bus and investigate the cause.
- 2 Never race a cold engine! Also avoid idling speed for long periods.
- 3 Never cover the radiator! The thermostat keeps the temperature constant regardless of ambient conditions. Check the coolant level regularly and use always the correct type of coolant. Check the hoses, pipes and tensioning of the belts. Do not drive with a cooling or heating system leakages.
- 4 Never drive off before the brake system warning lamps have extinguished in the dashboard.
- 5 Do not forget to release the parking brake.
- 6 The **ABS/EBS** indicator lamps may be light along the trip or stay lit after starting the engine, if this happens; the bus can be driven since the lights only indicate that the **ABS/EBS** auto diagnostic system detected a malfunctioning.
- 7 If one of the front wheels is blocked sideways, never try to force it to turn by applying excessive force to the steering wheel, because you can damage the servo-mechanism hydraulic pump.
- 8 While driving downhill and for gradual braking use the retarder (for more information see the following section in this manual: “Retarder (if installed)”, page 120). Take special care when driving in slippery conditions as there may be a risk of block the drive wheels using the retarder or disable the retarder altogether in this conditions to prevent the risk of wheels block and avoid skidding.
- 9 When driving on slippery surfaces, for example; in snow or heavy rain, reduce speed and avoid rapid steering wheel movements. Brake and accelerate gently, to make the journey as safe as possible for passengers. Driving in slippery conditions requires extra caution when there are strong side winds. Side winds can produce a lifting force acting on the front axle losing total directional control.

### Economy driving

As the driver, you are the most important link in the chain for getting the best overall driving economy.

Follow these tips to get an acceptable economy driving:

- 1 **Warm up the engine as quickly as possible.** A warm engine (normal operation temperature) consumes less fuel than a cold one and there is less wear, extending the engine life time.
- 2 **Treat the throttle pedal gently.** Don't "pump" the throttle pedal. The pump action increases fuel consumption without increasing the speed. The information provided by the turbo boost pressure indicator will help to drive economically.
- 3 **High speeds increase fuel consumption.** Since, air resistance increases sharply when increases the speed. Front and side strong winds increase fuel consumption even more.
- 4 **Timely and correct servicing.** Timely and correct servicing will keep the bus in good condition, this will also contribute to preserving low fuel consumption.

## Driving in cold weather

Before driving in cold weather conditions with ambient temperature of **41 °F (5 °C)** or below, pay attention to the following points:

- 1 The cooling system must be protected against freezing.
- 2 The washer fluid reservoir must be filled with winter liquid.
- 3 Batteries must be in good conditions. In low temperatures, the batteries capacity to deliver current drops, i. e. when starting the engine. Make sure that the poles of the batteries are thoroughly clean, with the cable terminals properly tightened and covered with grease, and that there is the correct amount of electrolyte in every cell.
- 4 Engine oil, as well as transmission and rear axle oil, must have the correct viscosity.
- 5 Fill up the tanks with winter fuel. This reduces the risk of wax settling in the fuel system. If this has already happened, change the fuel filters and fill up the tanks with winter fuel. Keep the tanks as full as possible.
- 6 The compressed air system is particularly sensitive to low temperatures. Excessive condensation in the primary tank indicates that the air drier is not working properly. Drain the tank and change the desiccator cartridge in the air drier. If none of these measures help, use an external heating source to defrost the system.

## QR code labels

There are some QR code labels distributed inside the bus. The QR code labels provide the passenger's and the driver a basic information about the bus.

To access this information, must have a smart phone with the QR code labels reader application.

The QR code labels in the bus are the following:

- 1 For driver is located on left windshield pillar and cabin door (WCL) frame right structure pillar.

Link:

<https://www.prevostcar.com/QRPassPrevost>

- 2 For passengers are located in the side windows pillars.

Link:

<https://www.prevostcar.com/QRDrivV2014>

**Note:** QR codes can be read by mobile devices.

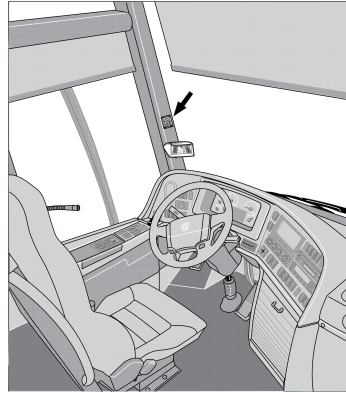

W0091714

QR code label for driver.

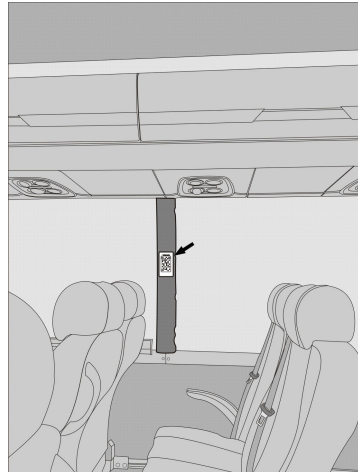

W0095902

QR code labels for passengers.



## Assistance and rescue on highway

### (VAS, Volvo Action Service)

In all Volvo buses, is stuck a label on the right bottom corner of the window of the driver seat. On this label will find the contact telephone numbers to request at any time **(24 hrs, 365 days a year)** the assistance and rescue on highway service provided by Volvo and its dealers network (service available in Mexico and in the United States).

**Note:** Before request the assistance and rescue on highway service should be ready with the following information: Complete Vehicle Identification Number (**VIN**).

For more information, see the following section on this manual: “Bus identification plate”, page 206), the vehicle location (the most precise as possible) and a clear brief description to the problem.



W0086993

Label with the contact details to request the assistance and rescue on highway service **VAS** in Mexico and in the United States.

# 144 If something happens

---

## Safety

**Note:** Always make passenger safety your first priority!

If something unexpected happens you should always proceed as follows:

- 1 Stop the bus in a place which is safe for the passengers, and where the bus itself does not constitute an obstacle for other road users and switch on the hazard warning lights.  
For more information, see the following section on this manual: “Hazard warning lights”, page 30.
- 2 Activate the emergency stop switch.  
For more information, see the following section on this manual: “Emergency stop switch”, page 31.
- 3 Set the ignition key switch in **0** position (to refer the ignition switch positions see the following section in this manual: “Ignition switch”, page 46).
- 4 Open the service door(s). If necessary, use the emergency valve located at the top of each door.
- 5 Let the passengers out.
- 6 Place a warning triangle behind the bus. Remember that the distance between the warning triangle and the vehicle depends on local regulations.
- 7 Immediately call an authorized Volvo service center, describe the problem and request the assistance and rescue on highway service.  
For more information, see the following section on this manual: “Assistance and rescue on highway”, page 143.

## If the engine is not working

If the engine does not start, check the following:

- 1 The emergency switch its not activated (The cover of the emergency switch is down).  
For more information, see the following section on this manual: “Emergency stop switch”, page 31.
- 2 The ignition switch is in **III** position.  
For more information, see the following section on this manual: “Ignition switch”, page 46.
- 3 The gear selector is in neutral position (**N**).  
For more information, see separate operating instructions: “I-Shift”.
- 4 The parking brake is engaged (see the following section in this manual: “Parking brake”, page 62).
- 5 The switch in the engine compartment is in (**1**) position, (see the following section on this manual: “Engine control panel in engine bay”, page 98).
- 6 Appropriate battery voltage in the starter batteries (*right hand side batteries compartment*), the engine cannot be started when the battery voltage is too low (below **18 V**).  
For more information about appropriate voltage in the electrical charge system, see separate operating instructions: “I-Start”.
- 7 The engine cannot be started if either the engine hatch or the front service hatch is opened. In that case the display will show

an appropriate symbol. Close the hatch before trying to start the engine.



T3018116

Symbol as shown in the driver information display related to currently open hatches in the bus.

For more information about the symbols shown in the driver information display, see separate operating instructions: “Display”.

**Note:** This vehicle is equipped with a battery discharge prevention system. If, with the parking brake applied, the battery voltage drops below **23.5 V**, the ARMS (*Automatic Reset Main Switch*) system acts and cuts the power of the chassis loads (to refer for ARMS function, see the following section in this manual: “ARMS (Automatic Reset Main Switch)”, page 135).

When ARMS (*Automatic Reset Main Switch*) is acting, for re-start the bus, you must turn **OFF** and turn **ON** the ignition key switch or turn **OFF** and turn **ON** the batteries cut-out switch in the vehicle.

To refer about key positions, see the following section in this manual: “Ignition switch”, page 46.

## 146 If something happens

---

### If the engine is not working (continue)

**Note:** When ARMS (*Automatic Reset Main Switch*) is acting for doing the rest it is needed to turn **OFF** and turn **ON** the ignition switch.

If these reviews don't get starting the engine, immediately contact an authorized Volvo service center to request the assistance and rescue on highway service.

For more information, see the following section on this manual: “Assistance and rescue on highway”, page 143.

## Punctures

There are several safety requirements that need to be considered in the event of a punctured tire.

For detailed information concerning wheel changing, see separate operating instructions: “Wheel replacement and towing”.

## Punctured air bellows

If any of the vehicle’s air bellows are punctured, further driving should be avoided. The preferred alternative is to replace the bellow at the current location or the vehicle should be towed to the nearest Volvo work shop.

Only if other options are judged not feasible, the vehicle shall be driven. In such case, the speed must be reduced to maximum **12 mph (20 km/h)** and during approximate **0,5 hour (30 minutes)** in order to avoid consequential faults or park the bus in a safe place out of the way and stop the engine and immediately contact an authorized nearest Volvo service center to request the assistance and rescue on highway service (see the following section on this manual: “Assistance and rescue on highway”, page 143).

For information about changing air bellows, see separate operating instructions: “Replacing wheels and bellows”.

# 148 If something happens

## Towing

The bus has for attaching a front and a rear drag points, see the accompanying illustration for the general location. For all long distance towing, assure that the tow vehicle has the necessary equipment to reach the front axle, per bus specifications, to refer see the following section on this manual: “Technical data”, page 196.

Towing or moving the bus for short distances can also be performed using a towing rod or bar, refer to the accompanying illustrations for attaching points location.

It may be necessary for the tow vehicle to attach an air supply to the bus during towing. To perform the towing its necessary use a bar of drag to tow and deploy it to the corresponding drag point (either to the front or back), release mechanically the parking brake and mechanically disconnect the transmission (either by removing the axle shaft or the main drive shafts to the drive wheels).

Towing requires either the drive shaft or both drive shafts to be removed, because otherwise the transmission may be damaged due to insufficient lubrication.

For more information about the transmission care in the towing process (for buses equipment with the Volvo I-Shift transmission), see separate operating instructions: “I-Shift”.

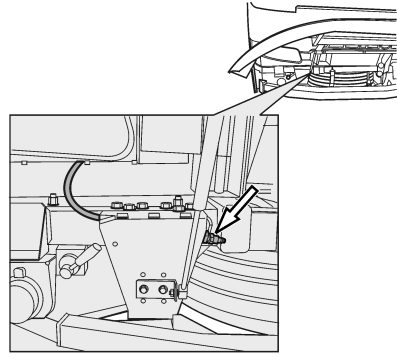

W1000252

Front air supply connection location.

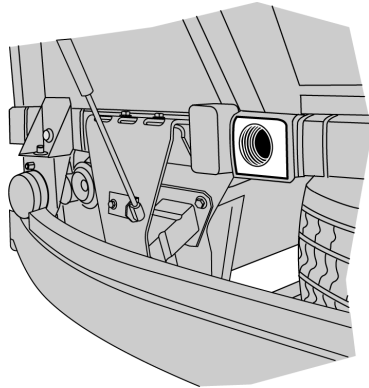

T8012390

Place for towing bar attachment (front).

## Towing (continue)

During the preparations for the bus towing, pay attention and take care at all the time the mechanically parking brake release of the bus, because after that the bus may be not be stopped (with the service brake or parking brake). First block the drive wheels, or connect a drag bar in another vehicle, so that the bus will not be able to start moving after you have released the parking brake. After mechanically releasing the parking brake, the bus cannot be braked either with the main brake or with the parking brake. Block the wheels or connect to the tow vehicle, so that the bus cannot start moving after the parking brake has been released.

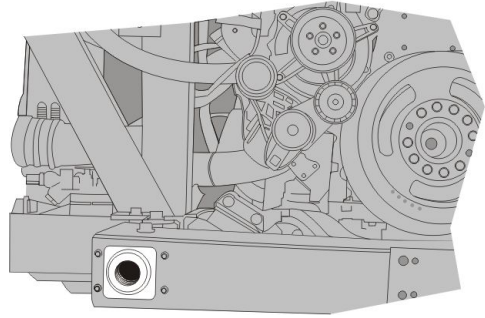

T8059309

Place for towing bar attachment (rear).

**Note:** TCS should be turned off if one of the axles is raised during towing and for, punctures, the tire must be repaired before towing begins.



### CAUTION

Failure to disconnect the drive shaft, remove the drive axle shaft(s) or lift the drive wheels off the ground before towing or pushing the vehicle, can cause serious transmission damage and void the transmission warranty.

## 150 If something happens

---

### Bus towing considerations

When you perform the bus towing, also consider the following indications:

- The hydraulic steering will not work during the vehicle towing due to the engine is not operating, so will be very difficult to steer the vehicle.
- A punctured or flat tire must be repaired before the vehicle towing.
- The connections for the drag bar are only to be used in the bus towing. Should not be used for other purpose.
- Bus conditioned with a low mounted coupling for trailer reduces the ground clearance. Make contact with the ground can cause damage to the bus!
- The TCS (traction control System) needs to be disabled if an axle is lifted during vehicle towing.



#### **CAUTION**

The towing requires that the axle shaft or both drive wheels main shafts are removed, otherwise the gearbox may be damaged due to insufficient lubrication.



## Alternative towing procedure

**Note:** This procedure apply only for buses equipped with I-Shift AMT-D (Automatized Manual Transmission) and have the management software that include the alternative towing function.

If can not follow the bus standard towing procedure due to road conditions or any other circumstances, the I-Shift transmission provides an alternative function to bus towing which will allow it to tow the bus without axle drive shafts or drive wheels main shafts removals regardless of the distance that the vehicle needs to travel during the towing. For the alternative towing procedure can take place, you must engage the **3 HR** speed in the transmission; for this it to be possible you must meet certain conditions, follow the alternative towing procedure described at the next page.



### CAUTION

**Do not replace the towing standard procedure, this procedure does not have any indicator, if any of the steps below are not fulfilled a transmission damage may be occur.**

## 152 If something happens

---

### Alternative towing procedure (continue)

Bus alternative towing procedure:

- The gear selector lever or the gear selector pad must be in neutral (N) position. For more information, see separate operating instructions: “I-Shift”.
- Engine is not running.
- There must be enough air pressure to the gearbox servo mechanism (minimum **4 bar / 58 psi**).
- The vehicle must have enough electrical power in the batteries.
- The ignition key must be in “ON” position.
- Vehicle must be towed forward.



#### CAUTION

Reverse towing is not allowed when such towing alternative procedure applied.  
Reverse towing can damage the gearbox.

## Additional fire detection system (multiplexed)

The Volvo 9700 US/CAN bus is equipped with a fire detection multiplexed system in the engine bay. This system is multiplexed to the bus electrical architecture “BEA3”. When the presence of fire in the engine bay is detected, the warning lamp “STOP” in the dashboard will turn on at the same time will emitted an audible signal and a symbol appears in the driver display in the dashboard.

Park the bus off the road in a safe place, stop the engine and immediately contact to the assistance and rescue on highway service to the phone provided in the stick placed at the bottom right corner on the driver window (for more information, see the following section on this manual: “Assistance and rescue on highway”, page 143).

Also, for more information about additional Automatic Fire Suppression System (AFSS), see the following section in this manual: “Automatic Fire Suppression System (AFSS)”, page 89.



T0012298



### **DANGER**

When this warning is presented, park the bus off the road in a safe place and shut down the engine immediately! Failure to do so may be keep the radiator fan running which impels air into the engine bay and fans the fire. Failure to do so may be result in serious personal injury or death.

## 154 If something happens

### Releasing the parking brake

#### Release the parking brake with air from the bus tires

Only in an emergency case, you can use the bus tire or wheel air pressure to release the parking brake in case of being left without air pressure in the pneumatic system circuit.

To perform this, do the following:

- 1 Block the drive wheels or grip a drag bar to another vehicle in order to prevent the bus movement when the parking brake is released.
- 2 Connect the clamp head of the tire inflation hose to the valve of one of the wheels.
- 3 Move the parking brake control to the drive position (parking brake release, for more information see the following section on this manual: "Parking brake", page 62).
- 4 While pressing the other end of the tire inflation hose against the pump nipple, press in the blocking valve. Now the brake system is filled with the air from the wheel. Filling can be interrupted as soon as the air flow stops.

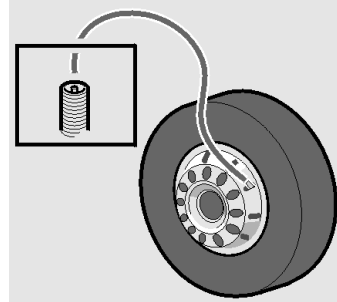

T0009182



#### **DANGER**

Block the drive wheels to prevent the bus from moving when releasing the parking brake. Failure to do so may result in serious personal injury or death.

## Parking brake mechanical releasing

To perform the bus towing procedure if there's no enough air pressure to release the parking brakes, these can be released mechanically.

To do this, proceed as follows:

- 1 Block the drive wheels or clamp a towing bar to another vehicle in order to prevent the vehicle to move when of releasing the parking brake.
- 2 In both drive shaft brake cylinders there are release bolts. Screw until you see out a red plastic button in the center of the screw, this the same in the other side, then the parking brakes are released. The full compression of the parking brake spring requires approximately **45 turns**, use the wrench, the socket and the fastener shank found in the tool box. Whenever possible try to fill with air the parking brake cylinders, this makes easier to turn the nuts of the release mechanism.
- 3 The bus can be towed when the parking brakes are fully released. Remember to make the bus towing must be done using the drag bar.

For more information about two available bus towing procedures, see the following sections on this manual: "Towing", page 148 or "Alternative towing procedure", page 151.

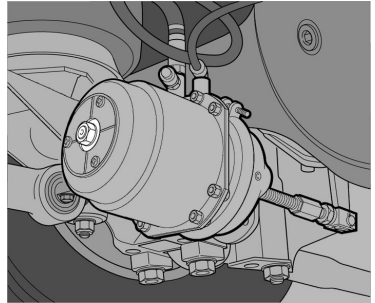

T5014634

**Note:** Do not forget to reset the bolts to their original position and attach the plastic cover after towing has been completed.



### DANGER

Block the drive wheels to prevent the bus from moving when releasing the parking brake. Failure to do so may be result in serious personal injury or death.

# 156 If something happens

## Parking brake on disc brakes mechanical releasing

The Volvo 9700 US/CAN bus is equipped in all axles with disc brakes, which in the drive axle can be mechanically released if there's no enough air pressure to release the parking brakes.

To do this, proceed as follows:

- 1 Block the drive wheels or clamp a towing bar to another vehicle in order to prevent the vehicle movement when releasing the parking brake.
- 2 In the disk brakes set for the drive wheels, both brake cylinders are equipped with a release screw, screw until you see out a red plastic button in the center of the screw, do this in the other brake cylinder side, then the parking brakes are released. The full compression of the parking brake spring requires approximately **45 turns**, use the wrench, the socket and the fastener shank found in the tool box. Whenever possible try to fill with air the parking brake cylinders, this makes easier to turn the nuts of the release mechanism.
- 3 The bus can be towed when the parking brakes are fully released. Remember to make the bus towing must be done using the drag bar.

For more information about two available bus towing procedures, see the following sections on this manual: "Towing", page 148 or "Alternative towing procedure", page 151.

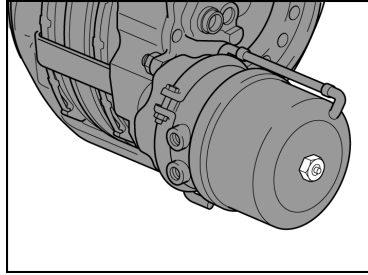

T5014635

**Note:** Do not forget to reset the bolts to their original position and attach the plastic cover after towing has been completed.



### DANGER

Block the drive wheels to prevent the bus from moving when releasing the parking brake. Failure to do so may be result in serious personal injury or death.

## Change the batteries

When changing the batteries, both batteries should have the same capacity and be of the same age. When connecting batteries correct polarity must be observed (to refer about correct batteries polarity, see the following section in this manual: “Starting assistance”, page 159).

To change a battery, proceed as follows:

- 1 Turn **OFF** the power supply with the ignition switch located in the left side of the steering wheel column (see the following section on this manual: “Ignition switch”, page 46).
- 2 Open the batteries compartment hatch (*Right or left hand side*)

**Note:** Use the proper key to open, see the following section in this manual: “Keys”, page 2.

- 3 Turn **OFF** the total power supply through by the batteries *cut-off switch* (“General switch”).  
As a reference, see the following section in this manual: “Batteries cut-off switch”, page 163.
- 4 Disconnect the cable terminal from the battery negative pole.
- 5 Disconnect the cable terminal from the battery positive pole.
- 6 Change the battery or batteries.
- 7 Clean the cable terminals and both poles of the battery or batteries.

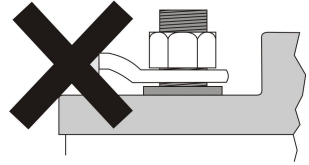
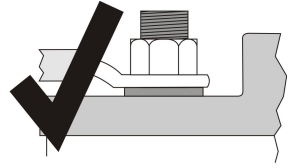

W0111158

Upper: Mounted properly, the terminal firmly tightens to the battery post.

Lower: Improperly mounted, the terminal doesn't tighten to the battery post.

## 158 If something happens

---

### Change the batteries (continue)

8 — Connect the positive cable terminal to the battery pole (tighten firmly).

9 — Connect the negative cable terminal to the battery pole (tighten firmly).

10 — Apply an anti-corrosive agent to the poles with terminals.

11 — Turn **ON** the batteries power supply through by the batteries *cut-off switch* (“General switch”).

As a reference, see the following section in this manual: “Batteries cut-off switch”, page 163.

12 — Turn **ON** the power supply with the ignition switch (to refer the ignition switch positions, see the following section on this manual: “Ignition switch”, page 46).

13 — Close the batteries compartment hatches (*Right or left hand side*).

For more information about care and bus batteries handle, see separate operating instructions: “I-Start” .

**Note:** When you connect the cable terminals to the battery posts, should be tightened firmly, in order to avoid a false contact and cause cables overheating.



### CAUTION

Incorrect batteries polarity connection will seriously damage the electrical system.



### WARNING

If a cable clamp has been incorrectly installed (seated), the battery terminal must be reamed to give a sufficiently large mating surface when correctly installed (seated). Incorrect installation entails a high risk of oxidation in the space between the top of the battery terminal and the battery cable clamp.



## Starting assistance

In the event that the batteries are unable to start the engine, auxiliary batteries can be used to help in starting. These batteries are connected in parallel with the ordinary bus batteries.

For more information about the auxiliary batteries connection to the electrical system bus, see separate operating instructions: “I-Start”.

For connect the batteries in case of starting assistance, proceed as follows:

**Note:** The batteries polarity is indicated by decals on both batteries compartments.

Note the polarity plus to plus and minus to minus. It is important to handle the battery in a suitable environment, contact a Volvo dealer when discarding or storing batteries.

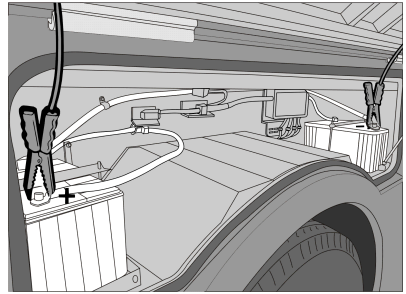

W0101443

Jump start.

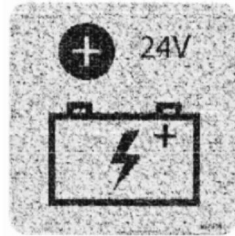

W011075

Positive pole polarity decal.

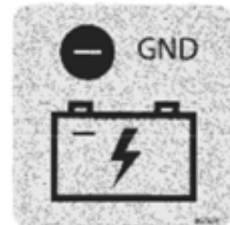

W011076

Ground pole polarity decal.

## Jump start batteries procedure

For jump start batteries, proceed as follows:

- 1 Place the ignition switch in **0** position.
- 2 Make sure the auxiliary batteries have **24 V** total voltage or **24 V** voltage on the system.
- 3 Turn **OFF** the engine on the “assistance vehicle” and make sure the vehicle do not touch each other.
- 4 Open the right hand side batteries compartment hatch.
- 5 Connect one of the red cable clamps to the positive terminal of the auxiliary battery. The positive terminal is marked in red, **P** or +.
- 6 Connect the other red cable clamp to the positive terminal in the bus battery. The positive terminal is marked in red, **P** or +.
- 7 Connect one of the black cable clamps to the negative terminal of the auxiliary battery marked in blue, **N** or -.
- 8 Connect the other black cable clamp to a ground stud for jump start placed inside to the right hand side batteries compartment.
- 9 Run the engine of the “assisting vehicle”. Let the engine run for about **1 minute**, at approximately **1000 rpm**.
- 10 Start the engine of the other vehicle.
- 11 Remove the clamp on the black cable from the ground terminal.
- 12 Remove the clamp on the black cable from the negative terminal on the auxiliary battery.
- 13 Remove the red cable.
- 14 Close the right hand side batteries compartment hatch.

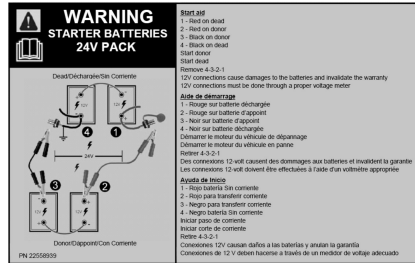

W0111077

Batteries jump start instructions decal.

**Note:** To refer about the ground stud for batteries jump start, see the following section in this manual: “Ground stud for jump start batteries”, page 162.

For batteries polarity identification, see the polarity decals placed into the batteries compartments.

In the backside of the right hand side batteries compartment hatch there is a decal with instructions for jump start in three languages.

## Jump start batteries procedure warnings



### CAUTION

Make sure the cable clamps are firmly fixed to the battery poles to avoid risk of sparks and resulting explosion.



### CAUTION

Battery chargers with a start boost feature must not be used for starting assistance. Failure to do so may cause damage to the electrical system.



### CAUTION

Do not touch the auxiliary batteries cables or the terminals while starting the engine (risk of sparkles).  
Do not lean over the batteries.



### WARNING

Do not connect auxiliary battery rechargers to start the vehicle, since they operate at high voltage and can damage the electronic control units (ECU's).

Always use another vehicle or other batteries to assist in jump-starting the engine.



### DANGER

Batteries contain sulfuric acid (which is corrosive and toxic) that can cause severe burning. If the acid contacts eyes, skin or clothes, flush with abundant water. If the acid spills on the eyes, visit a doctor immediately. Do not lean on or stand on the batteries.

## 162 If something happens

### Ground stud for jump start batteries

Inside of the right hand side batteries compartment, a stud for batteries jump start was placed at the right on the top of the batteries compartment frame. One ground indication decal is placed next to the stud.

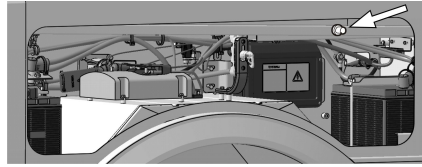

W0111078

Ground stud for batteries jump start location in the right hand side batteries compartment.

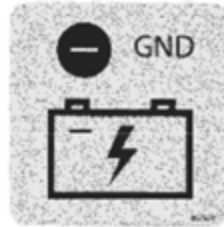

W0111076

Ground stud indication decal.

## Batteries cut-off switch

Also called “General switch”, is located into the right side batteries compartment and is there to completely cut off the bus power supply. To prevent battery discharge when the bus is standing for **24 hours** or more, turn **OFF** the battery cut-off switch to the **0** or **OFF** position.

For more information about to the batteries power supply and the general switch function, see separate operating instructions: “I-Start”.

**Note:** After using the battery cut-off switch and to avoid the vehicle’s equipment may loose memory functions. For example: the radio code or trigger fault codes recordings due a lack of power to the control units. The **B+** power supply is taken directly from the I-Start consumer batteries and is not disconnected by the batteries cut-off switch. This was intended especially to keep clock and radio memory when is necessary to turn **OFF** the batteries cut-off switch.

To refer the I-Start system in this manual, see the following section: “I-Start system”, page 131.

For more information related to the I-Start system, see separate operating instructions: “I-Start”.

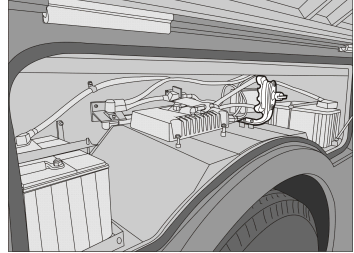

W0100418

Batteries cut-off switch location.(right side batteries compartment).

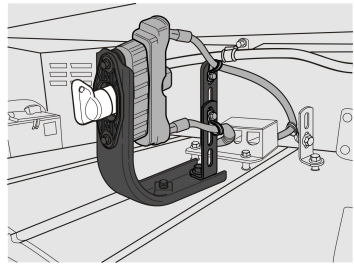

W0108406

Batteries cut-off switch knob.

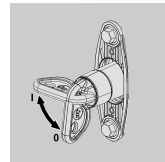

T0076655

Battery cut-off switch positions:  
Position I: Connected.  
Position 0: Disconnected.



### CAUTION

Always switch **OFF** the power with the cut-off switch when charging the batteries and when connecting an auxiliary batteries to start the engine.

**Before** using the battery cut-off switch, the power must always be switched **OFF** using the ignition key at the right side of the wheel steering column in position **0** (to refer the ignition key positions, see the following section in this manual: “Ignition switch”, page 46).

Failure to do so may cause damage to the electrical system.

## 164 If something happens

---

### *Operation of the SCR (Selective Catalyst Reduction) system*

When the engine is **OFF**, the SCR injection system continues working to clear Diesel Emission Fluid (DEF) from the injector and supply tubes. This process takes approximately **90 seconds**.



#### **CAUTION**

Wait at least **5 minutes** after shutting **OFF** the engine to turn **OFF** the main switch (by ignition key in position **0**) so that the cleaning process can be completed. Otherwise, the Diesel Emission Fluid (DEF) in the SCR system can freeze at low temperatures.

For more information, see separate operating instructions: “Exhaust Aftertreatment System (EATS)”.

## Bulb replacement

### Headlamps

#### Headlamp bulb replacement

For headlamp bulb replacement (right or left side), must do the following:

- 1 Lift the front bumper.
- 2 Loosen the securing screws (A) and (B), delicately lower the lamp module and tilt it open.
- 3 Disconnect power supply cables.
- 4 Remove the bulb(s).
- 5 Replace the bulb(s) as required.
- 6 Check the proper operation of the lights.
- 7 Install the lamp module.
- 8 Close the front bumper.

**Note:** Replace it with a new bulb of **24 V**, the same type and power rating (see the bulb part number in the following section in this manual: “Bulbs for lighting lamps”, page 198).

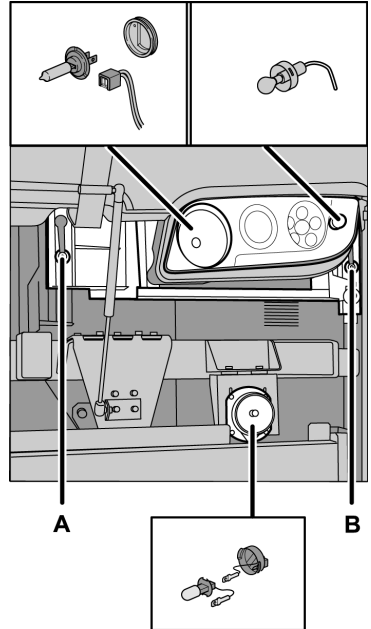

## Xenon lights

### DANGER

Xenon lights should only be serviced at an authorized service facility.

Never try to repair the lights on your own. Ignition voltage in xenon bulbs is **28,000 V**. Servicing these lights without the necessary knowledge and service information may result in serious personal injury or death.

## Rear lights

### Tail lamp replacement

For tail lamp replacement (right or left side), must do the following:

- 1 Unscrew the five cover fixing screws in the tail lamp.
- 2 Replace the lamps(s) as required.
- 3 Check the proper operation of the tail lamps.
- 4 Assemble the tail lamp set.

**Note:** Make sure that the lamp is replaced with a new lamp of **24 V**, the same type and power rating (see the lamp part number in the following section on this manual: “Bulbs for lighting lamps”, page 198).

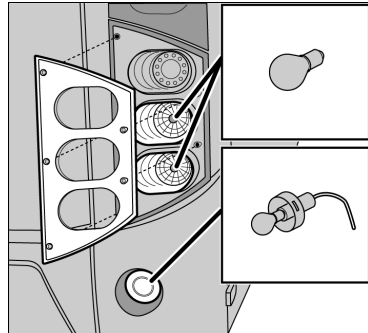

T3019941



## License plate lighting

### License plate lighting lamp replacement

Replace the license plate lamp as follows:

- 1 Unscrew the cover fixing screws of the lamp.
- 2 Replace the lamps(s) as required.
- 3 Check for proper operation.
- 4 Assembly the lamp set.

**Note:** Make sure that the lamp is replaced with a new lamp of **24 V**, the same type and power rating (see the lamp part number in the following section on this manual: “Bulbs for lighting lamps”, page 198).

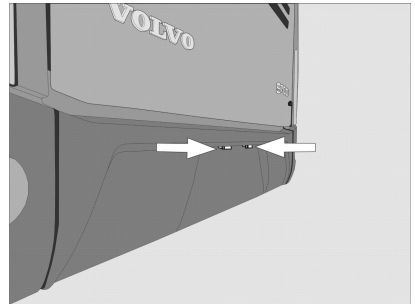

W0089795

## 168 If something happens

---

### Electrical fault general lookup

The first step to take when troubleshooting the electrical system is to check the fuses in the bus electrical center and check the messages displayed by the On-Board Diagnostic (OBD) system.

A burnt-out fuse can be seen with the eye. In this case, remove the fuse from the fuse holder and replace it. If the same fuse burns repeatedly, the bus should be contact to a Prevost or Volvo authorized dealer to have the electrical system repaired.



#### **WARNING**

Never replace fuses with higher capacity fuses or with metal elements like wires, coins, etc.

## Bus electrical center

The Volvo 9700 US/CAN bus is equipped with an electrical center where install the protect fuses and relays to the chassis and body electric circuits.

This electrical center is located at the front right of the bus, next to the entrance stairs and under to the partition wall.

**Note:** At the back side of the electrical center hatch, is stuck a label which has the description of each relay and fuse installed in the power load center to the chassis electrical circuits.

Similarly, for the fuse and relay box corresponding to the body electrical circuits, is stuck a label at the box lid back side which indicates the description of each fuse and relay installed inside the box.

Also the description for each symbol must be checked in this manual.

The label for the chassis electrical circuits on the electrical distribution unit only uses symbols for identification.



W0089803



### WARNING

The relays in the electrical distribution unit that have this symbol next to them are mandatory for vehicle operation. Do not use the relays to replace other faulty relays.

# 170 If something happens

## Chassis electric circuit relays

This electrical distribution unit is located in the bus electrical center.

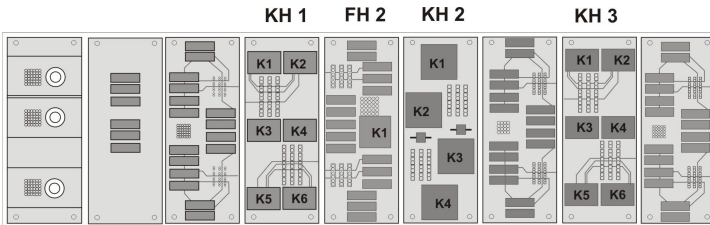

W0110753

### Relays “KH1 section”







K1	SPARE	Spare.	K2		Over load indicator.
K3		ECS (Electronic Control Suspension).	K4		Transmission “I-Shift” .
K5	SPARE	Spare.	K6	SPARE	Spare.

### Relays “KH2 section”

K1		Start engine.	K2 <sup>1</sup>		VECU (Vehicle Electronic Control Unit). EMS (Engine Management System).
K3 <sup>1</sup>		Wiper motor. Washer.	K4	SPARE	Spare.

<sup>1</sup> Depends on version.

## Chassis electric circuit relays (continue)







Relays “KH3 section”					
K1		Prevent start engine.	K2		Luggage compartment lighting.
K3		Emergency switch relay.	K4		Bogie.
K5 <sup>1</sup>		Spare. Retarder control.	K6 <sup>1</sup>		Spare. RECU (Retarder Electronic Control Unit).

1 Depends on version.

Relays “FH2 section”		
K1		Ignition “+ 15”.

# 172 If something happens

## Other chassis electric circuit relays

Relays chassis					
K35 <sup>1</sup>		Relay disconnect headlight wash.	K48 <sup>2</sup>		Relay engine preheating.
K53 <sup>3</sup>		Relay starter key .	K300 <sup>3</sup>		I-Start main relay.
K400 <sup>4</sup>	BODY +30	I-Start +30 Relay (Body builder).	K911 <sup>5</sup>		Relay DRL front lights.
K918 <sup>3</sup>		Relay for Allison gear selector ECU, I-Shift TECU, Aftertreatment NOX sensors, Relay 12 V EMS2 (Engine Management System, version 2), Solenoid valve AVU, engine breake / EPG.	K919 <sup>3</sup>		Allison Gear selector ECU, Allison control module, power supply relay. Relay 12 V IVS.

1 Depends on version.

2 Located inside of the under floor rear compartment at the back side of the passengers compartment.

3 Located inside of the right hand side batteries box.

4 Located inside of the left hand side batteries box.

5 Located inside in the electric center.

## Chassis electric circuit fuses

This electrical distribution unit is located in the bus electrical center.

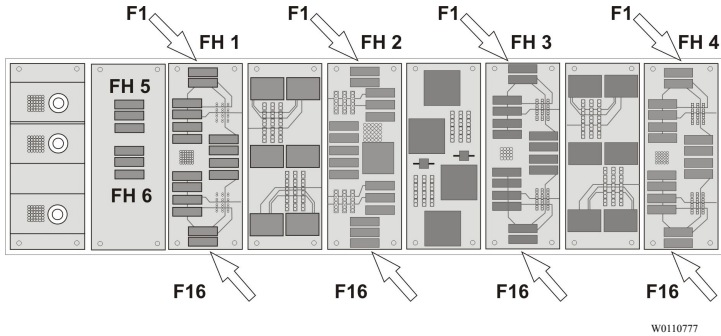











W0110777

Fuses “FH1 section”						
F1	5A		Electronic Control Suspension (ECS).	F2	10A	Instrument Cluster (IC08).
F3	—	SPARE	Spare.	F4 <sup>1</sup>	20A	Electronic Brake System (EBS). Anti lock Brake System (ABS).
F5	5A		Horn.	F6	—	SPARE Spare.
F7 <sup>1</sup>	10A		Gear Electronic Control Unit (GECU) I-Shift.	F8	5A	Gear selector pad or lever (I-Shift transmission). <sup>1</sup>
F9	5A		Engine bay control panel to “start / stop”.	F10	5A	Fire alarm.
F11	10A	FMS	Dynafleet. Fleet Management System (FMS).	F12	5A	BODY +30 Body + 30.
F13	10A	SPARE	Spare.	F14	5A	BBM Body Builder Module (BBM).
F15	15A		Engine Electronic Control Module (EECU).	F16	5A	VECU Vehicle Electronic Control Unit (VECU).

<sup>1</sup> Depends on version.

## 174 If something happens













### Chassis electric circuit fuses (continue)

Fuses "FH2 section"							
F1	5A		Switch feed.	F2	5A		Alternator.
F3	10A	HYMER	Hymer.	F4 <sup>1</sup>	10A		Electronic Brake System (EBS). Anti lock Brake System (ABS).
F5	15A		Wipers and washer windscreen.	F6	—	SPARE	Spare.
F7 <sup>1</sup>	5A	FMS	Adaptive Cruise Control (ACC). Fleet Management System (FMS).	F8	5A		Instrument Cluster (IC08).
F9	15A		Washer motor.	F10	5A		Electronic Control Suspension (ECS).
F11	—	SPARE	Spare.	F12	10A		Retarder Electronic Control Unit (RECU).
F13	5A	BODY +DR	Body + DR (ignition key switch).	F14	—	SPARE	Spare.
F15 <sub>1</sub>	10A		Hydraulic oil. After treatment cleaner system control unit DNOx2.	F16	5A		Tacograph.

<sup>1</sup> Depends on version.















Chassis electric circuit fuses (continue)

Fuses "FH3 section"							
F1	5A		Cut out fuel valve.	F2	—	SPARE	Spare.
F3	5A		Radio.	F4	10A		Luggage compartment light.
F5 <sup>1</sup>	10A		Bogie control valve. Heater water separator.	F6 <sup>1</sup>	5A		Luggage compartment hatches. Engine compartment hatch.
F7 <sup>1</sup>	10A		Exhaust gases Pressure Governor (EPG). Pre heating relay. Fan speed.	F8	10A		Volvo Engine Brake (VEB).
F9	5A		Key switch.	F10	5A		Fuel Tank Monitor (FTM).
F11	—	SPARE	Spare.	F12	—	SPARE	Spare.
F13 <sup>1</sup>	10A		Light. Luggage room.	F14	20A		Light sleeping compartment.
F15 <sup>1</sup>	5A	SPARE	Spare.	F16	10A		Load indicator.

1 Depends on version.



# 176 If something happens

## Chassis electric circuit fuses (continue)

Fuses "FH4 section"							
F1	5A		Instrument Cluster (IC08).	F2	—	SPARE	Spare.
F3	25A		Lighting Control Module (LCM).	F4	25A		Lighting Control Module (LCM).
F5	25A		Lighting Control Module (LCM).	F6	—	SPARE	Spare.
F7 <sup>1</sup>	25A		After treatment cleaner system control unit DNOx2.	F8	5A		Voltage guard.
F9	20A		Radio.	F10 <sup>1</sup>	5A		Main switch (ignition key in position I).
F11	—	SPARE	Spare.	F12	25A		Lighting Control Module (LCM).
F13	25A		Lighting Control Module (LCM).	F14	25A		Lighting Control Module (LCM).
F15	5A		Left side marker lights.	F16	5A		Right side marker lights.

<sup>1</sup> Depends on version.

## Chassis electric circuit fuses (continue)

Fuses “FH5 section”							
F1	30A		Bus configuration depends.	F2	15A		Bus configuration depends.
F3 <sup>1</sup>	—	SPARE	Spare.				

<sup>1</sup> Depends on version.









Fuses “FH6 section”							
F1	30A		Bus configuration depends.	F2 <sup>1</sup>	—	SPARE	Spare.
F3 <sup>1</sup>	—	SPARE	Spare.				

<sup>1</sup> Depends on version.

# 178 If something happens

## Other chassis electric circuit fuses

Other chassis electric circuit fuses.

Fuses chassis							
F76 <sup>1</sup>	80A		12V Equalizer.	F77 <sup>1</sup>	40A		24V Equalizer,
F99 <sup>1</sup>	15A		Allison transmission control module +30 power supply.	F100 <sup>1</sup>	10A		ODB (On Board Diagnostic) connection to B+.
F206 <sup>2</sup>	5A		External pre-heater.	F907 <sup>3</sup>	20A		12V I-Shift.
F915 <sup>3</sup>	30A	EMS	12V EMS2 (Engine Management System).	F955 <sup>3</sup>	20A	EMS	12V EMS (Engine Management System) Act.
F956 <sup>3</sup>	10A		12V Fuel pump.	F957 <sup>3</sup>	20A		12V Cool fan.
F958 <sup>3</sup>	10A		12V Allison transmission, gear box and OBD diagnostic connector.				

1 Located inside of the right hand side batteries box.

2 Located inside of the rear fuse box installed in the engine compartment (VPDUR).

3 Located inside of the right hand side batteries box (on FH1 fuse board).

## Body electric circuit relays

This electrical distribution unit is located in the bus electrical center.

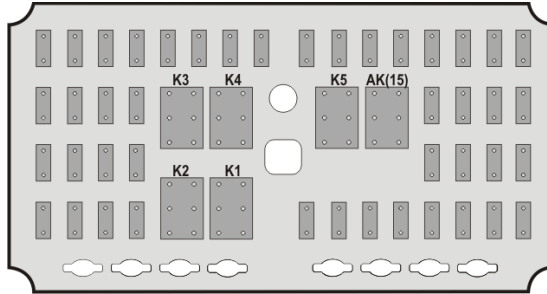

T8059319

Body relays					
AK (15)	BODY +15	Loads +15.	K3		Defroster speed 2.
K1		Over speed control 59 mph (95 km/h).	K4		Defroster speed 3.
K2		Defroster speed 1.	K5 <sup>1</sup>		Free relay.
					Night light.

1 Depends on version.

## Other body electric circuit relays

Other body relays					
K910 <sup>1</sup>		KIDDE protection panel (Automatic Fire Suppression System, AFSS).	K911 <sup>1</sup>		Audio & video on demand.
K912 <sup>1</sup>		Tire Pressure Monitoring System (TPMS) relay.			

1 Located inside in the electric center.

# 180 If something happens

## Body electric circuit fuses

This electrical distribution unit is located in the bus electrical center.

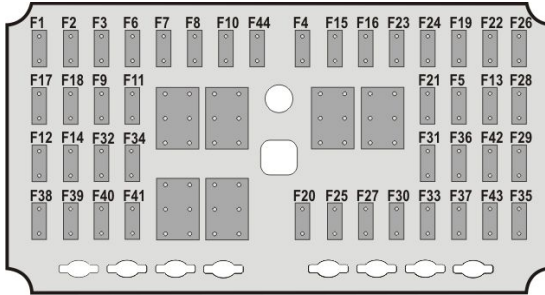

T8058916

Body fuses					
F1	20A	Feed +30 service kit.		7.5A	Left & middle toilet I/O B module.
F2 <sup>1</sup>	5A	Bosch entertainment system. DRL (Day Run Lights).	F13 <sup>1</sup>	15A	FSS (Fire Suppression System).
F3	20A	Audio & Video 12V.	F14	20A	Electric window.
F4	30A	Feed relay K5.	F15	30A	Wheel Chair Lift (WCL).
F5	30A	Floor I/O B module.	F16	30A	Roof left I/O B module.
F6	5A	Climate I/O A module.	F17	5A	Webasto timer 2.
F7	5A	Climate unit I/O A module.	F18	20A	Audio & Video 24 V.
F8 <sup>1</sup>	30A	Auxiliary heater. Front lights SEL.	F19	7.5A	Toilet I/O B module.
F9	5A	Red led switches.	F20 <sup>1</sup>	15A	Dashboard converter. Cigarette lighter output.
F10	20A	Defroster.	F21 <sup>1</sup>	5A	Copiloto. TD7. Wi — Fi.
F11	30A	Floor left 2 I/O B module.	F22	15A	+B feed MCM.
F12 <sup>1</sup>	7.5A	Innova control. MCM (Master Control Module) feed.	F23	5A	Light under seats.

<sup>1</sup> Depends on version.

## Body electric circuit fuses (continue)

Body fuses (body electric circuits, continue)					
F24	5A	Middle door I/O A module.	F35	10A	Park pilot system.
F25	5A	Webasto timer 3.	F36	5A	Time & temperature display.
F26	5A	Dashboard I/O A module.	F37	15A	TPMS (Tire Pressure Monitoring System).
F27	30A	24V CD Output in driver side.	F38	3A	Volvo link.
F28	5A	Pressure switch.	F39	7.5A	Roof hatch front.
F29 <sup>1</sup>	3A	Copiloto. Volvo link.	F40	7.5A	Roof hatch rear.
F30	5A	Control panel air.	F41	5A	Webasto timer 1.
F31	3A	Feed +15 TD7.	F42	15A	Electrical binder.
F32 <sup>1</sup>	5A	Innova (+15).	F43	5A	Defroster flap.
F33	15A	DRC Air conditioning.	F44	15A	Feed over speed relay.
F34	20A	Audio & Video (+15).			

1 Depends on version.

## Other body electric circuit fuses

Other body fuses		
F107 <sub>1</sub>	40A	I-Start B+ supply from body electrical center (distribution box).

1 Located inside in the electric center.

## 182 If something happens

### Fuse boxes inside to the batteries compartments

The Volvo 9700 US/CAN bus is equipped with 2 fuses and relays electrical boxes mounted inside to the batteries compartments. This fuses and relays boxes are follows:

- (A) Chassis fuses and relays box, including protect elements for the “I-Start” system (for more information, see separate operating instructions: “I-Start”).
- (B) Mini fuse box holder for body builder equipment electrical distribution.

The fuse and relay box lid corresponding to “I-Start” system has a label in one of its sides, which; description provide for each relay and fuse are install.

In the information shown below, its provide the fuse and relay description installed in both electrical boxes for a quickly references guide.

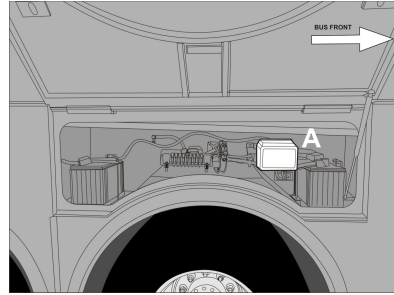

W0111079

(A) Chassis fuses and relays box inside to the right hand side batteries compartment.

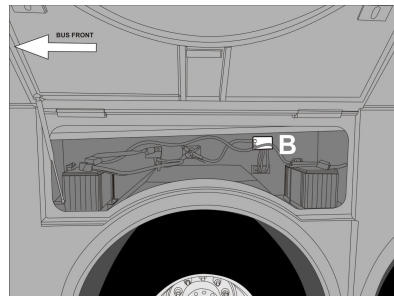

W0111080

(B) Mini fuse box holder inside to the left hand side batteries compartment.



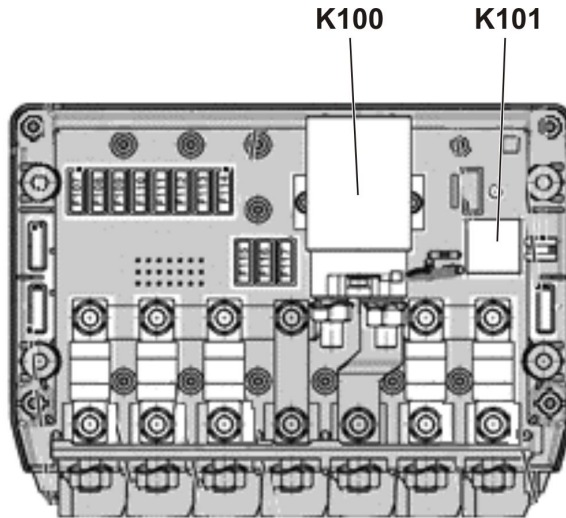

## Fuses and relays electrical box inside to the right hand side batteries compartment

Relays in the electrical distribution box corresponding to the I-Start system



W0108044

Relays in the electrical distribution box corresponding to the I-Start system					
K100		Main relay.	K101		Automatic Resetting Main Switch (ARMS).

# 184 If something happens

## Fuses in the electrical distribution box corresponding to the I-Start system

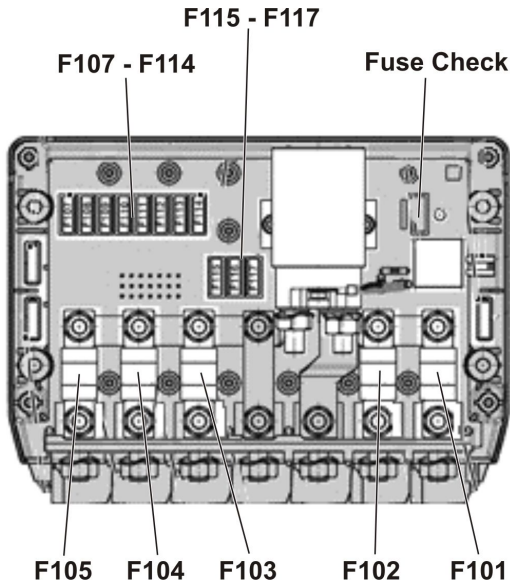





W0108045

Fuses in the electrical distribution box corresponding to the I-Start system							
F101	150 A	<b>B+</b>	Chassis B+.	F102 <sub>1</sub>	100 A	<b>B+</b>	Chassis B+.
F103	150 A	<b>+30</b>	Chassis +30.	F104	150 A	<b>G</b>	Alternator B+.
F105 <sup>1</sup>	200 A	<b>G</b>	Alternator B+.	F107	5 A	<b>G</b>	Alternator B+.

<sup>1</sup> Fuse unused.

**Fuses in the electrical distribution box corresponding to the I-Start system (continue)**

Fuses in the electrical distribution box corresponding to the I-Start system							
F108 <sup>1</sup>	10 A		Alternator B+.	F109	10 A		Alternator B+.
F110 <sup>1</sup>	10 A		Alternator B+.	F111 <sup>1</sup>	10 A		Alternator B+.
F112 <sup>1</sup>	20 A	<b>B+</b>	Chassis B+.	F113	10 A	<b>B+</b>	Chassis B+.
F114	5 A	<b>B+</b>	Chassis B+.	F115 <sup>1</sup>	15 A	<b>B+</b>	Chassis B+.
F116 <sup>1</sup>	20 A	<b>B+</b>	Chassis B+.	F117 <sup>1</sup>	20 A	<b>B+</b>	Chassis B+.

<sup>1</sup> Fuse unused.

# 186 If something happens

## Mini fuse box holder inside to the left hand side batteries compartment

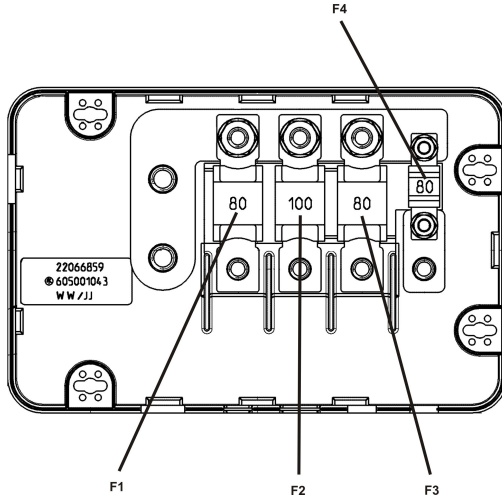

W0108046

### Mini fuse box holder

F1	80A	Body electric center +30.	F2	100A	Inverter.
F3	80A	AC unit.	F4 (mini)	60A	Wheel Chair Lift (WCL).

## Wheels replacement

All Volvo buses have a structural lift points (in both sides) for raise the bus and sustain it without a problem for change any punctured tire. These structural points are marked by a label stick on the bus in the exact location where the structural lift points are located on the bus. Only in this points, the hydraulic jack provided in the bus toolbox must be placed (see also the following section in this manual: “Hydraulic jack”, page 96).

For more information about cautions and wheel replacement procedure on the road, see separate operating instructions: “Wheels and air springs replacement”.



### CAUTION

Place the hydraulic jack in a different marked body structure points. So may be a considerably bus body structure damaging risk.

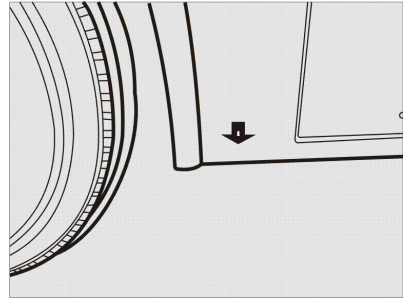

W0089967

Sticker to indicate the location of the bus structural lift points.

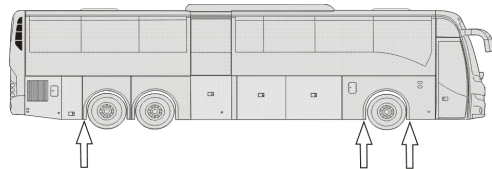

W0089962

Structural lift points localization (symmetrically on both sides, 6x2 configuration).

Valid in models with Wheel Chair Lift (WCL) or without WCL.

## 188 If something happens

---

### Spare wheel

All Volvo buses feature with a wheel of a spare installed from the factory. For the case of the Volvo 9700 US/CAN bus the spare wheel is mounted in the front of the bus under the driving cab floor.

Do the following to access the mechanism that holds the spare wheel:

- 1 Get off the bus and open the front hatch.
- 2 Unhook the spare wheel clamping system.
- 3 Drop the spare wheel base support to the floor.
- 4 Pull the spare wheel to the outside.
- 5 Perform the spare wheel change.
- 6 Install the punctured wheel in the spare wheel base support.
- 7 Lift the spare wheel base support and lock the clamping system.
- 8 Close the front hatch.

**Note:** You should periodically verify the proper spare wheel pressure inflation and so keep it always ready at any time for when it happens a contingency.

For more information about release or set up the spare wheel, see separate operating instructions: “Wheels and air bellows replacement”.

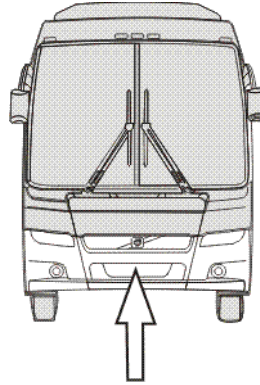

W0089968

Spare wheel location in the bus.

## Recommendations to avoid unnecessary tire wear

- Perform periodic inspections.
- Keep the correct air pressure, checking it against the load.

**Note:** Always check the pressure with a cold tire.

- Wear increases with increasing speed.
- Do not overload the tires with an unevenly distributed load.
- Do not drive when the tires are unbalanced and with different pressures.
- Check the wheel toe periodically.
- Rotate the wheels regularly.
- Keep the tires free of rocks and other objects on the tread grooves.
- Do not allow the tires to contact solvents, fuels and mineral lubricants.

**Note:** When mounting the tire on the rim, use only vegetal lubricant.

# 190 If something happens

## Recommended tire pressures

**Always follow the tire manufacturer's recommendations.** When this information is not available, you may temporarily use the tire pressures on the table below as a reference.

**Note:** The values in the table of tire pressures below come from (Latin American Tire and Rim Association).

Tire / Measurement	Load Index	Inflation pressure - lb/pl <sup>2</sup> (bar)											
		75 (5,2)	80 (5,5)	85 (5,8)	90 (6,2)	95 (6,5)	100 (6,9)	105 (7,3)	110 (7,6)	115 (8,0)	120 (8,3)	125 (8,5)	
		Load per tire in Kg											
315/80 R22,5	154	D	2300	2420	2540	2660	2780	2895	3010	3125	3240	3350	-
	150	S	2575	2710	2845	2980	3110	3240	3370	3500	3625	3750	-



## Check of tire wear

Check to make sure the tires are wearing normally.

Compare the wear with the figures, checking for various types of wear.

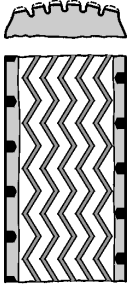
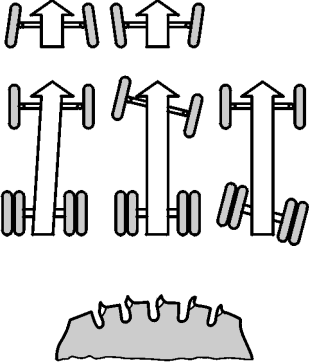
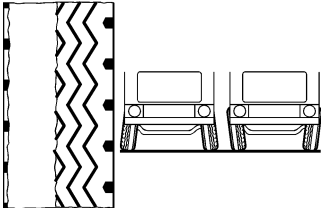
Symptoms	Probable cause	Illustration
<p>Normal wear, fast.</p>	<ol style="list-style-type: none"> <li>1 Hill roads with many curves or poorly paved.</li> <li>2 High ambient temperature.</li> <li>3 Improper tire for the usage type.</li> <li>4 Bad driving habits, specially incorrect use of the brakes and high speeds.</li> </ol>	
<p>Uneven wear, fast.</p>	<ol style="list-style-type: none"> <li>1 Incorrect parallelism of the front wheels.</li> <li>2 Incorrect parallelism between axles.</li> <li>3 Lack of regular inspections.</li> </ol>	
<p>Wear, one side.</p>	<ol style="list-style-type: none"> <li>1 Excessive positive or negative camber.</li> <li>2 Excessive bending of the axle due to overload.</li> </ol>	

# 192 If something happens

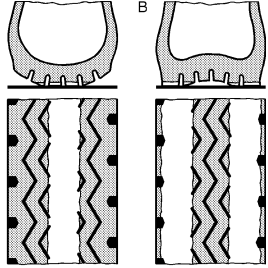
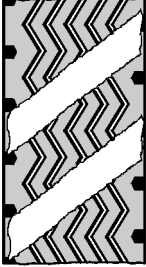
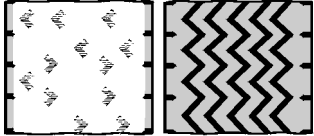
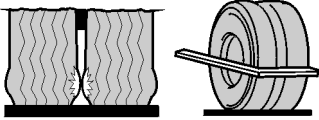
Symptoms	Probable cause	Illustration
<p>Central wear (A) and shoulders wear (B).</p>	<p>Incorrect pressure:</p> <p>A Pressure above recommendation.</p> <p>B Pressure below recommendation.</p>	
<p>Diagonal wear</p>	<ol style="list-style-type: none"> <li>1 Tire fluctuation.</li> <li>2 Doubles poorly combined.</li> <li>3 Erratic operation of the brakes.</li> <li>4 Heavy loads (“distribution”).</li> <li>5 Low air pressure or pressure difference between doubles.</li> <li>6 Tire breakdowns.</li> </ol>	
<p>Fast wear in one of the double assembly tires.</p>	<ol style="list-style-type: none"> <li>1 Tires with different diameters.</li> <li>2 Calibration.</li> <li>3 Bent axle.</li> <li>4 Overload.</li> </ol>	
<p>Wear due to friction between tires (“double assembly”).</p>	<ol style="list-style-type: none"> <li>1 Inappropriate pressures.</li> <li>2 Wheels incorrectly centered.</li> <li>3 Minimum spacing between tires outside the recommended.</li> <li>4 Incorrect tires type.</li> </ol>	

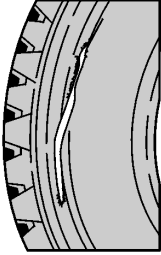
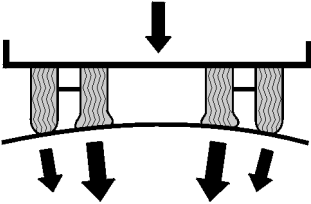
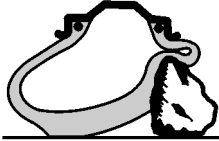
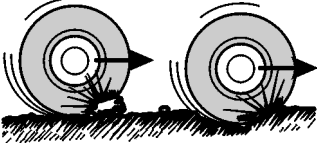
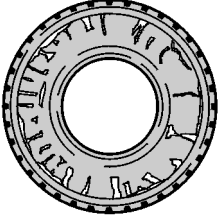
Symptoms	Probable cause	Illustration
<p>Housing broken on the flank.</p>	<ol style="list-style-type: none"> <li>1 Underinflated tire.</li> <li>2 Load unevenly distributed on the vehicle.</li> <li>3 Incorrect double assembly (dimensions, different wears, etc).</li> <li>4 Bulged roads.</li> <li>5 Accidental cut.</li> </ol>	
		
<p>Housing broken due to impacts.</p>	<ol style="list-style-type: none"> <li>1 Excessive pressure.</li> <li>2 High speed over big obstacles.</li> <li>3 Over-charging.</li> <li>4 Suspension, spring and dampers problems.</li> <li>5 Pinching by obstacle.</li> </ol>	
		
<p>Tire driven while empty or with low pressure.</p>	<ol style="list-style-type: none"> <li>1 Tire tube failure.</li> <li>2 Object penetration.</li> <li>3 Small leakage.</li> </ol>	

# 194 If something happens

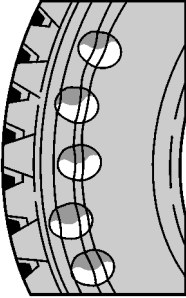
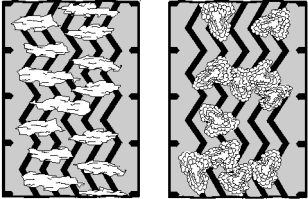
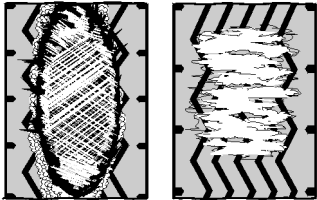
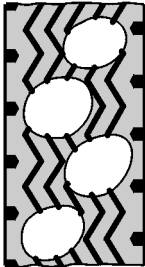
Symptoms	Probable cause	Illustration
Contamination of rubber.	<ol style="list-style-type: none"> <li>1 Contact of the tire with fuel, lubricants, burnt oil, greases, etc.</li> </ol>	
Multiple cuts.	<ol style="list-style-type: none"> <li>1 Improper tire for the usage type.</li> <li>2 Excessive pressure.</li> <li>3 Gravel roads, poorly kept roads, job sites, mines, etc.</li> <li>4 Excess of acceleration (“abusive usage”).</li> </ol>	
Localized wear due to brakes.	<ol style="list-style-type: none"> <li>1 New brakes not broke-in.</li> <li>2 Abrupt braking.</li> <li>3 Brake System unbalanced.</li> </ol>	
Wear of wave, bubble, etc. type.	<ol style="list-style-type: none"> <li>1 Incorrect assemblies.</li> <li>2 Incorrect matching of double assemblies.</li> <li>3 Anomalies on the fuel system operation.</li> <li>4 Pressures too low or unbalanced pressure in double assembly tires.</li> <li>5 Fatigued dampers and/or springs.</li> </ol>	

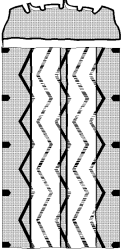
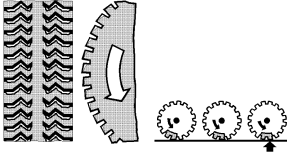
Symptoms	Probable cause	Illustration
<p>Longitudinal grooves.</p>	<p>1 Normal in non-drive wheels, good roads and long travels.</p>	
<p>Wear on the grooves edges ("tread").</p>	<p>1 It is normal, depending on the size of the tread; wear increases with increased weight.</p>	

## General dimensions

### 9700 US/CAN (6x2 only)

General dimensions for Volvo 9700 US/CAN bus in 6X2 axle configuration only.  
 General dimensions valid too: “9700 US/CAN WCL; with Wheel Chair Lift” version.

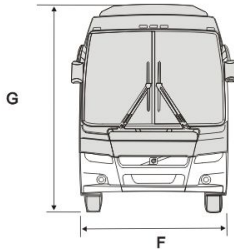
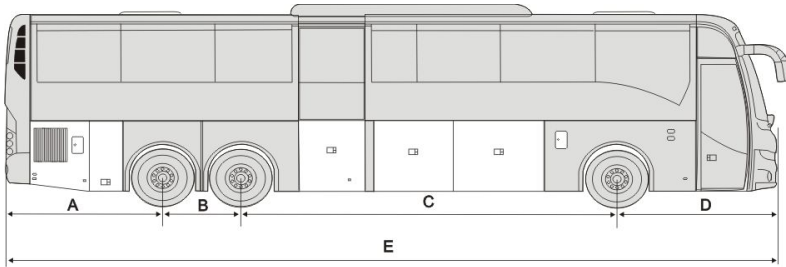

T8061190

#### General dimensions

	3 axle (Only); 13.7 m
<b>A</b>	2,780 mm (109 in.)
<b>B</b>	1400 mm (55 in.)
<b>C</b>	6660 mm (262 in.)
<b>D</b>	2,850 mm (112 in.)
<b>E</b>	13,690 mm (539 in.)
<b>F</b>	2600 mm (102 in.) <sup>1</sup>
<b>G</b>	3671 mm (145 in.) <sup>2</sup>

1 The dimension doesn't consider the side-view mirrors.

2 The air conditioning equipment is considered.

## Electrical system specifications

Voltage .....	24 V and 12 V (separately circuits).
Number of batteries .....	4
Connection to ground.....	Negative poles connected to the chassis.
Voltage (1 battery) .....	12 V
Capacity in 20 hours .....	- — Ah or — —Ah
Electrolyte density .....	- —g/cm <sup>3</sup> (charged) - —g/cm <sup>3</sup> (half charged) - —g/cm <sup>3</sup> (uncharged)
Alternator .....	150 A x 2
Starting Motor.....	5.6 kW (at +68 °F battery and wiring resistance 8 Ω).

### Bulbs for lighting lamps

In the table below, its provide the bulbs for lighting lamps part numbers, when require the order to be replaced.

Light	Rated Power	Volvo P/N
Main beam.	70 W	990037
Dipped beam.	35 W	21008653
Direction indicator, front.	21 W	982558
Direction indicator, rear.	21 W	982558
Fog lamps, front.	70 W	943903
Rear direction indicator lamp (LED).	—	22393677
Reversing lamp (LED).	—	22393680
Central tail lamp (LED).	—	70324417
Rear fog lamps.	21 W	945091
License plate lamp (LED).	—	21135967
Directional side lamp (LED).	2.64 W	22273875
Navigation side light (amber colour).	1.2 W	22358184
Navigation side light (red colour).	1.2 W	22358181
Cockpit upper light.	—	21599992



---

**Engine specifications**

Type .....	D13J
Number of cylinders .....	6
Maximum wattage .....	324kW (435hp) at 1700 rpm
Max torque .....	2250 Nm (1650 lb – ft) at 1100 rpm
Cylinder displacement .....	781 in <sup>3</sup> (12.8 L)
Compression ratio .....	16:1
Injection sequence.....	1 - 5 - 3 - 6 - 2 - 4
Emissions regulation.....	EPA 14
Fasteners and threads .....	Metric.

### Automatic gearbox specifications

#### Transmission ratios

Speed	Reductions, Volvo I-Shift AT2612D	Reductions, Allison 6B500 <sup>1</sup>
1st	14,94:1	3,51:1
2nd	11,73:1	1,91:1
3rd	9,04:1	1,43:1
4th	7,09:1	1,00:1
5th	5,54:1	0.74:1
6th	4,35:1	0.64:1
7th	3,44:1	N.A. <sup>2</sup>
8th	2,70:1	N.A.
9th	2,08:1	N.A.
10th	1,63:1	N.A.
11th	1,27:1	N.A.
12th	1,00:1	N.A.
Reverse gear R1	17,48:1	4,80:1
Reverse gear R2	13,73:1	N.A.
Reverse gear R3	4,02:1	N.A.
Reverse gear R4	3,16:1	N.A.

<sup>1</sup> Gear ratios do not include torque converter multiplication.

<sup>2</sup> Not Apply.

## Rear axle specifications

Designation .....	RS1228 C
Differential type .....	MS17X
Final drive/ratio.....	2,64:1
Number of teeth on differential (crown wheel/pinion) .....	45 / 17

## 202 Technical data

---

### Wheels and tires specifications

Wheels		Tires
Alloy disc wheels (with <b>DuraBrite™</b> finished).	9.00 x 22.5	315/80R22,5

## Front wheels alignment specifications

Toe—in.	1 to 3 mm	
Caster.	$+3^\circ \pm 0.25^\circ$	
<b>Left driver's position vehicle:</b>		
Camber. <sup>1</sup>	<b>LHS</b>	<b>RHS</b>
	$+0.4^\circ$	$-0.2^\circ$
King pin inclination.	$5.75^\circ$	$6,5^\circ$
Lock angle (°) left and right turn.	<b>Front axle <math>\pm 1,0^\circ</math></b>	
	<b>Inner wheel</b>	<b>Outer wheel (not adjustable)</b>
	50	41.4
	<b>Tag axle (steering) <math>+1^\circ / -2^\circ</math></b>	
	- - -	- - -

<sup>1</sup> Tolerance for vehicles in service at kerb weight=  $\pm 0.5^\circ$

**Note:** Measure with the vehicle empty.

## 204 Technical data

---

### Diesel Emission Fluid (DEF) tank specification

Capacity ..... 60 L

## Vehicle identification

Some components that integrate the Volvo 9700 US/CAN bus, for example; the engine, transmission, retarder (*if installed*), drive axle, among the others. may be have a plate or a label used for component identification, where provide a useful information to identify the component, some of these usually data are:

- Manufacturer.
- Manufacturing date and place.
- Serial number.
- Component model.
- Important technical data related with the component configuration.
- Internal own component manufacturer control information.

Below will mention only the most important identification plates or labels (as corresponds) in the bus for familiarization.

## Bus identification plate

The Volvo 9700 US/CAN bus Vehicle Identification Number (VIN) is marked on the bus identification plate located in the front lower part of the bus access stairs.

Within its inside border, the identification plate is subdivided into a legal requirement section, as well as three boxes for the chassis number, drive and wheelbase. These latter are not used for buses, only for lorries. The identification plate is located by the driver's seat and contains the following information:

- G.V.W.R (Gross vehicle weight rating), is the maximum allowable total weight of the vehicle.
- G.A.W.R (Gross axle weight rating), is the maximum distributed weight that may be supported by an axle VIN is the same number that can be found on the frame member.
- Maximum gross vehicle weight (kg / lb). The technical weight refers to the weight for which it was built the bus.
- The maximum weight (kg / lb), for the 3rd. axle (auxiliary or drag axle).
- Tires dimensions.
- Rims dimensions
- Cold inflation pressure, is the inflation pressure of the tires before the vehicle is driven and the tires warmed up.
- VIN is the same number that can be found on the frame member.

**VOLVO**

MANUFACTURED BY: VOLVO BUS CORPORATION  
FABRIQUE PAR:  VIM

G.V.W.R.: 22407 KG. (49400 LBS) DATE OF MFG:   
P.N.B.Y.:  DATE DE FAB:

AXLES/ ESSEUX	G.A.W.R/ P.M.B.		TIRES/ PNEUS	RIMS/ JANTES	COLD INFLATION PRESS/ PRES. A FROID		SINGLE OR DUAL/ SIMPLE OU DOUBLE
	KG	LBS			KPA	PSI	
FRONT/ AVANT:	7484	(16500)	315 / 80R22.5(J)	22.5/0,00	830	(120)	S
INT. DIFF:	10024	(22100)	315 / 80R22.5(J)	22.5/0,00	620	(90)	D
REAR/ ARRIERE:	4800	(10600)	315 / 80R22.5(J)	22.5/0,00	500	(85)	S

THIS VEHICLE CONFORMS TO ALL APPLICABLE U.S. FEDERAL MOTOR VEHICLE SAFETY STANDARDS AND CANADIAN MOTOR VEHICLE SAFETY REGULATIONS IN EFFECT ON THE DATE OF MANUFACTURE SHOWN ABOVE. VEHICULE EST CONFORME A TOUTES LES NORMES QUI LUI SONT APPLICABLES EN VERTU DES REGLEMENT SUR LA SECURITE DES VEHICULES AUTOMOBILES DU CANADA EN VIGUEUR A LA DATE DE SA FABRICATION INDIQUEE CI-DESSUS.

VEHICLE IDENTIFICATION NO.  TYPE: BUS B/A

T0015663



## Vehicle Identification Number (VIN)

This is stamped on the chassis C-beam at the right-hand front end of the vehicle, in the wheel arch in front of or behind the front axle.

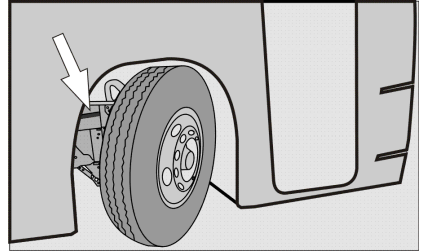

W0089910

The **VIN** number consists of 17 alphabetic and numeric characters, in which are expressed characteristics, vehicle origin place, manufacturing date and place, as well as the manufacturing consecutive number or serial number, among other data.

For example, with this **VIN** number **YV3R7G62151106335** express the following:

<b>YV3</b>	Manufacturer identification.
<b>R7</b>	Chassis version.
<b>G6</b>	Engine version.
<b>2</b>	Brake system type.
<b>1</b>	Check digit (according ISO 13779).
<b>5</b>	Model year.
<b>1</b>	Assembly factory.
<b>106335</b>	Chassis number.

### Engine identification labels

For the engine identification has a couple of labels adhered to the right side of the valve cover.

In these labels will find the following information:

- Application type.
- Part number.
- Engine serial number.
- Chassis serial number.
- Information of emission certification.

Also on the engine block count with the following information (which is marked with a punch in the middle of the engine block near the transfer pump):

- Engine control module part number (label adhered on the module).
- Engine type and application.
- Stamped engine serial number.
- Engine certifications.

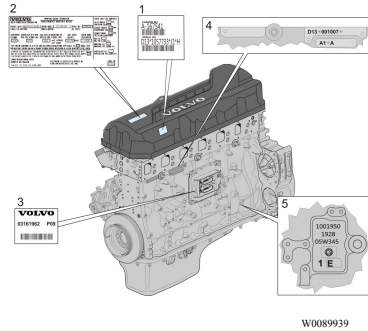

## Vehicle emission control information label

In the engine compartment, an additional label is placed (A). Which label contains information regarding to vehicle emission control (B).

This label is located as shown in the image (A).

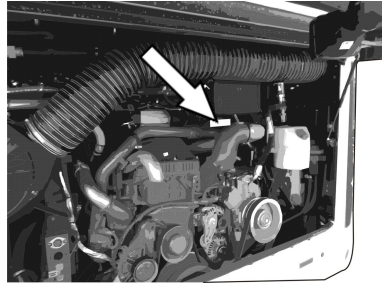

W0101024

(A) Vehicle emission control label location inside the engine compartment.

VEHICLE EMISSION CONTROL INFORMATION	
VOLVO BUS CORPORATION A DIVISION OF VOLVO GROUP	
	
VEHICLE FAMILY IDENTIFICATION: FVPT2V0VCF00	VIN3CET2V221F5171421
REGULATORY SUB-CATEGORY: Heavy duty vocational vehicle.	
DATE OF MANUFACTURE: 02/2015	
VEHICLE EMISSION CONTROL SYSTEM: LRR4	
THIS VEHICLE COMPLIES WITH U.S. EPA REGULATIONS FOR MY 2015 HEAVY DUTY VEHICLES.	
22204124	

W0101015

(B) Vehicle emission control label information.

### I-Shift transmission identification plate (if installed)

The type designation and serial number of the **I-Shift** transmission are marked on the identification plate located at the top of the transmission.

The information provided in the plate is as follows:

- Transmission model.
- Service type.
- Part number.
- Serial number.

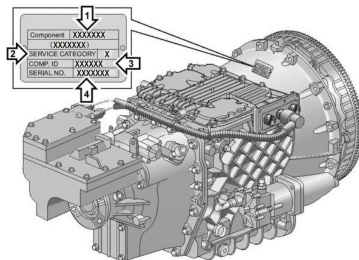

W0091964

## Allison transmission (identification plate)

The transmission series, the transmission model and the serial number are punched on the plate located in the left side of the transmission.

The information provided on the plate as follows:

- Transmission series and model.
- Serial number.
- Part number.

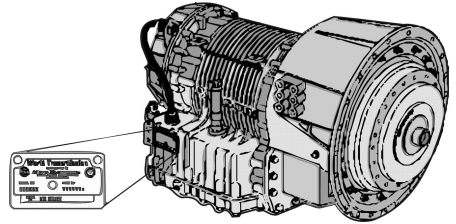

W0095903

### Rear axle identification plate

The plate is located on the carrier housing in the drive axle.

The information provided in the plate is as follows:

- Carrier model.
- Carrier ratio.
- Category or service type.
- Drive axle part number.
- Carrier assembly number.
- Chassis serial number assigned.
- Axle serial number.

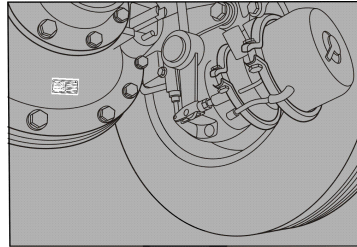

W0089943

## Retarder identification plate (if installed)

Retarder serial number and its version are stamped on rear left side of retarder housing. The information provided in the plate is as follows:

- Retarder model.
- Serial number.
- Manufacturing date.
- Part number assigned by “VOITH”.
- Part number assigned by “Volvo”.

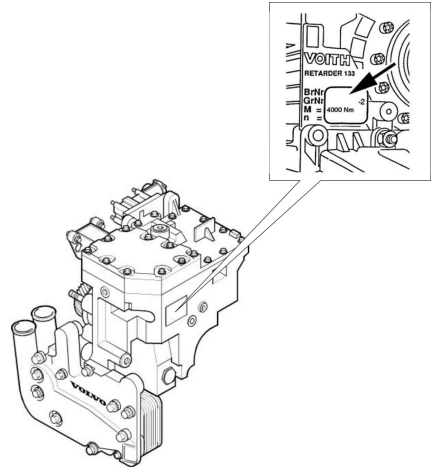

### Service intervals

Regular servicing in accordance with the special service schedule is required to maintain the bus to its original specifications throughout its service life.

Carry out all servicing and maintenance of the bus at a Volvo workshop or, for Prevost support vehicles, in Prevost service center/provider.

These workshops have the trained personnel, special tools and necessary service literature that are vital in ensuring high quality of servicing. This quality also depends on the use of Volvo Original parts, which are of identical quality to the components installed at the Volvo manufacturing facility.

For service intervals, see the separate service literature to know this intervals. Refer to the separate service information related to the 9700 BSTAR — NAM-SPEC and B13R EM-USA17 model.

**Note:** When washing the bus, only use agents that are intended for this purpose, see separate operating instructions: “Interior maintenance” and “Exterior maintenance”.



**A**

A/C Controller, multiplexing system..... 70

Accelerator pedal deactivated..... 19

Additional fire detection system (multiplexed)..... 153

Adjusting external rear view mirrors..... 48

Air conditioning test switch..... 44

Allison automatic transmission..... 56

Allison identification plate.....211

Allison transmission mode function..... 58

Allison transmission shifter..... 57

Alternative towing procedure..... 151

ARMS (Automatic Reset Main Switch)..... 135

ARMS failure detection..... 135

Assistance and rescue on highway (VAS, Volvo Action Service)..... 143

Audio system..... 41, 85

Audiovisual control panel..... 84

Audiovisual system..... 83

Audiovisual system..... 83

Automatic Fire Suppression System..... 89

Automatic Fire Suppression System (AFSS) manual discharge..... 90

Automatic gearbox specifications..... 200

**B**

Batteries charger..... 137

Batteries cut-off switch..... 163

Blocking valve..... 64

Body electric circuit fuses..... 180

Body electric circuit relays..... 179

Body fuses..... 180

Body fuses, continue..... 181

Body relays..... 179

Bulb replacement..... 165

Bulbs for lighting lamps..... 198

Bulk charge time estimation..... 138

Bus electrical center..... 169

Bus identification plate..... 206

Bus interior and exterior cleaning and maintenance..... 103

Bus structural lift points..... 187

Bus towing considerations..... 150

**C**

Central locking..... 40

Change the batteries..... 157

Chassis electric circuit fuses..... 173

Chassis electric circuit relays..... 170

Check the warning lights..... 104

Checking before driving..... 102

Checking of tire wear..... 191

Closing the bus..... 8

Combined cruise control and speed limiting..... 124

Compensating for differences in the wear of the brake pads..... 68

Control pendant (for Wheel Chair Lift, WCL equipment)..... 82

Critical emissions related maintenance..... 130

Cruise control activation..... 118

Cruise control deactivation..... 119

**D**

Daily inspection.....	105
Dashboard.....	17
Destination sign control.....	71
Destination sign lighting.....	38
Destination sign, Innova.....	72
Destination sign, Mobitec.....	73
Diesel Emission Fluid (DEF) tank specification.....	204
Diesel Exhaust Fluid (DEF) level related messages.....	111
Diesel Exhaust Fluid (DEF) tank.....	110
Diesel exhaust fluid gauge.....	26
Diesel Particulate Filter (DPF) regeneration required icon.....	128
Differential lock.....	35
Directional indicator, dipped / full beam changer.....	52
Door brake general deactivation.....	50
Door brake switch.....	45
Doors and hatches.....	6
Doors and hatches configurations.....	9
Doors.....	6
Driver blower.....	39
Driver compartment lighting.....	37
Driver display.....	23
Driver window heating.....	39
Driver's area.....	13
Driver's area.....	13
Driver's responsibility.....	1
Driver's seat.....	14
Driver's seat features label.....	15
Driving in cold weather.....	141

**E**

EBS, Electronically- controlled braking system.....	67
Economy driving.....	140
Electrical fault general lookup.....	168
Electrical system specifications.....	197
Electrically heated rear view mirrors.....	39
Emergency and safety equipment.....	87
Emergency and safety equipment.....	87
Emergency brake.....	63
Emergency exits — doors.....	99
Emergency stop switch.....	31
Emergency stop.....	5
Emergency window in use indicator lamp.....	43
Emergency windows.....	101
Emission green house gas component warranty.....	130
Engine block heater.....	112
Engine control panel in engine bay.....	98
Engine coolant system fluid level.....	106
Engine coolant temperature gauge.....	22
Engine identification labels.....	208
Engine idle speed adjustment.....	116
Engine oil level.....	105
Engine specifications.....	199
Entering the bus.....	4
Exhaust Aftertreatment System (EATS) components.....	126
Exhaust Aftertreatment System (EATS), warnings.....	127
External air supply connection.....	95

**F**

Faults and warnings..... 18  
 Fire extinguisher..... 88  
 First aid kit..... 94  
 Front wheels alignment  
   specifications..... 203  
 Fuel gauge..... 23  
 Fuel replenishment  
   warnings..... 109  
 Fuel replenishment..... 108  
 Fuse boxes inside  
   to the batteries  
   compartments..... 182  
 Fuses and relays electrical  
   box inside to the right  
   hand side batteries  
   compartment..... 183  
 Fuses chassis..... 178  
 Fuses FH1 section..... 173  
 Fuses FH2 section..... 174  
 Fuses FH3 section..... 175  
 Fuses FH4 section..... 176  
 Fuses FH5 section..... 177  
 Fuses FH6 section..... 177  
 Fuses in the electrical  
   distribution box  
   corresponding to the I-Start  
   system..... 184  
 Fuses in the right hand  
   side batteries compartment  
   electrical box..... 184–185

**G**

General dimension, Volvo  
 9700 US/CAN (6X2)  
 bus..... 196  
 Ground stud for jump start  
   batteries..... 162  
 Guide or driver  
   microphone..... 86

**H**

Half-light lighting..... 37  
 Hatches and doors opened  
   warning..... 9

Hazard warning lights..... 30  
 Headlamp bulb  
   replacement..... 165  
 Headlamps..... 165  
 Headlight washers..... 53  
 High brake temperature  
   warning..... 69  
 High engine exhaust system  
   temperature..... 129  
 Hill start assistance..... 35  
 Horn..... 16  
 Hydraulic jack..... 96  
 Hydraulic level fluid for the  
   engine coolant fan..... 106

**I**

I-Shift transmission  
   identification plate..... 210  
 I-Shift transmission lever  
   selector..... 54  
 I-Shift transmission pad  
   selector..... 55  
 I-Start system batteries  
   compartments decals..... 132  
 I-Start system failure  
   detection..... 133  
 I-Start system power  
   relays..... 136  
 I-Start system..... 131  
 If something happens..... 143  
 If the engine is not  
   working..... 145  
 Ignition switch..... 46  
 Increasing load on the drive  
   axle (bogie lift)..... 34  
 Indicator lights on after  
   the engine has been  
   started..... 115  
 Instrument cluster..... 21  
 Instrument panel lamps and  
   symbols..... 27  
 Instruments and controls..... 18  
 Interior equipment..... 74  
 Interior equipment..... 74  
 Introduction..... 1

<b>J</b>	
Jump start batteries procedure warnings. ....	161
Jump start batteries procedure. ....	160
<b>K</b>	
Key and cylinder replacement. ....	3
Keys. ....	2
Kneeling system. ....	32
<b>L</b>	
LED lighting stripe. ....	77
Level control. ....	33
Liaison communication system. ....	80
License plate lighting lamp replacement. ....	167
License plate lighting. ....	167
Lighting Switch. ....	29
Lights switch. ....	29
<b>M</b>	
Main/dipped beam, switching (lights on) ....	52
MCM (Master Control Module) service switch. ....	44
Mini fuse box holder inside to the left hand side batteries compartment. ....	186
Mini fuse box holder. ....	186
<b>N</b>	
Night lighting. ....	36
<b>O</b>	
Open door brake deactivation. ....	50
Open door brake. ....	49
Opening service door from the outside. ....	41
Opening the bus from inside. ....	7
Other body electric circuit fuses. ....	181
Other body electric circuit relays. ....	179
Other body fuses. ....	181
Other body relays. ....	179
Other chassis electric circuit relays. ....	172
<b>P</b>	
Park pilot system. ....	91
Parking brake mechanical releasing. ....	155
Parking brake on disc brakes mechanical releasing. ....	156
Parking brake. ....	62
Passenger AC 110 V power outlets circuit breaker. ....	79
Passenger compartment lighting. ....	36
Passenger's individual lighting. ....	37
Passengers AC 110 V power outlets in the passengers seats. ....	78
Passengers panel. ....	77
Passengers sliding seats. ....	81
Passengers thermometer and clock display. ....	76
Pneumatic system pressure gauge. ....	24
Position lights. ....	38
Power steering hydraulic oil level. ....	106
Power steering. ....	125
Prioritized brake function. ....	19
Protection against batteries discharge. ....	5
Punctured air bellows. ....	147
Punctures. ....	147

**Q**

QR code labels. .... 142

**R**

Rear axle identification plate. .... 212  
 Rear axle specifications. .... 201  
 Rear lights. .... 166  
 Recommendations to avoid unnecessary tire wear. .... 189  
 Recommended tire pressures. .... 190  
 Relays chassis. .... 172  
 Relays FH2 section. .... 171  
 Relays in the electrical distribution box corresponding to the I-Start system. .... 183  
 Relays in the right hand side batteries compartment electrical box. .... 183  
 Relays KH1 section. .... 170  
 Relays KH2 section. .... 170  
 Relays KH3 section. .... 171  
 Release the parking brake with air from the bus tires. .... 154  
 Retarder enabled. .... 36  
 Retarder identification plate. .... 213  
 Retarder overheating. .... 61  
 Retarder use. .... 121  
 Retarder. .... 60, 120  
 Roof hatches. .... 12  
 Roof hatches. .... 100

**S**

Safe driving. .... 139  
 Safety information. .... 11  
 Safety. .... 144  
 Selective Catalyst Reduction (SCR). .... 164  
 Service brakes use. .... 66

Service brakes. .... 65  
 Service intervals. .... 214  
 Shutdown the engine. .... 114  
 Some advice for driving. .... 139  
 Spare wheel. .... 188  
 Speed limiting. .... 123  
 Speedometer. .... 25  
 Start a cold engine. .... 113  
 Starter and consumer batteries failure detection. .... 134  
 Starting a warm engine. .... 114  
 Starting and driving. .... 102  
 Starting assistance. .... 159  
 Starting the engine. .... 113  
 Steering wheel adjustment. .... 51  
 Stop at the next bus stop message. .... 20  
 STOP message. .... 20  
 Sun visor. .... 40  
 Switches into the electrical center. .... 44  
 Switches. .... 31

**T**

Tachometer. .... 25  
 Tail lamp replacement. .... 166  
 Technical data. .... 196  
 Telematics Gate Way system. .... 80  
 Tire inflation valve. .... 95  
 Tire Pressure Monitoring System (TPMS) display. .... 93  
 Tire Pressure Monitoring System (TPMS). .... 92  
 Toilet activation. .... 40  
 Toilet. .... 75  
 Toolbox. .... 97  
 Towing. .... 148  
 Traction Control System (TCS). .... 34  
 Transmission overheating. .... 59  
 Transmission ratios. .... 200  
 Trash bin; rear. .... 75

Turbo pressure gauge..... 22

### V

Vehicle emission control  
information label..... 209

Vehicle Identification  
Number (VIN)..... 207

Vehicle identification..... 205

Video system..... 84

### W

Warning message..... 20

Warning triangle..... 94

Wheel Chair Lift (WCL)  
system indicator light..... 43

Wheel Chair Lift (WCL)  
system; (optional)..... 42

Wheels and tires  
specifications..... 202

Wheels replacement..... 187

Windscreen washers..... 53

Windscreen wipers..... 53

Windscreen wipers,  
windscreen headlight  
washer..... 53

Windshield washer fluid..... 107

### X

Xenon lights..... 166



**VOLVO**

**Volvo Bus Corporation**

Göteborg, Sweden



# **Driver's Handbook**

Electronic Brake System (EBS)  
Multiplex electrical system Version 2

**VOLVO**

# Foreword

This manual contains information concerning the operation and function of the Electronic Brake System (EBS). The information in this manual applies to vehicles built January 2009 and later. Please keep this manual in the vehicle at all times.

**Note:** Illustrations in this manual are used for reference only and may differ slightly from the actual vehicle. However, key components addressed in this document are represented as accurately as possible.

## **Volvo Bus Corporation**

Göteborg, Sweden

**Order number: PV776-20196363**

© 2009 Volvo Bus Corporation, Göteborg, Sweden

All rights reserved. No part of this publication may be reproduced, stored in retrieval system, or transmitted in any forms by any means, electronic, mechanical, photocopying, recording or otherwise, without the prior written permission of Volvo Bus Corporation

---

# Contents

<b>About EBS</b> .....	1
General .....	1
<b>Manually Engaged Functions</b> .....	2
Antispin (Traction Control System, TCS) .....	2
Brake Blending .....	4
Engage Differential Lock .....	4
Automatic Engagement of Differential Lock (DLC — Differential Lock Control) .....	6
Hill Start Assistance .....	7
<b>Automatic Functions</b> .....	8
ABS .....	8
Electronic Stability Program (ESP) .....	8
Engine Torque Control .....	9
Emergency Braking Assistance .....	9
Equalizing Brake Pad Wear .....	9
Predicted Brake Pad Wear .....	10
Warning of High Brake Temperature .....	10
Wheel Brake Monitoring .....	10
<b>Fault Codes</b> .....	11
Resetting Fault Codes .....	11

---

# Safety Information

**IMPORTANT:** Before driving this vehicle, be certain that you have read and that you fully understand each and every step of the driving and handling information in this manual. Be certain that you fully understand and follow all safety warnings.

IT IS IMPORTANT THAT THE FOLLOWING INFORMATION BE READ, UNDERSTOOD AND ALWAYS FOLLOWED.

The following types of advisories are used throughout this manual:



## DANGER

Danger indicates an unsafe practice that could result in serious personal injury or death. A danger advisory banner is in **white** type on a **black** background with a **black** border.



## WARNING

Warning indicates an unsafe practice that could result in personal injury. A warning advisory banner is in **black** type on a **gray** background with a **black** border.



## CAUTION

Caution indicates an unsafe practice that could result in damage to the product. A caution advisory is in **black** type on a **white** background with a **black** border.

**Note:** Note indicates a procedure, practice, or condition that must be followed in order for the vehicle or component to function in the manner intended.

## **General**

EBS (for multiplex electrical system Version 2) does not work in the same way as previous braking systems. In previous braking systems a particular pressure to the pedal applied a particular pressure to the braking system. With EBS a particular pressure to the pedal now gives a particular reduction in speed, while the pressure applied to the brake cylinders on the axles varies depending on the load of the axles.

The initial braking after reloading can identify differences and allows the braking system has to adjust to the new axle loading.

## 2 Manually Engaged Functions

---

### Antispin (Traction Control System, TCS)

The Traction Control System (TCS) automatically reduces engine torque in the event of wheel spin. At speeds below 40 km/h (25 mph), TCS also functions as an automatic differential brake and brakes the driving wheels on one side when required.

#### Off-road TCS

Engage the off-road TCS in difficult conditions, such as on sand, gravel or snow. TCS then allows the wheels to spin more. The function is activated by pressing the switch. Disengage the off-road TCS by pressing the switch again. When the off-road TCS is engaged an indicator on the switch lights up, at the same time as the level for engaging Electronic Stability Program (ESP) is raised slightly.

**Note:** Do not use the off-road TCS during normal driving.



T3014400

Display symbol when TCS is activated.

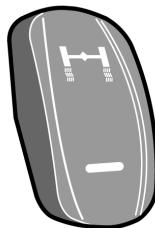

T0012059

## Disengage TCS

Use the display control lever to disengage the TCS. The vehicle should be stationary. Please refer to the “Drivers Information Display (DID)” manual for more information about the display functions.

- 1 Scroll to the “Settings” menu (3 and 4)
- 2 Press “Select” (2)
- 3 Scroll to the “Traction control” menu (3 and 4)
- 4 Press “Select” (2)
- 5 Scroll to “Off” (3 and 4)
- 6 Press “Select” (2)

The next time that the ignition key is turned to the drive position or the front axle rotates faster than 12 km/h (7 mph) the TCS will engage again.

**Note:** Switch off TCS before towing with a raised axle!

**Note:** Disengage the TCS during rolling brake tests!

## If TCS is Activated After Changing a Wheel

If a smaller wheel is installed on the drive axle TCS may be activate.

Drive faster than 25 km/h (16 mph). The EBS system learns the difference in size between the wheels. How long for depends on how great the difference in size between the wheels is.

It may be difficult to drive because the TCS is limiting the engine torque. In this case engage terrain TCS (“Off-road TCS” page 2). Terrain TCS permits greater differences in wheel speed between the front axle and the driven axle. When Terrain TCS is engaged, it will take longer for the EBS system to learn the difference of the new wheel size.

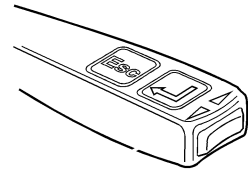

T3008810

## 4 Manually Engaged Functions

### Brake Blending

When the retarder lever is in the “A” position, the supplementary brakes are applied together with the normal brakes when the brake pedal is pressed.

The EBS ensures that the different brakes are used in the most effective way. The supplementary brakes are used as much as possible and the normal brakes are applied as required.

**Note:** The “B” position for the lever is only available on vehicles built with the I-Shift transmission. This position activates a braking program that allows a higher engine speed when engine braking is applied.

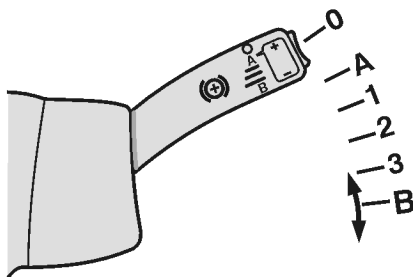

T0010263

Put the lever in position “A”

### Engage Differential Lock

(This function is an option.)

On vehicles equipped with a differential lock, the differential lock can be coupled without pressing down the coupling. When the switch is pressed at speeds (below 40 km/h (25 mph)), the EBS system will slow the wheels so that they are all rotating at the same speed when the differential lock is engaged. At speeds above 40 km/h (25 mph) the EBS system waits (it does not brake the wheels) until the wheels are rotating at the same speed before engaging the differential lock.

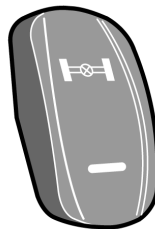

T0012041

Differential lock engaged. The light on the instrument panel flashes.



For automatic engagement of the differential lock see “Automatic Engagement of Differential Lock (DLC — Differential Lock Control)” page 6 .

- 1 Set the switch to the lower position
- 2 Wait until the indicator light on the instrument panel flashes
- 3 Accelerate **carefully** so not to damage the drive axle and gear
- 4 Drive away from the slippery area
- 5 Release the accelerator
- 6 Disengage the differential lock

**Note:** The differential lock is not engaged until the warning lamp on the instrument panel flashes. **And remains engaged as long as the warning lamp is flashing, even if the switch is turned off.**

## 6 Manually Engaged Functions

---

### Automatic Engagement of Differential Lock (DLC — Differential Lock Control)

(This function is an option.)

Put the differential lock switch in the center position. The DLC is then activated.

The differential lock engages automatically when the drive wheels turn at different speeds and vehicle speed is below 15 km/h (9 mph).

The differential lock disengages if the vehicle speed exceeds 15 km/h (9 mph) or at the next gear shift.

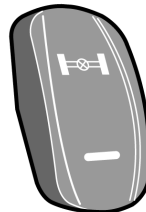

T0012041

#### Overview of the Switch Functions

Switch position	Function
0 (upper position)	No differential lock engaged.
1 (center position)	DLC engaged.
2 (lower position)	Differential lock manually engaged.

#### Manual Engagement of the Differential Lock

See “Engage Differential Lock” page 4 .

## Hill Start Assistance

(This function is an option.)

The function is activated by pressing the switch. The lamp on the switch, then lights up to indicated the activation.

**Note:** The function works differently depending on whether the vehicle is equipped with a manual or automatic transmission.

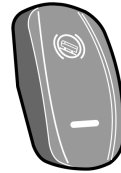

T0012045

Switch for hill start help.

- 1 Keep the bus still with the brake pedal
- 2 Release the foot brake.  
The brake pressure is automatically retained for a few moments.  
The symbol in the display is shown as long as the brakes are applied.
- 3 Start accelerating.

The brakes are automatically released two seconds after the brake pedal is released, or when the engine torque is sufficient.

Deactivate the function by pressing the switch again. The function is always disengaged when the engine is started.

## 8 Automatic Functions

---

### ABS

ABS is part of EBS and is fully automatic.

### Electronic Stability Program (ESP)

(This function is an option.)

ESP is a stabilizing system that reduces the risk of overturning and skidding.

If the system senses that the bus is going to tip over. It first cuts back the engine. If this is not sufficient, it then applies the wheel brakes to reduce the speed of the vehicle.

If the system senses a risk of skidding, it cuts back the engine and applies the wheel brakes as necessary to hold the vehicle on its course. If necessary, the supplementary brakes are also disengaged.



T0012128

The displays shows the symbol for ESP engaged because of the risk of tipping.



T3014400

Display symbol when the ESP is activated because of the risk of skidding.



### WARNING

Drive the vehicle in the same way as vehicles without an ESP. ESP reduces the risk of tipping and skidding, but a bus can still tip over if the center of gravity is very high and the wheels hit a curb at high speed, or by careless driving. A bus can skid on slippery surfaces even if it is equipped with ESP.

Do not drive buses equipped with ESP through steeply banked curves (for example on a test track). Driving through steeply banked curves can cause the ESP to be engaged unnecessarily, which could be dangerous.

## Engine Torque Control

(This function is an option.)

When the accelerator is released on a slippery road, the supplementary brake or the engine brake can lock the driving wheels. When this happens the supplementary brake is disengaged and the engine drives the driving wheels until they rotate at the same speed as the front wheels. This does not happen if the transmission is in neutral, the ABS is activated or the vehicle speed is less than 10 km/h (6 mph).



T3014400

Display symbol for regulation of engine torque.

## Emergency Braking Assistance

(This function is an option.)

When the brake pedal is pressed quickly and forcefully the braking pressure is higher and the braking effect stronger. This function is there to enable rapid application of full braking force in emergency situations.

## Equalizing Brake Pad Wear

**Note:** Does not apply to low entry buses.

If the brake pads wear more on one axle than another, greater braking force is distributed to the other wheels to even out the wear.

**Note:** This function works during gentle braking. During harder braking the braking force is divided so that braking occurs as effectively as possible.

A warning symbol is shown on the display panel when a brake shoe becomes more than 80% worn.



T5013668

Display symbol when a brake shoe is more than 80% worn.

## Low Entry Buses

Buses with low entry have a wear warning, but do not perform the brake shoe wear evening function. The wear warning only applies to the drive and running axle, when the front axle has no wear sensor.

### Predicted Brake Pad Wear

**Note:** Does not apply to low entry buses.

(This function is an option.)

The “Vehicle Data” menu displays information about when the brake linings must be replaced. This information can also be read off by a Volvo service shop.

### Warning of High Brake Temperature

If the brakes become too hot the “CHECK” lamp illuminates and a symbol is shown on the display.

**Note:** If the temperature is allowed to rise even further, the feeling of the brakes changes so that the pedal has to be pressed harder to obtain the same braking effect as before.



T5013670

Warning symbol for high brake temperature.

### Wheel Brake Monitoring

(This function is an option.)

If the braking effect on a wheel is weaker than on the other wheels, the “CHECK” lamp illuminates and a symbol is shown on the display. This does not necessarily mean that braking feels different as the other wheels brake harder. However a fault code is stored in the system and a Volvo service shop should examine the braking system.



T3014494

Warning symbol for poor braking effect.

## Resetting Fault Codes

If the brake pedal is pressed when the pressure in the braking system is too low, several fault codes can be set. These codes can be removed in the following way:

- 1 Ensure that the vehicle is stationary.
- 2 Check the display to see that the air pressure is at least 9 bar (130 psi). If it is not, start the engine to allow the pneumatic system to pressurize.
- 3 Switch off the ignition so that the control unit is reset.
- 4 Start the engine without touching the foot brake.
- 5 Wait at least five seconds.
- 6 Slowly depress the foot brake until it is fully depressed (it should take at least one second to be fully applied from when it is released).
- 7 Hold the foot brake fully depressed for at least seven seconds.
- 8 Release the foot brake slowly (it should take at least one second from fully applied to when it is released).
- 9 Switch off the ignition.
- 10 Wait at least five seconds.
- 11 Switch the ignition on.
- 12 Check the fault codes.

After resetting, the fault codes should be inactive. Otherwise the fault remains.

If it takes longer than 25 seconds to carry out steps 10, 11 and 12 or the fault codes will not be deactivated.

**Note:** If the above procedure does not help, contact a Volvo service shop for further examination of the system.

**VOLVO**

**Volvo Bus Corporation**

Göteborg, Sweden



# Driver's Handbook

Webasto Thermo Control 230/300/350



TS008841

**VOLVO**



# Foreword

This manual contains information concerning the operation and function of the Webasto Thermo 230/300/350 water heating unit control. The information in this manual applies to vehicles built June 2008 and later. Please keep this manual in the vehicle at all times.

**Note:** Illustrations in this manual are used for reference only and may differ slightly from the actual vehicle. However, key components addressed in this document are represented as accurately as possible.

## **Volvo Bus Corporation**

Göteborg, Sweden

**Order number: PV776-20196677**

© 2009 Volvo Bus Corporation, Göteborg, Sweden

All rights reserved. No part of this publication may be reproduced, stored in retrieval system, or transmitted in any forms by any means, electronic, mechanical, photocopying, recording or otherwise, without the prior written permission of Volvo Bus Corporation



---

# Contents

<b>Display</b> .....	1
General Introduction .....	1
Display .....	2
<b>Button Functions</b> .....	3
Buttons for Changing Parameter Values .....	3
Setting of the Time and Date .....	3
Button for Programming Unit Start-up Time .....	4
Button for Starting the Unit .....	5
Turning off the Unit .....	5
Programming and Control of the Unit Time of Work .....	5
Setting of the Alarm Clock .....	6
Check the Setting of the Alarm Clock .....	6
Programming Unit Start-up/Shut-down Time .....	6
<b>Error Messages</b> .....	7
Error Messages .....	7

---

# Safety Information

**IMPORTANT:** Before driving this vehicle, be certain that you have read and that you fully understand each and every step of the driving and handling information in this manual. Be certain that you fully understand and follow all safety warnings.

IT IS IMPORTANT THAT THE FOLLOWING INFORMATION BE READ, UNDERSTOOD AND ALWAYS FOLLOWED.

The following types of advisories are used throughout this manual:



## DANGER

Danger indicates an unsafe practice that could result in serious personal injury or death. A danger advisory banner is in **white** type on a **black** background with a **black** border.



## WARNING

Warning indicates an unsafe practice that could result in personal injury. A warning advisory banner is in **black** type on a **gray** background with a **black** border.



## CAUTION

Caution indicates an unsafe practice that could result in damage to the product. A caution advisory is in **black** type on a **white** background with a **black** border.

**Note:** Note indicates a procedure, practice, or condition that must be followed in order for the vehicle or component to function in the manner intended.

## General Introduction

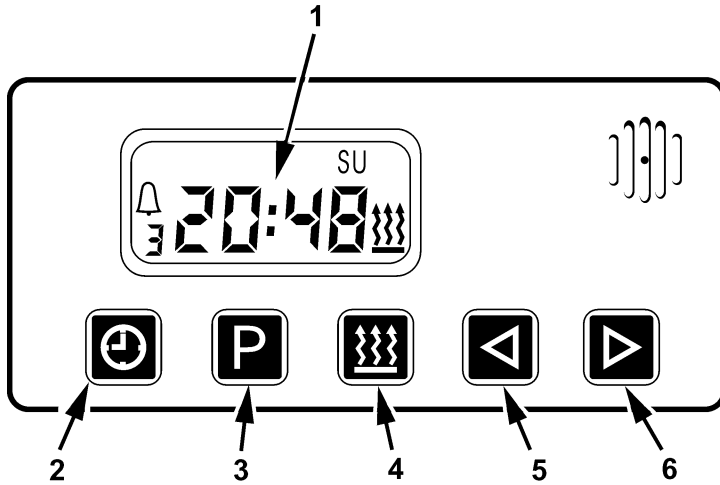

T8008842

- |   |                          |   |   |
|---|--------------------------|---|---|
| 1 | Display                  | 5 | Button for reducing the value of the parameter selected   |
| 2 | Clock button             | 6 | Button for increasing the value of the parameter selected |
| 3 | Program selection button |   |   |
| 4 | Button for unit start-up |   |   |

## 2 Display

---

### Display

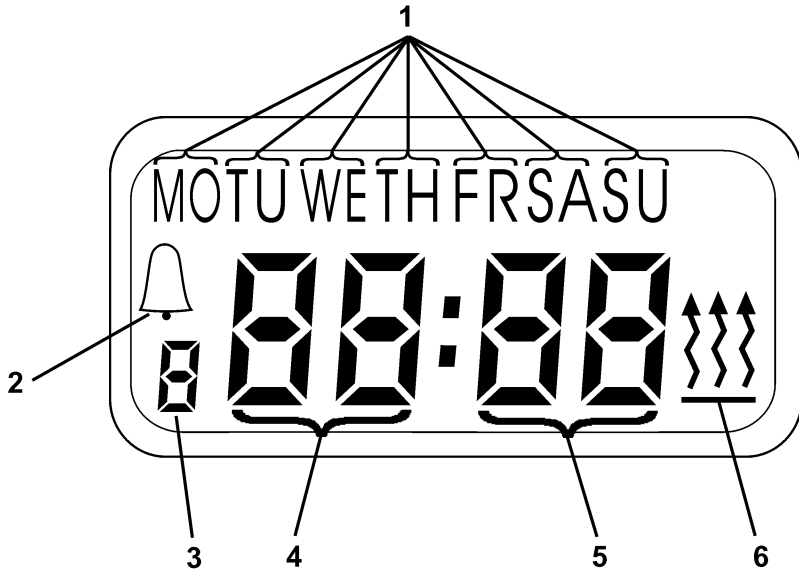

T8008844

- |   |  |   |  |
|---|--|---|--|
| 1 | Symbols for the days of the week:<br>MO - Monday<br>TU - Tuesday<br>WE - Wednesday<br>TH - Thursday<br>FR - Friday<br>SA - Saturday<br>SU - Sunday | 2 | Symbol for alarm clock set                             |
|   |  | 3 | Symbol for programming unit start-up<br>time (1, 2, 3) |
|   |  | 4 | Symbol for hours (0, 1, 2.....22, 23)                  |
|   |  | 5 | Symbol for minutes (00, 01, 02.....58,<br>59)          |
|   |  | 6 | Symbol for unit turned on                              |



## Buttons for Changing Parameter Values

By pressing the (1) button, you can reduce the value of the selected parameter (day of the week, hour, minutes or programme of starting up the unit) and by pressing the (2) button, you can increase the value of the selected parameter. Pressing and holding either button (1) or (2) for longer than 2 seconds, will change the selected parameter at a faster rate. When the buttons are not used for longer than 5 seconds the value set is entered in the memory.



T8008839

Button 1



T8008840

Button 2

## Setting of the Time and Date

By pressing the (3) button, you can set the present hour, minutes and day of the week.



T8008836

Button 3

Pressing and holding the (3) button for longer than 2 seconds and the symbols for hours and minutes begin to flash simultaneously. With the aid of the (1) or (2) button, set the present time.

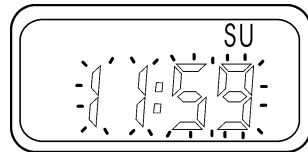

T8008851

After setting the time, wait 5 seconds and the symbol for the day of the week begins to flash. Next, with the aid of (1) or (2) button, set the present day of the week. After setting, press the button or wait 5 seconds to enter the selected values in the control memory.



T8008852

## 4 Button Functions

---

### Button for Programming Unit Start-up Time

Using the (4) button you can select one of three programs for unit starting up.



T8008837

Button 4

To change the setting of the first program, press the (4) button once. To change the setting of the second program press the (4) button twice and to change the setting of the third program, press the (4) button three times. The number of the program that's selected, will be shown flashing on the display.



T8008854

When the (1) or (2) button is pressed, the symbol of the hours and minutes then begins to flash. Set the desired hour and minutes with the (1) or (2) button and then wait five seconds.

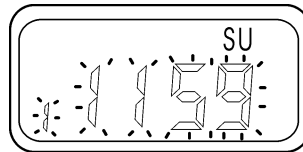

T8008853

The symbol of the day of the week begins to flash. The value can be changed with button (1) or (2). After waiting five seconds or pressing button (4), the time value for unit starting up is set and entered in the memory.



T8008855

On the display, the number of the program selected is illuminated and the background lighting of the unit start-up time button (5) begins to flash.

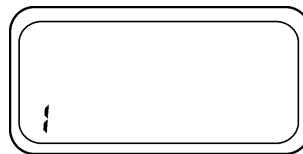

T8008856

## Button for Starting the Unit

The unit can start up automatically (see subheading Button for programming unit start-up time) or manually. In order to start up the unit manually press button (5).



T8008838

Button 5

The unit turned on symbol appears on the display and the time remaining for completion of its work. If you wish to change the value of the time remaining for completion of the work, press button (1) or (2). The unit time of work can be regulated in a range of 1 to 120 minutes.



T8008857

## Turning off the Unit

The unit can be turned off by pressing button (5) again. The unit start-up signal will disappear from the display. The unit will turn itself off automatically if you have pre-programmed a time for this function.

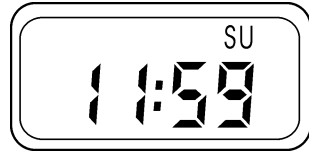

T8008858

## Programming and Control of the Unit Time of Work

With the unit off, the unit time of work can be set. Press the (1) button longer than 3 seconds - on the lit screen the symbol for unit time of work begins to flash. Pressing button (1) or (2) will set the desired time of work for the unit (in program 1, 2, 3 and with manual start up). After waiting 5 seconds the selected time is entered into the memory.

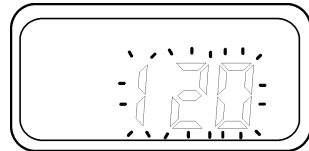

T8008846

## 6 Button Functions

### Setting of the Alarm Clock

The setting of the alarm clock is not connected with a day of the week. Press the (4) button four times, the symbol for the alarm clock will then begin to flash on the display.



T8008847

Press either the (1) or (2) button. The symbol for hours and minutes begins to flash.

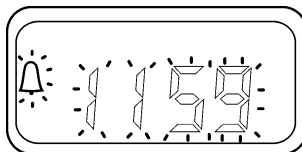

T8008848

To set the desired waking time press button (1) or (2). After waiting five seconds the waking time is entered in the memory. The symbol for the alarm clock remains illuminated on the display. The alarm sounds for 5 minutes. You can turn it off by pressing any button.

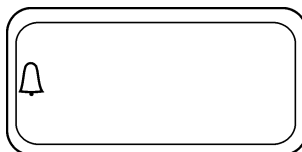

T8008849

### Check the Setting of the Alarm Clock

To check the setting of the alarm clock press the (4) button four times. When alarm clock symbol begins to flash on the display, the set time for waking can read. To cancel the setting of the alarm press the (4) button a fifth time. The symbol of the alarm disappears from the display.

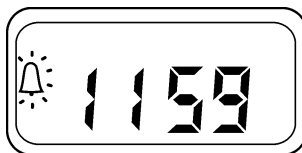

T8008847

### Programming Unit Start-up/Shut-down Time

Pressing the (4) button once, will allow checking the setting of the first program. Pressing the (4) button twice, will allow checking the setting of the second program. Pressing the (4) button three times, will allow checking the setting of the third program. Pressing the (4) button five times, exits the program.

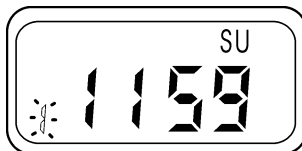

T8008854

## Error Messages

Messages about errors appear on the lit display screen in the form of codes. The error code descriptions can be found in the accompanying table.

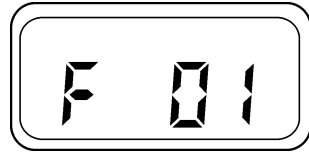

Code	Description
F01	No start up
F02	Interruption of the flame
F03	Tension too low
F04	Recognition of a foreign light in start up or run out
F05	Damage to flame sensor
F06	Damage to temperature sensor
F07	Damage to magnetic valve
F08	Damage to blower motor
F09	Damage to circulation pump
F10	Damage to/overheating of temperature limiter
F11	Damage to ignition spark generator
F12	Blocking of the appliance through repeated disturbance or repeated interruption of the flame





**VOLVO**

**Volvo Bus Corporation**

Göteborg, Sweden



# Driver's Handbook

## Cleaning and Maintaining the Paint Finish 9700

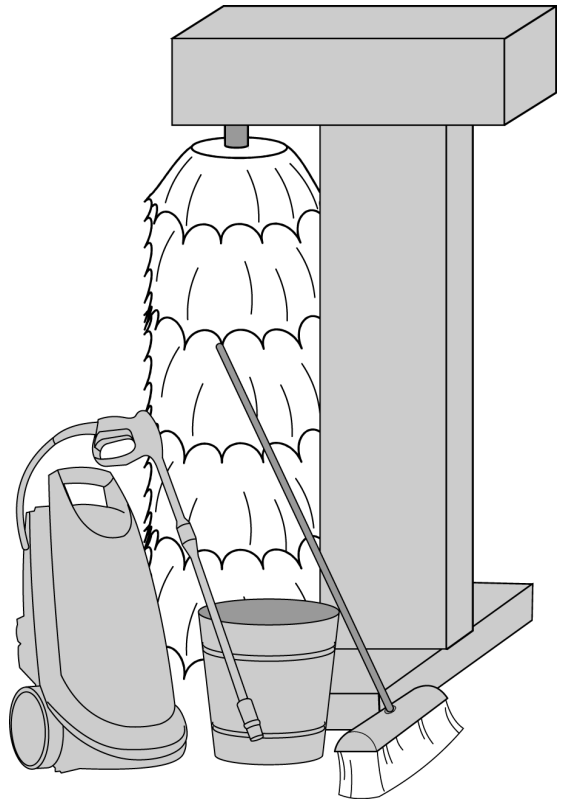

**VOLVO**



# Foreword

This manual contains information concerning the maintenance of the bus exterior finish. The information in this manual applies to vehicles built January 2009 and later. Please keep this manual in the vehicle at all times.

**Note:** Illustrations in this manual are used for reference only and may differ slightly from the actual vehicle. However, key components addressed in this document are represented as accurately as possible.

## Volvo Bus Corporation

Göteborg, Sweden

**Order number: PV776-20196937**

© 2009 Volvo Bus Corporation, Göteborg, Sweden

All rights reserved. No part of this publication may be reproduced, stored in retrieval system, or transmitted in any forms by any means, electronic, mechanical, photocopying, recording or otherwise, without the prior written permission of Volvo Bus Corporation

---

# Contents

<b>General Information</b> .....	1
Keeping the Vehicle Clean — Overview .....	1
<b>Washing and Aftercare</b> .....	3
Hand Washing, Painted Finishes .....	3
Washing in a Car Wash .....	5
Washing and Waxing .....	5
Waxing .....	6
Polishing .....	7
<b>Renovation of the Paint Finish</b> .....	8
Renovation .....	8
Professional Renovation .....	8
<b>Additional Information</b> .....	9
Stickers .....	9

---

# Safety Information

**IMPORTANT:** Before driving this vehicle, be certain that you have read and that you fully understand each and every step of the driving and handling information in this manual. Be certain that you fully understand and follow all safety warnings.

IT IS IMPORTANT THAT THE FOLLOWING INFORMATION BE READ, UNDERSTOOD AND ALWAYS FOLLOWED.

The following types of advisories are used throughout this manual:



## DANGER

Danger indicates an unsafe practice that could result in serious personal injury or death. A danger advisory banner is in **white** type on a **black** background with a **black** border.



## WARNING

Warning indicates an unsafe practice that could result in personal injury. A warning advisory banner is in **black** type on a **gray** background with a **black** border.



## CAUTION

Caution indicates an unsafe practice that could result in damage to the product. A caution advisory is in **black** type on a **white** background with a **black** border.

**Note:** Note indicates a procedure, practice, or condition that must be followed in order for the vehicle or component to function in the manner intended.

## Keeping the Vehicle Clean — Overview

The maintenance procedures described in the following instructions ensure the correct utilization and attractive appearance of the vehicle.

### Maintenance Objectives:

- To ensure the cleanliness and smart appearance of the bus from the outside
- To prolong the life of the vehicle's paint finish

### Equipment:

- Cloths, soft brushes, cotton cleaning cloths
- Protective clothing, rubber gloves
- Pressure washer
- Detergents, agents for washing painted surfaces, waxes, and polishing agents, as recommended by Authorized Volvo Service Outlets



T1008823

## 2 General Information

---

### Using Permitted Chemical Agents



#### **DANGER**

Before using a chemical agent, read the instructions governing its use, as well as the instructions on how to proceed in a hazard situation (e.g. contact of the chemical agent with the skin or the eyes)! Care must be taken when using chemical agents - perform all operations in protective clothing and protective gloves. Failure to do so may result in serious personal injury or death.

### Guidelines for Protection of the Environment

**Note:** The empty packages from chemical agents from washing, waxing or polishing, as well as fabric items used for cleaning and polishing, should be disposed of in an ecologically sound manner.

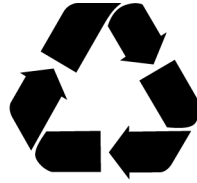

T1008770



#### **CAUTION**

The vehicle may only be washed in a place intended for this purpose. Failure to do so may result in components getting damaged.

## Hand Washing, Painted Finishes

**Note:** Never wash the vehicle in full sunlight, as the surface is then too hot, and this causes the washed surface to suddenly dry out.

- Mix a painted surface washing agent with hot water, in the correct proportions recommended by the manufacturer.
- Before washing, rinse the entire bus surface with water.

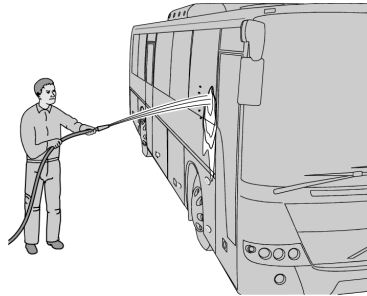

T1008816

- For washing, use the previously prepared solution of washing agent and a soft cloth or soft brush.

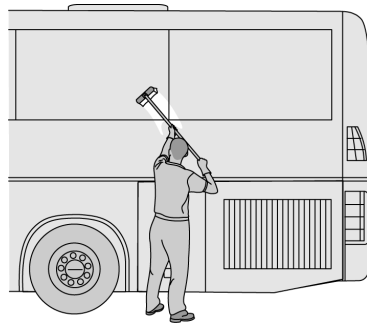

T1008817

- Immediately after washing, rinse the washed surface with clean water so that the used solution of washing agent does not dry on the vehicle surface. Rinse the vehicle with clean water from top to bottom, paying particular attention to depressions and joints. A pressure washer may be used to perform this.

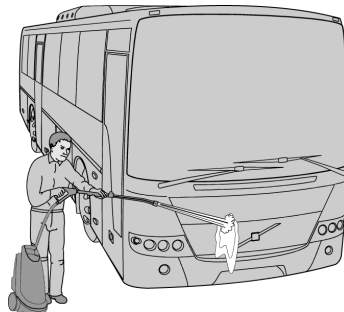

T1008818



## 4 Washing and Aftercare

- Wipe the water off the vehicle windows with a squeegee.

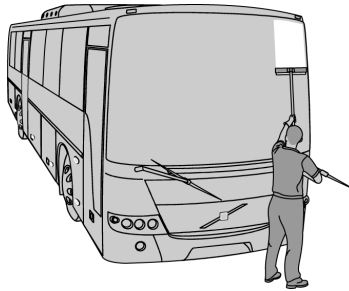

T1008819

- Dry the vehicles surface with a soft, dry, clean cloth (cleaning cloth).
- Leave the painted surfaces to dry out fully.

**Note:** Water used for washing the bus must have a pH from 6 to 8. The water used should be of the correct hardness – below 120ppm.

**Note:** Use a special cleaning cloth to wipe the vehicle down.

**Note:** Tar or asphalt can be removed from the painted surface using a special agent recommended by Authorized Volvo Service Outlets.

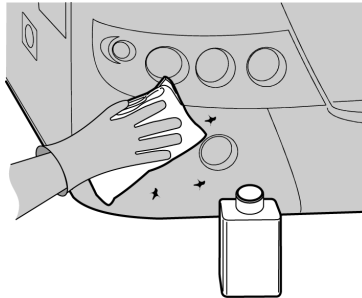

T1008821



### CAUTION

Do not use sharp metal instruments, such as a scraper or knife, to clean tar or asphalt from the painted surface! Failure to do so may result in damage to the vehicles surfaces.

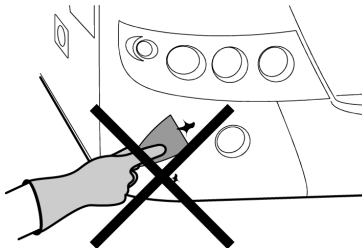

T1008822

## Washing in a Car Wash



### CAUTION

The bus should be washed in a car wash with vertical brushes that wash the vertical surfaces of the bus. Failure to do so may result in damage to exterior items such as; ventilation holes, hatches and roof antennas and the climate control modules.

When washing the vehicle in a car wash you should read the instructions for use and act in accordance with them.

## Washing and Waxing

**Note:** Some washing agents contain wax. In such cases, the vehicle should be washed in accordance with the instructions for hand washing and left to dry. In such cases, no additional waxing should be carried out.

After waxing, the windows should be de-greased using a cloth and screen washing agent.



T1008824

## 6 Washing and Aftercare

---

### Waxing

**Note:** Do not wax the vehicle within 90 days of its being supplied, as the finish may still be curing.

Waxing of the bodywork is regarded as a servicing item for the vehicle.

**Note:** Before waxing the paint finish, you should first wash the vehicle thoroughly.

- Do not put wax on a surface that cannot be easily buffed up.
- The optimum ambient temperature for waxing is 15-25<sup>o</sup>C (59-77<sup>o</sup>F).
- Apply the wax in thin layers.
- Rub out the wax coat you have applied with a soft cotton cloth to obtain a sheen.

**Note:** Never wax the vehicle in full sunlight as the surface will be too hot. The wax will be difficult to remove and may result in spots.



T1008820

## Polishing

**Note:** Polishing can be carried out after proper washing of the painted surface has not removed dirt or, if small scratches exist on the painted surface resulting in reduced sheen and dulling.

- Before beginning polishing, you should thoroughly wash the vehicle surface.
- For polishing, only use pastes and polishing agents recommended by Authorized Volvo Service Outlets. Always perform the work in accordance with the instructions provided with the agents being used.
- Small fragments of the painted surface can be buffed up by hand using a soft cloth.
- Polishing of larger elements can be done using an angle grinder and suitable polishing discs.

**Note:** Polishing is the ultimate way of removing scratches in the painted surface, but always remember that polishing causes a reduction in the thickness of the paint layer.



T1008825

## 8 Renovation of the Paint Finish

---

### Renovation

If the paint finish has been damaged, uncovering the paint primer or the panel (metal), the paint finish must be repaired.

To carry out small repairs:

- Wash the surface with a degreasing agent, an agent for removing wax, or white spirit.
- Remove the corroded surface using a fine-grade abrasive, and then collect up the dust and again degrease the surface.
- If the primer has been removed it should be reapplied.

### Professional Renovation

If deeper scratches and grazes to the paint finish surface cannot be removed using these methods described above, consult an Authorized Volvo Service Facility for further information.

- Protect the remaining surfaces - those that are not to be painted.
- Before painting, check that the surface is properly dried off.
- Apply paint to a small area to make sure that the color is well-matched.
- Apply a thin layer of paint, and if a second layer is needed, wait until the first has fully dried.
- After painting, buff up the surface.

### **Stickers**

No laminate-based decorative items and stickers should be attached to the painted surfaces for a minimum of 7 days after painting of the vehicle. The procedure for applying laminates to the surface should be in accordance with their instructions.



**VOLVO**

**Volvo Bus Corporation**

Göteborg, Sweden



# Driver's Handbook

## Replacing Belts B13R

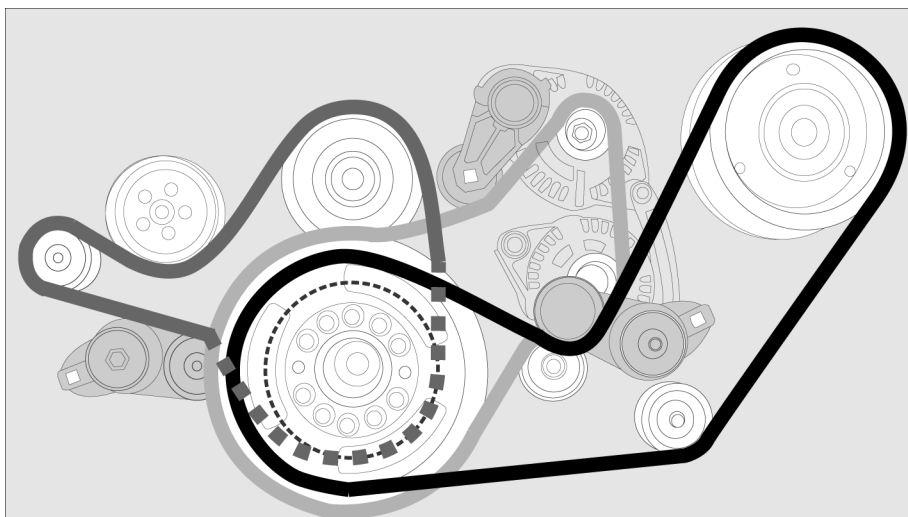

T0015452

**VOLVO**

# Foreword

This manual contains information intended to help the driver in replacing the engine's belts (compressor, coolantpump, alternators), when one of them is broken or damaged. The information in this manual applies to vehicles built January 2009 and later. Please keep this manual in the vehicle at all times.

**Note:** Illustrations in this manual are used for reference only and may differ slightly from the actual vehicle. However, key components addressed in this document are represented as accurately as possible.

## **Volvo Bus Corporation**

Göteborg, Sweden

**Order number: PV776-20198553**

© 2009 Volvo Bus Corporation, Göteborg, Sweden

All rights reserved. No part of this publication may be reproduced, stored in retrieval system, or transmitted in any forms by any means, electronic, mechanical, photocopying, recording or otherwise, without the prior written permission of Volvo Bus Corporation

---

# Contents

<b>Replacing Belts</b> .....	1
Introduction .....	1
Compressor Belt, Removal .....	1
Water Pump Belt, Removal .....	3
Alternators Belt, Removal .....	4
Engine Belts, Installation .....	5
Alternators Belt, Installation .....	6
Water Pump Belt, Installation .....	8
Compressor Belt, Installation .....	9

---

# Safety Information

**IMPORTANT:** Before driving this vehicle, be certain that you have read and that you fully understand each and every step of the driving and handling information in this manual. Be certain that you fully understand and follow all safety warnings.

IT IS IMPORTANT THAT THE FOLLOWING INFORMATION BE READ, UNDERSTOOD AND ALWAYS FOLLOWED.

The following types of advisories are used throughout this manual:



## DANGER

Danger indicates an unsafe practice that could result in serious personal injury or death. A danger advisory banner is in **white** type on a **black** background with a **black** border.



## WARNING

Warning indicates an unsafe practice that could result in personal injury. A warning advisory banner is in **black** type on a **gray** background with a **black** border.



## CAUTION

Caution indicates an unsafe practice that could result in damage to the product. A caution advisory is in **black** type on a **white** background with a **black** border.

**Note:** Note indicates a procedure, practice, or condition that must be followed in order for the vehicle or component to function in the manner intended.

## Introduction

This manual contains information intended to help the driver in replacing the engine's belts (compressor, coolant pump, alternators), when one of them is broken or damaged. To change the alternators belt (3), it is necessary to remove the compressor belt (1) and the water pump belt (2). To change the water pump belt (2), first remove the compressor belt (1).

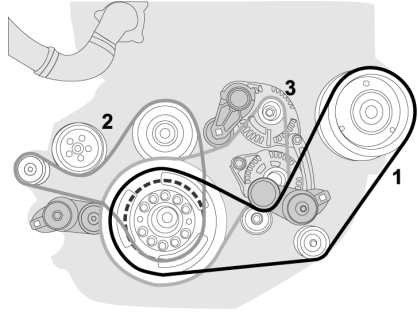

T0015453

## Compressor Belt, Removal

Turn off the power supply using the main switch

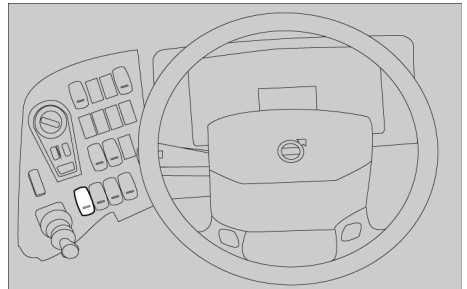

T0015454

Place the "Start Enable Switch" to the 0 position.

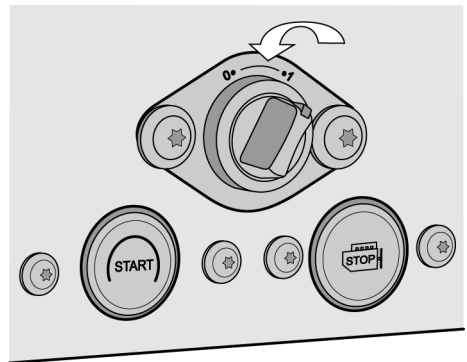

T0015455

## 2 Replacing Belts

---

Place the breaker bar inside the hole of the belt tensioner and pull clockwise to release the belt.

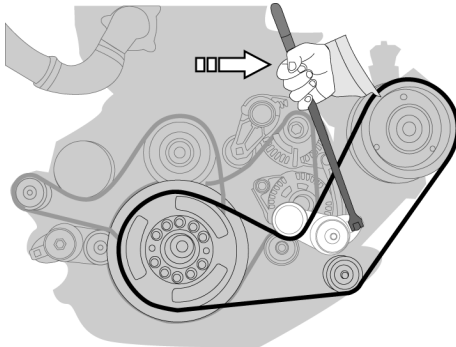

T0015457

Pull outward to unhook the belt.



T0015456

## Water Pump Belt, Removal

Place the breaker bar inside the hole of the belt tensioner, pull clockwise to release the belt.

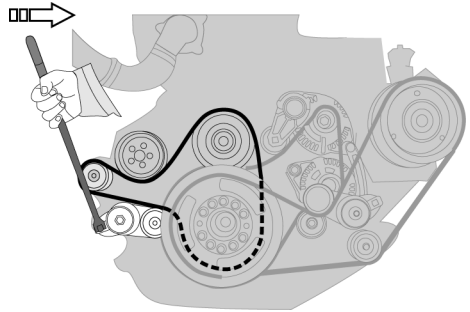

T0015458

Pull outward to free the belt from the pulley (1).

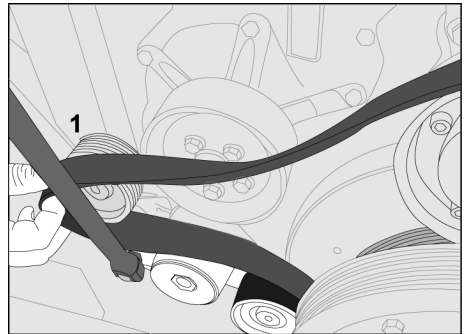

T0015459

Unhook the belt from the others pulleys and remove.

## 4 Replacing Belts

---

### Alternators Belt, Removal

Place the breaker bar inside the hole of the belt tensioner, pull clockwise to release the belt. Pull the belt out from the upper and lower pulley's.

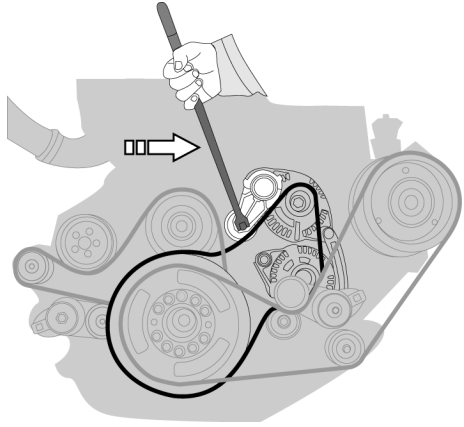

T0015460

Turn the belt and pass it through the damper and intermediate pulley, and pull down.

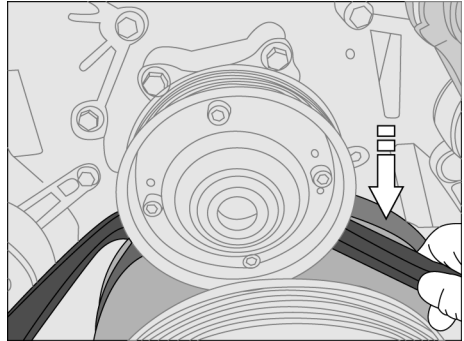

T0015461



Again, turn the belt and pass it through the intermediate and the crankshaft pulley and remove the belt.

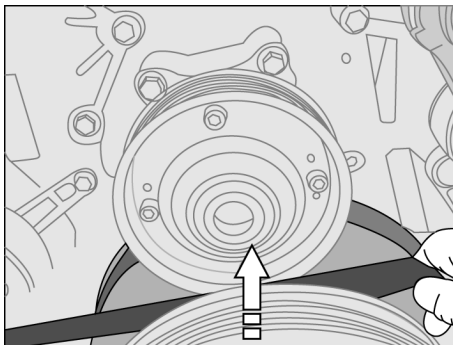

T0015462

## Engine Belts, Installation

To install the belts, perform the following sequence:

- 1 Alternators belt,
- 2 Water pump belt,
- 3 Compressor belt.

## 6 Replacing Belts

### Alternators Belt, Installation

Pass the belt through the damper and intermediate pulley. Move inwards and pull the belt up to go through the intermediate and crankshaft pulley. Position the belt into the damper pulley groove.

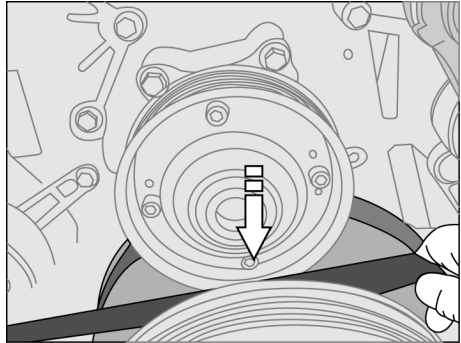

T0015463

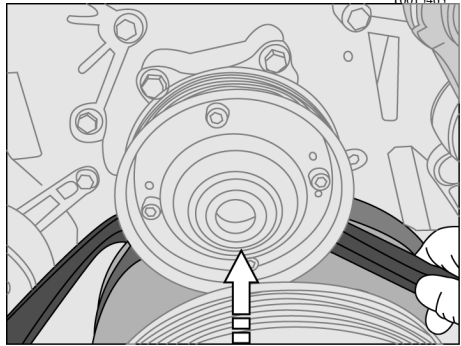

T0015464

Pull the belt towards the idler pulley (1) and position it over the pulley.



T0015465

Place the breaker bar inside the hole of the belt tensioner and pull clockwise. Position the belt over the upper alternator pulley (1).

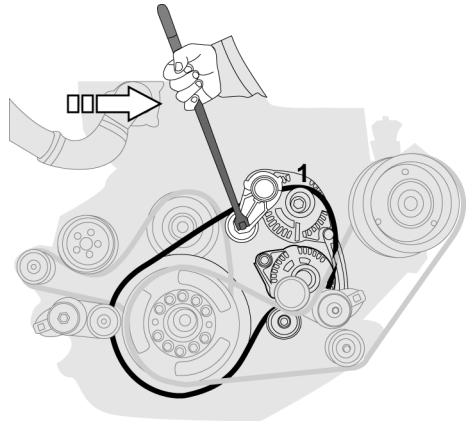

T0015466

Check and verify that the belt is under the belt tensioner (1).

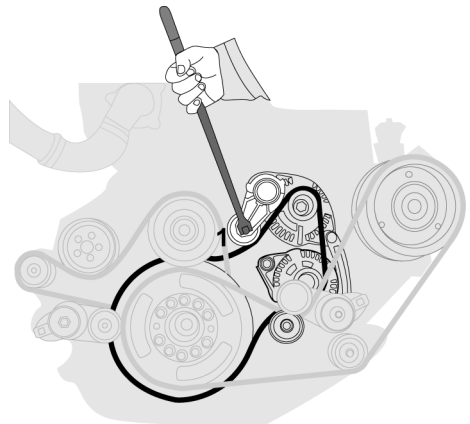

T0015467

## 8 Replacing Belts

### Water Pump Belt, Installation

Position the belt on the crankshaft pulley (1).

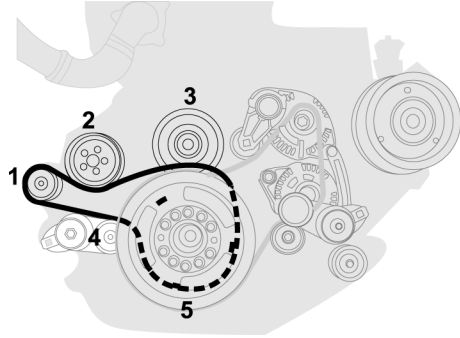

T0015468

Pass the belt under the water pump pulley (2). Place the breaker bar into the hole of the tensioner belt (4) and pull the belt up to position it over the intermediate pulley (3).

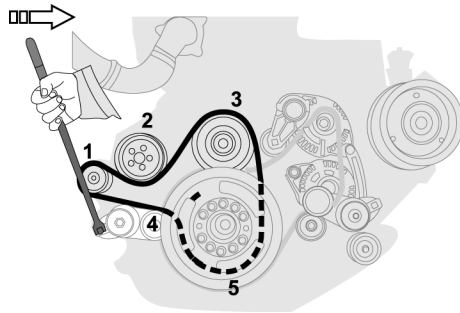

T0015469

## Compressor Belt, Installation

Position the belt over the crankshaft pulley (1), under the idler pulley (2) and place it around the compressor pulley (3).

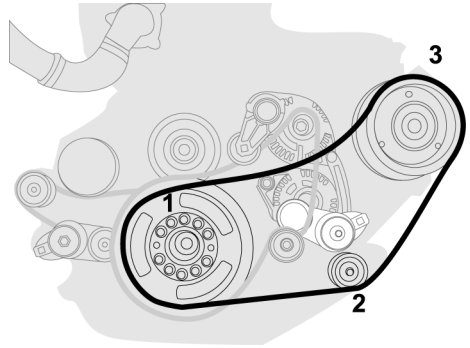

T0015470

Place the breaker bar inside of the hole of the belt tensioner, pull clockwise and push the belt in to the belt tensioner (4).

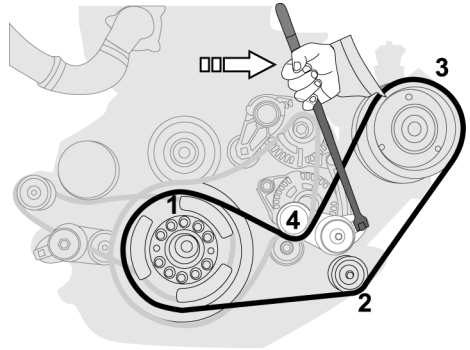

T0015471

**VOLVO**

**Volvo Bus Corporation**

Göteborg, Sweden

# **Driver's Handbook**

## **Replacement of Wheel and Air Springs**

B13R

**VOLVO**





# Foreword

This manual contains information concerning the replacement of the wheels and bellows. The information in this manual applies to vehicles built January 2009 and later. Please keep this manual in the vehicle at all times.

**Note:** Illustrations in this manual are used for reference only and may differ slightly from the actual vehicle. However, key components addressed in this document are represented as accurately as possible.

The National Highway Traffic Safety Administration (NHTSA) and Volvo Trucks North America should be informed immediately if you believe that the vehicle has a defect that could cause a crash, injury or death.

Contact NHTSA by calling the Auto Safety Hotline at 1 (888) 327-4236, by writing to NHTSA, U.S. Department of Transportation, Washington, DC 20590, by TTY at 1 (800) 424-9153, or visit their website at [www.nhtsa.dot.gov](http://www.nhtsa.dot.gov).

## Volvo Bus Corporation

Göteborg, Sweden

**Order number: 88993880**

©2010 Volvo Bus Corporation, Göteborg, Sweden

All rights reserved. No part of this publication may be reproduced, stored in retrieval system, or transmitted in any forms by any means, electronic, mechanical, photocopying, recording or otherwise, without the prior written permission of Volvo Bus Corporation

---

# Contents

<b>Replacement of Wheels.....</b>	<b>1</b>
Introduction.....	1
Wheel Replacement.....	1
Before Lifting the Vehicle.....	1
Lifting Point s.....	1
Lifting Point for Wheel Change.....	2
Lowering the Spare Wheel.....	4
Lifting with the Jack.....	8
Install the Spare Wheel.....	9
Install the Spare Wheel in the Mount Position.....	11
<b>Replacement of Air Springs.....</b>	<b>14</b>
Air Springs Replacement.....	14
Before Lifting the Vehicle.....	14
Lifting Point Decal.....	14
Lifting Point, Air Springs Replacement.....	15
Air Spring Replacement.....	16
<b>Recovery and Towing.....</b>	<b>17</b>
Towing.....	17
Release the Parking Brake with Air from the Bus Tires.....	19
<b>Tire Chains.....</b>	<b>20</b>
Tire chains.....	20



---

# Safety Information

**IMPORTANT:** Before driving this vehicle, be certain that you have read and that you fully understand each and every step of the driving and handling information in this manual. Be certain that you fully understand and follow all safety warnings.

IT IS IMPORTANT THAT THE FOLLOWING INFORMATION BE READ, UNDERSTOOD AND ALWAYS FOLLOWED.

The following types of advisories are used throughout this manual:

## **DANGER**

Danger indicates an unsafe practice that could result in serious personal injury or death. A danger advisory banner is in **white** type on a **black** background with a **black** border.

## **WARNING**

Warning indicates an unsafe practice that could result in personal injury. A warning advisory banner is in **black** type on a **gray** background with a **black** border.

## **CAUTION**

Caution indicates an unsafe practice that could result in damage to the product. A caution advisory is in **black** type on a **white** background with a **black** border.

**Note:** Note indicates a procedure, practice, or condition that must be followed in order for the vehicle or component to function in the manner intended.

---

## Introduction

This booklet is intended to help the driver about how to replace wheels and air springs properly

## Wheel Replacement

### Before Lifting the Vehicle

Make sure the bus is parked on a flat even surface that is not too soft. Turn on the hazard warning flashers. Place the warning triangle out.

Ask the passengers to leave the bus.

Verify that the parking brake is applied.

### Lifting Point s

The bus has special jack lifting points.

These jack lifting points are marked with decals.

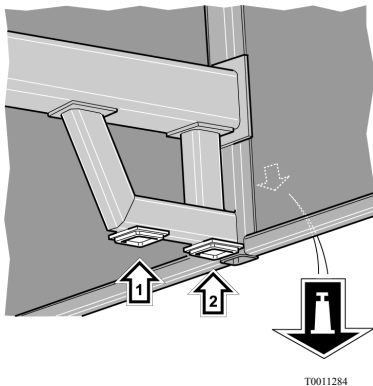

Example of lifting points.

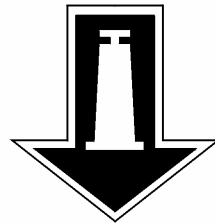

T0008922

Jack lifting point decal

## 2 Replacement of Wheels

### Lifting Point for Wheel Change

#### Two Axle Bus

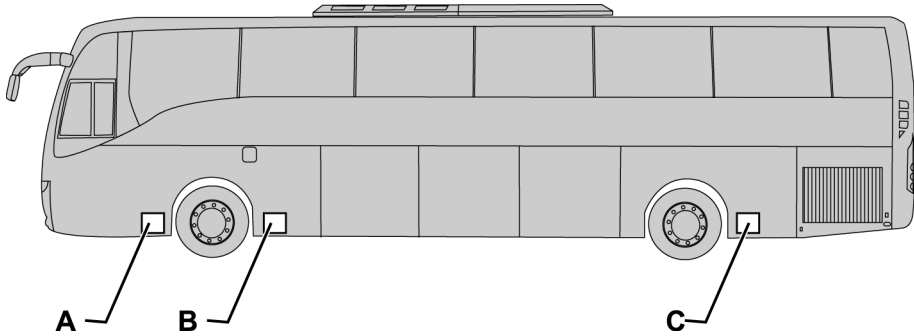

T0015373

Bus model	Chassis	Lifting point for front axle	Lifting point for rear axle
9700	B12B,B13	B	C

#### Three Axle Bus

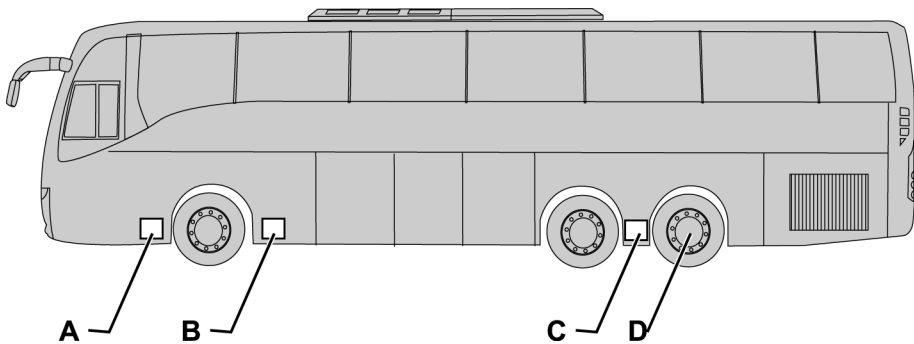

T0015374

Bus model	Chassis	Lifting point for front axle	Lifting point for driving axle	Lifting point for trailing axle
9700	B12B,B13	B	C	D Lift under the axle

## Lifting Point C

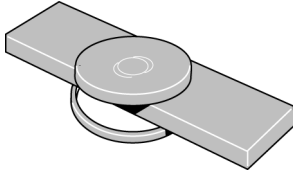

T0011285

Adapter for lifting air suspension beam

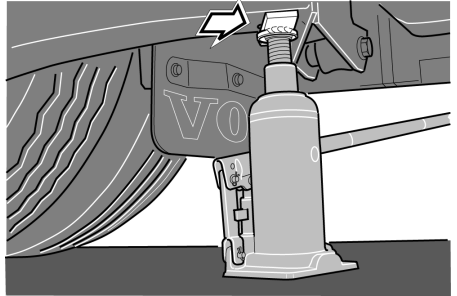

T0011286

Jack with adapter at lifting point C

## Lifting Point D



### **DANGER**

Exercise the greatest care when the trailing axle is raised. Be sure to position the jack properly so that the bus does not slide off the jack. Failure to do so may result in serious personal injury or death.

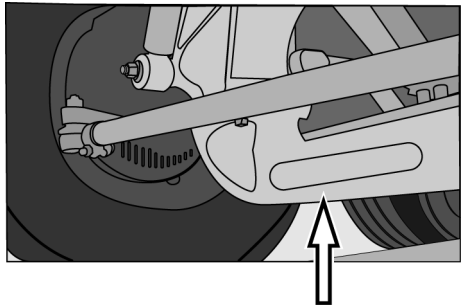

T0015389



## 4 Replacement of Wheels

### Lowering the Spare Wheel

The Volvo 9700 is equipped with a spare wheel located behind the front bumper. To remove the spare wheel, proceed as follows:

- Unscrew and remove the two support brackets (1,2) for the front under run protection brace.

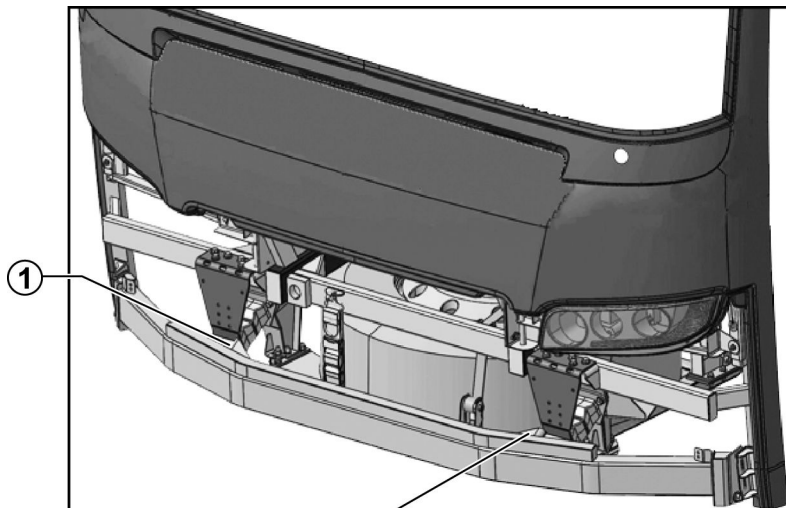

2

1

2

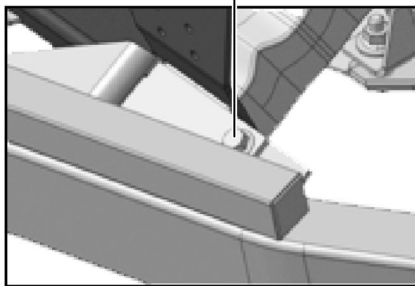
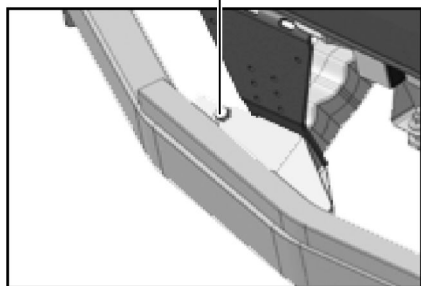

- Turn the front under run protection brace (1) downward.
- Check that the belts are tighten.
- Unscrew the security nuts (2,3)

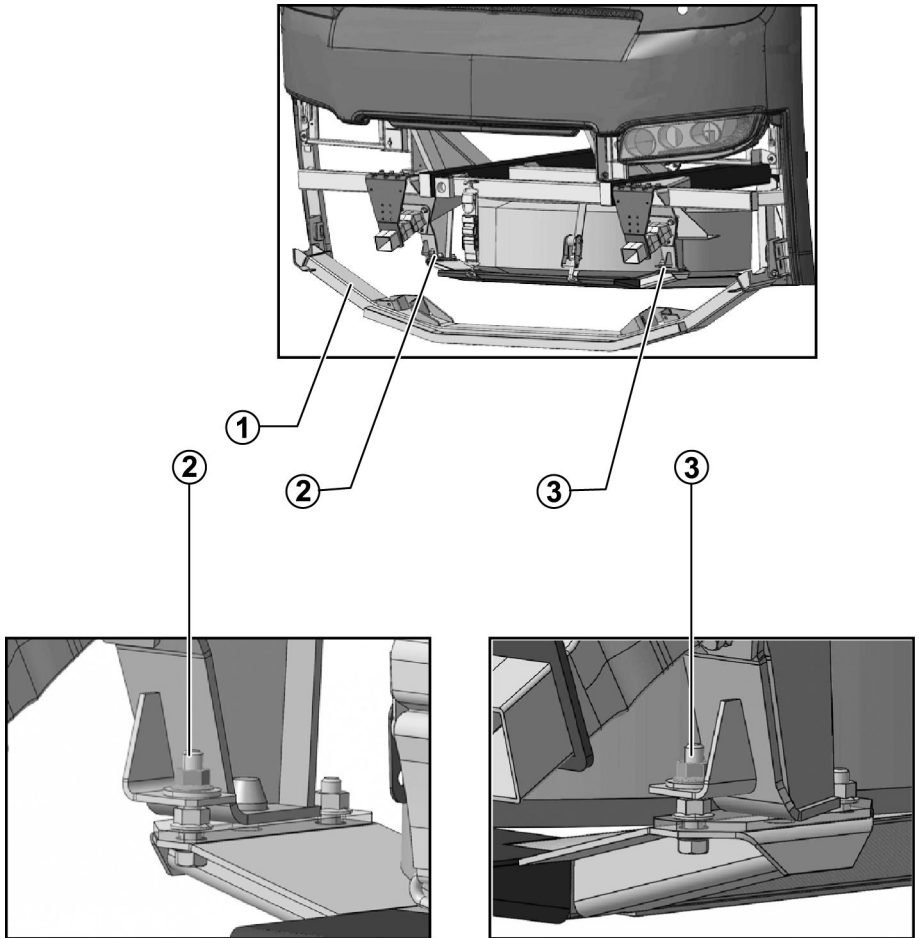

## 6 Replacement of Wheels

- Release and loosen the sling (1)

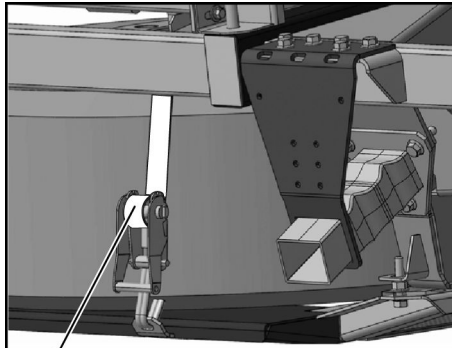

T0015377

- Loose sling slowly to down the spare wheel (2).

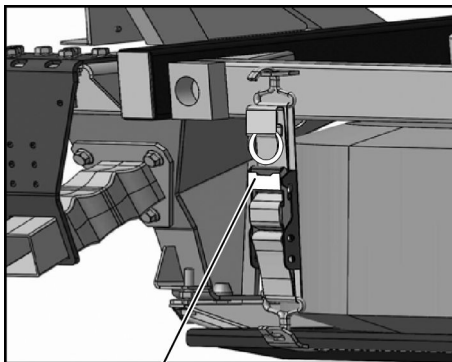

T0015378



## DANGER

Keep hands clear from the underside of the tire while removing it as they may get trapped between the tire and the front under run protection brace. Failure to do so may result in serious personal injury.

- Remove the spare wheel from the support frame.

**Note:** The sling may be used to pull out the spare wheel.

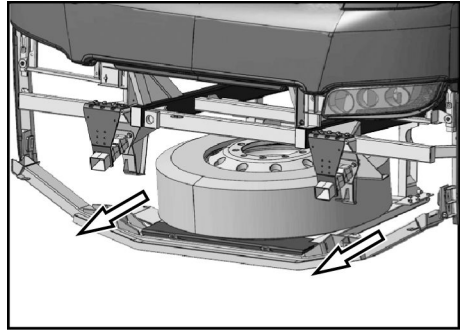

T0015379

## 8 Replacement of Wheels

---

### Lifting with the Jack

#### DANGER

Always ensure that the bus **cannot** move. Always place stop chocks behind and in front of the wheels. Failure to do so may result in serious personal injury or death.

#### DANGER

Place the jack so that you do not have your arm or other body part beneath the bus when lifting is performed. Failure to do so may result in serious personal injury or death.

#### DANGER

Never get under a vehicle that is lifted with only a jack. Support the vehicle with jack stands or other suitable equipment if it is necessary to get under it. Failure to do so may result in serious personal injury or death.

- 1 Establish where the lifting points are. Refer to “Lifting Point for Wheel Change”, page 2 .
- 2 Place the jack directly beneath the jacking point. Assure that the jack is placed on a hard even surface.

**Note: For the rear wheels, the jacking point can be a fixture on the chassis or sometimes an air suspension beam. Use the adapter if the bus is to be lifted on an air suspension beam.**

- 3 Loosen the wheel nuts about two turns.
- 4 Make sure that the bus cannot slide off the jack during the lift.
- 5 Lift the bus sufficiently for the wheel to leave the ground.
- 6 Remove the wheel nuts completely and then the wheel.

## Install the Spare Wheel

### Before Installation

Clean the hub and spare wheel. Perform a check of the wheel contact surface with dual wheels. Check that the wheel nut threads and nut thrust washers are not damaged. Grease them lightly if possible.

### Single Wheel

- 1 Lift the wheel up onto the hub so that it is centered. Install two diagonally opposite wheel nuts.
- 2 Install the remainder of the wheel nuts and tighten lightly.
- 3 Lower the bus and perform the final tightening of all nuts.

### Dual Wheels

Use two guide sleeves, **9996833**.

- 1 Install the guide sleeves. Lift the inner wheel onto the hub so that it is centered.
- 2 Lift up and install the outer wheel. Make sure the valve is placed on the opposite side to the inner wheel.
- 3 Remove the guide sleeves. Install two diagonally opposite wheel nuts and tighten lightly. Install the remainder of the wheel nuts and tighten them.
- 4 Lower the bus and perform the final tightening of all nuts.

# 10 Replacement of Wheels

---

## Tightening

Torque the nuts in the correct sequence, according to the tightening diagram.

Start by torquing them to **200 ± 8 Nm (148 ± 6 lb-ft)**. After that, angle torque in sequence to **90° ± 10°**.

**Note:** Re-torque the wheel nuts after about 200 km (124 mi).

**Note:** Check the tire pressure at the first service station along the road.

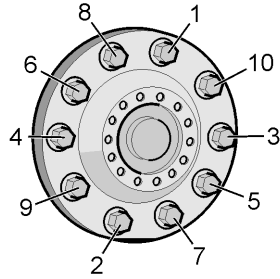

T0008985

## Check Tightening at a Workshop

The torque check should not be less than **670 ± 30 Nm (494 ± 22 lb-ft)** for any wheel nut.

**Note:** Re-torque the wheel nuts every sixth month whether the wheel has been removed or not.

## Install the Spare Wheel in the Mount Position

To install the spare wheel in the mount position proceed as follows:

- Put the spare wheel on the support frame (1).

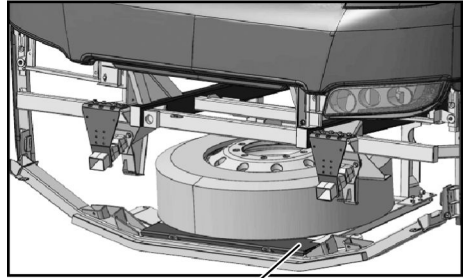

①

T0015380

- Install the sling on the left side and use the sling mechanism to lift the spare wheel up to its raised position.

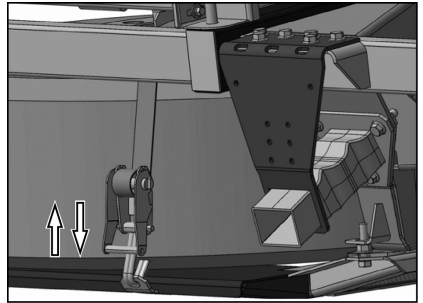

T0015381



## 12 Replacement of Wheels

- Install the belt on the right side and tighten the sling mechanism (1).

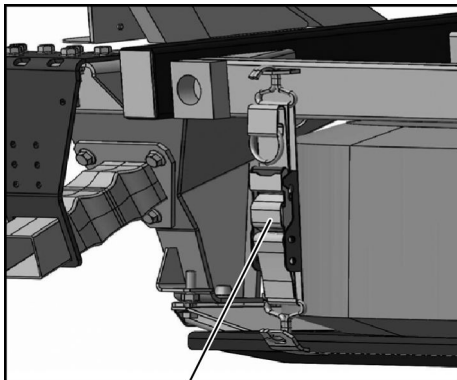

1

T0015382

- Install the two nuts and tighten them (2,3).

2

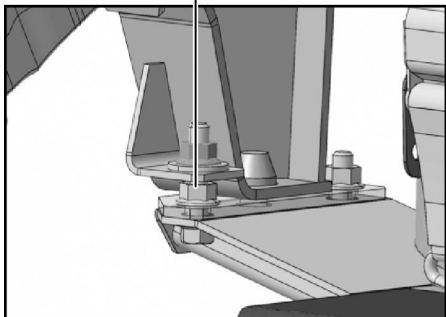

3

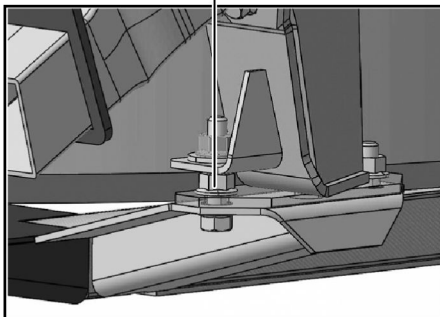

T0015383

- Rotate the front under run protection brace upward (1) and install the brackets with the screws (2,3).

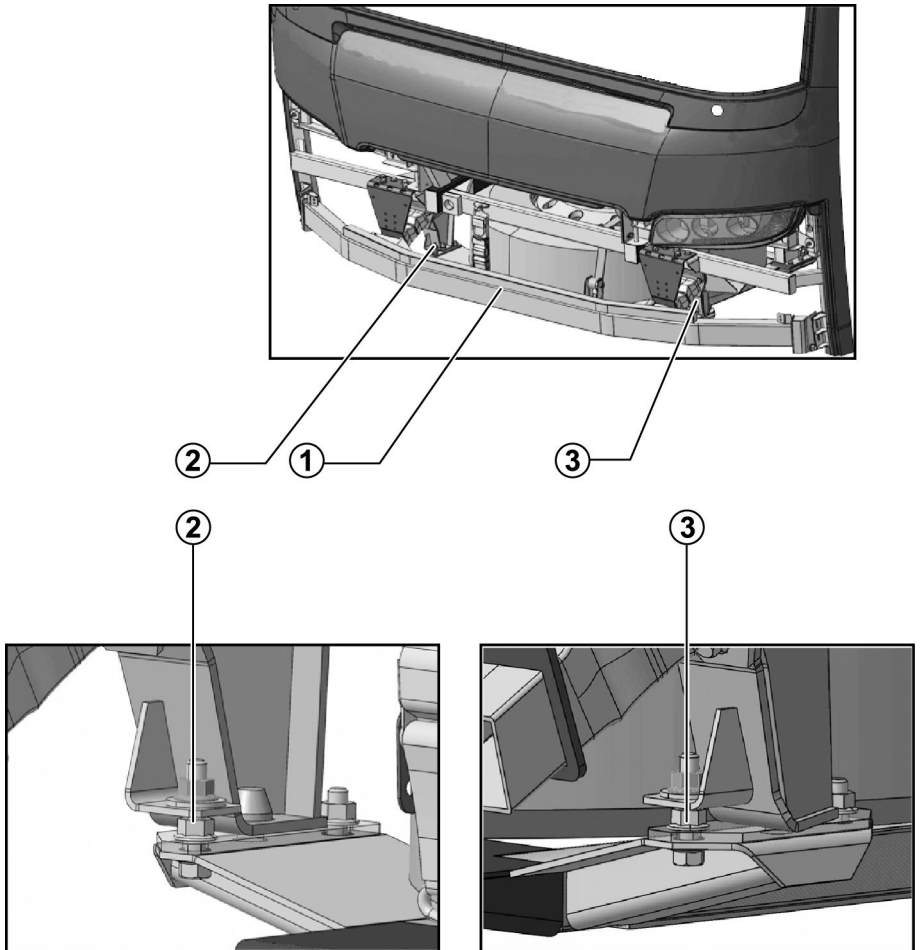

# 14 Replacement of Air Springs

---

## Air Springs Replacement

### Before Lifting the Vehicle

Make sure the bus is parked on a flat even surface that is not too soft. Turn on the hazard warning flashers. Place the warning triangle out.

Ask the passengers to leave the bus.

Verify that the parking brake is applied.

### Lifting Point Decal

The bus has special jack lifting points. These jack lifting points are marked with decals.



T0008922

## Lifting Point, Air Springs Replacement

### Two Axle Bus

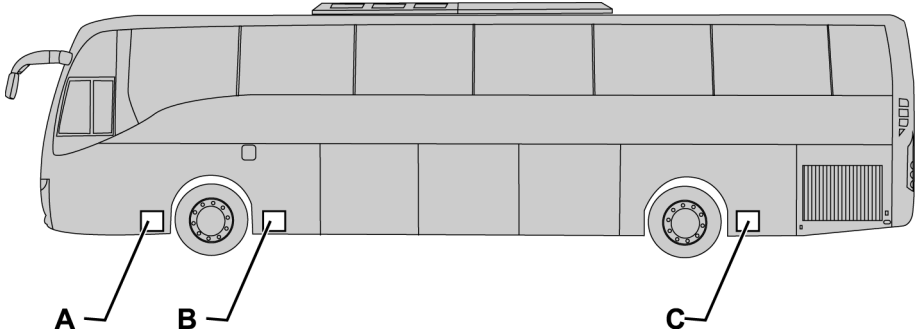

T0015373

Bus model	Chassis	Front lifting point	Rear lifting point
9700	B12B,B13	B	C

### Three-axle Bus

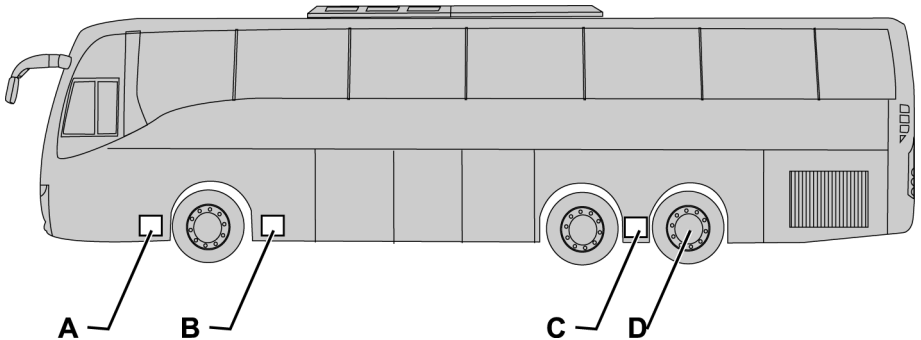

T0015374

Bus model	Chassis	Lifting point for front axle	Lifting point for driving axle	Lifting point for trailing axle
9700	B12B,B13	B	D	D

# 16 Replacement of Air Springs

---

## Air Spring Replacement

### DANGER

Always ensure that the bus **cannot** move. Always place stop chocks behind and in front of the wheels. Failure to do so may result in serious personal injury or death.

### DANGER

Place the jack so that you do not have your arm or other body part beneath the bus when lifting is performed. Failure to do so may result in serious personal injury or death.

### DANGER

Never get under a vehicle that is lifted with only a jack. Support the vehicle with jack stands or other suitable equipment if it is necessary to get under it. Failure to do so may result in serious personal injury or death.

- 1 Establish where the lifting points are. Refer to “Lifting Point, Air Springs Replacement”, page 15.
- 2 Place the jack directly beneath the jacking point. Assure that the jack is placed on a hard even surface.

**Note: For the rear wheels: The jacking point can be a fixture on the chassis or sometimes an air suspension beam. Use the adapter if the bus is to be lifted on an air suspension beam.**

- 3 Make sure that the bus cannot slide off the jack during the lift.
- 4 Lift the bus sufficiently to remove the air bellows.
- 5 Install a new air bellow and lower the bus.

## Towing



### CAUTION

Failure to disconnect the driveshaft, remove the drive axle shaft(s) or lift the drive wheels off the ground before towing or pushing the vehicle, can cause serious transmission damage and void the transmission warranty.



### CAUTION

Do not run the engine while towing as this may result in transmission damaged.

The power steering will not function with the engine off. Keep in mind that this will make the bus steering very heavy.

If towing is over a longer distance, checks should be performed to verify the bus parking brake does not gradually become applied, due to the air pressure in the system dropping. If the bus's engine cannot be started to supply sufficient pressure to the braking circuit, pressurization from an external source can be used. Behind the front hatch there is a valve to which an external air supply can be connected. If it is not possible to arrange external air pressure, the parking brake can be disengaged mechanically. For more information refer to the vehicle "Operators Manual".

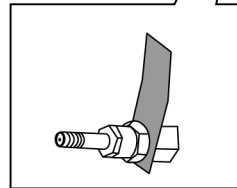
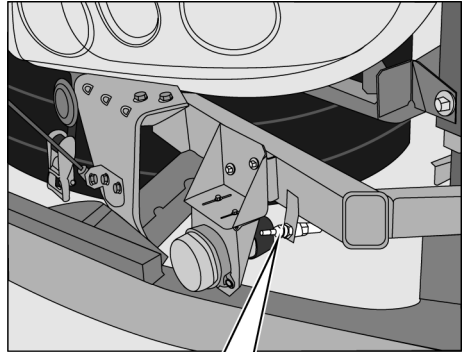

T0015390

# 18 Recovery and Towing

---

A tow bar connection should never be used for recovery (lifting), only when towing.

For more information about the connection points, refer to the vehicle “Operators Manual”.

- Use a tow bar, **NOT** a chain or rope. Install the tow bar to the correct attaching points on the vehicle.
- Ensure that the bus is attached to the towing vehicle before releasing the parking brake or removing the stop chocks from the wheels.

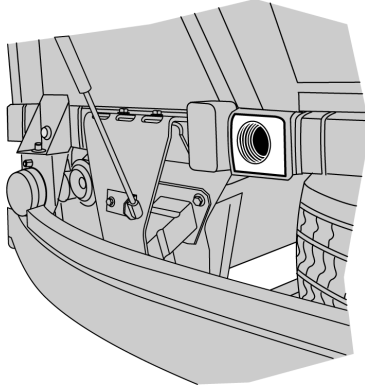

T8012390

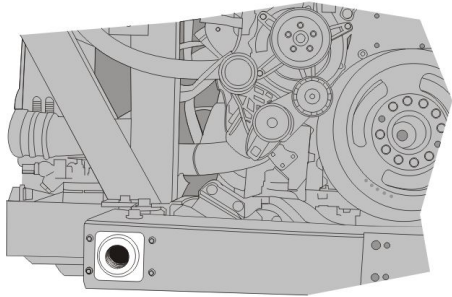

T8059309

## Release the Parking Brake with Air from the Bus Tires



### DANGER

Always ensure that the bus **cannot** move. Always place stop chocks behind and in front of the wheels. Failure to do so may result in serious personal injury or death.

**Note:** Instead of using the air pressure from tires, you can use an external supply of air compressed with at least 4 bars (58 psi).

- To prevent the bus from moving, chock the wheels.
- Connect the clamp end of the tire inflation hose to the valve of one of the tires.
- Move the parking brake control to the drive position.
- While pressing the other end of the tire inflation hose against the pump nipple, press in the blocking valve. Now the brake system is filled with the air from the tire. Filling can stop as soon as the air flow stops.

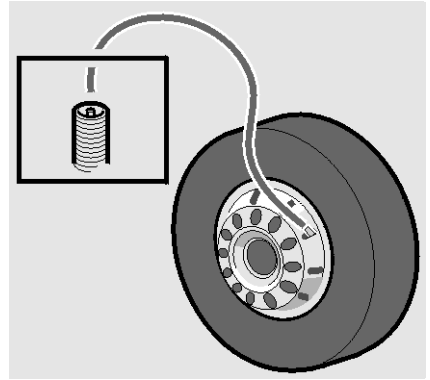

T0009182



# 20 Tire Chains

## Tire chains

Some jurisdictions may require their use in certain weather conditions or during certain months of the year.

To install the tire chains please follow the instructions from the tire chains manufacturer.

Following a small procedure to install the tire chains on a bus tire, just as general explanation.

- Laid Chains in front of Drive Axle Tire
- Make sure that the chain links are spread out
- Drive forward onto 1/3 of the chain distance.
- Loop one side of the chains over the tires then loop the opposite side and link them together.

**Note:** Keep the chains as tight as possible in order to avoid damage to the coachwork

**Note:** Refer to laws of each State for more information related to dates an areas were the tire chains should be used, and on what axle(s) must be installed.

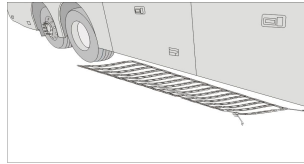

T8061480

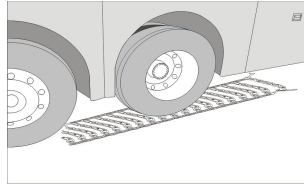

T8061481

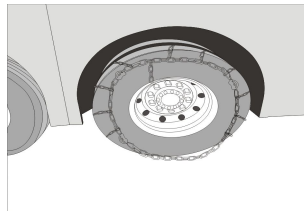

T8061482

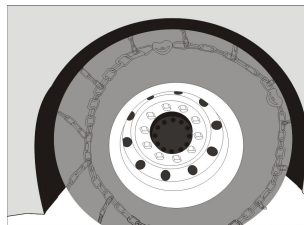

T8061483





**VOLVO**

**Volvo Bus Corporation**

Göteborg, Sweden

# Operating Instructions

## Manual Roof Hatch, Operation

9700 Bus

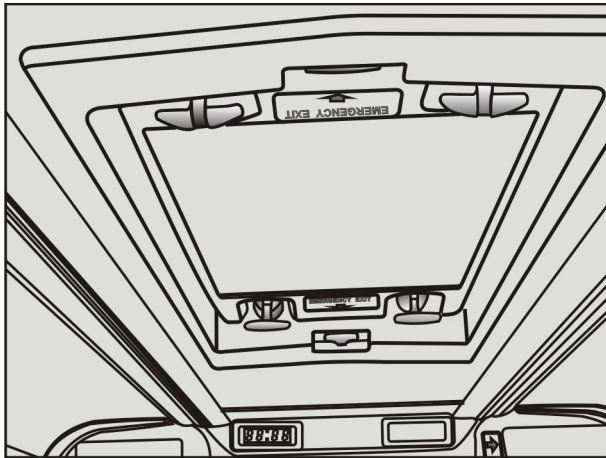

TR061505

**VOLVO**



# Foreword

This manual contains information concerning the operation and function of the Manual Roof Hatches mounted on the 9700 US/CAN.

Illustrations in this manual are used for reference only and may differ slightly from the actual vehicle. However, key components addressed in this document are represented as accurately as possible.

The National Highway Traffic Safety Administration (NHTSA) and Prevost should be informed immediately if you believe that the vehicle has a defect that could cause a crash, injury or death.

Contact NHTSA by calling the Auto Safety Hotline at 1(888) 327-4236, by writing to NHTSA, U.S Department of Transportation, Washington, DC 20590, by TTY at 1 (800) 424-9153, or visit their web site at [www.nhtsa.dot.gov](http://www.nhtsa.dot.gov).

## Volvo Bus Corporation

Göteborg, Sweden

**Order number: 88994761**

©2010 Volvo Bus Corporation, Göteborg, Sweden

All rights reserved. No part of this publication may be reproduced, stored in retrieval system, or transmitted in any forms by any means, electronic, mechanical, photocopying, recording or otherwise, without the prior written permission of Volvo Bus Corporation

---

# Contents

<b>Introduction</b> .....	1
Introduction .....	1
<b>Manual Roof Hatches</b> .....	2
Normal operation .....	2
Opening the Roof Hatch for an emergency .....	3
Reassembling the Roof Hatch .....	5
<b>Index</b> .....	9





---

# Safety Information

**IMPORTANT:** Before driving this vehicle, be certain that you have read and that you fully understand each and every step of the driving and handling information in this manual. Be certain that you fully understand and follow all safety warnings.

It is important that the following information be read, understood and always followed.

The following types of advisories are used throughout this manual:

## **DANGER**

Danger indicates an unsafe practice that could result in serious personal injury or death. A danger advisory banner is in **white** type on a black background with a **black** border.

## **WARNING**

Warning indicates an unsafe practice that could result in personal injury. A warning advisory banner is in **black** type on a **gray** background with a **black** border.

## **CAUTION**

Caution indicates an unsafe practice that could result in damage to the product. A caution advisory is in **black** type on a **white** background with a **black** border.

**Note:** Note indicates a procedure, practice, or condition that must be followed in order for the vehicle or component to function in the manner intended.

---

## Introduction

This booklet is intended to help the driver about how to operate properly and take care of the manual roof hatches.

## 2 Manual Roof Hatches

### Normal operation

#### Opening the hatch

When fresh air intake is required, e.g., when the Air Conditioning system is not working, it is possible to open the roof hatch from inside. To open the hatch procedure as follows:

- To unlock the roof hatch pull the two black handles towards center of the hatch
- Push up the roof hatch on the side were was unlocked
- Do the same for opposite end.

**Note:** Do not open the roof hatch when the Air Conditioning System is working.

#### Closing the hatch.

To close the hatch proceed as follows

- Take the two black handles and pull down
- Pull down again the roof hatch up to red tab appears, this means that the hatch is properly closed
- Do the same for the opposite end.

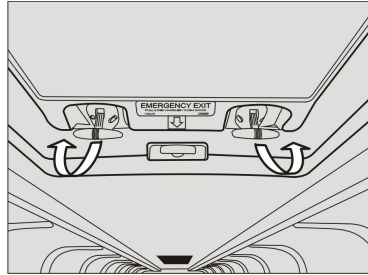

T8061506

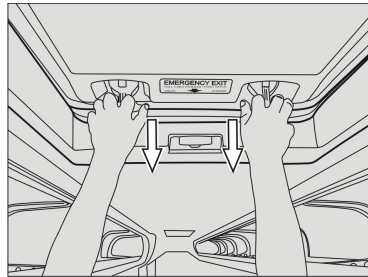

T8061507

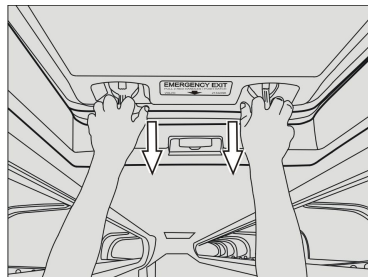

T8061507

## Opening the Roof Hatch for an emergency

### Interior

In case of an emergency, to open the hatch from the inside, perform the following steps:

- 1 Pull out the red emergency handle at both ends of the hatch.
- 2 Push out the roof hatch.

**Note:** When the roof hatch is opened because an emergency, a strip fixed at one end avoids that the hatch gets miss.

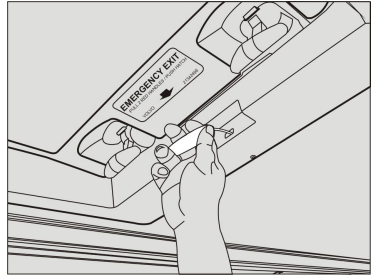

T8061509

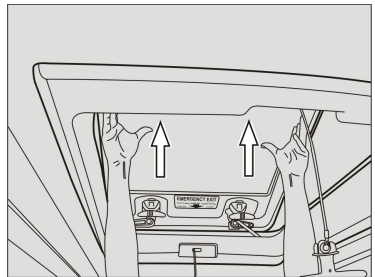

T8061510

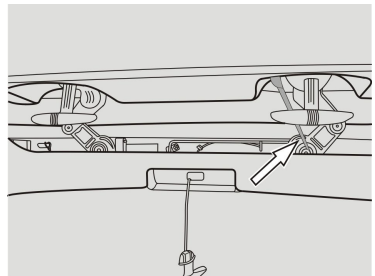

T8061511

## 4 Manual Roof Hatches

---

### Exterior

In case of an emergency, to open the hatch from the outside, perform the following steps:

- 1 Pull out both red emergency handles, located at the right side of the frame of the roof hatch
- 2 Pull out the roof hatch.

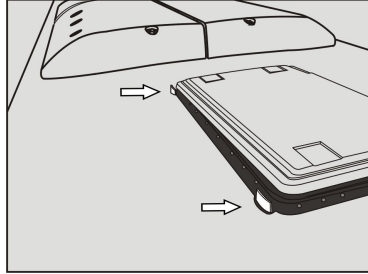

T8061298

## Reassembling the Roof Hatch

To reassembly the roof hatch after it was opened for an emergency, proceed as follows:

Put the roof hatch in a position were it will possible to have access to the mechanisms.

Pull up the black handle and pull down the mechanism, do it for each mechanism

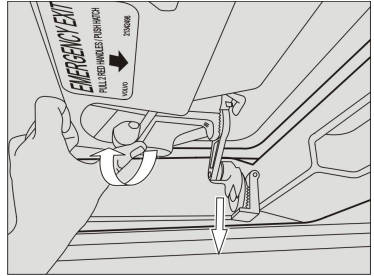

T8061512

Turn the lugs until the holes are horizontally

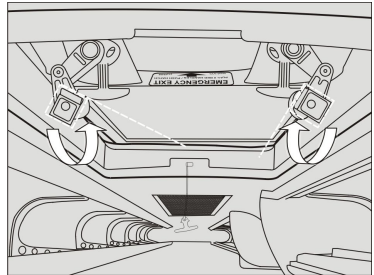

T8061513

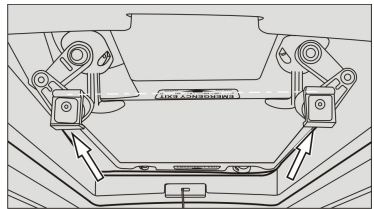

T8061514

Move the rod to allow to insert the roof hatch mechanisms in their position, do it for each end

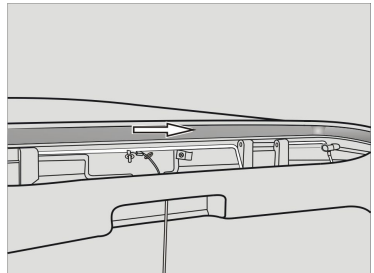

T8061515



## 6 Manual Roof Hatches

---

Place the mechanism into their positions (two by each end)

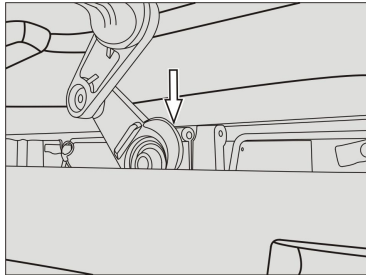

T8061516

Insert the larger end of the rod in the middle of the lug to use like a guide, do the same for the other end of the roof hatch

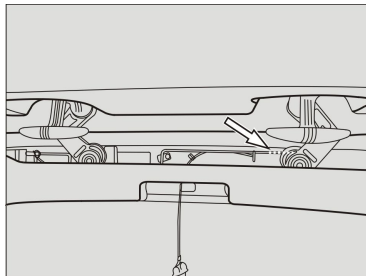

T8061517

Now, carefully insert both ends of the rod inside the holes of the frame and mechanisms

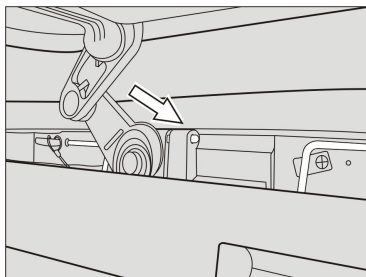

T8061568

When the rod is completely inserted in its position, secure it with the plastic bracket

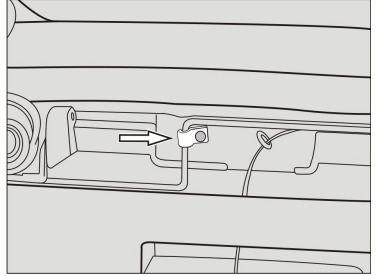

T8061518

Place the emergency red handles in their original positions



T8061519

Close the hatch as the normal closing procedure

**Note:** Always check that the roof hatch is close properly by checking the red tabs are visible.

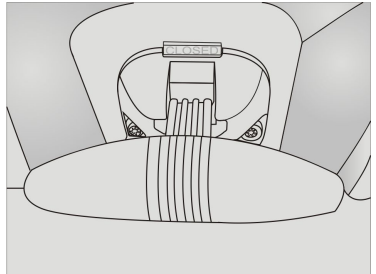

T8061520



---

## Index

### I

Introduction ..... 1

### M

Manual Roof Hatches ..... 2

### N

Normal operation ..... 2

### O

Opening the Roof Hatch for  
an emergency. .... 3

### R

Reassembling the Roof  
Hatch ..... 5

### S

Safety Information ..... 5



**VOLVO**

**Volvo Bus Corporation**

Göteborg, Sweden

# Operating Instructions

## Automatic Fire Suppression System

9700 Bus

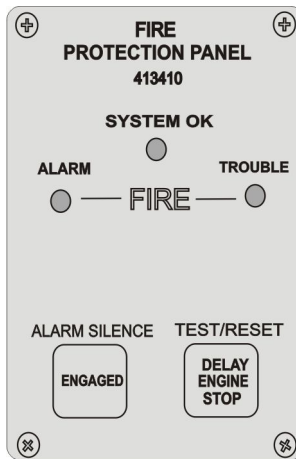

**VOLVO**





# Foreword

This manual contains information concerning the operation and function of the Anti Fire Supression System mounted on the 9700 US/CAN.

Illustrations in this manual are used for reference only and may differ slightly from the actual vehicle. However, key components addressed in this document are represented as accurately as possible.

The National Highway Traffic Safety Administration (NHTSA) and Prevost should be informed immediately if you believe that the vehicle has a defect that could cause a crash, injury or death.

Contact NHTSA by calling the Auto Safety Hotline at 1(888) 327-4236, by writing to NHTSA, U.S Department of Transportation, Washington, DC 20590, by TTY at 1 (800) 424-9153, or visit their web site at [www.nhtsa.dot.gov](http://www.nhtsa.dot.gov).

## **Volvo Bus Corporation**

Göteborg, Sweden

**Order number: 88996731**

©2010 Volvo Bus Corporation, Göteborg, Sweden

All rights reserved. No part of this publication may be reproduced, stored in retrieval system, or transmitted in any forms by any means, electronic, mechanical, photocopying, recording or otherwise, without the prior written permission of Volvo Bus Corporation

---

# Contents

<b>Introduction</b> .....	1
Introduction .....	1
General Information .....	1
<b>System Operation</b> .....	2
Protection Panel .....	2
Normal .....	3
Trouble .....	4
Fire Detector Activated .....	5
Delay AFSS button.....	5
Manual Activation switch .....	6
<b>Pre-Trip Inspection</b> .....	7
Pre-Trip Inspection.....	7
<b>Index</b> .....	9



---

# Safety Information

**IMPORTANT:** Before driving this vehicle, be certain that you have read and that you fully understand each and every step of the driving and handling information in this manual. Be certain that you fully understand and follow all safety warnings.

It is important that the following information be read, understood and always followed.

The following types of advisories are used throughout this manual:

## **DANGER**

Danger indicates an unsafe practice that could result in serious personal injury or death. A danger advisory banner is in **white** type on a black background with a **black** border.

## **WARNING**

Warning indicates an unsafe practice that could result in personal injury. A warning advisory banner is in **black** type on a **gray** background with a **black** border.

## **CAUTION**

Caution indicates an unsafe practice that could result in damage to the product. A caution advisory is in **black** type on a **white** background with a **black** border.

**Note:** Note indicates a procedure, practice, or condition that must be followed in order for the vehicle or component to function in the manner intended.

---

## Introduction

This booklet is intended to help the driver about how to operate properly and take care of the Automatic Fire Suppression System (AFSS).

## General Information

Automatic Fire Suppression System (AFSS) provides continuous monitoring of a vehicle's hazard areas. It responds to fires fueled by diesel, gasoline, oil, lubricants and other flammable liquids. If a fire is detected, the system will alert the driver with both audible and visual alarms while immediately shutting down the ventilation system to prevent smoke from entering the passenger area. A time delay allows the driver the capability to bring the vehicle to a safe stop prior to the activation of the fire extinguisher and engine shutdown. The system can also be manually activated immediately by the driver.

Automatic Fire Suppression System consists of three elements: Operator Controls, Detection, and Suppression.

## Hazards Protected

Engine Compartment

## 2 System Operation

---

### Protection Panel

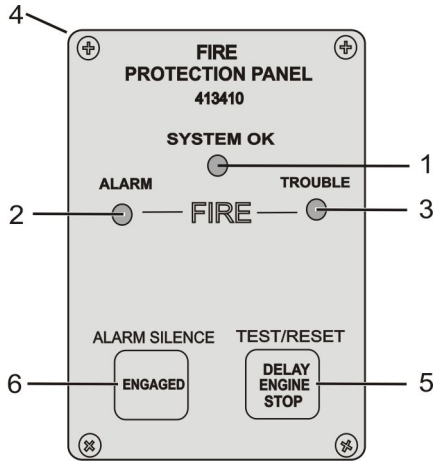

T8061693

The protection panel displays the current system status. The protection panel contains:

- 1 SYSTEM OK lamp
- 2 Fire ALARM lamp
- 3 TROUBLE lamp
- 4 Audio Alarm
- 5 TEST/RESET switch
- 6 ALARM SILENCE switch

## Normal

The “SYSTEM OK” lamp indicates power is on the system and that there are no trouble conditions present.

**Note:** If battery power to the system is low, the “SYSTEM OK” lamp will blink

Depressing the “TEST/RESET” switch tests the protection panel lamps and audio alarm. The “ALARM SILENCE” switch will disable the audio alarm.

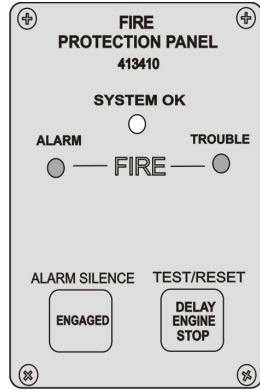

T8061694



## 4 System Operation

---

### Trouble

The “TROUBLE” lamp blinks if there is a fault in the Detection Circuit due to wiring problem or sensor problem. If the fault is in the extinguisher circuitry the will illuminates solid and means that are a wiring problem or the extinguisher is discharged..

When the “TROUBLE” lamp is on, the “SYSTEM OK” lamp will be off and the audible alarm will sound intermittently.

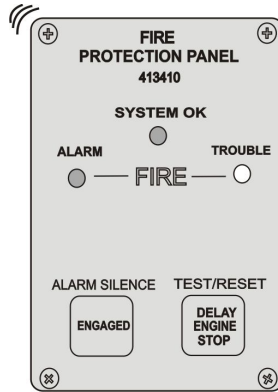

T8061695

## Fire Detector Activated

When a fire detector automatically detects a fire, the audio alarm activate and the fire “ALARM” lamp illuminates solid

**Note:** If the vehicle is not safe to stop (i.e. on railtracks, in intersection) depress the DELAY ENGINE STOP button to delay 15 seconds that engine shutdowns and the extinguisher discharges; if is needed more time you need to deprees the button again and before the previous 15 seconds of delay finished.

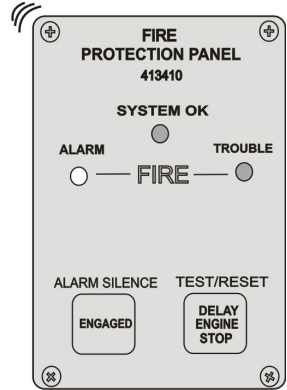

T8061696

## Delay AFSS button

If it is not possible to find quickly a safe place to stop the bus, use delay AFSS button instead of the Delay Engine Stop button (described above), then, depress the delay AFSS button to stop the activation of the system up to find a safe place to stop the bus, then press to the original position the Delay AFSS button to allow that engine stops and extinguisher discharges.

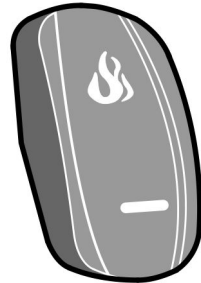

T8062854

## 6 System Operation

---

### Manual Activation switch

The manual activation switch allows immediate system activation (extinguisher discharge and engine shutdown) by the operator at any time.

Activation of the switch is accomplished by twisting and pulling the tamper seal to remove, lifting the cover and pressing and holding the red “FIRE” button for more than half a second.

After the manual activation switch has been activated, the fire “ALARM” lamp blinks and the audio alarm activates. The lamp will remain blinking until power is cycled to the system.

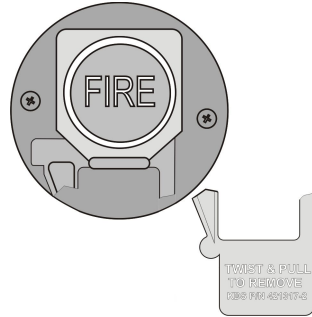

T8061697

## Pre-Trip Inspection

Before starting a trip, first check the Control Panel by pressing the “TEST/RESET ”switch, and the following should occur:

- All lamps and switches should be illuminated.
- Audible Alarm should sound

As a second step, verify the tamper seal on the manual discharge switch is intact and access to the switch is unobstructed.

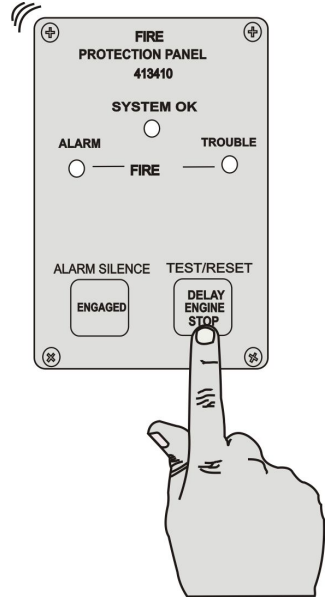



---

## Index

### D

Delay AFSS button..... 5

### F

Fire Detector Activated..... 5

### G

General Information..... 1

### H

Hazards Protected..... 1

### I

Introduction ..... 1

### M

Manual Activation Switch..... 6

### N

Normal..... 3

### P

Pre-Trip Inspection ..... 7

Protection Panel..... 2

### S

Safety Information ..... 5

System Operation ..... 2

### T

Trouble ..... 4



**VOLVO**

**Volvo Bus Corporation**

Göteborg, Sweden



# Operating Instructions

## Tire Pressure Monitoring System

9700 Bus

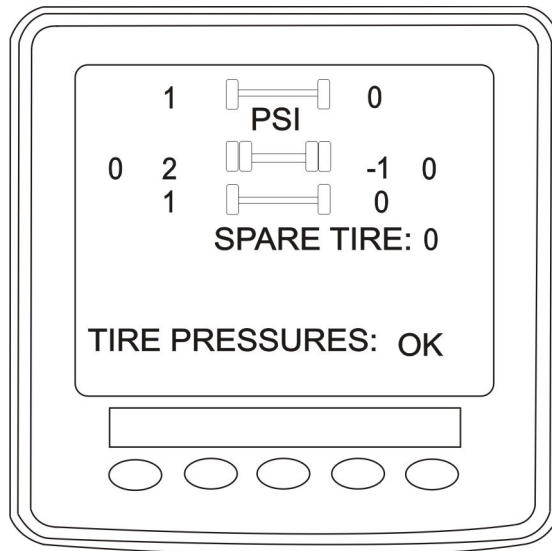

**VOLVO**



# Foreword

This manual contains information concerning the operation and function of the Tire Pressure Monitoring System mounted on the 9700 US/CAN.

Illustrations in this manual are used for reference only and may differ slightly from the actual vehicle. However, key components addressed in this document are represented as accurately as possible.

The National Highway Traffic Safety Administration (NHTSA) and Prevost should be informed immediately if you believe that the vehicle has a defect that could cause a crash, injury or death.

Contact NHTSA by calling the Auto Safety Hotline at 1(888) 327-4236, by writing to NHTSA, U.S Department of Transportation, Washington, DC 20590, by TTY at 1 (800) 424-9153, or visit their web site at [www.nhtsa.dot.gov](http://www.nhtsa.dot.gov).

## **Volvo Bus Corporation**

Göteborg, Sweden

**Order number: 88998506**

©2010 Volvo Bus Corporation, Göteborg, Sweden

All rights reserved. No part of this publication may be reproduced, stored in retrieval system, or transmitted in any forms by any means, electronic, mechanical, photocopying, recording or otherwise, without the prior written permission of Volvo Bus Corporation

---

# Contents

<b>Introduction</b> .....	1
Introduction .....	1
General Information .....	1
<b>System Operation</b> .....	2
TPMS Display .....	2
Operation .....	3
Start-up .....	3
Pre-Trip Check .....	4
Spare tire .....	7
Post Trip Operation .....	8
<b>Index</b> .....	11



---

# Safety Information

**IMPORTANT:** Before driving this vehicle, be certain that you have read and that you fully understand each and every step of the driving and handling information in this manual. Be certain that you fully understand and follow all safety warnings.

It is important that the following information be read, understood and always followed.

The following types of advisories are used throughout this manual:

## **DANGER**

Danger indicates an unsafe practice that could result in serious personal injury or death. A danger advisory banner is in **white** type on a black background with a **black** border.

## **WARNING**

Warning indicates an unsafe practice that could result in personal injury. A warning advisory banner is in **black** type on a **gray** background with a **black** border.

## **CAUTION**

Caution indicates an unsafe practice that could result in damage to the product. A caution advisory is in **black** type on a **white** background with a **black** border.

**Note:** Note indicates a procedure, practice, or condition that must be followed in order for the vehicle or component to function in the manner intended.

---

## Introduction

This booklet is intended to help the driver about how to operate properly and take care of the Tire Pressure Monitoring System (TPMS).

## General Information

Tire Pressure Monitoring System (TPMS) is a sensing device designed to identify and display tire operating data and activate an alert or warning when pressure or temperature irregularities are detected.

**Note:** It is the responsibility of the driver to react promptly and with discretion to alerts and warnings. Abnormal tire inflation pressures should be corrected at the earliest opportunity.



## 2 System Operation

---

### TPMS Display

The TPMS display knows where the sensors are located. It receives the raw temperature and pressure readings from the TPMS receiver, it reads several signals from the vehicle and does the calculation required to generate the various screens.

When no readings have been received for a tire location or when the received data correspond to a parameter range defined as unavailable, then the reading is considered as not available and appears as two dash lines “ — ”

The TPMS display is initially configured for current bus 9700.

The TPMS display is also configured with several other parameters, including threshold levels for the alarms.

The TPMS display power supply turns OFF when the ignition key is switched OFF.

## Operation

The system will monitor all vehicle tires plus the spare tire when a spare is supplied. And is configured for 8 tires total: two tires in front axle, 4 tires on drive axle and 2 tires on tag axle

## Start-up

When turning the ignition switch to ON, two screen appears on the TPMS Display. Dash lines are displayed meaning that no pressure data have been received by the display..

As illustrated, the pressure readings will appear replacing the dash lines as the TPMS display starts to receive pressure data from the TPMS receiver. It can take 1 minute to get all pressure readings updated since the sensors transmit at a one minute interval.

The user can flip through the menus.

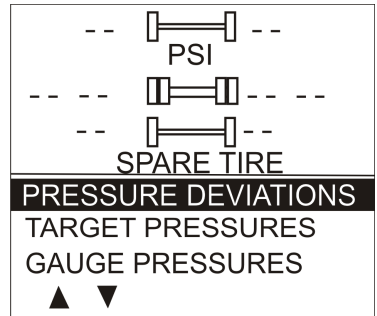

TS061960

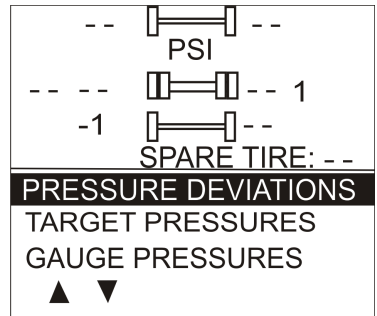

TS061961

## 4 System Operation

### Pre-Trip Check

When one of the preconditions defined to start the pre-trip check is met, the TPM display enters into a pre-trip check routine and the screen shown below appears. The preconditions to initiate the pre-trip are: Park brake removed Or No activity on the display menu keys for a defined time (Key pressed timeout).

After a pretrip, the display is in a “drive” mode with bottom menu replaced by the alarm status. The display remains in this mode until one of the following occurs: A menu key is touched while the park brake is applied, or the park brake does a transition from released to park brake applied.

During the pre-trip check, the pressure readings for the different wheels become all available.

The pre-trip check ends, either when: the pressure readings have been received for all running wheels or the pre-trip check maximum time has elapsed. It was selected to provide sufficient time for all wheel sensors to wake-up and send a first reading.

The pre-trip check is aborted and the bottom menu reappears if the park brake was active and the user press one of the menu keys.

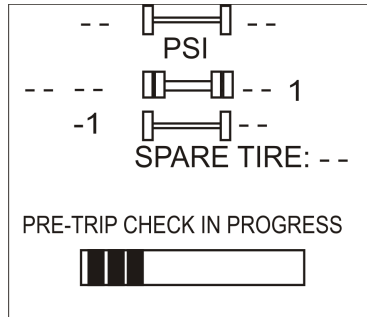

T8061962

Upon completion of the pre-trip check, the TPMS display will come up with one of the following screens:

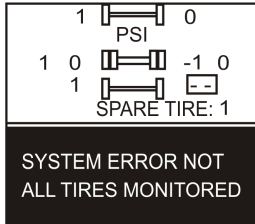
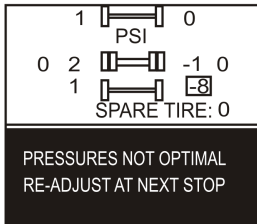
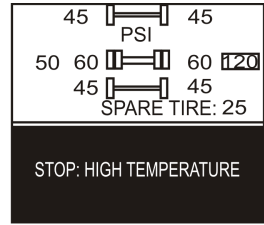
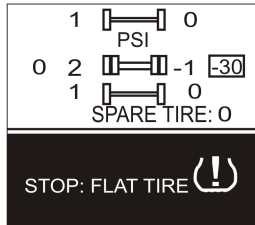
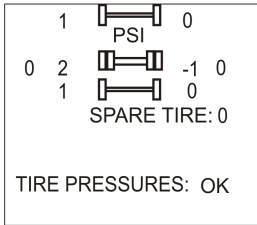

T8061963

A rectangle around each pressure/temperature reading of the tires that have an issue is blinking to draw the attention to the defective tires.

In the case of multiple errors at the same time, the highest priority error is displayed at the bottom. “Flat Tire” has the highest priority followed by “High Temperature”, “Not all tires monitored” and “Tire pressure not Optimal”.



## DANGER

Continuing to operate the bus with a flat tire or a tire with excessively high temperatures may result in a blowout or tire fire. This could result in loss of vehicle control, vehicle crash and serious personal injury or death.

## 6 System Operation

---

To get the driver's attention to the alarms, the bottom section of the screen where the alarm message appears will blink to reverse contrast at the following rate: 0.5 sec normal contrast, 0.5 sec reverse contrast. Pressing any key will acknowledge the alarms that are considered as non critical and stop the blinking of these alarms message for the remaining of the trip. The non critical alarms are: "Pressure not optimal" and "Not all tires monitored". The "flat tires" and "high temperature" alarms are critical and will keep blinking even when a key is pressed. If a different alarm occurs, blinking will start again. The blinking rectangle around the pressure/temperature readings is not impacted by the acknowledgement and keeps blinking until the error condition disappears.

The spare tire does not contribute to alarms and so never blinks.

On the road, the TPMS display shows one of the 5 previous screens.

In the event of a temperature alarm, the display switches automatically to temperature readings.

The driver can also press any of the menu keys to momentary switch the display to temperature readings. In this case, the temperature reading appears for 15 seconds and the display returns to pressure.

The switching to temperature by pressing a key does not take place if there is an acknowledgeable alarm active, since in this case pressing the key does acknowledge the alarm.

The switching to temperature does not take place either if there is an alarm of Temperature or Flat Tire.

The switching to temperature works when the bottom message indicates either: Tire Pressure OK, Pressure Not Optimal non flashing or not all tires monitored non flashing. When the switch is done to temperature readings, the bottom portion of the screen is not affected and still shows the status message.

**Note:** High temperature is not likely to occur during the pre-trip.

The pressure and temperature readings are continuously updated with the displayed readings of the wheel having issues blinking. The bottom line message is automatically updated to the highest priority alarm prevailing. There is a hysteresis on the alarm levels to assure that the error conditions do not flicker ON and OFF.

On the occurrence of an alarm, a beep will sound. The alarm beep could be turned OFF in the alarm settings menu.

## Spare tire

The spare tire is monitored but it is not taken into account when setting the bottom alarm messages. This is to prevent unnecessary alarms that would otherwise occur, if for example, the spare tire is removed from a vehicle.

The user will have the possibility to check the pressure of the spare tire by accessing the TPMS display menu. For vehicles that have no spare tires, the title “spare tire:“ will still appear on the screens but the pressure will remain with two dash lines at all time.

After the manual activation switch has been activated, the fire “ALARM” lamp blinks and the audio alarm activates. The lamp will remain blinking until power is cycled to the system. until power has been cycled to the system.

# 8 System Operation

## Post Trip Operation

When parking the vehicle (park brake applied), the TPMS display keep the drive mode display active. The driver can press any keys to get the bottom lines showing the status information replaced with the menus.

The pressure readings are still displayed and updated as new readings are received and the readings are blinking if not within the optimum pressure range.

From this point the user can scroll through the menus to get more detailed information and inflate/deflate the tires to bring them back to their optimum target pressures. Scrolling through these menus is also available prior to departure.

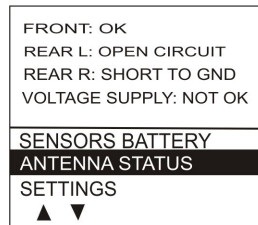
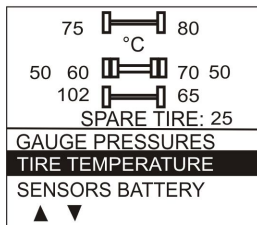
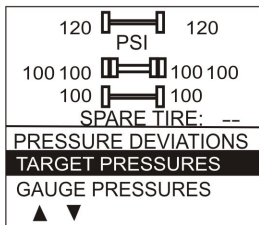
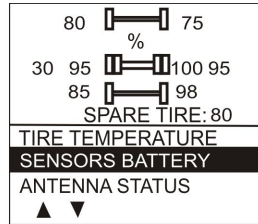
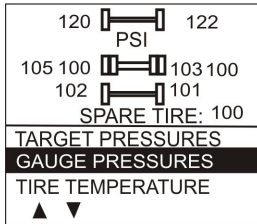
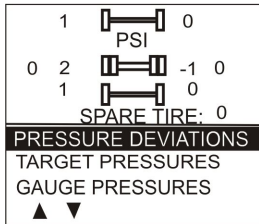

The display remains in this mode with the menus appearing at the bottom until the pre-trip check sequence starts again.

Scrolling down below the Battery life menu will show the Settings menu. Highlighting the Settings and pressing OK allows entering the settings menu.

Highlighting the Exit menu and pressing OK exits the settings and come back to the pressure display mode.

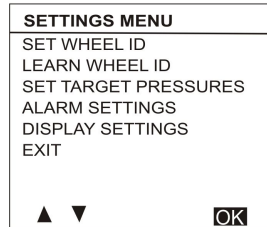
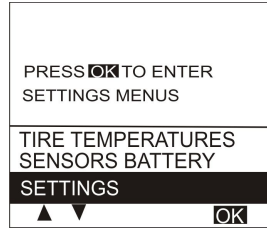





## Index

### G

General Information ..... 1

### I

Introduction ..... 1

### O

Operation ..... 3

### P

Post Trip Operation ..... 8

Pre-Trip Check..... 4

### S

Safety Information ..... 5

Spare tire ..... 7

Start-up ..... 3

System Operation ..... 2

### T

TPMS Display ..... 2



**VOLVO**

**Volvo Bus Corporation**

Göteborg, Sweden

# Driver's Handbook

## A/C Controller

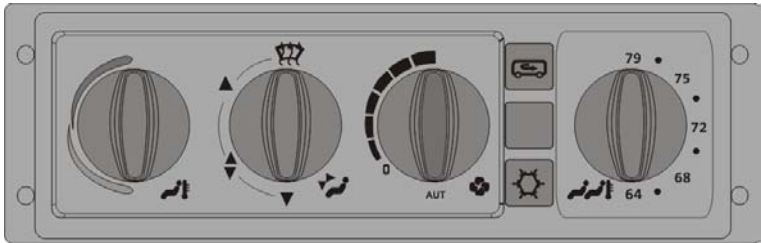

T8061140

**VOLVO**



# Foreword

This manual contains information concerning the operation and function A/C controls. The information in this manual applies to vehicles built January 2010 and later. Please keep this manual in the vehicle at all times.

**Note:** Illustrations in this manual are used for reference only and may differ slightly from the actual vehicle. However, key components addressed in this document are represented as accurately as possible.

**Volvo Bus Corporation**

Göteborg, Sweden

**Order number: 88999203**

©2009 Volvo Bus Corporation, Göteborg, Sweden

All rights reserved. No part of this publication may be reproduced, stored in retrieval system, or transmitted in any forms by any means, electronic, mechanical, photocopying, recording or otherwise, without the prior written permission of Volvo Bus Corporation

---

# Contents

.....	1
Introduction.....	1
General View.....	1
Controller Functions.....	2





---

# Safety Information

**IMPORTANT:** Before driving this vehicle, be certain that you have read and that you fully understand each and every step of the driving and handling information in this manual. Be certain that you fully understand and follow all safety warnings.

IT IS IMPORTANT THAT THE FOLLOWING INFORMATION BE READ, UNDERSTOOD AND ALWAYS FOLLOWED.

The following types of advisories are used throughout this manual:



## DANGER

Danger indicates an unsafe practice that could result in serious personal injury or death. A danger advisory banner is in **white** type on a **black** background with a **black** border.



## WARNING

Warning indicates an unsafe practice that could result in personal injury. A warning advisory banner is in **black** type on a **gray** background with a **black** border.



## CAUTION

Caution indicates an unsafe practice that could result in damage to the product. A caution advisory is in **black** type on a **white** background with a **black** border.

**Note:** Note indicates a procedure, practice, or condition that must be followed in order for the vehicle or component to function in the manner intended.

---

## Introduction

This booklet is intended to help the driver about how to operate properly and take care of the A/C controller.

The A/C controller allows control of the temperature inside the bus as well as, control of additional equipment (such as the recirculation air damper and air conditioning).

## General View

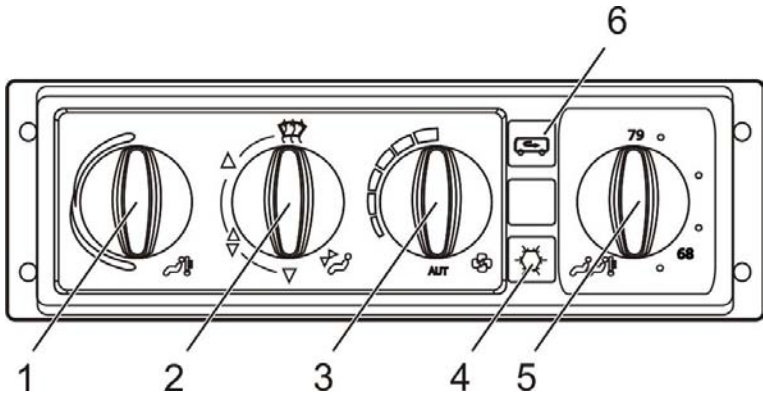

T8062094

- |   |  |   |                                      |
|---|--|---|--------------------------------------|
| 1 | Temperature, driver's compartment.           | 4 | Air conductioning.                   |
| 2 | Direction of air flow, driver's compartment. | 5 | Temperature, passengers' compartment |
| 3 | Defroster fan speed.                         | 6 | Fresh Air/ Recirculation             |

## Controller Functions

- 1 Sets desired temperature in driver's compartment to a value between 64°F (18°C) and 79°F (26°C).
- 2 Sets the direction of the air flow into the driver's compartment.
  - A) to the windscreen (defroster mode)
  - B) to the windscreen
  - C) to the driver and floor
  - D) to the floor.

**Note:** While the defroster mode is active, warm air is blown, no matter position of knob 1.

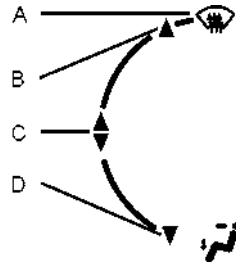

T8010433

- 3 Sets the desired fan speed

**Note:** In "AUT" position the fan speed is controlled automatically.



T8028666

- 
- 4 Switches on the air conditioning. A backlit button indicates the air conditioning is on.



T3028692

- 5 Sets the desired temperature in the passengers' compartment to a value between 64°F (18°C) and 79°F (26°C).

- 6 Switches on the recirculation. A backlit button indicates the recirculation is switched on.



T3028690



**VOLVO**

**Volvo Bus Corporation**

Göteborg, Sweden



# Operating Instructions

## Safety seat belts

9700 Bus



**VOLVO**

# Foreword

This manual contains information concerning the operation and function of the safety seat belts mounted on the 9700 US/CAN.

Illustrations in this manual are used for reference only and may differ slightly from the actual vehicle. However, key components addressed in this document are represented as accurately as possible.

The National Highway Traffic Safety Administration (NHTSA) and Prevost should be informed immediately if you believe that the vehicle has a defect that could cause a crash, injury or death.

Contact NHTSA by calling the Auto Safety Hotline at 1(888) 327-4236, by writing to NHTSA, U.S Department of Transportation, Washington, DC 20590, by TTY at 1 (800) 424-9153, or visit their web site at [www.nhtsa.dot.gov](http://www.nhtsa.dot.gov).

## **Volvo Bus Corporation**

Göteborg, Sweden

**Order number: 89008115**

©2011 Volvo Bus Corporation, Göteborg, Sweden

All rights reserved. No part of this publication may be reproduced, stored in retrieval system, or transmitted in any forms by any means, electronic, mechanical, photocopying, recording or otherwise, without the prior written permission of Volvo Bus Corporation

---

# Contents

<b>Introduction</b> .....	1
Introduction.....	1
<b>Seat belts</b> .....	2
Safety seat belt .....	2
Operating two points safety belt.....	3
Operating three points safety belt .....	5
<b>Maintenance</b> .....	6
Inspection .....	6
Important Facts About Safety Belts in Buses.....	10
<b>Index</b> .....	11



---

# Safety Information

**IMPORTANT:** Before driving this vehicle, be certain that you have read and that you fully understand each and every step of the driving and handling information in this manual. Be certain that you fully understand and follow all safety warnings.

It is important that the following information be read, understood and always followed.

The following types of advisories are used throughout this manual:

## **DANGER**

Danger indicates an unsafe practice that could result in serious personal injury or death. A danger advisory banner is in **white** type on a black background with a **black** border.

## **WARNING**

Warning indicates an unsafe practice that could result in personal injury. A warning advisory banner is in **black** type on a **gray** background with a **black** border.

## **CAUTION**

Caution indicates an unsafe practice that could result in damage to the product. A caution advisory is in **black** type on a **white** background with a **black** border.

**Note:** Note indicates a procedure, practice, or condition that must be followed in order for the vehicle or component to function in the manner intended.



## Introduction

This booklet is intended to help the driver about how to operate properly and take care of the safety seat belts.

Safety belts assemblies installed in this vehicle meet FMVSS 209, type 1 and type 2. They are recommended for all persons weighing over 50 lb ( 25 kg).

A child restrain system should also be provided for each child weighing 50 lb (25 kg) or less. It should meet the requirements of “FMVSS213 Child Restraint System”. Carefully read and follow all manufacture’s instructions on installation and use. Make certain the child remains in the restraint system at all times while the vehicle is in motion.



### **DANGER**

Safety belts must be properly worn at all times by the driver and all passengers while the vehicle is in motion. Failure to do so can result in serious personal injury or death in the event of sudden stop or collision.



### **DANGER**

Fasten the safety belt before starting to drive. Trying to fasten the safety belt while the vehicle is moving may lead to an accident, causing serious personal injury or death.

## 2 Seat belts

---

### Safety seat belt

Using the seat belts is the single most important thing that can be done for protection in the event of a crash.

Safety belts must be properly worn at all times. Before adjusting or fastening the safety belt, move the seat forward or rearward and adjust the seat height as necessary. Sit erect and adjust the seat cushion and seat back for a comfortable driving position. In the event of a collision, a correct driving position maximizes the effectiveness of the safety belt. There are both Federal and State laws governing the use of safety belts. As laws differ from state to state, make yourself familiar with the current rules.

Tether straps are installed on all suspension/type seats. Tether straps help secure the seat to the floor and are intended to restrain the seat and safety belt in case of an accident or sudden stop. The tether straps are not adjustable and do not need any adjustment.

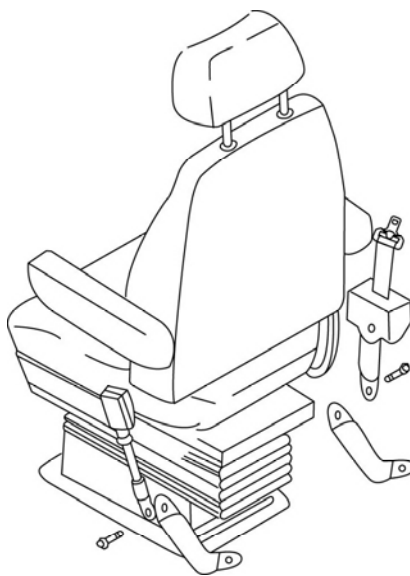



## Operating two points safety belt

You should properly adjust your seat first before fastening the seat belt. To fasten the safety belt, pull the belt out from the retractor and insert the latch into the buckle. Verify proper lock of the latch by pulling on the latch.

The buckle will click when the latch is engaged. *Always confirm that the latch is engaged by tugging on the belt at the latch.*

After confirming the latch is engaged, adjust the lap belt cross the hips below the stomach. When properly adjusted the lap belt should be snug against the body.

The lap portion of the safety belt should be worn low across the pelvic region (hip bone) and adjusted snugly. A push button on the buckle is used to release the safety latch by pushing in the button release on the buckle.

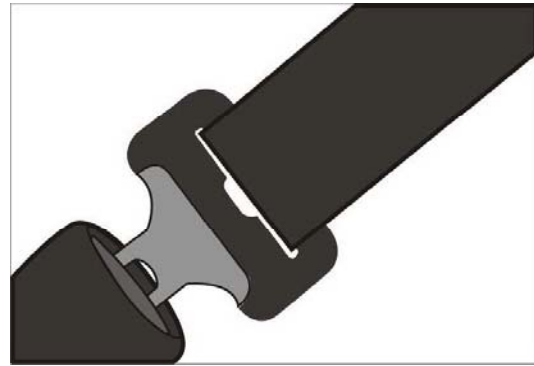

T8056398

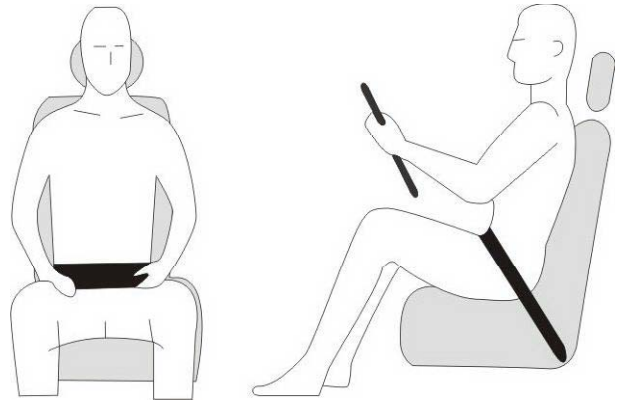

T8056402



**DANGER**

Never adjust the lap belt across the abdomen.

## 4 Seat belts

---

The buckle portion of the safety belt system is different depending on the seat option chosen. The national standard and comfort seat has separate buckle that is attached to a floor anchor by seat strap. This seat strap is not adjustable, and does not need to be adjusted.

The buckle will click when the latch is engaged. *Always confirm that the latch is engaged by tugging on the belt at the latch.*

After confirming the latch is engaged, adjust the belt so that the belt should be snug against the body.

The buckle for the seat is bolted to the front division wall.

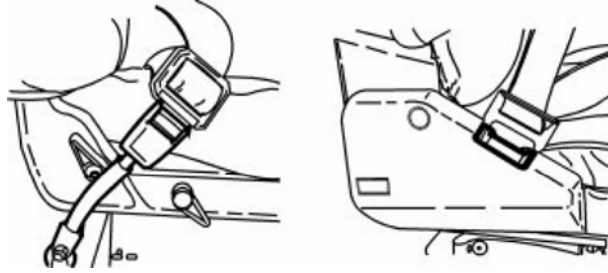

T8014325

## Operating three points safety belt

You should properly adjust your seat first before fastening the sea belt. To fasten the seat belt, pull de belt out from the retractor and insert the latch into the buckle.

Adjust the slack by pulling on the top part of the belt until the lower part, or the part that crosses the lap, is snugly adjusted. Release the top part and let the retractor pull the belt in.

One lap portion of the safety belt should be worn low across the pelvic region (hip bone) and adjusted snugly. The other part of the safety belt should be worn over the shoulder and cross the chest, away from the neck.

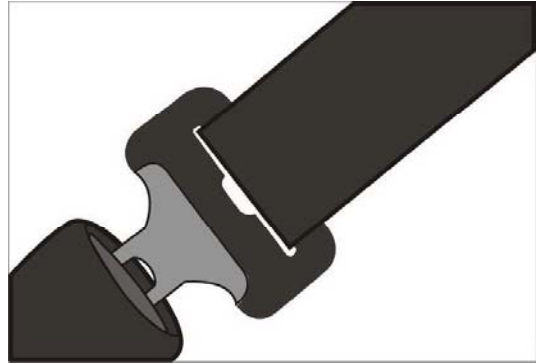

T8056398

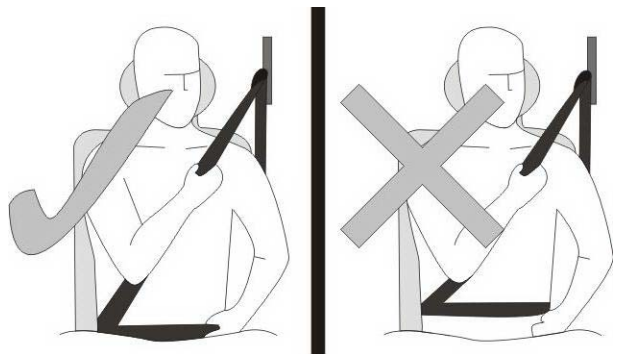

T8056401



**DANGER**

Never adjust the lap belt across the abdomen.



**DANGER**

Never place the shoulder belt behind your back or under your arm.

A push button on the buckle is used to release the safety latch.

## 6 Maintenance

---

### Inspection

Check the belts, buckles, latch plates, retractors, anchorages, and guide loops to ensure that they are working properly. Look for loose/damage parts (without disassembling) that could keep the restraint system from working properly. If the safety belt, retractor and hardware were in use during a collision, they must be replaced. The restraint system anchorage fasteners must be replaced if necessary. If there is any doubt about the restraint system's effectiveness, replace the entire safety belt assembly.

#### **DANGER**

Failure to properly inspect and maintain the safety belts can cause serious personal injury or death

#### **DANGER**

It is critical that any time a vehicle has been involved in an accident, the entire safety belt system must be replaced in the vehicle if they were in use at the time of the accident. Failure to replace the safety belt system may result in serious injury or death

#### **DANGER**

A damaged safety belt, whether visibly damaged or not, could result in serious personal injury in the event of an accident. The safety belt systems should be replaced at least every five years.

#### **DANGER**

Do not bleach or re/dye the color webbing because it may cause a severe loss of belt strength. This loss of strength could allow the safety belt to break under stress, thus resulting in severe personal injury or death.

The following maintenance guidelines detail how to inspect safety belts and tethers for cuts, fraying, extreme or unusual wear of the webbing, etc., and damage of the buckle, retractor, hardware or other factors which indicate that the safety belt system replacement is necessary. Check the web wear at the buckle/latch area. The webbing must be closely examined to determine if there are any cuts, fraying or extreme wear in the webbing. Cuts, fraying or excessive wear would indicate the need for replacement of the safety belt system.

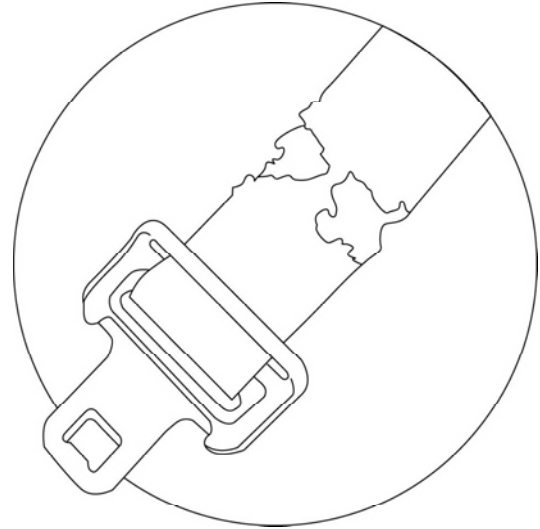

T8014326

Check the buckle by inserting the latch and verifying proper operation. Determine if the latch plate is worn or deformed. Check the buckle and latch casing for cracks or breakage

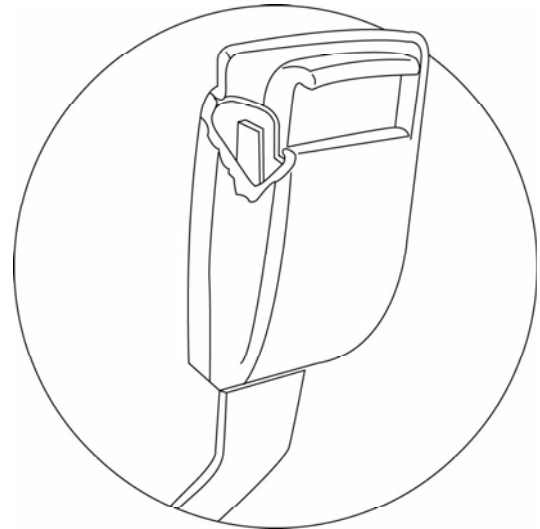

T8014327

## 8 Maintenance

---

For driver, the retractor web storage device is mounted on the B-pillar, just behind the Driver's window for 3 points seat belt, and for 2 points seat belt the retractor is mounted on the right side of the driver seat. The retractor is the heart of the safety belt system and can be damaged if abused, even unintentionally. Check the retractor web storage device operation to ensure that it is not locked and that it spools out and retracts the webbing properly.



T8065899

For passengers, the retractor web storage device is mounted into the backseat. The retractor is the heart of the safety belt system and can be damaged if abused, even unintentionally. Check the retractor web storage device operation to ensure that it is not locked and that it spools out and retracts the webbing properly.

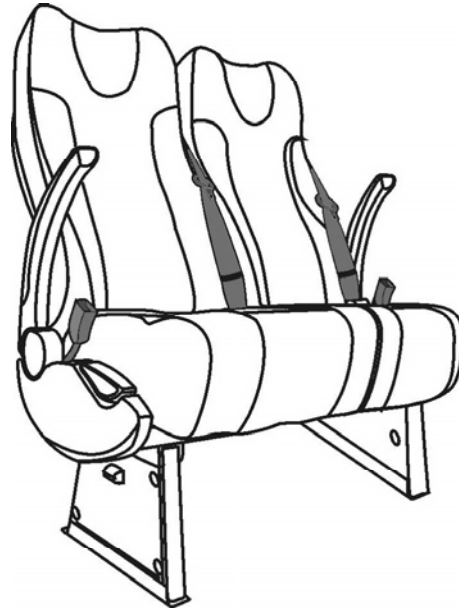

T8065952

If the tethers are being used to anchor the safety belts to the floor, make sure that they are properly attached to the seat. Tethers must also be inspected for web wear and proper tightness of mounting hardware.

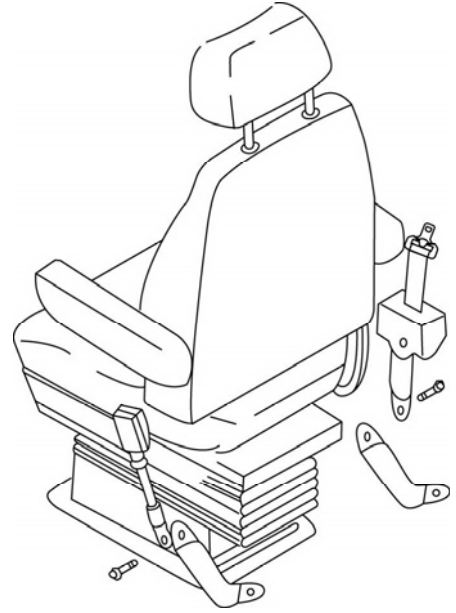

T8014323

All hardware for safety belt mounting points should be evaluated for corrosion. All attachment points of the system should be checked for tightness of mounting hardware.

Check the web in areas exposed to ultra-violet rays from the sun or extreme dust or dirt. If the original color of the web in these areas is extremely faded, the physical strength of this web may be deteriorated. If this condition exists, replace the safety belt system.

# 10 Maintenance

---

## Important Facts About Safety Belts in Buses

The high mileage associated with buses and the potential exposure of this safety belt to severe environmental conditions make it crucial to inspect the seat belt system regularly. It is recommended that the system be inspected every 15,000 miles (24,000 km) or more often if the vehicle is exposed to severe environmental or vocational conditions. Any safety belt system that shows cuts, fraying, extreme or unusual wear, significant discolorations due to ultra-violet ray exposure, dusty-dirty conditions, abrasion to the safety belt webbing or damage to the buckle, latch plate, retractor, hardware or any other obvious problem should be replaced immediately, regardless of the mileage.

Once replacement of the safety belt has been determined necessary, be certain that it is replaced only with a Volvo original replacement safety belt. See your authorized Volvo or for Prevost supported vehicles, in Prevost service center/provider for replacement. Replace it only with the exact same design that the vehicle was equipped with. If the inspection indicates that any other part of the safety belt system requires replacement, the entire belt system must be replaced. It is vitally important that all components are mounted back in the same positions as the original components that were removed. This will maintain the design integrity of the mounting points for the safety belt assembly.



## Index

### I

Inspection .....	6
Introduction .....	1

### M

Maintenance.....	6
------------------	---

### O

Operating three points safety belt .....	5
---	---

Operating two points safety belt.....	3
--	---

### S

Safety Information .....	5
Safety seat belt.....	2
Seat belts.....	2

**VOLVO**

**Volvo Bus Corporation**  
Göteborg, Sweden

# **Driver's Handbook**

## **Driver's seat**

B13R

**VOLVO**

# Foreword

This manual contains information concerning the operation and function of the driver's seat. The information in this manual applies to vehicles built January 2009 and later. Please keep this manual in the vehicle at all times.

**Note:** Illustrations in this manual are used for reference only and may differ slightly from the actual vehicle. However, key components addressed in this document are represented as accurately as possible.

The National Highway Traffic Safety Administration (NHTSA) and Volvo Trucks North America should be informed immediately if you believe that the vehicle has a defect that could cause a crash, injury or death.

Contact NHTSA by calling the Auto Safety Hotline at 1 (888) 327-4236, by writing to NHTSA, U.S. Department of Transportation, Washington, DC 20590, by TTY at 1 (800) 424-9153, or visit their website at [www.nhtsa.dot.gov](http://www.nhtsa.dot.gov).

## Volvo Bus Corporation

Göteborg, Sweden

**Order number: 89008116**

©2009 Volvo Bus Corporation, Göteborg, Sweden

All rights reserved. No part of this publication may be reproduced, stored in retrieval system, or transmitted in any forms by any means, electronic, mechanical, photocopying, recording or otherwise, without the prior written permission of Volvo Bus Corporation

---

# Contents

<b>Introduction</b> .....	1
Important Notes.....	1
<b>Adjusting the Seat Settings</b> .....	2
Raising and Lowering the Seat .....	2
Adjusting the Cushion's, Rear Section.....	2
Setting the Distance from the Steering Wheel.....	3
Adjusting the Seat Backrest Position.....	3
Adjusting the Armrests.....	4
Adjusting the Lumbar Backrest .....	4
Safety Belt .....	5



---

# Safety Information

**IMPORTANT:** Before driving this vehicle, be certain that you have read and that you fully understand each and every step of the driving and handling information in this manual. Be certain that you fully understand and follow all safety warnings.

IT IS IMPORTANT THAT THE FOLLOWING INFORMATION BE READ, UNDERSTOOD AND ALWAYS FOLLOWED.

The following types of advisories are used throughout this manual:

## **DANGER**

Danger indicates an unsafe practice that could result in serious personal injury or death. A danger advisory banner is in **white** type on a **black** background with a **black** border.

## **WARNING**

Warning indicates an unsafe practice that could result in personal injury. A warning advisory banner is in **black** type on a **gray** background with a **black** border.

## **CAUTION**

Caution indicates an unsafe practice that could result in damage to the product. A caution advisory is in **black** type on a **white** background with a **black** border.

**Note:** Note indicates a procedure, practice, or condition that must be followed in order for the vehicle or component to function in the manner intended.

---



## **Important Notes**

Do not use the seat before you have read these instructions on how to use it. Keep this manual in the vehicle at all times. With road traffic and passengers safety in mind, only perform adjustments to the seat when the bus is at a standstill.

## 2 Adjusting the Seat Settings

---

The National 60848 seat is designed with a wide range of adjustment options. The seat controls for adjusting the seat may be located on the left or right-hand side of the seat.

### Raising and Lowering the Seat

To make getting up, down or getting out from the drivers position easier the seat has a quick-lowering function. If control (1) is pressed downwards, the seat lowers making it easier to get up, down and out of the drivers position. If control (1) is pressed upwards, the seat rises to the drivers preferred position.

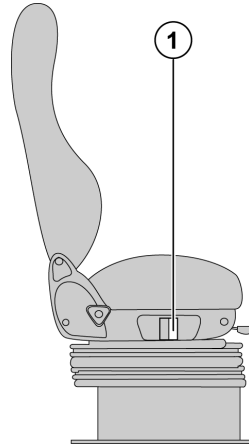

T0015365

### Adjusting the Cushion's, Rear Section

If the knob (2) is turned in either direction, the cushion's rear section raises up or moves down.

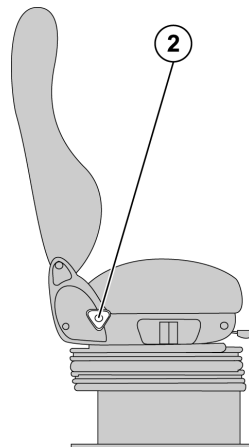

T0015366

## Setting the Distance from the Steering Wheel

To move the whole seat forward or backward, push the lever (3) to the left then move the seat up to the desire position and release the lever to lock the seat again.

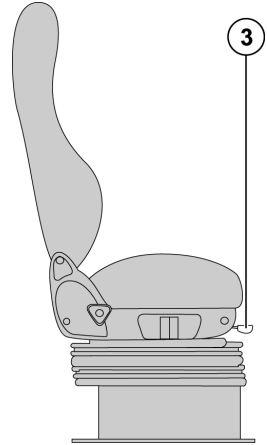

T0015367

## Adjusting the Seat Backrest Position

Twist the knob (4) counterclockwise to move the backrest forward or turn the knob clockwise to move the backrest backward.

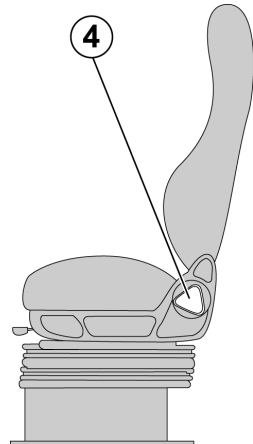

T0015368

## 4 Adjusting the Seat Settings

### Adjusting the Armrests

The seat has two armrests, one attached on either sides. To make sitting down or getting up easier, the armrest can be tilted fully vertical. The armrests have an adjust range from 15° to 45°. To adjust the armrest angle, pull it up to the top position then down to its bottom position. From the down position, lift the armrest up to the desire position.

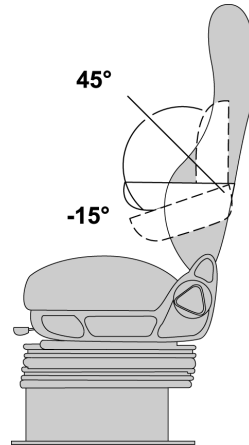

T0015369

### Adjusting the Lumbar Backrest

By pulling the control (5) upward, the lumbar pressure increases while pushing down decreases pressure. When the control is released, the lumbar backrest is set.

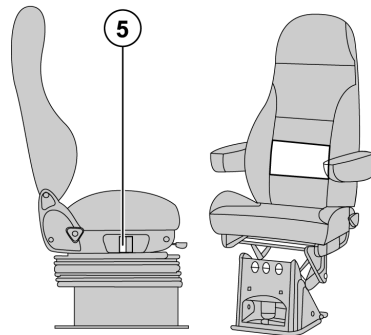

T0015370

## Safety Belt

For security, always use the safety belt.

### Two points safety belt

Cross the belt from the right (7) side to the left side (6) and insert the latch into the buckle on the left side an audible click is heard, verify proper lock of the latch by pulling on the latch. Safety belt should be worn low across the pelvic region (hip bone) and adjusted snugly.

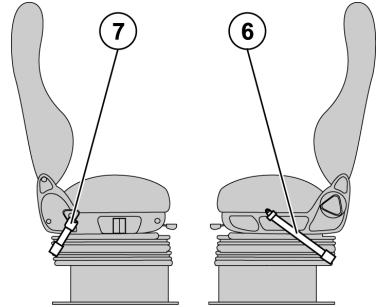

T0015371



### DANGER

Never place the shoulder belt behind your back or under your arm.

A push button on the buckle is used to release the safety latch, by pushing in the button release the on the buckle

## 6 Adjusting the Seat Settings

### Three point safety belt

To fasten the safety belt, pull the belt out from the retractor (6) and insert the latch into the buckle (7) an audible click is heard, verify proper lock of the latch by pulling on the latch. Adjust the slack by pulling on the top part of the belt until the lower part that crosses the lap, is snugly adjusted, release the top part and let the retractor pull the belt in. One lap portion of the safety belt should be worn low across the pelvic region (hip bone) and adjusted snugly, the other part of the safety belt should be worn over the shoulder and cross the chest, away from the neck.

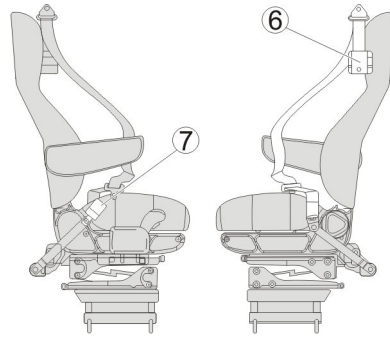

T0064067

#### DANGER

Never place the shoulder belt behind your back or under your arm.

A push button on the buckle is used to release the safety latch, by pushing in the button release the on the buckle



**VOLVO**

**Volvo Bus Corporation**

Göteborg, Sweden



# Driver's Handbook

## Prevost Liaison 2.0 Communication System

H3, X3

**PREVOST**  
**LIAISON** 

**VOLVO**

# Foreword

This manual contains information concerning the operation and function of the Telematics System. The information in this manual applies to vehicles built January 2012 and later. Please keep this manual in the vehicle at all times.

**Note:** Illustrations in this manual are used for reference only and may differ slightly from the actual vehicle. However, key components addressed in this document are represented as accurately as possible.

**Volvo Bus Corporation**

Göteborg, Sweden

**Order number: 89038570**

©2011 Volvo Bus Corporation, Göteborg, Sweden

All rights reserved. No part of this publication may be reproduced, stored in retrieval system, or transmitted in any forms by any means, electronic, mechanical, photocopying, recording or otherwise, without the prior written permission of Volvo Bus Corporation

---

# Contents

<b>General Information.....</b>	<b>1</b>
System Information.....	1
Switch Control Buttons.....	2
Using the Display.....	3
Read Message .....	4
Send Message.....	6
Other Info.....	11
Compass Gauge .....	13
Location .....	13
Directional Arrow .....	13



---

# Safety Information

**IMPORTANT:** Before driving this vehicle, be certain that you have read and that you fully understand each and every step of the driving and handling information in this manual. Be certain that you fully understand and follow all safety warnings.

IT IS IMPORTANT THAT THE FOLLOWING INFORMATION BE READ, UNDERSTOOD AND ALWAYS FOLLOWED.

The following types of advisories are used throughout this manual:



## DANGER

Danger indicates an unsafe practice that could result in serious personal injury or death. A danger advisory banner is in **white** type on a **black** background with a **black** border.



## WARNING

Warning indicates an unsafe practice that could result in personal injury. A warning advisory banner is in **black** type on a **gray** background with a **black** border.



## CAUTION

Caution indicates an unsafe practice that could result in damage to the product. A caution advisory is in **black** type on a **white** background with a **black** border.

**Note:** Note indicates a procedure, practice, or condition that must be followed in order for the vehicle or component to function in the manner intended.

---

## System Information

The Telematics System is a cell phone GSM communication and GPS communication from GPS satellites to the vehicle. It includes a GPS communication ECU, a combined GPS/GSM antenna and wiring harnesses. This system allows communication between web-based software on the Customer Portal and the vehicle. The driver can send and receive short text messages, which are visible through the Driver Information Display (DID) in the vehicle instrument cluster. The fleet operator can communicate with the driver through web-based software on the Customer Portal. The Telematics System also provides GPS data in the DID Gauges menu. This data indicates the location and direction the vehicle is travelling to the driver and fleet operator.

## 2 General Information

---

### Switch Control Buttons

The controls for the Driver Information Display (DID) in the instrument cluster are two buttons on the left hand side of the steering wheel..

#### Upper one

- **ENTER** Selects message.
- **ESCAPE** Takes you back to previous menu .

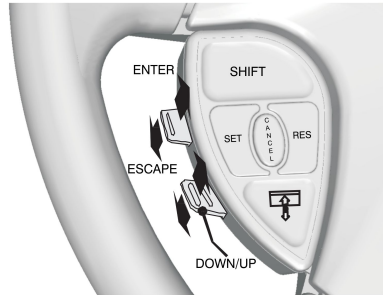

W3071911

#### Lower one

- **UP** Arrow scrolls up through menus, text, messages or alphabet.
- **DOWN** Arrow scrolls down through menus, text, messages or alphabet.



## Using the Display

- 1 The Telematics System is seen as Prevost Liaison in system menu in the DID. Press **ESCAPE** to display the main menus in the DID.
- 2 Use the up and down button on the left hand side of steering wheel switch to scroll to the Prevost Liaison menu.
- 3 Press **ENTER** to select the Prevost Liaison menu.
- 4 After selecting Prevost Liaison, another screen pops up, offering the choice to read messages, send messages, or view other information.
- 5 For instructions on reading and sending messages, or other information, refer to:
  - “Read Message”, page 4
  - “Send Message”, page 6
  - “Other Info”, page 11

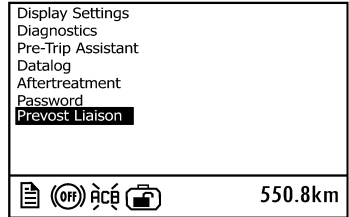

W3071907

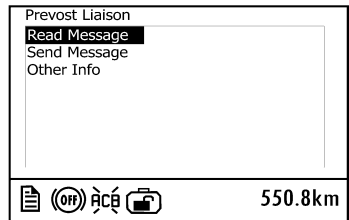

W3071908

The following menus are available:

- 1 Read message
  - Quick Response (Only available if there is a message available.)
- 2 Send message
  - Driver & Equipment
  - Dispatch Messages
  - Free Text
- 3 Other Info
  - Comm Link Info
  - Mailbox Info
  - GPS Info
  - INI Info
  - Configuration Info

## 4 General Information

---

### Read Message

#### *Incoming Message Notification*

The fleet operator can send messages to the driver. When a message is received by the Telematics ECU, the driver is notified by the INFO lamp in the instrument cluster :



W3005150

and a message in the DID. One of the following two messages will appear:

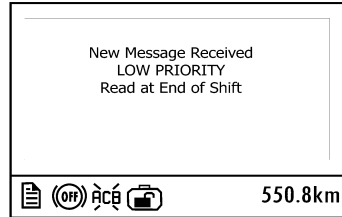

W3071909

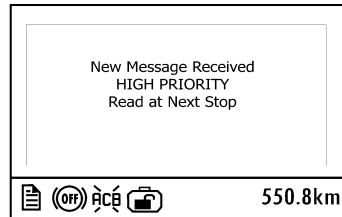

W3071910

Press **ESCAPE** on the left hand side of steering wheel switch when the message

appears to turn off the INFO lamp and message.

## Viewing Messages

To view all stored messages, select Prevost Liaison, then **Read message** in the DID.

**Note:** Messages **can be sent (or read)** only when the vehicle is stopped.



W3072069

\*2 indicates there are two unread messages in the queue.

When there are no stored messages, the following screen is displayed.

This will be seen once in life of vehicle.

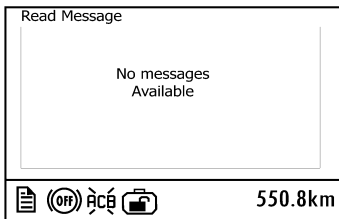

W3072070



## WARNING

For safety reasons do not attempt to use the messaging feature if the vehicle is not parked, failure to do so could result in personal injury or vehicle damage.

## 6 General Information

---

### Send Message

#### *Sending Messages from the Vehicle*

The driver can send messages to the fleet operator. Messages **can be sent (or read)** only when the vehicle is stopped .

The driver can send three types of messages: Driver & Equipment, Dispatch Messages, and Free text. Scroll to **Send message** in the Prevost Liaison menu and press **ENTER**.

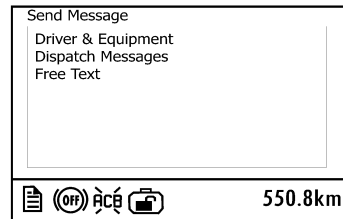

W3072076

The Driver & Equipment and Dispatch Messages menus contain standard messages.

## Driver & Equipment

H3 and X3 Models
<ul style="list-style-type: none"><li>• Driver1:Start/Resume</li><li>• Off Duty For the Day</li><li>• Pre-Trip Check OK</li><li>• Stopped: On Duty</li><li>• Stopped: Off Duty</li><li>• Please Call Me ASAP</li><li>• Instructions Needed</li><li>• Breakdown: Stranded</li><li>• Breakdown: Driveable</li></ul>



**Note:** Message “Breackdown: Stranded”, open a case with PASS. PASS will take action to contact the people they have in reference for this vehicle help. Only this message is alerting PASS.

# 8 General Information

---

## Dispatch Messages

### H3 and X3 Models

- Trip/Leg: Started
- Trip/Leg: Completed
- Status: Loaded
- Status: Empty
- Not Fueled/ Cleanedl
- Picked up Group
- Dropped Group
- Stop-Off
- On Time Arrival
- Late: More Than 1 h
- Send Dispatch Info

To select a message, scroll to the message and press **ENTER**. To send the message, press **ENTER**. Press **ESCAPE** to return to the menu.

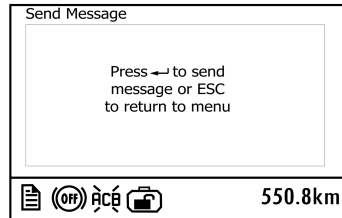

## Free Text

Free text messages are sent as follows:

Use the switch button to scroll the cursor (see 1 in illustration) through the available characters. Press the UP arrow to move to the left and the DOWN arrow to move to the right. Once the cursor has highlighted the correct character, press **ENTER**. Repeat for each character.

Hold the UP or DOWN arrow to quickly move the cursor through the available characters.

Use the message movement arrows (see 5 in illustration) to move the cursor (see 4 in illustration) in the message area.

When finished with the message select X (see 6 in illustration), or press **ENTER** and hold for 3 seconds, to send the message.

**Note:** Press **ESCAPE** to go back to the previous character. To cancel sending a typed message, press **ESCAPE** until the message is cleared from the screen.

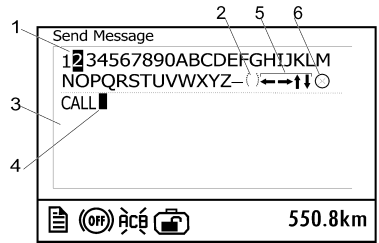

W3072077

- 1 Selection Cursor
- 2 Space
- 3 Message Area
- 4 Message Cursor
- 5 Message Movement Arrows
- 6 Send Icon

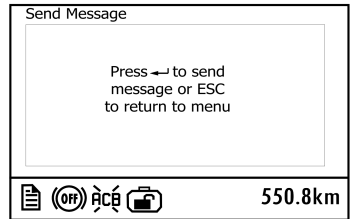

W3072073

# 10 General Information

---

## After Message is Sent

After a message is sent, one of the following confirmations will appear on screen:

If **Message Placed In Outbox** is displayed, the message was received by the Telematics ECU and will be sent during the next GPS transmission.

If **Sending Not Allowed** is displayed, the message was **NOT** sent. The reason for this failure may be the system is busy or the output queue is full. Wait briefly and try sending the message again. If the error message persists, please contact your fleet operator.

**Note: Sending Not Allowed** is displayed if the Outbox is full or there is an antenna problem. Scroll to Mailbox Info and Comm Link Info screens for additional information.

If **Please CALL PASS (800) 463-7738** is displayed, the message was **NOT** sent. This indicates that messaging capabilities have not been activated or they have been disabled by the fleet. Please contact your fleet operator.

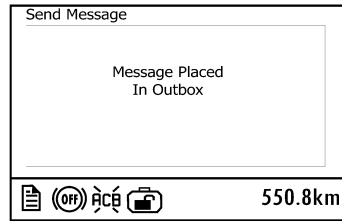

W3072080

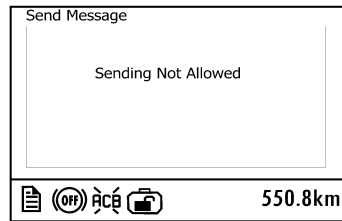

W3072081

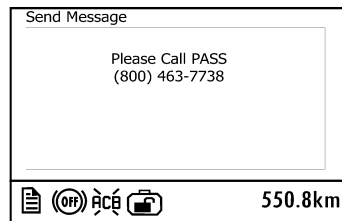

W3072082



## Other Info

The **Other Info** menu displays general operational information about the Telematics System. Information includes:

- Comm Link Info
- Mailbox Info
- GPS Info
- INI Info
- Configuration Info

Use the switch buttons to scroll through each screen. To update the information in each screen, scroll to the next screen then return to the previous screen.

The **Comm Link Info** screens provide information about the Internet Protocol and International Mobile Subscriber Identity. Signal is a scale of 0 to 30, indicates quality of cell reception.

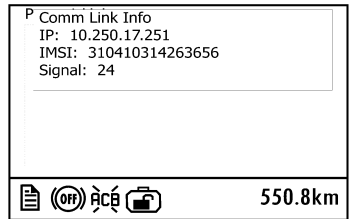

## 12 General Information

---

The **Mailbox Info** screen indicates the total number of messages sent and received. Also indicated is the number of messages currently in the outbox waiting to be transmitted and whether or not the outbox is full.

**0** in Outbox means all messages were processed and sent. If in a zone where no cell coverage, and message is sent by driver, Outbox could indicate something different than 0, where a message is pending. This could be a check for driver if he wants to confirm his message has gone through.

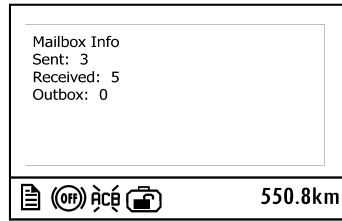

W3072083

The **GPS Info** screen provides information about the GPS signal. It displays how many satellites are in view and the type of **Fix** (3D, 2D or No Fix). **Lat** is the current latitude. **Lon** is the current longitude.

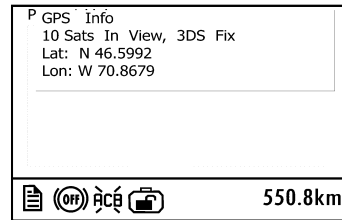

W3072079

The **INI Info** screen displays the current state of the ECU initialization (start-up) and the VIN Check status.

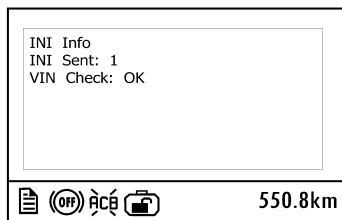

W3072084

The **Configuration Info** screen indicates the status of active schedules and driver messaging. When schedules are enabled, the number of active schedules is also displayed.

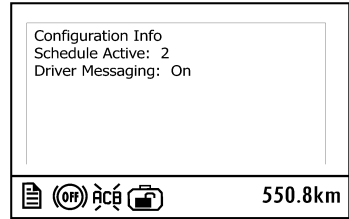

W3072085

## Compass Gauge

Select **Gauges** in the DID main menu and scroll UP or DOWN to display the compass gauge.

If a GPS fix is not available, the gauge may or may not display the compass arrow, a latitude and longitude reading, a 0.0 or dashes latitude and longitude reading. Scroll to the **GPS Info** screen to check the GPS signal status.

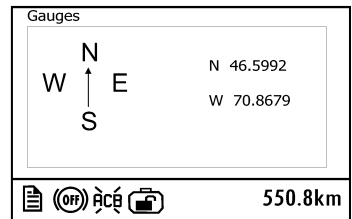

## Location

The location of the vehicle is displayed in degrees latitude and longitude. The top value shows the latitude. The bottom value shows the longitude.

## Directional Arrow

The compass arrow shows the direction the vehicle is travelling. After the vehicle is stopped, the arrow stays pointed in the last direction of travel.

**VOLVO**

**Volvo Bus Corporation**

Göteborg, Sweden

# **Driver's Handbook**

## **Passenger, Seat Side Electrical Outlet**

**B13R**

**VOLVO**

# Foreword

This information provides the service information about the operation and function of the Passenger, Seat Side Electrical Outlet in Volvo buses.

**Note:** Illustrations in this manual are used for reference only and may differ slightly from the actual vehicle. However, key components addressed in this document are represented as accurately as possible.

**Volvo Bus Corporation**

Göteborg, Sweden

**Order number: 89070632**

©2012 Volvo Bus Corporation, Göteborg, Sweden

All rights reserved. No part of this publication may be reproduced, stored in retrieval system, or transmitted in any forms by any means, electronic, mechanical, photocopying, recording or otherwise, without the prior written permission of Volvo Bus Corporation

---

# Contents

<b>Passenger, Seat Side Electrical Outlet.....</b>	<b>1</b>
System Overview .....	1
Network System Description .....	2
Electric Network Operation .....	3
Resetting Electric Network 127 V.....	4





---

# Safety Information

**IMPORTANT:** Before driving this vehicle, be certain that you have read and that you fully understand each and every step of the driving and handling information in this manual. Be certain that you fully understand and follow all safety warnings.

IT IS IMPORTANT THAT THE FOLLOWING INFORMATION BE READ, UNDERSTOOD AND ALWAYS FOLLOWED.

The following types of advisories are used throughout this manual:



## DANGER

Danger indicates an unsafe practice that could result in serious personal injury or death. A danger advisory banner is in **white** type on a **black** background with a **black** border.



## WARNING

Warning indicates an unsafe practice that could result in personal injury. A warning advisory banner is in **black** type on a **gray** background with a **black** border.



## CAUTION

Caution indicates an unsafe practice that could result in damage to the product. A caution advisory is in **black** type on a **white** background with a **black** border.

**Note:** Note indicates a procedure, practice, or condition that must be followed in order for the vehicle or component to function in the manner intended.

---

## System Overview

Some vehicles can be equipped with 127 V AC passenger, seat side electrical outlets. The circuit may have up to twenty four(24) outlets.

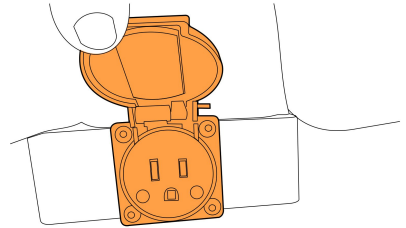

As standard, one electrical outlet, is located in front of each pair of passenger seats.

W3076818



### CAUTION

Only laptop computer may be connected to the electrical network.  
Connecting any other electrical device may cause a malfunction of the electrical network.

## 2 Passenger, Seat Side Electrical Outlet

---

### Network System Description

Passengers can use the electrical outlets to connect their laptop computer.

A maximum of sixteen (16) laptop computers can be connected at same time.

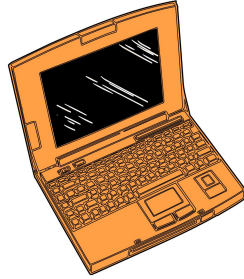

W0074155

## Electric Network Operation

The following conditions must be satisfied before the electrical network can be used.

1. Engine Speed must be greater than 1000 RPM.
2. Wheel Chair Lift (WCL) must be inactive.

**Note:** If this required condition is not met, the operation relay will not activate and electrical network will not function.

**Note:** If the vehicle does not have a WCL condition 2 does not apply.

## 4 Passenger, Seat Side Electrical Outlet

---

### Resetting Electric Network 127 V.

To protect the vehicle, the electrical network has a thermal circuit breaker to disconnect the power supply if the load exceeds 25A.

In the event of a circuit interruption the passengers must disconnect their laptop computer prior to resetting the circuit breaker. Leaving devices connected to the electrical network may damage the devices or cause a repeat circuit interruption.

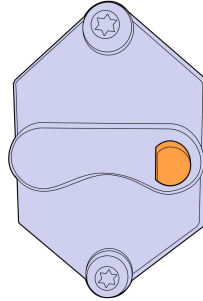

W3074156

# Passenger, Seat Side Electrical Outlet 5

There is an 50A fuse protecting the electric network. This fuse is located in the fuse and relay box in the interior bus floor behind the operators seat.

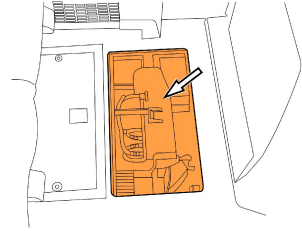

W3076819

If the fuse fails, it should be replaced by an 50A fuse. Never insert a fuse of a higher amperage rate. Replacement of this fuse should be performed **by a properly trained technician.**

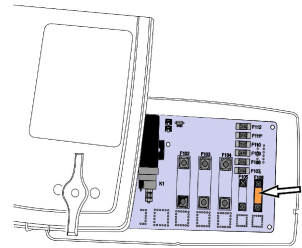

W3076817



## WARNING

Failure to use proper circuit protection devices in the vehicle can result in damage to the vehicle and its components. Replace blown fuses only with fuses of the same rating. Replace fusible links only with proper replacement parts of the exact gauge and length. Failure to use proper circuit protection could overload the circuit, causing damage to the vehicle and a possible fire, and personal injury

**VOLVO**

**Volvo Bus Corporation**

Göteborg, Sweden



# **Driver's Handbook**

## **Exhaust Aftertreatment System**

B13R, 9700

**VOLVO**

# Foreword

This manual contains information concerning the operation and function of the Exhaust Aftertreatment System. The information in this manual applies to vehicles complying with US10 Emissions Standard Please keep this manual in the vehicle at all times.

**Note:** Illustrations in this manual are used for reference only and may differ slightly from the actual vehicle. However, key components addressed in this document are represented as accurately as possible.

The National Highway Traffic Safety Administration (NHTSA) and Prevost should be informed immediately if you believe that the vehicle has a defect that could cause a crash, injury or death.

Contact NHTSA by calling the Auto Safety Hotline at 1 (888) 327-4236, by writing to NHTSA, U.S. Department of Transportation, Washington, DC 20590, by TTY at 1 (800) 424-9153, or visit their website at [www.nhtsa.dot.gov](http://www.nhtsa.dot.gov).

## Volvo Bus Corporation

Göteborg, Sweden

**Order number: 89090868**

©2013 Volvo Bus Corporation, Göteborg, Sweden

All rights reserved. No part of this publication may be reproduced, stored in retrieval system, or transmitted in any forms by any means, electronic, mechanical, photocopying, recording or otherwise, without the prior written permission of Volvo Bus Corporation

---

# Contents

<b>Exhaust Aftertreatment System .....</b>	<b>1</b>
General .....	1
System Overview .....	2
Exhaust Aftertreatment System Description .....	3
Filtration and Regeneration Unit .....	3
Passive regeneration .....	3
Stationary (parked) regeneration .....	4
Safety Information .....	5
Selective Catalytic Reduction .....	6
Instrument Cluster Icons .....	8
Operation .....	9
Aftertreatment Menu .....	10
DPF Regeneration .....	11
Aftertreatment DEF Tank Level — Driver Warning & Inducement .....	16
Aftertreatment DEF Quality — Driver Warning & Inducement .....	17
Exit conditions for DEF Quality “8Km/h (5 mph) road speed limit” Inducement: .....	18
Aftertreatment Tampering — Driver Warning & Inducement .....	19
Misfilling Diesel or Aftertreatment DEF Tanks .....	21
Results of misfilling DEF in Diesel Tank .....	21
Results of misfilling diesel en Aftertreatment DEF Tank .....	21
Aftertreatment System Maintenance .....	21
Aftertreatment System Conditions .....	22
Diesel Exhaust Fluid (DEF) .....	23
Diesel Exhaust Fluid (DEF) Handling .....	23
About spilled Diesel Exhaust Fluid (DEF) .....	24
Warranty and Maintenance .....	25
Exhaust Aftertreatment System Maintenance .....	25
Emissions Maintenance .....	25
Engine Gaseous Emission Control Systems .....	26
Emissions Control System Warranty .....	27
Engine Gaseous Emissions Control System Warranty .....	28
Federal Emission Requirements .....	28
Emission Control System Warranty — California .....	29
Emissions Control System Warranty .....	32
Engine Components, Service Schedules .....	34



---

# Safety Information

**IMPORTANT:** Before driving this vehicle, be certain that you have read and that you fully understand each and every step of the driving and handling information in this manual. Be certain that you fully understand and follow all safety warnings.

IT IS IMPORTANT THAT THE FOLLOWING INFORMATION BE READ, UNDERSTOOD AND ALWAYS FOLLOWED.

The following types of advisories are used throughout this manual:



## **DANGER**

Danger indicates an unsafe practice that could result in serious personal injury or death. A danger advisory banner is in **white** type on a **black** background with a **black** border.



## **WARNING**

Warning indicates an unsafe practice that could result in personal injury. A warning advisory banner is in **black** type on a **gray** background with a **black** border.



## **CAUTION**

Caution indicates an unsafe practice that could result in damage to the product. A caution advisory is in **black** type on a **white** background with a **black** border.

**Note:** Note indicates a procedure, practice, or condition that must be followed in order for the vehicle or component to function in the manner intended.

---

## General

### USA

Emissions Control Compliance: The Federal Clean Air Act, Section 203 (a) (3), states the following concerning the removal of air pollution control devices or modification of a certified engine to a non-certified configuration:

“The following acts and the causing thereof are prohibited:

(3) For any person to remove or render inoperative any device or element of design installed on or in a motor vehicle engine in compliance with regulations under this part prior to its sale and delivery to the ultimate purchaser, or for any manufacturer or dealer knowingly to remove or render inoperative any such design after sale and delivery to the ultimate purchaser”

Specifically, please note that no person may make such changes prior to the sale and delivery of the vehicle to the ultimate purchaser, and, in addition, no manufacturer or dealer may take such action after sale and delivery of the vehicle to the ultimate purchaser. The law provides a penalty of up to \$10,000 for each violation.

Modifications, such as reprogramming of the fuel system so the engine will exceed the certified horsepower or torque, or removing the mufflers are examples of illegal changes.

Changes should not be made to a certified engine that would result in an engine that does not match the configuration of an engine model that is currently certified to meet Federal Standards

### Canada

The same conditions that apply in the USA apply to Canada, with one exception. After the vehicle is sold to a retail customer, that is, the end user, the jurisdiction controlling the emissions control devices becomes the province in which the vehicle is licensed. No changes should be made that render any or all of the devices inoperative.

Should the owner/ operator wish to make any changes to the emissions control devices, check with the provincial authority before making any such changes

### Mexico

The same conditions that apply in the USA apply to Mexico. Refer to Mexican Federal Law for Emissions Control which adheres to EPA regulations. No changes Should be made that render any or all of the emissions control devices inoperative.

If the owner/operator wishes to make changes to the emission control devices, check with state authority before changes are made.

## 2 Exhaust Aftertreatment System

---

### System Overview

EPA 2010 requires 83% reduction in NOx and 0% reduction in particulate relative to EPA 2007; then is retained the Diesel Particulate Filter (DPF) and is added another aftertreatment device called Selective Catalytic Reduction (SCR) catalyst. The process for reducing NOx via aftertreatment is called Selective Catalytic Reduction (SCR). It requires a catalytic converter into which is injected Diesel Exhaust Fluid (DEF). The primary component of DEF is water; the active component is urea. Urea is a nitrogen compound that turns to ammonia when heated. When a urea-and-water solution is injected into the exhaust stream and passed over a catalyst, the urea reacts with the NOx to form nitrogen and water vapor – two clean and harmless components of the air we breathe. The aftertreatment system primary function is to capture and oxidize (regenerate) the particulate matter (soot) in the engine exhaust gases and to reduce NOx. To achieve this goal, the exhaust aftertreatment system is split into two main sections: the exhaust gases first enter the Diesel Oxidation Catalyst

(DOC) and Diesel Particulate Filter (DPF) assembly to capture and regenerate the soot on a regular or passive basis, then the exhaust gases flow through the catalytic converter to reduce NOx to minimum level.

Vehicles equipped with a DPF require the use of EO-O Premium Plus (or VDS-4) specification high performance diesel engine oil and Ultra Low Sulfur Diesel (ULSD) fuel.



#### CAUTION

The use of Diesel fuel other than ULSD and engine oils other than EO-O Premium Plus (or VDS-4), will adversely affect performance, efficiency and durability of DPF system and the engine, to the point where the engine may not run at all. Manufacturer's warranties can also be rendered void due usage of improper fuel. None approved fuel additives (including engine oil) are NOT permitted. Blends of No. 1D and No. 2D grades of ULSD are recommended and allowable for cold weather operations.



## Exhaust Aftertreatment System Description

The exhaust aftertreatment system consists of two units, the filtration and regeneration unit and the selective catalytic reduction SCR unit.

### Filtration and Regeneration Unit

The main purpose of the filtration and regeneration unit is to capture and oxidize (regenerate) the particulate matter (soot) in the engine exhaust gas. The exhaust gas first enters the Diesel Oxidation Catalyst (DOC) and then flow through the Diesel Particulate

Filter (DPF); together they capture and regenerate the soot on a regular or passive basis. Through constant monitoring of the exhaust gas temperature and the system back pressure, the engine control module is able to manage regeneration.

### Passive regeneration

Passive regeneration is the process by which the particulate matter is oxidized due to the heat generated by the engine internal combustion process. During normal highway

operation, exhaust temperatures alone are usually high enough to oxidize accumulating soot.

## 4 Exhaust Aftertreatment System

---

### Stationary (parked) regeneration

In a small number of specific engine duty cycles, engine control module may not be capable of completing an active regeneration. In these situations, the operator will be notified that a stationary or parked regeneration may be required. A DPF telltale light will illuminate indicating the need for user interaction. The lamp gives the operator a grace period to allow this process to take place at a time when most convenient for the

operator. This process requires the vehicle to be parked while a driver or maintenance technician initiates the regeneration process using the DID menus. Once initiated, the stationary regeneration process will be complete in about 45 minutes. The driver will be notified of the need for a stationary regeneration (parked) by illumination of the DPF REGENERATION telltale light.

## Safety Information

The exhaust aftertreatment system utilizes technology that oxidizes trapped particles of unburned hydrocarbons thereby reducing emissions. This oxidation occurs during the regeneration process. While regeneration is occurring, very high exhaust gas temperatures will occur when the vehicle is stationary.



### WARNING

Always ensure that the vehicle is in a safe and suitable location to withstand the high temperatures that occur during the generation process. Equipment damage or personal injury may occur if combustibles are too close to the exhaust pipe or outlet.



### WARNING

The temperature of the exhaust system components during the regeneration process can exceed 500 degrees C (1000 degrees F). Various factors including ambient temperature and duration of the regeneration process, determine when these components will return to normal operating temperature after regeneration has completed. Be extremely careful around these hot components. Contact with these components can result in personal injury.

## 6 Exhaust Aftertreatment System

---

### Selective Catalytic Reduction

Selective Catalytic Reduction is an emissions-reduction technology with the ability to deliver near-zero emissions of nitrogen oxides (NO<sub>x</sub>), a smog-causing pollutant and greenhouse gas. SCR's performance has been proved in millions of miles of real-world operation in other countries, as well as in long-term field tests in U.S.

SCR reduces NO<sub>x</sub> emissions to very low levels, while at the same time delivering excellent fuel economy and reliability. The system doesn't change the design or operation of the basic engine. Rather, SCR is an aftertreatment system which converts NO<sub>x</sub> in exhaust stream into harmless gases. Modern diesels already use exhaust aftertreatment systems, called diesel particulate filters, to control emissions of another pollutant, soot (also known as particulate matter or PM).

SCR works by injecting Diesel Exhaust Fluid (DEF) into the exhaust stream, after the DPF. DEF is a safe, simple solution of water and urea. DEF works with the heat of the exhaust and catalyst to convert NO<sub>x</sub> into nitrogen and water vapor — two harmless and natural components of the air we breathe. The end result is cleaner air, excellent fuel efficiency and a reliable emissions control system for today's modern diesel engine.

The VOLVO SCR system is simple and effective, with few components. It consists of a Aftertreatment DEF tank plus a Aftertreatment DEF pump, Aftertreatment DEF dosing unit and SCR catalyst. The advantage of using DEF is that it enables the engine to use less EGR —and higher oxygen levels- for better combustion, while meeting EPA near-zero NOx emissions requirement of 0.2 g/hp-hr NOx. By using DEF, we avoid the disadvantages of increasing EGR to massive levels. This results in better fuel economy from your VOLVO engine.



W2055491



## CAUTION

Do not put diesel fuel in the aftertreatment DEF tank. Diesel fuel, if sprayed into the hot exhaust along with the DEF, could ignite explosively causing a fire resulting in personal injury or damage to the exhaust system.

# 8 Exhaust Aftertreatment System

## Instrument Cluster Icons

Aftertreatment icons are displayed on the instrument cluster. There are two aftertreatment icons.

- DPF Regeneration Required
- High Exhaust System Temperature (HEST)

The DPF Regeneration Required icon illuminates when the diesel particulate filter is becoming full and regeneration is needed.

The icon flashes when the filter is full or overfull.

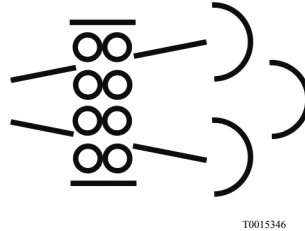

T0015346

The high Exhaust System Temperature icon illuminates when a parked regeneration is initiated. When the HEST icon is illuminated, do not park or operate the vehicle near people or any flammable materials, vapors and structures.

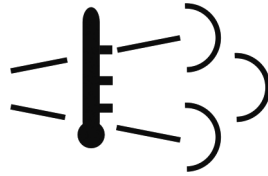

T0015347

## Operation

The stalk switch control lever is used to interact with the Driver Information Display (DID) in the center of the instrument cluster. The lever is located on the right-hand side of the steering wheel.

- 1 Esc or Escape button is used to return to the previous menu or display
- 2 ↵ or Enter button is used to display a list of menus, open a menu or select the highlighted area.

- 3 Up arrow button is used to scroll up through a menu
- 4 Down arrow button is used to scroll down through a menu.

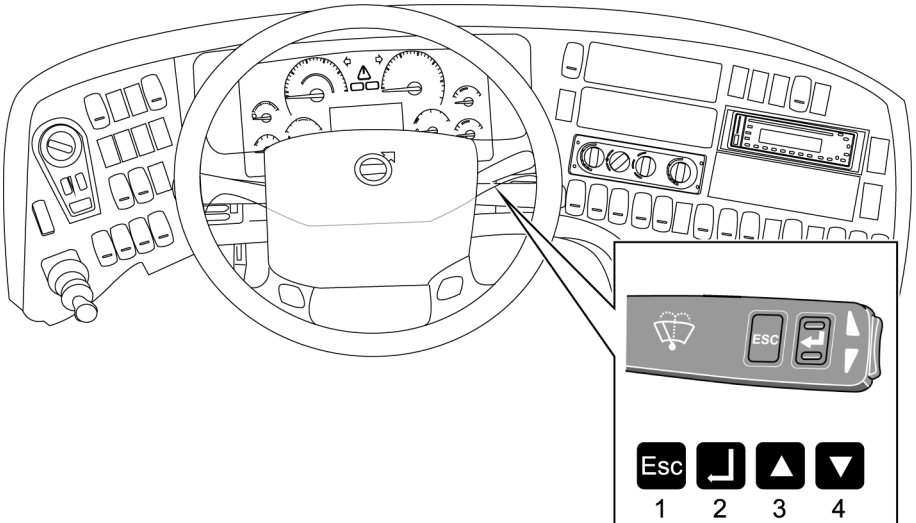

# 10 Exhaust Aftertreatment System

## Aftertreatment Menu

- 1 The aftertreatment system (ATS) menu is in the DID.
- 2 Use the up and down buttons on the stalk switch to scroll to the Aftertreatment menu.
- 3 Press the ↵ button to select the ATS menu

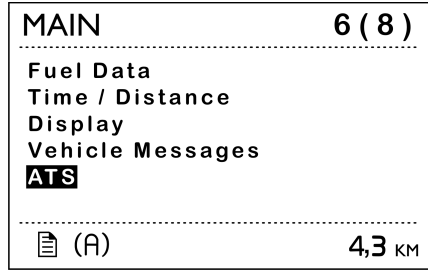

W2080635

The ATS menu has three submenus: Request regeneration, System status and ATS enable/disable.

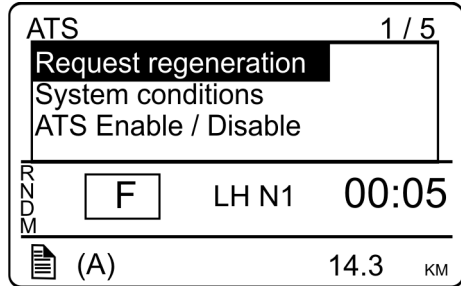

W2075117



## DPF Regeneration



### WARNING

Always ensure that the vehicle is in a safe and suitable location to withstand the high temperatures that occur during the generation process. Equipment damage or personal injury may occur if combustibles are too close to the exhaust pipe or outlet.

**Note:** If the vehicle is in a location that may be hazardous when regeneration begins, the regeneration should be stopped. If the regeneration is stopped by vehicle operator, it should be initiated at a later time when the

There are two types of regeneration:

- Passived, and

vehicle is in a safer location. Regenerations that are stopped and never restarted at a later time however, will require that the vehicle be taken to an authorized Volvo workshop (or for Prevost supported vehicles, a Prevost service center/provider) to have the regeneration manually started.



### CAUTION

If the regeneration is cancelled by vehicle operator, it must be completed as soon as possible to avoid exhaust aftertreatment system damage.

- Parked

## 12 Exhaust Aftertreatment System

---

Passive regeneration only occurs when the vehicle is moving at uninterrupted highway speed. Parked regeneration is manually initiated when the vehicle is stationary. This is the standard configuration. Other configurations are available.

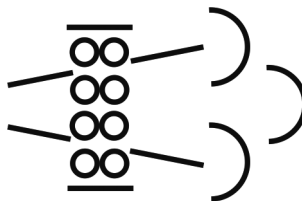

T0015346

If the regeneration process is not delayed, the regeneration process starts. The DPF Regeneration Required icon turns off and the High Exhaust System Temperature (HEST) icon may illuminate.

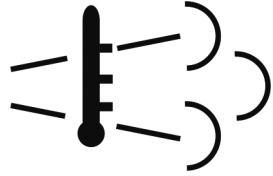

T0015347

To temporarily disable regeneration, scroll to the Aftertreatment menu in the DID, select “ATS Enable/Disable”. When regeneration is disabled, the letters ATS with X through them will be displayed in the DID. Enable regeneration by scrolling to the Aftertreatment menu, selecting “ATS enable/disable” and selecting “Enable regeneration”.

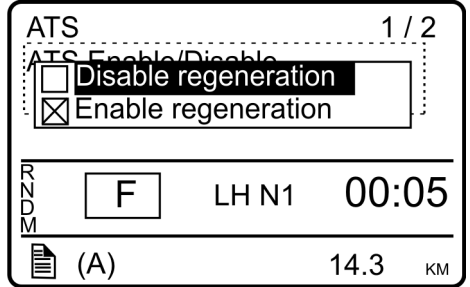

W2075110

# 14 Exhaust Aftertreatment System

---

**Note:** It is important to enable regeneration as soon as possible to avoid engine problems. Long-term engine operation with regeneration disabled will result in a loss of engine performance including horsepower, torque and speed derates. Also, the DPF filter will become overloaded with soot and require service.

The regeneration process can be stopped at any time by turning the ignition key to OFF, scrolling to the Aftertreatment menu in the Driver Information Display (DID)

and selecting “ATS enable/disable”, or by pressing the ↵ button on the stalk switch. Regeneration cannot be initiated if it is not required. The following conditions must be met to perform a parked regeneration:

- Parking brake on and transmission in neutral
- Minimum 10 volts battery charge
- Engine running
- Accelerator and clutch pedal released
- PTO not active

If a request for parked regeneration fails, “Regeneration failed. Check system conditions” is displayed. Scroll to the Aftertreatment menu in the Driver Information Display (DID) and select “System conditions” to determine why the regeneration failed.

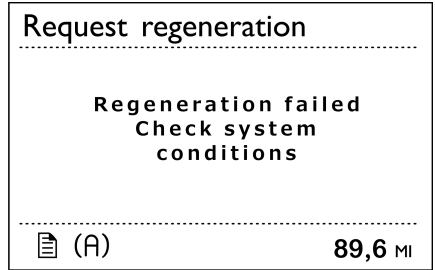

W2080636

If the DPF Regeneration icon is flashing, the diesel particulate filter is full. Maintain uninterrupted highway speed for a passive or move the vehicle to a safe location and initiate a parked regeneration.

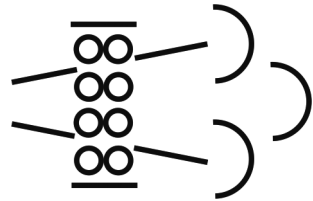

T0015346

If the Regeneration Required icon is flashing and the CHECK light illuminates, the diesel particulate filter is overfull. Engine performance will be limited. To avoid further engine derate, immediately move the vehicle to a safe location and initiate a parked regeneration, or take the vehicle to an authorized Volvo dealership (or for Prevost support vehicles, to a Prevost service center/provider).



T3014365

If the DPF Regeneration Required icon is flashing and the STOP light illuminates, a serious engine problem has occurred. The diesel particulate filter may be over its maximum capacity and the engine may shut down. The vehicle must be taken immediately to an authorized Volvo dealership (or for Prevost supported vehicles, to a Prevost service center/provider) for service.





T3014364

# 16 Exhaust Aftertreatment System







## Aftertreatment DEF Tank Level — Driver Warning & Inducement

Aftertreatment DEF tanks are sized to have no less than two times the diesel fuel tank mileage.

The vehicle instrument cluster has an aftertreatment DEF tank level gauge.

Triggers	Aftertreatment DEF Tank Low Level Indicator	Driver Information Display Screen
100% to 12% Aftertreatment DEF Tank Level Gauge	None	None
<=12% Aftertreatment DEF Tank Level Gauge	 <p style="text-align: center; font-size: small;">W2029416</p> <p>Solid indicator</p>	Low DEF level Refill to avoid Engine derate
0% Aftertreatment DEF Tank Level Gauge (~1% DEF Remaining)	 <p style="text-align: center; font-size: small;">W2029415</p> <p>Blinking indicator</p>	DEF Tank Empty Engine in derate Refill to avoid 5 Mph
0% Aftertreatment DEF Tank Level Gauge AND either: 1 Vehicle stationary for 20 minutes, or 2 Diesel fuel Refueling > 15% with parking brake engaged.	 <p style="text-align: center; font-size: small;">W2029415</p>	DEF tank empty Speed limited to 5 Mph

## Aftertreatment DEF Quality — Driver Warning & Inducement

Triggers	Lamp Status	Driver Information Display Screen
Good DEF Quality	None	None
Poor DEF Quality DTC Initially Detected	 <small>W2029417</small>	SCR performance low Engine derate in < xxx mins
Poor DEF Quality DTC Initially Detected + 1 hour of operation	 <small>W2029417</small>	SCR performance low Engine derate in < xxx mins
Poor DEF Quality DTC Initially Detected +4 hours of operation	 <small>W2029417</small>	SCR performance low Engine in derate 5 Mph in < xxx mins
Poor DEF quality DTC initially detected + 4 hours of operation AND either: 1 Vehicle stationary for 20 minutes, or 2 Diesel Fuel Refueling > 15% with parking brake engaged	 <small>W2029417</small>	SCR Performance low Engine in derate 5 Mph at next stop
By means of 1 engine start or use of a service tool temporary exit from 8 Km/h (5 Mph) Inducement	 <small>W2029417</small>	SCR performance low Speed limited to 5 Mph
Ignition Key Cycle before DEF Quality Evaluation has been completed	 <small>W2029417</small>	SCR perf. check Engine in derate 5 Mph Limit removed

## 18 Exhaust Aftertreatment System

---

### **Exit conditions for DEF Quality “8Km/h (5 mph) road speed limit” Inducement:**

**Next 1 Engine Starts:** Return to 25% torque reduction until there is a proper DEF quality evaluation. If poor DEF quality is detected during the next monitoring cycle then 8 Km/h (5 mph) is resumed after the vehicle is stationary for 20 minutes. After one engine start has been exhausted then a Tech Tool is required to exit the 8 Km/h (5 mph) road speed limit.





**With Tech Tool DTC Clearing:** Invoke 25% torque reduction until there is a proper DEF quality evaluation. If poor DEF Quality is detected during the next monitoring cycle then 8 Km/h (5 mph) is resumed after de vehicle is stationary for 20 minutes.







## Aftertreatment Tampering — Driver Warning & Inducement

When the SCR tampering fault is active for one or more hours a new Driver Information Display screen appears. The text changes for the Driver Information Display (DID) screen associated with this fault are listed in the table below.

**Note:** Repeated acts of tampering will result in more severe inducement.

Triggers	Lamp Status	Driver Information Display Screen
No fault	None	None
<p>Tampering Fault Detect</p> <p><b>Note:</b> For examples of various SCR sensor tampering types refer to the “SCR Tampering ” table below</p>	 <p style="text-align: center; font-size: small;">W2029417</p>	<p>SCR system fault Engine derate in &lt; xxx mins</p>
<p>Second Drive Cycle with Active DTC.</p>	 <p style="text-align: center; font-size: small;">W2029417</p>  <p style="text-align: center; font-size: small;">W3031200</p>	<p>SCR System Fault Engine in derate 5Mph in &lt;xxx mins</p>
<p>Driving with Active Fault for + 1 hour.</p>	 <p style="text-align: center; font-size: small;">W2029417</p>  <p style="text-align: center; font-size: small;">W3031200</p>	<p>SCR system fault Engine in derate 5 Mph in &lt; mins</p>

## 20 Exhaust Aftertreatment System

<p>Driving with Active Fault for + 4 hours</p>	 <p style="text-align: center;">W2029417</p>  <p style="text-align: center;">W3031200</p>	<p>SCR system fault Engine in derate 5 Mph at next stop</p>
<p>Active tampering DTC initially detected + 4 hours of operation AND either:</p> <ol style="list-style-type: none"> <li>1 Vehicle stationary for 20 minutes, or</li> <li>2 Diesel Fuel Refueling &gt; 15% with parking brake engage</li> </ol>	 <p style="text-align: center;">W2029417</p>  <p style="text-align: center;">W3031200</p>	<p>SCR system fault Speed limited to 5 Mph.</p>

### SCR Tampering

Aftertreatment Control Module (ACM)  
Disconnected

Aftertreatment Inlet NOx Sensor  
Disconnected

Aftertreatment Outlet NOx Sensor  
Disconnected

DEF Pump Disconnected

DEF Dosing Valve Disconnected

DEF Tank Lever Sensor Disconnected

DEF Dosing valve or line blocked

DEF Pump pressure build up failure

DEF Return Line Blocked or Plugged

**Note:** For additional DID information refer to the Driver Information Display Manual.

## Misfilling Diesel or Aftertreatment DEF Tanks

Although diesel fuel and Aftertreatment DEF caps are clearly labeled and filler necks and nozzles are different accidents can happen.

Contamination of fluids by- misfilling of diesel or DEF in the wrong tank may result in vehicle malfunction

## Results of misfilling DEF in Diesel Tank

- Engine may run poorly or not at all
- Injectors may be damaged
- Exhaust system corrosion may occur between turbocharger and Aftertreatment DPF
- On Board Diagnostic (OBD) Diagnostic Trouble Codes (DTC)
- Costly repair

## Results of misfilling diesel en Aftertreatment DEF Tank

- Aftertreatment SCR system may be damaged by Diesel
- SCR Catalyst may be damage by diesel (chemical damage)
- Emissions may be non-compliant
- On Board Diagnostic (OBD) Diagnostic Trouble Codes (DTC)
- Costly repairs

## Aftertreatment System Maintenance

The vehicle must be taken to an authorized Volvo workshop (or for Prevost supported vehicles, to a Prevost service center/provider) to remove the ash from the diesel particulate filter and clean the aftertreatment fuel injector.

- The ash cleaning interval is 400 000 km (250,000 miles) or 4,500 hours, which ever occurs first.
- The aftertreatment fuel injector cleaning interval is 240 000 km (150,000 miles) or 4500 hours, which ever occurs first.

## 22 Exhaust Aftertreatment System

### Aftertreatment System Conditions

When ATS System conditions is selected, the following submenus are available:

System conditions		1 ( 4 )
Clutch Status	NA	▲
Engine Status	Check	
PTO Status	OK	▼
 (A)		4,3 MI

W3079741

System conditions		2 ( 4 )
Acc. Pedal	OK	▲
Gear Status	OK	
Vehicle Speed	OK	▼
 (A)		4,3 MI

W3079742

System conditions		3 ( 4 )
Park Brake	OK	▲
System Fault	OK	
Perm System Lockout	OK	▼
 (A)		4,3 MI

W3079743

System conditions		4 ( 4 )
Temp System Lockout	Check	▲
Inhibit Switch	OK	▼
 (A)		4,3 MI

W3079744

## Diesel Exhaust Fluid (DEF)

Diesel Exhaust Fluid (DEF) is a reactant that's key to the SCR process. It's nontoxic, aqueous solution of 32.5% urea and 67.5% water. Urea is a compound of nitrogen that turns to ammonia when heated. It is used in a variety of industries, perhaps most commonly

as fertilizer in agriculture. The fluid is not flammable, nor is it dangerous when handled normally. However, it is corrosive to metal, particularly copper or aluminium. Read the separate section concerning the handling of DEF solution.

## Diesel Exhaust Fluid (DEF) Handling

When handling DEF solution, it is important that electrical connectors to be connected or well encapsulated. Otherwise there is a risk that the DEF will cause oxidation that cannot be removed. Water or compressed air do not help, since DEF quickly oxidizes metal. If a

connector comes into contact with the DEF solution it must be replaced immediately to prevent the DEF solution from creeping further into the copper wiring, which takes place at a speed of about 60 mm (2.4 in) per hour.



### CAUTION

When detaching hoses and components, do not spill DEF on disconnected connectors. If DEF is spilled on a connector, the connector must be replaced immediately.

## 24 Exhaust Aftertreatment System

---

### About spilled Diesel Exhaust Fluid (DEF)

Things to know about spilled Diesel Exhaust Fluid (DEF)

- If urea solution comes into contact with the skin, rinse with plenty of water and remove contaminated clothing.
- If urea solution comes into contact with eyes rinse for several minutes and call for medical help if necessary
- If inhaled breathe fresh air and call for medical help if necessary
- Do not allow the DEF solution to come into contact with other chemicals
- The DEF solution is not flammable. If the DEF solution is exposed to high temperatures for long periods of time, it breaks down into ammonia and carbon dioxide

- The DEF solution is corrosive to certain metals, including copper and aluminium. This is similar to the corrosion caused by salt water
- If the DEF solution is spilled onto the vehicle, wipe off the excess and rinse with water. Spilled DEF solution can form concentrated white crystals on the vehicle. Rinse off these crystals with water.

**Note:** Do not flush DEF into the normal drain system.



#### WARNING

DEF split onto hot components will quickly vaporize. Turn your face away!

## Warranty and Maintenance

### Exhaust Aftertreatment System Maintenance

The vehicle must be taken to an authorized Prevost Service Center to remove the ash from the Aftertreatment Diesel Particulate Filter and clean the Aftertreatment Doser.

### Emissions Maintenance

1. If owner's manual recommends Aftertreatment DPF replacement within useful life, the manufacturer must pay for the replacement; however, a random failure within the useful life is covered only per the above warranty provisions.
2. First maintenance interval in life of the engine is allowed at 160 000 kilometers (100,000 miles), 3000 hours.

## 26 Exhaust Aftertreatment System

---

### Engine Gaseous Emission Control Systems

#### WARRANTY MAINTENANCE

#### GASEOUS EMISSION CONTROL SYSTEMS WARRANTY

Prevost warrants the Emission Control Systems on each new VOLVO diesel engine in a new Prevost coach to comply with all United States Federal and Canadian emissions regulations applicable at the time of manufacture of the engine, and to be free from defects in material and workmanship under normal use and service up to 60 months, or 100,000 miles, whichever occurs first, provided all Prevost, maintenance requirements are followed as described in this manual. All warranty periods are calculated from the date-in-service of the new vehicle. The repair or replacement of defective parts will be made without charge for the cost of parts and, if repairs are made at an authorized Prevost Service Center, there will be no charge for labor. Prevost's obligation under this warranty is limited to the repair or replacement, at Prevost's option, of any part(s) of the Emission Control Systems of such engine and/or vehicle found to be defective upon examination by Prevost and provided that such part(s) were returned to Prevost or its nearest authorized Service Center within a reasonable period of time.

#### *Qualifications and Limitations:*

**Note: Not covered** by the Emissions Control Systems Warranty:

- Malfunctions caused by misuse, improper adjustments, modification, alteration, tampering, disconnection, improper or inadequate maintenance and use of improper diesel fuel or DEF.
- Damage resulting from accident, acts of nature or other events beyond the control of Prevost.
- Inconvenience, loss of use of the vehicle, commercial loss of any kind including, but not limited to, consequential or incidental damages
- Any vehicle in which the odometer has been altered or damaged so that mileage cannot be readily determined.

**THIS WARRANTY IS EXPRESSLY IN LIEU OF ALL OTHER WARRANTIES AND REPRESENTATIONS OR CONDITIONS, STATUTORY OR OTHERWISE, EXPRESSED OR IMPLIED INCLUDING, BUT NOT LIMITED TO, IMPLIED WARRANTY OF MERCHANTABILITY OR FITNESS FOR A PARTICULAR PURPOSE.**



## Emissions Control System Warranty

The following engine components are covered by the supplemental emissions control system warranty policy as required by the Federal code of emission regulations.

- 1 Engine Turbocharger Assembly
    - Engine VGT Actuator
  - 2 Engine Charge Air Cooler (CAC)
    - CAC Pipes (Air inlet to/from CAC)
    - CAC Hoses
  - 3 Engine Control Module (ECM)
  - 4 Engine Injectors
  - 5 Engine and Vehicle Wire harness ( repair to circuits related to Emissions Warrantable Components )
  - 6 Exhaust Gas Recirculation (EGR) Mixer Tube
  - 7 EGR Cooler
  - 8 EGR Valve and EGR Valve Control
  - 9 EGR Pipes - Engine Exhaust Manifold to EGR Cooler
  - 10 EGR Pipes - EGR Cooler to Inlet Manifold
  - 11 Crankcase Breather (CCB)
  - 12 Crankcase Breather Oil Separator
  - 13 Crankcase Tubing and Hoses before CCB Oil Separator
  - 14 Aftertreatment Wiring Harness
  - 15 Aftertreatment Control Module (ACM)
  - 16 Aftertreatment Diesel Particulate Filter (DPF) Assembly
    - A. Aftertreatment DPF Assembly with Aftertreatment Diesel Oxidation Catalyst (DOC)
      - Aftertreatment Hydrocarbon Doser (HCD)
      - Diffuser Pipe (Aftertreatment Hydrocarbon Doser Mounting)
      - Fuel lines to Aftertreatment Hydrocarbon Doser
  - Aftertreatment Fuel Shutoff Valve
  - Aftertreatment Fuel Pressure Sensor
  - Discharge Recirculation Valve (DRV) (Heat Mode)
  - Discharge Recirculation Valve (DRV) Solenoid
  - Engine Turbocharger Compressor Bypass Actuator (Heat Mode)
  - Engine Turbocharger Compressor Bypass Actuator Solenoid
  - Engine Exhaust Gas Temperature (EGT) Sensor
  - Aftertreatment DPF Intake Temperature Sensor
  - Aftertreatment DPF Outlet Temperature Sensor
  - Aftertreatment DPF Differential Pressure Sensor
  - Aftertreatment Hydrocarbon Doser Air Supply Regulator (if applicable), Supply Lines, and Fittings
- 17 Sensors:
- Crankshaft Position (CKP) Sensor
  - Camshaft Position (CMP) Sensor
  - Engine Coolant Temperature (ECT) Sensor
  - Intake Manifold Air Temperature/Pressure Sensor
  - EGR Temperature Sensor
  - Aftertreatment Outlet NOx Sensor
  - Aftertreatment Intake NOx Sensor
  - EGR Differential Pressure
  - Ambient Air Temperature (AAT)
- 18 SCR

## 28 Exhaust Aftertreatment System

---

- Aftertreatment Selective Catalytic Reduction (SCR) Catalyst
  - Aftertreatment Diesel Exhaust Fluid (DEF) Pump
    - Aftertreatment DEF Dosing Absolute Pressure Sensor
    - Aftertreatment DEF Return Valve
  - Aftertreatment DEF Dosing Valve
  - Aftertreatment DEF Tank
  - Aftertreatment DEF Tank Heater/Sender
  - Aftertreatment DEF Tank Heater
  - Aftertreatment DEF Tank Heater Valve
  - Aftertreatment DEF Tank Temperature Sensor
  - Aftertreatment DEF Level Sensor
  - Aftertreatment DEF Heated Lines
19. Instrument Cluster (Repair of microprocessor , OBD MIL, Real Time Clock, Aftertreatment DEF Tank Gauge and, Aftertreatment DEF Tank Low Level Indicator)
  20. Exhaust Gas Piping (from Turbocharger to Aftertreatment System )
  21. Data Link Connector (DLC)

## Engine Gaseous Emissions Control System Warranty

The emission warranty for the diesel particulate filter and SCR Systems covers defects in workmanship only. Normal maintenance, such as cleaning ash from the filter at regular maintenance intervals and cleaning the Aftertreatment fuel injector on Diesel Oxidation Catalyst (DOC) DPF systems, is not covered by the emission warranty. With the Thermal Regeneration DPF system, cleaning the ignition electrodes and fuel injection nozzle at the regular maintenance intervals is considered normal maintenance and not covered by the emission warranty.

## Federal Emission Requirements

This section covers the requirement of the United States Clean Air Act which states: “The manufacturer shall furnish with each new motor vehicle or motor vehicle engine such written instructions for the maintenance and use of the vehicle or engine by the ultimate purchaser as may be reasonable and necessary to assure the proper functioning of emission control devices and systems. ”This section also covers the requirements of the emissions regulations promulgated under the Motor Vehicle Safety Act in Canada.

**TAMPERING WITH GASEOUS EMISSION CONTROL SYSTEMS PROHIBITED**

The Federal Clean Air Act prohibits the removal or rendering inoperative of any device or element of design installed on or in a motor vehicle or motor vehicle engine in compliance with Federal Emission Regulations by:

- 1 Any person prior to its sale and delivery to the ultimate purchaser, or
- 2 Any manufacturer or distributor after its sale and delivery to the ultimate purchaser, or
- 3 Any person engaged in the business of repairing, servicing, selling, leasing, or trading motor vehicles or motor vehicle engines following its sale and delivery to the ultimate purchaser, or
- 4 Any person who operates a fleet of motor vehicles following its sale and delivery to the ultimate purchaser.

### Emission Control System Warranty — California

The California Air Resources Board and Prevest. are pleased to explain the California emission control system warranty on your new motor vehicle engine. In California, new motor vehicle engines must be designed, built and equipped to meet the State's stringent anti-smog standards. Prevest. must warrant the emission control system on your engine for the period of time listed below provided there has been no abuse, neglect, or improper maintenance of your engine. Your emission control system may include parts such as the fuel-injection system, turbocharger assembly, electronic control module and other emission-related assemblies.

Where a warrantable condition exists, Prevest will repair your engine at no cost to you including diagnosis, parts, and labor. **MANUFACTURER'S WARRANTY COVERAGE:** If an emission-related part of your engine is defective, the part will be repaired or replaced by Prevest. This is your emission control system DEFECTS WARRANTY.

## 30 Exhaust Aftertreatment System

---

### OWNER'S WARRANTY RESPONSIBILITIES:

As the motor vehicle engine owner, you are responsible for the performance of the required maintenance listed in this manual. Prevost recommends that you retain all receipts covering maintenance of your vehicle, but Prevost cannot deny warranty solely for the lack of receipts or for your failure to ensure the performance of all scheduled maintenance listed in other manuals which were supplied with your vehicle. You are responsible for presenting your motor vehicle engine to a Prevost Service Center as soon as a problem exists. The warranty repairs should be completed in a reasonable amount of time, not to exceed 30 days. As the motor vehicle engine owner, you should also be aware that Prevost may deny you warranty coverage if your vehicle or a part has failed due to abuse, neglect, improper maintenance, or unapproved modifications. If you have any questions regarding your warranty rights and responsibilities, you should contact the Prevost Department 850 Chemin Olivier, St-Nicolas, Qc, G7A 2N1, Canada, Fax 418-831-9301, or the California Air Resources Board at 9480 Telstar Avenue, El Monte, California 91731. **(Applicable only to vehicles and/or engines certified for sale and registered in the State of California)** Prevost warrants the Emission Control Systems on each new VOLVO diesel engine in a new Prevost coach to comply with all State of California emissions regulations applicable at the time of manufacture of the engine, and to be free from defects in material and workmanship under normal use and service up to 60 months or 160 000 km (100,000 miles), whichever occurs first, provided all Prevost maintenance requirements are followed as described in this manual. All warranty periods are calculated from the date-in-service of the new vehicle. The repair or replacement of defective parts will be made without charge for the cost of parts and, if repairs are made at an authorized Prevost Service Center, there will be no charge for labor. Prevost's obligation under this warranty is limited to the repair or replacement, at Prevost's option, of any part(s) of Emission Control Systems of such engine and/or vehicle found to be defective upon examination by Prevost and provided that such part(s) were returned to Prevost or its nearest authorized Dealer within a reasonable period of time.

### *Qualifications and Limitations:*

**Not covered** by the Emissions Control Systems Warranty:

- Malfunctions caused by misuse, improper adjustments, modification, alteration, tampering, disconnection, improper or inadequate maintenance and use of improper diesel fuel or DEF.
- Damage resulting from accident, acts of nature or other events beyond the control of Prevost
- Inconvenience, loss of use of the vehicle, commercial loss of any kind including, but not limited to, consequential or incidental damages.
- Any vehicle in which the odometer has been altered or damaged so that mileage cannot be readily determined.

**THIS WARRANTY IS EXPRESSLY IN LIEU OF ALL OTHER WARRANTIES AND REPRESENTATIONS OR CONDITIONS, STATUTORY OR OTHERWISE, EXPRESSED OR IMPLIED INCLUDING, BUT NOT LIMITED TO, IMPLIED WARRANTY OF MERCHANTABILITY OR FITNESS FOR A PARTICULAR PURPOSE.**

## 32 Exhaust Aftertreatment System

---

### Emissions Control System Warranty

The following engine components are covered by the supplemental emissions control system warranty policy as required by the California code of regulations.

- 1 Engine Turbocharger Assembly
  - Engine VGT Actuator
- 2 Engine Charge Air Cooler (CAC)
  - CAC Pipes (Air inlet to/from CAC)
  - CAC Hoses
- 3 Engine Control Module (ECM)
- 4 Engine Injectors
- 5 Engine and Vehicle Wire harness ( repair to circuits related to Emissions Warrantable Components )
- 6 Exhaust Gas Recirculation (EGR) Mixer Tube
- 7 EGR Cooler
- 8 EGR Valve and EGR Valve Control
- 9 EGR Pipes - Engine Exhaust Manifold to EGR Cooler
- 10 EGR Pipes - EGR Cooler to Inlet Manifold
- 11 Crankcase Breather
- 12 Engine Crankcase Breather Oil Separator
- 13 Crankcase Tubing and Hoses before Separator
- 14 Aftertreatment Wiring Harness
- 15 Aftertreatment Control Module (ACM)
- 16 Aftertreatment Diesel Particulate Filter (DPF) Assembly
  - A. Aftertreatment DPF Assembly with Aftertreatment Diesel Oxidation Catalyst (DOC)
    - Aftertreatment Hydrocarbon Doser (HCD)
  - Diffuser Pipe (Aftertreatment Hydrocarbon Doser Mounting)
  - Fuel lines to Aftertreatment Hydrocarbon Doser
  - Aftertreatment Fuel Shutoff Valve
  - Aftertreatment Fuel Pressure Sensor
  - Discharge Recirculation Valve (DRV) (Heat Mode)
  - Discharge Recirculation Valve (DRV) Solenoid
  - Engine Turbocharger Compressor Bypass Actuator (Heat Mode)
  - Engine Turbocharger Compressor Bypass Actuator Solenoid
  - Engine Exhaust Gas Temperature (EGT) Sensor
  - Aftertreatment DPF Intake Temperature Sensor
  - Aftertreatment DPF Outlet Temperature Sensor
  - Aftertreatment DPF Differential Pressure Sensor
  - Aftertreatment Hydrocarbon Doser Air Supply Regulator (if applicable), Supply Lines and Fittings

## 17 Sensors:

- Crankshaft Position (CKP) Sensor
- Camshaft Position (CMP) Sensor
- Engine Coolant Temperature (ECT) Sensor
- Intake Manifold Air Temperature/Pressure Sensor
- EGR Temperature Sensor
- Aftertreatment Outlet NOx Sensor
- Aftertreatment Intake NOx Sensor
- EGR Differential Pressure Sensor
- Ambient Air Temperature (AAT) Sensor
- Aftertreatment DEF Return Valve
- Aftertreatment DEF Dosing Valve
- Aftertreatment DEF Tank
- Aftertreatment DEF Tank Heater/Sender
- Aftertreatment DEF Tank Heater
- Aftertreatment DEF Tank Heater Valve
- Aftertreatment DEF Tank Temperature Sensor
- Aftertreatment DEF Level Sensor
- Aftertreatment DEF Heated Lines

## 18 SCR

- Aftertreatment Selective Catalytic Reduction (SCR) Catalyst
- Aftertreatment Diesel Exhaust Fluid (DEF) Pump
  - Aftertreatment DEF Dosing Absolute Pressure Sensor

19. Instrument Cluster (Repair of microprocessor , OBD MIL, Real Time Clock, Aftertreatment DEF Tank Gauge and, Aftertreatment DEF Tank Low Level Indicator)

20. Exhaust Gas Piping (from Turbocharger to Aftertreatment System )

21. Data Link Connector (DLC)

## 34 Exhaust Aftertreatment System

### Engine Components, Service Schedules

Component	Operation	Km (Miles)/Maximum Months/Hours
Engine Fuel Filter	Change	Each oil change *
Water Separator	Filter change	Each oil change *
Air Filter US 2010	Change	160 000 (100,000) or 12 months, whichever comes first
Engine Coolant	Change	500 000 (300, 000) or 24 months, whichever comes first
Engine Coolant (ELC)	Change	1 000 000 (600,000) or 48 months, whichever comes first
Coolant Filter US 2010	Change	80 000 (50,000) or 6 months, whichever comes first
Engine Coolant Filter (ELC) US 2010	Change	240 000 (150,000) or 12 months, whichever comes first
Valves/Engine Injectors **	Initial Adjust	200 000 (125,000) or 12 months, whichever comes first
Valves/Engine Injectors **	Adjust	400 000 (250,000) or 24 months, whichever comes first
Catalyzed DPF Filter (If equipped)	Change	400 000 (250,000) or 4,500 hours, whichever comes first.
Aftertreatment Diesel Exhaust Fluid Dosing Valve	Clean	240 000 (150,000) or 4,500 hours, whichever comes first.
Aftertreatment Diesel Exhaust Fluid (DEF) Pump Filter	Change	First Change; 161 000 (100,000), 3200 hours or three (3) years. Then every 241 000 (150,000) 4800 hours or three (3) years, whichever comes first.
Diesel Exhaust Fluid (DEF) Tank Filler Neck Filter Cleaning	Clean	280 000 (175,000) or 12 months, whichever comes first.

\*Under certain conditions (for example, irregular fuel quality), the fuel/water separator filters may require more frequent replacement.

\*\*Valves must be adjusted whenever the rocker shaft has been removed and reinstalled for any reason.





**VOLVO**

**Volvo Bus Corporation**

Göteborg, Sweden

# Operating Instructions

## WHEEL CHAIR LIFT

9700 Bus

**VOLVO**

# Foreword

This manual contains information concerning the operation and function of the Wheel Chair Lifter mounted on the 9700 US/CAN.

Illustrations in this manual are used for reference only and may differ slightly from the actual vehicle. However, key components addressed in this document are represented as accurately as possible.

The National Highway Traffic Safety Administration (NHTSA) and Prevost should be informed immediately if you believe that the vehicle has a defect that could cause a crash, injury or death.

Contact NHTSA by calling the Auto Safety Hotline at 1(888) 327-4236, by writing to NHTSA, U.S Department of Transportation, Washington, DC 20590, by TTY at 1 (800) 424-9153, or visit their web site at [www.nhtsa.dot.gov](http://www.nhtsa.dot.gov).

## **Volvo Bus Corporation**

Göteborg, Sweden

**Order number: 89146318**

©2014 Volvo Bus Corporation, Göteborg, Sweden

All rights reserved. No part of this publication may be reproduced, stored in retrieval system, or transmitted in any forms by any means, electronic, mechanical, photocopying, recording or otherwise, without the prior written permission of Volvo Bus Corporation

---

# Contents

<b>Introduction</b> .....	1
Introduction .....	1
General Safety Precautions .....	3
Major Lift Components .....	4
<b>Operating Instructions</b> .....	7
Operating Instructions .....	7
Daily Safety Check .....	10
Platform Motions .....	11
Controls and Indicators .....	12
Normal Lift Operation .....	19
Manual Lift Operation .....	32
<b>Maintenance</b> .....	38
Cleaning .....	38
Maintenance Schedule .....	38
<b>Index</b> .....	41



---

# Safety Information

**IMPORTANT:** Before driving this vehicle, be certain that you have read and that you fully understand each and every step of the driving and handling information in this manual. Be certain that you fully understand and follow all safety warnings.

It is important that the following information be read, understood and always followed.

The following types of advisories are used throughout this manual:



## DANGER

Danger indicates an unsafe practice that could result in serious personal injury or death. A danger advisory banner is in **white** type on a **black** background with a **black** border.



## WARNING

Warning indicates an unsafe practice that could result in personal injury. A warning advisory banner is in **black** type on a **gray** background with a **black** border.



## CAUTION

Caution indicates an unsafe practice that could result in damage to the product. A caution advisory is in **black** type on a **white** background with a **black** border.

**Note:** Note indicates a procedure, practice, or condition that must be followed in order for the vehicle or component to function in the manner intended.

---



## Introduction

The bus Volvo 9700 US/CAN could be equipped with a Wheel Chair Lifter, intended to provide wheelchair access to the vehicle.

The mechanical linkages provide smooth movement to the platform, which has a rated load capacity of 600 pounds (273 kilograms). Five hydraulic cylinders are employed to move the lift components. Two cylinders are mounted within the scissors assembly to extend and retract the platform assembly. A third cylinder raises and lowers the inner barrier.

The remaining two cylinders raise and lower the platform assembly. The movement of these cylinders is multiplied by a chain lift connected between the intermediate frame (rear portion of platform assembly) and the platform itself. As the cylinders lift the intermediate frame the chain lift doubles the movement of the platform assembly.

The lift contains an electro-hydraulic pump with a built-in manual backup pump. If the lift loses electrical power, it can be raised or lowered manually. The cylinders are controlled by solenoid valves that are operated manually if there is an electrical failure.

## 2 Introduction

---

Platform movement is controlled with buttons on the hand held pendant. By using the buttons, the lift is extracted from the vehicle storage compartment and lowered to the ground level. The passenger boards the large non-skid platform and the operator uses the buttons to raise the platform to vehicle floor level. After the passengers departs, the platform is raised and retracted back into the vehicle. A similar procedure is used to exit.

This manual contains information about safety precautions, operating instructions, and maintenance. It is important to user safety that the lift operator be completely familiar with the operating instructions. Once the lift is installed, it is very important that the lift be properly maintained by following the Volvo recommended maintenance and inspection instructions.

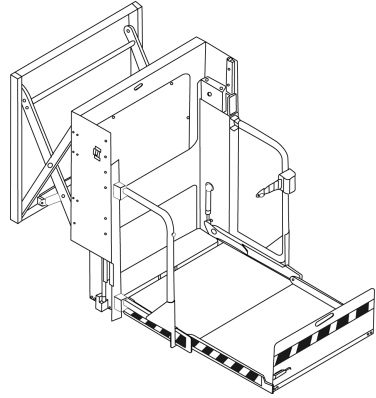

T8053922

## **General Safety Precautions**

The following general safety precautions must be followed during operation and maintenance:

- To avoid injury, always exercise caution when operating lift and be certain that hands, feet, legs, and clothing are not in the path of product movement.
- Read and thoroughly understand the operating instructions.
- Inspect the product before each use for unsafe conditions, and unusual noises or movements. Do not use lift until any problems are corrected.
- Stand clear of doors and platform and keep others clear during operation.
- The product requires regular periodic maintenance. A thorough inspections is recommended at least once every six months. The product should be maintained at the highest level of performance.

## 4 Introduction

### Major Lift Components

The terms used throughout are illustrated in the picture and defined in the table.

BAYLIFT TERM DEFINITIONS	
TERM	DESCRIPTION
Left, right, front, rear	Position references when installed lift is viewed from outside of vehicle.
Access panel	Provides easy access to components located behind intermediate.
Audible alarm	(not shown) Announces that something has passed through doorway threshold area and platform. Is 71” from vehicle floor level and is activated by threshold warning system (TWS). Refer to “Threshold Warning System” in chapter “Operating Instructions”.
Bridgeplate	Plate bridges gap between platform and vehicle floor when platform is at floor level. Acts as rear barrier during up and down platform motions to prevent wheelchair from rolling off of platform.
Control pendant	Hand-held device controls platform motions.
Cycle counter viewport	When platform is stowed the counter can be see here. It records number of times platform has moved from floor to ground and back to floor.
Electronic controller	Receives input signals from pendant and lift sensors and sends control signals to pump motor and hydraulic controller.
Front and rear platform sections	Lift components where wheelchair and occupant are situated during UP and DOWN platform motions. Folds and stows into platform frame.
Front rollstop	Front barrier prevents the wheelchair from inadvertently rolling off platform during platform movements.
Front rollstop latch	Manually operated latch locks front rollstop in stowed position. Rollstop is locked in upright position by dropping into slots.
Handrail	(left and right) Provides a handhold for standing passenger (standee).

Handrail latch	(left and right) Manually operated latch locks handrail in outward or inward position. Push handrail downward to release latch.
Hydraulic controller	Electro-hydraulic, solenoid valve system controls distribution of hydraulic fluid to cylinders. Receives input signals from electronic controller.
Hydraulic pump and reservoir	Hydraulic pump is driven by electric motor and procedures pressure to extend and raise platform and to raise bridgeplate.
Intermediate frame	Rigid structure suspended on outer ends of scissor assembly. Platform frame is attached to front face.
Maintenance safety pin	(left and right) Maintenance item that is employed to lock platform in position on intermediate frame. Must be removed for normal operation.
Manual backup pump handle	Use to operate manual backup pump when electrical power is not available.
Manual bypass knobs	Four knobs are employed during manual operation to control distribution of hydraulic fluid to preferred lift cylinders.
Manual pressure release valve	Opening valve bleeds pressure from hydraulic system, allowing platform or bridgeplate to lower.
Pendant holders	(up to three each, depending on application) Storage clips for pendant. One clip is attached to bottom of platform.
Platform frame	Structure that platform and handrails attach to. Moves up and down on sliders fastened to intermediate frame.
Platform latch	Magnetic catch that holds folded platform sections in upright position.
Reservoir dipstick	Use to determine fluid level in reservoir.
Safety belt	Safety restraint belt that spans between handrails to confine passenger.

# 6 Introduction

<p>Scissors assembly</p>	<p>(left and right) Telescoping components that support intermediate frame and platform, and allow horizontal movement.</p>
<p>Visual alarm</p>	<p>(not shown) Flashing red light makes it know that something has passed through doorway threshold area. Activated by threshold warning system (TWS). Refer to “Threshold Warning System”.</p>

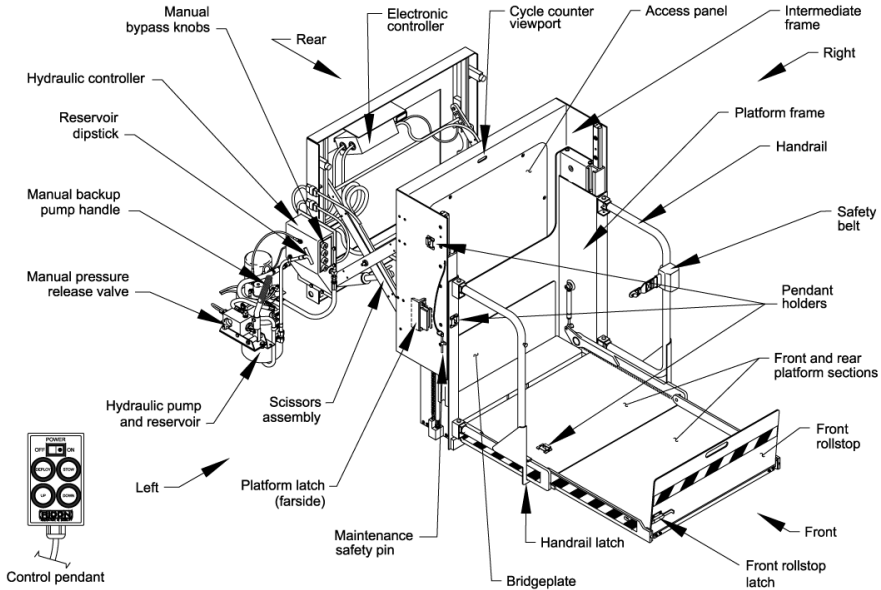

## Operating Instructions

The following safety precautions must be complied with when operating lift.

- Deploying the lift when vehicle is on sloped ground is hazardous. Operate lift with vehicle parked on level ground.
- Vehicle must be safely parked with parking brake set before using lift.
- Inspect lift before use. Do not use lift if an unsafe conditions exists, or unusual noises or movements are noticed, and contact a Volvo authorized service technician for repair.
- Read and comply with all warning labels affixed to wheel chair lift and vehicle.
- Wheelchair occupant should face outward on platform when entering or exiting vehicle to minimize the possibility of the large rear wheels rolling up and over the front rollstop.



T8053924

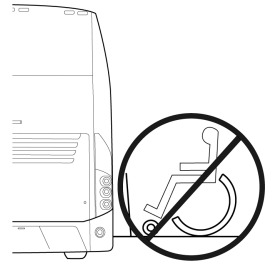

T8053925

## 8 Operating Instructions

---

- Do not load an oversize wheelchair into vehicle if it is too large to pivot freely inside vehicle.
- Do not place large equipment inside vehicle that can prevent pivoting of a wheelchair. Being able to pivot assures that a passenger can safely exit facing outward.
- Do not rely on a threshold-warning device (audible, or other) to confirm that is safe for a passenger to exit backwards. This device may be inoperative or unheard, and they might exit backwards when the platform is on the ground!
- When exiting vehicle, verify that platform is at same height as floor and front rollstop is upright and locked.



### WARNING

Do not operate with a load in excess of 600 lbs (273 kgs).

- The upright front rollstop inhibits slow and unintentional rolling off the platform. It is not intended to stop a fast-moving wheelchair, which might tip forward if the small front wheels collide with the rollstop.
- Be certain wheelchair fits safely on platform; it must not extend beyond edges or interfere with rising and locking of front rollstop.
- Keep arms, legs, and clothing away from moving lift parts.
- The lift is intended for one wheelchair and occupant, or one standee. Do not overload lift.



- Do not stand in front of lift while deploying platform.
- Keep others clear while operating lift.
- Do not allow an untrained person to operate lift.
- Careful supervision is necessary if used near children.
- Lock wheelchair brakes when on platform (power chair users must turn off power and set brake).
- Use great care in wet conditions, because the wheelchair brakes are less effective if wheels or platform are wet.
- Never leave platform outside of vehicle. Return platform to stowed position after use.

Read and understand safety precautions. Review them periodically and ask other operators to read them.

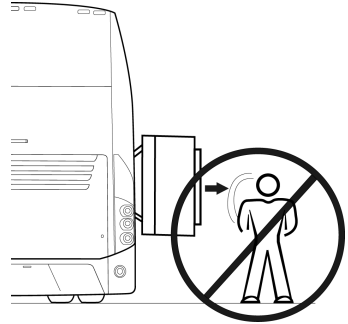

T8053926

# 10 Operating Instructions

---

## Daily Safety Check

Inspect the lift before each use and check that the following conditions are met before operating:

- All functions operate properly and there are no unusual noises or movements. If problems are present, contact a Volvo authorized workshop for repair or, a Prevost service center/provider.
- Vehicle interlock is operating properly.
- No objects that may interfere with operation are present.
- General appearance and lubrication are satisfactory, and fasteners are tight.

## Platform Motions

**Note:** The platform is an assembly comprised of the intermediate frame, platform frame, handrails, front and rear platform sections, bridgeplate, and front rollstop. Note that up and down motions operate only when platform is fully extended.

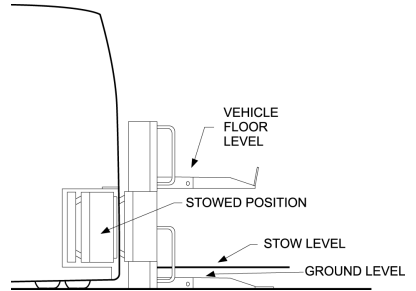

T8053932

PLATFORM MOTIONS	
MOTION	DESCRIPTION
<p>T8053927</p>	Platform moves outward from lift compartment.
<p>T8053928</p>	Platform lowers towards ground level. Bridgeplate automatically rises when platform drops below floor level.
<p>T8053929</p>	Platform rises towards vehicle floor level. Bridgeplate automatically lowers when platform arrives at floor level.
<p>T8053930</p>	Platform moves downwards towards stow level and then retracts into lift compartment. If platform is below stow level, it must first be raised above stow level.

# 12 Operating Instructions

---

## Controls and Indicators



### **WARNING**

The lift is allowed to operate only when the lift and vehicle interlock circuitry requirements are met. Do not attempt to operate lift with interlock bypassed.



### **CAUTION**

The pendant must be attached to the clip located on the bottom of the platform when the platform is stowed. The pendant can be severely damaged by the lift compartment doors if left stored on either of the other clips.

## Control Pendant

The lift is operated with a hand-held, hard-wired remote-control pendant. Turn on the POWER ENABLE switch and then press an appropriate button to control each lift motion.

The POWER ENABLE switch provides power to the pendant and thereby enables the lift. When turned on, the power switch and each button illuminate.

Pressing the DEPLOY button extends the platform from the storage compartment, and pressing the STOW button retracts the platform back into the storage compartment. Pressing the DOWN button lowers the platform towards the ground, and pressing the UP button raises the platform towards the vehicle floor. A button must be held depressed until the motion is completed. Movement of the platform can be halted at any time by releasing the button.

**Note:** In addition to the four powered operations described above, there are several manual operations required to deploy, lower, and stow the platform. Refer to Manual Lift Operation section.

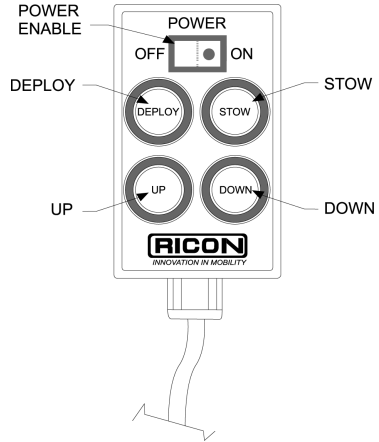

T8053933

# 14 Operating Instructions

---

## Circuit Breakers

### Main Circuit Breaker

The main circuit breaker is located in vehicle battery compartment and is used to interrupt electrical power to lift electrical system when a major short circuit occurs. If problems are present, contact a Volvo authorized workshop or, a Prevost service center, provider.



T8056323

### Control System Circuit Breaker.

The control system circuit breaker is located on the PCB assembly, which is inside the electronic controller. The control system includes essentially all electrical components except the motor that drives the hydraulic pump

## Vehicle Interlock System

The purpose of the vehicle interlock system is to prevent lift operation if it is unsafe to do so. Requirements are that the vehicle transmission be in neutral, the parking brake applied, and the passenger door be opened before power is supplied to the lift. Before the vehicle can depart, the lift must be stowed, and both the lift compartment door and passenger door must be closed.

## **Bridgeplate Load Sensor**

A sensor switch is located in the hydraulic line connected to the bridgeplate hydraulic cylinder. When the sensor detects that an object is present on the bridgeplate it inhibits raising or lowering of the platform. This protects the passenger from possible injury when the cylinder raises the bridgeplate. It also protects the bridgeplate from damage, which could interfere later with proper operation of the lift.

# 16 Operating Instructions

## Threshold Warning System

The threshold warning system is installed at the top of the doorway above the lift compartment. The module is powered on when the lift is powered, and the status indicator light then turns on. The acoustic sensors are enabled when the door is open and the lift-to-vehicle interlock system requirements are met.

**Note:** Installations provide a vehicle door closure signal to the module that will disable the sensors when the door is closed.

Acoustic sensors (transmitter and receiver) monitor the doorway threshold area for the presence of a passenger (or object, such as a wheelchair). If someone is detected in the threshold area when the platform is one inch, or more, below the floor an audible buzzer and flashing red light are actuated.

This system provides a margin of safety for lift passengers by warning them when the platform is below floor level. The platform must be at floor level when a passenger is boarding or exiting the platform.

**Note:** The buzzer and flashing light are disabled when the door is closed. In this case, the status indicator flashes when a passenger presence is detected.

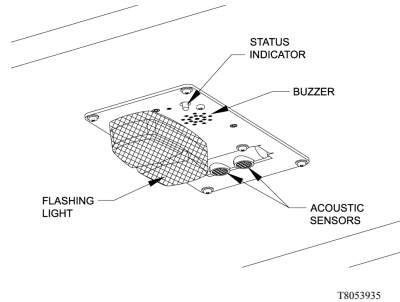



## Lift Cycle Counter

The cycle counter (located near the electronic controller) is visible through a slot at the top center of the intermediate frame, just above the access panel. The platform must be fully stowed to view the counter. The counter advances each time the platform moves through a complete cycle, which consists of the platform moving from the vehicle floor to the ground and back to the floor. The number of cycles displayed is used to schedule maintenance operations.

# 18 Operating Instructions

---

## Manual Backup Pump

The manual backup pump system can operate the lift if electrical power is not functional. The controls for the system consist of a pump handle (not removable) and pressure release valve, which are used in conjunction with four bypass knobs to extend, raise, lower, and retract the platform.

The four bypass knobs shown on the front face of the hydraulic controller are connected to four solenoid valves located inside the enclosure. The open or closed position of each solenoid valve determines how fluid is distributed to the five hydraulic cylinders. The knobs provide the ability open and close the valves manually.

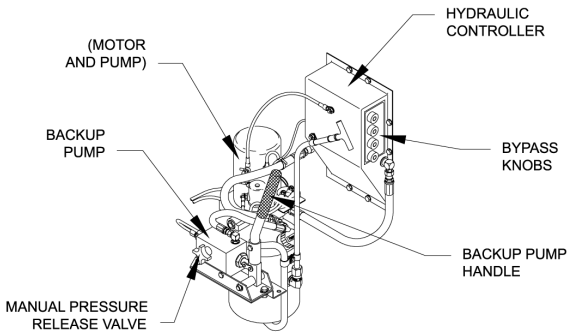

## Normal Lift Operation

- Before operating lift, be certain vehicle is safely parked on a level area away from traffic. Provide space for lift operation and passenger boarding.
- The lift operator must take special care to ensure that area is clear before deploying platform. Be certain there are no obstacles beneath platform.
- When parked adjacent to a curb, the vehicle must be within 26 inches of curb. Rear section of platform must overlap curb a minimum of eight inches.
- Engage the parking brake and turn on the vehicle.
- Turn on lift power switch located on dashboard.
- Open lift compartment door (lower) completely and secure.
- Pull handle located rear to release door lock, insert key in door lock and turn front to open.
- Open the upper door 90°.



T8055670

## 20 Operating Instructions



### CAUTION

Before attempting to raise or lower the platform, verify the two maintenance safety pins are not inserted into intermediate frame and platform. Severe damage can occur if pins are inserted. The pins are normally stored on the side, as shown, and are for maintenance use only.

- Enable lift control pendant by turning on Power switch located on pendant.

**Note:** Attendant must remain near passenger to render immediate assistance when necessary.

**Note:** A person that uses the wheelchair lift while standing (does not require mobility aid equipment) is referred to in this manual as a Standee

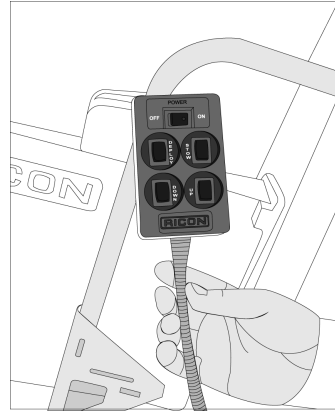

T8054862

## Procedure to move the sliding seats.

Follow the steps below in order to make room for WCL:

- Fold up the armrest.

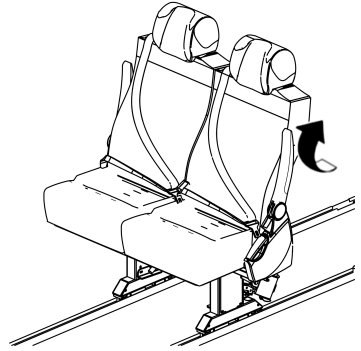

W8091806

- Pull the handle located under the cushion and lift it up.

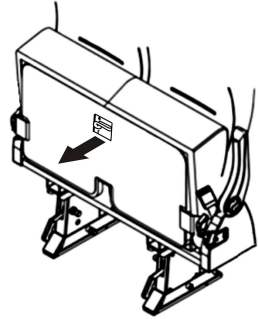

W8091808

- Lift the pedals up.

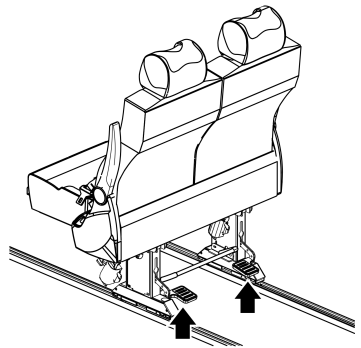

W8091807

## 22 Operating Instructions

---

- Press down the footbar until the seat is unlocked.

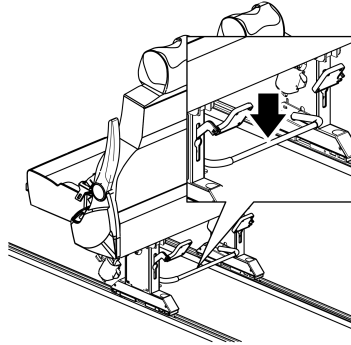

W8091809

- Push the seats. Place the hands on the backrest to move the seats forward. Slide until hear the lock sound.

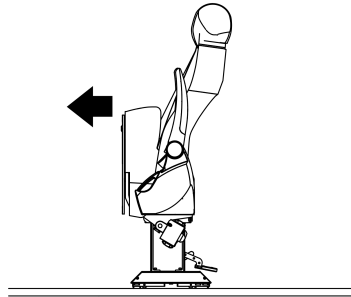

W8092294

- Push the pedals down to lock the seats.

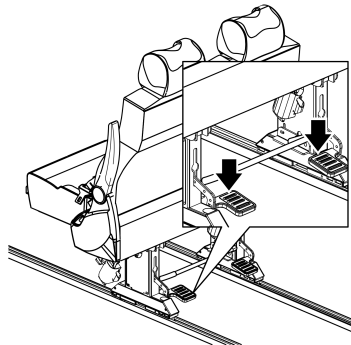

W8091812

Follow the steps below in order to return to original position:

- Lift the pedals up.

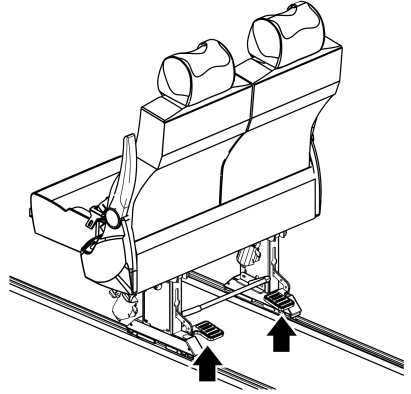

W8091807

- Push down the footbar .

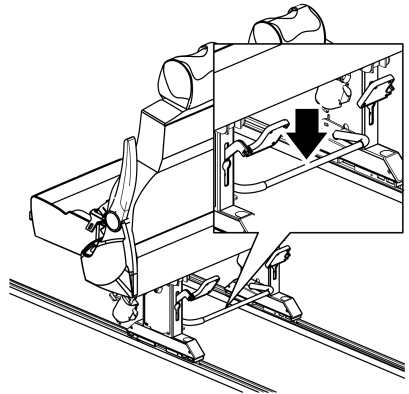

W8091809

- Pull the seats. Place the hands on the backrest to move the seats backward. Slide until hear the lock sound.

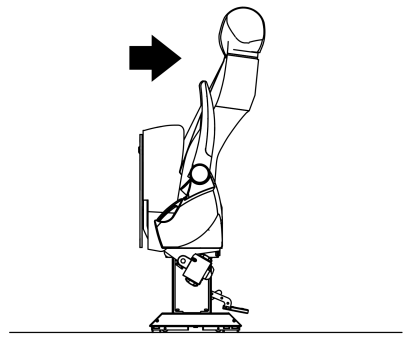

W8091810

## 24 Operating Instructions

---



### CAUTION

The edges of the pedestal need to be aligned with the lateral plate. Do not try to push the pedal down if the pedestal is not aligned with the arrows, if not followed this caution might cause a damage to the lever mechanism.

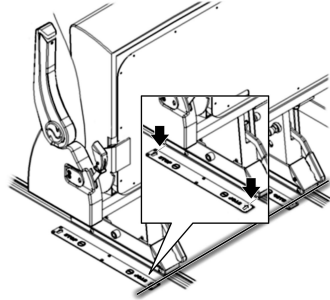

W0087929



**Note:** If any person is located under the sensor or near at door when the platform are in movement, an alarm and the red light will be activated.



## CAUTION

The platform does not automatically stop when being lowered onto a curb, therefore the operator must monitor the height of the platform. Do not allow platform to tilt as shown in left panel. Use the UP button to adjust the platform height, if necessary. Also, do not lower front portion of platform onto curb as shown in right panel.

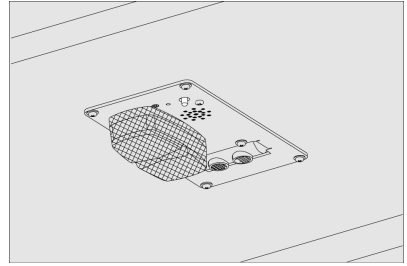

T8054868

### • DEPLOY PLATFORM

Press and hold DEPLOY button until platform is completely extended from lift compartment.

**Note:** Platform cannot be moved up or down unless platform is fully extended.

- Unlatch each handrail by pushing downward and then swinging outward by hand.
- Pull out on top edge of platform to release magnetic latch and lower platform sections to horizontal position; weight of platform is spring assisted.
- Unfold front platform section by grasping handle provided.
- Raise front rollstop to upright position and lock in place by allowing it to drop into the slots at rollstop pivot points.

## 26 Operating Instructions

---

- **LOWER PLATFORM**

Press and hold DOWN button until platform contacts ground. Verify that bridgeplate is in upright position.

- Lift front rollstop out of slots and swing forward until it rests on ground.

- Carefully place wheelchair brakes. Pull safety belt from retractor on handrail and fasten to other handrail.

**Note:** A standee must stand near the center of the platform, facing in the direction of travel (into vehicle), and firmly grasp handrails. Do not stand on bridgeplate.

- Raise front rollstop to upright position and lock in place by allowing it to drop into the slots at rollstop pivot points.

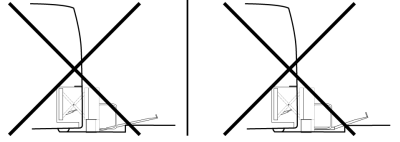

T8053936

- **RAISE PLATFORM**

Press and hold UP button until platform rises and stops automatically at vehicle floor level. Verify that bridgeplate lowers to horizontal position and rests flat on vehicle floor.

- Release wheelchair brakes, and carefully board passenger into vehicle.
- Place wheelchair in position, place brakes and secure with the hooks (located at lower zone from passenger's seats) placing at wheelchair frame.
- Always use the safety belt. Cross the belt from right side to left side and push it into the lock on the left side. After cross the upper belt and secure at lock from low belt.

Make sure an audible click is heard from the clasp in the lock and tug on the belt to verify it has locked.

**Note:** Lock could be stay at the aisle side.

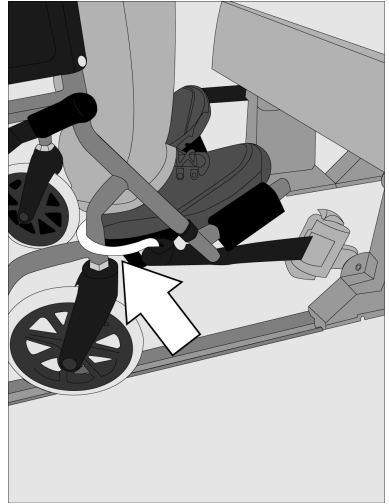

T8055403

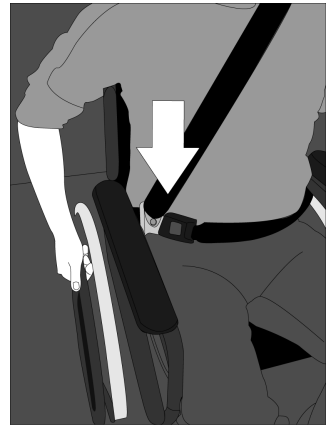

T8055400

## 28 Operating Instructions

---

### Exit Vehicle

- To exit from vehicle, release:
  - 1 the safety belts
  - 2 the wheelchair from hooks
  - 3 brakes from wheelchair
- **DEPLOY PLATFORM**

Press and hold DEPLOY button until platform is completely extended from lift compartment.

**Note:** Platform cannot be moved up or down unless platform is fully extended.
- Unlatch each handrail by pushing downward and then swing outward by hand.
- Pull out on top edge of platform to release magnetic latch and lower platform sections to horizontal position; weight of platform is spring assisted.
- Unfold front platform section by grasping handle provided.
- Raise front rollstop to upright position and lock in place by allowing it to drop into the slots at rollstop pivot points.



#### CAUTION

Be certain wheelchair is safely within platform perimeter and does not interfere with operation of rollstop or bridgeplate.

- Carefully place wheelchair in center of platform, preferably facing outward (away from vehicle), and lock wheelchair brakes. Pull safety belt from retractor on handrail and fasten to other handrail.

**Note:** A standee must stand near the center of the platform, facing in the direction of travel (away from vehicle), and firmly grasp handrails. Do not stand on bridgeplate.

- **LOWER PLATFORM**

Press and hold DOWN button until platform settles at ground level. Verify that bridgeplates is in upright position before platform begins to lower.

**Note:** The platform does not automatically stop when being lowered onto a curb, therefore the operator must monitor the height of the platform. Do not allow platform to tilt as shown in left panel. Use the UP button to adjust the platform height, if necessary

- Lift front rollstop out of slots and swing forward until it rests on ground.
- Unfasten safety belt, release wheelchair brakes, and carefully assist passenger off platform.

# 30 Operating Instructions

## Stow Platform

- Lift front rollstop out of slots and swing to rear until it rests on platform. Latch in place.
- Grasp handle on lower side of front platform section and fold section back onto rear platform section.
- Raise platform sections by hand until they engage magnetic platform latch; weight of platform is spring assisted.
- Swing handrails inward and then push downward and latch handrails into square holes in bottom edge of platform frame.
- Stow platform:
  - If platform is at floor level (or anywhere above stow level) press and hold STOW button until platform lowers to stow level and fully retracts into lift compartment.
  - If platform is at ground level (or anywhere above stow level) press and hold UP button until platform lowers to stow level and fully retracts into lift compartment.

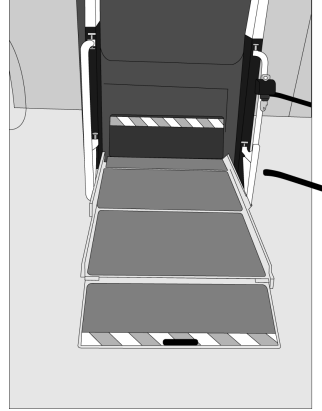

T8054866



### CAUTION

Be certain platform has retracted completely. To prevent damage to lift compartment doors, do not release button until lift pump motor has stopped automatically.

- Turn control pendant power switch off and stow pendant on clip located on bottom of platform.



## CAUTION

The pendant must be attached to the clip located on the bottom of the platform when the platform is stowed. The pendant can be severely damaged by the lift compartment doors if left stored on either of the other clips.

- Close lift compartment doors releasing the locks.
- Turn off lift power switch located on dashboard.

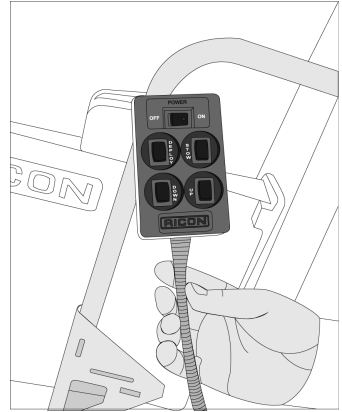

T8054862

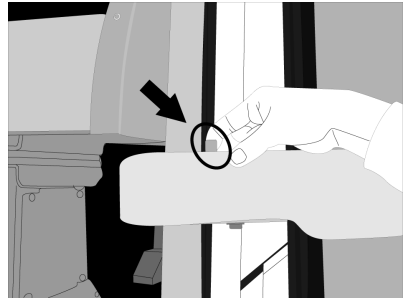

T8054864

## 32 Operating Instructions

---

### Manual Lift Operation

The lift can be operated manually if lift electrical power is not functioning. Its recommend that manual operation be used only to exit from bus, not to enter bus.

Preparation:

- Be certain bus is on a level area and away from traffic. Allow space for platform movement plus space to exit from platform.
- The driver must summon assistance to move bus to a safe area if a break down situation exists where vehicle cannot be moved under its own power.
- Open storage compartment doors.
- The threshold warning system is not active during manual operation and cannot be used to indicate that the platform is at floor height.

The manual backup pump handle and manual pressure release valve are both referred to frequently in the following procedures. Moving its handle back and forth operates the backup pump. The release valve is closed by rotating it clockwise and opened by rotating it counterclockwise. The valve must be kept closed during normal operation.

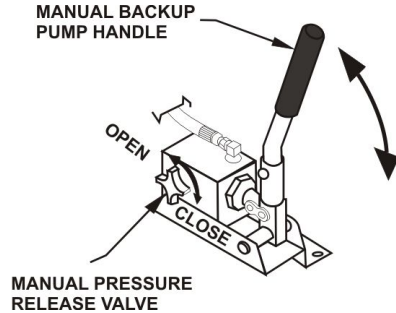

T8055708





## CAUTION

Open the pressure relief valve slowly and only far enough to result in a slow and steady movement of the platform. Avoid opening valve quickly because this will result in sudden and considerable platform movement.

The four bypass knobs shown are also referred to frequently in the following procedures. Push the destination knob inward and rotate to the setting directed in the procedure. Each knob must be in the normal position during normal operation.



## CAUTION

Follow the procedure carefully. Do not open more than one valve at time.

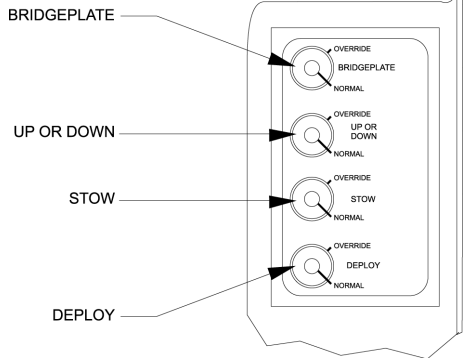

T8053937

# 34 Operating Instructions

---

## 1 DEPLOY PLATFORM

- Verify that pressure release valve is closed.
- Rotate DEPLOY knob to override position.
- Operate hand pump until platform assembly is fully extended from lift compartment.
- Rotate DEPLOY knob to normal position.
- Swing both handrails outward by hand.
- Pull out on top edge of platform to release magnetic latch and lower platform sections to horizontal position; weight of platform is spring assisted.
- Unfold front platform section by grasping handle provided.
- Raise front rollstop to upright position and lock in place by allowing it to drop into the slots at rollstop pivot points.

## 2 RAISE PLATFORM

- Verify that pressure release valve is closed.
- Rotate the UP or DOWN knob to override position.
- Operate hand pump until platform rises to vehicle floor height.
- Rotate the UP or DOWN knob to normal position.
- Rotate BRIDGEPLATE knob to override position.
- Open pressure release valve and allow bridgeplate to lower to floor. Close valve.
- Rotate BRIDGEPLATE knob to normal position.
- Load passenger by carefully placing wheelchair in center of platform, preferably facing outward (away from vehicle), and lock wheelchair brakes. Pull safety belt from retractor on handrail and fasten to other handrail.

## 36 Operating Instructions

---

### 3 LOWER PLATFORM

- Verify that pressure release valve is closed.
- Rotate BRIDGEPLATE knob to override position.
- Operate hand pump until bridgeplate is in upright position.
- Rotate BRIDGEPLATE knob to normal position.
- Rotate UP or DOWN knob to override position.
- Open pressure release valve and allow platform to lower to ground level. Close valve.
- Rotate UP or DOWN knob to normal position.
- Unlock front rollstop and swing forward until it rests on ground.
- Unfasten safety belt, release wheelchair brakes, and carefully assist passenger off platform.

## 4 STOW PLATFORM

- Verify that pressure release valve is closed.
- Rotate the UP or DOWN knob to override position.
- Operate hand pump until top edge of platform frame is at same height as top edge of intermediate frame (stow level).
- Rotate the UP or DOWN knob to normal position.
- Lift front rollstop and swing to rear until it rests on platform. Latch in place.
- Grasp handle on lower side of front platform section and fold section back onto rear platform section.
- Raise platform sections by hand until they engage magnetic platform latch; weight of platform is spring assisted.
- Swing handrails inward and then push downward and latch handrails into square holes in bottom edge of platform frame.
- Rotate STOW knob to override position.
- Operate hand pump until platform assembly is fully retracted into lift compartment.
- Rotate STOW knob to normal position.

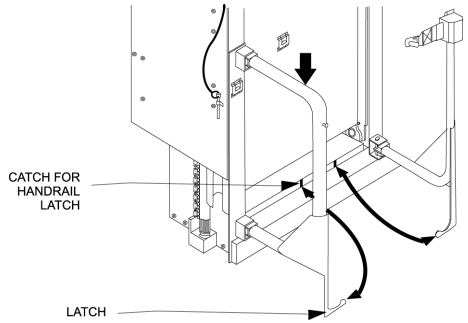

T8055939

## 38 Maintenance

---

### Cleaning

Regular cleaning with mild soap (i.e. liquid hand soap or car wash liquid) and drying thoroughly will protect the lifts painted surfaces. Cleaning is especially important in areas where roads are salted in winter. Make sure that lift pivot points are clean and dry prior to lubrication.

### Maintenance Schedule

Refer to cycle counter located on rear side of hydraulic power unit. Under normal operating conditions, maintenance inspections are required at the frequencies listed in table. Ten cycles is considered a typical number of cycles for one days use.

<b>MAINTENANCE SCHEDULE</b>	
<b>SERVICE POINT</b>	<b>ACTION TO PERFORM</b>
<b>10 CYCLES</b>	
Overall condition	Listen for abnormal noises as lift operates (i.e. grinding or binding noises.)
Control Pendant	<ul style="list-style-type: none"> <li>• Verify that control pendant is undamaged and cable connector is tight.</li> <li>• Verify that switch and buttons are illuminated.</li> </ul>
Threshold warning system (TWS)	Verify that system reliably detects objects in doorway threshold area, when enabled, and actuates the visual and audible alarms.
Bridgeplate load sensor	Verify that sensor inhibits upward and downward movement of platform when a weight is present on the lowered bridgeplate.
<b>150 CYCLES</b>	
Electrical wiring	Inspect electrical wiring for frayed wires, loose connectors, etc.
Vehicle interlock	Place vehicle in non-interlock mode and verify that lift does not operate.
Decals	Verify that lift decals are properly affixed, clearly visible, and legible. Replace, if necessary.
Handrails	Verify that handrail fasteners are properly tightened, and that handrails can be latched securely in position.
Lift mounting points	<ul style="list-style-type: none"> <li>• Verify that the vehicle mounting and support points are undamaged.</li> <li>• Verify that mounting bolts are sufficiently tight and free of corrosion.</li> </ul>
	<div style="border: 1px solid black; padding: 5px; margin-bottom: 5px;">  <b>CAUTION</b> </div> <p>Check and add fluid when platform is at ground level. Fluid that is added when platform is raised will overflow when platform is lowered.</p>

## 40 Maintenance

Main lifting pivots	Verify that pins on scissor arms are properly installed, free from damage, and locked in position.
Platform pivot points	Verify that platform moves freely, without binding, and does not wobble.
Bridgeplate	<ul style="list-style-type: none"><li>• Verify that bridgeplate operates without binding during lift functions.</li><li>• Verify that bridgeplate deploys fully when platform stops at floor level.</li><li>• Verify bridgeplate rests flat against vehicle floor.</li></ul>
Front rollstop	Verify that rollstop pivots freely and can be latched securely in position.
Hydraulic power unit	<ul style="list-style-type: none"><li>• Verify that pump hydraulic fluid level is at FULL mark when platform is at ground level. Add Pentosin G002000 fluid.</li><li>• Verify there are no hydraulic fluid leaks.</li><li>• Verify that manual backup pump operates properly.</li></ul>
Cleaning and lubrication	<ol style="list-style-type: none"><li>1 Clean lift with mild soap and water wipe dry. Prevent rust by coating all surfaces with a light oil. Remove excess oil.</li><li>2 Spray penetrating oil (Curtisol Red Grease 88167 or WD-40) . Remove excess grease from surrounding areas.</li></ol>
<b>3600 CYCLES</b>	
Hydraulic cylinders, hoses, and fittings	<ul style="list-style-type: none"><li>• Check hydraulic cylinders for evidence of leaks.</li><li>• Inspect hydraulic hoses for damage.</li><li>• Verify that all fittings are tight.</li></ul>



## **B**

Bridgeplate Load Sensor ..... 15

## **C**

Circuit Breakers ..... 14

Control and Indicators ..... 12

Control Pendant ..... 13

## **D**

Daily Safety Check ..... 10

## **E**

Exit Vehicle ..... 28

## **G**

General Safety  
Precautions ..... 3

## **I**

Introduction ..... 1

## **L**

Lift Cycle Counter ..... 17

## **M**

Maintenance ..... 38

Major Lift Components ..... 4

Manual Backup Pump ..... 18

Manual Lift Operation ..... 32

## **N**

Normal Lift Operation ..... 19

## **O**

Operating Instructions ..... 7

## **P**

Platform Motions ..... 11

## **S**

Safety Information ..... 5

Stow Platform ..... 30

## **T**

Threshold Warning  
System ..... 16

## **V**

Vehicle Interlock System ..... 14

**VOLVO**

**Volvo Bus Corporation**

Göteborg, Sweden

# **Driver's Handbook**

## **VOLVO D13J Engine Operator's Manual**

PREVH, PREVX, B13R, 9700 USCAN

**VOLVO**

# Foreword

This manual contains information concerning the safe operation of your vehicle. It is extremely important that this information is read and understood before the vehicle is operated. This manual also contains a considerable amount of information concerning the vehicle, such as vehicle identification, Preventive Maintenance recommendations and a log for your service records. Please keep this in the vehicle at all times. Information from other component manufacturers is supplied in separate manuals in the Owners Package.

Illustrations in this manual are used for reference only and may differ slightly from the actual vehicle. However, key components addressed in this document are represented as accurately as possible.

The National Highway Traffic Safety Administration (NHTSA) and Prevost should be informed immediately if you believe that the vehicle has a defect that could cause a crash, injury or death.

Contact NHTSA by calling the Auto Safety Hotline at 1(888) 327-4236, by writing to NHTSA, U.S Department of Transportation, Washington, DC 20590, by TTY at 1 (800) 424-9153, or visit their web site at <http://www.safercar.gov>

## Volvo Bus Corporation

Göteborg, Sweden

**Order number: 89166953**

©2014 Volvo Bus Corporation, Göteborg, Sweden

All rights reserved. No part of this publication may be reproduced, stored in retrieval system, or transmitted in any forms by any means, electronic, mechanical, photocopying, recording or otherwise, without the prior written permission of Volvo Bus Corporation

---

# Contents

<b>VOLVO Engines</b> .....	<b>1</b>
Information For the Owner .....	1
General .....	3
Federal Emission Requirements .....	4
Tampering with exhaust emission control systems Prohibited .....	5
Noise Emissions .....	5
Safety Information .....	11
Proper Maintenance Procedure .....	11
During Maintenance.....	13
Compressed Air and Water .....	14
Asbestos Information .....	14
Fluid Penetration.....	14
Injury Prevention .....	15
Burn Prevention .....	15
Fire or Explosion Prevention .....	17
Engine Damage Prevention.....	23
Before Starting the Engine.....	23
Engine Starting.....	23
Electric and Electronic Systems.....	25
Reporting Safety Defects .....	26
USA.....	26
Canada.....	27
On-Call Assistance.....	27
Introduction.....	27
Fuel .....	28
Engine Oil .....	29
Engine Operation .....	30
Engine Overview, D13J Left Side View .....	33
Engine Overview, D13J Right Side View .....	34
Exhaust Emissions and Aftertreatment Diesel Particulate Filters (DPFs).....	35
Exhaust Aftertreatment System .....	37
DPF Systems .....	39
Selective Catalytic Reduction (SCR) .....	40
Aftertreatment Hydrocarbon Dosing System.....	43
Diesel Exhaust Fluid (DEF).....	44
Aftertreatment Control Module (ACM).....	46
Smart NOx Sensor .....	47
Aftertreatment Inducement Screens.....	49
Aftertreatment DEF Tank Level - Driver Warning & Inducement.....	49
Aftertreatment DEF Quality - Driver Warning & Inducement .....	50
Aftertreatment Tampering - Driver Warning & Inducement .....	52
Misfilling Diesel or Aftertreatment DEF Tanks.....	54
Warranty and Maintenance .....	55
Exhaust Aftertreatment System Maintenance.....	55
Emissions Maintenance .....	55

---

Engine Maintenance Intervals.....	55
Engine Gaseous Emission Control Systems .....	56
Emissions Control System Warranty .....	57
Engine Gaseous Emissions Control System Warranty .....	58
Federal Emission Requirements .....	59
Emission Control System Warranty — California.....	59
Emissions Control System Warranty .....	62
Emission Green House Gas Component Warranty (If Equipped) .....	64
Engine Brake.....	65
Engine Components, Service Schedules.....	66
Cooling System.....	67
General Coolant Information.....	67
Regular Coolant Change Interval.....	70
Extended Life Coolant Change Interval .....	70

---

# Safety Information

**IMPORTANT:** Before driving this vehicle, be certain that you have read and that you fully understand each and every step of the driving and handling information in this manual. Be certain that you fully understand and follow all safety warnings.

IT IS IMPORTANT THAT THE FOLLOWING INFORMATION BE READ, UNDERSTOOD AND ALWAYS FOLLOWED.

The following types of advisories are used throughout this manual:



## DANGER

Danger indicates an unsafe practice that could result in serious personal injury or death. A danger advisory banner is in **white** type on a **black** background with a **black** border.



## WARNING

Warning indicates an unsafe practice that could result in personal injury. A warning advisory banner is in **black** type on a **gray** background with a **black** border.



## CAUTION

Caution indicates an unsafe practice that could result in damage to the product. A caution advisory is in **black** type on a **white** background with a **black** border.

**Note:** Note indicates a procedure, practice, or condition that must be followed in order for the vehicle or component to function in the manner intended.

---



## Information For the Owner

If there are questions on the maintenance and performance of your vehicle, please discuss them with your Prevost Service Manager or Prevost Service Center. Your authorized Prevost Service Center is required to have trained mechanics, special tools and spare parts to fully service your vehicle.

In addition to this Operator's Manual, there may be additional instruction/operators manuals supplied by component manufacturers. These manuals are placed in the Owners Package and placed in the vehicle. Be sure to read all the manuals thoroughly before operating the vehicle.

Also, various safety labels may be placed on components by the component manufacturer. Be sure to read and follow these labels to prevent damage to the vehicle, personal injury or even death.

Information in this manual refers to VOLVO components and VOLVO drivetrain. For detailed information on non-VOLVO drivetrains contact your nearest Prevost Service Center.

Establish a Preventive Maintenance Program with the help of your Prevost Service Center/ Provider. A Preventive Maintenance Program makes it possible to maximize the amount of time your vehicle is up and running, resulting in longer component life. This makes for a safer vehicle by reducing any mechanical failures due to poor maintenance practices.

**Note:** Federal law requires manufacturers to notify owners of its products in the event of a Federal Motor Vehicle Safety Standard or if a safety related defect is discovered. If you are not the original owner of this vehicle, please notify us about the change in ownership at the address below or through an authorized Prevost Service Center. This is the only way we will be able to contact you if necessary.

Prevost Warranty Departement  
850 Chemin Olivier  
St-Nicolas, Qc  
G7A 2N1  
Canada  
Fax: 418-831-930

## 2 VOLVO Engines

---

This Operator's Manual covers all VOLVO vehicles manufactured by Prevost or Volvo Bus, including the whole chassis and all VOLVO manufactured components. For specific maintenance information on vendor components, manufactured by, for example: Fuller, Meritor, etc., see the respective manufacturers service and maintenance literature.

This manual, together with manuals for specific components contain important information to be able to operate this vehicle safely. They contain advice and instructions which will enable you to get the operating economy and performance that you expect from this quality vehicle.

All information, illustrations and specifications contained in this manual are based upon the latest product information available at the time of publication. If any questions arise concerning the current status of Federal or state laws, the appropriate Federal or state agency should be contacted.

**Note:** Illustrations are used for reference only and may differ slightly from the actual vehicle, however, key components addressed in this manual are represented as accurately as possible.

VOLVO Bus Corporation reserves the right to make changes at any time or to change specifications or design without notice and without incurring obligation.

---

## **General**

### *USA*

#### USA

The Federal Clean Air Act, Section 203 (a) (3), states the following concerning the removal of air pollution control devices or modification of a certified engine to a non-certified configuration:

CAA, Section (a) (3) (A) prohibits any person from removing or rendering inoperative any emission control device or element of design installed on or in a motor vehicle or motor vehicle engine in compliance with federal regulations under the Clean Air Act prior to the sale and delivery of the vehicle to the ultimate purchaser. The statute also prohibits any person from knowingly removing or rendering inoperative any emission control device or element of design after sale and delivery of a vehicle or engine to the ultimate purchaser. Any person who violates these provisions either by removing or rendering inoperative emissions control devices prior to the sale or delivery of an engine or vehicle to an ultimate purchaser, or by knowingly removing or rendering inoperative such devices after the sale and delivery of an engine or vehicle to an ultimate purchaser, can be subject to penalties of up to \$3,750 per incident. Any dealer or manufacturer who violates these provisions can be subject to penalties of up to \$37,500 per incident.

### *Canada*

The same conditions that apply in the USA apply to Canada, with one exception. After the vehicle is sold to a retail customer, that is, the end user, the jurisdiction controlling the emission control devices becomes the province in which the vehicle is licensed. No changes should be made that render any or all of the devices inoperative.

Should the owner/operator wish to make any changes to the emission control devices, check with the provincial authority before making any such changes.

### *Mexico*

The same conditions that apply in the USA apply to Mexico. Refer to the Mexican Federal Law for Emission Control which adheres to EPA regulations. No changes should be made that render any or all of the emissions control devices inoperative.

Should the owner/operator wish to make any changes to the emission control devices, check with the state authority before making any such changes.

## 4 VOLVO Engines

---

### Federal Emission Requirements

This section covers the requirement of the United States Clean Air Act which states:

The manufacturer shall furnish with each new motor vehicle or motor vehicle engine such written instructions for the maintenance and use of the vehicle or engine by the ultimate purchaser as may be reasonable and necessary to assure the proper functioning of emission control devices and systems.

This section also covers the requirements of the emissions regulations promulgated under the Motor Vehicle Safety Act in Canada.

## Tampering with exhaust emission control systems Prohibited

The Federal Clean Air Act prohibits the removal or rendering inoperative of any device or element of design installed on or in a motor vehicle or motor vehicle engine in compliance with Federal Emission Regulations by:

- 1 Any person prior to its sale and delivery to the ultimate purchaser, or
- 2 Any manufacturer or distributor after its sale and delivery to the ultimate purchaser, or
- 3 Any person engaged in the business of repairing, servicing, selling, leasing, or trading motor vehicles or motor vehicle engines following its sale and delivery to the ultimate purchaser, or
- 4 Any person who operates a fleet of motor vehicles following its sale and delivery to the ultimate purchaser.

**Note:** For specifics of the prohibited vehicle/engine modifications refer to the Volvo Bus or Prevest documentation.

## Noise Emissions

Prevest warrants to the first person who purchases this vehicle for purposes other than resale and to each subsequent purchaser, that this vehicle as manufactured by Prevest was designed, built and equipped to conform, at the time it left the control of Prevest, with all applicable U.S. EPA Noise Control Regulations.

This warranty covers this vehicle as designed, built and equipped by Prevest, and is not limited to any particular part, component or system of the vehicle manufactured by Prevest Defects in design, assembly or in any part, component or system of the vehicle as manufactured by Prevest, which, at the time it left the control of Prevest caused noise emissions to exceed Federal standards, are covered by this warranty for the life of the vehicle.

## 6 VOLVO Engines

---

### *Noise Control System, Operator Inspection and Maintenance Requirements*

A Noise Control System Maintenance Log is located in this manual. This log should be used to document all Noise Control System related maintenance, whether the maintenance results from a specific noise control system inspection, or a deficiency identified during another general maintenance event.

If additional log space is needed, further entries may be added on a separate sheet of paper. Store these additions with the main log to preserve a comprehensive record. It is recommended that copies of all noise emissions related maintenance invoices be retained.

The following Noise Control System inspection and maintenance instructions contain suggested maintenance intervals. These intervals may need adjustment in order to best accommodate the specific vehicle usage. The following instructions only concern Noise Emissions related items and do not address or modify any general vehicle maintenance requirements.

The following elements make up the Noise Control System:

- Noise Shielding and Insulation Devices
- Cooling System
- Exhaust System/DPF System
- Air Intake/Air Induction System
- Engine Control, EGR and Fuel Systems
- Selective Catalytic Reduction (SCR)

---

## *Tampering with Noise Control System*

Federal law prohibits the following acts or the causing thereof:

(1) The removal or rendering inoperative by any person, other than for purposes of maintenance, repair, or replacement, of any device or element of design incorporated into any new vehicle for the purpose of noise control prior to its sale or delivery to the ultimate purchaser or while it is in use;

or

(2) the use of the vehicle after such device or element of design has been removed or rendered inoperative by any person.

Among the acts that constitute tampering are the acts listed below:

- Removal, or rendering inoperative, of any exhaust components, including mufflers, heavy or double-wall exhaust tubing, flexible tubing or exhaust pipe clamping.
- Removal, or rendering inoperative, of the temperature-modulated cooling fan system.
- Removal of the cooling fan shroud.
- Removal, or rendering inoperative, of the air cleaner or air intake in-line silencer.
- Removal or rendering inoperative any vehicle body mounted sound insulation components.
- Removal, or rendering inoperative, of the engine speed governor so as to allow engine speed to exceed the manufacturers specifications.
- Removal of splash shields located inside the wheel housings.
- Removal of engine block shields.
- Removal of engine crankcase shields or insulation.
- Removal of insulated rocker arm covers.
- Removal of transmission noise shields.

## *Noise Shielding and Insulation Devices*

### **Maintenance**

Ensure sound shielding and insulating devices are intact. Inspect components for damage. Primary system components requiring noise related inspection include the engine compartment insulating materials (including engine covers, hatches insulation) wheel housings, fenders, and body panels. Inspect all related fasteners, brackets, and clamps for damage and tightness.

## 8 VOLVO Engines

---

### Regulatory Compliance

Acts that constitute tampering with the Noise Shielding and Insulation Devices:

Removing or rendering inoperative the engine and/or transmission noise deadening panels, shields or insulating materials.

Removing or rendering inoperative any vehicle body mounted sound insulation components and/or shields (fender shields, skirts, wheel housing splash shields, etc.).

### Cooling System



#### WARNING

DO NOT work near the fan with the engine running or the ignition in the ON position. The engine fan can engage at any time without warning. Anyone near the fan when it turns on could be seriously injured.

### Maintenance

Visually inspect cooling system components for damage, and/or misalignment.

Primary system components requiring noise related inspection include fan blades, fan clutch, fan shroud, fan ring, and recirculation shields. Check fan blades, fan ring, fan shroud, belt tensioner and recirculation shields for any damage. Verify that fan blades clear the fan ring. Inspect all related fasteners, brackets, and clamps for damage and tightness. Confirm operation of temperature modulated fan clutch.

### Regulatory Compliance

Acts that constitute tampering with the Cooling System:

Removing or rendering inoperative cooling system components (such as the temperature modulated fan clutch, fan shroud, fan ring, recirculation shields, etc.).



---

## *Exhaust System*

**WARNING**

Hot engine! Avoid all movable parts or hot engine parts, exhaust gases, and/or fluids. A hot engine, exhaust, and/or fluids can cause burns.

### **Maintenance**

Make sure the exhaust system is intact. Inspect for damage, misalignment and/or leakage. Primary system components requiring noise related inspection include exhaust manifold, turbocharger, and all exhaust system (rigid and flexible) piping. Closely check the system for exhaust leaks. Special attention should be given to all welds, seams, gaskets, support points, clamps, couplings and connections.

Inspect all exhaust system fasteners, brackets, and clamps for damage and tightness.

### **Regulatory Compliance**

Acts that constitute tampering with the Exhaust System:

Removing or rendering inoperative exhaust system components (such as the pipes, clamps, etc.).

## *Air Intake/Air Induction System*

### **Maintenance**

Make sure the air intake system is intact. Inspect components for damage, misalignment and/or leakage. Primary system components requiring noise related inspection include the air cleaner housing, air cleaner element, turbocharger, charge air cooler and intake manifold.

Also inspect all ducts, pipes, hoses, tubing and elbows used to interconnect the system. Special attention should be given to all welds, seams, gaskets, support points, clamps, couplings and connections.

Inspect all intake system fasteners, brackets, and clamps for damage and tightness.

# 10 VOLVO Engines

---

## **Regulatory Compliance**

Acts that constitute tampering with the Air Intake/Air Induction System:

Removing or rendering inoperative air intake/induction system components (filter, filter housings, ducts, etc.).

## *Engine Control, EGR and Fuel Systems*

Acts that constitute tampering with Engine Control, EGR and Fuel Systems:

Removing rendering inoperative, or modifying the engine control system such as the ECU, EGR system components, or fuel system components, in order to allow the engine to operate outside of the manufacturers specifications is not allowed and violates both warranty and legislation.

---

## Safety Information

### Proper Maintenance Procedure

**DANGER**

Before working on a vehicle, set the parking brakes, place the transmission in neutral, and chock the wheels. Failure to do so can result in unexpected vehicle movement and can cause serious personal injury or death.

**DANGER**

Exhaust gases contain carbon monoxide. Always run the engine outdoors or use a properly vented exhaust hose. Prolonged or excessive exposure may cause serious illness or death.

**DANGER**

Never operate the engine in an area where hydrocarbon vapors (gasoline, for example) are present or are suspected to be present. Hydrocarbon vapors can enter the air intake and over speed the engine, causing severe engine damage and/or an explosion and fire. Serious personal injury or death could occur.

**DANGER**

Never try to operate or work on this vehicle while under the influence of alcohol. Your reflexes can be affected by even a small amount of alcohol. Drinking and operating this vehicle can lead to an accident, causing serious personal injury or death.

## 12 VOLVO Engines

---



### **WARNING**

DO NOT attempt to repair or service this vehicle without having sufficient training, correct service literature and the proper tools. Failure to follow this could lead to personal injury or making your vehicle unsafe.



### **WARNING**

Diesel engine exhaust and some of its constituents are known to the state of California to cause cancer, birth defects and other reproductive harm.

---

## **During Maintenance**

Remove key from ignition while working on vehicle or engine.

**DO NOT allow unauthorized personnel on, around or in the vehicle when maintenance or repair is being performed.**

- When operating the engine in an enclosed area, vent the exhaust to the outside.
- Before servicing your vehicle, apply the parking brakes and adequately chock the wheels in order to prevent unintended vehicle movement. If the service procedure requires the parking brakes to be released recheck to ensure that the wheels are adequately chocked to prevent any forward and/or rearward movement.
- DO NOT use combustibile substances in or around the engine either during repair or maintenance or when running the engine.
- DO NOT wear loose clothing or jewelry that can catch or get snagged by parts or moving components on the engine. Also wear all protective equipment required by the job conditions, such as protective glasses, hearing protection, etc.
- Make certain that all protective covers and guards are in place and properly secured.
- Never put maintenance fluids into glass containers since glass containers can break.
- Report all problems in a timely manner before they threaten the safety of operating the vehicle.
- DO NOT work on the engine while it is running.
- Make sure protective locks and covers are in their proper place.
- DO NOT use high amperage electronic starting devices for jump-starting the engine. Rely on conventional battery charging for charging the batteries or jump-start with the help of a start battery.
- DO NOT attempt repairs you do not understand. If you do not have the proper tools/knowledge to perform the repairs correctly, Prevost recommends contacting your nearest Prevost Service Center for all necessary repairs.
- When starting an engine after repairs have been made to the fuel or injection system, prepare equipment for shutting off the engine intake air and/or fuel supply (to stop the engine), in case there is an over speed on start-up.
- Start the engine only from the driver seat. Never operate the starter motor across the starter terminals or the batteries as this could bypass the engine neutral-start system as well as causing damage to the electrical or electronic systems.

### Compressed Air and Water



#### **DANGER**

Compressed air can cause serious personal injury. When using compressed air for cleaning, wear a protective face shield, protective clothing and protective shoes. Pressurized water could cause particles and/or hot water to be sprayed in your direction and cause personal injury. The maximum air pressure must be below 30 psi (200 kPa) for cleaning purposes.

### Asbestos Information

**Note:** The VOLVO engine and replacement parts for it shipped from the factory are asbestos free. VOLVO recommends the use of only genuine VOLVO spare parts.

Never use any parts that contain or are thought to contain asbestos. Exposure to asbestos fibers can create serious health risks, including death.

### Fluid Penetration



#### **DANGER**

Always use a piece of paper or cardboard when checking for a leak. Escaping fluid under high pressure, even a pin-hole sized leak, can penetrate body tissue, causing serious injury or death. If fluid is injected into your skin, immediate treatment must be administered by a doctor familiar with this type of injury.

## Injury Prevention

### Burn Prevention

#### *Engine Parts*



#### **WARNING**

Hot engine. Keep yourself clear of all hot engine parts and/or fluids. A hot engine and/or fluid can cause serious burns.



#### **WARNING**

DO NOT raise the engine hood if you see or hear steam or coolant escaping from the engine compartment. Wait until steam or coolant cannot be seen or heard any longer before raising the hood.

DO NOT remove the coolant fill cap if the coolant in the surge tank is boiling. Also, do not remove the cap while the engine and radiator are still hot. Scalding fluid and steam may be blown out under pressure if the cap is taken off too soon, which can cause personal injury and damage to engine components.



W0001525

DO NOT touch any part of the engine while it is hot. Allow the engine to cool before any repair or maintenance is performed on the engine.

Relieve all pressure in air, oil, fuel or cooling systems before any lines, fittings or related items are disconnected or removed.

# 16 VOLVO Engines

---

## Coolant



### WARNING

Coolant may be combustible. Coolant leaked or spilled onto hot surfaces or electrical components can cause a fire. Clean up coolant spills immediately.



W0001527

To prevent personal injury, use suitable, properly positioned ladder to reach and remove the filler cap. At normal operating temperature, the engine coolant is very hot and under pressure. If pressure is relieved rapidly in a hot cooling system, the hot coolant can turn into steam. Any contact with hot coolant or steam can cause severe burns. The radiator and all heating system and radiator lines and hoses contain hot coolant.

Verify coolant level only by the markings on the expansion tank. Open the filler cap only after the engine is stopped and cooled down. Remove the filler cap slowly to relieve pressure.

## Oils



### WARNING

Hot engine. Keep yourself clear of all hot engine parts and/or fluids. A hot engine and/or fluid can cause serious burns.

Hot oil can cause severe burns. DO NOT allow hot oil to contact the skin. When changing oil, wear protective gloves.



## Batteries



### WARNING

Always wear eye protection when working around batteries to prevent the risk of injury due to contact with sulfuric acid or an explosion.



### WARNING

Battery posts, terminals and related accessories contain lead and lead compounds, chemicals known to the State of California to cause cancer and reproductive harm. Wash hands after handling.

Battery electrolyte contains acid and can cause injury. Avoid contact with the skin and eyes. Wash hands after touching batteries and connectors. Use of gloves is recommended. Always wear protective glasses when working with batteries.

## Fire or Explosion Prevention



### DANGER

The diesel engine will operate on any fuel which enters the cylinder, whether it is from the injectors or from the air intake system. Therefore, if any solvent is used to flush out the air cleaner element, the engine may over speed during start-up. Engine damage and severe injury and/or death from burns or explosion can occur.



### DANGER

Excessive heat may cause the pressurized components of the air conditioned system to explode. Some mixtures of R134a refrigerant can become combustible at elevated pressures. Never weld, solder, steam clean or use a gas torch near any part of the air conditioning system. Severe injury or death may occur from an explosion.



W0001526



## **DANGER**

DO NOT service any part of the fuel system while smoking or in the presence of flames, sparks or hot surfaces. Failure to follow these precautions can result in fire, which can cause serious injury or death.



## **WARNING**

DO NOT store fuel containers in the vehicle. They may leak, explode and cause or feed a fire. Empty or full, they present a hazard that may lead to burns in the event of a fire.



W0001527

The engine should not be operated in an area where combustible gases are suspected to be in the air. These could be drawn into the engine through the engine air intake system and could cause the engine to over speed with possible serious damage to the engine and bodily injury or property damage.

Make provisions for shutting off the engine intake air or fuel supply to stop the engine if there is an over speed on start-up after performing repair or maintenance on it.

Contact your nearest authorized Prevost Service Center for any necessary air conditioning testing or repairs.

All fuels, most lubricants and some coolant mixtures are flammable. Diesel fuel is flammable. Gasoline is flammable. The mixture of diesel and gasoline fumes is extremely explosive. DO NOT smoke while refueling or when in a refueling area.

Keep all fuels and lubricants stored in properly marked containers and away from all unauthorized personnel. Store oily rags or other flammable material in a protective container, in a safe place.

Remove all flammable material such as fuel, oil and other substances before they accumulate on the engine.

DO NOT expose the engine to flames, driving over burning ground.

DO NOT weld or flame cut on or around pipes or tubes that contain flammable fluids.

Exhaust heat shields may be installed to protect oil or fuel carrying lines and pipes from hot exhaust parts. To protect from pipe or seal failure, install heat shields correctly.

Provide adequate and proper waste oil disposal. Always dispose of waste liquids according to Federal and local regulations. Oil and fuel filters should be properly installed and housing covers tightened to the proper torque when being changed.

## *Fire Extinguisher*

Anytime work is being done to the fuel system or any other area where flammable substances are being used, have a fire extinguisher available and know how to use it. Inspect and have it serviced as recommended on its instruction label.

## 20 VOLVO Engines

---

### *Respiratory Hazard Prevention*



#### **DANGER**

Exhaust gases contain carbon monoxide. Always run the engine outdoors or use a properly vented exhaust hose. Prolonged or excessive exposure may cause serious illness or death.



#### **WARNING**

Diesel engine exhaust and some of its constituents are known to the state of California to cause cancer, birth defects and other reproductive harm.



W0001523

Always work in a well ventilated space if the engine needs to be running and use a hose to route the exhaust to the outside.

### *Poisonous Substances*



#### **DANGER**

Coolant is toxic; risk of poisoning.  
DO NOT drink coolant. Use proper hand protection when handling. Keep coolant out of reach of children and animals. Failure to follow these precautions can cause serious illness or death.

Cooling system supplemental additive contains alkali. To prevent personal injury, avoid contact with the skin and eyes.

DO NOT drink coolant of any concentration.

## Crushing or Cutting Prevention



### DANGER

Before working on a vehicle, set the parking brakes, place the transmission in neutral and chock the wheels. Failure to do so can result in unexpected vehicle movement and can cause serious personal injury or death.



### WARNING

DO NOT work near the fan with the engine running or the ignition in the ON position. The engine fan can engage at any time without warning. Anyone near the fan when it turns on could be seriously injured.



W0001524

Never attempt adjustments or repairs while the engine is running, see your authorized Prevost Service Center.

Inspect the fan blade assembly before service for cracks or loose mounting before starting the engine. *Never* stand alongside a rotating fan assembly, particularly at high fan speeds.

Wear protective glasses when striking objects to avoid injury to your eyes. Chips or other debris can fly off objects that are struck. Make sure no one can be injured by flying debris before striking any object.

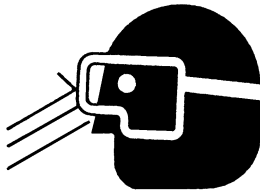

W0001528

### *Climbing Up and Down*



#### **DANGER**

Always use a three-point stance (one foot and two hands or two feet and one hand) whenever climbing up or down. Failure to follow this warning can result in serious personal injury or death.

DO NOT climb up on or jump off from the engine or stand on components that cannot support your weight. Use an adequate ladder or scaffolding, suitably situated.

Clean steps, handholds and areas of the vehicle on which you will be working or are around. Refer to the Operators Manual for proper entry and exit procedures.

---

# Engine Damage Prevention

## Before Starting the Engine



### DANGER

Before working on a vehicle, set the parking brakes, place the transmission in neutral and chock the wheels. Failure to do so can result in unexpected vehicle movement and can cause serious personal injury or death.

Inspect engine for potential hazards. Make sure all protective guards and covers are properly installed if an engine needs to be started to make adjustments or checks. To help prevent an accident by moving parts, work carefully around them.

DO NOT disable or bypass automatic alarm/shutoff circuits. They are provided to prevent personal injury and engine damage.

Only properly trained and authorized Prevost Service Technicians may attempt repairs on this vehicle.

## Engine Starting

DO NOT start the engine or move any of the controls or disengage the parking brake if the warning tag DO NOT OPERATE is attached to the ignition key or located on the dash. Check with the person who attached the tag before starting.

Make sure no one is working on or close to the engine or components driven by the engine before starting it. Always make an inspection of the engine before and after starting.

Diesel engine exhaust contains products of combustion which may be harmful to your health. Always start and operate the engine in a well-ventilated area, and if in an enclosed area, vent the exhaust to the outside.

Start the engine only from the driver seat in the cab. Never start the engine by shorting across the starter motor terminals or batteries to start the engine as this could bypass the engine neutral-start system as well as damage the electrical and electronic system. Always start the engine according to the required engine starting procedure described in this operators manual to prevent major engine component damage and personal injury.

## 24 VOLVO Engines

---

### Starting Aids



#### **DANGER**

DO NOT use ether or other combustibile starting aids on any engine equipped with a preheater. If the engine is equipped with a preheater, introduction of ether or similar starting aids could cause a fire or explosion resulting in severe property damage, serious personal injury or death.

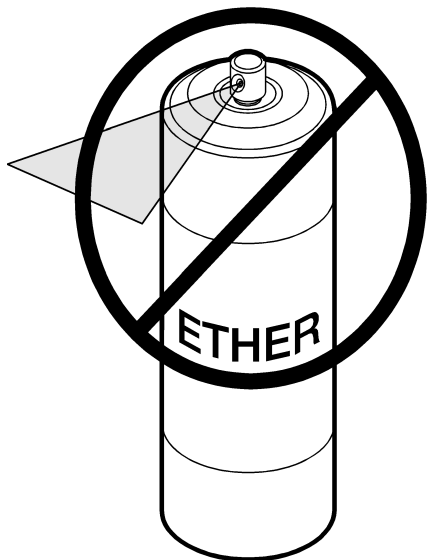

W0001484



## Electric and Electronic Systems



### WARNING

Always wear eye protection when working around batteries to prevent the risk of injury due to contact with sulfuric acid or an explosion.



W0001526

Never disconnect any charging unit circuit or battery circuit cable from the battery when the charging unit is operating. A spark can cause the flammable vapor mixture of hydrogen and oxygen to explode.

To prevent potential sparks from igniting combustible gases produced by some batteries, attach the negative (-) terminal last when hooking up and remove the negative terminal first after the engine has started. Check regularly around the engine and engine compartment for loose or frayed wires. Have all loose or frayed electrical wires tightened, repaired or replaced before operating the vehicle.

### *Grounding Practices*

Proper grounding for vehicle and engine electrical and electronic systems is necessary for proper vehicle and engine performance and reliability. Improper grounding will result in uncontrolled and unreliable electrical paths.

Uncontrolled engine electrical circuit paths can result in damage to main bearings, crankshaft journals surfaces and aluminum components. Uncontrolled electrical circuit paths can also cause electrical noise which may degrade vehicle and radio performance.

Operating engines without the engine-to-frame ground strap installed can cause damage to the engine. To prevent electrical discharge damage, check to make sure the engines electrical system has an engine-to-frame ground strap. All ground connections should be tight and free of corrosion.

### *Electronic Engine Control System*



#### **DANGER**

The engine uses high voltage to the electronic unit injectors. **DO NOT** come in contact with the unit injector terminals while the engine is running. An electric shock can cause an involuntary muscle spasm and cause loss of balance and falls leading to severe personal injury or death.



W0001522

Tampering with the electronic system installation can be dangerous and could result in personal injury or death and/or engine damage. It is very important to take the proper precautions with the electrical and electronic system when charging the batteries, jump-starting or performing electric welding on the vehicle. See the vehicle operator's manual for correct procedures.

This engine is equipped with monitoring features that may cause reduced power or shutdown under certain conditions. The power output, monitoring and idling features can only be programmed and/or changed with electronic service tools and passwords.

Certain features, such as low oil pressure, high coolant temperature or low coolant level could cause the engine power and/or vehicle speed to be limited and the engine may also shut down. The shutdown will take approximately 30 seconds from the time the warning feature is activated. See the vehicle operator's manual for more information.

## Reporting Safety Defects

### **USA**

The National Highway Traffic Safety Administration (NHTSA) and Prevest should be informed immediately if you believe that the vehicle has a defect that could cause a vehicle accident, injury or death.

Contact NHTSA by calling the Auto Safety Hotline at 1 (888) 327-4236, by writing to NHTSA, U.S. Department of Transportation, Washington, DC 20590, by TTY at 1 (800) 424-9153, or visit their website at <http://www.safercar.gov>.

## Canada

Refer customer complaints to Prevost — Customer Service.

850 Chemin Olivier

St-Nicolas, Qc

G7A 2N1 Canada

Fax: 418-831-9301

Canadian customers who wish to report a safety-related defect to Transport Canada, Defect Investigations and Recalls, may telephone the toll free hotline 1 (800) 333-0510 (within Canada only) or call 1 (613) 993-9851 (from Ottawa region or outside Canada). Contact Transport Canada by mail at: Transport Canada, ASFAD, Place de Ville Tower C, 330 Sparks Street, Ottawa ON K1A 0N5.

For additional road safety information, please visit the Road Safety website at: <http://www.tc.gc.ca/roadsafety/menu.htm>

## On-Call Assistance

Prevost Action Service, provides on-call assistance. For help contact Prevost Action Service directly: 24 hours a day at 1 800 463 7738.

## Introduction

The US2010 VOLVO D13J engines meet the very stringent new emissions standards which apply to all heavy-duty diesel engines built after January 1, 2010 for on-highway coaches. The new standards for US 2010 requires 83% reduction in nitrogen oxides (NOx). This represents a total reduction of 99% of all emissions from original levels.

Key Features of the VOLVO engines:

- Improved Fuel Economy
- Extended Oil Drain Intervals
- Improved Cooling Capacity
- Low Maintenance Catalyzed Aftertreatment Diesel Particulate Filter (DPF)
- Enhanced Engine Brake Performance
- Selective Catalytic Reduction (SCR)

### Fuel



#### CAUTION

Diesel engines for US 2010 vehicles are designed to operate only with ultra low sulfur diesel (ULSD) fuel. Use of fuel other than ULSD will reduce the efficiency and durability of the engine, permanently damage the advanced emission control systems, reduce fuel economy and possibly prevent the engine from running at all. Manufacturer's warranties are likely to be rendered void by usage of improper or incorrect fuel, and usage of fuels other than ULSD fuel in diesel-powered vehicles is illegal and punishable with civil penalties. Use of fuel additives to compensate for the lower sulfur content is NOT recommended by Volvo.

Fuel sold for use in diesel-powered engines for US 2010 vehicles may only contain a maximum sulfur content of 0.0015% by weight. This was done to reduce particle emissions in the exhaust.

**Ultra Low Sulfur  
Diesel Fuel Only**

20836671

W2059486

Diesel Fuel Only Decal

---

## Engine Oil

EO-O Premium Plus (or VDS-4) diesel engine oil is mandatory for use in all US 2010 emission compliant VOLVO engines. Chassis equipped with a US 2010 emission compliant engine, which can be identified by the presence of an Aftertreatment Selective Catalytic Reduction (SCR) system, also require the use of ultra low sulfur diesel (ULSD) fuel. EO-O Premium Plus oils exceed the new API service category CJ-4.

### Engine Operation

#### **DANGER**

Do not use ether or other combustible starting aids in any VOLVO engine. Introduction of ether or similar starting aids could cause a fire or explosion resulting in severe property damage, serious personal injury or death.

#### **CAUTION**

DO NOT crank the engine for more than 30 seconds at a time; wait two minutes after each try to allow the starter to cool. Failure to follow these instructions could cause starter damage.

**Note:** Some starters are equipped with starter protection. If the engine is running, the starter temperature is too high or the transmission is not in neutral, starter engagement is inhibited.

Allow the engine to slow down and idle for 3 to 5 minutes before shutting it off. This allows the turbo to slow down and the cooling system to dissipate the engine heat. Switch the engine off by turning the ignition key to the OFF position.

#### **CAUTION**

Shutting off an engine immediately after high speed or full load operation can damage the turbo and cause heat stress in the engine. Always let the engine idle for 3 to 5 minutes before shutting it off.

## Engine Shutdown System

### Stopping the Engine

Allow the engine to slow down and idle for 3 to 5 minutes before shutting it off. This allows the turbo to slow down and the cooling system to dissipate the engine heat. Switch the engine off by turning the ignition key to the B, or OFF, position.



### CAUTION

Shutting off an engine immediately after high speed or full load operation can damage the turbo and cause heat stress in the engine. Always let the engine idle for 3 to 5 minutes before shutting it off.



### DANGER

Failure to take the necessary precautions when the CHECK or STOP tell-tales are on, can ultimately result in automatic engine shut-down and the loss of power steering. Vehicle crash can occur.

### Engine Shut-Down System



W3005170



W3005171

## 32 VOLVO Engines

---

The engine shut-down system will automatically derate or stop the engine when one or more of the systems listed below reaches a critical stage:

- High Coolant Temperature
- Low Oil Pressure
- Low Coolant Level
- High Crankcase Pressure
- High Diesel Particulate Filter Soot Level
- Low DEF Fluid Level

When the shut-down is activated, the tell-tales come on and the buzzer is also activated. From that time it will take 30 seconds before the engine shuts down. In this time period, find a safe place to pull off of the road.

After the engine has been shut down by the system, the override will allow a restart of the engine for 30 seconds. This is so the vehicle may be pulled off the road, if necessary. The alarm will remain activated until repairs have been made to correct the problem.

The operator should not continually override the system as this can cause serious damage to the vehicle's engine.



## Engine Overview, D13J Left Side View

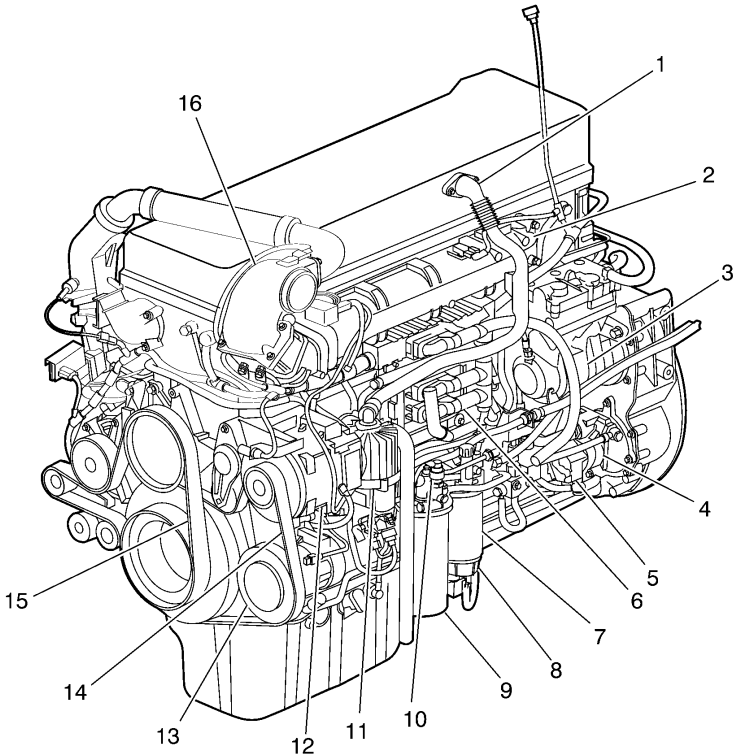

W2006034

### D13J Engine

**Note:** Illustration is used for reference only and may differ slightly from the actual vehicle.

1. Breather Tube	9. Fuel Filter
2. Intake Manifold	10. Hand-Priming Pump
3. Air Compressor	11. Crankcase Ventilator
4. Power Steering Pump	12. Alternator
5. Fuel Pump	13. AC Compressor
6. Engine Control Module (ECM)	14. Alternator/AC Compressor Belt
7. Fuel Filter	15. Fan/Coolant Pump Belt
8. Fuel/Water Separator	16. EGR Mixing Chamber

## 34 VOLVO Engines

### Engine Overview, D13J Right Side View

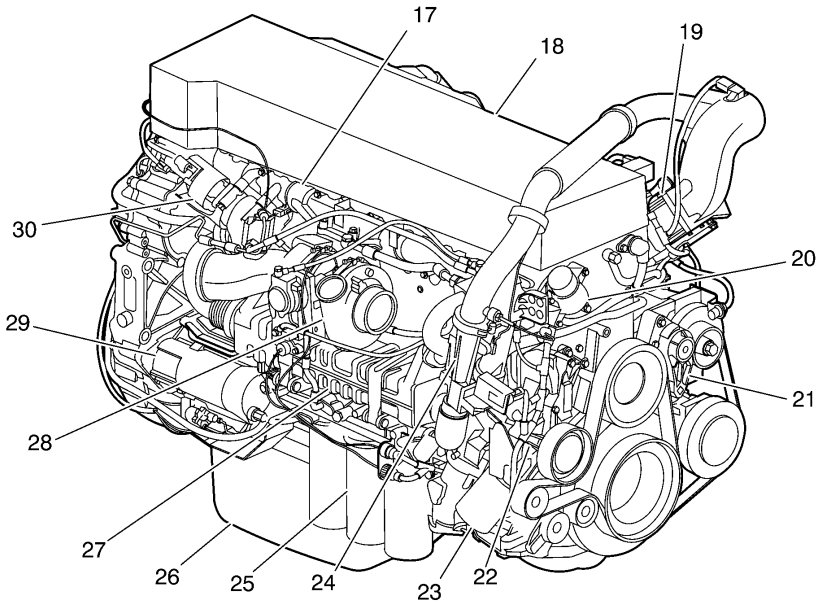

W2006035

#### D13J Engine

**Note:** Illustration is used for reference only and may differ slightly from the actual vehicle.

17. Exhaust Manifold	24. Venturi Pipe
18. Valve Cover	25. Oil Filters
19. Intake Air Heater (IAH) optional	26. Oil Pan
20. Thermostat	27. EGR Cooler
21. Belt Tensioner	28. Turbocharger
22. Coolant Pump	29. Starter Motor
23. Coolant Filter	30. EGR Valve

---

## **Exhaust Emissions and Aftertreatment Diesel Particulate Filters (DPFs)**

### *General*

#### **USA**

Emissions Control Compliance: The Federal Clean Air Act, Section 203 (a) (3), states the following concerning the removal of air pollution control devices or modification of a certified engine to a non-certified configuration:

“The following acts and the causing thereof are prohibited:

(3) For any person to remove or render inoperative any device or element of design installed on or in a motor vehicle or motor vehicle engine in compliance with regulations under this part prior to its sale and delivery to the ultimate purchaser, or for any manufacturer or dealer knowingly to remove or render inoperative any such design after sale and delivery to the ultimate purchaser.”

Specifically, please note that no person may make such changes prior to the sale and delivery of the vehicle to the ultimate purchaser, and, in addition, no manufacturer or dealer may make take such action after sale and delivery of the vehicle to the ultimate purchaser. The law provides a penalty of up to \$10,000 for each violation.

Modifications, such as reprogramming of the fuel system so the engine will exceed the certified horsepower or torque, or removing the mufflers are examples of illegal changes.

Changes should not be made to a certified engine that would result in an engine that does not match the configuration of an engine model that is currently certified to meet Federal Standards.

#### **Mexico**

The same conditions that apply in the USA apply to Mexico. Refer to the Mexican Federal Law for Emission Control which adheres to EPA regulations. No changes should be made that render any or all of the emissions control devices inoperative.

If the owner/operator wishes to make changes to the emission control devices, check with the state authority before changes are made.

#### **Canada**

The same conditions that apply in the USA apply to Canada, with one exception. After the vehicle is sold to a retail customer, that is, the end user, the jurisdiction controlling the emission control devices becomes the province in which the vehicle is licensed. No changes should be made that render any or all of the devices inoperative.

Should the owner/operator wish to make any changes to the emission control devices, check with the provincial authority before making any such changes.

### *Exhaust Emissions and Aftertreatment DPF with Vertical SCR Catalyst*

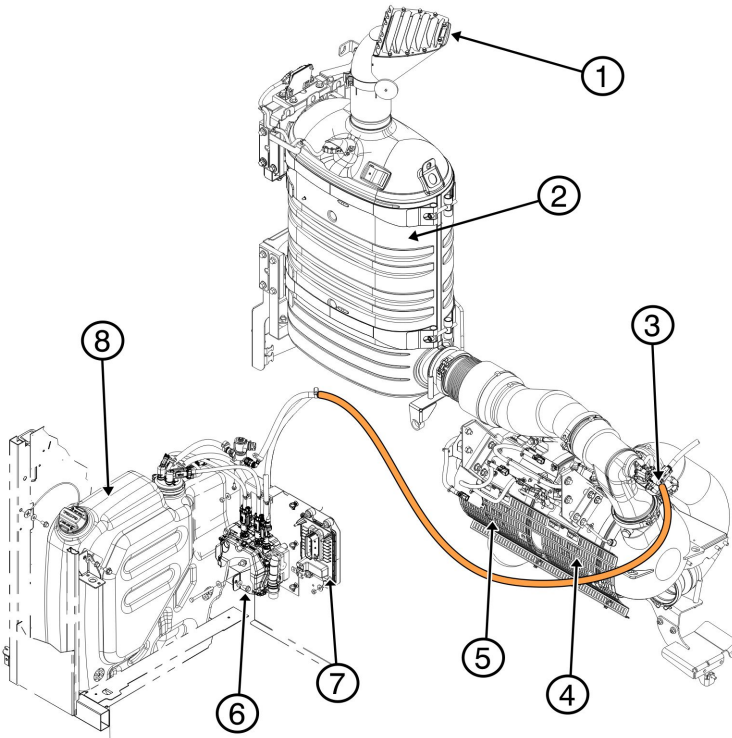

W2081002

1. Diffuser AssemblyAftertreatment
2. Catalytic Converter
3. DEF Injection Nozzle
4. Diesel Particulate Filter (DPF)
5. Diesel Oxidation Catalyst (DOC)
6. DEF Pump
7. Aftertreatment Control Module
8. Aftertreatment DEF Tank

## Exhaust Aftertreatment System



### DANGER

The DPF/SCR shield should not be removed while the vehicle is in use. Also, only remove the shield, once the vehicle is out of use and the SCR/DPF is sufficiently cooled. Failure to follow these instructions can result in fire, which can cause component damage, personal injury or death.



### CAUTION

The Diesel Particulate Filters (DPF), Selective Catalytic Reduction unit (SCR) and their components, **can not** be moved or altered from the OEM installation in any fashion. Any alterations may cause component damage and is prohibited by the law.

These components are part of the overall vehicle emissions control system. In normal operation, these components can experience surface temperatures as high as 350° C (662° F). It is important to verify the temperature at which the material or substance in, or associated with, the body can ignite. If it is possible for the material or substance to fall or leak from the body, take steps to prevent them from contacting or collecting on the DPF or SCR. Failure to do so may result in fire.

It is important to note that additional shielding may, depending upon conditions and the material or substance, trap flammable substances between the additional shield and the DPF/SCR. If this condition can develop, advise the user of the vehicle to periodically check to ensure there are no trapped substances.

**Note: The DPF/SCR and associated components are part of a U.S. EPA and California Air Resources Board (CARB) certified engine emissions system. These components must not be moved, altered or modified in any way. Tampering with these systems render the emissions warranty void and may result in possible tampering charges by the EPA or CARB.**

New stringent standards for exhaust emission control begin with the US 2010 engine model year. The Diesel Particulate Filter (DPF) system has been developed to act in combination with ultra low sulphur diesel (ULSD) fuel to reduce particulate emissions to meet the requirement. The Exhaust After-Treatment System (EATS) includes all the engine and exhaust emissions control components that are required to meet the stringent US 2010 standard.

Particulate matter consists of soot and ash in the exhaust that engines with an EGR system alone, are not equipped to handle. The particulate matter is considered a contaminant that contains undesirable elements. The DPF system reduces the unwanted elements to a more acceptable level defined in the regulations. There are multiple methods of reducing these emissions. VOLVO has selected to use a Diesel Oxidation Catalyst (DOC) with a catalyzed diesel particulate filter. The other uses a diesel particulate filter of a different kind without a DOC and in its place uses a combustion chamber to heat the exhaust mixture thus causing active regeneration.

The particulate matter removed from the exhaust collects on the filter surfaces. To avoid eventual blockage, which would increase exhaust back pressure and affect power and fuel economy, the filter must be cleaned. The DPF is cleaned automatically. The soot breaks down to safer substances before being released to the atmosphere. Some of the ash remains, but takes a long time to reach the point where ash clogs the filter.

Cleaning a filter so it can continue to function is called “regeneration.” Depending on vehicle usage, the engine utilizes a passive or parked regeneration system. Either system uses high heat to break down the chemical properties.

In “passive regeneration,” the exhaust produces enough heat continuously to convert the soot, with approximately 260 °C (500 °F) being required. The process is slow and continues indefinitely. Passive regeneration is possible only in vehicle applications where the temperature is likely to remain at or above the required temperature level, making active regeneration unnecessary.

Parked regeneration is initiated manually by the driver when alerted by the dash. The vehicle must be stationary to begin the regeneration, and remain stationary to complete. The Aftertreatment DPF Regeneration system is self-monitoring. Under certain duty cycles driver action is needed to perform a parked regeneration. When driver action is needed to perform a parked regeneration the Aftertreatment DPF Regeneration Needed icon on the instrument cluster flashes and the message “Parked REGEN Needed” is displayed. Initiate a parked Aftertreatment DPF regeneration at the next stop.



### **WARNING**

Prior to ever working on the exhaust, allow time for the entire exhaust system to cool. Failure to do so may result in personal injury. Severe burns can occur.

## DPF Systems

The VOLVO systems chemically alters soot by high heat into a harmless gas which passes out through the stack pipe. At these high temperatures, the process is relatively rapid (10–12 minutes). Eventually, the filter must be removed to permit clearing away of the ash with special equipment.

The DPF-muffler has an integrated heat insulation that covers most areas of the muffler. The DPF mufflers are un-insulated at the V-clamp body connections, inlet and outlet pipes. The following surface temperatures have been measured with the muffler freely positioned in a room temperature environment with no forced cooling or wind (only self convection).

**Note:** These are **not** maximum temperatures! The surface temperature in a certain vehicle installations, is dependent on the degree of encapsulation and the airflow around the muffler.

### Compact DPF Temperatures

Position	Thickness of Heat Insulation	at exhaust temperature of 350 °C (662 °F) at the DPF-muffler inlet (no regeneration)	at exhaust temperature 450 °C (842 °F) at the DPF-muffler inlet (no regeneration)
Inlet section — top	10 mm (0.4 in.)	170 °C (338 °F)	190 °C (374 °F)
Inlet section — side	No insulation	260 °C (550 °F)	320 °C (608 °F)
DOC section	9 mm (0.35 in.)	175 °C (347 °F)	215 °C (419 °F)
DPF section	10.5 mm (0.41 in.)	145 °C (293 °F)	190 °C (374 °F)
Outlet section — side	4.5 mm (0.18 in.)	100 °C (212 °F)	150 °C (302 °F)
Outlet section — bottom	4.5 mm (0.18 in.)	120 °C (248 °F)	170 °C (338 °F)
Clamping area — side	No insulation	230 °C (446 °F)	300 °C (572 °F)

## Selective Catalytic Reduction (SCR)

Selective Catalytic Reduction (SCR) is an emissions-reduction technology with the ability to deliver near-zero emissions of nitrogen oxides (NOx), a smog-causing pollutant and greenhouse gas. SCR's performance has been proved in millions of miles of real-world truck operations in other countries, as well as in long-term field tests in the U.S.

SCR reduces NOx emissions to very low levels, while at the same time delivering excellent fuel economy and reliability. The system doesn't change the design or operation of the basic engine. Rather, SCR is an aftertreatment system which converts NOx in the exhaust stream into harmless gases. Modern diesels already use exhaust aftertreatment systems, called diesel particulate filters, to control emissions of another pollutant, soot (also known as particulate matter or PM).

SCR works by injecting Diesel Exhaust Fluid (DEF) into the exhaust stream, after the DPF. DEF is a safe, simple solution of water and urea. DEF works with the heat of the exhaust and a catalyst to convert NOx into nitrogen and water vapor - two harmless and natural components of the air we breathe. The end result is cleaner air, excellent fuel efficiency and a reliable emissions control system for today's modern diesel engine.

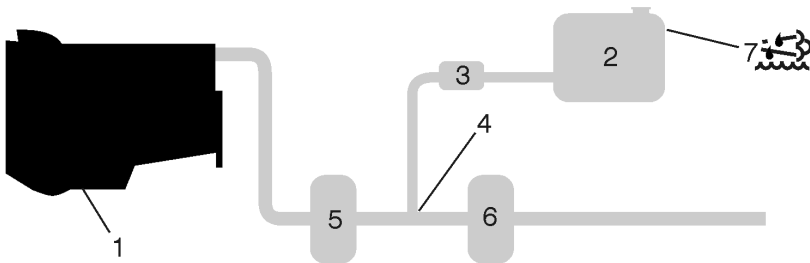

W2031651

1. Diesel Engine
2. Aftertreatment DEF Tank
3. Aftertreatment DEF Pump
4. Aftertreatment DEF Dosing Unit
5. Aftertreatment Diesel Particulate Filter (DPF)
6. Selective Catalytic Reduction (SCR) Catalyst
7. Aftertreatment DEF Tank Sending Unit and DEF Low Level Indicator



**SCR Surface Temperatures**

<b>Position</b>	<b>Thickness of Heat Insulation</b>	<b>at exhaust temperature of 350 °C (662 °F) at the SCR-muffler inlet</b>	<b>at exhaust temperature 450 °C (842 °F) at the SCR-muffler inlet</b>
Casing – all round	Muffler filled with insulation	75 °C (167 °F)	125 °C (257 °F)
End wall – in/outlet side	20 mm (0.78 in.)	100 °C (212 °F)	150 °C (302 °F)
End wall – other side	20 mm (0.78 in.)	125 °C (257 °F)	200 °C (392 °F)
Mounting strap area	No insulation	225 °C (437 °F)	300 °C (572 °F)

## 42 VOLVO Engines

---



### CAUTION

Do not put diesel fuel in the Aftertreatment DEF tank. Diesel fuel, if sprayed into the hot exhaust along with the DEF, could ignite explosively causing a fire resulting in personal injury or damage to the exhaust system.

The VOLVO SCR system is simple and effective, with few components. It consists of a Aftertreatment DEF tank positioned near the standard diesel tank, plus a Aftertreatment DEF pump, Aftertreatment DEF Dosing unit and SCR catalyst. The advantage of using DEF is that it enables the engine to use less EGR -- and higher oxygen levels -- for better combustion, while meeting the EPA near-zero NOx emissions requirement of 0.2 g/hp-hr NOx. By using DEF, we avoid the disadvantages of increasing EGR to massive levels. This results in better fuel economy from your VOLVO engine.



W2055491

Vertical SCR, vertical inlet

## Aftertreatment Hydrocarbon Dosing System

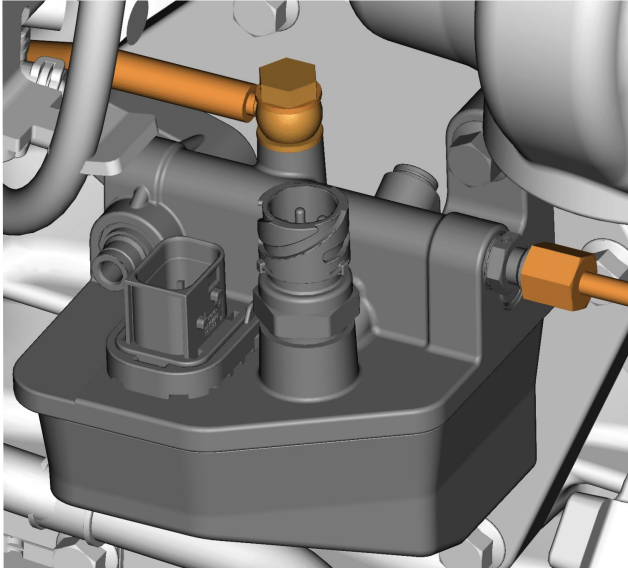

W2064634

The aftertreatment hydrocarbon dosing system is a part of the exhaust aftertreatment system and is used to increase the exhaust gas temperature (EGT) needed for the aftertreatment system.

The dosing system allows diesel fuel to be injected into the exhaust system of the engine to increase the amount of hydrocarbon (HC) released.

The injected fuel will increase the EGT by oxidation of hydrocarbon. An aftertreatment diesel oxidation catalyst (DOC) is mounted upstream of the aftertreatment diesel particulate filter (DPF). This elevated temperature is needed for the aftertreatment selective catalytic reduction (SCR) system and DPF. The HC-system shall be governed by the engine control module (ECM).

The dosing system has interfaces with a most of the vehicle's, major control systems including the fuel system, compressed air system , exhaust system, electrical system, control system and external mechanical interfaces.

### Diesel Exhaust Fluid (DEF)

Diesel Exhaust Fluid (DEF) is a reactant that's key to the SCR process. It's a nontoxic, aqueous solution of 32.5% urea and 67.5% water. Urea is a compound of nitrogen that turns to ammonia when heated. It is used in a variety of industries, perhaps most commonly as a fertilizer in agriculture. The fluid is not flammable, nor is it dangerous when handled normally. However, it is corrosive to metal, particularly copper and aluminium. Read the separate section concerning the handling of DEF solution.

#### *Diesel Exhaust Fluid (DEF) Handling*

When handling DEF solution, it is important that electrical connectors to be connected or well encapsulated. Otherwise there is a risk that the DEF will cause oxidation that cannot be removed. Water or compressed air do not help, since DEF quickly oxidizes metal. If a connector comes into contact with the DEF solution it must be replaced immediately to prevent the DEF solution from creeping further into the copper wiring, which takes place at a speed of about 60 cm (2.4 in) per hour.



#### **CAUTION**

When detaching hoses and components, do not spill DEF on disconnected connectors. If DEF is spilled on a connector, the connector must be replaced immediately



W2059485

## Things to know about spilled Diesel Exhaust Fluid (DEF)

If urea solution comes into contact with the skin, rinse with plenty of water and remove contaminated clothing.
If urea solution comes into contact with the eyes rinse for several minutes and call for medical help if necessary.
If inhaled breathe fresh air and call for medical help if necessary.
Do not allow the DEF solution to come into contact with other chemicals.
The DEF solution is not flammable. If the DEF solution is exposed to high temperatures for long periods of time, it breaks down into ammonia and carbon dioxide.
The DEF solution is corrosive to certain metals, including copper and aluminium. This is similar to the corrosion caused by salt water.
If the DEF solution is spilled onto the vehicle, wipe off the excess and rinse with water. Spilled DEF solution can form concentrated white crystals on the vehicle. Rinse off these crystals with water.

**Note:** Do not flush DEF spills into the normal drain system.

 <b>WARNING</b>
DEF spilt onto hot components will quickly vaporize. Turn your face away!

## *Diesel Exhaust Fluid (DEF) Consumption*

DEF consumption is related to fuel consumption. A bus may travel 225-300 miles (360 — 480 kilometers) or more on one gallon (3.8 liters) of DEF. A gauge much like a fuel gauge will indicate the level of DEF in the tank. A DEF low-level warning activates when DEF is low. If a driver runs out of DEF completely, vehicle power will be reduced to derate mode. When the DEF tank is refilled, the engine will resume normal power.

**Note:** DEF tanks are sized for a two to one fuel to DEF ratio in order to meet US 2010 requirements.

## *Diesel Exhaust Fluid (DEF) Availability*

DEF is available in 2.5 gallon (9.6 liters) containers, 55 gallon (200 liters) drums, 275 gallon (1000 liters) IBC and in bulk storage for fleet locations, truck stops and dealerships. All major truck stops, dealers and distributors carry DEF. For more information on DEF and availability please visit the website [www.volvoscr.com](http://www.volvoscr.com).

### Aftertreatment Control Module (ACM)

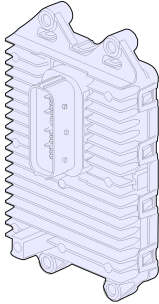

W2038621

The ACM controls the following components in the exhaust aftertreatment system:

- Aftertreatment DEF Dosing Unit
- Aftertreatment DEF Tank Heater Valve
- Aftertreatment DEF Line Heaters
- Aftertreatment DEF Pump
- Aftertreatment DEF Return Valve
- Aftertreatment DEF Tank Level Sensor

The ACM also monitors the following values in the exhaust aftertreatment system:

- Aftertreatment DEF Dosing Absolute Pressure
- Aftertreatment DEF Tank Temperature
- Aftertreatment DEF Tank Level
- Aftertreatment DPF Inlet/Outlet Temperature
- Aftertreatment DPF Differential Pressure
- NOx Sensors

The ACM is a stand alone module. Depending on your configuration it may be mounted as part of the DEF tank (as shown above) or on a bracket near the DEF tank.

## Smart NOx Sensor

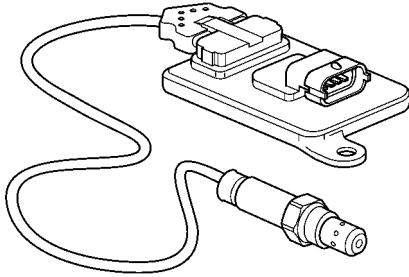

W9000948

The Smart NOx- sensor is used to monitor the emission reduction system. Two NOx sensors are needed for US 2010 vehicles. One sensor is positioned on the DPF/muffler outlet, the other on the exhaust pipe after the SCR-muffler on the SCR-muffler outlet (vertical version).

**Note:** The Smart NOx sensors should not be moved or modified in anyway. To do so would inhibit the proper operation of the Aftertreatment system

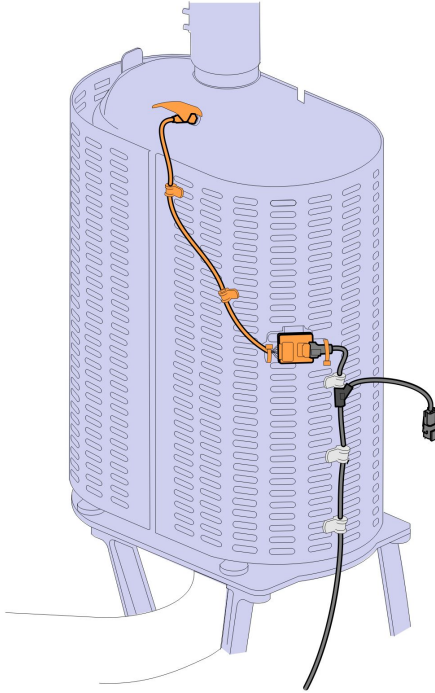

W2081003

NOx Sensor Locations for Vertical SCR





## Aftertreatment Inducement Screens







### Aftertreatment DEF Tank Level - Driver Warning & Inducement

Aftertreatment DEF tanks are sized to have no less than two times the diesel fuel tank mileage.

The vehicle instrument cluster has an aftertreatment DEF tank level gauge.

Triggers	Aftertreatment DEF Tank Low Level Indicator	Driver Information Display Screen
100% to 12% Aftertreatment DEF Tank Level Gauge	None	None
<=12% Aftertreatment DEF Tank Level Gauge	 <p style="text-align: center; font-size: small;">W2029416</p> <p style="text-align: center;">Solid indicator</p>	Low DEF level Refill to avoid Engine derate
0% Aftertreatment DEF Tank Level Gauge (~1% DEF Remaining)	 <p style="text-align: center; font-size: small;">W2029415</p> <p style="text-align: center;">Blinking indicator</p>	DEF Tank Empty Engine in derate Refill to avoid 5 Mph
0% Aftertreatment DEF Tank Level Gauge AND either: <ol style="list-style-type: none"> <li>1 Vehicle stationary for 20 minutes, or</li> <li>2 Diesel fuel Refueling &gt; 15% with parking brake engaged.</li> </ol>	 <p style="text-align: center; font-size: small;">W2029415</p>	DEF tank empty Speed limited to 5 Mph

## Aftertreatment DEF Quality - Driver Warning & Inducement

Triggers	Lamp Status	Driver Information Display Screen
Good DEF Quality	None	None
Poor DEF Quality DTC Initially Detected	 <small>W2029417</small>	SCR performance low Engine derate in < xxx mins
Poor DEF Quality DTC Initially Detected + 1 hour of operation	 <small>W2029417</small>	SCR performance low Engine derate in < xxx mins
Poor DEF Quality DTC Initially Detected +4 hours of operation	 <small>W2029417</small>	SCR performance low Engine in derate 5 Mph in < xxx mins
Poor DEF quality DTC initially detected + 4 hours of operation AND either: <ol style="list-style-type: none"> <li>1 Vehicle stationary for 20 minutes, or</li> <li>2 Diesel Fuel Refueling &gt; 15% with parking brake engaged</li> </ol>	 <small>W2029417</small>	SCR Performance low Engine in derate 5 Mph at next stop
By means of 1 engine start or use of a service tool temporary exit from 8 Km/h (5 Mph) Inducement	 <small>W2029417</small>	SCR performance low Speed limited to 5 Mph
Ignition Key Cycle before DEF Quality Evaluation has been completed	 <small>W2029417</small>	SCR perf. check Engine in derate 5 Mph Limit removed

**Exit conditions for DEF Quality "8 Km/h (5 mph) road speed limit" Inducement:**





**Next 1 Engine Starts:** Return to 25% torque reduction until there is a proper DEF quality evaluation. If poor DEF quality is detected during the next monitoring cycle then 8 Km/h (5 mph) is resumed after the vehicle is stationary for 20 minutes. After one engine start has been exhausted then a Tech Tool is required to exit the 8 Km/h (5 mph) road speed limit.





**With Tech Tool DTC Clearing:** Invoke 25% torque reduction until there is a proper DEF quality evaluation. If poor DEF Quality is detected during the next monitoring cycle then 8 Km/h (5 mph) is resumed after the vehicle is stationary for 20 minutes.

## Aftertreatment Tampering - Driver Warning & Inducement

When the SCR tampering fault is active for one or more hours a new Driver Information Display screen appears. The text changes for the Driver Information Display (DID) screen associated with this fault are listed in the table below.

**Note:** Repeated acts of tampering will result in more severe Inducement.

Triggers	Lamp Status	Driver Information Display Screen
No fault	None	None
<p>Tampering Fault Detect</p> <p><b>Note:</b> For examples of various SCR sensor tampering types refer to the “SCR Tampering ” table below</p>	 <p>W2029417</p>	<p>SCR system fault Engine derate in &lt; xxx mins</p>
<p>Second Drive Cycle with Active DTC.</p>	 <p>W2029417</p>  <p>W3031200</p>	<p>SCR System Fault Engine in derate 5Mph in &lt;xxx mins</p>
<p>Driving with Active Fault for + 1 hour.</p>	 <p>W2029417</p>  <p>W3031200</p>	<p>SCR system fault Engine in derate 5 Mph in &lt; mins</p>

<p>Driving with Active Fault for + 4 hours</p>	 <p>W2029417</p>  <p>W3031200</p>	<p>SCR system fault Engine in derate 5 Mph at next stop</p>
<p>Active tampering DTC initially detected + 4 hours of operation AND either:</p> <ol style="list-style-type: none"> <li>1 Vehicle stationary for 20 minutes, or</li> <li>2 Diesel Fuel Refueling &gt; 15% with parking brake engage</li> </ol>	 <p>W2029417</p>  <p>W3031200</p>	<p>SCR system fault Speed limited to 5 Mph.</p>

<b>SCR Tampering</b>
Aftertreatment Control Module (ACM) Disconnected
Aftertreatment Inlet NOx sensor disconnected
Aftertreatment Oulte NOx sensor disconnected
DEF Pump Disconnected
DEF Dosing Valve Disconnected
DEF Tank Level Sensor Disconnected
DEF Dosing valve or line blocked.
DEF Pump pressure build up failure
DEF Return Line Blocked or Plugged

**Note:** For additional DID information refer to the Driver Information Display Manual.

## Misfilling Diesel or Aftertreatment DEF Tanks

Although diesel fuel and Aftertreatment DEF caps are clearly labeled and filler necks and nozzles are different accidents can happen.

Contamination of fluids by- misfilling of diesel or DEF in the wrong tank may result in vehicle malfunction.

### Results of Misfilling DEF in Diesel Tank

- Engine may run poorly or not at all
- Engine injectors may be damaged
- Exhaust system corrosion may occur between engine turbocharger and Aftertreatment DPF
- On Board Diagnostic (OBD) Diagnostic Trouble Codes (DTC)

- Costly repairs

### Results of Misfilling Diesel in Aftertreatment DEF Tank

- Aftertreatment SCR system may be damaged by diesel
- SCR Catalyst may be damaged by diesel (chemical damage)
- Emissions may be non-compliant
- On Board Diagnostic (OBD) Diagnostic Trouble Codes (DTC)
- Costly repairs

## Warranty and Maintenance

### **Exhaust Aftertreatment System Maintenance**

The vehicle must be taken to an authorized Prevost Service Center to remove the ash from the Aftertreatment Diesel Particulate Filter and clean the Aftertreatment Doser.

### **Emissions Maintenance**

1. If owner's manual recommends Aftertreatment DPF replacement within useful life, the manufacturer must pay for the replacement; however, a random failure within the useful life is covered only per the above warranty provisions.
2. First maintenance interval in life of the engine is allowed at 160 000km (100,000 miles), 3000 hours.

### **Engine Maintenance Intervals**

For specific engine maintenance intervals reference the “Maintenance Manual PREVH, PREVX.”

### Engine Gaseous Emission Control Systems

#### WARRANTY MAINTENANCE

#### GASEOUS EMISSION CONTROL SYSTEMS WARRANTY

Prevost warrants the Emission Control Systems on each new VOLVO diesel engine in a new Prevost coach to comply with all United States Federal and Canadian emissions regulations applicable at the time of manufacture of the engine, and to be free from defects in material and workmanship under normal use and service up to 60 months, or 100,000 miles, whichever occurs first, provided all Prevost, maintenance requirements are followed as described in this manual. All warranty periods are calculated from the date-in-service of the new vehicle. The repair or replacement of defective parts will be made without charge for the cost of parts and, if repairs are made at an authorized Prevost Service Center, there will be no charge for labor. Prevost's obligation under this warranty is limited to the repair or replacement, at Prevost's option, of any part(s) of the Emission Control Systems of such engine and/or vehicle found to be defective upon examination by Prevost and provided that such part(s) were returned to Prevost or its nearest authorized Service Center within a reasonable period of time.

#### *Qualifications and Limitations:*

**Note: Not covered** by the Emissions Control Systems Warranty:

- Malfunctions caused by misuse, improper adjustments, modification, alteration, tampering, disconnection, improper or inadequate maintenance and use of improper diesel fuel or DEF.
- Damage resulting from accident, acts of nature or other events beyond the control of Prevost.
- Inconvenience, loss of use of the vehicle, commercial loss of any kind including, but not limited to, consequential or incidental damages
- Any vehicle in which the odometer has been altered or damaged so that mileage cannot be readily determined.

**THIS WARRANTY IS EXPRESSLY IN LIEU OF ALL OTHER WARRANTIES AND REPRESENTATIONS OR CONDITIONS, STATUTORY OR OTHERWISE, EXPRESSED OR IMPLIED INCLUDING, BUT NOT LIMITED TO, IMPLIED WARRANTY OF MERCHANTABILITY OR FITNESS FOR A PARTICULAR PURPOSE.**



---

## **Emissions Control System Warranty**

The following engine components are covered by the supplemental emissions control system warranty policy as required by the Federal code of emission regulations.

- 1 Engine Turbocharger Assembly
  - Variable Geometry Turbo (VGT) Actuator
- 2 Charge Air Cooler (CAC)
- 3 Engine Control Module (ECM)
- 4 Injectors
- 5 EGR Cooler
- 6 EGR Valve and EGR Valve Control
- 7 EGR Venturi
- 8 Crankcase Breather (Does not include Crankcase Pressure Sensor)
- 9 Crankcase Separator
- 10 Crankcase Tubing and Hoses before Separator
- 11 Aftertreatment Wiring Harness (DPF)
- 12 Aftertreatment Wiring Harness (SCR)
  - Jumper to AHI Pressure Regulator
  - ACM Power Supply
  - Heater NOx Care
  - DEF Tank
- 13 Aftertreatment Control Module (ACM)
- 14 Aftertreatment Diesel Particulate Filter (DPF) with Aftertreatment Diesel Oxidation Catalyst (DOC)
  - Aftertreatment Doser
  - Aftertreatment Fuel Shutoff Valve
  - Aftertreatment Fuel Pressure Sensor
  - Engine Exhaust Gas Temperature (EGT) Sensor
  - Aftertreatment DPF Intake Temperature Sensor
  - Aftertreatment DPF Outlet Temperature Sensor
  - Aftertreatment DPF Differential Pressure Sensor
- 15 Sensors:
  - Crankshaft Position (CKP) Sensor
  - Transmission Speed Sensor
  - Engine Coolant Temperature (ECT) Sensor
  - Intake Manifold Air Temperature/Pressure Sensor
  - Exhaust Gas Recirculation (EGR) Temperature Sensor
  - Aftertreatment Outlet NOx Sensor
  - Aftertreatment Intake NOx Sensor
  - Engine Exhaust Gas Recirculation Differential Pressure Sensor
  - Ambient Air Temperature (AAT) Sensor
- 16 SCR
  - Aftertreatment Selective Catalytic Reduction (SCR) Catalyst
  - Aftertreatment Diesel Exhaust Fluid (DEF) Pump
    - Aftertreatment DEF Dosing Absolute Pressure Sensor
    - Aftertreatment DEF Return Valve
  - Aftertreatment DEF Dosing Valve
  - Aftertreatment DEF Tank
  - Aftertreatment DEF Tank Heater/Sender
  - Aftertreatment DEF Tank Heater
  - Aftertreatment DEF Tank Heater Valve
  - Aftertreatment DEF Tank Temperature Sensor
  - Aftertreatment DEF Level Sensor

- Aftertreatment DEF Heated Lines
  - Aftertreatment DEF Quality Sensor
17. Instrument Cluster (Repair of Microprocessor)
18. Exhaust Gas Piping (from Turbocharger to Aftertreatment System)

### **Engine Gaseous Emissions Control System Warranty**

The emission warranty for the diesel particulate filter and SCR Systems covers defects in workmanship only. Normal maintenance, such as cleaning ash from the filter at regular maintenance intervals and cleaning the Aftertreatment fuel injector on Diesel Oxidation Catalyst (DOC) DPF systems, is not covered by the emission warranty. With the Thermal Regeneration DPF system, cleaning the ignition electrodes and fuel injection nozzle at the regular maintenance intervals is considered normal maintenance and not covered by the emission warranty.

## Federal Emission Requirements

This section covers the requirement of the United States Clean Air Act which states: “The manufacturer shall furnish with each new motor vehicle or motor vehicle engine such written instructions for the maintenance and use of the vehicle or engine by the ultimate purchaser as may be reasonable and necessary to assure the proper functioning of emission control devices and systems.” This section also covers the requirements of the emissions regulations promulgated under the Motor Vehicle Safety Act in Canada.

### TAMPERING WITH GASEOUS EMISSION CONTROL SYSTEMS PROHIBITED

The Federal Clean Air Act prohibits the removal or rendering inoperative of any device or element of design installed on or in a motor vehicle or motor vehicle engine in compliance with Federal Emission Regulations by:

- 1 Any person prior to its sale and delivery to the ultimate purchaser, or
- 2 Any manufacturer or distributor after its sale and delivery to the ultimate purchaser, or
- 3 Any person engaged in the business of repairing, servicing, selling, leasing, or trading motor vehicles or motor vehicle engines following its sale and delivery to the ultimate purchaser, or
- 4 Any person who operates a fleet of motor vehicles following its sale and delivery to the ultimate purchaser.

**Note:** For specifics of the prohibited vehicle/engine modifications refer to the VOLVO Body Builders documentation .

## Emission Control System Warranty — California

The California Air Resources Board and Prevost. are pleased to explain the California emission control system warranty on your new motor vehicle engine. In California, new motor vehicle engines must be designed, built and equipped to meet the State’s stringent anti-smog standards. Prevosti. must warrant the emission control system on your engine for the period of time listed below provided there has been no abuse, neglect, or improper maintenance of your engine. Your emission control system may include parts such as the fuel-injection system, turbocharger assembly, electronic control module and other emission-related assemblies.

Where a warrantable condition exists, Prevost will repair your engine at no cost to you including diagnosis, parts, and labor. **MANUFACTURER’S WARRANTY COVERAGE:** If an emission-related part of your engine is defective, the part will be repaired or replaced by Prevost. This is your emission control system DEFECTS WARRANTY.

### OWNER'S WARRANTY RESPONSIBILITIES:

As the motor vehicle engine owner, you are responsible for the performance of the required maintenance listed in this manual. Prevost recommends that you retain all receipts covering maintenance of your vehicle, but Prevost cannot deny warranty solely for the lack of receipts or for your failure to ensure the performance of all scheduled maintenance listed in other manuals which were supplied with your vehicle. You are responsible for presenting your motor vehicle engine to a Prevost Service Center as soon as a problem exists. The warranty repairs should be completed in a reasonable amount of time, not to exceed 30 days. As the motor vehicle engine owner, you should also be aware that Prevost may deny you warranty coverage if your vehicle or a part has failed due to abuse, neglect, improper maintenance, or unapproved modifications. If you have any questions regarding your warranty rights and responsibilities, you should contact the Prevost Department 850 Chemin Olivier, St-Nicolas, Qc, G7A 2N1, Canada, Fax 418-831-9301, or the California Air Resources Board at 9480 Telstar Avenue, El Monte, California 91731. **(Applicable only to vehicles and/or engines certified for sale and registered in the State of California)** Prevost warrants the Emission Control Systems on each new VOLVO diesel engine in a new Prevost coach to comply with all State of California emissions regulations applicable at the time of manufacture of the engine, and to be free from defects in material and workmanship under normal use and service up to 60 months or 160 000 km (100,000 miles), whichever occurs first, provided all Prevost maintenance requirements are followed as described in this manual. All warranty periods are calculated from the date-in-service of the new vehicle. The repair or replacement of defective parts will be made without charge for the cost of parts and, if repairs are made at an authorized Prevost Service Center, there will be no charge for labor. Prevost's obligation under this warranty is limited to the repair or replacement, at Prevost's option, of any part(s) of Emission Control Systems of such engine and/or vehicle found to be defective upon examination by Prevost and provided that such part(s) were returned to Prevost or its nearest authorized Dealer within a reasonable period of time.

### *Qualifications and Limitations:*

**Not covered** by the Emissions Control Systems Warranty:

- Malfunctions caused by misuse, improper adjustments, modification, alteration, tampering, disconnection, improper or inadequate maintenance and use of improper diesel fuel or DEF.
- Damage resulting from accident, acts of nature or other events beyond the control of Prevost
- Inconvenience, loss of use of the vehicle, commercial loss of any kind including, but not limited to, consequential or incidental damages.
- Any vehicle in which the odometer has been altered or damaged so that mileage cannot be readily determined.

**THIS WARRANTY IS EXPRESSLY IN LIEU OF ALL OTHER WARRANTIES AND REPRESENTATIONS OR CONDITIONS, STATUTORY OR OTHERWISE, EXPRESSED OR IMPLIED INCLUDING, BUT NOT LIMITED TO, IMPLIED WARRANTY OF MERCHANTABILITY OR FITNESS FOR A PARTICULAR PURPOSE.**

### Emissions Control System Warranty

The following engine components are covered by the supplemental emissions control system warranty policy as required by the California code of regulations.

- 1 Engine Turbocharger Assembly
  - Variable Geometry Turbo (VGT) Actuator
- 2 Charge Air Cooler (CAC)
- 3 Engine Control Module (ECM)
- 4 Injectors
- 5 EGR Cooler
- 6 EGR Valve and EGR Valve Control
- 7 EGR Venturi
- 8 Crankcase Breather (Does not include Crankcase Pressure Sensor)
- 9 Crankcase Separator
- 10 Crankcase Tubing and Hoses before Separator
- 11 Aftertreatment Wiring Harness (DPF)
- 12 Aftertreatment Wiring Harness (SCR)
  - Jumper to AHI Pressure Regulator
  - ACM Power Supply
  - Heater NOx Care
  - DEF Tank
- 13 Aftertreatment Control Module (ACM)
- 14 Aftertreatment Diesel Particulate Filter (DPF) with Aftertreatment Diesel Oxidation Catalyst (DOC)
  - Aftertreatment Doser
  - Aftertreatment Fuel Shutoff Valve
  - Aftertreatment Fuel Pressure Sensor
  - Engine Exhaust Gas Temperature (EGT) Sensor
  - Aftertreatment DPF Intake Temperature Sensor
  - Aftertreatment DPF Outlet Temperature Sensor
  - Aftertreatment DPF Differential Pressure Sensor
- 15 Sensors:
  - Crankshaft Position (CKP) Sensor
  - Transmission Speed Sensor
  - Engine Coolant Temperature (ECT) Sensor
  - Intake Manifold Air Temperature/Pressure Sensor
  - Exhaust Gas Recirculation (EGR) Temperature Sensor
  - Aftertreatment Outlet NOx Sensor
  - Aftertreatment Intake NOx Sensor
  - Engine Exhaust Gas Recirculation Differential Pressure Sensor
  - Ambient Air Temperature (AAT) Sensor
- 16 SCR
  - Aftertreatment Selective Catalytic Reduction (SCR) Catalyst
  - Aftertreatment Diesel Exhaust Fluid (DEF) Pump
    - Aftertreatment DEF Dosing Absolute Pressure Sensor
    - Aftertreatment DEF Return Valve
  - Aftertreatment DEF Dosing Valve
  - Aftertreatment DEF Tank
  - Aftertreatment DEF Tank Heater/Sender
  - Aftertreatment DEF Tank Heater
  - Aftertreatment DEF Tank Heater Valve
  - Aftertreatment DEF Tank Temperature Sensor
  - Aftertreatment DEF Level Sensor

- Aftertreatment DEF Heated Lines
- Aftertreatment DEF Quality Sensor

17. Instrument Cluster (Repair of Microprocessor)

18. Exhaust Gas Piping (from Turbocharger to Aftertreatment System)

### **Emission Green House Gas Component Warranty (If Equipped)**

#### *Critical Emissions-Related Maintenance*

**Source of parts and repair:** A repair shop or person of the owner's choosing must maintain, replace, or repair emission control devices and systems per manufacturer's recommendations.

**Replacement of tires that are GHG certified:** The original equipment tires installed on this vehicle at the factory were certified to the U.S. EPA Greenhouse Gas (GHG) and National Highway Traffic Safety Administration (NHTSA) Fuel Efficiency regulations. Replacement of these tires should be with a tire of equal or lower rolling resistance levels (TRRL or Crr). Please consult your tire supplier(s) for appropriate replacement tires.

**Maintaining a GHG certified tire:** In order to maintain the certified rolling resistance of the tires which optimize fuel economy, the maintenance procedures provide by the tire manufacturer must be followed.

*Please visit Previst Web Site for further information about Warranty.*



## **Engine Brake**

The engine brake is operated by the Engine Brake buttons on the steering wheel. It works together with the exhaust brake to provide two levels of braking power. There are three Engine Brake buttons on the steering wheel: OFF, (1) LOW and (2) HIGH. When the Engine Brake button (1) LOW is depressed, only the exhaust brake is engaged. When the Engine Brake button (2) HIGH is depressed, both the exhaust brake and the compression brake are activated. The following conditions must be met:

- Engine Brake button (1) LOW or (2) HIGH depressed
- Engine Brake/Transmission Retarder selector switch is set to Engine Brake position (selector switch can be found on the dashboard only if the vehicle is equipped with both systems)
- Vehicle speed over 12 km/h (7.5 mph)
- Engine temperature over 43°C (110°F)
- Accelerator pedal is released
- Engine speed exceeds 1150 rpm

## Engine Components, Service Schedules

Component	Operation	Km (Miles)/Maximum Months/Hours
Engine Fuel Filter	Change	Each oil change *
Water Separator	Filter change	Each oil change *
Air Filter US 2010	Change	160 000 (100,000) or 12 months, whichever comes first
Engine Coolant	Change	500 000 (300, 000) or 24 months, whichever comes first
Engine Coolant (ELC)	Change	1 000 000 (600,000) or 48 months, whichever comes first
Coolant Filter US 2010	Change	80 000 (50,000) or 6 months, whichever comes first
Engine Coolant Filter (ELC) US 2010	Change	240 000 (150,000) or 12 months, whichever comes first
Valves/Engine Injectors **	Initial Adjust	200 000 (125,000) or 12 months, whichever comes first
Valves/Engine Injectors **	Adjust	400 000 (250,000) or 24 months, whichever comes first
Catalyzed DPF Filter (If equipped)	Change	400 000 (250,000) or 4,500 hours, whichever comes first.
Aftertreatment Diesel Exhaust Fluid Dosing Valve	Clean	240 000 (150,000) or 4,500 hours, whichever comes first.
Aftertreatment Diesel Exhaust Fluid (DEF) Pump Filter	Change	First Change; 161 000 (100,000), 3200 hours or three (3) years. Then every 241 000 (150,000) 4800 hours or three (3) years, whichever comes first.
Diesel Exhaust Fluid (DEF) Tank Filler Neck Filter Cleaning	Clean	280 000 (175,000) or 12 months, whichever comes first.

\*Under certain conditions (for example, irregular fuel quality), the fuel/water separator filters may require more frequent replacement.

\*\*Valves must be adjusted whenever the rocker shaft has been removed and reinstalled for any reason.

## **Cooling System**

### **General Coolant Information**



#### **DANGER**

Coolant is toxic; risk of poisoning. **DO NOT** drink coolant. Use proper hand protection when handling. Keep coolant out of reach of children and animals. Failure to follow these precautions can cause serious illness or death.



#### **WARNING**

Coolant may be combustible. Coolant leaked or spilled onto hot surfaces or electrical components can cause a fire. Clean up coolant spills immediately.



#### **WARNING**

**DO NOT** raise the engine hood if you see or hear steam or coolant escaping from the engine compartment. Wait until steam or coolant cannot be seen or heard before raising the hood.

**DO NOT** remove the coolant fill cap if the coolant in the surge tank is boiling. Also, **DO NOT** remove the cap while the engine and radiator are still hot. Scalding fluid and steam may be blown out under pressure if the cap is taken off too soon and can cause personal injury.



#### **CAUTION**

Prevost and Volvo Bus Corporation does not recommend using plain water in the cooling system. Water alone is corrosive at engine operating temperatures and does not provide adequate boiling protection. The engine may develop corrosion and cavitation problems in the engine and radiator, and the boiling point of the coolant is lowered compared to a proper antifreeze and water mixture. Failure to follow Prevost and Volvo Bus Corporation cooling system care/maintenance recommendations can render the warranty invalid.

The main purpose of coolant is to transport heat from the hot parts of the engine to the radiator and to protect the cooling system from corrosion.

In addition to this, the coolant must:

- Protect against pitting and cavitation erosion damage of the water pump and cylinder liners.
- Protect against freezing and boiling.
- Prevent formation of scale, sludge deposits and clogging.
- Be harmless to polymer materials and seals in the cooling system.
- Maintain its liquid properties in cold climates.

Many engine failures can be traced back to a problem in the cooling system. If the coolant level is allowed to go below the bottom of the tank, there is the risk of the engine shutting down. See the operators manual for more information on the warning functions.

**Note:** Always dispose of coolant according to Federal or local regulations. Take all used coolant to a recycling or waste collection center.

Coolant mixture consisting of an antifreeze solution in water should be used year-round to provide freeze and boil-over protection as well as providing a stable environment for seals and hoses.

**Note:** DO NOT use antifreeze formulated for automobile gasoline engines. These have a very high silicate content that will clog the radiator and leave unwanted deposits in the engine.

Freeze Protection Down To:	Percentage of Antifreeze in Mixture
– 25°C (– 13°F)	40%
– 30°C (– 22°F)	46%
– 38°C (– 36°F)	54%
– 46°C (– 51°F)	60%

A well functioning and maintained cooling system is as important to the engine as performing regular oil changes or using good fuel. To get the best result use quality products and service the system at the correct intervals. Please read this section carefully.

Keep the radiator (including charge air cooler) and the frontal area free from bugs, dirt, leaves, etc.

Check the coolant level in the tank regularly. Fill the tank as necessary with the correct coolant.

Inspection of the whole cooling system is important. Check for swollen or deteriorated heater and radiator hoses, loose hose clamps and connections, and radiator leaks.



## DANGER

DO NOT work near the fan with the engine running. The engine fan can engage at any time without warning. Anyone near the fan when it turns on could be seriously injured. Before turning on the ignition, be sure that no one is near the fan.



## CAUTION

Never add coolant to a hot or overheated engine. Engine damage can result. Allow the engine to cool first.

## Additives

Additives help prevent rust, scale and mineral deposits from forming. Additives also protect metals from corrosion, prevent water pump and cylinder liner cavitation and contain anti-foaming agents. Additives are depleted during normal engine operation and need to be **replaced**. For non-extended life coolant mixture, this means the addition of **Supplemental Coolant Additives (SCA)** at any time the additive goes below the recommended level. For extended life coolant mixture, this means an extender package added halfway through the coolant lifetime.

## 70 VOLVO Engines

---

### Regular Coolant Change Interval

Coolant SCA level must be tested at least twice per year or whenever coolant loss occurs. For maximum coolant system efficiency, test the system at every engine oil change interval, every 1,000 hours or every 6 months (whichever comes first). For proper SCA levels, consult Service Manual.

### *Regular Coolant Filter Change Intervals*



#### **WARNING**

Hot engine. Keep clear of all hot engine parts and fluids. A hot engine and fluids can cause serious burns.

The charged coolant filter contains 8 units of SCA that are released slowly over time to maintain the recommended level during operation. Consult engine service manual for proper SCA level and change intervals.

### Extended Life Coolant Change Interval



#### **WARNING**

Hot engine. Keep clear of all hot engine parts and fluids. A hot engine and fluids can cause serious burns.



#### **CAUTION**

Extended life coolant will test as out of additives (SCA), but SCA should not be added. Shortened engine life may be the result of adding SCA.



#### **CAUTION**

**DO NOT** use a filter that contains SCA. Damage to components can result.

**Note: DO NOT add supplement coolant additives (SCA) to extended life coolant.**

Should the extended life coolant system become contaminated with regular coolant exceeding 10% of the systems total capacity or if SCA is added to extended life coolant, drain the system and refill with new extended life coolant or regular coolant.



**VOLVO**

**Volvo Bus Corporation**

Göteborg, Sweden



# Driver's Handbook

## Toilet

9700



**VOLVO**

# Foreword

This manual contains information concerning the operation and function of the bus toilet facility. The information in this manual applies to vehicles built in 2015 and later. Please keep this manual in the vehicle at all times.

**Note:** Illustrations in this manual are used for reference only and may differ slightly from the actual vehicle. However, key components addressed in this document are represented as accurately as possible.

The National Highway Traffic Safety Administration (NHTSA) and Volvo Trucks North America should be informed immediately if you believe that the vehicle has a defect that could cause a crash, injury or death.

Contact NHTSA by calling the Auto Safety Hotline at 1 (888) 327-4236, by writing to NHTSA, U.S. Department of Transportation, Washington, DC 20590, by TTY at 1 (800) 424-9153, or visit their website at [www.nhtsa.dot.gov](http://www.nhtsa.dot.gov).

## Volvo Bus Corporation

Göteborg, Sweden

**Order number: 89180362**

©2014 Volvo Bus Corporation, Göteborg, Sweden

All rights reserved. No part of this publication may be reproduced, stored in retrieval system, or transmitted in any forms by any means, electronic, mechanical, photocopying, recording or otherwise, without the prior written permission of Volvo Bus Corporation

---

# Contents

<b>Toilet .....</b>	<b>1</b>
Toilet .....	1
Valves and Water Tanks .....	2
Operation Instructions .....	3
To Flush the Toilet .....	3
Holding and Freshwater Tanks .....	4
In Case of an Emergency .....	4
Water Tank Filling & Emptying .....	5
Toilet Enclosure Cleaning .....	5
Toilet Bowl Cleaning .....	5
Trash Bin .....	5
Soap Dispenser .....	6
Toilet Paper Roll Dispenser .....	6
Maintenance .....	7
Daily Routine .....	7
Weekly Routine .....	8
Quarterly Routine .....	9
Sticker Legend .....	10



---

# Safety Information

**IMPORTANT:** Before driving this vehicle, be certain that you have read and that you fully understand each and every step of the driving and handling information in this manual. Be certain that you fully understand and follow all safety warnings.

IT IS IMPORTANT THAT THE FOLLOWING INFORMATION BE READ, UNDERSTOOD AND ALWAYS FOLLOWED.

The following types of advisories are used throughout this manual:



## DANGER

Danger indicates an unsafe practice that could result in serious personal injury or death. A danger advisory banner is in **white** type on a **black** background with a **black** border.



## WARNING

Warning indicates an unsafe practice that could result in personal injury. A warning advisory banner is in **black** type on a **gray** background with a **black** border.



## CAUTION

Caution indicates an unsafe practice that could result in damage to the product. A caution advisory is in **black** type on a **white** background with a **black** border.

**Note:** Note indicates a procedure, practice, or condition that must be followed in order for the vehicle or component to function in the manner intended.

---

## Toilet

The toilet is composed with the following parts:

- 1 Door Lock
- 2 LED Spot Light
- 3 PIR Sensor
- 4 Mirror
- 5 Vanity Door Hinges
- 6 Push Plunger
- 7 Alarm Button
- 8 Toilet Bowl Assy
- 9 Toilet Seat
- 10 Flush Button
- 11 Ambient Light

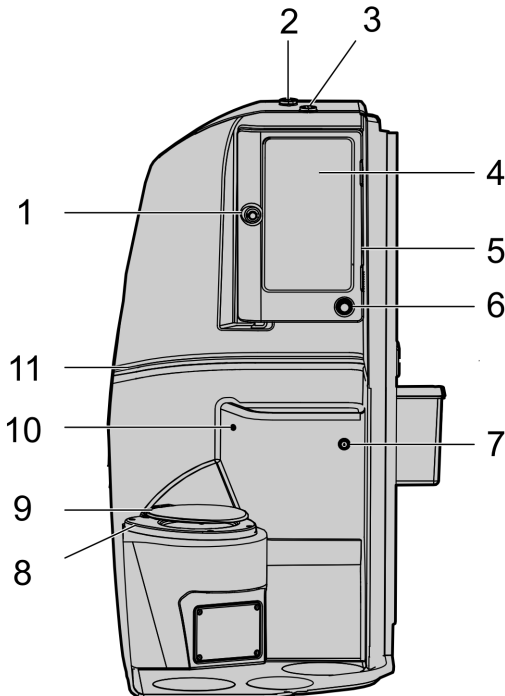

## 2 Toilet

### Valves and Water Tanks

The fill valves for the water tanks are located on the right side of the bus, behind the rear axle. The drain valves are located under the passenger area in front of the rear axle

- 1 Sink water tank fill valve.
- 2 Flushing water tank drain valve.
- 3 Holding tank
- 4 Fresh water tank
- 5 Drain valve fresh water tank
- 6 Pumps

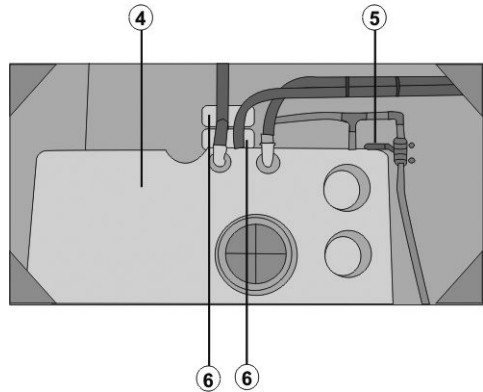
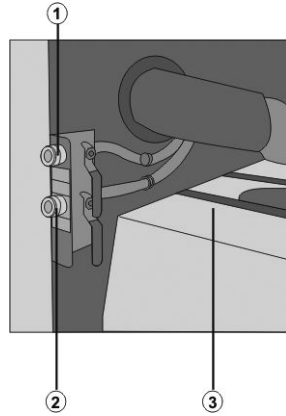



## Operation Instructions

To activate the toilet switch main power supply, push the WC button on the dashboard. When occupying the toilet facility, the interior light will turn on. Even when closing the lock on the inside, an indicator lamp will turn it on in the passengers area.

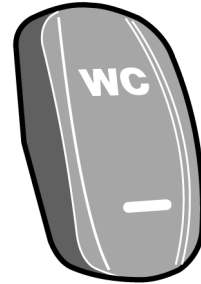

T3018183

Toilet master switch

The interior light is controlled by a movement sensor, that will turn off the light automatically shortly after the facility is vacated. The “Vacant” lamp will then illuminate.

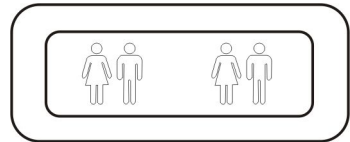

T0015272

“Occupied / Vacant” lamp

## To Flush the Toilet

Push the flush button once to flush the toilet. If further flushing is required, wait for the flush cycle to complete then press the button again.

**Note:** The toilet will flush automatically if the facility is vacated without flushing first.

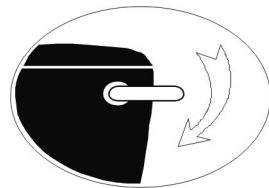

T0015351

Flush button

## 4 Toilet

---

### Holding and Freshwater Tanks

When the holding tank is full, a dashboard LED will illuminate and the “Occupied” lamp will signal. The toilet is now out of use until the holding tank is emptied.



T0015355

Full dashboard LED

When the fresh water tank is empty a dashboard LED will illuminate and the “Occupied” lamp will signal. The toilet is now out of use until the water tank is re-filled.

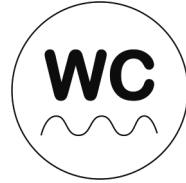

T0015356

Empty dashboard LED

### In Case of an Emergency

Pressing the red alarm button will alert the driver and sound a buzzer. The button is located on the left side of the sink.



T8095635

Emergency Button

---

## Water Tank Filling & Emptying

Tanks are filled via the hose connectors located in the holding tank compartment. The sinks 40 mm (1.6 in.) fill pipe is accessed by removing the litter bin and the flush tank. These are attached with a 100mm (4 in.) cap screws that can be accessed through the floor trap.

The holding tank is emptied by firmly pulling the handle on the slide valve located underneath the tank.

## Toilet Enclosure Cleaning

The enclosure is manufactured from Glass Reinforced Plastic (GRP) with high gloss interior and lightly textured exterior surfaces. This surface finish is delicate and must only be washed down using a mild detergent. The use of a caustic or abrasive material is not recommended, as this will affect the appearance.

## Toilet Bowl Cleaning

To protect the finish of the Stainless Steel toilet bowl, do not use abrasives of any kind. To clean the bowl, use a mild anti-bacterial detergent and a suitable brush.

## Trash Bin

The trash bin is located on the wall beside the door. The use of a trash bag is recommended.



## 6 Toilet

---

### Soap Dispenser

To fill the dispenser, unlock the mirror cabinet, lift the lid of the dispenser and fill with liquid soap.

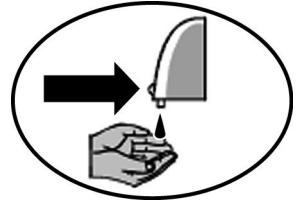

T8014110

### Toilet Paper Roll Dispenser

It is recommended that a biodegradable paper is used all times. The toilet paper roll is located inside the lower vanity door. Unlock and open the door and slide the roll onto the spindle.

**Note:** Domestic grade toilet paper is not recommended as this can block the system.

---

## Maintenance

### Daily Routine

- Prior to the vehicle entering service the holding tank should be charged with an additive to sanitize it.
- The recommended product is **Shades Super Sani ECO**, formulated from natural essential oils. This formaldehyde-free formula is contained within a water soluble membrane. A single 16 gram bottle contains the recommended dosage for 110 liter (26 gallons) capacity holding tank and will function for a maximum of three days.  
To apply:
  - 1 Ensure the holding tank is empty.
  - 2 Verify that the tank evacuation valve is closed.
  - 3 Verify that the toilet clean water tank is full.
  - 4 Switch the toilet facility power on.
  - 5 Press the flush button to open the toilet valve and pour the complete bottle into the bowl.
- It is recommended that the toilet supply tank be drained and the waste holding tank be emptied at the end of every day.
- The daily addition of a couple of drops of mild detergent into water resting in the toilet bowl will lubricate the slider and protect the seal.
- The sink tank should be emptied and re-filled daily. To help maintain a clean tank and freshwater the use of a water conditioner is recommended. Use a suitable product that disinfects the water, that is safe to drink and non-irritable to the skin and eyes.

## 8 Toilet

---

### Weekly Routine

- Check exhaust fan function.
- Inspect faucet, door hinges and toilet seat. Check the operation of the enclosure door and lock function. Test alarm button and buzzer function.
- Open vanity door, check extractor fan and pneumatic valve connections.
- Verify that the water flow to the sink basin is smooth and constant.

---

## Quarterly Routine

- Flush out holding tank with fresh water. (the holding tank must be empty and the vehicle positioned so that the holding tank evacuation valve is over a sewage drainage point )

To flush out:

- 1 Switch the toilet facility power on.
  - 2 Connect a hose to a main water supply.
  - 3 Press the flush button once to open the slide valve.
  - 4 When the valve opens, insert the end of the hose down through the bowl, into the drain pipe. When the valve closes the hose will be held into position by the paddle pressure.
  - 5 Turn on the water to the hose and fill the holding tank, being careful not to overfill.
  - 6 Switch off the water to the hose and open the evacuation valve to empty the tank.
  - 7 Press the flush button to open the valve and remove the hose when done.
- Lubricate the holding tank evacuation valve. ( to be carried out immediately after flushing the holding tank ).  
Undo the four bolts holding the drain valve assembly together and remove the main body section. Lubricate the slide paddle using lithium grease or similar so the open/close operation is smooth. Install the drain valve.  
Do not over tighten as this will restrict the operation of the valve.
  - Disinfect the sink tanks and flush with fresh water.

# 10 Toilet

## Sticker Legend

Refer to the toilet facility sticker legend to become familiar with the equipment found in the toilet facility.

- 1 Do not stand up, do not use standing up position, do not throw strange objects in the bowl.
- 2 No smoking
- 3 Left door closed
- 4 Right door closed
- 5 Flushing water
- 6 Emergency button
- 7 Logo
- 8 Toilet paper roll
- 9 Paper towel dispenser
- 10 Soap dispenser
- 11 Trash bin

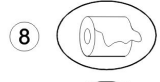
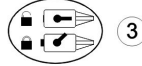





**VOLVO**

**Volvo Bus Corporation**

Göteborg, Sweden

# Driver's Handbook

## Bus Interior Maintenance

9700

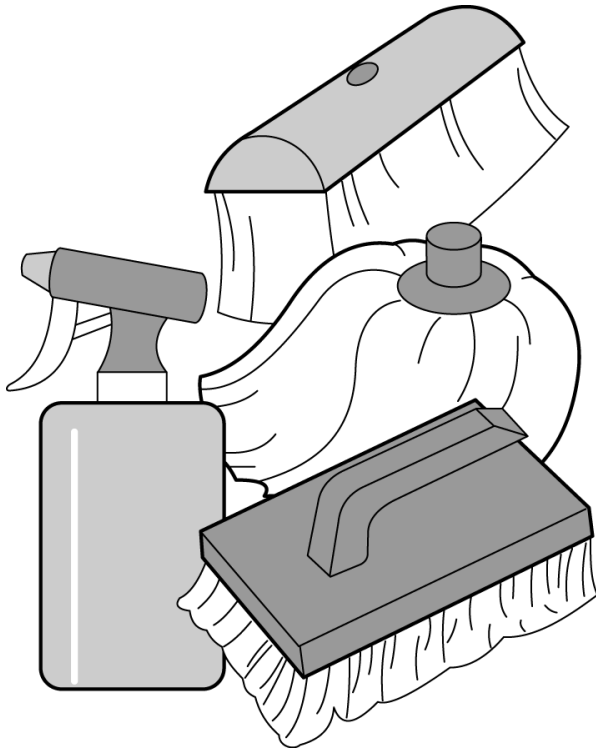

T1008766

**VOLVO**

# Foreword

This manual contains information concerning the maintenance of the Volvo 9700 Bus interior. The information in this manual applies to vehicles built October 2008 and later. Please keep this manual in the vehicle at all times.

**Note:** Illustrations in this manual are used for reference only and may differ slightly from the actual vehicle. However, key components addressed in this document are represented as accurately as possible.

**Volvo Bus Corporation**

Göteborg, Sweden

**Order number: 89189666**

©2015 Volvo Bus Corporation, Göteborg, Sweden

All rights reserved. No part of this publication may be reproduced, stored in retrieval system, or transmitted in any forms by any means, electronic, mechanical, photocopying, recording or otherwise, without the prior written permission of Volvo Bus Corporation

---

# Contents

<b>General Information</b> .....	1
Types of Trim Material Used in the 9700 Buses .....	1
Keeping the Vehicle Clean — Overview .....	2
<b>Floor Cleaning</b> .....	5
PVC Coverings .....	5
Rubber Corner Moldings .....	8
Carpet Covering .....	9
<b>Cleaning Laminates</b> .....	10
Wall and Ceiling Laminates and Interior Partitions .....	10
<b>Cleaning Upholstery</b> .....	12
Upholstery .....	12
Anti-static solution; application procedure .....	19
<b>Maintenance of the Seats</b> .....	20
Imitation Leather .....	20
Velour .....	21
Real Leather .....	23
Covers on Seat Headrests .....	23
<b>Washing and Maintenance of the Driver's Position</b> .....	24
Dashboard, Steering Wheel, Gear Selector Lever, Shelves and Driver Caddies .....	24
Instrumentation .....	24
<b>Washing Windows and Glass</b> .....	25
Glass, Interior Partition Glass .....	25
Window Pillars and Sills .....	26
<b>Cleaning Additional Items</b> .....	27
Hand Rails, Handles, Aluminium, Chrome and Nickel Items .....	27
Diaphragm .....	27
Driver's Blind .....	27
Curtains .....	27
<b>Index</b> .....	29



---

# Safety Information

**IMPORTANT:** Before driving this vehicle, be certain that you have read and that you fully understand each and every step of the driving and handling information in this manual. Be certain that you fully understand and follow all safety warnings.

IT IS IMPORTANT THAT THE FOLLOWING INFORMATION BE READ, UNDERSTOOD AND ALWAYS FOLLOWED.

The following types of advisories are used throughout this manual:



## DANGER

Danger indicates an unsafe practice that could result in serious personal injury or death. A danger advisory banner is in **white** type on a **black** background with a **black** border.



## WARNING

Warning indicates an unsafe practice that could result in personal injury. A warning advisory banner is in **black** type on a **gray** background with a **black** border.



## CAUTION

Caution indicates an unsafe practice that could result in damage to the product. A caution advisory is in **black** type on a **white** background with a **black** border.

**Note:** Note indicates a procedure, practice, or condition that must be followed in order for the vehicle or component to function in the manner intended.

---



## Types of Trim Material Used in the 9700 Buses

### Floor

- PVC covering
- Carpet covering (removable)

### Side Walls

- Velour upholstery trim
- Leather-effect upholstery trim
- Laminate

### Ceiling, Luggage Racks, Roof Ducts

- Laminate
- Leather-effect upholstery trim
- Velour upholstery trim

### Seats

- Imitation leather
- Velour
- Real leather

### Finishes

- Aluminium
- Lacquered steel
- Chrome, chrome nickel and aluminium items
- Rubber floor edging and other rubber items
- Plastic items

## 2 General Information

---

### Keeping the Vehicle Clean — Overview

The maintenance procedures described in the following instructions ensure the correct utilization and attractive appearance of the vehicle interior.

Correct maintenance of all bus interior will ensure optimum service life and durability.

Areas subject to heavy passenger use require greater attention on the part of the cleaning team.

#### **Maintenance Objectives:**

- Ensure cleanliness of floor surfaces, walls, ceilings, trim and seats
- Maintain hygiene
- Return floor surfaces, walls, ceilings, trim and seats, to their original attractive appearance
- Extend the service life of finish items in the bus interior

#### **Sequence for Carrying Out Operations**

**Note:** Remember the sequence for carrying out operations when cleaning. Always begin cleaning from the top down. Start with items such as ceilings, luggage racks, lights and then move on to ones lower down like wall laminates, interior partitions, hand rails, seats. Floor cleaning should be carried out last. Do not walk on washed or cleaned surfaces until they are completely dry.

## Equipment:

- Cloth, broom, hand brushes (particularly for places that are difficult to reach, i.e. areas under passenger seats, luggage racks)
- Dust mop
- Cleaning mop for damp wiping
- Scrubbing brush
- Vacuum cleaner for collecting loose dust and dirt (various attachments)
- Floor/carpet washer with water extraction (various attachments)
- Protective clothing, rubber gloves
- Detergents and cleaning agents designed for various types of surfaces, as recommended by Authorized Volvo Service Outlets, as well as by the manufacturers of the trim materials

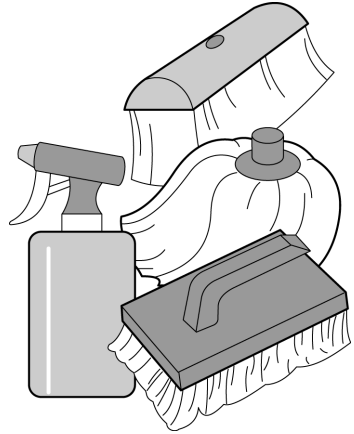

T1008766



## CAUTION

Do not use aggressive agents. Failure to do so may result in damage to the components.



T1008772

## 4 General Information

---

### Using stain removers, solvents and other permitted chemical substances

#### **DANGER**

Before using a chemical agent, read the instructions governing its use, as well as the instructions on how to proceed in a hazard situation (e.g. contact of the agent with the skin or the eyes). Failure to do so may result in serious personal injury or death.

#### **CAUTION**

To prevent damage to the surface of coverings or other items of the bus interior, each chemical agent used should first be tested on a small invisible area.

### Guidelines for protection of the environment

**Note:** The empty packaging from chemical agents used in washing the vehicles interior, as well as fabric items used for cleaning, should be disposed of in an ecologically sound manner.

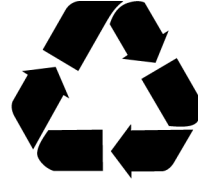

T1008770

## PVC Coverings

### Overview



#### CAUTION

High pressure washers, steam cleaners, as well as abrasive disc and rotary scrubbing machines may not be used for washing floors with PVC coverings. Failure to do so may result in damage to the floors.

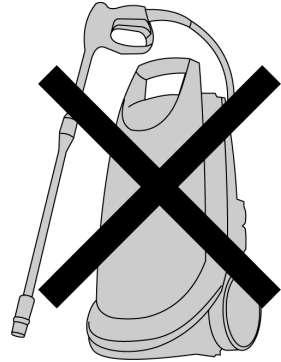

T1008767



#### CAUTION

Running water may not be used to clean a floor with a PVC covering. Excessive water may result in damage to the floor.



T1008768



#### CAUTION

Solvents, aggressive agents and alcohol-based solvents may not be used to clean a floor with a PVC covering. Failure to do so may result in damage to the covering.



T1008772

## 6 Floor Cleaning

---

### Daily Maintenance

The following should be carried out daily:

- Sweep the floor with a soft brush, or vacuum
- Wipe the floor down with a damp mop. The floor should be wiped with the mop in a figure eight motion, ensuring that no area has been missed.
- If a lot of dirt is present on the floor, clean it with a damp, well squeezed out mop using a neutral detergent.
- Use a mop or floor washer to remove any dirty water.

**Note:** Use a two-compartment container for the water, or two buckets (one for the dirty water and one for the clean water). Double rinsing the mop to remove both dirt and cleansing agents, stops the covering from losing its color and its anti-slip surface from getting scratched.



T1008758

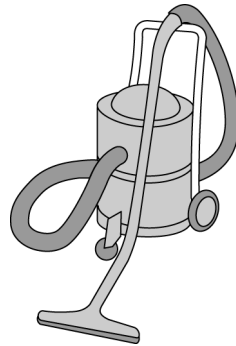

T1008761



T1008759

## Thorough Washing of the PVC Surface

The PVC surface should be thoroughly washed once a month.

To do this, you should:

- Sweep the floor using a soft brush or vacuum it. Sweep places that are difficult to access (under the seats, the floor edges and the corners) with a hand brush.

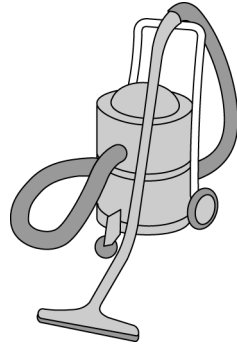

T1008761

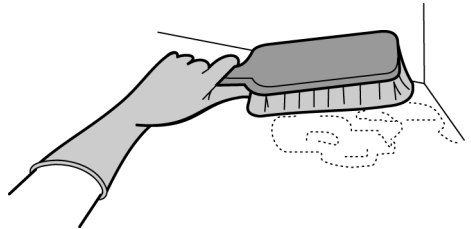

T1008799

- Cover the entire floor with cleansing agent, and wait for 2 to 3 minutes.
- Scrub the floor with a long-handled brush or small scrubbing brush
- Remove any stubborn stains (chewing gum, asphalt etc.) using a scraper or brush
- Use a mop or floor washer to remove any dirty water.

**Note:** Use a two-compartment container for the water, or two buckets (one for the dirty water and one for the clean water). Double rinsing the mop to remove both dirt and cleansing agents, stops the covering from losing its color and its anti-slip surface from getting scratched.



T1008759

## 8 Floor Cleaning

### Rubber Corner Moldings

#### Daily Maintenance

The following should be carried out daily:

- Wipe down the rubber corner molds with a damp cloth



T1008800

- If a lot of dirt is present on the floor, clean it with a damp, well squeezed out mop using a neutral detergent

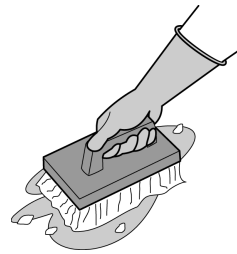

T1008801

- Remove stubborn marks such as those of chewing gum or asphalt etc. using a brush or scraper.

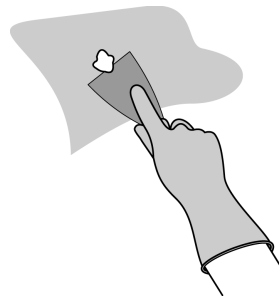

T1008802



#### CAUTION

Exercise care when removing dirt with a scraper so as not to damage the moldings. Piercing a molding can cause water to seep under the covering during washing down, and this can result in damage to the floor adhesive.



## Carpet Covering

There may be carpeted flooring in the bus entrance on the steps, in the driver's compartment, under the passenger seats and in the luggage archways. The carpet covering is attached to the floor using retaining studs.

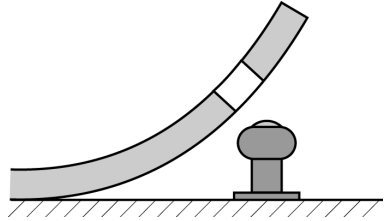

T8012277

## Daily Maintenance

Daily maintenance of carpeted flooring involves thorough vacuuming of the carpet surface using a vacuum cleaner inside the vehicle. The carpet mats do not have to be unclipped to carry out this operation.

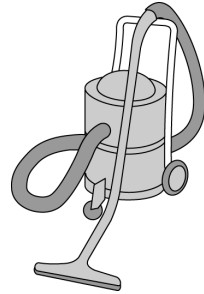

T1008761

## Washing Carpet

The carpet may be washed as necessary. Because the carpet can be removed, washing should be carried out outside the vehicle. To do this, the carpet surface should first be vacuumed, so as to remove larger particles of dirt, such as crumbs or sand, and then the full carpet surface should be cleaned using a special carpet washer.

**Note:** After removing the carpet, vacuum or sweep the floor so as to remove dust and sand.

**Note:** Be sure to allow the carpets to dry before installing them back into the bus.

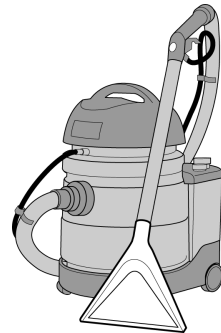

T1008775

# 10 Cleaning Laminates

## Wall and Ceiling Laminates and Interior Partitions

### Daily Maintenance

Daily maintenance of wall, ceiling laminates and lower partition items involves thorough wiping down the laminate surface using a damp cloth and neutral detergent. Wall laminates and interior partition laminates should be cleaned more often, given that they are more likely to get dirty.

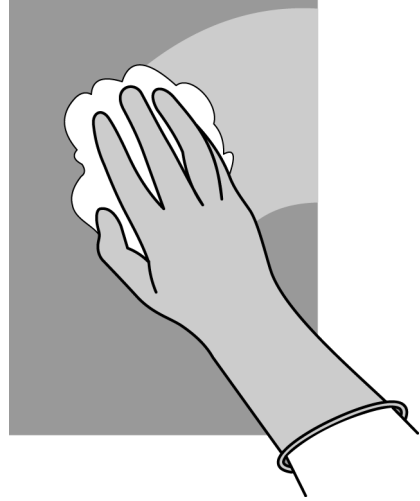

T1008800

### Cleaning Stubborn Dirt

Problematic dirt, such as scuff marks from shoes, mud etc., should be removed using detergents and brushes of medium stiffness. After cleaning the surface, wipe it down with a damp cloth.

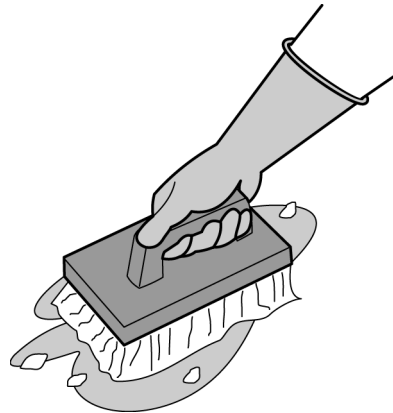

T1008801



#### CAUTION

Do not use solvents as they can result in the laminate pattern being rubbed off.



## CAUTION

Large amounts of water must not be used in the washing of laminates. Over wetting of the laminates may result in separation of the laminate layers.



T1008773

Stubborn marks such as those of chewing gum or asphalt etc. should be removed using a scraper.



## CAUTION

Exercise care when removing dirt with a scraper so as not damage (scratch) the laminate.

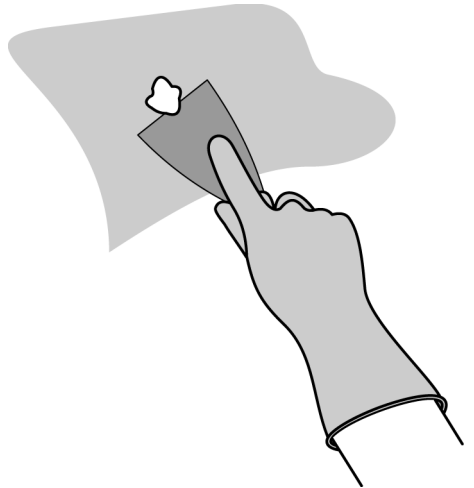

T1008802

# 12 Cleaning Upholstery

---

## Upholstery

The interior of the 9700 bus (ventilation ducts, luggage racks, headliner, lining of the luggage racks, upholstery trim of the toilet surround, rear wall liner) may be upholstered.

## Daily Maintenance

Daily maintenance of the upholstery trim involves thorough removal of dust from the surface of the upholstered items using a soft brush (e.g. a clothes brush) or a vacuum cleaner. For this, special attachments and nozzles designed for upholstery should be used (brushes, crevice nozzles, nozzles for places that are difficult to reach).

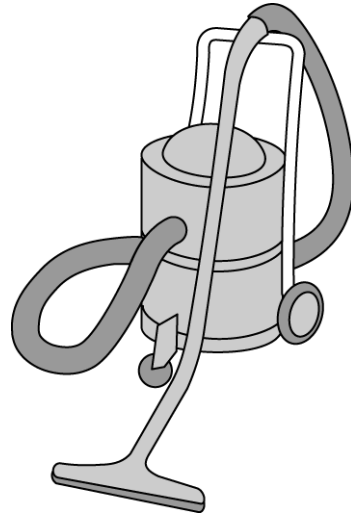

T1008761



### CAUTION

When cleaning upholstery trim using a vacuum cleaner, take into account the suction force of the vacuum. Excessive suction force on the upholstery can cause damage from stretching the fabric and pulling out fibers. To extend the life of the bus upholstery, do not use industrial vacuums for cleaning.

Upholstery can be wiped with a chamois cloth paying attention to the direction of the pile of the upholstery material.

## Washing Wall and Ceiling Upholstery Trim

Wash the wall or ceiling upholstery trim of the bus as needed, using dry foam. Put a small amount of the agent on a damp sponge and work up a foam with the sponge. Apply the foam to the upholstery and gently rub over the dirty upholstery. Vacuum off the foam using a carpet washer or remove it using a soft brush.

	<h3>CAUTION</h3>
<p>Upholstery trim cannot be washed down with water. <b>Do Not</b> over wet the upholstery as the adhesive used to install it is not water resistant and damage or delamination may occur.</p>	

**Note:** To prevent stains, dirty spots on the upholstery should be cleaned along with the whole upholstery surface. After each wash, the covering should be thoroughly brushed out, paying attention to the direction of the pile of the material.

	<h3>CAUTION</h3>
<p>Pressure washers, steam cleaners and running water must not be used to wash down upholstery. The adhesive used to install the upholstery is not water resistant and damage or delamination may occur.</p>	

**Note:** After washing upholstery inside the vehicle, the bus must be aired out and time allowed to dry if needed.

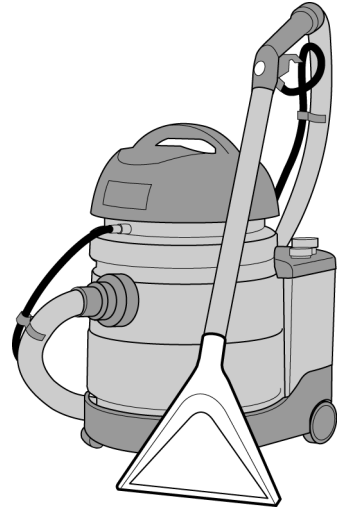

T1008775

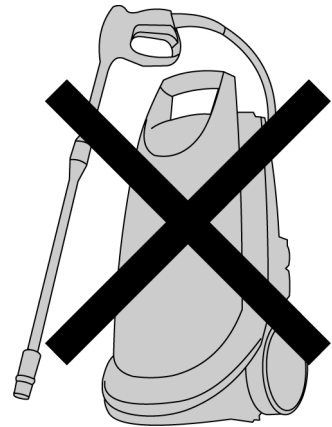

T1008767

## 14 Cleaning Upholstery

---

### Cleaning Stubborn Dirt — Stain Removal

Stains should be removed as soon as possible. Any part of a substance that has not dried out should be scraped off. As much of the substance as possible should be absorbed with a clean, soft cloth. Using a stain remover, wipe the dirty spot with a damp cloth. When cleaning stains, you should start by working inwards from the edges of the stain towards the center.



#### **CAUTION**

Do not use flannel type material in the process to remove stains. For this purpose, only use a microfiber cloth to avoid damage the seats fabric.



#### **CAUTION**

Only with a soft bristle brush; brush the seat fabrics to avoid fabric damage.



#### **CAUTION**

Do not use detergents and solvent based stain removers, to avoid damaging the seats fabric.

General cleaning.

Type of stain	Method of stain removal
Powder, pilling, fluff, dust.	Remove excess of dirt with the help of a vacuum cleaner. If dirt remains, brush in both directions using a soft bristle brush and vacuum the dirt or impurities. Do not use a flannel type cloth or damp cloth to remove the dirt to prevent damage the seats fabric.



**CAUTION**

Do not use solvent-based stain removers.

# 16 Cleaning Upholstery

Stains that dissolve in water.

Type of stain	Method of stain removal
Blood, egg, mud, urine.	Clean with a cold water and neutral shampoo mixture and mix until good foam is obtained. Do not use hot water as egg white will curdle. Remove excess of dirt with a clean microfiber cloth next brush off carefully using an antistatic soft bristle brush with a neutral shampoo foam then remove the dirt exceed with a clean microfiber cloth; repeat this process until the dirt has been removed. Use a drier or sunlight to dry the seat fabric, finally brush the fabric into the pile direction and vacuum it out.
White coffee, vomit, chocolate, ball point pen, pencil, lipstick, mayonnaise, milk, perfumes, cream, shoe polish, sauces, soft drinks, soup, mascara, soot.	Clean with a lukewarm water and neutral shampoo mixture and mix until good foam is obtained. Remove excess of dirt with a clean microfiber cloth next brush off carefully using an antistatic soft bristle brush with a neutral shampoo foam then remove the dirt exceed with a clean microfiber cloth; repeat this process until the dirt has been removed; use a drier or sunlight to dry the seat fabric. If the stain cannot be removed, after drying the material you can try to remove the stain using stain remover or other agents for the removal of stain products that not either solvent based. Finally brush the fabric into the pile direction and vacuum it out.



## CAUTION

Do not use solvent-based stain removers.



Stains that dissolve in water.

Type of stain	Method of stain removal
Coca cola, fruit juices, lemonade, coffee, tea, vodka, beer.	Do not allow the stain to dry. Quickly absorb the stain using dry cloths, paper towels or paper tissues. Clean with lukewarm water and neutral shampoo mixture and mix until good foam is obtained. Remove excess of dirt with a clean microfiber cloth next brush off carefully using an antistatic soft bristle brush with a neutral shampoo foam then remove the dirt exceed with a clean microfiber cloth; repeat this process until the dirt has been removed. Use a drier or sunlight to dry the seat fabric, finally brush the fabric into the pile direction and vacuum it out.



## CAUTION

Do not use solvent-based stain removers.

# 18 Cleaning Upholstery

Stains that do not dissolve in water.

Type of stain	Method of stain removal
Butter, floor polish, grease, resin, coal, shoe polish (oil-based), pencil, lacquer, oil, tar.	Clean with microfiber cloth soaked in stain remover or other agent for the removal of stain products that not either solvent based. Remove excess of dirt with a clean microfiber cloth; repeat this process until the dirt has been removed; use a drier or sunlight to dry the seat fabric. Finally brush the fabric into the pile direction and vacuum it out.
Chewing gum.	Clean with a microfiber cloth soaked in special agent for removing chewing gum. Remove excess of dirt with a clean microfiber cloth; repeat this process until the dirt has been removed; use a drier or sunlight to dry the seat fabric. Finally brush the fabric into the pile direction and vacuum it out.
Rust, dried blood.	Dip a white microfiber cloth in a solution of citric acid (1 flat teaspoonful to 100 ml of cold water). Clean the stains working from the edge in the direction of the center. Remove excess of dirt with a clean microfiber cloth; repeat this process until the dirt has been removed; use a drier or sunlight to dry the seat fabric. Finally brush the fabric into the pile direction and vacuum it out.

After removing stains, is recommended to apply on the fabric seats a special anti-static solution. See “Anti-static solution; application procedure”, page 19.

## Anti-static solution; application procedure

After cleaning and removing stains, it is recommended to apply on the fabric seats a special anti-static solution. In order to extend and obtain the best appearance of the fabric seats.

Follow the next steps to apply the anti-static solution.

**Note:** It is recommended to use a special anti-static solution “**General Purpose Staticide**”.

For further information about the “**General Purpose Staticide**” product. See the following website for more information: [http://www.aclstaticide.com/general\\_purpose\\_staticide.html](http://www.aclstaticide.com/general_purpose_staticide.html)

- Clean fabric as described in the “**Stain removal**” tables procedures for: General cleaning, Stains that dissolve in water and Stains that do not dissolve in water. “Cleaning Stubborn Dirt — Stain Removal”, page 14
- Spray uniformly the fabric with the anti-static solution. The uniformity of the application can also be obtained by brushing the solution in the pile of fabric.

**Note:** Avoid the dripping of the anti-static solution over the fabric.

- Dry the fabric using a drier or under sunlight.

## 20 Maintenance of the Seats

---

### Imitation Leather

#### Daily Maintenance

Daily maintenance of seats covered with imitation leather involves thoroughly wiping down their surfaces using a dry or damp cloth. The top and back of the seats should also be wiped down, as should the underside. To remove dirt, such as scuff marks from shoes and mud, a damp cloth should be used with detergent added. For this, you can use water that neutral washing liquid has been added.



#### CAUTION

**Do Not** over wet the upholstery as the adhesive used to install it is not water resistant and damage or delamination may occur.

In addition, seats of this type may be vacuumed every so often so as to remove items such as crumbs or sand. During vacuuming, particular attention should be paid to items that are difficult to reach — the joints between the cushions, the backs, and folds in the upholstery. When vacuuming this type of seat, a special vacuum cleaner attachment should be used (brush).

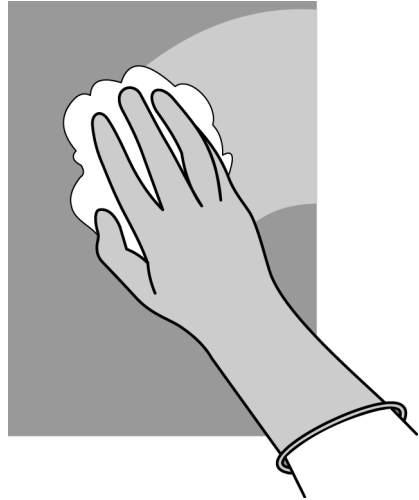

T1008800

## Velour

### Daily Maintenance

Daily maintenance of velour upholstered seats involves thorough removal of dust from their surface using a vacuum cleaner. If dirt remains, brush in both directions and vacuum the impurities.

**Note:** Do not use a damp cloth to remove the dust.

### Washing Upholstered Seats

Upholstered seats can be washed, as needed, using a special carpet washer which extracts the water. During vacuuming, particular attention should be paid to items that are difficult to reach — the joints between the cushions, the backs, and folds in the upholstery. In vacuuming this type of seat, a special vacuum cleaner attachment should be used of washer/extractor type.



#### CAUTION

**Do Not** over wet the upholstery as the adhesive used to install it is not water resistant and damage or delamination may occur.

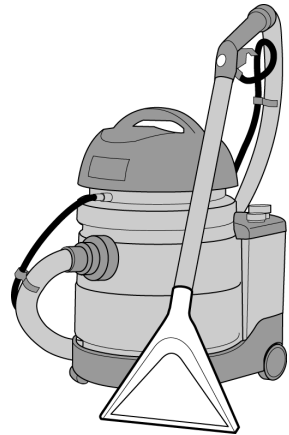

T1008775

**Note:** After washing the upholstery, allow time to air dry.

## 22 Maintenance of the Seats

---

### Cleaning Stubborn Dirt — Stain Removal

Any remaining stains should be removed as soon as possible, as prolonged contact may result in permanent staining of the upholstery.

When removing stains from upholstery, suitable stain removing agents should be used. Chosen an agent in accordance with the recommendations of the seat manufacturer. See also Upholstery, “Cleaning Stubborn Dirt — Stain Removal”, page 14

## Real Leather

Leather items on seats should be wiped with a damp cloth and then dried off.



### CAUTION

Over wetting leather may result in damage to the leather. Exercise care when cleaning leather items.



T1008800

## Covers on Seat Headrests

Covers that have been removed from seat headrests should be washed in accordance with the washing instructions attached to them.

**Note:** In order to maintain a good standard of appearance in the vehicle, covers should be washed after every round trip. The bus should be equipped with the relevant number of headrest covers, so that the travelling comfort of each and every passenger is assured in terms of a clean headrest cover.

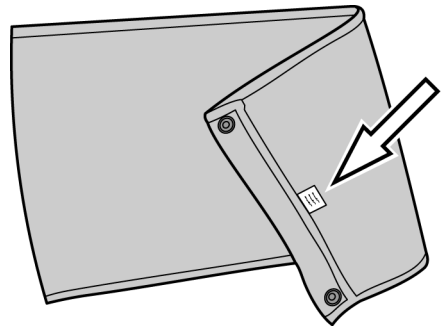

T1008774

## 24 Washing and Maintenance of the Driver's Position

---

### Dashboard, Steering Wheel, Gear Selector Lever, Shelves and Driver Caddies

#### Daily Maintenance

Spray some dashboard protector onto a soft cloth and then distribute equally over the cleaned surface, and dry off.

#### Instrumentation

#### Daily Maintenance

Wipe down dirty areas with a cloth dampened in lukewarm water with some neutral washing liquid added, and then dry off with a dry cloth.



#### CAUTION

Do not use scouring agents as they may damage the finish on the components.



#### CAUTION

Ensure that no moisture gets behind covers and comes in contact with electrical and electronic items. Failure to do so may result in damaged electrical components.



## Glass, Interior Partition Glass

Washing of glass inside the bus should be carried out using special fluids designed for use on glass. After misting on a suitable amount of glass cleaner, wipe the glass down using a cloth.



### CAUTION

Do not use a squeegee to remove the glass cleaner on the interior glass as the fluid will run down onto other finish. Instead wipe the glass down with a cloth. Failure to do so may result in damage to other finishes that the cleaner comes in contact with.

**Note:** The driver's window should be washed with a fluid that has an anti-static characteristic.

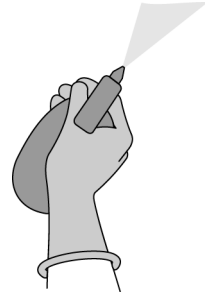

T1008762

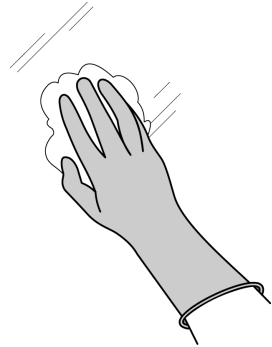

T1008803

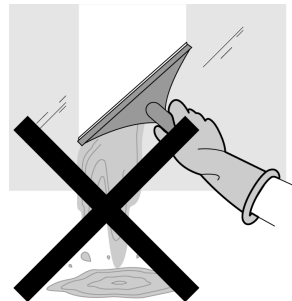

T1008771

## 26 Washing Windows and Glass

---

### Window Pillars and Sills

Wipe down pillars and sills with a damp sponge, with a neutral detergent added as needed. Then wipe down with a dry cloth.



#### CAUTION

Do not use too much water. Over wetting the lower walls may cause delamination of the laminates and or upholstery that cover them.

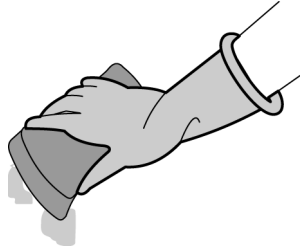

T1008765



T1008773

### **Hand Rails, Handles, Aluminium, Chrome and Nickel Items**

Daily maintenance of the above-mentioned interior equipment involves thoroughly wiping them down using a dry or damp cloth.

Hand rails, handles or covers should be de-greased using detergents and cloths, as needed.

Aluminium items should be protected every so often using special agents designed for aluminium.

Chrome/nickel items should be protected every so often using special agents designed for this purpose.

### **Diaphragm**

Wipe all recesses of the diaphragm clean of dust and dirt, as needed, using a damp cloth or sponge.

### **Driver's Blind**

Unroll the driver's blind, and then remove dust with a vacuum cleaner with a suitable attachment (soft brush for upholstery). The use of an industrial strength vacuum is not recommended to perform this task. Use a vacuum with lower suction force.

### **Curtains**

Washing of the curtains in 9700 buses should be carried out in accordance with the washing instructions attached to the curtains.



**A**

Anti/static solution  
application ..... 19

**C**

Cleaning Additional Items ..... 27  
Cleaning Laminates ..... 10  
Cleaning Upholstery ..... 12

**F**

Floor Cleaning ..... 5

**G**

General cleaning ..... 15  
General Information ..... 1

**M**

Maintenance of the Seats ..... 20

**S**

Stain removal ..... 14  
Stains dissolve in  
water ..... 16–17  
Stains do not dissolve in  
water ..... 18

**W**

Washing and Maintenance  
of the Driver's Position ..... 24  
Washing Windows and  
Glass ..... 25

**VOLVO**

**Volvo Bus Corporation**

Göteborg, Sweden

# Operating Instructions

## Display IC08

B13R, 9700 NAM-SPEC

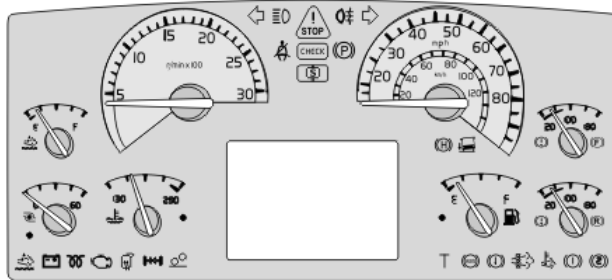

**VOLVO**





---

# Contents

<b>General</b> .....	1	Alarm Clock.....	27
Display and Stalk Switch Control		Trip Meter.....	28
Lever.....	1	Average Speed.....	28
Getting Started.....	2	Estimated Time of Arrival.....	29
Navigating in the DID, (Display at start).....	3	Driving and rest time.....	29
<b>Vehicle Messages and Symbols</b> .....	4	<b>Regeneration menu</b> .....	30
General Information on Vehicle Messages.....	4	Regeneration.....	30
Status Symbols.....	11	Aftertreatment (ATS).....	31
<b>Use the Display Menus</b> .....	12	Aftertreatment (ATS) Enable/Disable... 31	
General Information on Menus.....	12	System Conditions.....	32
Scroll Between the Menus.....	12	<b>Menu Display</b> .....	33
Changing Settings.....	13	Black Panel.....	33
<b>Menu Overview</b> .....	16	Favorite Display.....	33
Main Menus and Sub-menus.....	16	Backlight.....	33
<b>Menu Gauge</b> .....	18	Favorite Display, Set.....	34
Gear Engaged.....	18	Night/Day.....	35
Temperature Outside/Inside.....	18	<b>Menu Vehicle Messages</b> .....	36
Temperature Engine Oil.....	18	Vehicle Messages.....	36
Temperature oil, gearbox/retarder.....	19	Language.....	37
Voltmeter.....	20	Units.....	37
Pressure, Primary Tank.....	20	Time/Date.....	38
Engine Oil Pressure.....	20	Display light.....	39
AdBlue tank, level.....	21	Change Password (If Password is Required).....	40
Brake Pressure, 3rd Circuit.....	21	<b>Menu Vehicle Settings</b> .....	41
<b>Menu Fuel Data</b> .....	22	Traction Control.....	41
Fuel Used.....	22	Lowering protection.....	41
Average fuel consumption.....	23	Fleet Limits (Password is Required).....	42
Stage Information.....	23	Speed Limit.....	43
Remaining Fuel.....	23	Fuel Target.....	44
<b>Menu Climate</b> .....	24	Fleet ID (Password Required).....	45
Climate System/Pause Heating, Passenger.....	24	Day Running Lights.....	45
Temperature/Roof Fan, Passenger.....	24	<b>Menu Diagnosis</b> .....	46
Roof Heat/Floor Fan, Passenger.....	25	Fault Diagnostics.....	46
Extra Heat, Passenger.....	25	Instrument Cluster Self Test.....	48
Floor Fan, Driver.....	25	Part Number.....	50
<b>Menu Time/Distance</b> .....	26	Status test.....	50
Clock and Date.....	26	Calibration number.....	50
		<b>Menu Vehicle Data</b> .....	51
		Oil Level.....	51
		Coolant Level.....	51

---

Lining Wear Prediction.....	51	Trip Data .....	53
<b>Menu Data Log</b> .....	52	Reset Trip Data (Password Required)...	53
Vehicle ID.....	52	<b>Menu Password</b> .....	54
Total Data .....	52	Enter Password.....	54

---

# Safety Information

**IMPORTANT:** Before driving this vehicle, be certain that you have read and that you fully understand each and every step of the driving and handling information in this manual. Be certain that you fully understand and follow all safety warnings.

IT IS IMPORTANT THAT THE FOLLOWING INFORMATION BE READ, UNDERSTOOD AND ALWAYS FOLLOWED.

The following types of advisories are used throughout this manual.



## DANGER

Danger indicates an unsafe practice that could result in serious personal injury or death. A danger advisory banner is in **white** type on a **black** background with a **black** border.



## WARNING

Warning indicates an unsafe practice that could result in personal injury. A warning advisory banner is in **black** type on a **gray** background with a **black** border.



## CAUTION

Caution indicates an unsafe practice that could result in damage to the product. A caution advisory is in **black** type on a **white** background with a **black** border.

**Note:** Note indicates a procedure, practice, or condition that must be followed in order for the vehicle or component to function in the manner intended.

---

## Display and Stalk Switch Control Lever

The Driver Information Display (DID) is located in the middle of the instrument cluster. The display shows vehicle messages and information about the bus, and from it you can control some of the bus functions.



W3079694

The display is controlled via the stalk switch control lever to the right of the steering wheel. The control lever has four buttons:

- 1 **ESC**: Abort or return to previous menu.
- 2 **SELECT**: Select or confirm marked choice.
- 3 **▲**: To Scroll the cursor up or set a symbol.
- 4 **▼**: Scroll the cursor down or set a symbol.

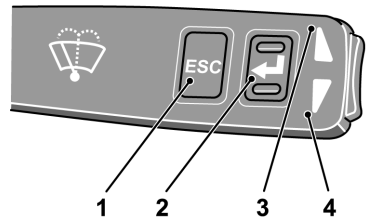

T0014701

## 2 General

---

### Getting Started

#### Display Fields

The display is divided into three fields:

1 **Menu and message field (Upper section)**

Menus, stop, warning and information messages are shown.

2 **Favorite display (Middle section)**

Information is shown, which the driver has selected in the left area, using the “Favorite Display” menu. For buses with automatic transmissions, the selected gear is shown.

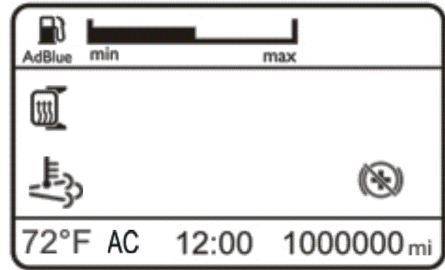

W0098134

**Note:** Some variants do not have an adaptable Favorite Display.

3 **Status line (Lower section)**

To the left, current status symbols are shown. At the center the clock is shown, to the right; the odometer is shown.

## Navigating in the DID, (Display at start)

The DID lights up when the starter key is turned. If there are any vehicles messages, they will be shown in the top field. The most important message is shown first. The message order number is shown in the top right corner. For example, 2/13 indicates that the message now being displayed is the second of thirteen active messages. For more information on messages see “General Information on Vehicle Messages”, page 4 .

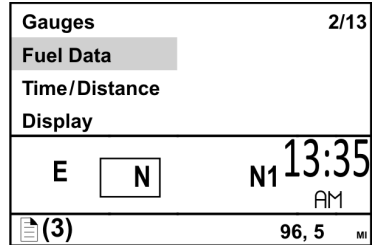

W3079748

Scroll between the various vehicle messages using the ▲ and ▼ button. Take suitable actions and then acknowledge them with **ESC**.

When the vehicle messages have been acknowledge the menus are shown. To navigate between the menus:

- 1 ▲/▼ Scroll the cursor between the menus, which are then marked. The hierarchical order for menus is shown in the top right corner (for example 2/13).
- 2 Pressing **SELECT** confirms the choice.
- 3 Pressing **ESC** exits the chosen menu. Repeated pressing on **ESC** moves the cursor back to the main menus.

For more information on menus, see “General Information on Vehicle Messages”, page 4 .

## 4 Vehicle Messages and Symbols

---

### General Information on Vehicle Messages

There are three lamps above the display:

- Lamp for stop messages
- Lamp for warning messages
- Lamp for stop at the next bus stop.

When there is a fault in the bus or an incident occurs which requires attention, one of these three lamps is lit. Associated messages and symbols are shown in the Driver Information Display (DID) at the same time. Several messages may be active at the same time. The message with the highest priority is shown first in the display.

Previously shown messages can be retrieved in the DID; For more information see “Vehicle Messages”, page 36.

For more detailed technical information about vehicle messages, see “Fault Diagnostics”, page 46.

**Note:** For explanation of the symbols used in vehicle messages, see the driver's handbook.



T3014364

Stop lamp.



T3014365

Check lamp.

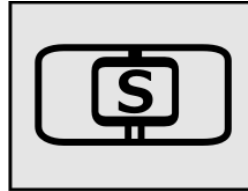

W3079585

Stop at the next bus stop lamp.



## Stop Messages

When the Stop telltale lights, the vehicle must be stopped immediately and the engine switched off.

A buzzer sounds at the same time as a stop message is displayed. The buzzer and stop message can be acknowledged with **ESC**, but is repeated after 10 seconds. The symbol is lit continuously.



T3014364

 <b>WARNING</b>
If the Stop telltale lights while driving, stop the bus immediately and turn off the engine. Continuing to drive may severely endanger the vehicle, the driver and/or passengers.

## Warning Messages

If this lamp lights, the vehicle must be taken to a workshop for repair as soon as possible. There is no immediate danger of the vehicle breaking down, and under normal circumstances it should be possible to complete the journey. This lamp is also used to draw the driver's attention to problems other than vehicle failures, e.g. as a warning in the case of an open luggage compartment hatch.

Acknowledge the message with **ESC**. If the fault is still active, it will be shown again next time the starter key is turned to the starting position.



T3014365

## 6 Vehicle Messages and Symbols

---

### Stop at the Next Bus Stop Messages

Simultaneously with this lamp lighting up, a new message is shown on the display. The fact that this lamp lights up does not mean that there is something wrong with the vehicle. This lamp may for example illuminate to draw the driver's attention to low fuel level.

Acknowledge the message with **ESC** key. If the information message is still activate, it will be shown again next time the starter key is turned to the starting position.

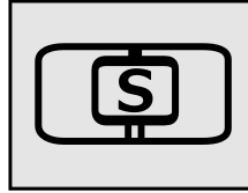















W3079585

## Symbols and messages in the driver display



















Symbols and messages are displayed in combination with stop or warning lamps coming on. Certain messages can have either a yellow or red lamp depending on level, pressure, temperature, etc. Several messages may be active at one time. The message with the highest priority is displayed first. Step through the messages with  $\triangle$  and  $\nabla$  on the display stalk.

Some messages are displayed without a symbol.





















The symbols and their meaning are presented below:

Symbol	Meaning	Symbol	Meaning
	<ul style="list-style-type: none"> <li>• high temperature, coolant, engine.</li> <li>• high temperature, coolant, retarder.</li> </ul>		Sensor error, check level manually.
	Low level, hydraulic fluid for cooling fan.		<ul style="list-style-type: none"> <li>• low level, hydraulic fluid.</li> <li>• low level, hydraulic fluid for power steering.</li> </ul>
	High oil pressure, engine.		Low oil level, engine See also “Oil Level”, page 51 (Vehicle data menu).
	High temperature, engine oil See also “Temperature Engine Oil”, page 18 (Meter menu).		Temperature too high, engine oil.
	Fault in engine pre-heating.		Engine fault.
	Clogged air filter (first check that the net in the air inlet is not blocked).		Clogged fuel filter.
	Too cold for engine brake (VEB).		Fire alarm.





















## 8 Vehicle Messages and Symbols

	Idling engine turned off.		Turbo pressure, no data.
	Water in fuel (drain at next stop).		Low fuel level See also “Remaining Fuel”, page 23 (Fuel data menu).
	Fault in fuel level sensor.		<ul style="list-style-type: none"> <li>low level, AdBlue tank Engine torque is reduced if AdBlue not topped up See also “AdBlue tank, level”, page 21 (Meter menu).</li> <li>empty AdBlue tank Speed limited if AdBlue not topped up.</li> <li>level in AdBlue tank, no data.</li> </ul>
	<ul style="list-style-type: none"> <li>bad AdBlue quality Engine torque reduced and speed limited.</li> <li>incorrect AdBlue consumption Engine torque reduced.</li> </ul>		Depress the brake pedal to check oil pressure, hydraulic turntable (articulated bus only).
	Low air pressure to gearbox.		Low level, transmission fluid.
	Low oil pressure, gearbox.		High temperature, transmission fluid See also “Temperature oil, gearbox/retarder”, page 19 (Meter menu).
	Temperature too high, transmission fluid.		Gear selector not in neutral (engine will not start).
	High temperature, clutch.		High oil temperature, hydraulic retarder See also “Temperature oil, gearbox/retarder”, page 19 (Meter menu).
	High temperature, brakes.		Brake linings, wear warning.

# Vehicle Messages and Symbols 9









	<ul style="list-style-type: none"> <li>• poor braking.</li> <li>• fault in braking system.</li> <li>• data link for EBS broken.</li> </ul>		<p>No data from 1st brake circuit.</p>
	<p>No data from 2nd brake circuit.</p>		<ul style="list-style-type: none"> <li>• low pressure on 3rd brake circuit.</li> <li>• no data from 3rd brake circuit</li> </ul> <p>See also “Brake Pressure, 3rd Circuit”, page 21 (Meter menu).</p>
	<ul style="list-style-type: none"> <li>• low parking brake pressure.</li> <li>• no data from parking brake.</li> </ul>		<p>Auxiliary brake disengaged.</p>
	<p>Fault in compressor.</p>		<p>Fault in compressor/air drier.</p>
	<p>Low pressure in air suspension system.</p>		<ul style="list-style-type: none"> <li>• level control active (raising/lowering).</li> <li>• low wet tank pressure (value given in bar).</li> </ul> <p>See also “Pressure, Primary Tank”, page 20 (Meter menu).</p>
	<p>Fault in air suspension system.</p>		<p>Pinch guard active. See also “Lowering protection”, page 41 (Vehicle settings menu).</p>
	<p>Bus fully lowered.</p>		<p>Vehicle kneeling.</p>
	<p>TCS (Traction Control System) enabled.</p>		<p>“TCS” temporarily disengaged. See also “Traction Control”, page 41 (Vehicle settings menu).</p>
	<p>“ESP” (Electronic Stability Program) enabled.</p>		<p>“ESP” disabled.</p>
	<p>“ESP” requires calibrating.</p>		<p>Accelerator pedal disengaged.</p>

## 10 Vehicle Messages and Symbols

	Luggage hatch open.		Door open.
	Faulty door.		Engine cover open.
	Faulty headlamp.		Faulty brake light.
	Faulty direction indicator.		Overheating, instrument.
	Battery voltage too high. See also “Voltmeter”, page 20 (Meter menu).		Low level, washer fluid.
	Hill start assist enabled.		Air conditioning not working.
	One or more lamps not lighting up.	<b>R</b>	Reverse gear selected.
	Graph sheet compartment open or sheet for driver 1 missing. (analogue tachograph).		Speeding.
	<ul style="list-style-type: none"> <li>• high ash level.</li> <li>• regeneration required.</li> </ul>	<b>S</b>	Stop at next bus stop.
	Toilet fluid level.		Freezing conditions — Outdoor.
	Supply voltage below 24 V.		Auxiliary pressure no data.

## Status Symbols

Status symbols are shown in the lowest row of the display.

Symbol	Meaning	Symbol	Meaning
	Pre-Heat active.		Regeneration active.
	Alarm clock activated.		Regeneration inactive.
	Message active.		Auxiliary brake position 0.
<b>MI</b>	Odometer, miles.		AdBlue level.
<b>KM</b>	Odometer, kilometers.		Low fuel level.
<b>CC</b>	Cruise control active.	<b>WC</b>	WC, engaged.
<b>(A)</b>	Auxiliary brake position A.	<b>AC</b>	Climate control active.
<b>(1)</b>	Auxiliary brake position 1.	<b>(B)</b>	Auxiliary brake position B.
<b>(2)</b>	Auxiliary brake position 2.		Auxiliary brake in operation.
<b>(3)</b>	Auxiliary brake position 3.		

## 12 Use the Display Menus

---

### General Information on Menus

Using the menus you can see the status and control some of the bus functions. For reasons of safety, not all menus are available when driving. To see certain menus and to adjust certain settings, the bus must be stationary. A password is required for some menus.

### Scroll Between the Menus

- 1 Scroll the cursor between menus using ▲ and ▼. The order number of the marked menu is shown in the top right corner. 2/13 indicates that there are 13 menus and that the current menu is number 2.
- 2 Go from a menu to a sub-menu using **SELECT**
- 3 Exit a sub-menu using **ESC**

Gauges		2/13
Fuel Data		
Time/Distance		
Display		
E	<input type="checkbox"/> N	N1 13:35
		AM
(3)		96, 5 MI

W3079748



## Changing Settings

- 1 Use ▲/▼ to change set values (for example, number of hours).
- 2 Pressing **SELECT** confirms the choice.
- 3 Use **ESC** to Scroll the cursor to the previous digit or abort the setting process.

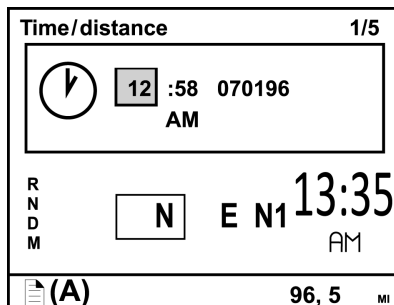

T0031652

### Example: Change a Setting

The Favorite Display is shown. To set the alarm clock to go off at 02:33. Proceed as follows:

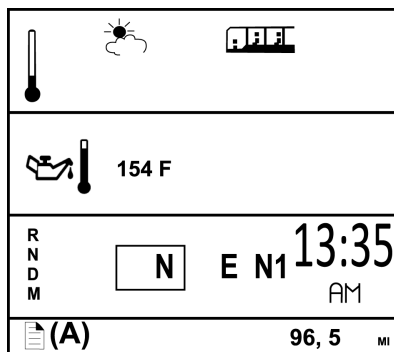

T0031653

## 1

Go to the menus using **SELECT** Place the cursor on Time/Distance using ▲ and ▼.

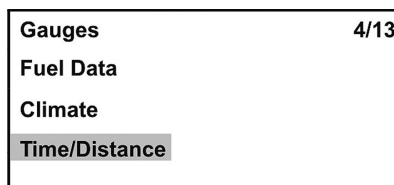

T0031654

# 14 Use the Display Menus

---

2

Press **SELECT** The current time and date are shown.

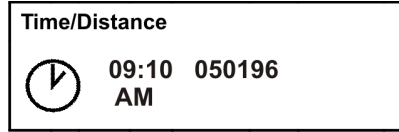

T8056484

3

Scroll to the alarm clock using **▲** and **▼**.

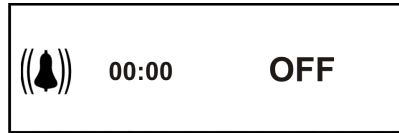

4

Press **SELECT** Scroll down to **SET** using **▲** and **▼**.

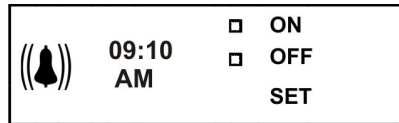

T8056483

5

Press **SELECT** The hours are marked. Scroll to the required hour using **▲** and **▼**.

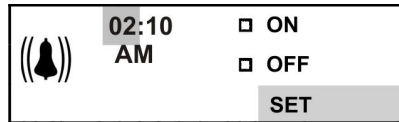

T8056482

6

Press **SELECT** The first digit for minutes is marked. Scroll to the required digit using **▲** and **▼**.

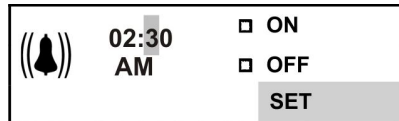

T8056481

## 7

Press **SELECT** The second digit for minutes is marked. Scroll to the required digit using ▲ and ▼.



T0031660

## 8

Press **SELECT** "ON" is marked.

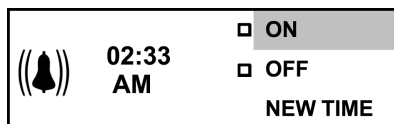

T0031661

## 9

Press **SELECT** A cross is placed in the box in front of "ON." The symbol for activated alarm clock is shown in the status bar. The alarm clock setting is then automatically displayed.

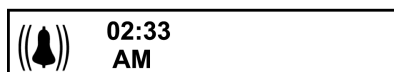
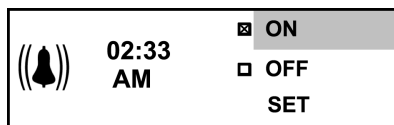

T0031662

## 10

Return to Favorite Display using ESC. The symbol for activated alarm clock is shown in the status bar.

To deactivate the alarm clock:

- Go into menu "Time/Distance" using **SELECT**
- Scroll to the alarm clock using ▲ and ▼.
- Press **SELECT**.
- Scroll to "OFF" with ▲ and ▼.
- Press **SELECT**.

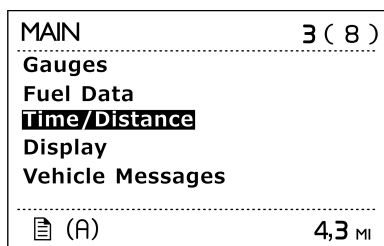

W3079745

# 16 Menu Overview

---

## Main Menus and Sub-menus

The overview shows how the menus are structured.

- **Gauges**

Gear engaged

Temperature outside/inside

Temperature, engine oil

Voltmeter

Pressure, primary tank

Oil Pressure

Brake pressure, 3rd circuit

- **Fuel Data**

Average fuel consumption

Stage information

Remaining fuel

- **Climate**

Climate/Pause heating, passenger

Temperature/Roof Fan, passenger

Roof Heat/Floor Fan, passenger

Extra Heat, passenger

Floor Fan, driver

**Note:** Not all buses have all the menus that are shown in the overview.

- **Time/Distance**

Clock and Date

Alarm clock

Trip meter

Average speed

Estimated time of arrival

- **Display**

Black Panel

Backlight

Favorite Display, setting

Night/Day

- **Vehicle Messages**

- **DisplaySettings**

Favorite display set

Language

Clock/Date

Units

Time/Date

Display light

Change password

- **Aftertreatment System (ATS)**

Enable / Disable ATS

Regeneration request

System conditions

Soot/Ash level

- **Vehicle Settings**

Traction Control

Fleet limits

Fleet ID

Day Running Light

- **Diagnosis**

Fault diagnosis

Cluster self test

Part number

- **Vehicle Data**

Oil level

Lining wear prediction

- **Data Log**

Vehicle ID

Total data

Trip Data

Reset trip data

- **Password**

Enter password

# 18 Menu Gauge

## Gear Engaged

(This gauge is extra equipment. Only buses equipped with an I-shift transmission.)  
Information about the engaged gear, gear lever position, available gears and such like.  
For further information, see separate driver instructions for "I-shift".

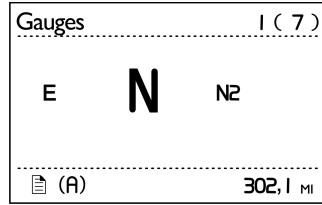

W3079551

## Temperature Outside/Inside

(This gauge is extra equipment).  
Outside temperature shown above. Bus inside temperature shown at the bottom.

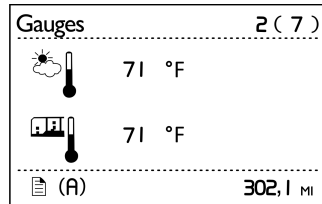

W3079552

## Temperature Engine Oil

Temperature of the engine oil.  
Warning for high engine oil temperature.

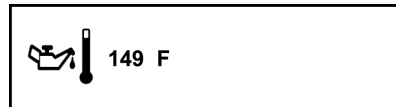

T0031666

Engine oil temperature.

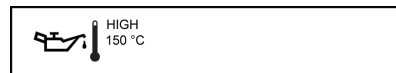

T0088897

High engine oil temperature.

## Temperature oil, gearbox/retarder

(The gauge is extra equipment.)

For gearboxes with I-shift, the gearbox temperature is shown. For gearboxes manufactured by ZF or Voith the retarder temperature is shown.

**Note:** Temperatures below 45° C are not shown.

- Temperature of transmission fluid.
- Warning for high transmission fluid temperature.
- Temperature of retarder oil.
- Warning for high retarder oil temperature.



Temperature transmission fluid.



High transmission oil temperature.



Retarder oil temperature.

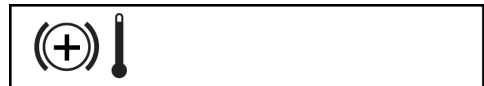

High retarder oil temperature.

# 20 Menu Gauge

## Voltmeter

Battery voltage.

If the engine is running and the voltage drops below 20 V or over 31 V, a fault messages are displayed together with the information/warning symbol.



T0031667

Battery tension in volts.

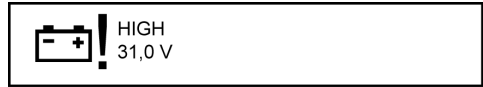

Warning battery voltage too high.

## Pressure, Primary Tank

If the pressure in the primary tank drops **below 100 PSI (7 bar)**, a fault message is displayed together with the information/warning symbol.

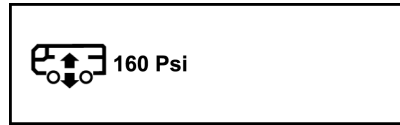

T0031668

## Engine Oil Pressure

If the pressure drops **below 25 PSI (1.7 bar)** a fault message is displayed together with the stop symbol and red light.

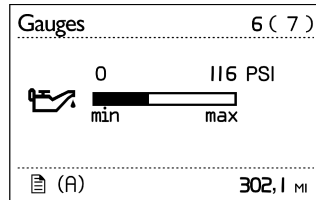

W3079554



## AdBlue tank, level

Shows the amount of AdBlue in the tank.

The “Low level, AdBlue tank” symbol and a message are shown on the display when only 20% of the AdBlue solution is remaining.

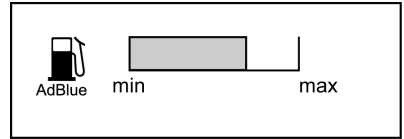

## Brake Pressure, 3rd Circuit

(only on buses with min. three axles).

If the pressure drops **below 80 PSI (5.5 bar)** a fault message is displayed together with the stop symbol and red light.

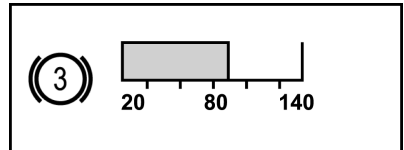

## 22 Menu Fuel Data

---

### Fuel Used

For setting the units, see “Units”, page 37.

1 **Average fuel consumption:**

The value is presented as a figure and an arrow pointing down. For a time after resetting the display “- — —” is shown while average fuel consumption is being calculated.

2 **Instantaneous fuel consumption:**

The value is presented numerically.

3 **Target fuel consumption:**

The value is presented with the symbol  $\wedge$  below the bar. For information on setting this value, see “Fuel Target”, page 44.

**Note:** At idle, no bar is shown and the fuel consumption is displayed in gallons/hr (alternatively liter/hr).

### Resetting, fuel consumption

Press **SELECT**. To reset all fuel data, press **SELECT** for 1 second. Leg data is also reset.

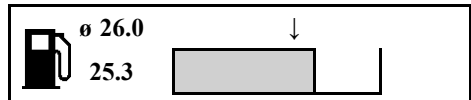

## Average fuel consumption

The average fuel consumption in gallons/hr (alternatively liter/hr)

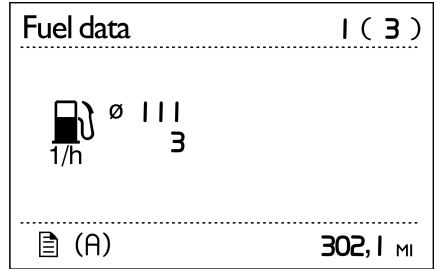

W3079553

## Stage Information

The amount of fuel consumed since the last reset.



W3079993

## Resetting, leg data

Press **SELECT** To reset leg data, hold **SELECT** depressed for 1 second.

## Remaining Fuel

- The first value shows the distance that can be driven before the tank is empty with current fuel consumption.
- The second value shows the amount of fuel currently in the tank.

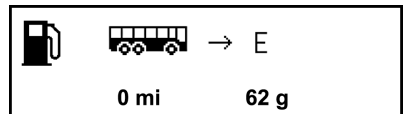

T0031671

## 24 Menu Climate

---

### Climate System/Pause Heating, Passenger

Shows whether the passenger climate system or pause heating is switched on or off.

Press **SELECT** once to come to "Climate system". Press **SELECT** twice to come to "Pause heating". Activate/deactivate the respective unit using the control lever buttons (**SELECT**, **ESC**, **▲** and **▼**).

**Passenger:**

<b>Climate system</b>	<b>ON</b>
<b>Pause heating</b>	<b>OFF</b>

T0031672

### Temperature/Roof Fan, Passenger

Shows the required temperature level or roof fan speed in the passenger compartment.

Press **SELECT** once to come to "Temperature". Press **SELECT** twice to come to "Roof Fan". Set the required temperature (between 59 and 82° F [15 and 28° C]) using the control lever buttons (**SELECT**, **ESC**, **▲** and **▼**). Set the required roof fan speed (manually between -5 and +5, alt. automatic) using the control lever buttons (**SELECT**, **ESC**, **▲** and **▼**).

**Passenger:**

<b>Temperature</b>	<b>62 F</b>
<b>Roof Fan</b>	<b>+1</b>

T0031673

## Roof Heat/Floor Fan, Passenger

Shows the selected level for roof heat or status for floor fan in the passenger compartment. Press **SELECT** once to come to "Roof Heat". Press **SELECT** twice to come to "Floor Fan". Set the required level for Roof Heat (manually between -5 and +5, alt. automatic) using the control lever buttons (**SELECT**, **ESC**, **▲** and **▼**). Activate/deactivate the floor fan (switched off, alt. automatic) using the control lever buttons (**SELECT**, **ESC**, **▲** and **▼**).

<b>Passenger:</b>	
<b>Roof Heat</b>	<b>AUTO</b>
<b>Floor Fan</b>	<b>N/A</b>

T0031684

## Extra Heat, Passenger

Shows whether the extra heating in the passenger compartment is switched on or off. Activate/deactivate the extra heat using the control lever buttons (**SELECT**, **ESC**, **▲** and **▼**).

<b>Passenger:</b>	
<b>Extra Heating</b>	<b>N/A</b>

T0031685

## Floor Fan, Driver

Shows whether the floor fan in the driver compartment is in automatic position or switched off.

Activate/deactivate the floor fan using the control lever buttons (**SELECT**, **ESC**, **▲** and **▼**).

<b>Driver:</b>	
<b>Floor Fan</b>	<b>N/A</b>

T0031686

## 26 Menu Time/Distance

---

### Clock and Date

Shows current time and date. For setting the formats, 12 hr alt. 24 hr and date, see “Time/Date”, page 38.

### Setting, time and date

Press **SELECT**. Set the time and date using the control lever buttons (**SELECT**, **ESC**, **▲** and **▼**). If the starter key is in stop position and it takes more than 30 seconds between button depressions, the setting process is aborted.

**Note:** The menu "Time and date" is available even when the starter key is in the stop position. The menu is activated by pressing any of the buttons on the control unit for at least 1 second. The menu remains active for 30 seconds after the last depression.

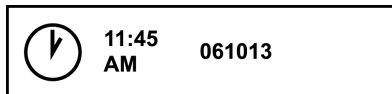

T0031687

## Alarm Clock

### Alarm clock, setting

Press "SELECT". Set the alarm time using the control lever buttons (SELECT, ESC, ▲ and ▼). Finish off by selecting "ON". The symbol for the alarm is shown on the status bar to indicate that the alarm clock is active.

**Note:** The alarm clock cannot be set while driving. If the starter key is in stop position and it takes more than 30 seconds between button depressions, the setting process is aborted. The menu "Alarm clock" is available even when the starter key is in stop position. The menu is activated by pressing any of the buttons on the control unit for at least 1 second.

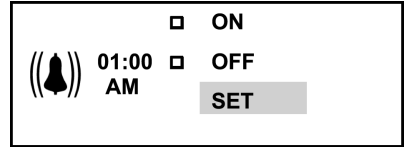

T0031688

### Activate alarm clock

Here the alarm clock can be activated without changing the alarm time. Activate the alarm using the control lever buttons (SELECT, ESC, ▲ and ▼). When the clock has been activated, the symbol for activated alarm clock is shown on the display status bar.

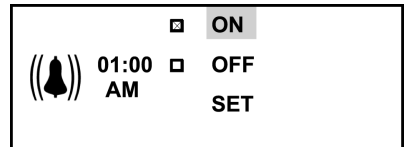

T0031689

### Switch Off the alarm clock

When the alarm clock goes off, the word "ALARM" lights up, the current time is displayed and a warning signal is sounded. The alarm shuts off after 60 seconds or if ESC is depressed.

## 28 Menu Time/Distance

---

### Trip Meter

Two independent distances can be saved, for leg 1 and leg 2.

**Note:** The trip values must be reset before each measurement.

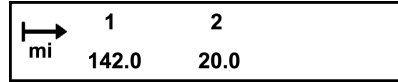

T0031690

### Reset Trip Meter

Press "SELECT". Reset the trip meters 1 and 2 respectively using the control lever buttons (SELECT, ESC, ▲ and ▼).

### Average Speed

The average speed is calculated as the distance driven divided by the time the engine has been running (since latest reset). Two different average speeds can be measured, average speed 1 and 2.

**Note:** The values must be reset before each measurement.

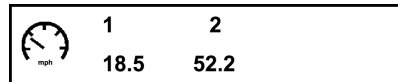

T0031691

### Reset Average Speed

Press "SELECT". Reset average speeds 1 and 2 respectively using the control lever buttons (SELECT, ESC, ▲ and ▼).



## Estimated Time of Arrival

The estimated time of arrival is calculated as the remaining distance divided by the vehicle's average speed.

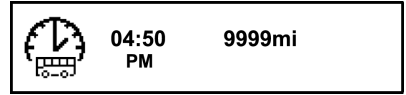

T0031692

## Set Distance

Press "SELECT". Set the remaining distance in Km (alt. miles) using the control lever buttons (SELECT, ESC, ▲ and ▼).

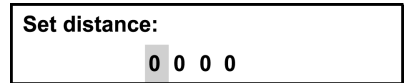

T0031693

## Driving and rest time

Information about driving and resting times is obtained from the digital tachograph.

The symbol is at the **far left** and the information under it varies depending on the selected activity in the digital tachograph.

The symbol in the **centre** indicates pause and rest time.

The symbol to the **right** indicates driving time.

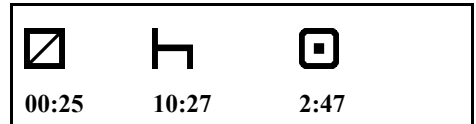

## 30 Regeneration menu

### Regeneration

An automatic regeneration is carried out on particles collected in the Diesel Particle Filter (DPF). This prevents large amounts of soot collecting in the filter. A clogged filter can mean the permitted NOx emissions will not be met.

Parameters for enabling regeneration are level of soot in the particle filter and the amount of fuel consumed.

There are two categories of regeneration. Moving regeneration that is carried out while driving.

Parked regeneration that is enable manually while the vehicle is stationary.

A status symbol, high exhaust temperature, is displayed while regeneration is in progress. The symbol disappears when the process is complete.

**Note:** There are no warning or indicator lamps when moving regeneration is enabled.

For more information, see driver instruction “Aftertreatment, SCR.”.

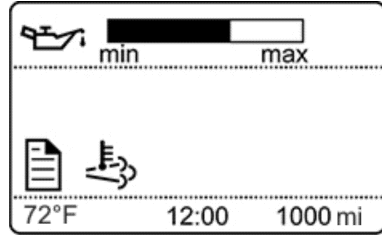

Driver's display.

## Aftertreatment (ATS)

For additional information about the aftertreatment system (ATS), refer to Exhaust Aftertreatment System manual.

The aftertreatment menu allows the operator to request a parked regeneration, check the status of the aftertreatment system, and cancel a regeneration.

ATS	I ( 4 )
<b>ATS Enable/Disable</b>	
Request regeneration	
System conditions	
Soot/Ash level	
-----	
(A)	4,3 MI

W3079746

## Aftertreatment (ATS) Enable/Disable

To temporarily disable automatic regeneration, scroll to the Aftertreatment menu, select "ATS Enable/Disable". When automatic regeneration is disabled, the letters ATS with X through them will be displayed in the DID. Enable regeneration by scrolling to the Aftertreatment menu, selecting "ATS Enable/Disable" and selecting "Enable REGEN".

ATS Enable/Disable	I ( 2 )
-----	
<input checked="" type="checkbox"/> <b>Enable regeneration</b>	
<input type="checkbox"/> <b>Disable regeneration</b>	
-----	
(A)	4,3 MI

W3079740

## 32 Regeneration menu

### System Conditions

The system conditions menus are used to help determine why a parked regeneration failed.

<b>System conditions</b>		<b>1 ( 4 )</b>
-----		
<b>Clutch Status</b>	<b>NA</b>	▲
<b>Engine Status</b>	<b>Check</b>	
<b>PTO Status</b>	<b>OK</b>	▼
-----		
 (A)		<b>4,3 MI</b>

W3079741

<b>System conditions</b>		<b>2 ( 4 )</b>
-----		
<b>Acc. Pedal</b>	<b>OK</b>	▲
<b>Gear Status</b>	<b>OK</b>	
<b>Vehicle Speed</b>	<b>OK</b>	▼
-----		
 (A)		<b>4,3 MI</b>

W3079742

<b>System conditions</b>		<b>3 ( 4 )</b>
-----		
<b>Park Brake</b>	<b>OK</b>	▲
<b>System Fault</b>	<b>OK</b>	
<b>Perm System Lockout</b>	<b>OK</b>	▼
-----		
 (A)		<b>4,3 MI</b>

W3079743

<b>System conditions</b>		<b>4 ( 4 )</b>
-----		
<b>Temp System Lockout</b>	<b>Check</b>	▲
<b>Inhibit Switch</b>	<b>OK</b>	
-----		
 (A)		<b>4,3 MI</b>

W3079744

## Black Panel

When "Black panel" is activated, only the speedometer, tachometer (except the colored field) and the lowest line of the display light up. The following events light the backlighting:

- a message is activated
- a button is depressed
- the engine speed enters the red field on
- the tachometer

## Favorite Display

This function is used to activate " Favorite Display".

## Backlight

This menu can be used to alter the display lighting with respect to the lighting of the other instruments.

## Set Backlight

- 1 Increase or decrease the backlight in the display using ▲/▼.
- 2 Confirm with **SELECT**.
- 3 **ESC** aborts the setting process.













W3079738

## 34 Menu Display

### Favorite Display, Set

Select the gauges and functions to show in "Favorite Display".

No display	
Gear engaged	
Outside temperature	
Temperature, engine oil	
Fuel used	
Stage information	
Remaining fuel	
Trip meter	
Pressure, primary tank	
Pressure, 3rd brake circuit	
Average speed	
Estimated time of arrival	

## Select Favorite Display

### To Select Favorite Display:

- 1 Press **SELECT**.
- 2 Press **SELECT** once more and the upper field becomes active. Select gauge or function using **▲** and **▼**. Confirm with **SELECT** when the desired gauge or function is shown.
- 3 Press **SELECT** once more to activate the next field. Select gauge or function using **▲** and **▼**. Confirm with **SELECT** when the desired gauge or function is shown.
- 4 Press **SELECT** or **ESC** until all the fields are active and the clock is shown.

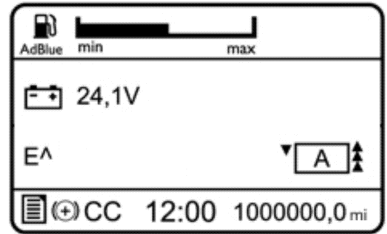

## Night/Day

This function is used to switch between white text on a black background and black text on a white background.

Press **Select** to switch between alternatives.

## 36 Menu Vehicle Messages

---

### Vehicle Messages

If a message appears on the display, confirm to be aware by pushing ESC key, then a symbol will appear on the status bar. Enter to this menu to view the messages confirmed and not corrected.

Switch between messages using ▲ and ▼.

Press **ESC** to return to the main menu.

If a confirmed message is still active it will appear as unconfirmed message the next time the starter key will set in ON position. The message symbol will stay as long as there are unconfirmed messages.



## Language

Select the desired language using the control lever buttons (SELECT, ESC, ▲ and ▼).

## Units

### Distance

Select to show distances in miles or kilometers using the control lever buttons (SELECT, ESC, ▲ and ▼).

### Fuel Consumption

Select, using the control lever buttons (SELECT, ESC, ▲ and ▼), to show fuel consumption in:

- L/100 Km
- Km/L
- mpg (IMP gallons)
- mpg (US gallons)

### Temperature

Select, using the control lever buttons (SELECT, ESC, ▲ and ▼), to show temperatures in Fahrenheit (F) or Celsius (C).

## 38 Menu Vehicle Messages

---

### Time/Date

#### Time

Set the time format (AM/PM or 24:00) using the control lever buttons (SELECT, ESC, ▲ and ▼).

#### Date Display

Select, using the control lever buttons (SELECT, ESC, ▲ and ▼), from the various date formats.

- year, month, day (**yymmdd**)
- day, month, year (**ddmmyy**)
- month, day, year (**mmddyy**)

## Display light

### Contrast

Set the contrast using the control lever buttons (SELECT, ESC, ▲ and ▼).

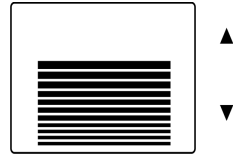

W3079738

### Backlight

In this menu the display lighting can be altered in relation to the other instrument lighting, using the control lever buttons (SELECT, ESC, ▲ and ▼).



W3079738

### Standard / Inverted; (Night Mode)

This function is used to switch between white text with black background and black text with white background, using the control lever buttons (SELECT, ESC, ▲ and ▼).

## 40 Menu Vehicle Messages

---

### Change Password (If Password is Required)

First enter the current password, see “Enter Password”, page 54.

- 1 Mark the password to be changed using ▲ and ▼.
- 2 Confirm with **SELECT**.
- 3 Enter the first digit using ▲ and ▼.
- 4 Scroll to the next digit using **SELECT**.
- 5 Scroll back in the menu using **ESC**.

## Traction Control

**Note:** Normally, traction control should be on. The disengagement function must only be used by workshop personnel or vehicle testing centres.



T0014612

Select On or Off using the control lever buttons (SELECT, ESC, ▲ and ▼).

When traction control is disengaged, the symbol for disengaged TCS (Traction Control System) is shown in the driver's display.

## Lowering protection

(Only for certain variants)

The the lowering protection is active (symbol for the lowering protection is shown in the display) kneeling is not possible. Should there be special circumstances where kneeling is required, the lowering protection can be inactivated in this menu. Activate/inactivate the lowering protection with the display control buttons.



T0014566

## 42 Menu Vehicle Settings

---

### Fleet Limits (Password is Required)

#### Revolutions Per Minute (RPM) Limit

Only accessible if correct password is entered.

This function makes it possible for the carrier to set an engine speed limit for the fleet. If the engine exceeds this limit, it will be registered, see "Trip data" page 46.

Select **RPM Limit (max)** and set the new engine speed limit in rpm using the control lever buttons (SELECT, ESC, ▲ and ▼).

If the setting fails:

- Press **ESC** and try to do the setting once again.
- If it still fails, perform a diagnosis of the display and engine control unit, see "Fault Diagnostics", page 46.
- Contact a authorized VOLVO workshop if necessary or Prevost service center/provider.

## Speed Limit

Only accessible if correct password is entered.

This function makes it possible to set a road speed limit for the fleet. If the bus exceeds this speed it is registered, see "Trip data" page 46. Go to "Speed Limit (max)" and set the new speed limit using the control lever buttons (SELECT, ESC, ▲ and ▼).

The message "Transfer complete" is shown

If the setting fails:

- Press **ESC** and try to do the setting once again.
- If it still fails, perform a diagnosis of the display and engine control unit, see "Fault Diagnostics", page 46.
- Contact a authorized VOLVO workshop if necessary or Prevost service center/provider.

## 44 Menu Vehicle Settings

---

### Fuel Target

Only accessible if correct password is entered.

This function makes it possible to set a fuel consumption target for the fleet. For information about fuel consumption for a journey, see "Trip data" page 46.

If the setting fails:

Select "On" or "Off" using the control lever buttons (SELECT, ESC, ▲ and ▼).

- Press **ESC** and try to do the setting once again.
- If this still fails, perform a diagnosis of the display and engine control unit, see "Fault Diagnostics", page 46.
- Contact a authorized VOLVO workshop if necessary or Prevost service center/provider.



## Fleet ID (Password Required)

Only accessible if correct password is entered.

Using this menu the carrier can enter the vehicle ID within the fleet if required. Data registered in the engine control unit is then registered for that ID.

Set the fuel consumption target using the control lever buttons (SELECT, ESC, ▲ and ▼) 13 digits must be entered (a space is entered for unused positions).

If the setting fails:

- Press **ESC** and try to do the setting once again.
- If it still fails, perform a diagnosis of the display and engine control unit, see “Fault Diagnostics”, page 46.
- Contact a authorized VOLVO workshop if necessary or Prevost service center/provider.

## Day Running Lights

Day running lights can be switched off in this menu. This means that if the day running lights have been set to the **OFF** position, the dipped beam must be turned on and off using the lights knob in the panel.

Select **ON** or **OFF** using the control lever buttons (SELECT, ESC, ▲ and ▼).

## 46 Menu Diagnosis

---

### Fault Diagnostics

A list of the bus's control units is shown in the "Fault diagnostics" menu.

Switch between control units using ▲ and ▼. **SELECT** confirms choice of control unit. To abort press **ESC**.

- 1 During the time that the selected control unit is being called up, the display indicates that "Data transfer is taking place".
- 2 If the selected control unit has no faults "No faults" is displayed. Press **ESC** to return to the previous menu.
- 3 If the selected control unit does not reply within 5 seconds the following is shown "Operation failed" in the display.
  - Press **ESC** and try to do the setting one again, see point 1.
  - If it still fails, perform a diagnosis on the display and selected control unit.
  - Contact a authorized VOLVO workshop if necessary or Prevost service center/provider.
- 4 The following is shown if the selected control unit has a fault code:
  - Which control unit it applies to
  - Which parameter or component is faulty
  - Which type of fault it is
  - If the fault is active or inactive
  - How many times the fault has been registered since the last reset

- 5 If there are several fault codes or fault messages for the same control unit, you can scroll through the fault codes using ▲ and ▼. "Reset all" is shown last in the list. This resetting only clears the fault codes for the selected control unit.
- 6 A maximum of 20 fault codes/messages can be shown for a control unit. To see more than the first 20, one or more messages must be deleted.
- 7 Press **SELECT** to show more information on the fault code. Fault codes are shown numerically here. If the fault is inactive, among other things, the time and date when it occurred are shown:
  - **MID:** Module Identification.
  - **PID:** Identification of parameters.
  - **PPID:** Volvo unique Identification of parameters.
  - **SID:** Identification of components.
  - **PSID:** Volvo unique Identification of components.
  - **FMI:** Identification of fault IDs.

## 48 Menu Diagnosis

---

### Instrument Cluster Self Test

#### Telltails Test

- 1 Select "Telltails test".
- 2 The control lamps light for approx. 5 seconds.
- 3 Abort the test using **ESC**.

Gauges test

#### Gauges Test

- 1 Select "Gauge test".
- 2 Gauge function is checked through the entire of the gauge. The pointers move back and forth a couple of times between the end positions. The pointers should not show a particular value; this is only a function check.
- 3 Stop the test using **ESC**.

## Display Test

- 1 Select "Display test".
- 2 The whole display lights up for 3 seconds after which it blacks out for 3 seconds. After this a checkered pattern is displayed for 3 seconds. The checkered pattern is then displayed inverted for 3 seconds.
- 3 Stop the test using **ESC**.

## Speaker Test

- 1 Select "Speaker test".
- 2 The ticking sound of the direction indicators is heard from the instrument panel load speakers.
- 3 Cancel the test using **ESC**.

## 50 Menu Diagnosis

---

### Part Number

A list of the bus control units is shown in the menu "Part number".

- 1 Select a part using ▲ and ▼.
- 2 Confirm with **SELECT**.
- 3 Return using **ESC**.

### Status test

**Note:** This menu is only for use by workshops.

**MENU:** Diagnostics, Status test

Messages on the bus data link are shown in the menu "Status test".

<b>Status test</b>
<b>MID:</b> 128
<b>PID:</b> 091
<b>Data:</b> 000

### Calibration number

Number to identify the version of software equipped to the electronic engine control.

## Oil Level

The bus has an electronic oil level sensor.

The bar marked "min" and "max" shows the engine oil level. The figure in the centre shows how many gallons there are between min. and max. levels.

The engine oil level is also shown when the key is turned to the ignition position. This is shown for 5 seconds or until the engine is started.

In order to show the correct value, the engine must have been turned off for at least 70 minutes. If the engine has not been turned off sufficiently long, the display shows how many minutes remain until a correct value can be shown.

If the oil level is below "min" a warning symbol is shown.

**Note:** There is no warning for low oil level while driving.

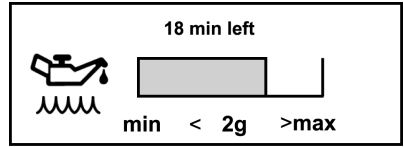

T0031743

## Coolant Level

Shows how much coolant is in the container.

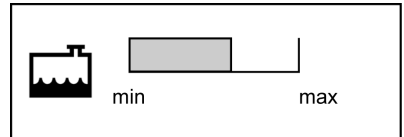

T0088895

## Lining Wear Prediction

See operating instructions Engine Braking System (EBS) for more information about lining wear prediction.

### Vehicle ID

The bus chassis id and the vehicle number that were entered into the menu are displayed. For more information see “Fleet ID (Password Required)”, page 45.

### Total Data

The total values show the engine's total values to date, logged during the lifetime of the engine control unit. The values that are saved are:

- Total distance
- Total fuel used
- Total engine hours.
- Total idle time
- Total engine revolutions

If the transfer should fail, then "No data" is shown when data is missing.



## Trip Data

There are 12 different trip data stored.

- Trip distance
- Trip fuel avg
- Trip fuel acc
- Trip over revolutions
- Trip uneconomy revolutions
- Trip fuel uneconomy revolutions
- Trip average speed
- Trip overspeed:
- Trip engine hours
- Trip idle time
- Trip idle fuel
- Trip cruise

Switch between values using ▲ and ▼.

Return to previous menu using ESC. If the transfer should fail, then "No data" is shown when data is missing.

**Note:** In the menu "Trip data" you can find information saved since the last reset.

## Reset Trip Data (Password Required)

Only accessible if correct password has been entered.

Reset all information in menu "Trip data".  
Follow the instructions on the display.

## 54 Menu Password

---

### Enter Password

Certain functions in the display are protected by a password. There are three passwords for the display. The factory set passwords are:

Workshop Password 1	0000
Owner Password	1234
Workshop Password 2	5678

When "Workshop, password 1" is entered, it is possible to reset values (applies to a number of functions). With both the other passwords the following menus are accessible:

- Fleet limit: engine speed
- Fleet limit: speed
- Fleet limit: fuel
- Fleet ID

When the starter key has been in the stop position for more than 60 seconds or if the battery has been disconnected, the password must be entered again in order to access all functions.

It is not possible to remove the password protection for certain functions. This can only be done at a authorized VOLVO workshop or Prevost service center/provider.

- 1 Set the first digit using **▲** and **▼**
- 2 Scroll to the next digit using **SELECT**
- 3 Scroll back using **ESC**

**Note:** Change password to prevent unauthorized access to menus, see "Change Password (If Password is Required)", page 40.



**VOLVO**

**Volvo Bus Corporation**

Göteborg, Sweden

# Operating Instructions

## I-shift gear selector pad

B13R

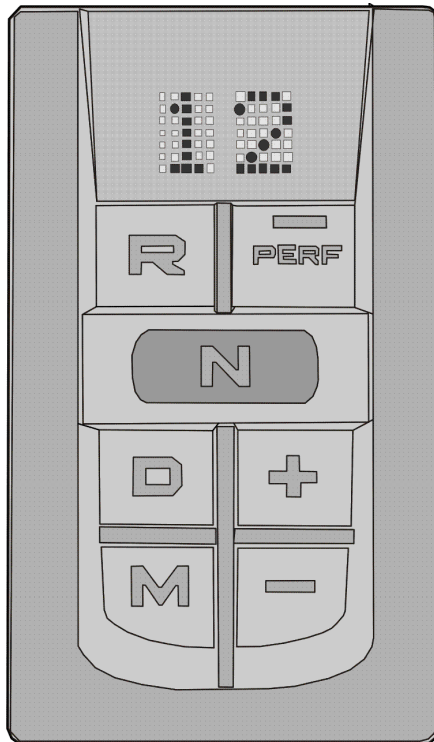

**VOLVO**

# Foreword

The following levels of observations, cautions and warnings are used in this Service Documentation:

**Danger:** Indicates an unsafe practice where serious personal injury or death could occur.

**Warning:** Indicates an unsafe practice where personal injury or severe damage to the product could occur.

**Caution:** Indicates an unsafe practice where damage to the product could occur.

**Note:** Indicates a procedure, practice, or condition that must be followed in order to have the vehicle or component function in the manner intended.

Technical data, construction information, descriptions and illustrations in this driver's handbook, were current when the book was published, and it can have been changed. Volvo company reserve the right to make changes without prior notice.

This manual contains information concerning the operation and function of **I-shift gear selector pad**

This manual contains general information about instruments and controls, as well as driving instructions. In case a bus is not equipped with all functions described in this manual, it is due to the custom adaptation and different levels of equipment.

**Volvo Bus Corporation**

Göteborg, Sweden

**Order number: 89219726**

©2016 Volvo Bus Corporation, Göteborg, Sweden

All rights reserved. No part of this publication may be reproduced, stored in retrieval system, or transmitted in any forms by any means, electronic, mechanical, photocopying, recording or otherwise, without the prior written permission of Volvo Bus Corporation.

---

# Contents

<b>Introduction</b> .....	1
Driver's responsibility .....	1
I-shift, general.....	2
Display .....	2
<b>Instruments and controls</b> .....	5
I-shift gear selector pad .....	5
Buttons .....	6
<b>Starting and stopping</b> .....	9
Starting instructions.....	9
Stopping the vehicle .....	9
<b>Driving</b> .....	10
Program package .....	10
Function description .....	12
Automatic shifting .....	13
Driving program .....	16
Kick-down .....	17
Manual gear changing .....	18
Reverse gears.....	19
In case of gearbox malfunction.....	20
<b>Driving tips</b> .....	21
Fuel economy driving .....	21
I-Roll.....	21
Avoid downshifting .....	21
Avoid up-shifts.....	22
Greatest possible down-change.....	22
Save brakes .....	22
Queue driving .....	23
Hill Start.....	24
Driving on poor roads and in difficult conditions.....	25
Clutch.....	26
Extra down-changing for maximum engine brake in low gears.....	27
Changing driving direction .....	27
<b>If something happens</b> .....	28
<b>Technical Data</b> .....	31
Nomenclature and Ratios .....	31
<b>Index</b> .....	33





---

# Safety information

**IMPORTANT:** Before driving this vehicle, be certain that you have read and that you fully understand each and every step of the driving and handling information in this manual. Be certain that you fully understand and follow all safety warnings.

IT IS IMPORTANT THAT THE FOLLOWING INFORMATION BE READ, UNDERSTOOD AND ALWAYS FOLLOWED.

The following types of advisories are used throughout this manual:



## DANGER

Danger indicates an unsafe practice that could result in serious personal injury or death. A danger advisory banner is in white type on a black background with a black border.



## WARNING

Warning indicates an unsafe practice that could result in personal injury. A warning advisory banner is in black type on a gray background with a black border.



## CAUTION

Caution indicates an unsafe practice that could result in damage to the product. A caution advisory is in black type on a white background with a black border.

**Note:** Note indicates a procedure, practice, or condition that must be followed in order for the vehicle or component to function in the manner intended.

---

## Driver's responsibility

- As the driver, you are responsible for the safety and comfort of the passengers during the journey. Therefore, do not drive the bus before you have read this driver's manual. You must be familiar with all the indicators and warning lights and know what to do if something unexpected happens.
- Follow the recommended service and maintenance program to maintain the bus's condition and safety.
- As the driver of the vehicle, you should be aware of the vehicle weight and loading capacity. See instructions on warning stickers, the vehicle registration book and on the identification plate.
- As the driver of the vehicle, it is your responsibility to foresee any hazards that could threaten your passengers.
- It is also your responsibility to ensure that all the safety equipment of the bus is in place. Therefore check regularly the working order of safety belts, emergency door and window opening, door sensitive edges, fire extinguishers and first aid equipment.

## 2 Introduction

### I-shift, general

The I-Shift is an automated **mechanical** transmission with 12 forward gears and 4 reverse gears. There is no clutch pedal and the gear shifting is controlled by the transmission or the driver through the ergonomic gear selector so that the driver can concentrate on traffic. If necessary, the driver can choose to shift manually.

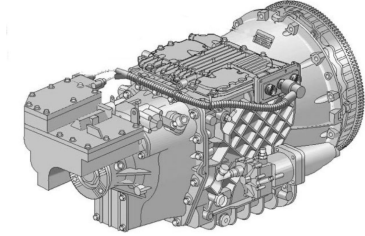

I-shift is delivered with two different software packages. As some functions are optional, not everything in this document is applicable to your gearbox.

### Display

Select the INDICATORS menu on the display to show information about I-shift (valid both when the vehicle is stopped and when the vehicle is in motion). Information about the transmission will be presented on the driver display.

See the “Driver's instructions, Display ” for information about how to configure the transmission information as a standard display.

The gearbox section is divided into smaller sections showing:

- 1 Driving program
- 2 Selected gear
- 3 Available gears (down/up)
- 4 Gear selector option.

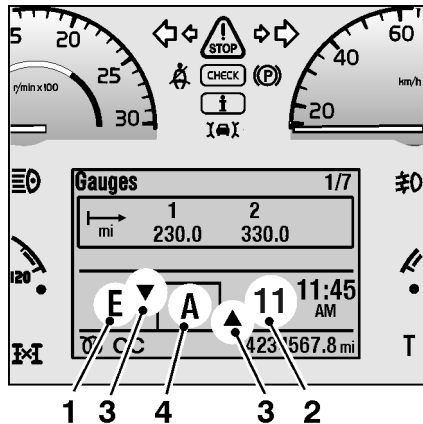

T3018210

## 1. Driving program

The section to the left of the gearbox field shows the driving program. The following driving programs are available:

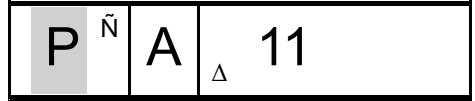

E = economy

E+ = freewheel possible<sup>1</sup>

P = power

B = braking<sup>2</sup>

L = Limp-Home function

B = Basic

CO = Commuter Traffic

LH = Line Haul Traffic

TC = Tourist & Charter Traffic

For more information about driving programs, refer to section “Driving”, page 10.

<sup>1</sup>The freewheel function is included in some program packages

<sup>2</sup>The brake program is included in some program packages

## 4 Introduction

---

### 2. Selected gear

The section to the right of the gearbox field shows the selected gear.

Gear no.1 - 12

N = neutral

(N1 = low split, N2 = high split)

R = reverse



### 3. Available gears

The second section from the left in the gearbox field shows, with arrows, the number of lower gears that are available (maximum 3 arrows).

The second section from the right in the gearbox field shows how many higher gears are available (maximum 3 arrows).

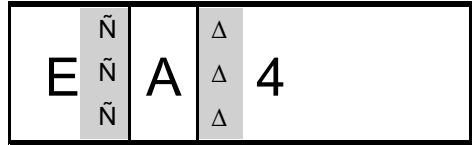

### 4. Gear selector buttons

The section in the middle of the display shows the button pressed of gear selector.

R = reverse

N = neutral

A = automatic (Drive)

M = manual

For more information about gear selection buttons, refer to section “Instruments and controls”, page 5.

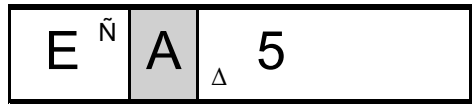

## I-shift gear selector pad

The I-shift gear selector pad is located on the left side of the driver's seat. This pad is available on two versions :

- Premium
- Basic

### Premium version description

- |   |                     |
|---|---------------------|
| 1 | Reverse             |
| 2 | Neutral             |
| 3 | (Automatic) Drive   |
| 4 | Manual              |
| 5 | Economy/Performance |
| 6 | Upshift             |
| 7 | Downshift           |

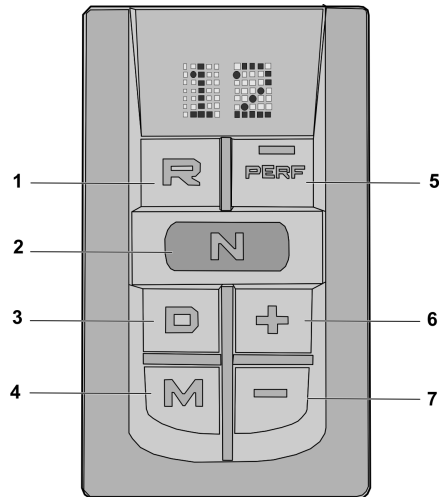

### Basic version description

- |   |                   |
|---|-------------------|
| 1 | Reverse           |
| 2 | Neutral           |
| 3 | Drive (Automatic) |
| 4 | Manual            |
| 5 | Limp mode         |

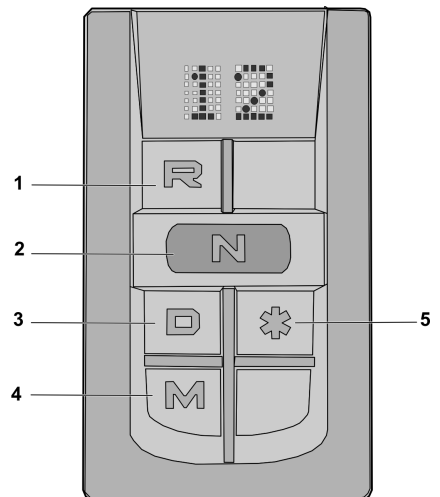

## 6 Instruments and controls

### I-shift gear selector pad programs

**Note:** The available programs depends on the I-shift gear selector pad version

The I-shift gear selector pad is used to choose between four different driving programs.

- R Reverse. The vehicle must be stopped in order to put the lever in position R.
- N Neutral position. No gear engaged.
- D Automatic programme. The gearbox itself selects the gear with respect to load, slope, speed and accelerator position.
- M Manual program. Changing up and down is done with the +/- buttons on the I-shift gear selector pad.

## Buttons

### Changing up/down

The +/- button is used to:

- change up or down one step at a time when in manual mode
- adjustment of gears in automatic mode
- to select split gear in neutral position when using power take-off
- to select reverse, see “Reverse gears”, page 19
- choice of start gear in automatic mode

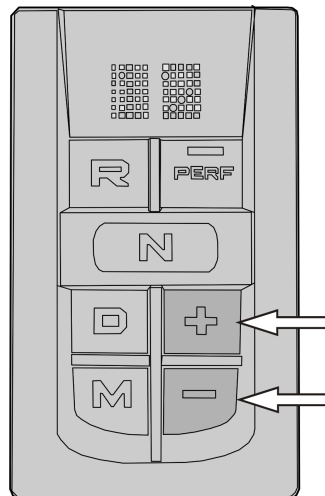



## Economy/Performance (E/P)

There is an economy/performance button (Perf) on the I-shift gear selector pad. This is used to:

- switch between the economy program and the power program

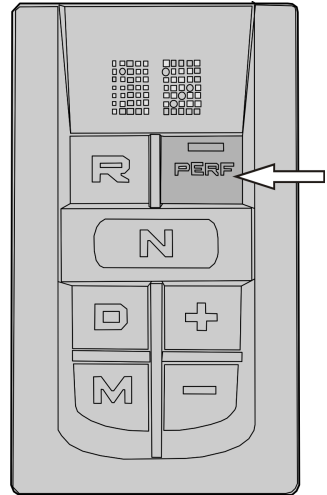

## 8 Instruments and controls

### Limp-Home

Limp home is an emergency mode that can be engaged if a fault has occurred in the gearbox that prevents the vehicle from being driven in automatic, manual or reverse modes.; see “In case of gearbox malfunction”, page 20

To activate the Limp Home mode for premium version of gear selector pad:

- Simultaneously press N and + buttons. Activating can only be done while the vehicle is stationary.
- Select M position or R position as required.

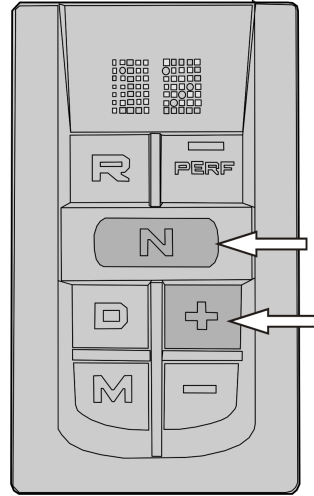

To activate the Limp Home mode for basic version of gear selector pad:

- Simultaneously press N and + limp mode buttons. Activating can only be done while the vehicle is stationary.
- Select M position or R position as required.

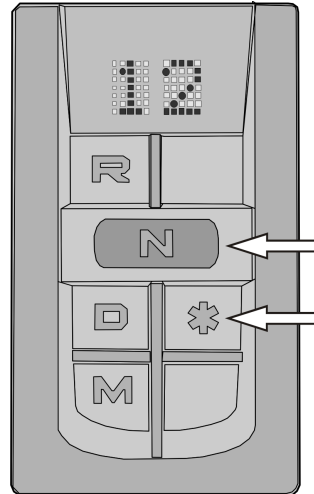

**Note:** Limp Home mode should only be used for moving short distances.

## Starting instructions

The neutral button must be selected on the I shift pad gear selector otherwise the engine will not start.

When the air pressure to the gearbox is too low, a warning will be displayed automatically. An icon will appear on the display at the same time as the information lamp comes on. Wait until the lamp has gone out before driving off.



Icon for low air pressure to gearbox

## Stopping the vehicle

When the vehicle is stationary:

- Apply the parking brake.
- Push the I-shift gear selector pad N button (neutral).
- Switch off the engine.



### CAUTION

Always apply the parking brake and put the I-shift gear selector pad in N when the vehicle is parked or whenever the driver leaves the driver position.

# 10 Driving

---

## Program package

Gearboxes have different characteristics and functions depending on the program package that is installed. The following program packages are available:

- **Basic** (B is shown on the display) is the standard transmission program
- **Commuter** is suited to the requirements of commuter traffic and includes functions that make the bus more easily manoeuvrable.
- **Line Haul** is suited to the requirements of line haul traffic and includes functions that provide improved fuel economy and also make the bus more easily manoeuvrable.
- **Tourist & Charter** are appropriate for tourist traffic demands. The program also includes functions that help improve fuel economy and make it easier to manoeuvre the bus.

Basic is the standard program and the other two programs include extra equipment. The table below shows the functions that are included in the different program options.

<b>Functions</b>	<b>Basic</b>	<b>Commuter</b>	<b>Line Haul</b>	<b>Tourist &amp; Charter</b>
Launch Control		X <sup>1</sup>	X	X
Enhanced Shift strategy		X	X	X
Kick-down			X	X
I- Roll including Smart cruise control				X
Gear selection Adjustment In Auto				X
<b>Possible optional functions</b>	<b>Basic</b>	<b>Commuter</b>	<b>Line Haul</b>	<b>Tourist &amp; Charter</b>
I-Roll including Smart cruise control		O <sup>2</sup>	O	

1 X - Standard application

2 O - Optional application

# 12 Driving

---

## Function description

### Standard characteristics

- **Performance Shift**  
The function selects the best way of performing a gear shift. This provides more nimble and comfortable shifting.
- **Basic Shifting Strategy**  
See “Automatic choice of starting gear”, page 13
- **Basic Shifting Regulation**  
Allows adjustment of automatically selected gear when engine braking.
- **Gearbox Oil Temperature Monitor**  
A warning system informs the driver if the oil temperature becomes too high.

### Optional characteristics

- **I-Roll (requires VEB or retarder)**  
Automatic clutching in or out of the freewheel function, with the aim of reducing fuel consumption. When the accelerator pedal is released, the drive line is disconnected so that the vehicle can roll freely, and the engine is brought down to idling speed.
- **Enhanced Shift Strategy**  
Works together with EBS as compensation for lack of engine braking during gear changing. This function enhances comfort.
- **Intelligent Auto Pilot**  
Only active when the cruise control is activated. Saves fuel by deactivating the auxiliary brakes in certain conditions. This function improves the auto pilot by disengaging the auxiliary brakes (VEB) while driving on ascents.
- **Gear Selection Adjustment in Auto**  
Allows gears to be selected automatically even when the accelerator pedal is depressed.
- **Pull-away control**  
Allows the clutch to be controlled at low speeds using the brake pedal. Allows the engine to idle without depressing the clutch. Regulates engine torque when pulling away for optimum gear changing and avoid high engine speed.
- **Kick down** the Kick Down function supplied maximum acceleration.

## **Automatic shifting**

The easiest way to drive the vehicle is to use the automatic program (D button). Gears will shift automatically, and the driver can focus on the actual driving.

When changing gear, the system will govern the clutch, gearbox and throttle. The system selects the gear and the point in time for gear changing for optimum driving performance based on accelerator pedal position, vehicle weight, road inclination, vehicle acceleration, etc.

In automatic mode it is also possible to adjust the gears up or down. The arrows in the display show how many steps it is possible to change up or down.

## **Automatic choice of starting gear**

The gearbox can also select a suitable pulling away gear based on vehicle weight and road inclination.

# 14 Driving

---

## Freewheel (I-Roll)

The freewheel can be activated if the lever for the auxiliary brake is in position A and E+ is shown in the display. When the freewheel is activated, the split gear is set to N, neutral. The freewheel is activated differently depending on whether the cruise control is on or not.

- 1 If the cruise control is active:
  - The free wheel is engaged in downhill stretches when speeds exceed the set driving speed (for example 80 km/h). The set permitted excess speed must be 6 km/h or more. (Please refer to “Driver's Manual ”, the chapter on auxiliary brakes for more information on how the auxiliary brake functions and how the excess speed can be set.)
  - The free wheel is disengaged when the speed exceeds the set excess speed or below the set driving speed (for example 80 km/h).
  - The I-Roll function also includes the Smart Cruise Control that inactivates the auxiliary brakes at the end of downhill slopes to further save fuel.
- 2 If the cruise control is not active:
  - The I-Roll is engaged when the accelerator is released and the road is flat or has a small slope upwards or downwards
  - The I-Roll is disengaged when the brake pedal is depressed, the accelerator is depressed, the lever for the auxiliary brake is set in position 0, 1, 2, 3 or B or if the M button of the I-shift gear selector pad is pushed.

When the free wheel is activated, N is shown as the gear in the info display and the engine idles.



## Locking gear

Do **not** use automatic up or down-changing when:

- When the vehicle gets near the top of an ascent and wants to avoid unnecessary downshifting.
- On an uphill slope with a flat section.
- When driving on poor surfaces.

**This function is used only when driving with the automatic program D**

The function can be used in all forward gears (1 to 12).

Whenever gear changing is not desired, (e.g. driving up a hill), change the selector from D to M. No further gear changes will be carried out and the current gear will remain engaged. The display shows an M.

To return to the automatic program, push the button A on the I-shift gear selector pad again.

**Note:** There is risk of over revving when the gear is locked.

**Note:** If the vehicle is stopped with a not permitted gear engaged in the M mode, the starting gear is automatically selected.

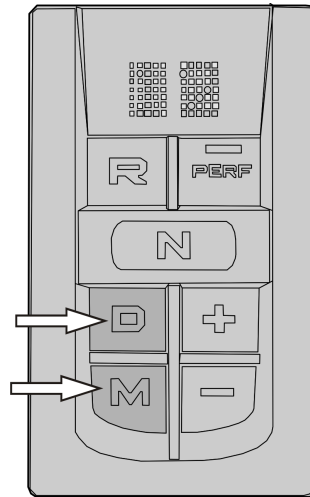

### CAUTION

Pulling away in too high a gear causes excessive wear to the clutch and can increase the risk for breakdown in the clutch.

# 16 Driving

## Driving program

There are three different driving programs:

Economy

Power or enhanced power for difficult conditions or poor roads

Braking program

### Economy

When the engine is on, the economy program is always selected (shown as an E on the display). The economy program prioritizes reduced fuel consumption while driving and is mainly used when driving under normal conditions.

### Power

The power program is engaged/disengaged using the Perf button (see figure). The power program prioritizes handling at the expense of fuel economy, and is used when driving in mountainous terrain or off-road driving. The power program generally uses higher engine speeds than the economy program, and a lower pull-away gear is selected.

To save fuel, the gearbox will automatically switch off the power program when it is no longer required and returns to the economy program.

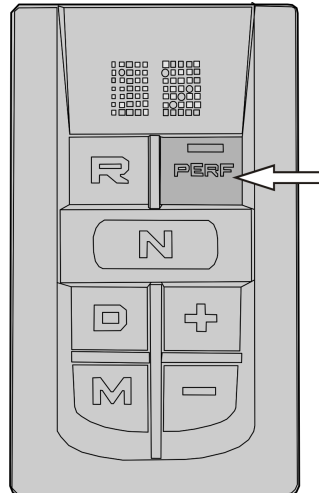

## Brakes

A special braking program can be engaged using the auxiliary brake lever. Please refer to “Driver's Manual”, section on auxiliary brake. (Optional function.)

## Kick-down

Kick-down is activated by pressing the accelerator pedal all the way down to the floor (position B). The kick-down program optimises gear selection/throttle for maximum acceleration. This is possible in both economy and power programs but not in manual position M. (Kick-down is an option.)

Position A = full throttle

Position B = kick down

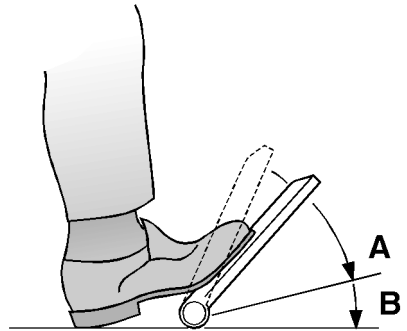

# 18 Driving

## Manual gear changing

The vehicle can be driven under manual shifting, or automatic shifting can be engaged whenever needed. Shift gears by first pushing the M button on the I-shift gear selector pad. The + and - buttons on the side of the I-shift gear selector pad are then used to select the gear.

Press the + or - buttons once for each up-shift or downshift, respectively, until the desired gear is reached.

Press the + or - buttons several times to shift several gears at once.

**Note:** When changing a gear, the accelerator pedal should **not** be released.

**Note:** If the vehicle is stopped with a not permitted gear engaged in the M mode, the starting gear is automatically selected.

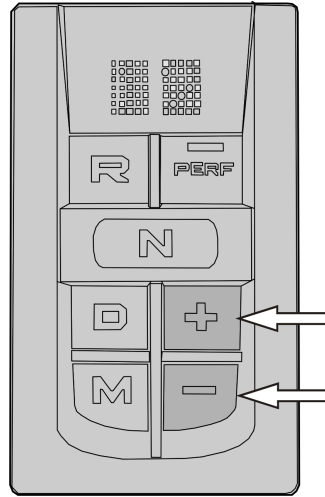

### CAUTION

Starting in a too high gear exposes the clutch to high levels of wear.

## Reverse gears

The gearbox has four reverse gears (R1 through R4). The vehicle must be stopped before reverse can be engaged. The system will automatically select R1 when the I-shift gear selector pad is set to R.

While driving, it is possible to shift between R1 and R2, and between R3 and R4. To shift between R2 and R3, the vehicle must be stopped.

Use the + or - buttons on the I-shift gear selector pad to change gear manually.



### CAUTION

Starting in a too high gear exposes the clutch to high levels of wear.

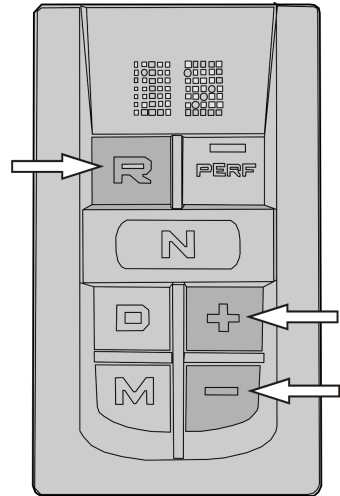

### In case of gearbox malfunction

Where there is a fault with the gearbox that means that you cannot drive the vehicle, activate the Limp-Home function and drive on.

**Note:** The Limp-Home function should only be used for short distances and activating can only be done while the vehicle is stationary

Activate Limp-Home as follows:

- 1 Simultaneously press N and + buttons (or limp mode for basic version).
- 2 Select M position or R position as required
- 3 Select a gear using the + or - buttons on the I-shift gear selector pad

When Limp-Home is selected, the vehicle cannot be driven if the I-shift gear selector pad is set on automatic mode. Only forward gears 1, 3 and 5, and reverse gear 1 may be used. The transmission can only be shifted when the vehicle is stopped.

To select reverse, set the I-shift gear selector pad to R. Set the I-shift gear selector pad back to M to drive forwards again.

The Limp-Home function will be disengaged when the ignition is turned off.

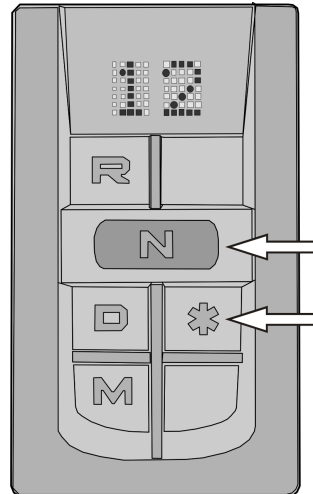
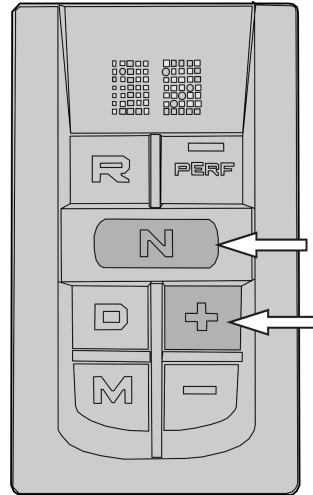

## Fuel economy driving

I-Shift is optimized to provide the best fuel economy for the vehicle's situation. To achieve better fuel economy, drive in mode automatic whenever possible. Only chose mode manual when driving in conditions that require manual shifting.

## I-Roll

During normal driving, the I-shift gear selector pad should be set on D (automatic), and the auxiliary brake should be in position A so that I-Roll can be accessed. Use I-Roll whenever possible: for example, on gentle descents.

Set the cruise control's speed slightly lower and instead increase the overspeed. This gives more opportunities when I-Roll can be activated and thereby save fuel.

## Avoid downshifting

In some cases, it may be better to stay in a higher gear if the engine speed is low. For example, immediately before reaching the top of an incline, it's better to reach the top without downshifting, which saves on fuel. When driving, hold the + button down until the vehicle starts to accelerate again to avoid downshifts.

## 22 Driving tips

---

### Avoid up-shifts

To avoid up-shifting (for example, when climbing a hill) the - button should be held down until the vehicle starts to brake (hill climbing).

The function can also be used just before an uphill slope to get a higher speed into the uphill slope. Down-changing functions normally in these cases.

### Greatest possible down-change

To optimize downshifting, for example, after a steep climb:

- Hold the minus button pressed in
- Change the I-shift gear selector pad from D to the M
- Release the minus button

This allows for better downshifting, since immediately after releasing the (-) button the engine speeds up. Keep the M program when you want to avoid another shift in gears.

### Save brakes

Preferably use the engine brake to brake towards a stop to save the service brakes. When braking hard, brake program B can be used. Down-changing will then occur which contributes to an increased braking effect from the engine brake.



## Queue driving

The Launch control function allows you to drive the vehicle in idle, which is sufficient when driving in traffic jams. If you have selected the "Enhanced Gear Selection" setting, including Kick-down, then you can also downshift or up-shift to adjust to the speed of traffic. The gearbox will then increase the engine speed a bit to allow the transmission to shift.

Activating while standing still:

- 1 Choose position D or M
- 2 Release the brake
- 3 Depress the accelerator pedal
- 4 Release the accelerator pedal once the vehicle starts to move forward.

When the brake pedal is depressed or it becomes so heavy that the engine risks stopping, the clutch is disengaged to prevent the engine from stopping. To return to queue driving, press on the accelerator pedal.

**Note:** The vehicle does not need to be stopped for this function to be activated.

**Note:** At low speeds and gears, queue driving is activated automatically. Depress the brake pedal to inactivate.

## 24 Driving tips

---

### Hill Start

If the vehicle is equipped with “Auxiliary uphill pull-away” this must be used to prevent the vehicle from rolling back when pulling away on an uphill slope.

- Keep the vehicle stationary using the handbrake.
- Change the I-shift gear selector pad to the A or M position and select a suitable starting gear.
- Depress the accelerator pedal at the same time as releasing the parking brake.



This icon will be shown on the cluster when hill start mode is activated



#### **CAUTION**

Never hold the vehicle stationary on an uphill slope by using the accelerator pedal. The clutch could overheat, which could cause it to fail.

## Driving on poor roads and in difficult conditions

In difficult driving conditions or mountainous terrain (for example, on forest roads, job sites or off-road) it can be helpful to use the P driving program, which allows fewer shifts to be made. The gear selection is optimized for higher engine speeds, in order to achieve good response and acceleration while maintaining good fuel economy. This also offers higher tolerance for shifts during on-road ascents.

To prevent unplanned gear changing, e.g. on a soft surface or sudden change of the terrain that the automatic gear changing can not foresee, use manual mode.

To prevent up-changing when e.g. driving uphill, the minus button can be held pressed in. The function can also be used just before an uphill slope to get a higher speed into the uphill slope.

To achieve the greatest down-change possible, e.g. just before a steep uphill slope, hold down the minus button, move the I-shift gear selector pad from position A to M and then release the minus button.

In normal driving conditions, return to the E driving program by pressing the Perf button for optimum fuel consumption.

## 26 Driving tips

---

### Clutch

The clutch is a dry disc type, i.e. has no torque converter. Therefore, never allow the clutch to slip in too high a gear when pulling away. The information lamp will come on and a symbol will appear on the display if the clutch overheats.

If the lamp lights up when the vehicle is started and the bus is already moving, continue driving.

If the lamp lights up when the vehicle is started and the bus is not moving, set the gear to position D or position R and let the engine idle until the light goes out.

When starting in manual position, choose 1st gear to avoid straining the clutch.

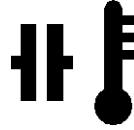

These icons will appear on the cluster if clutch overheats



#### CAUTION

Never hold the vehicle stationary on an uphill slope by using the accelerator pedal. The clutch could overheat, which could cause it to fail.

## Declutching

If rapid declutching is required, e.g. in slippery conditions, change the I-shift gear selector pad to N, neutral.

## Extra down-changing for maximum engine brake in low gears

For maximum comfort in low gears, the braking program B does not permit more than one down-change at a time when the gearbox has one of these gears engaged. To get maximum braking power e.g. at construction site driving, move the auxiliary brake stalk to the B position repeatedly, which results in a down-change each time. Thereby a higher engine speed and maximum engine brake is obtained.

## Changing driving direction

(Applies only to units equipped with EBS)

The driving direction, forwards (A or D) or backwards (R), can be changed while driving using the I-shift gear selector pad without the brake pedal being used. The bus does not need to be standing still. The unit brakes slowly down automatically and when stationary the gear is changed for the new driving direction.

**Note:** The function must only be used when marshalling.

## 28 If something happens

### Towing with I-Shift

**Note:** During towing, the main switch and parking lamps shall be lit if the electrical system of the vehicle is functioning.



#### CAUTION

Failure to disconnect the driveshaft, remove the drive axle shaft(s) or lift the drive wheels off the ground before towing or pushing the vehicle, can cause serious transmission damage and void the transmission warranty.

**Note:** Traction control system should be turned off if one of the axles is raised during towing.

The parking brake must be released during towing.

For all long distance towing, assure that the tow vehicle has the necessary equipment to reach the front axle, per bus specifications. It may be necessary for the tow vehicle to attach an air supply to the bus during towing.

Towing or moving the bus for short distances can also be performed using a towing rod or bar. Refer to the accompanying illustrations for attaching points location.

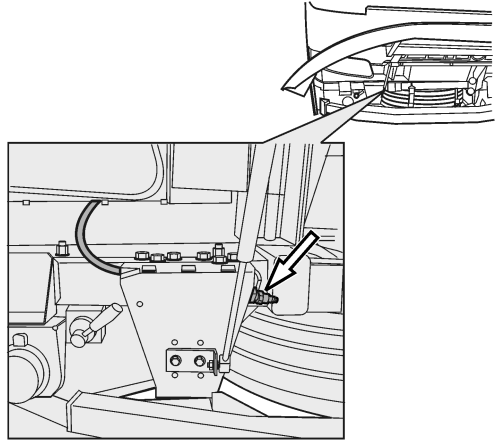

Front Air Supply Connection Location

The position for attaching is available in the front of the bus. See the accompanying illustration for the general location.

After mechanically releasing the parking brake, the bus cannot be braked either with the main brake or with the parking brake. Block the wheels or connect to the tow vehicle, so that the bus cannot start moving after the parking brake has been released.

Towing requires either the drive shaft or both drive shafts to be removed, because otherwise the transmission may be damaged due to insufficient lubrication.

**Note:** For punctures, the tire must be repaired before towing begins.

For more information about towing, refer to Function Group 192, Information type Description Towing information

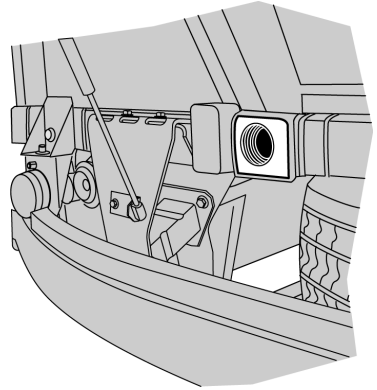

Place for towing bar attachment (front).

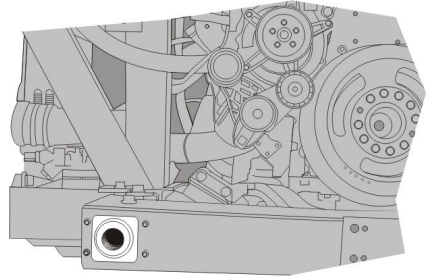

T8059309

Place for towing bar attachment (rear)

## 30 If something happens

---

### Towing alternative procedure.

**Note:** This procedure applies only for buses with I-Shift AMT-D with towing alternative procedure.

If the standard procedure can't be followed due to road conditions, follow the alternative procedure described below.

This will allow the vehicle to be towed without the removal of the driveshaft for whatever distance the vehicle need to be towed. The following conditions must be met.



#### CAUTION

**Do not replace the towing standard procedure, this procedure does not have any indicator, if any of the steps below are not fulfilled a transmission damage may occur.**

Towing gear 3 HR will be engaged if following points are fulfilled:

- The gear lever or the shift pad must be in neutral
- Engine is not running
- There must be enough air pressure to the gearbox
- The vehicle must have electrical power.
- The ignition key must be in "ON" position.
- Vehicle must be towed forward



#### CAUTION

Reverse towing is not allowed when such towing alternative procedure applied.  
Reverse towing can damage the gearbox.



## Nomenclature and Ratios

The I-Shift transmission is available in three configurations:

- AT2612D – Direct Drive for VOLVO D11 and D13 Engines
- ATO2612D – Overdrive for VOLVO D11 and D13 Engines
- ATO3112D – Overdrive for VOLVO D16 Engines

### Nomenclature

AT	O	XX	12	D
Automated Mechanical Transmission	O = Overdrive No Letter = Direct Drive	Maximum Input Torque Nm (ft-lb) 26 = 2600 (1918) 31 = 3100 (2300)	Forward Speeds	Design Level

## 32 Technical Data

---

### Gear Ratios

Gear Selection	<b>AT2612D</b>	<b>ATO261 2D</b>	<b>ATO3112D</b>
	<b>Direct Drive</b>	<b>Overdrive</b>	<b>Overdrive</b>
1st	14.94:1	11.73	11.73
2nd	11.73:1	9.21	9.21
3rd	9.04:1	7.09	7.09
4th	7.09:1	5.50	5.50
5th	5.54:1	4.35	4.35
6th	4.35:1	3.41	3.41
7th	3.44:1	2.70	2.70
8th	2.70:1	2.12	2.12
9th	2.08:1	1.63	1.63
10th	1.63:1	1.28	1.28
11th	1.27:1	1.00	1.00
12th	1.00:1	0.79	0.79
Reverse Gear R1	17.48:1	13.73	13.73
Reverse Gear R2	13.73:1	10.78	10.78
Reverse Gear R3	4.02:1	3.16	3.16
Reverse Gear R4	3.16:1	2.48	2.48

**A**

Automatic transmission ..... 13  
 Available gears ..... 4  
 Avoid downshifting ..... 21  
 Avoid up-shifts ..... 22

**B**

Braking program ..... 17  
 Button D ..... 6  
 Button M ..... 6  
 Button N ..... 6  
 Button R ..... 6  
 Buttons ..... 6

**C**

Changing up/down ..... 6  
 Clutch ..... 26  
 Compressed air, gearbox ..... 9

**D**

Decutching ..... 27  
 Display ..... 2  
 Driver's responsibility ..... 1  
 Driving ..... 10  
 Driving fuel economy ..... 21  
 Driving in construction sites ..... 25  
 Driving on forest roads ..... 25  
 Driving program ..... 3, 16  
 Driving tips ..... 21

**E**

Economy program ..... 16  
 Economy/Performance (E/P) ..... 7  
 Engaging a gear ..... 18

**F**

Freewheel ..... 14  
 Fully manual shifting ..... 18

**H**

Hill Start ..... 24

**I**

I-Roll ..... 14, 21  
 I-shift gear selector pad ..... 5  
 I-shift gear selector pad programs ..... 6  
 If something happens ..... 28  
 Instruments and controls ..... 5  
 Introduction ..... 1

**K**

Kick-down ..... 17

**L**

Lever position ..... 4  
 Limp-Home ..... 8  
 Limp-Home function ..... 20  
 Locking gear ..... 15

**O**

Off-road ..... 25  
 Optimized downshifting ..... 22  
 Optional characteristics ..... 12

**P**

Power program ..... 16  
 Program packages ..... 10

**Q**

Queue driving ..... 23

**R**

Reverse gears ..... 19

## 34 Index

---

### S

Safety information. ....	5
Save brakes .....	22
Selected gear .....	4
Standard characteristics .....	12
Starting and stopping .....	9

Stopping the engine.....	9
--------------------------	---

### T

Technical Data .....	31
----------------------	----



**VOLVO**

**Volvo Bus Corporation**

Göteborg, Sweden

# Driver's Handbook

## I-START System

B13R, 9700/USCAN



C0080351

**VOLVO**

# Foreword

This manual contains information concerning the operation and function of the Volvo 9700 US/CAN bus I-Start System. Please keep this manual in the vehicle at all times.

Technical data, construction information, descriptions and illustrations in this driver's handbook, that were current when the book was published, can have been changed. The Volvo company reserve the right to make changes without prior notice.

The National Highway Traffic Safety Administration (NHTSA) and Prevost should be informed immediately if you believe that the vehicle has a defect that could cause a crash, injury or death.

Contact NHTSA by calling the Auto Safety Hotline at 1 (888) 327-4236, by writing to NHTSA, U.S. Department of Transportation, Washington, DC 20590, by TTY at 1 (800) 424-9153, or visit their website at: [www.nhtsa.dot.gov](http://www.nhtsa.dot.gov).

Please keep this manual in the vehicle at all times.

**Note:** Illustrations in this manual are used for reference only and may differ slightly from the actual vehicle. However, key components addressed in this document are represented as accurately as possible.

**Note:** It is important that this manual stays with the vehicle when it is sold. Important safety information must be passed on to the new owner.

All information, illustrations and specifications contained in this manual are based upon the latest product information available at the time of publication. VOLVO Bus reserves the right to make changes at any time or to change specifications or design without notice and without incurring obligation.

## Volvo Bus Corporation

Göteborg, Sweden

**Order number: 89258615**

©2016 Volvo Bus Corporation, Göteborg, Sweden

All rights reserved. No part of this publication may be reproduced, stored in retrieval system, or transmitted in any forms by any means, electronic, mechanical, photocopying, recording or otherwise, without the prior written permission of Volvo Bus Corporation



---

# Contents

<b>Introduction</b> .....	1
Driver's responsibility .....	1
<b>Overview</b> .....	2
<b>General Information</b> .....	3
Labels .....	3
Power relays labels .....	4
Schematics .....	5
<b>Battery charger</b> .....	6
Batteries charger electrical outlet .....	6
Batteries charger specification .....	6
Charging mode .....	7
Battery charging time .....	8
<b>ARMS (Automatic Reset Main Switch)</b> .....	9
<b>Starter batteries compartment</b> .....	10
The battery main switch .....	10
A chassis fuse box .....	10
<b>Consumer batteries compartment</b> .....	11
A body fuse box .....	11
12 V Fuse holder .....	11
<b>Vehicle messages and symbols</b> .....	12
For I-start .....	12
For Starter Batteries/ARMS .....	13
<b>If something happens</b> .....	14
Service Switch .....	14
Jump start ground connection .....	15
Jump start procedure .....	16
<b>Index</b> .....	17



---

# Safety Information

**IMPORTANT:** Before driving this vehicle, be certain that you have read and that you fully understand each and every step of the driving and handling information in this manual. Be certain that you fully understand and follow all safety warnings.

IT IS IMPORTANT THAT THE FOLLOWING INFORMATION BE READ, UNDERSTOOD AND ALWAYS FOLLOWED.

The following types of advisories are used throughout this manual:



## DANGER

Danger indicates an unsafe practice that could result in serious personal injury or death. A danger advisory banner is in **white** type on a **black** background with a **black** border.



## WARNING

Warning indicates an unsafe practice that could result in personal injury. A warning advisory banner is in **black** type on a **gray** background with a **black** border.



## CAUTION

Caution indicates an unsafe practice that could result in damage to the product. A caution advisory is in **black** type on a **white** background with a **black** border.

**Note:** Note indicates a procedure, practice, or condition that must be followed in order for the vehicle or component to function in the manner intended.

---

## Driver's responsibility

- As the driver, you are responsible for the safety and comfort of the passengers during the journey. Therefore, do not drive the bus before you have read this driver's manual. You must be familiar with all the indicators and warning lights and know what to do if something unexpected happens.
- As the driver of the vehicle, it is your responsibility to foresee any hazards that could threaten your passengers.
- It is also your responsibility to ensure that all the safety equipment of the bus is in place. Therefore check regularly the working order of safety belts, emergency door and window opening, door sensitive edges, fire extinguishers and first aid equipment.
- Follow the recommended service and maintenance program to maintain the bus's condition and safety.

## 2 Overview

---

I-Start is a dual battery system designed to secure cranking and provide a longer service life for the batteries

In order to achieve this, vehicle loads are split in two systems:

- Chassis electronics (connected to Starter Batteries)
- Body electronics (connected to Consumer Batteries)

All the electric devices are connected to the consumer batteries (Coffee makers, Lamps, Power outlets, etc).



### **WARNING**

On vehicles with I-Start there is voltage in the starter batteries even if the battery main switch is disengaged. In order to fully de-energize the vehicle, the cables on the battery terminals must be disconnected from both the starter batteries and the consumer batteries.

## Labels

Danger, Warning and Caution labels are placed in various locations on the vehicle to alert drivers and service technicians about situations that may lead to personal injury or equipment damage. In the event that a label is damaged or missing the **label must be replaced**. Contact your authorized VOLVO Bus dealer for assistance regarding labels.

Decal is placed in the chassis fuse box in the starter batteries compartment.

### WARNING

#### STARTER BATTERIES

Do not stock anything in this compartment  
Starter motor is always connected to 24V  
Starter batteries

Ne pas ranger quoi que ce soit dans ce compartiment  
Le démarreur est toujours sous tension 24-volt  
Batteries de démarrage

No almacenar nada en este compartimento  
El motor de arranque está siempre conectado a 24V  
Baterías de arranque



W0111068

Decal is placed in the body fuse box in the consumer batteries compartment.

### WARNING

#### CONSUMER BATTERIES

Do not stock anything in this compartment  
Consumer batteries  
Do not jump start here

Ne pas ranger quoi que ce soit dans ce compartiment  
Batteries de consommation  
Ne pas connecter une batterie d'appoint pour démarrage de secours ici

No almacenar nada en este compartimento  
Baterías de Consumo  
No pasar corriente



W0111069

Decal with the system description is placed on the hatch of the right side battery compartment.

### I-START SYSTEM OVERVIEW

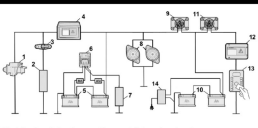

When battery charged is plugged in power goes consumer batteries are always charged  
 Bei charged battery system power will always be provided  
 When I-Start engine with battery charged plugged in the power goes  
 Cuando el cargador de batería está conectado a los cables, los cables de consumo siempre se cargan.  
 Una carga del sistema de arranque se hace por la base de gestión de la potencia si  
 la base de arranque se activa y el cargador de batería está conectado a los cables.

L'unique le Chargeur de Batterie est branché, les batteries de Consommation seront maintenues pleines charge.  
 Dans l'étape les batteries de Consommation, elles toujours la puissance.  
 Ne jamais débrancher le moteur avec le chargeur de Batterie branché.

For more information see electrical service manual.  
 Para más información véase el manual eléctrico de servicio.  
 Für mehr Informationen siehe ein Manual de service électrique.

### CAUTION

<p><b>Start components:</b></p> <ul style="list-style-type: none"> <li>1. Starter motor</li> <li>2. Control Switch</li> <li>3. Battery fuse holder</li> <li>4. Chassis fuse box</li> <li>5. Battery fuse holder</li> <li>6. Battery fuse holder</li> <li>7. Battery fuse holder</li> <li>8. Battery fuse holder</li> <li>9. Battery fuse holder</li> <li>10. Battery fuse holder</li> <li>11. Battery fuse holder</li> <li>12. Battery fuse holder</li> <li>13. Battery fuse holder</li> <li>14. Battery fuse holder</li> <li>15. Battery fuse holder</li> <li>16. Battery fuse holder</li> <li>17. Battery fuse holder</li> <li>18. Battery fuse holder</li> <li>19. Battery fuse holder</li> <li>20. Battery fuse holder</li> <li>21. Battery fuse holder</li> <li>22. Battery fuse holder</li> <li>23. Battery fuse holder</li> <li>24. Battery fuse holder</li> <li>25. Battery fuse holder</li> <li>26. Battery fuse holder</li> <li>27. Battery fuse holder</li> <li>28. Battery fuse holder</li> <li>29. Battery fuse holder</li> <li>30. Battery fuse holder</li> <li>31. Battery fuse holder</li> <li>32. Battery fuse holder</li> <li>33. Battery fuse holder</li> <li>34. Battery fuse holder</li> <li>35. Battery fuse holder</li> <li>36. Battery fuse holder</li> <li>37. Battery fuse holder</li> <li>38. Battery fuse holder</li> <li>39. Battery fuse holder</li> <li>40. Battery fuse holder</li> <li>41. Battery fuse holder</li> <li>42. Battery fuse holder</li> <li>43. Battery fuse holder</li> <li>44. Battery fuse holder</li> <li>45. Battery fuse holder</li> <li>46. Battery fuse holder</li> <li>47. Battery fuse holder</li> <li>48. Battery fuse holder</li> <li>49. Battery fuse holder</li> <li>50. Battery fuse holder</li> <li>51. Battery fuse holder</li> <li>52. Battery fuse holder</li> <li>53. Battery fuse holder</li> <li>54. Battery fuse holder</li> <li>55. Battery fuse holder</li> <li>56. Battery fuse holder</li> <li>57. Battery fuse holder</li> <li>58. Battery fuse holder</li> <li>59. Battery fuse holder</li> <li>60. Battery fuse holder</li> <li>61. Battery fuse holder</li> <li>62. Battery fuse holder</li> <li>63. Battery fuse holder</li> <li>64. Battery fuse holder</li> <li>65. Battery fuse holder</li> <li>66. Battery fuse holder</li> <li>67. Battery fuse holder</li> <li>68. Battery fuse holder</li> <li>69. Battery fuse holder</li> <li>70. Battery fuse holder</li> <li>71. Battery fuse holder</li> <li>72. Battery fuse holder</li> <li>73. Battery fuse holder</li> <li>74. Battery fuse holder</li> <li>75. Battery fuse holder</li> <li>76. Battery fuse holder</li> <li>77. Battery fuse holder</li> <li>78. Battery fuse holder</li> <li>79. Battery fuse holder</li> <li>80. Battery fuse holder</li> <li>81. Battery fuse holder</li> <li>82. Battery fuse holder</li> <li>83. Battery fuse holder</li> <li>84. Battery fuse holder</li> <li>85. Battery fuse holder</li> <li>86. Battery fuse holder</li> <li>87. Battery fuse holder</li> <li>88. Battery fuse holder</li> <li>89. Battery fuse holder</li> <li>90. Battery fuse holder</li> <li>91. Battery fuse holder</li> <li>92. Battery fuse holder</li> <li>93. Battery fuse holder</li> <li>94. Battery fuse holder</li> <li>95. Battery fuse holder</li> <li>96. Battery fuse holder</li> <li>97. Battery fuse holder</li> <li>98. Battery fuse holder</li> <li>99. Battery fuse holder</li> <li>100. Battery fuse holder</li> </ul>	<p><b>Consumables (Start):</b></p> <ul style="list-style-type: none"> <li>1. Starter motor</li> <li>2. Control Switch</li> <li>3. Battery fuse holder</li> <li>4. Chassis fuse box</li> <li>5. Battery fuse holder</li> <li>6. Battery fuse holder</li> <li>7. Battery fuse holder</li> <li>8. Battery fuse holder</li> <li>9. Battery fuse holder</li> <li>10. Battery fuse holder</li> <li>11. Battery fuse holder</li> <li>12. Battery fuse holder</li> <li>13. Battery fuse holder</li> <li>14. Battery fuse holder</li> <li>15. Battery fuse holder</li> <li>16. Battery fuse holder</li> <li>17. Battery fuse holder</li> <li>18. Battery fuse holder</li> <li>19. Battery fuse holder</li> <li>20. Battery fuse holder</li> <li>21. Battery fuse holder</li> <li>22. Battery fuse holder</li> <li>23. Battery fuse holder</li> <li>24. Battery fuse holder</li> <li>25. Battery fuse holder</li> <li>26. Battery fuse holder</li> <li>27. Battery fuse holder</li> <li>28. Battery fuse holder</li> <li>29. Battery fuse holder</li> <li>30. Battery fuse holder</li> <li>31. Battery fuse holder</li> <li>32. Battery fuse holder</li> <li>33. Battery fuse holder</li> <li>34. Battery fuse holder</li> <li>35. Battery fuse holder</li> <li>36. Battery fuse holder</li> <li>37. Battery fuse holder</li> <li>38. Battery fuse holder</li> <li>39. Battery fuse holder</li> <li>40. Battery fuse holder</li> <li>41. Battery fuse holder</li> <li>42. Battery fuse holder</li> <li>43. Battery fuse holder</li> <li>44. Battery fuse holder</li> <li>45. Battery fuse holder</li> <li>46. Battery fuse holder</li> <li>47. Battery fuse holder</li> <li>48. Battery fuse holder</li> <li>49. Battery fuse holder</li> <li>50. Battery fuse holder</li> <li>51. Battery fuse holder</li> <li>52. Battery fuse holder</li> <li>53. Battery fuse holder</li> <li>54. Battery fuse holder</li> <li>55. Battery fuse holder</li> <li>56. Battery fuse holder</li> <li>57. Battery fuse holder</li> <li>58. Battery fuse holder</li> <li>59. Battery fuse holder</li> <li>60. Battery fuse holder</li> <li>61. Battery fuse holder</li> <li>62. Battery fuse holder</li> <li>63. Battery fuse holder</li> <li>64. Battery fuse holder</li> <li>65. Battery fuse holder</li> <li>66. Battery fuse holder</li> <li>67. Battery fuse holder</li> <li>68. Battery fuse holder</li> <li>69. Battery fuse holder</li> <li>70. Battery fuse holder</li> <li>71. Battery fuse holder</li> <li>72. Battery fuse holder</li> <li>73. Battery fuse holder</li> <li>74. Battery fuse holder</li> <li>75. Battery fuse holder</li> <li>76. Battery fuse holder</li> <li>77. Battery fuse holder</li> <li>78. Battery fuse holder</li> <li>79. Battery fuse holder</li> <li>80. Battery fuse holder</li> <li>81. Battery fuse holder</li> <li>82. Battery fuse holder</li> <li>83. Battery fuse holder</li> <li>84. Battery fuse holder</li> <li>85. Battery fuse holder</li> <li>86. Battery fuse holder</li> <li>87. Battery fuse holder</li> <li>88. Battery fuse holder</li> <li>89. Battery fuse holder</li> <li>90. Battery fuse holder</li> <li>91. Battery fuse holder</li> <li>92. Battery fuse holder</li> <li>93. Battery fuse holder</li> <li>94. Battery fuse holder</li> <li>95. Battery fuse holder</li> <li>96. Battery fuse holder</li> <li>97. Battery fuse holder</li> <li>98. Battery fuse holder</li> <li>99. Battery fuse holder</li> <li>100. Battery fuse holder</li> </ul>
--	---

W0111070

## 4 General Information

---

### Power relays labels

The I-Start system have two power relays:

- **K400** relay is identified with a label placed on the left side battery compartment near to the Consumer Batteries.
- **K300** relay is identified with a label placed on the right side battery compartment near to the Starter Batteries.

**Note:** Both power relays have a decal in three languages for a better identification.



W0111072



W0111071



## Schematics

I-Start system has the next Schematics distribution.

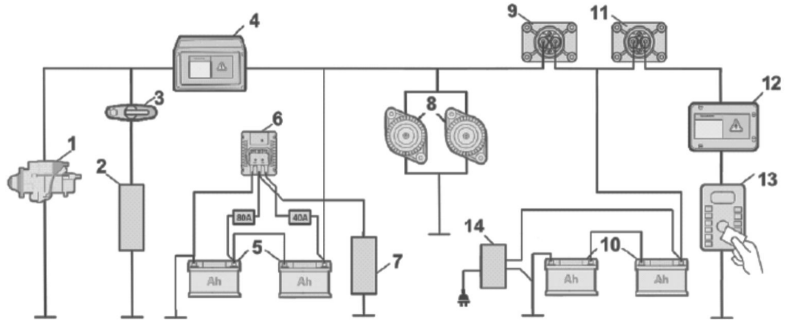

T3113041

- |                       |  |
|-----------------------|--|
| 1 Starter Motor       | 9 Split relay (Ignition controlled)  |
| 2 Chassis Loads       | 10 Consumer batteries  |
| 3 Battery Main Switch | 11 Body relay (MCM controlled)   |
| 4 Chassis fuse box    | 12 Body fuse box   |
| 5 Starter batteries   | 13 Consumer loads (Video Equipment,<br>Coffee maker, Lamps, Power outlets, etc.) |
| 6 Battery equalizer   | 14 Battery Charger   |
| 7 12 V Chassis loads  |  |
| 8 24 V Alternators    |  |

## 6 Battery charger

---

### Batteries charger electrical outlet

In the right hand side batteries compartment hatch there is installed an electrical outlet for connecting the charger to the power grid.

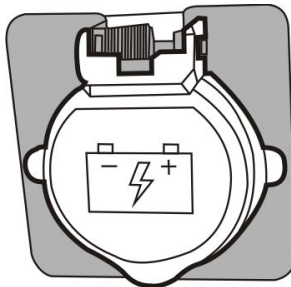

W0111074

### Batteries charger specification

The current consumption is 15A connected to 120VAC +/- 10% 60Hz +/- 10.

---

## Charging mode

The batteries charger has the following charging modes:

- If ignition key is on position **0** or **I + click**, only the consumer batteries are charged.
- If Ignition key is on position **II**, starter and consumer batteries are charged.

If Ignition key is on position I + click, bus accessories can be used (like the radio).



### WARNING

Never crank engine with battery charger plugged on the power grid.

## 8 Battery charger

---

### Battery charging time

Consumer batteries (ignition key on position 0 or position I + click):

- State of charge from **50% to 80%**:  
Around **45 minutes**.\*
- State of charge from **60% to 80%**:  
Around **30 minutes**.\*
- State of charge from **70% to 80%**:  
Around **15 minutes**.\*
- Starter and Consumer Batteries with state of charge from **50% to 80%**: Around **6 hours**.\*
- Starter and Consumer Batteries with state of charge from **60% to 80%**: Around **4 hours**.\*
- Starter and Consumer Batteries with state of charge from **70% to 80%**: Around **2 hours**.\*

\* Considering SOH (State Of Health) **100%** and **25 °C**.

The values were estimated and may vary according to specific conditions.



T0014333

# ARMS (Automatic Reset Main Switch) 9

The function of the ARMS (Automatic Reset of Main Switch) relay is to secure energy for cranking.

The ARMS relay is responsible for shutting down +30 power source to prevent starter batteries from getting drained when **23,5 V** are detected for more than **120 seconds**.

ARMS relay is located in the fuse box..

This function will only work if the ignition key is on position **I + a click**, refer to the ignition key positions on the Driver's manual.

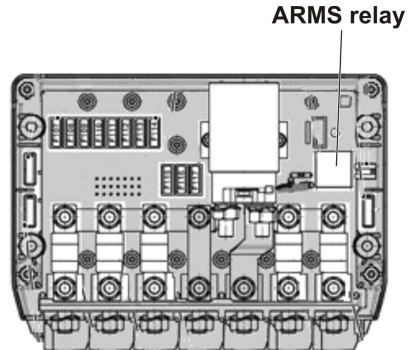

W0111465

# 10 Starter batteries compartment

The starter batteries supply the necessary current to starter motor to work. These batteries are located in the left side of the bus, refer to the image.

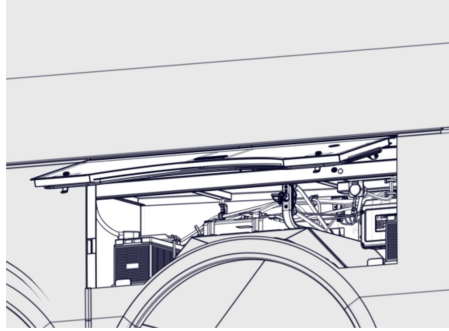

## The battery main switch

The battery main switch disconnects the current to the consumer batteries but NOT the starter batteries.

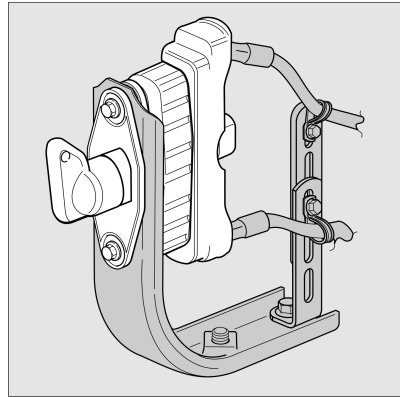

W0104281

## A chassis fuse box

This fuse box contains the fuses for the I-Start System. This fuse box is located in the starter batteries compartment.

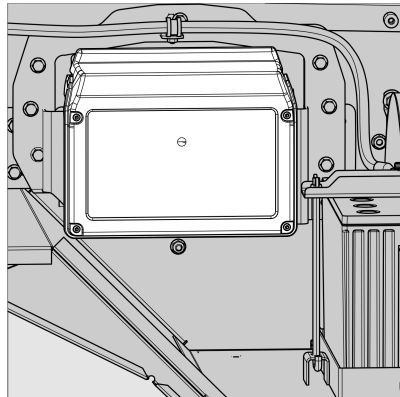

W0104280

The consumer batteries supply energy to all bus electrical devices and the vehicle's Control Units. These batteries are located in the right side of the bus, refer the image.

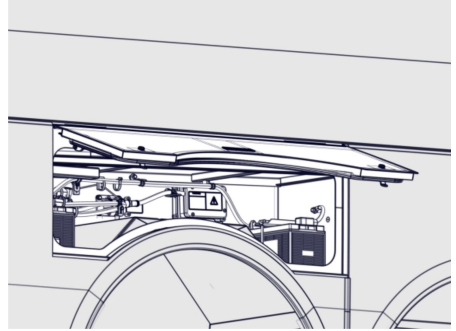

## A body fuse box

This fuse box contains the fuses for the I-Start System. This fuse box is located in the consumer batteries compartment.

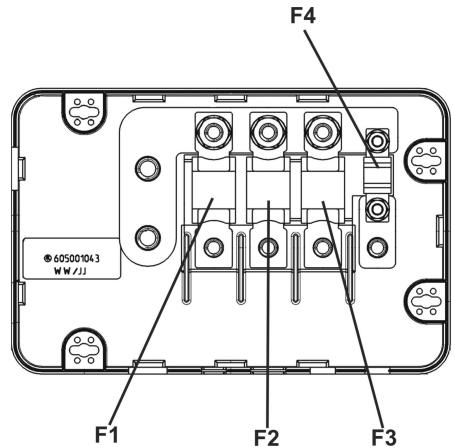







T3113651

## 12 V Fuse holder

12V supply from Equalizer

A decal was added to the fuse holder for a better identification of each fuse.



F958 10A (12V) 	F957 20A (12V) 	F956 10A (12V) 	F955 20A (12V) 	F915 30A (12V) 	F907 20A (12V) 
--	--	--	--	--	--

T3115137

## 12 Vehicle messages and symbols

---

### For I-start

#### High Voltage / Consumer Batteries and probable causes:

- Rapid charger or jump starting unit connected
- Faulty alternator
- Abnormally high voltage or short-circuit to higher voltage

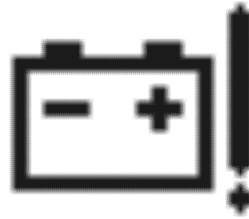

T3113158

#### Low voltage / Consumer Batteries and probable causes:

- Faulty battery
- Abnormally low voltage or short-circuit to ground cable

#### I START fault and probable causes:

- Problem on K300 or K400 or K53 Relay

**Note:** If one of the mentioned messages appear, call to the service center at the next stop.



## For Starter Batteries/ARMS

### High Voltage / Starter Batteries and probable causes:

- Rapid charger or jump starting unit connected
- Faulty alternator
- Faulty battery
- Abnormally high voltage or short-circuit to higher voltage



T3113159

### Supply voltage below 24 V and probable causes:

- Faulty battery
- Abnormally low voltage or short-circuit to ground cable

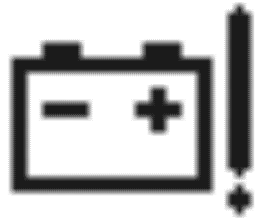

T3113158

### Check BBM and probable causes:

- ARMS relay open circuit
- Faulty ARMS relay

**Note:** If one of the mentioned messages appears, stop the bus in the next station and call to the service center.

# 14 If something happens

---

## Service Switch

There is a switch in the Electrical Center compartment (with a lock symbol) that needs to be activated when the MCM is being programmed.



T1008543

If this switch is activated, the start is disable and an indicator is displayed in the cluster.

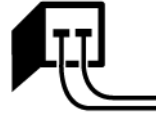

T0014716

## Jump start ground connection

A stud for jump start was placed in the Starter Batteries compartment.

On the hatch of the compartment there is a decal with instructions for jump start in three languages.

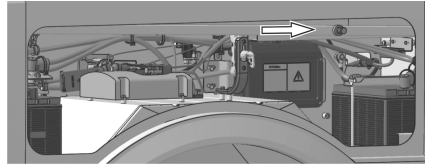

T3113156

Ground connection

# 16 If something happens

## Jump start procedure

For jump start batteries, proceed as follows:

- 1 Place the ignition switch in **0** position
- 2 Make sure the donor batteries have **24 V** total voltage or **24 V** voltage on the system
- 3 Turn **OFF** the engine on the assistance vehicle and make sure the vehicles do not touch each other
- 4 Open the consumer batteries compartment.
- 5 Connect one of the red cable end to the positive terminal of the donor battery. The positive terminal is marked in red, **P** or +
- 6 Connect the other red cable clamp to the positive terminal of the dead batteries. The positive terminal is marked in red, **P** or +
- 7 Connect one of the black cable end to the negative terminal of the donor battery marked in black, **N** or -
- 8 Connect the other black cable end to a ground stud
- 9 Start the engine of the assistance vehicle. Let the engine run, at approximately **1000 rpm**
- 10 Start engine of dead vehicle. Disconnect the black cable from the ground stud. Disconnect the other end of the black cable
- 11 Disconnect the clamp on the black cable from the ground terminal
- 12 Disconnect the cable end on the black cable from the negative terminal on the donor batteries.
- 13 Disconnect the red cable.

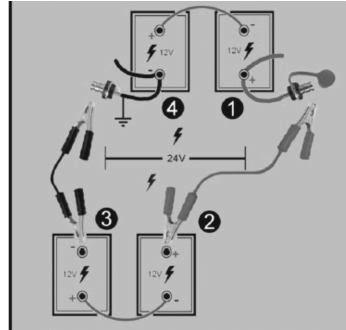

T3113157

- 1 Red on dead
- 2 Red on donor
- 3 Black on donor
- 4 Black on dead

12 V Fuse holders. .... 11

## A

A chassis fuse box. .... 10  
 ARMS (Automatic Reset  
 Main Switch)..... 9  
 ARMS (Automatic Reset  
 Main Switch). .... 9

## B

Batteries charger  
 specification..... 6  
 Battery charger ..... 6  
 Battery charger. .... 6  
 Battery charging time. .... 8

## C

Charging mode. .... 7  
 Chassis fuse box front..... 11  
 Check BBM ..... 13  
 Consumer batteries  
 compartment..... 11  
 Consumer batteries  
 compartment..... 11

## D

Driver's responsibility. .... 1

## G

General Information..... 3

## H

High Voltage / Consumer  
 Batteries..... 12  
 High Voltage / Starter  
 Batteries..... 13

## I

I START Fault..... 12

If something happens ..... 14  
 If something happens..... 14  
 Introduction ..... 1

## J

Jump start batteries  
 procedure..... 16  
 Jump start procedure..... 15

## L

Labels..... 3  
 Low voltage / Consumer  
 Batteries..... 12

## O

Overview..... 2  
 Overview..... 2

## P

Power relays..... 4

## S

Safety information. .... 5  
 Schematics..... 5  
 Service Switch. .... 14  
 Starter batteries  
 compartment..... 10  
 Starter batteries  
 compartment..... 10  
 Supply voltage below 24  
 V ..... 13

## T

The battery main switch. .... 10

## V

Vehicle messages and  
 symbols..... 12

**VOLVO**

**Volvo Bus Corporation**

Göteborg, Sweden