

SECTION 11: REAR AXLES

CONTENTS

- 1. DRIVE AXLE 2**
 - 1.1 DESCRIPTION..... 2
 - 1.2 DCDL (DRIVER-CONTROLLED MAIN DIFFERENTIAL LOCK) 2
 - 1.3 DRIVE AXLE LUBRICATION 2
 - 1.4 MAINTENANCE 3
 - 1.4.1 *Checking and Adjusting the Oil Level* 3
 - 1.4.2 *Draining and Replacing the Oil* 3
 - 1.4.3 *Speed Sensors (Anti-Lock Brake system, ABS)* 4
 - 1.5 REMOVAL AND REINSTALLATION 4
 - 1.6 DISASSEMBLY AND REASSEMBLY 4
 - 1.7 GEAR SET IDENTIFICATION 5
 - 1.8 ADJUSTMENTS 5
 - 1.9 FASTENER TORQUE CHART 5
 - 1.10 TIRE MATCHING 5
 - 1.11 DRIVE AXLE ALIGNMENT 5
 - 1.11.1 *Procedure* 5
 - 1.12 AXLE SHAFT SEALING METHOD..... 7
- 2. TAG AXLE 7**
 - 2.1 UNLOADING TAG AXLE 7
 - 2.2 RETRACTING TAG AXLE..... 7
 - 2.3 RETRACTING TAG AXLE FOR REPAIR PURPOSES..... 8
 - 2.4 GREASE LUBRICATED WHEEL BEARINGS..... 8
 - 2.5 REMOVAL AND INSTALLATION 8
 - 2.5.1 *Removing Tag Axle Only*..... 8
 - 2.5.2 *Removing Tag Axle Along With Suspension Components*..... 8
 - 2.6 TAG AXLE ALIGNMENT..... 9
- 3. SPECIFICATIONS..... 10**

ILLUSTRATIONS

- FIGURE 1: DRIVE AXLE 2
- FIGURE 2: DIFFERENTIAL ASSEMBLY 2
- FIGURE 3: DRIVER-CONTROLLED DIFFERENTIAL LOCK 2
- FIGURE 4: DIFFERENTIAL HOUSING BOWL 3
- FIGURE 5: JACKING POINTS ON FRAME 4
- FIGURE 6: JACKING POINTS ON DRIVE AXLE 4
- FIGURE 7: FRONT & DRIVE AXLE ALIGNMENT 6
- FIGURE 8: TAG AXLE ALIGNMENT..... 6
- FIGURE 9: AXLE SHAFT INSTALLATION 7
- FIGURE 10: TORQUE SPECIFICATION 7
- FIGURE 11: JACKING POINTS ON TAG AXLE 9

Section 11: REAR AXLES

1. DRIVE AXLE

1.1 DESCRIPTION

The Meritor drive axle is equipped with a single reduction standard carrier mounted in front of the axle housing. The carrier consists of a hypoid drive pinion, a ring gear set and gears in the differential assembly.

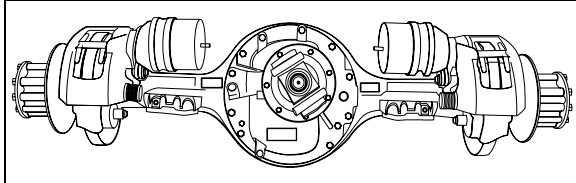

FIGURE 1: DRIVE AXLE

11019

A straight roller bearing (spigot) is mounted on the head of the drive pinion. All other bearings in the carrier are tapered roller bearings. When the carrier operates, there is a normal differential action between the wheels all the time.

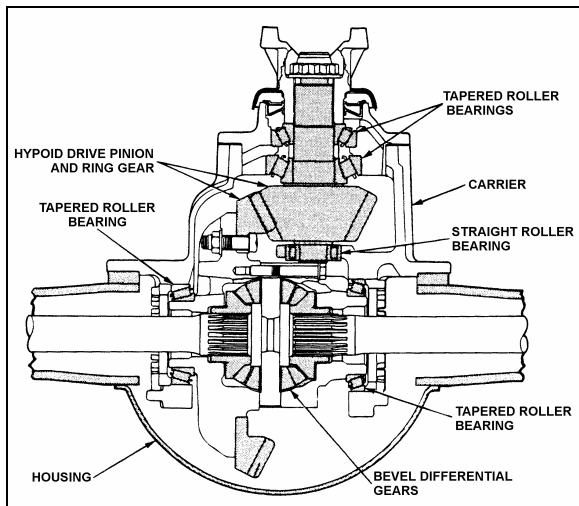

FIGURE 2: DIFFERENTIAL ASSEMBLY

11024

Several speed ratios are available for the drive axle. These ratios depend upon the motor and transmission. Also, special applications may suggest slightly different gear ratios.

1.2 DCDL (DRIVER-CONTROLLED MAIN DIFFERENTIAL LOCK)

Meritor Single-reduction carriers with driver-controlled main differential lock (DCDL) have the same type of gears and bearings as the standard-type carriers. The differential lock is operated by an air actuated shift assembly that is mounted on the carrier.

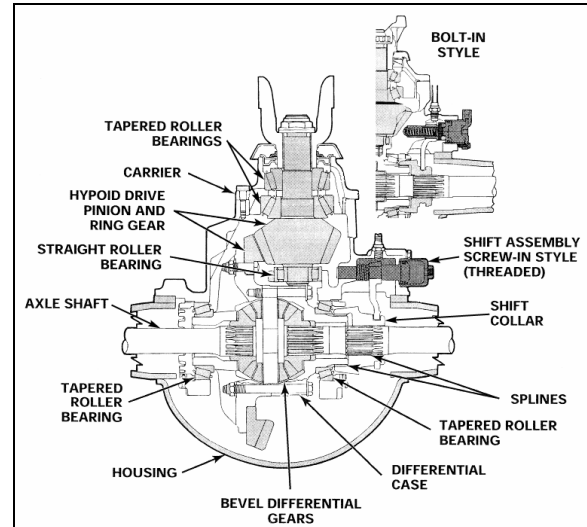

FIGURE 3: DRIVER-CONTROLLED DIFFERENTIAL LOCK

11028

1.3 DRIVE AXLE LUBRICATION

Additional lubrication information is covered in the Meritor Technical Bulletin TP-9539: "Approved Rear Drive Axle Lubricants" annexed to this section. During initial stage of normal operation, tiny metal particles originating from moving parts can be found on mating surfaces. These particles are carried by the lubricant through the assembly and act as lapping compound, which accelerates wear of all parts. To ensure maximum life of the differential and prevent premature failure, the original "factory fill" lubricant should be drained. Change break-in oil before 3,000 miles (4 800 km) of initial operation (drain the unit while it is still warm from operation), in accordance with the lubrication and servicing schedule.

Change differential oil and clean the breathers, magnetic fill and drain plugs, every 100,000 miles (160 000 km) or once every two years, whichever comes first.

Use Multigrade gear oil MIL-L-2105-D. Use the 75W90-gear oil for northern climates and the 80W140 for southern climates. In extreme conditions, or for better performance, fill with synthetic gear oil. Check oil level and add (if necessary) every 6,250 miles (10 000 km) or twice a year, whichever comes first (Fig. 4).

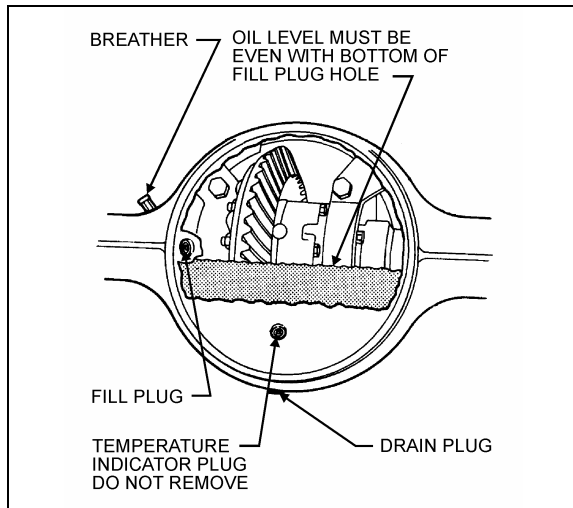

FIGURE 4: DIFFERENTIAL HOUSING BOWL 11007

1.4 MAINTENANCE

Proper vehicle operation begins with preventive maintenance, such as good differential use. The most common types of drive axle carrier failures are spinout, shock, fatigue, overheating and lubrication. Avoid neglecting these points since they would be the first steps to improper maintenance, expensive repairs, and excessive downtime.

Inspect the pinion oil seal, axle shaft flange and carrier housing gaskets for evidence of lubricant leakage. Tighten the bolts and nuts, or replace the gaskets and seals to correct leaks. Maintenance of the axle mountings consists primarily in a regular and systematic inspection of the air suspension units and radius rods, as directed in Section 16, "Suspension".

1.4.1 Checking and Adjusting the Oil Level

DANGER

Before servicing, park safely over a repair pit, apply parking brake, stop engine and set battery master switch to the "OFF" position.

1. Make sure the vehicle is parked on a level surface.

WARNING

Check the oil level when the axle is at room temperature. When hot, the oil temperature may be 190°F (88°C) or more and can cause burns. Also, a correct reading is not obtained when the axle is warm or hot.

2. Make sure the axle is "cold" or at room temperature.
3. Clean the area around the fill plug. Remove the fill plug from the differential axle housing bowl (Fig. 4).
4. The oil level must be even with the bottom of the hole of the fill plug.
 - a. If oil flows from the hole when the plug is loosened, the oil level is high. Drain the oil to the correct level.
 - b. If the oil level is below the bottom of the hole of the fill plug, add the specified oil.
5. Install and tighten the fill plug to 35-50 lbf-ft (48-67 Nm).

1.4.2 Draining and Replacing the Oil

DANGER

Before servicing, park safely over a repair pit, apply parking brake, stop engine and set battery master switch to the "OFF" position.

1. Make sure the vehicle is parked on a level surface. Put a large container under the axle's drain plug.

NOTE

Drain the oil when the axle is warm.

2. Remove the drain plug from the bottom of the axle. Drain and discard the oil in an environment friendly manner.
3. Install and tighten the drain plug to 35-50 lbf-ft (48-67 Nm).
4. Clean the area around the fill plug. Remove the fill plug from the differential housing bowl.
5. Add the specified oil until the oil level is even with the bottom of the hole of the fill plug. Allow the oil to flow through the axle and check the oil level again (lube capacity 41 pints [13,3 liters]).

CAUTION

The differential overheats when the oil temperature rises above 250°F (120°C).

6. Install and tighten the fill plug to 35-50 lbf-ft (48-67 Nm).

Section 11: REAR AXLES

1.4.3 Speed Sensors (Anti-Lock Brake system, ABS)

For removing and installing the drive axle speed sensors (for anti-lock brake systems, ABS), refer to Section 12: "Brake and Air System" and to Rockwell WABCO Maintenance Manual: "Anti-Lock Brake Systems For Trucks, Tractors and Buses", annexed at the end of section 12.

1.5 REMOVAL AND REINSTALLATION

The following procedure deals with the removal of the drive axle assembly and its attachments as a unit. The method used to support the axle during removal and disassembly depends upon local conditions and available equipment.

1. Raise vehicle by its jacking points on the body (fig. 5 or see Section 18, "Body" under heading "Vehicle Jacking Points"). Place jack stands under frame. Remove drive axle wheels (if required, refer to Section 13, "Wheels, Hubs And Tires".

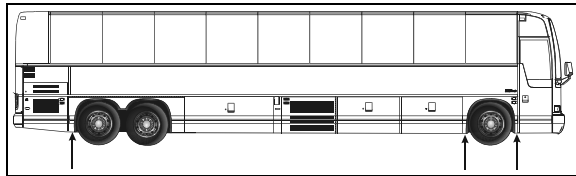

FIGURE 5: JACKING POINTS ON FRAME 18618

2. Exhaust compressed air from the air supply system by opening the drain cock on each air reservoir.
3. Disconnect the propeller shaft as directed in Section 9, "Propeller Shaft", in this manual.
4. On both sides of the vehicle, unscrew fasteners retaining front wheel housing plastic guards, and remove them from vehicle.
5. Disconnect both height control valve links from air spring mounting plate brackets then move the arm down to exhaust air suspension.
6. Remove cable ties securing the ABS cables (if vehicle is so equipped) to service brake chamber hoses. Disconnect the ABS cable plugs from the drive axle wheel hubs.

NOTE

When removing drive axle, if unfastening cable ties is necessary for ease of operation, remember to replace them afterwards.

7. Disconnect the brake chamber hoses.

NOTE

Position the hoses so they will not be damaged when removing the axle.

8. Install jacks under the axle jacking points to support the axle weight (refer to figure 6).

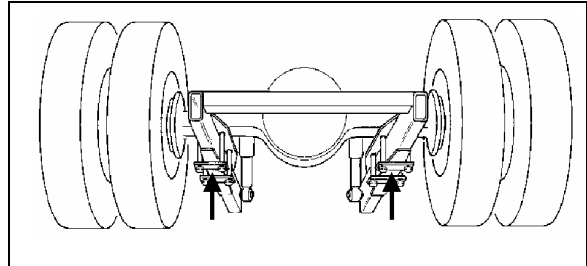

FIGURE 6: JACKING POINTS ON DRIVE AXLE 11005

9. Remove the four shock absorbers as outlined in Section 16, "Suspension" under heading "Shock Absorber Removal".
10. Remove the sway bar.
11. Remove the lower and upper longitudinal radius rod supports from vehicle sub-frame as outlined in Section 16, "Suspension", under heading "Radius Rod Removal".
12. Remove the transversal radius rod support from the vehicle sub-frame.
13. Remove the two retaining nuts from each of the four air bellows lower mounting supports.
14. Use the jacks to lower axle. Carefully pull away the jacks axle assembly from underneath vehicle.
15. Reverse removal procedure to reinstall drive axle.

NOTE

Refer to Section 16, "Suspension" for suspension components' proper tightening torques.

NOTE

Refer to section 13 "Wheels, Hubs And Tires" for correct wheel bearing adjustment procedure.

1.6 DISASSEMBLY AND REASSEMBLY

Disassembly and re-assembly procedures are covered under applicable headings in Meritor's "MAINTENANCE MANUAL, NO. 5", annexed to this section.

1.7 GEAR SET IDENTIFICATION

Gear set identification is covered under applicable heading in Meritor's "MAINTENANCE MANUAL NO. 5", annexed to this section.

1.8 ADJUSTMENTS

Adjustments are covered under applicable headings in Meritor's "MAINTENANCE MANUAL NO. 5", annexed to this section.

1.9 FASTENER TORQUE CHART

A differential fastener torque chart is provided in Meritor's "MAINTENANCE MANUAL NO. 5", annexed to this section.

1.10 TIRE MATCHING

Drive axle tire matching is covered under the applicable heading in Section 13, "Wheels, Hubs And Tires" in this manual.

1.11 DRIVE AXLE ALIGNMENT

NOTE
For drive axle alignment specifications, refer to paragraph 3: "Specifications" in this section.

The drive axle alignment consists in aligning the axle according to the frame. The axle must be perpendicular to the frame. The alignment is achieved with the use of shims inserted between the lower longitudinal radius rod supports and the frame.

Drive axle alignment is factory set and is not subject to any change, except if the vehicle has been damaged by an accident or if there are requirements for replacement.

DRIVE AXLE ALIGNMENT

- With the system installed as in figure 7, adjust drive axle according to specifications' chart below.

DRIVE AXLE ALL VEHICLES			
Alignment / value	Minimum value	Nominal value	Maximum value
Thrust angle (deg.)	-0.04	0	0.04
Total Toe (deg.)	0.18 Toe-in	0	0.18 Toe-out

TAG AXLE ALIGNMENT

- Remove and reinstall all wheel mount sensors on the drive and tag axles (fig. 8);

If the axle has been removed for repairs or servicing and if all the parts are reinstalled exactly in the same place, the axle alignment is not necessary. However, if the suspension supports have been replaced or altered, proceed with the following instructions to verify or adjust the drive axle alignment.

NOTE
When drive axle alignment is modified, tag axle alignment must be re-verified.

1.11.1 Procedure

1. Park vehicle on a level surface, then chock front vehicle wheels.
2. Using two jacking points (which are at least 30 inches [76 cm] apart) on drive axle, raise the vehicle sufficiently so that wheels can turn freely at about 1/2 inch from ground. Secure in this position with safety stands, and release parking brake.
3. Install wheel mount sensors on front end and drive axle wheels (fig. 7).

NOTE
See reference numbers on wheel mount sensors (fig.7).

NOTE
Select axle specifications in the appropriate chart

Section 11: REAR AXLES

NOTE

For an accurate alignment, the tag axle must be aligned with the drive axle.

NOTE

Reinstall wheel mount sensors as shown in figure 8.

- Adjust tag axle according to specifications' chart below in reference with drive axle.

TAG AXLE ALL VEHICLES			
Alignment / value	Minimum value	Nominal value	Maximum value
Parallelism (deg.)	-0.02	0	0.02
Total Toe (deg.)	0.18 Toe-in	0	0.18 Toe-out

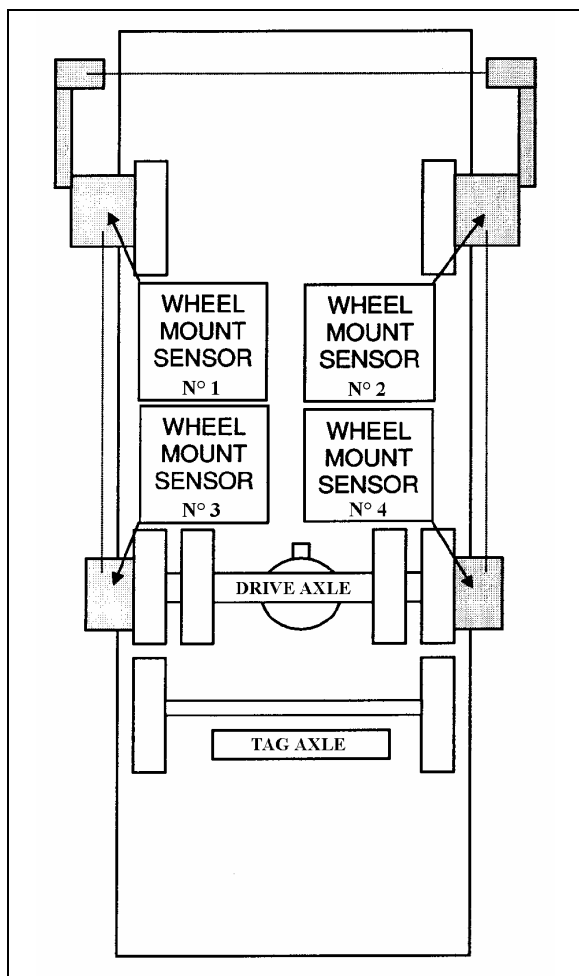

FIGURE 7: FRONT & DRIVE AXLE ALIGNMENT 11025

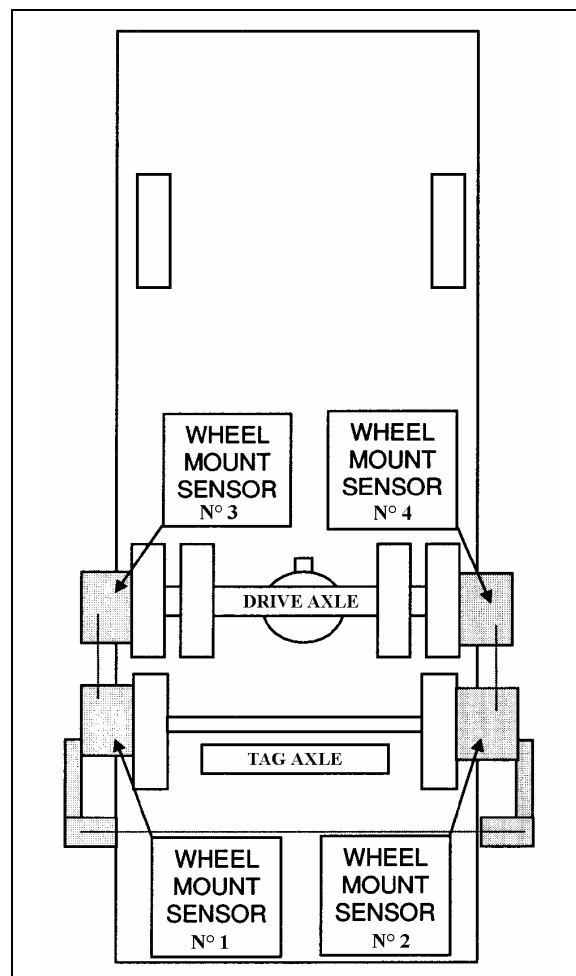

FIGURE 8: TAG AXLE ALIGNMENT 11026

NOTE

Refer to Section 16, "Suspension", for proper torque tightening of the longitudinal radius rod support nuts.

NOTE

When the drive alignment is changed, the tag alignment must also be adjusted.

1.12 AXLE SHAFT SEALING METHOD

The following method is to be used to ensure that axle shaft installation is fluid-tight:

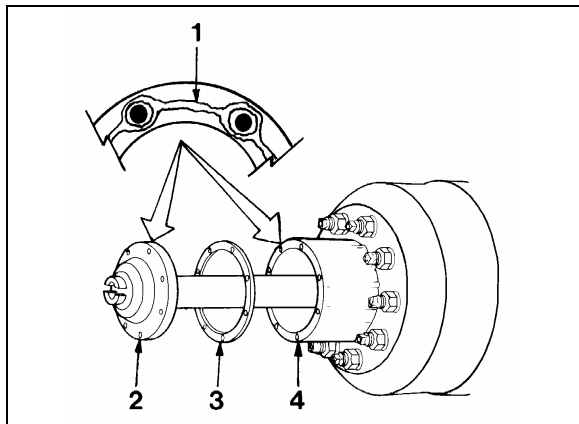

FIGURE 9: AXLE SHAFT INSTALLATION 11003

- 1 Silicone sealant*
- 2 Axle shaft
- 3 Gasket
- 4 Wheel hub

1. Clean the mounting surfaces of both the axle shaft flange and wheel hub where silicone sealant will be applied. Remove all old silicone sealant, oil, grease, dirt and moisture. Dry both surfaces.
2. Apply a continuous thin bead of silicone sealant* (Prévost P/N 680053) on the mounting surfaces and around the edge of all fastener holes of both the axle shaft flange and wheel hub.

* GENERAL ELECTRIC Silicone Rubber Adhesive Sealant RTV 103 Black.

WARNING

Carefully read cautions and instructions on the tube of silicone sealant and its packing.

3. Assemble components immediately to permit the silicone sealant to compress evenly between parts.
 - a. Place a new gasket and then install the axle shaft into the wheel hub and differential carrier. The gasket and flange of the axle shaft must fit flat against the wheel hub.
 - b. Install the tapered dowels at each stud and into the flange of the axle shaft. Use a punch or drift and hammer if needed.

- c. Install the lock washers and nuts on the studs. Tighten nuts to the correct torque value.

NOTE

Torque values are for fasteners that have a light application of oil on the threads (refer to Meritor Maintenance Manual).

9/16-18 plain nut: 110 - 165 lbf-ft (149 -224 Nm)

5/8-18 plain nut: 150 - 230 lbf-ft (203 - 312 Nm)

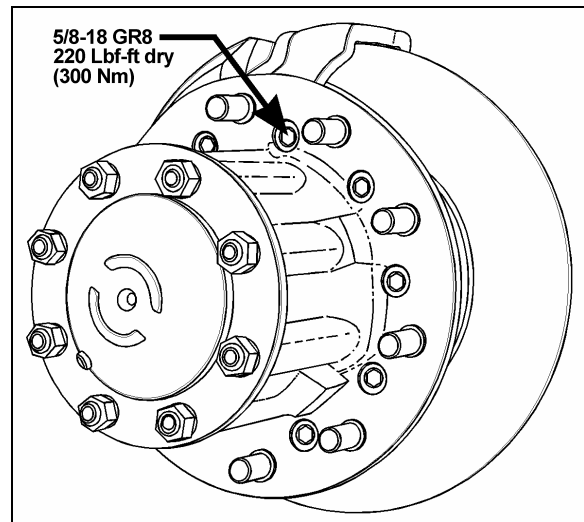

FIGURE 10: TORQUE SPECIFICATION

2. TAG AXLE

The tag axle is located behind the drive axle. It carries a single wheel and tire on each side.

2.1 UNLOADING TAG AXLE

To reduce the turning radius, the air springs pressure will be automatically reduced by 75% when the coach is moving at speed lower than 5 mph (8 km/h) and with more than 1½ turn from the steering.

2.2 RETRACTING TAG AXLE

The standard tag axle retraction system is controlled by a valve located on the right lateral console and enables unloading and raising the tag axle (refer to the "OPERATOR'S MANUAL" for location of controls). This system has been designed for the following purposes:

1. Shortening of wheelbase, thus allowing tighter turning in tight maneuvering areas such as parking lots or when making a sharp turn.

Section 11: REAR AXLES

2. Transferring extra weight and additional traction to the drive wheels on slippery surfaces.

The tag axle service brakes operate only when the axle is in normal driving (loaded) position.



CAUTION

Do not use tag axle in raised position for an extended period. Raising tag axle increases load on the drive axle, suspension and tires.

Do not drive vehicle with tag axle raised when speed is exceeding 9mph (15 km/h).

In order to prevent damage to the suspension, always raise the tag axle before lifting the coach.

2.3 RETRACTING TAG AXLE FOR REPAIR PURPOSES

- Connect an external air pressure line to the emergency fill valve in the engine compartment.
- Lift the axle by pushing the lever forward.



WARNING

Install a protective cover to prevent unfortunate lever operation while work is being carried out under the vehicle.

- Raise the vehicle using the lifts.



WARNING

Lift manufacturers recommend lowering the vehicle to the ground or installing some safety stands before activating the suspension to prevent the lifts from becoming unstable.

- For added safety, install nylon slings over tag axle shock absorbers.

2.4 GREASE LUBRICATED WHEEL BEARINGS

The unitized hub bearings used on the NDS range of axles, are non-serviceable items. Bearings are pre-adjusted, lubricated and have seals fitted as part of the manufacturing process. The bearings are greased for life and there is no need or facility for re-lubrication

Front and tag axle hub bearings need to be checked every 30,000 miles (48 000 km).

NOTE

For more information on front and tag axle wheel hub, refer to "DANA SPICER Maintenance Manual Model NDS and Maintenance Manual NDS Axles" annexed at the end of this Section.

2.5 REMOVAL AND INSTALLATION

2.5.1 Removing Tag Axle Only

The following procedure deals with the removal of the tag axle while keeping the air springs installed. The method used to support the axle and suspension components during removal and disassembly depends upon local conditions and available equipment.

- Connect an external air pressure line to the emergency fill valve in the engine compartment.
- Lift the axle by pushing the lever forward.



WARNING

Install a protective cover to prevent unfortunate lever operation while work is being carried out under the vehicle.

- Disconnect tag axle air springs pneumatic hoses and install valves or plugs.
- Raise the vehicle using the lifts.
- Dismount tag axle components.
- Before reinstalling air spring hoses, make sure there is no pressure left inside by opening the valves or unloading tag axle.

2.5.2 Removing Tag Axle Along With Suspension Components

The following procedure deals with the removal of the tag axle assembly along with the suspension components. The method used to support the axle and suspension components during removal and disassembly depends upon local conditions and available equipment.

1. Raise vehicle by its jacking points on the body (fig. 5 or see Section 18, "Body" under heading: "Vehicle Jacking Points"). Place jack under frame. Remove drive axle wheels (if

required, refer to Section 13, "Wheels, Hubs And Tires").

2. Exhaust compressed air from the air supply system by opening the drain cock on each air reservoir and deplete air bags by moving leveling valve arm down.
3. Install jacks under tag axle jacking points to support the axle weight (refer to figure 11).

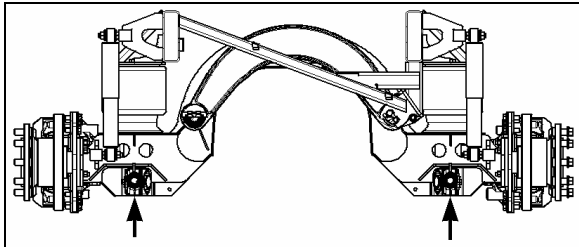

FIGURE 11: JACKING POINTS ON TAG AXLE 11029

4. Disconnect tag axle lifting chain collars from lower longitudinal radius rods.
5. Remove the propeller shaft as directed in Section 9, "Propeller Shaft", in this manual.
6. Disconnect the tag axle brake chamber hoses.



CAUTION

Position the hoses so they will not be damaged when removing axle.

7. Disconnect hose from the air spring upper mounting plate.
8. Remove the two shock absorbers as outlined in Section 16, "Suspension", under "Shock Absorber Removal".
9. Disconnect the lower longitudinal radius rods as outlined in Section 16, "Suspension", under "Radius Rod Removal".
10. Disconnect the transversal radius rod.
11. Disconnect the upper longitudinal radius rod.
12. Remove the air bellows retaining nuts from each of the two upper mounting plates.
13. Use the jacks to move the axle forward to clear the axle off the transmission. Lower the axle.



CAUTION

On vehicles equipped with an automatic transmission (with or without the output retarder), move tag assembly very carefully. Pay special attention to the U-shaped section, as the transmission end components may be easily damaged through a false maneuver.

14. Reverse removal procedure to reinstall tag axle.

NOTE

Refer to Section 16, "Suspension", for proper torque tightening of suspension components.

NOTE

Refer to section 13 "Wheels, Hubs And Tires" for correct wheel bearing adjustment procedure.

2.6 TAG AXLE ALIGNMENT

The tag axle alignment consists in aligning the tag axle parallel to the drive axle position. Before aligning the tag axle, proceed with the drive axle alignment (paragraph 1.11). Tag axle alignment is achieved with the use of shims inserted between the lower longitudinal radius rod supports and axle. Tag axle alignment is factory set and is not subject to any change, except if vehicle has been damaged by an accident or if there are requirements for parts replacement.



CAUTION

If this setting is altered significantly, it will cause excessive tire wear.

NOTE

It may be necessary to adjust the axle TOE as well as its alignment. In this case, insert shims (7 min. - P/N 121203 or 15 min. - P/N 121240) in between mounting plate and spindle, as required.

If axle has been removed for repair or servicing and if all parts are reinstalled exactly in their previous locations, axle alignment is not necessary. However, if the suspension supports have been replaced or have changed position, proceed with the following instructions to verify or adjust the tag axle alignment.

Section 11: REAR AXLES

3. SPECIFICATIONS

Drive Axle

MakeMeritor
Drive track..... 76.7 inches (1 949 mm)
Gear typeHypoid
Axle type Full floating
Lube capacity41 pints (19,3 liters)

Drive axle ratio

World Transmission

4.30:1 Standard
4.10:1 Optional
4.56:1 Optional
4.88:1 Optional

ZF Transmission

3.73:1 Standard
3.42:1 Optional
3.58:1 Optional

NOTE

The drive axle alignment consists in aligning the axle with reference to the frame. The axle must be perpendicular to the frame.

Tag Axle

MakePrévost
Rear track 83.6 inches (2 124 mm)
Axle type Dana Spicer Europe TS8U Hub Unit

NOTE

The tag axle alignment consists in aligning the tag axle parallel to the drive axle.