

PREVOST

COACH MANUFACTURER

MAINTENANCE MANUAL

LE MIRAGE XLII
BUS SHELLS



PA1564

(1ST EDITION)

PA1564 1st edition
Date: July, 2007
Starting from vehicle: 8-9277
Featuring: DDC S60-2007 engine with Aftertreatment System

SECTION 00: GENERAL INFORMATION

CONTENTS

1. FOREWORD.....	2
2. SCHEMATICS	2
3. PRECAUTIONS TO BE OBSERVED BEFORE WELDING	2
4. SAFETY NOTICE	4
4.1 DATA PLATES AND CERTIFICATIONS	4
4.1.1 Engine	4
4.1.2 Transmission	5
4.1.3 Drive Axle	5
4.1.4 Front Suspension	5
4.1.5 Power Steering Pump	5
4.1.6 Coach Final Record.....	5
4.1.7 Safety Certification	5
4.1.8 DOT Certification Label.....	6
4.1.9 EPA Engine Label	6
4.1.10 Fuel Tank Label.....	6
4.1.11 Vehicle Identification Number (VIN).....	6
5. FASTENER STRENGTH IDENTIFICATION.....	8
5.1 SELF-LOCKING FASTENERS.....	9
5.2 RECOMMENDATIONS FOR REUSE	9
5.3 SIX LOBED SOCKET HEAD	9

ILLUSTRATIONS

FIGURE 1 : DETROIT DIESEL SERIES 60.....	5
FIGURE 2: ALLISON TRANSMISSION	5
FIGURE 3: TYPICAL SERIAL & MODEL NUMBERS.....	5
FIGURE 4: ISS TYPICAL SERIAL & MODEL NUMBERS	5
FIGURE 5 : POWER STEERING PUMP NAMEPLATE.....	5
FIGURE 6: DOT CERTIFICATION PLATE	6
FIGURE 7 : ENGINE COMPARTMENT	6
FIGURE 8 : VEHICLE I.D.....	6
FIGURE 9 : VEHICLE IDENTIFICATION NUMBER	7
FIGURE 10 : THREAD NOTATION	8
FIGURE 11: BOLT STRENGTH MARKINGS	8
FIGURE 12 : SELF-LOCKING FASTENERS	9
FIGURE 13: METRIC - US STANDARD CONVERSION TABLE.....	10
FIGURE 14: CONVERSION CHART	11

1. FOREWORD

This manual includes procedures for diagnosis, service, maintenance and repair for components of the XLII series bus shell models as listed on the front cover page. This manual should be kept in a handy place for ready reference by the technician. If properly used, it will meet the needs of the technician and owner.

Information provided in Section 1 through 26 pertains to standard equipment items, systems and components as well as the most commonly used optional equipment and special equipment offered on the bus shell models covered by this manual. At the beginning of each section: a Table of Contents and a list of illustrations give the page number on which each subject begins and where each figure is located. Coach operating information is provided in a separate Owner's Manual. Audio/Video system operator instructions are also included in a separate manual.

More specific information on engine and transmission operating, maintenance, and overhaul information is contained in the applicable engine or transmission service manual published by the engine or transmission manufacturer. Engine and transmission parts information is contained in the applicable engine or transmission parts catalog published by the engine or transmission manufacturer. All information, illustrations and specifications contained in this manual are based on the latest product information available at the time of publication approval. The right is reserved to make product changes at any time without notice.

NOTE

Typical illustrations may be used; therefore minor illustration difference may exist when compared to actual parts or other publications.

Prévost Car occasionally sends Maintenance Information, Warranty Bulletins, Safety Recalls or other literature to update users with the latest service procedures. They are issued, when required, to supplement or supersede information in this manual. Update sheet should be filled out and bulletins should be filed at the end of their respective section for future reference.

2. SCHEMATICS

Vehicle AIR SCHEMATICS are provided at the end of Section 12, "Brake". SUSPENSION AIR SCHEMATICS are provided at the end of Section 16, "Suspension". Moreover, ELECTRICAL SCHEMATICS are provided in the technical publications box. Refer to those schematics for detailed circuit information or during diagnosis.

3. PRECAUTIONS TO BE OBSERVED BEFORE WELDING



CAUTION

Precautions are to be observed before welding to minimize the risk of major and costly damage caused to the vehicle electronic components.

NOTE

For XLII Multiplex vehicles, also execute procedure no: PR060034 "MULTIPLEX MODULES DISCONNECTION PROCEDURE PRIOR TO WELDING" included at the end of this section.



CAUTION

Cover electronic control components and wiring to protect from hot sparks, etc.



CAUTION

Position welding machine ground clamp as close as possible to the work. Ensure that the welding machine ground return clamp is well secured and makes a good electrical contact with a large metallic area of the chassis located as close as possible to the welding point.



CAUTION

Do not use TIG welding process on the vehicle. This high frequency current process can seriously damage the electronic components.

STEEL – STEEL WELDING

CAUTION
Before welding, disconnect electronic modules and battery terminals.
<i>NOTE</i>
Welding surfaces must be free of scale, slag, rust, paint, grease, humidity or other foreign material that would render welding impossible.

DANGER
Only a qualified and experienced person must do welding.

- FCAW (Flux Cored Arc Welding) process ;
- Electrode wire conforms to A5.20 AWS (American Welding Society) specifications ;
- E4801T-9-CH, type electrode wire with 0,045“ diameter (1,14 mm) ;

Material Thickness	Voltage	Current	Wire Feed Rate	Shielding Gas
1/8” to ½”	26 ± 2 volts	260 Amps	450 ipm. approx.	75% argon – 25% CO2 or 100% CO2

If necessary and with great care to prevent perforating the material, it is possible to use a conventional electric arc welding machine according to the following specifications:

- SMAW (Shielded Metal-Arc Welding) process ;
- Welding rod conforms to A5.1 of AWS (American Welding Society) specifications; E 7018 type welding rod with 1/8” diameter (3,2 mm).
- Current: 100 amperes to 150 amperes; optimum at 120 amps.

It is important to grind weld bead starts and stops and also to grind arc strikes from surfaces.

STEEL - STAINLESS STEEL OR STAINLESS STEEL - STAINLESS STEEL WELDING

CAUTION
Before welding, disconnect electronic modules and battery terminals.
<i>NOTE</i>
Welding surfaces must be free of scale, slag, rust, paint, grease, humidity or other foreign material that would render welding impossible.

DANGER
Only a qualified and experienced person must do welding.

- GMAW (Gas Metal-Arc Welding) process;
- Welding wire conforms to AWS (American Welding Standards) A5.9 specifications;
- 308LSi type welding wire with 0.035" diameter (0,9 mm);

STEEL - STAINLESS STEEL WELDING

Steel Thickness	SS Thickness	Voltage	Current	Wire Feed Rate	Shielding Gas
Less than 1/8”	Any type	20±1.5 volts	130±15 Amps	290 ipm approx.	90% He, 7.5% Ar, 2.5% CO2
1/8” and more	Any type	22±1.5 volts	160±15 Amps	330 ipm approx.	90% He, 7.5% Ar, 2.5% CO2

Section 00: GENERAL INFORMATION

STAINLESS STEEL - STAINLESS STEEL WELDING

SS Thickness	Voltage	Current	Wire Feed Rate	Shielding Gas
Any type	20 ± 1.5 volts	130 ± 15 Amps	290 ipm approx.	90% He – 7.5% Ar, 2.5% CO ₂

If necessary and with great care to prevent perforating the material, it is possible to use a conventional electric arc welding machine according to the following specifications :

- SMAW (Shield Metal-Arc Welding) process;
- Welding rod conforms to AWS (American Welding Standards) A5.4 specifications; 308L-17 type welding rod with 3/32" diameter (2,4 mm);
- Current: - 50 amperes to 90 amperes, optimum at 60 amperes.

It is important to grind weld bead starts and stops and also to grind arc strikes from surfaces.

4. SAFETY NOTICE

This maintenance manual has been prepared in order to assist skilled mechanics in the efficient repair and maintenance of PRÉVOST vehicles.

This manual covers only the procedures as of manufacturing date.

Safety features may be impaired if other than genuine PRÉVOST parts are installed.

Torque wrench tightening specifications must be strictly observed. Locking devices must be installed or replaced by new ones, where specified. If the efficiency of a locking device is impaired, It must be replaced.

This manual emphasizes particular information outlined by the wording and symbols:

 DANGER
Directs the operator's attention to unsafe practices which could result in serious personal injury or death.

 WARNING
Directs the operator's attention to unsafe practices which could result in serious personal injury or severe damage to the vehicle.

 CAUTION
Directs the operator's attention to unsafe practices where personal injury is not likely but damage to vehicle components could occur.

NOTE

Indicates supplementary information essential to the proper operation of the vehicle. Although, the mere reading of such information does not eliminate the hazard, understanding of the information will promote its correct use.

4.1 DATA PLATES AND CERTIFICATIONS

Delay and confusion can be avoided by placing the complete vehicle identification number of the coach and the serial numbers of the engine on parts orders and correspondence. Also, the transmission, axles, power steering pump chassis and other major components are identified by serial numbers.

4.1.1 Engine

The engine serial and model numbers are laser etched on the cylinder block (as viewed from the flywheel end) on the left side just below the fire deck and above the cast-in Detroit Diesel logo (Fig. 1).

In addition, option plates made of laminated paper are located on the rocker cover (starter side). The engine serial and model number and a list of the optional engine equipment are written on the option plate. Refer to this information when ordering replacement parts (Fig. 1).

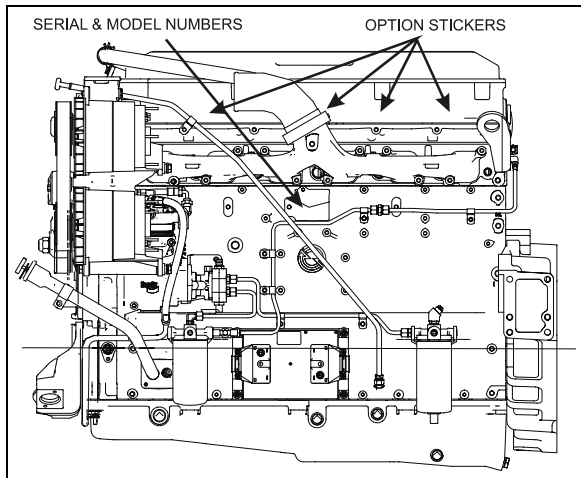

FIGURE 1 : DETROIT DIESEL SERIES 60 00043

4.1.2 Transmission

The transmission identification plate is located on the fluid level dipstick side of the transmission (Fig. 2). The identification plate shows the transmission serial number, part number (assembly number), and model number. Use all three numbers when ordering parts.

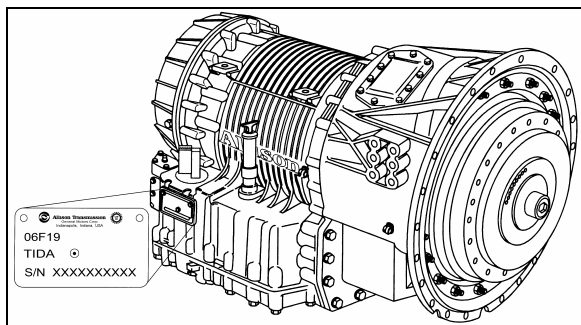

FIGURE 2: ALLISON TRANSMISSION 07139

4.1.3 Drive Axle

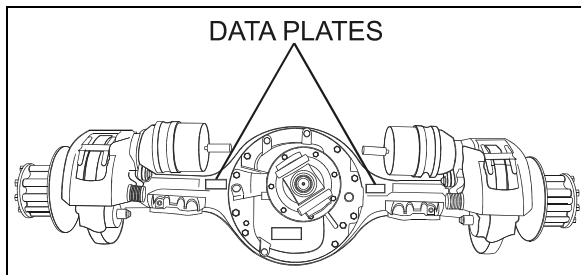

FIGURE 3: TYPICAL SERIAL & MODEL NUMBERS 11019

4.1.4 Front Suspension

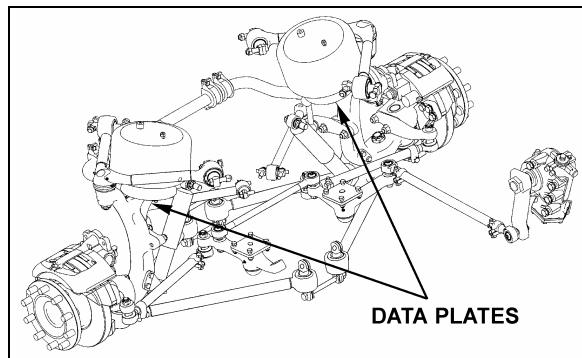

FIGURE 4: ISS TYPICAL SERIAL & MODEL NUMBERS

4.1.5 Power Steering Pump

Power steering pump serial number is located on a tag on the pump (Fig. 5). The pump is mounted on the engine beside the crankshaft pulley.

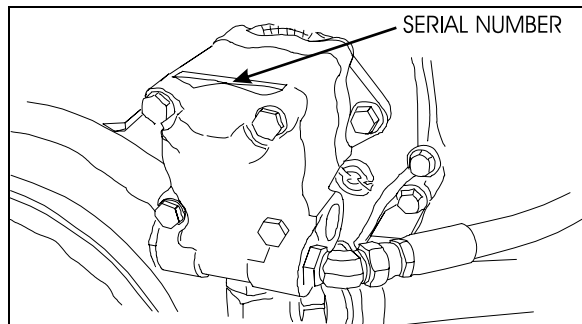

FIGURE 5 : POWER STEERING PUMP NAMEPLATE 00035

4.1.6 Coach Final Record

The Coach Final Record is a record of all data pertaining to the assembly of the coach. This record is included in the technical publication package supplied with the coach. Retain this record in the company records office for reference and safe-keeping.

4.1.7 Safety Certification

Coach components meet specifications and standards as follows:

- Material and parts conform to ASTM and/or SAE standards in effect at the time of manufacture.
- All factory-installed interior materials meet FMVSS 302 for fire resistance.
- Certified according to Provincial, State and Federal Safety standards (Canadian and US) BMCSS, FMVSS, and CMVSS.

Section 00: GENERAL INFORMATION

Other applicable certification labels are affixed to the component.

4.1.8 DOT Certification Label

This certifies that coaches manufactured by Prevost Car Inc., comply with all Federal Motor Vehicle Safety Standards at the time of manufacture. Information such as date of manufacture, model year, gross vehicle weight rating, tire types and inflation pressure is also etched on this plate. The DOT Certification plate is affixed to L.H. control panel.

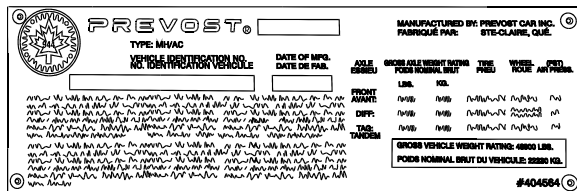

FIGURE 6: DOT CERTIFICATION PLATE 00016

4.1.9 EPA Engine Label

The exhaust emission certification label affixed above the engine certifies that the engine conforms to federal and any state exhaust emission regulations (Fig. 7). It gives the operating conditions under which certification was made.

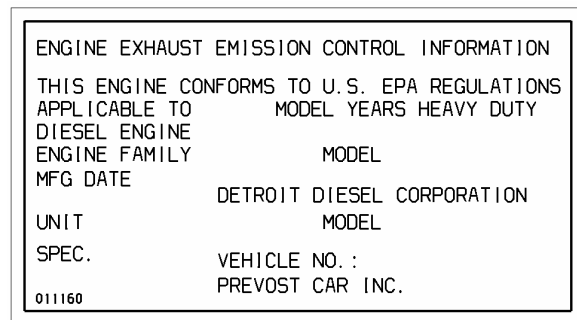

FIGURE 7 : ENGINE COMPARTMENT 00173

4.1.10 Fuel Tank Label

The fuel tank label is molded on the side of the fuel tank. To read this label, unscrew the fuel tank access panel nuts located at the left in the condenser compartment.

4.1.11 Vehicle Identification Number (VIN)

The seventeen digit vehicle identification number (VIN) is located on a plate (Fig. 8 & 9) located on the windshield frame pillar (driver's side). The VIN is visible from the outside of the coach. Make sure the correct vehicle identification number is given when ordering replacement parts. Using the VIN when ordering parts will facilitate processing.

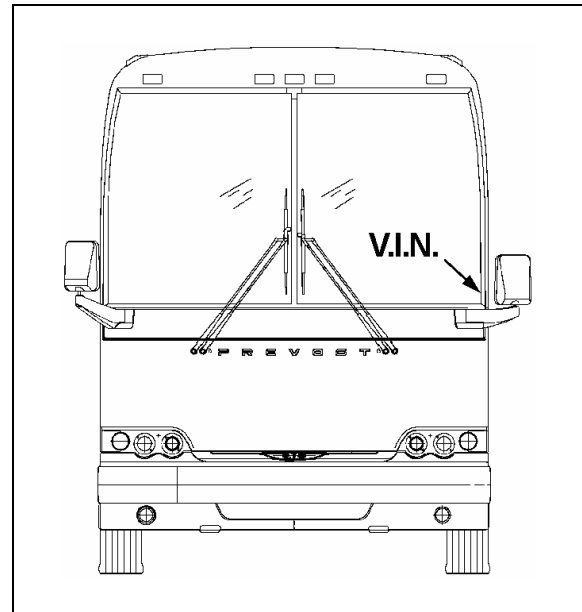

FIGURE 8 : VEHICLE I.D. 00020

NOTE

Record the VIN in the coach documentation and keep with company records. The VIN will normally be used for vehicle registration and for obtaining vehicle insurance coverage.

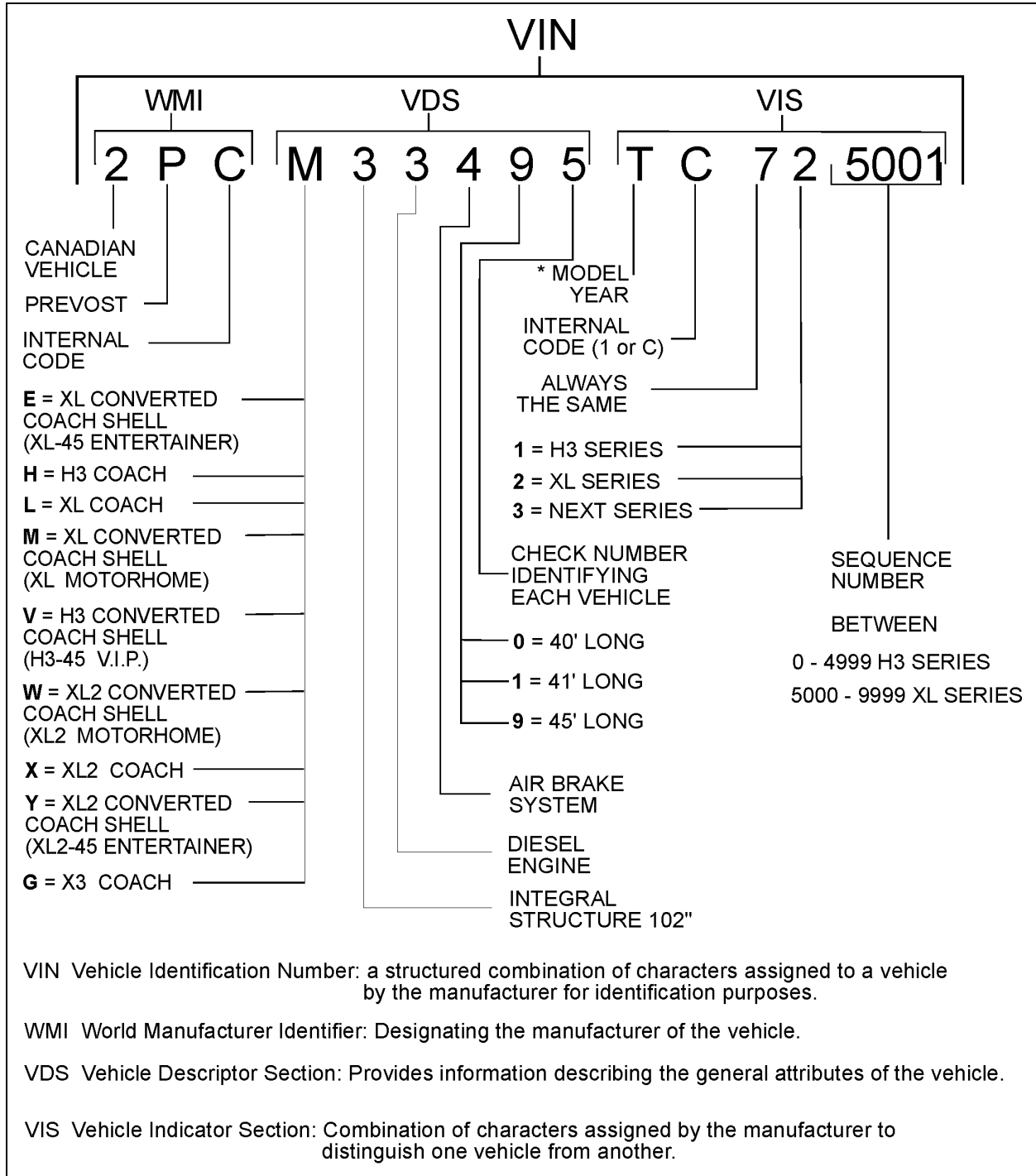

FIGURE 9 : VEHICLE IDENTIFICATION NUMBER

00050

YEAR	CODE	YEAR	CODE
2000	Y	2006	6
2001	1	2007	7
2002	2	2008	8
2003	3	2009	9
2004	4	2010	A
2005	5	2011	B

Section 00: GENERAL INFORMATION

5. FASTENER STRENGTH IDENTIFICATION

Most commonly used metric fastener strength property classes are 9.8 and 10.9 with the class identification embossed on the head of each bolt. Customary (inch) strength classes range from grade 2 to 8 with radial line identification embossed on each bolt head actual grade (i.e., a grade 7 bolt will have 5 embossed radial lines on the bolt head). Some metric nuts will be marked with single digit strength identification numbers on the nut face. Fig. 11 shows the different strength markings. When replacing

metric fasteners, be careful to use fasteners of the same or greater strength than the original fasteners (the same number marking or higher). It is also important to select replacement fasteners of the correct size. Correct replacement fasteners are available through the parts division. Some metric fasteners available in after-market parts sources were designed to metric standards of countries other the United States and may be of a lower strength, may not have the numbered head marking system, and may be of a different thread pitch.

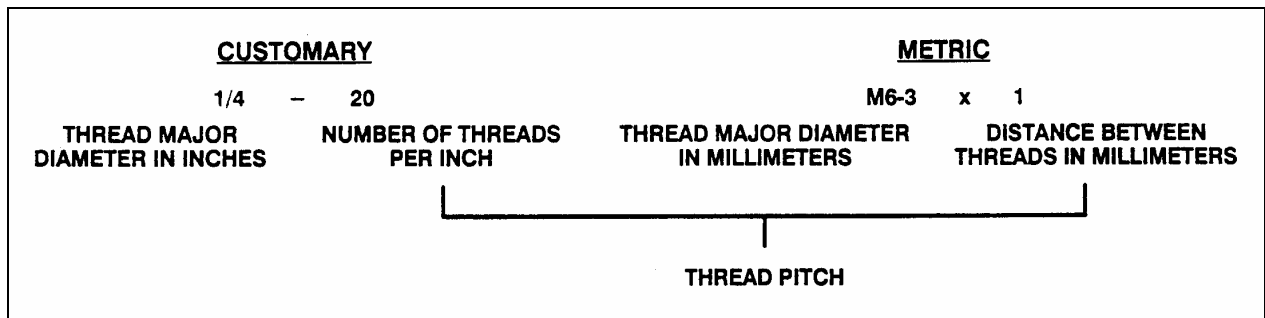

FIGURE 10 : THREAD NOTATION

00002

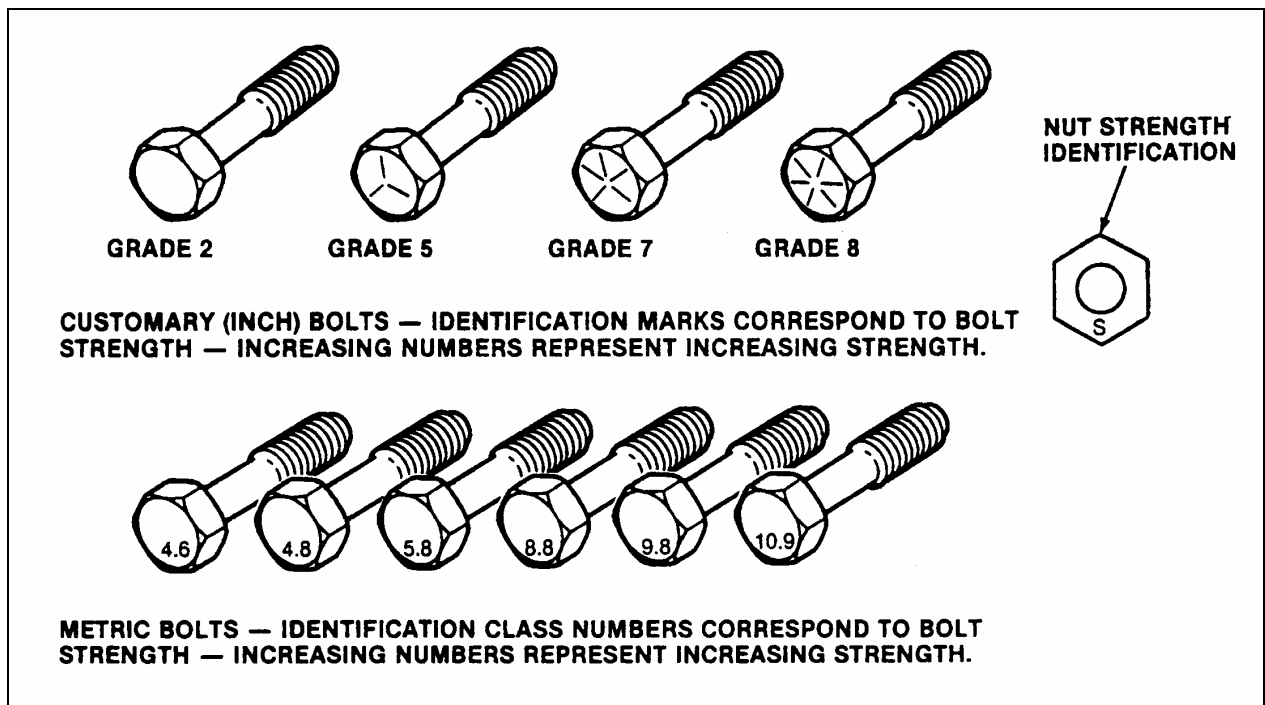

FIGURE 11: BOLT STRENGTH MARKINGS

00003

The metric fasteners used on the coach are designed to new standards and may not yet be manufactured by some non-domestic fastener suppliers. In general, except for special applications, the common sizes and pitches are:

- M 8 X 1.25;
- M 10 X 1.5;
- M 12 X 1.75;
- M 14 X 2;

5.1 SELF-LOCKING FASTENERS

A self-locking fastener is designed with an interference fit between the nut and bolt threads. This is most often accomplished by distortion of the top thread of an all-metal nut or bolt or by using a nylon patch on the threads. A nylon insert or the use of adhesives may also be used as a method of interference between nut and bolt threads (Fig. 12).

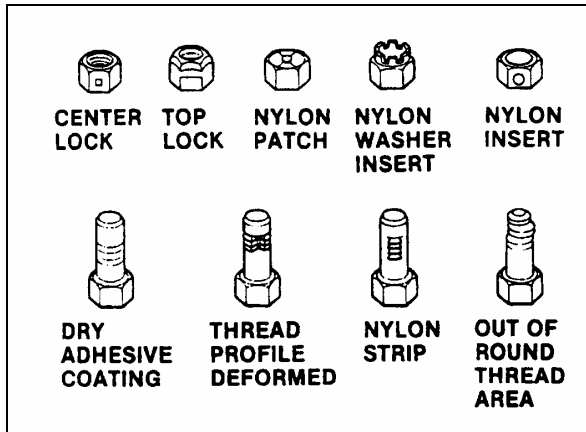

FIGURE 12 : SELF-LOCKING FASTENERS 00004

5.2 RECOMMENDATIONS FOR REUSE

Clean, unruined self-locking fasteners may be reused as follows:

- a) Clean dirt and other foreign matter from the fastener;
- b) Inspect the fastener to ensure there is no crack, elongation, or other sign of fatigue or overtightening. If there is any doubt, replace with a new self-locking fastener of equal or greater strength;
- c) Assemble parts and hand start fastener;
- d) Observe that, before the fastener seats, it develops torque per the chart in table two. If there is any doubt, replace with a new self-locking fastener of equal or greater strength;
- e) Tighten the fastener to the torque specified in the applicable section of this manual;

Fasteners which are rusty or damaged should be replaced with new ones of equal or greater strength.

SELF-LOCKING FASTENER TORQUE CHART									
METRIC		6 & 6.3	8	10	12	14	16	20	
NUTS AND ALL-METAL BOLTS	Nm	0.4	0.8	1.4	2.2	3.0	4.2	7.0	
	Lbf-in	4.0	7.0	12	18	25	35	57	
ADHESIVE OR NYLON COATED BOLTS	Nm	0.4	0.6	1.2	1.6	2.4	3.4	5.6	
	Lbf-in	4.0	5.0	10	14	20	28	46	
US STANDARD		.250	.312	.375	.437	.500	.562	.625	.750
NUTS AND ALL-METAL BOLTS	Nm	0.4	0.6	1.4	1.8	2.4	3.2	4.2	6.2
	Lbf-in	4.0	5.0	12	15	20	27	35	51
ADHESIVE OR NYLON COATED BOLTS	Nm	0.4	0.6	1.0	1.4	1.8	2.6	3.4	5.2
	Lbf-in	4.0	5.0	9.0	12	15	22	28	43

5.3 SIX LOBED SOCKET HEAD

Six lobed socket head (Torx) fasteners are used in some applications on vehicles covered in this manual. The tools designed for these fasteners are available commercially. However, in some cases, if the correct tool is not available, a hex socket head wrench may be used.

Section 00: GENERAL INFORMATION

Multiply	by	to get equivalent number of:	Multiply	by	to get equivalent number of:
	LENGTH			ACCELERATION	
Inch	25.4	millimeters (mm)	Foot/sec ²	0.305	meter/sec ² (m/s ²)
Foot	0.305	meters (m)	Inch/sec ²	0.026	meter/sec ²
Yard	0.914	meters			
Mile	1.609	kilometers (km)			
	AREA			TORQUE	
Inch ²	645.2	millimeters ² (mm ²)	Pound-inch	0.113	newton-meters (N·m)
Foot ²	6.45	centimeters ² (cm ²)	Pound-foot	1.35	newton-meters
Yard ²	0.093	meters ² (m ²)			
	0.836	meters ²			
	VOLUME			POWER	
Inch ³	16	mm ³	Horsepower	0.746	kilowatts (kW)
Quart	16.387	cm ³			
Gallon	0.016	liters (l)			
Yard ³	0.946	liters	Inches of water	0.249	kilopascals (kPa)
	3.785	liters	Pounds/sq. in.	6.895	kilopascals
	0.765	meters ³ (m ³)			
	MASS			ENERGY OR WORK	
Pound	0.453	kilograms (kg)	BTU	1	055.0 joules (J)
Ton	907.18	kilograms (kg)	Foot-pound	1.356	joules
Ton	0.907	ton (t)	Kilowatt-hour	3	600 000.0 joules (J = one W's)
				or 3.6 x 10 ⁶	
	FORCE			LIGHT	
Kilogram	9.807	newtons (N)	Foot candle	1.076	lumens/meter ² (lm/m ²)
Ounce	0.278	newtons			
Pound	4.448	newtons			
	TEMPERATURE			VELOCITY	
Degree Fahrenheit	(°F - 32) ÷ 1.8	Degree Celsius (C)	Miles/hour	1.609	kilometers/hr (km/h)

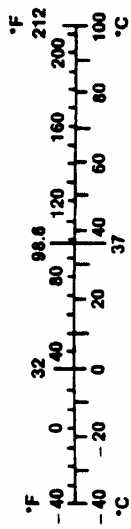

FIGURE 13: METRIC - US STANDARD CONVERSION TABLE

00005

DECIMAL AND METRIC EQUIVALENTS

FRACTIONS	DECIMAL IN.	METRIC MM	FRACTIONS	DECIMAL IN.	METRIC MM
1/64	.015625	.39688	33/64	.515625	13.09687
1/32	.03125	.79375	17/32	.53125	13.49375
3/64	.046875	1.19062	35/64	.546875	13.89062
1/16	.0625	1.58750	9/16	.5625	14.28750
5/64	.078125	1.98437	37/64	.578125	14.68437
3/32	.09375	2.38125	19/32	.59375	15.08125
7/64	.109375	2.77812	39/64	.609375	15.47812
1/8	.125	3.1750	5/8	.625	15.87500
9/64	.140625	3.57187	41/64	.640625	16.27187
5/32	.15625	3.96875	21/32	.65625	16.66875
11/64	.171875	4.36562	43/64	.671875	17.06562
3/16	.1875	4.76250	11/16	.6875	17.46250
13/64	.203125	5.15937	45/64	.703125	17.85937
7/32	.21875	5.55625	23/32	.71875	18.25625
15/64	.234375	5.95312	47/64	.734375	18.65312
1/4	.250	6.35000	3/4	.750	19.05000
17/64	.265625	6.74687	49/64	.765625	19.44687
9/32	.28125	7.14375	25/32	.78125	19.84375
19/64	.296875	7.54062	51/64	.796875	20.24062
5/16	.3125	7.93750	13/16	.8125	20.63750
21/64	.328125	8.33437	53/64	.828125	21.03437
11/32	.34375	8.73125	27/32	.84375	21.43125
23/64	.359375	9.12812	55/64	.859375	21.82812
3/8	.375	9.52500	7/8	.875	22.22500
25/64	.390625	9.92187	57/64	.890625	22.62187
13/32	.40625	10.31875	29/32	.90625	23.01875
27/64	.421875	10.71562	59/64	.921875	23.41562
7/16	.4375	11.11250	15/16	.9375	23.81250
29/64	.453125	11.50937	61/64	.953125	24.20937
15/32	.46875	11.90625	31/32	.96875	24.60625
31/64	.484375	12.30312	63/64	.984375	25.00312
1/2	.500	12.70000	1	1.00	25.40000

FIGURE 14: CONVERSION CHART

00006

PREVOST

MULTIPLEX MODULES DISCONNECTION PROCEDURE PRIOR TO WELDING

PROCEDURE NO: PR060034

**REVISION 3
2007-02-27**

Material : N/A

Equipment(s) : Phillips-head screwdriver
Ratchet handle
3/8" socket
Electric tape
Long nose pliers

Reference schematics: N/A

Safety rules :

- Wear safety goggles
- Set the battery master switch to the OFF position first

Recommendations: This procedure should be performed by qualified personnel only.

	Effective
Revision 0 : Issued with multiplex	
Revision 1 : Modified for Fire Protection System and also for VIP with multiplex	
Revision 2 : Step 5 modified for introduction of VIP with multiplex	-0436
Revision 3 : Step 1.15 added C397 Addition of SECTION 2 for X3 Coaches Addition of SECTION 3 for XLII MTH	

SECTION 1 H3 Coaches & VIP

1.00 **Location: Main power compartment and dashboard**
Set the battery master switch to the OFF position.
Place the ignition switch to the OFF position.

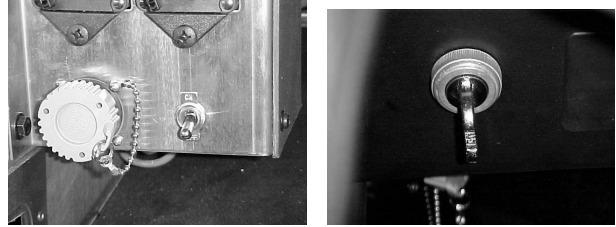

1.05 **Location: Main power compartment**
Trip circuit breakers CB2, CB4, CB6

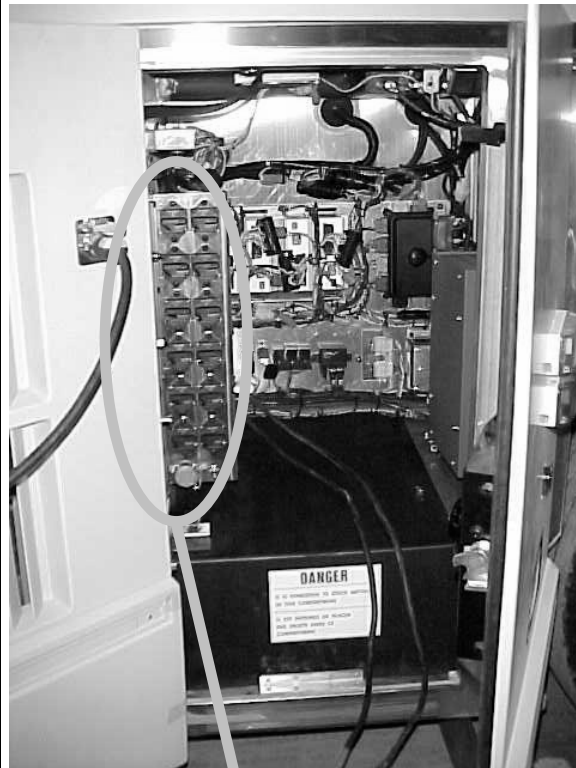

Push the red button to open the circuit



1.10 Location: Main power compartment

Remove the protective cover

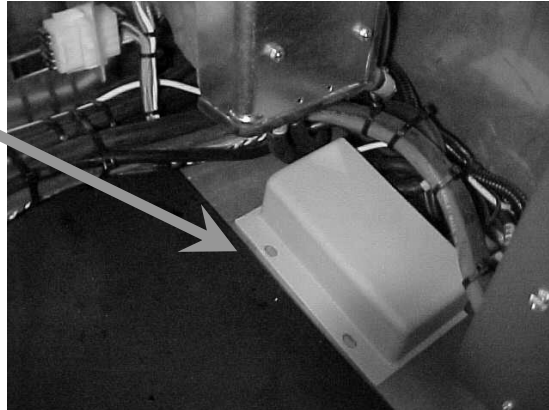

△ WARNING △

LIVE WIRE

This 12-volt terminal remains energized

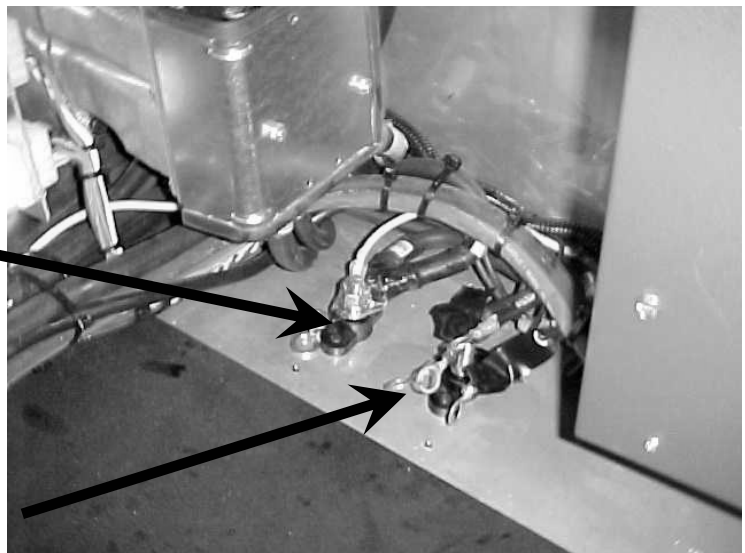

Disconnect the electronic ground terminals from the stud

Using electric tape, insulate the 2 largest gage wires. Make sure the ring terminals do not touch each others and the vehicle body.

NOTE

With disconnection of the electronic ground terminals, disconnecting the engine ECM, transmission TCM and the dashboard electronic components (telltale module, HVAC module, radio, control head, ...) is not required.

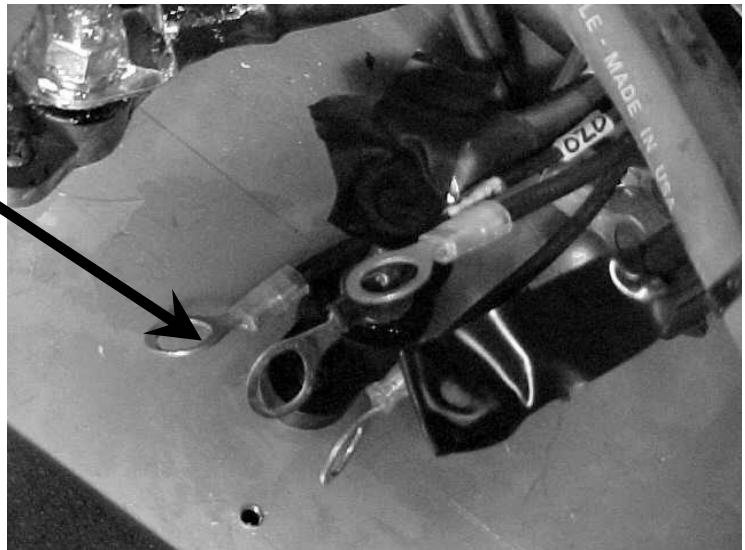

<p>1.15 Location: Main power compartment</p> <p>Disconnect the electronic modules :</p> <hr/> <p>Disconnect the I/O A and I/O B modules</p> <p style="padding-left: 40px;">Disconnect C397</p> <p>Disconnect connector C717</p> <p>Unplug 3 connectors per I/O B modules</p> <p>Unplug 3 connectors on the I/O A module</p>	
<p>1.20 Location: Front electrical compartment</p> <p>VIP + COACH: Disconnect the I/O A, I/O B, ABS, master ID, CECM and CPC modules. Unplug connector C92</p> <p>VIP: Disconnect all keyless module connectors.</p> <p>Unplug 3 connectors per I/O B modules and 3 connectors per I/O A modules.</p> <p>Unplug 2 connectors from the ABS module</p>	

Unplug 1 connector from the master ID

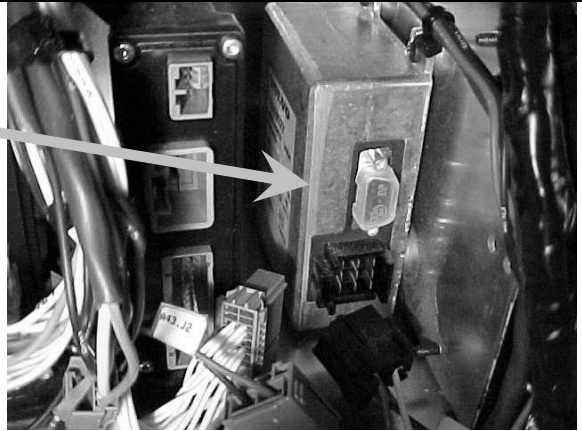

Disconnect CPC connectors



Unplug 3 connectors from the CECM

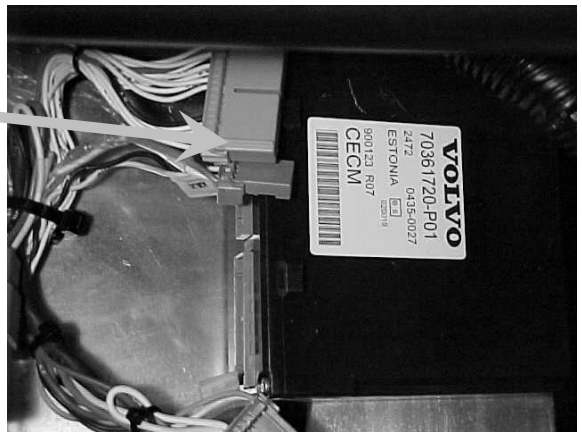

Unplug connector C92

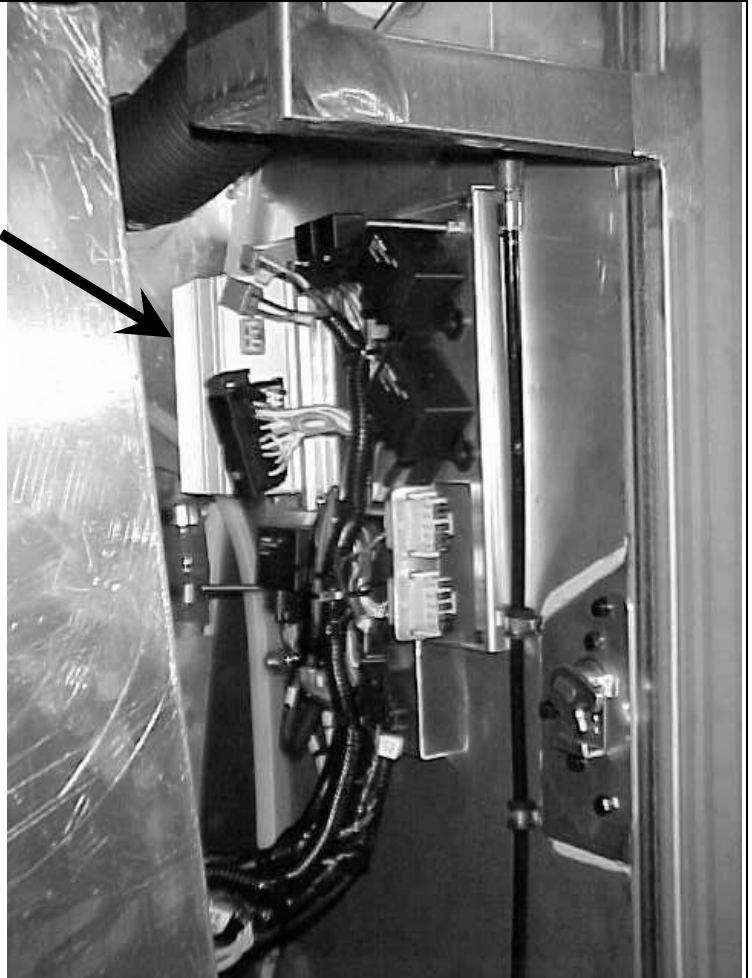

<p>1.25 Location: pneumatic accessory panel inside right console</p> <p>Remove the access panel on the right console (R.H. side of dashboard)</p> <p>Disconnect both I/O B modules</p>	
<p>1.30 Location: Evaporator compartment</p> <p>Remove the protective cover and disconnect the I/O B module</p>	

<p>1.40</p>	<p>Kidde Automatic Fire Detection and Suppression System (optional)</p> <p>Disconnect C466</p> <p>Kidde AFSS module is located on the lateral control panel.</p>	
<p>1.45</p>	<p>When all the previous steps are done, you can do welding on the vehicle</p>	<p>ENSURE THAT THE WELDING GROUND RETURN CLAMP IS WELL SECURED AND MAKES A GOOD ELECTRICAL CONTACT WITH A LARGE METALLIC AREA OF THE CHASSIS LOCATED NEAR THE WELDING POINT AS MUCH AS POSSIBLE.</p>
<p>1.50</p>	<p>When welding is completed, reconnect all the modules.</p> <p>Make sure that the connectors locking tab are well engaged</p>	<p>BE CAREFUL TO MAKE THE PROPER CONNECTIONS, IF NOT, SOME SYSTEMS OR COMPONENTS MAY NOT BE USABLE</p>

SECTION 2 X3 Coaches

2.00 **Location: Rear electrical compartment and dashboard**

Set the battery master switch to the OFF position.
Place the ignition switch to the OFF position.

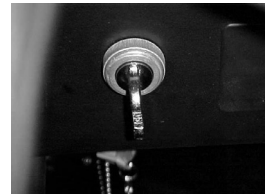
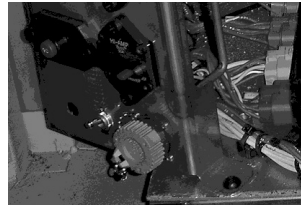

2.05 **Location: Rear electrical compartment**

Trip circuit breakers CB2-CB4-CB6 located on rear junction panel



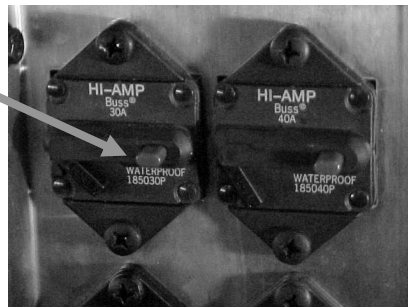

Push the red button in to open the circuit

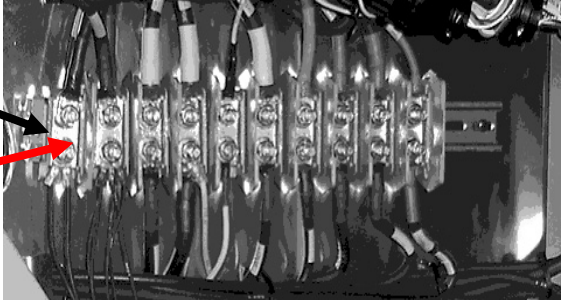
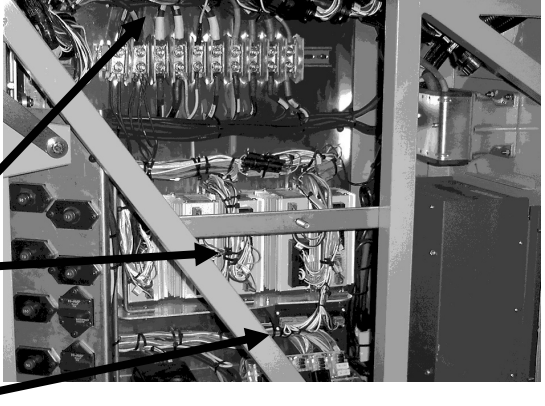

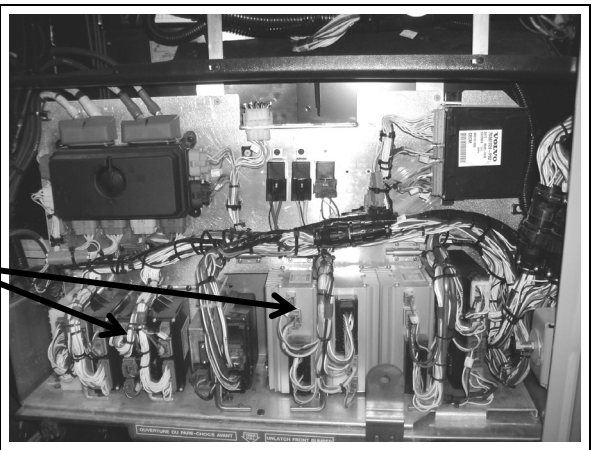
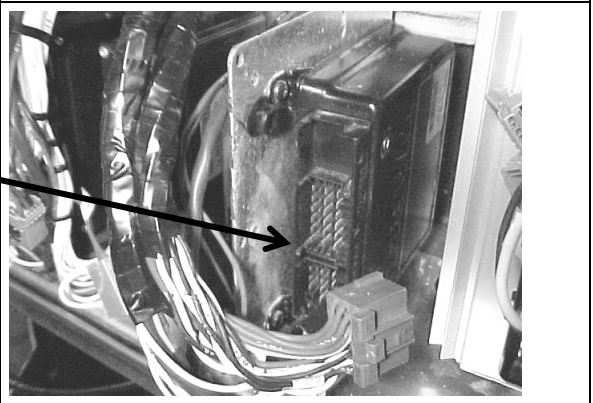
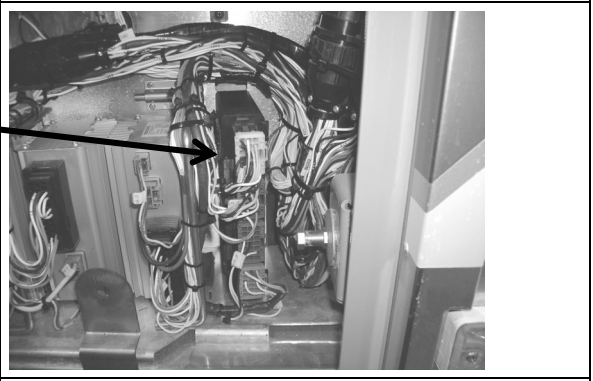
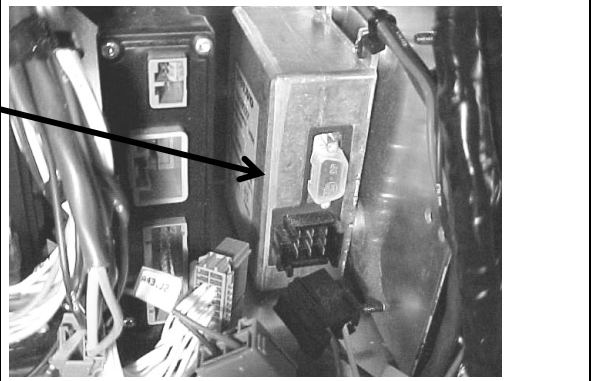
<p>2.10</p>	<p>Location: Rear electrical compartment</p> <p>Disconnect the electronic ground terminals from this stud</p> <div style="border: 2px solid red; padding: 5px; margin: 10px 0;"> <p>Warning: The remaining terminals may still be energized</p> </div> <p>Use electric tape; make sure that cables do not touch each others and the vehicle body.</p> <p style="text-align: center;"><i>NOTE</i></p> <p><i>With disconnection of the electronic ground terminals, disconnecting the engine ECM, transmission TCM and the dashboard electronic components (telltale module, HVAC module, radio, control head, ...) is not required.</i></p>	
<p>2.15</p>	<p>Location: Rear electrical compartment</p> <p>Disconnect the electronic modules:</p> <p>Disconnect all I/O A and I/O B modules</p> <p style="padding-left: 40px;">Disconnect C397 and C717</p> <p>Disconnect 3 connectors from each I/O B module</p> <p>Disconnect 3 connectors from each I/O A module</p>	

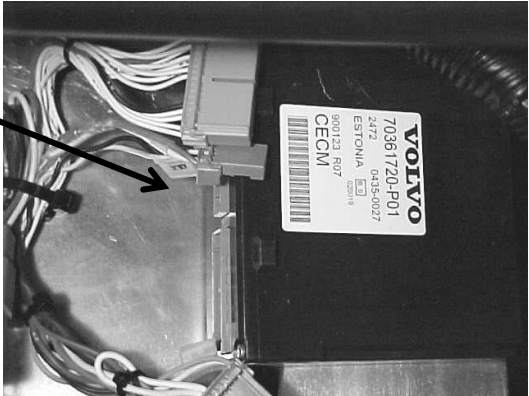
<p>2.20</p>	<p>Location: front electrical compartment</p> <p>Disconnect I/O A, I/O B, ABS, master ID, CECM and CPC modules and also disconnect connector C92</p> <p>Disconnect the 3 connectors from the I/O B and I/O A modules</p>	
	<p>Disconnect the 2 connectors from the ABS module</p>	
	<p>Disconnect CPC connectors</p>	
	<p>Disconnect connector from master ID</p>	

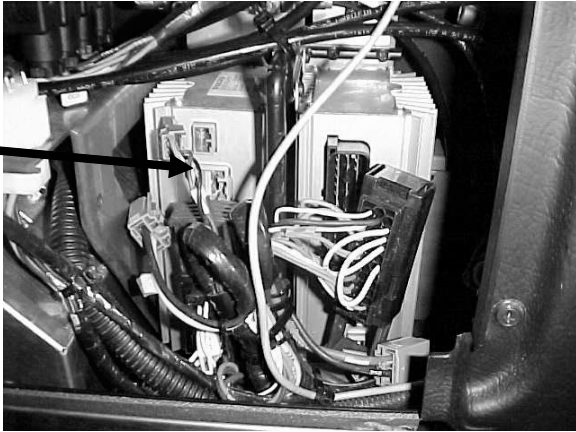
<p>Disconnect the 3 connectors from CECM</p>	
<p>Disconnect connector C92</p>	
<p>2.25 Location: Entrance door & wiper control panel Remove windshield wiper motor access panel and disconnect both I/O B modules</p>	
<p>2.30 When all the previous steps are done, you can do welding on the vehicle</p>	<p>ENSURE THAT THE WELDING GROUND RETURN CLAMP IS WELL SECURED AND MAKES A GOOD ELECTRICAL CONTACT WITH A LARGE METALLIC AREA OF THE CHASSIS LOCATED NEAR THE WELDING POINT AS MUCH AS POSSIBLE</p>
<p>2.40 When welding is completed, reconnect all the modules. Make sure that the connectors locking tab are well engaged!</p>	<p>BE CAREFUL TO MAKE THE PROPER CONNECTIONS, IF NOT, SOME SYSTEMS OR COMPONENTS MAY NOT BE USABLE</p>

SECTION 3 XLII MTH

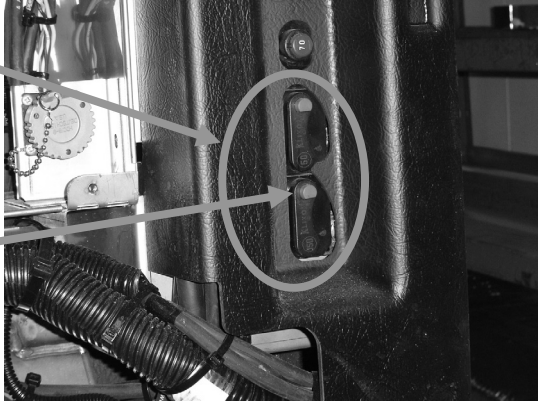
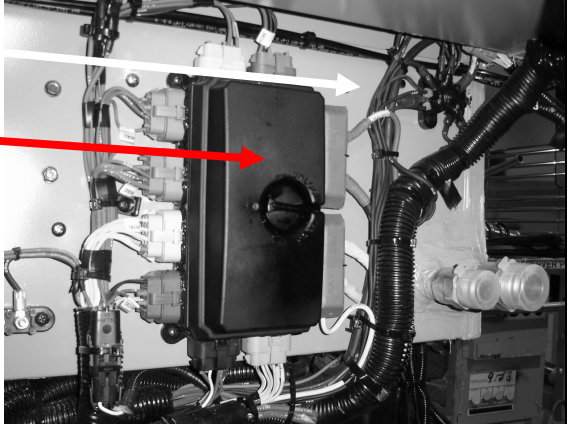
<p>2.00</p>	<p>Location: Dashboard</p> <p>Place the ignition switch to the OFF position.</p>	
<p>2.05</p>	<p>Location: Engine compartment R. H. side area</p> <p>Trip circuit breakers CB1-CB2 located on circuit breaker panel.</p> <p>Push the blue button in to open the circuit</p>	
<p>2.10</p>	<p>Location: Rear Junction Box</p> <p>Disconnect the electronic ground terminals from this stud.</p> <div style="border: 2px solid red; padding: 5px; margin: 10px 0;"> <p>Warning: The remaining terminals may still be energized.</p> </div> <p>Use electric tape; make sure that cables do not touch each others and the vehicle body.</p> <p style="text-align: center;"><i>NOTE</i></p> <p><i>With disconnection of the electronic ground terminals, disconnecting the engine ECM, transmission TCM and the dashboard electronic components (telltale module, HVAC module, radio, control head, ...) is not required.</i></p>	

2.15

Location: Rear Junction Box

Disconnect the electronic modules:

Disconnect all I/O A and I/O B modules

Disconnect C397

Disconnect transmission module (A1)

Disconnect 3 connectors from each I/O B

Disconnect 3 connectors from each I/O A

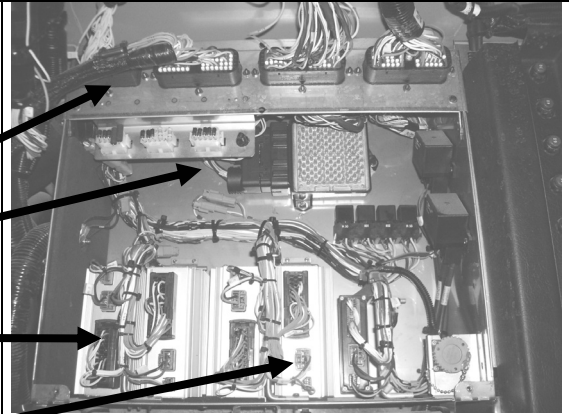

2.20

Location: Front Electrical Compartment

Disconnect I/O A, I/O B, ABS, master ID, CECM, CPC, keyless modules and also disconnect connector C92.

Disconnect 3 connectors from the I/O B and I/O A modules

Disconnect connectors from Keyless module

Disconnect 2 connectors from ABS module

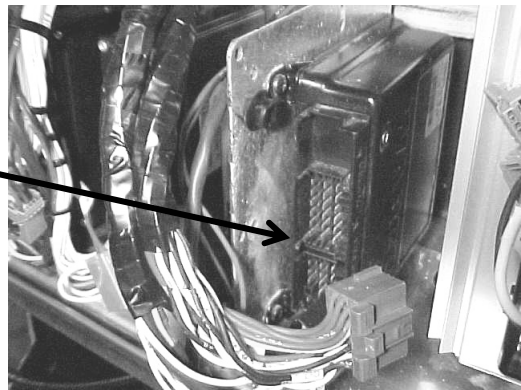

Disconnect connectors from CPC



Disconnect connector from master ID

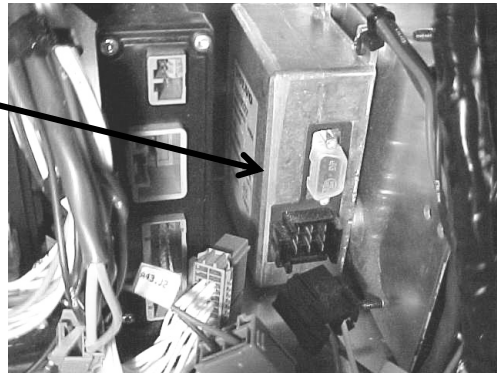

Disconnect 3 connectors from CECM

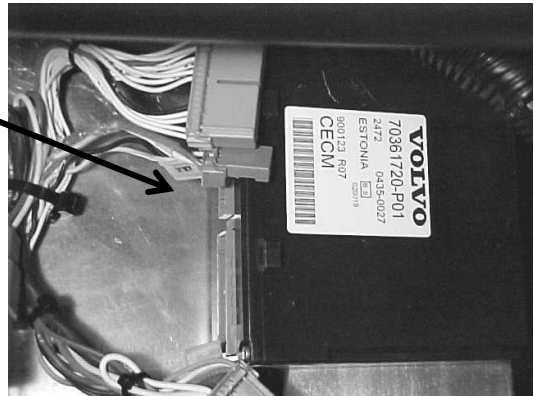

Disconnect connector C92



Location: Wiper Control Panel

Remove windshield wiper motor access panel

And disconnect I/O B modules

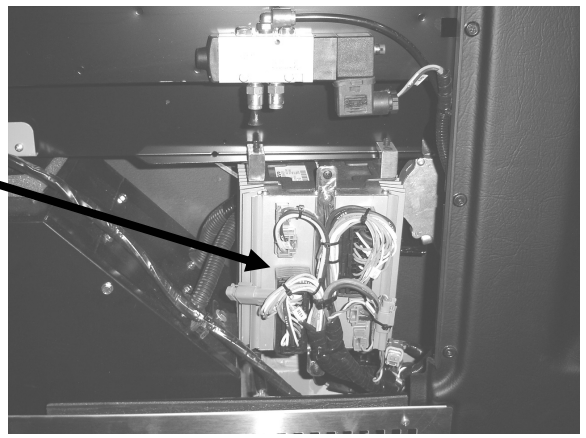

2.30	When all the previous steps are done, you can do welding on the vehicle	ENSURE THAT THE WELDING GROUND RETURN CLAMP IS WELL SECURED AND MAKES A GOOD ELECTRICAL CONTACT WITH A LARGE METALLIC AREA OF THE CHASSIS LOCATED NEAR THE WELDING POINT AS MUCH AS POSSIBLE
2.35	When welding is completed, reconnect all the modules. Make sure that the connectors locking tab are well engaged!	BE CAREFUL TO MAKE THE PROPER CONNECTIONS, IF NOT, SOME SYSTEMS OR COMPONENTS MAY NOT BE USABLE