

ABBREVIATION	DESCRIPTION
ABS	Antilock Brake System / Système de freinage antiblocage
A/C	Air Conditioning / Air climatisé
AFSS	Automatic Fire Suppression System / Système automatique de détection et d'extinction des incendies
ATC	Automatic Traction Control (Bendix) / Système d'antidérapage automatique
CECM	Chassis Electronic Control Module
CVC	Chauffage, Ventilation et Climatisation / heating, ventilation and air conditioning HVAC
DCDL	Driver Controlled Differential Lock / Verrouillage du différentiel
DDR	Diagnostic Data Reader
DEF	Diesel Exhaust Fluid / Fluide d'échappement diesel FED
DEL	Diode Électroluminescente / Light Emitting Diode LED
DID	Driver Information Display / Écran d'affichage du panneau des instruments
D-MIC	Driver Microphone / Microphone du conducteur
DPF	Diesel Particulate Filter / Filtre à particules
DTC	Diagnostic Troubleshooting Code / Code d'anomalie
DUFS	Diesel Ultra Faible en Soufre / Ultra Low Sulfur Diesel ULSD
ECM	Electronic Control Module / Unité de commande électronique
ECU	Electronic Control Unit / Unité de commande électronique
EECU	Engine Electronic Control Unit / Unité de commande électronique du moteur
EGR	Exhaust Gas Recirculation / Recirculation des gaz d'échappement
ESC	Electronic Stability Control / Dispositif électronique de contrôle de la stabilité
ESC	Escape / Échap
ESP	Electronic Stability Program (Bendix) / Dispositif électronique de contrôle de la stabilité
E+	Eco-Roll
FAP	Filtre À Particules / Diesel Particulate Filter DPF
FDA	Following Distance Alert / Alerte de distance
FED	Fluide d'Échappement Diesel / Diesel exhaust fluid DEF
GECU	Gear selector Electronic Control Unit / Unité de commande électronique du sélecteur de vitesses
G-MIC	Guide Microphone / Microphone du guide
HVAC	Heating, Ventilation and Air Conditioning / Chauffage, Ventilation et Climatisation CVC
IA	Impact Alert / Alerte de collision
IFS	Independent Front Suspension / suspension avant indépendante
LED	Light Emitting Diode / diode électroluminescente DEL
MPH	Miles Per Hour / Milles à l'heure
PPT	Premium Tech Tool
PTO	Power Take Off / Prise de pouvoir
SCR	Selective Catalytic Reduction / Réduction catalytique sélective
TCM	Transmission Control Module / Module de commande de la transmission
TCS	Traction Control System / Dispositif d'antipatinage
TECU	Transmission Electronic Control Unit / Unité de commande électronique de la transmission
TPMS	Tire Pressure Monitoring System / Système de surveillance de la pression des pneus
TWS	Threshold Warning System / Système avertisseur du seuil de porte
ULSD	Ultra Low Sulfur Diesel / Diesel Ultra Faible en Soufre DUFS
VCADS	Outil informatisé de diagnostic
VEB	Volvo Engine Brake / Frein moteur Volvo
VECF	Vehicle Electrical Center Front
VECR	Vehicle Electrical Center Rear
VECU	Vehicle Electronic Control Unit / Unité de commande électronique du véhicule
VSS	Video and Sound Selector / Sélecteur audio-vidéo
WCL	Wheelchair Lift / Système d'élévation de fauteuils roulants

Appendix A – Service Literature 163

SERVICE LITERATURE.....	164
NOTICE.....	165
DECLARATION OF THE MANUFACTURING DEFECTS TO THE GOVERNMENT OF THE UNITED STATES	165
DECLARATION OF THE MANUFACTURING DEFECTS TO THE CANADIAN GOVERNMENT	165
DECLARATION OF THE MANUFACTURING DEFECTS TO PRÉVOST.....	165

SERVICE LITERATURE

Visit our web sit at www.prevostcar.com for on-line product information and technical publications!

Additional copies of the following service literature are available upon request and at low cost.

- * **Maintenance Manual**
- * **Owner's Manual**
- * **Parts Manual**
- * **Service Center Directory**

To order, please call Prevost Parts toll free 1-800-463-8876 or write to:

PRÉVOST PARTS INC.

2955-A Watt Street
Sainte-Foy, QC G1X 3W1
CANADA

Please specify the complete vehicle serial number.

Allow 30 days for delivery.

NOTICE

DECLARATION OF THE MANUFACTURING DEFECTS TO THE GOVERNMENT OF THE UNITED STATES

If you believe that your vehicle has defect which could cause a crash or could cause injury or death, you should immediately inform the National Highway Traffic Safety Administration (NHTSA) in addition to notifying Prévost.

If NHTSA receives similar complaints, it may open an investigation, and if it finds that a safety defect exists in a group of vehicles, it may order a recall and remedy campaign.

However, NHTSA cannot become involved in individual problems between you, your dealer, or Prévost.

To contact NHTSA you may either call the toll-free Auto Safety Hotline at **1-800-424-9393** (or **366-0123**) in the Washington, D.C. area) or write to:

NHTSA
U.S. Department of transportation
Washington, D.C. 20590

You can also obtain other information about motor vehicle safety from the Hotline.

DECLARATION OF THE MANUFACTURING DEFECTS TO THE CANADIAN GOVERNMENT

If you live in Canada and you believe that your vehicle has a safety defect, you should immediately inform Transport Canada and Prévost. You may write to:

Transport Canada
Box 8880
Ottawa, ON K1G 3J2

DECLARATION OF THE MANUFACTURING DEFECTS TO PRÉVOST.

In addition to notify the NHTSA (or Transport Canada), please contact Prévost at **1-418-831-2046**. Or you may write to:

Prévost
After-Sales Service Department
850 Olivier Road
St-Nicolas, QC G7A 2N1
CANADA

Troubleshooting

Problem/Symptom	Probable Causes	Actions
Vehicle does not Start	Rear Start selector switch is not in the NORMAL position.	<ol style="list-style-type: none"> 1. Check that the rear start selector switch is flipped up to NORMAL start position and retry cranking. 2. Flip the rear start selector switch to “Rear Start” and start the vehicle from the rear.
	<p>CAN network problem (Multiplex)</p> <p>Module A53 not powered or is defective</p> <p>Engine ECM does not receive the ignition signal</p> <p>Engine ECM is not powered</p>	<p>If the vehicle does not start from the rear:</p> <ol style="list-style-type: none"> 1. Verify that module A53 is powered: <ol style="list-style-type: none"> a) Check the SYSTEM DIAGNOSTIC menu of the Driver Information Display (DID). Select FAULT DIAGNOSTIC and ELECTRICAL SYSTEM. The message “No Response ModA53, Active”, indicates a power problem on the module or a CAN network problem. b) Check / reset circuit breakers CB1 and CB9. c) Check / replace fuse F74 and F80. d) Probe gray connector on module to see if it is powered. 2. Verify that the engine ECM is powered and get the ignition signal. Check / replace fuse F78 and F79.
<p>None of the Multiplexed functions are operating, including the basic limp-home functions (door opening, flashers, wipers in speed 1)</p> <p>Three dashes “---“ appear in the telltale panel instead of the outside temperature</p> <p><i>Note: The sunshades are still functioning since these are not multiplexed</i></p>	<p>The program version in the CECM is different than the program in the I/O modules and the CECM is forcing all I/O modules to stay inactive</p>	<ol style="list-style-type: none"> 1. Engage the auto-programming of the I/O modules: Turn the ignition key to the OFF position then turn the ignition key ON. The letters CAN will appear in the telltale LCD panel for about 3 minutes. Everything shall get back to normal once the letters CAN are replaced with outside temperature display. 2. Try disconnecting the green connector on the CECM and reconnect. 3. If step 1 and 2 are ineffective, try disconnecting the Master ID module completely and repeat step 1. 4. Try disconnecting the CECM completely, leave it disconnected and see if the limp-home functions (start of the vehicle from the engine compartment, wipers speed 1, flashers, etc) are functioning.

168 Appendix B – Troubleshooting Guide for Multiplex Vehicles

Problem/Symptom	Probable Causes	Actions
<p>Many secondary functions (not essential for driving) not functioning (interior lighting, driver's area lighting, wiper speed 2 and intermittent).</p> <p>Outside temperature display in the telltale LCD panel displays three dashes "---"</p> <p>Marker lights and clearance lights are turned ON when setting ignition to the ON position.</p>	<p>The CECM module does not receive 24 V power.</p> <p>The CAN network is not working. It could be caused by a short on the network, an open circuit, a problem with the CECM or the CECM being disconnected from the network.</p>	<ol style="list-style-type: none"> 1. Check / reset circuit breaker CB2 (2nd from the bottom. Check / replace fuse F1. 2. Operate in limp-home mode by starting the vehicle from the engine compartment (REAR START). All functions essential to drive are available.
<p>No temperature control in the cabin area.</p> <p>Cabin temperature display indicates two dashes "--"</p>	<p>Problem with the temperature sensor located in the evaporator compartment air intake or the sensor wiring.</p>	<p>Manually control the temperature by playing with the cabin (passenger) set point. Set above 22°C (72°F) to heat and below 22° C (72°F) to cool.</p>
<p>Defroster fan not functioning</p> <p>Windshield wipers not functioning in speed 1 or intermittent</p>	<p>Module A47 is not powered or is faulty</p>	<ol style="list-style-type: none"> 1. Check the SYSTEM DIAGNOSTIC menu of Driver Information Display (DID). Select FAULT DIAGNOSTIC and ELECTRICAL SYSTEM. The message "No Response ModA47, Active" indicates a power problem on the module. (A CAN network problem would show the same message but doesn't produce these symptoms). 2. Check / reset circuit breaker CB3. 3. Check / replace fuse F5 and F16. 4. Probe gray connector on module to see if it is powered.
<p>Windshield wipers not functioning in speed 1 or intermittent</p>	<p>No power on R23</p>	<p>Check / replace fuse F82</p>
<p>HVAC condenser fans not functioning in speed 1</p>	<p>Circuit breaker CB7 tripped and not reset</p>	<p>Check / reset circuit breaker CB8</p>
<p>HVAC condenser fans not functioning in speed 2</p>	<p>Circuit breaker CB7 tripped and not reset</p>	<p>Check / reset circuit breaker CB5</p>
<p>Windshield washer not functioning</p>	<p>Module A46 is not powered or is faulty</p>	<ol style="list-style-type: none"> 1. Check the SYSTEM DIAGNOSTIC menu of Driver Information Display (DID). Select FAULT DIAGNOSTIC and ELECTRICAL SYSTEM.

Problem/Symptom	Probable Causes	Actions
Defroster fan is functioning but no heat or cooling available in the driver area.		<p>The message “No Response ModA46, Active” indicates a power problem on the module. (A CAN network problem would show the same message but doesn't produce these symptoms).</p> <ol style="list-style-type: none"> 2. Check / reset circuit breaker CB3. 3. Check / replace fuse F12 or F13. 4. Probe gray connector on module to see if it is powered.
<p>Low beam headlights and front flasher on left side not functioning</p> <p>Electric horn not functioning</p>	Module A45 is not powered or is faulty	<ol style="list-style-type: none"> 1. Check the SYSTEM DIAGNOSTIC menu of Driver Information Display (DID). Select FAULT DIAGNOSTIC and ELECTRICAL SYSTEM. The message “No Response ModA45, Active” indicates a power problem on the module. (A CAN network problem would show the same message but doesn't produce these symptoms). 2. Check / reset circuit breaker CB1. 3. Check / replace fuse F33 and F34. 4. Probe gray connector on module to see if it is powered.
Low beam headlights and flasher on right side not functioning	Module A48 is not powered or is faulty	<ol style="list-style-type: none"> 1. Check the SYSTEM DIAGNOSTIC menu of Driver Information Display (DID). Select FAULT DIAGNOSTIC and ELECTRICAL SYSTEM. The message “No Response ModA48, Active” indicates a power problem on the module. (A CAN network problem would show the same message but doesn't produce these symptoms). 2. Check / reset circuit breaker CB1. 3. Check / replace fuse F33 and F34. 4. Probe gray connector on module to see if it is powered.
<p>Rear flashers not functioning</p> <p>Stoplights and center stoplights not functioning</p>	Module A51 is not powered or is faulty	<ol style="list-style-type: none"> 1. Check the SYSTEM DIAGNOSTIC menu of Driver Information Display (DID). Select FAULT DIAGNOSTIC and ELECTRICAL SYSTEM. The message “No Response ModA51, Active” indicates a power problem on the module. (A CAN network problem would show the same message but doesn't produce this symptom).

170 Appendix B – Troubleshooting Guide for Multiplex Vehicles

Problem/Symptom	Probable Causes	Actions
		<ol style="list-style-type: none"> 2. Check / reset circuit breaker CB1. 3. Check / replace fuse F80. 4. Probe gray connector on module to see if it is powered.
<p>Engine is overheating and radiator fan clutch does not engage</p> <p>The A/C compressor clutch does not engage</p>	<p>Module A52 is not powered or is faulty</p>	<ol style="list-style-type: none"> 1. Check the SYSTEM DIAGNOSTIC menu of Driver Information Display (DID). Select FAULT DIAGNOSTIC and ELECTRICAL SYSTEM. The message “No Response ModA52, Active” indicates a power problem on the module. (A CAN network problem would show the same message but doesn't produce this symptom). 2. Check / reset circuit breaker CB7. 3. Check / replace fuse F65. 4. Probe gray connector on module to see if it is powered.
<p>Evaporator fan not functioning</p>	<p>Circuit breaker CB4 tripped</p> <p>Module A54 is not powered or is faulty</p>	<ol style="list-style-type: none"> 1. Check / reset circuit breaker CB4. 2. Check the SYSTEM DIAGNOSTIC menu of Driver Information Display (DID). Select FAULT DIAGNOSTIC and ELECTRICAL SYSTEM. The message “No Response ModA54, Active” indicates a power problem on the module. (A CAN network problem would show the same message but doesn't produce this symptom). 3. Check / reset circuit breaker CB7. 4. Check / replace fuse F67, F68. 5. Probe gray connector on module to see if it is powered.
<p>HVAC condenser fans not functioning in speed 1</p>	<p>Module A54 is not powered or is faulty</p>	<ol style="list-style-type: none"> 1. Check the SYSTEM DIAGNOSTIC menu of Driver Information Display (DID). Select FAULT DIAGNOSTIC and ELECTRICAL SYSTEM. The message “No Response ModA54, Active” indicates a power problem on the module. (A CAN network problem would show the same message but doesn't produce this symptom). 2. Check / reset circuit breaker CB7. 3. Check / replace fuse F67, F68. 4. Probe gray connector on module to see if it is powered.

Problem/Symptom	Probable Causes	Actions
Fire alarm telltale light and audible alarm always ON and there is no fire or high temperature in the engine compartment	Short-circuited fire sensor or defective sensor	Prior to start the vehicle, cycle the ignition key to the ON position, OFF position and then ON position again and then start the vehicle. This will deactivate the fire alarm function. This has to be repeated each time the vehicle is re-started.
The vehicle is parked and the electrical horn is activated to indicate a fire in the engine compartment but there is no fire	Short-circuited fire sensor or defective sensor	Cycle the ignition key between the ON and OFF position twice within 3 seconds. This will deactivate the fire alarm function. This has to be repeated each time the vehicle is parked.
A single light, a group of LED lights or another function of the vehicle is not functioning	The multiplex outputs are protected in current by an internal "soft-fuse". When an output is shorted, it turns OFF and stays OFF until the "soft-fuse" is reset	Turn the ignition key to the OFF position and turn to the ON position again. This resets all "soft-fuses".
No backlighting in the instrument cluster	Circuit breaker CB9 is tripped or fuse F21 blown.	Check / reset circuit breaker CB9 Check / replace fuse F21.
The radiator fan clutch does not function and the engine is overheating		<ol style="list-style-type: none"> 1. Set the ignition key to the ON position. 2. Activate the dashboard Telltale Light Test switch 3 times within 4 seconds. 3. In the engine compartment, set the starter selector switch to REAR START and then start the engine from the rear. <p>While in this mode, the rear start push-button can be used to manually engage the fan clutch. The Multiplex system knows when the engine is already running, and it will not activate the starter.</p> <ol style="list-style-type: none"> 4. Press the push-button one time to engage the clutch in 1st speed, press a second time to engage in 2nd speed, press a third time to stop the fan, press once again to return to 1st speed. <p>If the fan clutch does not engage using this procedure then the clutch is faulty or the wiring between the multiplex module and the clutch is faulty. Mechanically lock the fan clutch as described in section 05: COOLING SYSTEM of the maintenance manual.</p>

Appendix C – Allison Diagnostic Troubleshooting Codes 173

DIAGNOSTIC TROUBLESHOOTING CODES (DTC) – ALLISON 4TH GENERATION CONTROLS	174
DIAGNOSTIC TROUBLESHOOTING CODES (DTC) OVERVIEW.....	174
DIAGNOSTIC CODES – ALLISON 4 TH GENERATION CONTROLS	174
DIAGNOSTIC CODE DISPLAY AND CLEARING PROCEDURE - ALLISON 4 TH GENERATION CONTROLS	175
DIAGNOSTIC CODE RESPONSE	176
ALLISON TRANSMISSION DIAGNOSTIC TROUBLESHOOTING CODES (DTC) AND DESCRIPTIONS	177
ALLISON TRANSMISSION OIL LEVEL CHECK USING THE PUSH-BUTTON SHIFT SELECTOR....	181
EXITING THE FLUID LEVEL DISPLAY MODE.....	181
CONTROL SYSTEM PROGNOSTICS.....	182
OIL LIFE MONITOR.....	182
FILTER LIFE MONITOR.....	182
TRANSMISSION HEALTH MONITOR	183

DIAGNOSTIC TROUBLESHOOTING CODES (DTC) — ALLISON 4TH GENERATION CONTROLS

DIAGNOSTIC TROUBLESHOOTING CODES (DTC) OVERVIEW

Diagnostic codes (DTC) are numerical indications relating to a malfunction in transmission operation. These codes are logged in a list in the TCM memory with the most severe or most recent code listed first. A maximum of five codes (numbered d1 to d5) may be listed in memory at one time. As codes are added, the oldest inactive code is dropped from the list. If all codes are active, the code with the lowest priority that is not included on the severity list is dropped from the list.

Diagnostic codes (DTC) and code information may be accessed through the pushbutton shift selector or using an Allison DOC™ diagnostic tool.

The TCM separately stores the active and inactive codes. An active code is any code that is current in the TCM decision-making process. Inactive codes are codes that are retained in the TCM memory and will not necessary affect the TCM decision-making process. Inactive codes are useful in determining if a problem is:

- Isolated ;
- Intermittent ;
- Result from a previous malfunction.

The TCM may automatically delete a code from memory if it has not recurred. If the condition which generated the code is active, the LED indicator on the selector will be illuminated simultaneously with the display of the code. If the condition which generated the code no longer exists, the LED is not illuminated and the code is maintained only as a historical record of the prior condition. An illuminated MODE INDICATOR (LED) during normal operation signifies secondary shift mode operation.



DIAGNOSTIC CODES – ALLISON 4TH GENERATION CONTROLS

When the diagnostic mode is entered, the first code (position d1) is displayed as follows:

Exemple: Code P0722

Displayed as: **d1...P...07...22**

The code list position is the first item displayed, followed by the DTC. Each item is displayed for about one second. The display cycles continuously until the next code list position is accessed by pressing the **MODE** button. The following example shows how DTC P0722 is displayed on the pushbutton shift selector.

SELECT	d	1	MONITOR
		P	
	0	7	
	2	2	

- d1 (code list position) – The position which a code occupies in the list. Positions are displayed as « d1 » through « d5 » (code list position 1 through code list position 5).
- P0722 (DTC) – The diagnostic troubleshooting code number referring to the general condition or area of fault detected by the TCM.

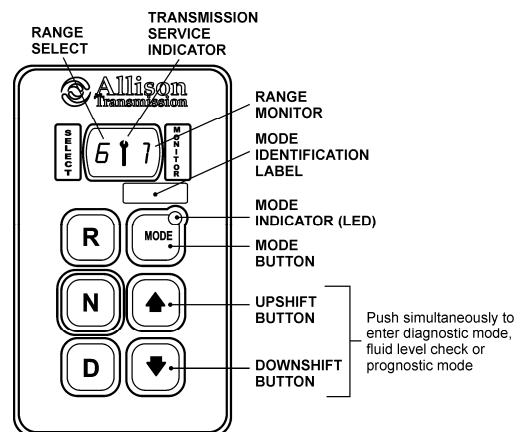

DIAGNOSTIC CODE DISPLAY AND CLEARING PROCEDURE – ALLISON 4TH GENERATION CONTROLS

Diagnostic codes can be read and cleared by two methods:

- Using an Allison DOC™ diagnostic tool. For specific instructions on how to use an Allison DOC™ diagnostic tool, refer to the User Guide.
- Using the pushbutton shift selector.

To begin the diagnostic process:

1. Bring the vehicle to a stop at a safe location.
2. Apply the parking brake.

To display stored codes:

1. Simultaneously press the ▲ (Up) and ▼ (Down) arrow buttons five times to access the Diagnostic Display Mode.

NOTE

To access the Oil Level Display Mode, simultaneously press the ▲ (Up) and ▼ (Down) arrow buttons once. Consult paragraph: « ALLISON TRANSMISSION OIL LEVEL CHECK USING THE PUSHBUTTON SHIFT SELECTOR » at the end of this section.

2. Observe the digital display for code (d1).
3. Press the MODE button to see the next code (d2) – repeat for subsequent codes (d3, d4 & d5).

NOTE

Be sure to record all codes displayed before they are cleared. This is essential for troubleshooting.

NOTE

The Diagnostic Display Mode can be entered for viewing codes at any speed. Codes can only be cleared when the output speed = 0 and no output speed sensor failure is active

Active indicators (MODE INDICATOR LED) and inactive codes can be cleared manually, while in the diagnostic display mode, after the condition causing the code is identified.

To clear active indicators and inactive codes:

1. While in Diagnostic Display Mode, press and hold the MODE button for 10 seconds to clear both active indicators and inactive codes.
2. Begin operating as normal. Have the transmission checked at the earliest opportunity by an Allison Transmission distributor or dealer.

NOTE

All active indicators are cleared at TCM power down.

Some codes will clear their active indicator when the condition causing the code is no longer detected by the TCM.

176 Appendix C – Allison Diagnostic Troubleshooting Codes

The Diagnostic Display Mode can be exited by any of the following methods:

- Press simultaneously the ▲ (Up) and ▼ (Down) arrow buttons at the same time on the pushbutton shift selector.
- Press any range button «D», «N» or «R» on the pushbutton shift selector (the shift will be commanded if it is not inhibited by an active code).
- Wait until the calibrated time (approximately 10 minutes) has passed. The system will automatically return to the normal operating mode.
- Turn off power to the TCM (shut off the engine using the ignition key).

<i>NOTE</i>

<i>If clearing a code while locked in a «D» (Drive) or «R» (Reverse) position (fail-to-range), the transmission will still be in «D» (Drive) or «R» (Reverse) when the clearing procedure is completed. «N» (Neutral) must be manually selected.</i>
--

DIAGNOSTIC CODE RESPONSE

The following responses are used in the "Diagnostic Troubleshooting Code List and Inhibited Operation Description" table to command safe operation when diagnostic codes are sent.

DNS - Do Not Shift Response

Release lock up clutch and inhibit lock up operation.
Inhibit all shifts.
Turn *ON* the CHECK TRANS light.
Display the range attained.
Ignore any range selection inputs from the shift selector.

DNA - Do Not Adapt Response

The TCM stops adaptive shift control while the code is active.

SOL OFF - SOLenoid OFF Response

All solenoids are commanded *OFF* (turning solenoids "A" and "B" off electrically cause them to be on hydraulically).

RPR - Return to Previous Range Response

When the speed sensor ratio or C3 pressure switch test associated with a shift not successful, the TCM commands the same range as commanded before the shift.

NNC - Neutral No Clutches Response

When certain speed sensor ratio or C3 pressure switch tests are not successful, the TCM commands a neutral condition with no clutches applied.

ALLISON TRANSMISSION DIAGNOSTIC TROUBLESHOOTING CODES (DTC) AND DESCRIPTIONS

DTC	Description	CHECK TRANS Light	Inhibited Operation Description
C1312	Retarder Request Sensor Failed Low	No	May inhibit retarder operation if not using J1939 datalink
C1313	Retarder Request Sensor Failed High	No	May inhibit retarder operation if not using J1939 datalink
P0122	Pedal Position Sensor Low Voltage	No	Use default throttle values. Freezes shift adapts.
P0123	Pedal Position Sensor High Voltage	No	Use default throttle values. Freezes shift adapts.
P0218	Transmission Fluid Over Temperature	No	Use hot mode shift schedule. Holds fourth range. TCC is inhibited. Freezes shift adapts.
P0561	System Voltage Performance		
P0562	System Voltage Low		
P0563	System Voltage High		
P0602	TCM Not Programmed	Yes	Lock in Neutral
P0610	TCM Vehicle Options (Trans ID) Error	Yes	Use TID A calibration
P0613	TCM Processor	No	All solenoids off
P0614	Torque Control Data Mismatch - ECM/TCM	Yes	Allows operation only in reverse and second range.
P0634	TCM Internal Temperature Too High	Yes	SOL OFF (hydraulic default)
P063E	Auto Configuration Throttle Input Not Present	Yes	Use default throttle values
P063F	Auto Configuration Engine Coolant Temp Input Not Present	No	None
P0658	Actuator Supply Voltage 1 (HSD1) Low	Yes	DNS, SOL OFF (hydraulic default)
P0659	Actuator Supply Voltage 1 (HSD1) High	Yes	DNS, SOL OFF (hydraulic default)
P0667	TCM Internal Temperature Sensor Circuit Range / Perform		
P0668	TCM Internal Temperature Sensor Circuit Low		
P0669	TCM Internal Temperature Sensor Circuit High		
P0701	Transmission Control System Performance		
P0702	Transmission Control System Electrical (TransID)	Yes	Use TID A calibration
P0703	Brake Switch Circuit Malfunction	No	No Neutral to Drive shifts for refuse packer. TCM inhibits retarder operation if a TPS code is also active.
P0708	Transmission Range Sensor Circuit High Input	Yes	Ignore defective strip selector inputs
P070C	Transmission Fluid Level Sensor Circuit – Low Input	No	None
P070D	Transmission Fluid Level Sensor Circuit – High Input	No	None
P0711	Transmission Fluid Temperature Sensor Circuit Performance	Yes	Use default sump temp
P0712	Transmission Fluid Temperature Sensor Circuit Low Input	Yes	Use default sump temp
P0713	Transmission Fluid Temperature Sensor Circuit High Input	Yes	Use default sump temp
P0716	Turbine Speed Sensor Circuit Performance	Yes	DNS, Lock in current range
P0717	Turbine Speed Sensor Circuit No Signal	Yes	DNS, Lock in current range
P071A	RELS Input Failed On	Yes	Inhibit RELS operation
P071D	General Purpose Input Fault	Yes	None

178 Appendix C – Allison Diagnostic Troubleshooting Codes

DTC	Description	CHECK TRANS Light	Inhibited Operation Description
P0720	Output Speed Sensor Circuit		
P0721	Output Speed Sensor Circuit Performance	Yes	DNS, Lock in current range
P0722	Output Speed Sensor Circuit No Signal	Yes	DNS, Lock in current range
P0726	Engine Speed Sensor Circuit Performance	No	Default to turbine speed
P0727	Engine Speed Sensor Circuit No Signal	No	Default to turbine speed
P0729	Incorrect 6 th Gear Ratio	Yes	DNS, Attempt 5 th , then 3 rd
P0730	Incorrect Neutral Gear ratio		
P0731	Incorrect 1 st Gear ratio	Yes	DNS, Attempt 2 nd , then 5 th
P0732	Incorrect 2 nd Gear ratio	Yes	DNS, Attempt 3 rd , then 5 th
P0733	Incorrect 3 rd Gear ratio	Yes	DNS, Attempt 4 th , then 6 th
P0734	Incorrect 4 th Gear ratio	Yes	DNS, Attempt 5 th , then 3 rd
P0735	Incorrect 5 th Gear ratio	Yes	DNS, Attempt 6 th , then 3 rd , then 2 nd
P0736	Incorrect Reverse Gear ratio	Yes	DNS, Lock in Neutral
P0741	Torque Converter Clutch System Stuck Off	Yes	None
P0776	Pressure Control Solenoid 2 Stuck Off	Yes	DNS, RPR
P0777	Pressure Control Solenoid 2 Stuck On	Yes	DNS, RPR
P0796	Pressure Control Solenoid 3 Stuck Off	Yes	DNS, RPR
P0797	Pressure Control Solenoid 3 Stuck On	Yes	DNS, RPR
P0842	Transmission Pressure Switch 1 Circuit Low	Yes	DNS, Lock in current range
P0843	Transmission Pressure Switch 1 Circuit High	Yes	DNS, Lock in current range
P0847	Transmission Pressure Switch 2 Circuit Low		
P0848	Transmission Pressure Switch 2 Circuit High		
P088A	Transmission Fluid Filter Deteriorated		
P088B	Transmission Fluid Filter Very Deteriorated		
P0880	TCM Power Input Signal	No	None
P0881	TCM Power Input Signal Performance	No	None
P0882	TCM Power Input Signal Low	Yes	DNS, SOL OFF (hydraulic default)
P0883	TCM Power Input Signal High	No	None
P0894	Transmission Component Slipping	Yes	DNS, Lock in first
P0960	Pressure Control Solenoid Main Mod Control Circuit Open	Yes	None
P0961	Pressure Control Solenoid (PCS) MM System Performance		
P0962	Pressure Control Solenoid Main Mod Control Circuit Low	Yes	DNS, SOL OFF (hydraulic default)
P0963	Pressure Control Solenoid Main Mod Control Circuit High	Yes	None
P0964	Pressure Control Solenoid 2 (PCS2) Control Circuit Open	Yes	DNS, SOL OFF (hydraulic default)
P0965	Pressure Control Solenoid (PCS) 2 System Performance		
P0966	Pressure Control Solenoid 2 (PCS2) Control Circuit Low	Yes	DNS, SOL OFF (hydraulic default)
P0967	Pressure Control Solenoid 2 (PCS2) Control Circuit High	Yes	DNS, SOL OFF (hydraulic default)
P0968	Pressure Control Solenoid 3 (PCS3) Control Circuit Open	Yes	DNS, SOL OFF (hydraulic default)
P0969	Pressure Control Solenoid (PCS) 3 System Performance		
P0970	Pressure Control Solenoid 3 (PCS3) Control Circuit Low	Yes	DNS, SOL OFF (hydraulic default)
P0971	Pressure Control Solenoid 3 (PCS3) Control Circuit High	Yes	DNS, SOL OFF (hydraulic default)
P0973	Shift Solenoid 1 (SS1) Control Circuit Low	Yes	DNS, SOL OFF (hydraulic default)
P0974	Shift Solenoid 1 (SS1) Control Circuit High	Yes	DNS, SOL OFF (hydraulic default)

DTC	Description	CHECK TRANS Light	Inhibited Operation Description
P0975	Shift Solenoid 2 (SS2) Control Circuit Open	Yes	7-speed: Allow 2 through 6, N, R
P0976	Shift Solenoid 2 (SS2) Control Circuit Low	Yes	7-speed: Allow 2 through 6, N, R Inhibit TCC operation
P0977	Shift Solenoid 2 (SS2) Control Circuit High	Yes	7-speed: Allow 2 through 6, N, R
P0989	Retarder Pressure Sensor Failed Low	No	None
P0990	Retarder Pressure Sensor Failed High	No	None
P1739	Incorrect Low Gear Ratio	Yes	Command 2 nd and allow shifts 2 through 6, N, R
P1891	Throttle Position Sensor PWM Signal Low Input	No	Use default throttle values
P1892	Throttle Position Sensor PWM Signal High Input	No	Use default throttle values
P2184	Engine Coolant Temperature Sensor Circuit Low Input	No	Use default engine coolant values
P2185	Engine Coolant Temperature Sensor Circuit High Input	No	Use default engine coolant values
P2637	Torque Management Feedback Signal (SEM)	Yes	Inhibit SEM
P2641	Torque Management Feedback Signal (LRTP)	Yes	Inhibit LRTP
P2670	Actuator Supply Voltage 2 (HSD2) Low	Yes	DNS, SOL OFF (hydraulic default)
P2671	Actuator Supply Voltage 2 (HSD2) High	Yes	DNS, SOL OFF (hydraulic default)
P2685	Actuator Supply Voltage 3 (HSD3) Low	Yes	DNS, SOL OFF (hydraulic default)
P2686	Actuator Supply Voltage 3 (HSD3) High	Yes	DNS, SOL OFF (hydraulic default)
P2714	Pressure Control Solenoid 4 (PCS4) Stuck Off	Yes	DNS, RPR
P2715	Pressure Control Solenoid 4 (PCS4) Stuck On	Yes	DNS, SOL OFF (hydraulic default)
P2718	Pressure Control Solenoid 4 (PCS4) Control Circuit Open	Yes	DNS, SOL OFF (hydraulic default)
P2719	Pressure Control Solenoid (PCS) 4 System Performance		
P2720	Pressure Control Solenoid 4 (PCS4) Control Circuit Low	Yes	DNS, SOL OFF (hydraulic default)
P2721	Pressure Control Solenoid 4 (PCS4) Control Circuit High	Yes	DNS, SOL OFF (hydraulic default)
P2723	Pressure Control Solenoid 1 (PCS1) Stuck Off	Yes	DNS, RPR
P2724	Pressure Control Solenoid 1 (PCS1) Stuck On	Yes	DNS, RPR
P2727	Pressure Control Solenoid 1 (PCS1) Control Circuit Open	Yes	DNS, SOL OFF (hydraulic default)
P2728	Pressure Control Solenoid (PCS) 1 System Performance		
P2729	Pressure Control Solenoid 1 (PCS1) Control Circuit Low	Yes	DNS, SOL OFF (hydraulic default)
P2730	Pressure Control Solenoid 1 (PCS1) Control Circuit High	Yes	DNS, SOL OFF (hydraulic default)
P2736	Pressure Control Solenoid 5 (PCS5) Control Circuit Open	Yes	Inhibit retarder operation
P2737	Pressure Control Solenoid (PCS) 5 System Performance		
P2738	Pressure Control Solenoid 5 (PCS5) Control Circuit Low	Yes	Allow 2 through 6, N, R. Inhibit retarder and TCC operation
P2739	Pressure Control Solenoid 5 (PCS5) Control Circuit High	Yes	Inhibit retarder operation
P2740	Retarder Oil Temperature Hot	No	None
P2742	Retarder Oil Temperature Sensor Circuit – Low Input	No	Use default retarder temp values
P2743	Retarder Oil Temperature Sensor Circuit – High Input	No	Use default retarder temp values
P2761	TCC PCS Control Circuit Open	Yes	Inhibit TCC operation
P2762	TCC PCS Control Circuit Range / Performance		
P2763	TCC PCS Control Circuit High	Yes	Inhibit TCC operation
P2764	TCC PCS Control Circuit Low	Yes	7-speed: Allow 2 through 6, N, R. Inhibit TCC operation
P2772	Four Wheel Drive Low Switch Circuit Performance		
P278A	Kickdown Input Failed ON	No	Inhibit kickdown operation

180 Appendix C – Allison Diagnostic Troubleshooting Codes

DTC	Description	CHECK TRANS Light	Inhibited Operation Description
P2793	Gear Shift Direction Circuit	Yes	Ignores PWM input from shift selector
P2808	Pressure Control Solenoid 6 (PCS6) Stuck Off	Yes	DNS, RPR
P2809	Pressure Control Solenoid 6 (PCS6) Stuck On	Yes	DNS, RPR
P2812	Pressure Control Solenoid 6 (PCS6) Control Circuit Open	Yes	DNS, SOL OFF (hydraulic default)
P2813	Pressure Control Solenoid (PCS) 6 System Performance		
P2814	Pressure Control Solenoid 6 (PCS6) Control Circuit Low	Yes	DNS, SOL OFF (hydraulic default)
P2815	Pressure Control Solenoid 6 (PCS6) Control Circuit High	Yes	DNS, SOL OFF (hydraulic default)
U0001	Hi Speed CAN Bus Reset Counter Overrun (IESCAN)	No	Use default values, inhibit SEM
U0010	CAN BUS Reset Counter Overrun	No	Use default values, inhibit SEM
U0100	Lost Communications with ECM/PCM (J1587)	Yes	Use default values
U0103	Lost Communication with Gear Shift Module (Shift Selector) 1	Yes	Maintain range selected, observe gear shift direction circuit
U0115	Lost Communication with ECM	Yes	Use default values
U0291	Lost Communication with Gear Shift Module (Shift Selector) 2	Yes	Maintain range selected, observe gear shift direction circuit
U0304	Incompatible Gear Shift Module 1 (Shift Selector) ID	Yes	Ignore shift selector inputs
U0333	Incompatible Gear Shift Module 2 (Shift Selector) ID	Yes	Ignore shift selector inputs
U0404	Invalid Data Received From Gear Shift Module (Shift Selector) 1	Yes	Maintain range selected, observe gear shift direction circuit
U0592	Invalid Data Received From Gear Shift Module (Shift Selector) 2	Yes	Maintain range selected, observe gear shift direction circuit

ALLISON TRANSMISSION OIL LEVEL CHECK USING THE PUSH-BUTTON SHIFT SELECTOR

Oil level codes are obtained as follows:

1. Park vehicle on a level surface, select «N» (neutral) on the pushbutton shift selector and apply parking brake.
2. Press simultaneously the ▲ (Up) and ▼ (Down) arrow buttons once.
3. Oil level codes are displayed in 2 minutes (e.g. display will flash and 8, 7, 6, 5, ...; countdown will occur during the 2 minutes) once the following parameters are met:
 - **Waiting time, vehicle must be stationary for at least 2 minutes to allow the oil to settle;**
 - **Engine at idle;**
 - **Oil at normal operating temperature, between 140°F (60°C) and 220°F (104°C);**
 - **Transmission in «N» (Neutral);**
 - **Transmission output shaft stopped;**
 - **Oil level sensor present and working.**

After 2 minutes, the display will flash one of the codes shown below:

CODE	CAUSE OF CODE
OL...OK	Oil level is correct
OL...LO... 1	Oil Level is LOw 1 quart
OL...LO... 2	Oil Level is LOw 2 quart
OL...LO... 3	Oil Level is LOw 3 quarts
OL...LO... 4	Oil Level is LOw 4 or more quarts
OL...HI... 1	Oil Level is Hlgh 1 quart
OL...HI... 2	Oil Level is Hlgh 2 quarts
OL...HI... 3	Oil Level is Hlgh 3 or more quarts
OL... – (fc)	Oil Level is invalid. Source of invalid reading is defined by a two-character fault code (fc)

NOTE
 Note that the quantities LO 4 and HI 3 are the largest values displayed and that the actual variation in oil level may exceed these numbers.

NOTE
 Failure to meet one of the above parameters will stop the two minute countdown. One of the codes shown hereafter will indicate the cause of the countdown interruption. Once all parameters are met, the countdown will continue from where it left off.

If the fluid level check cannot be completed, an Invalid for Display fault is reported. This condition is reflected by the display of "OL", followed by "–", followed by one or two additional characters. The displayed characters define the cause of the fault, which may be either a system malfunction or an improper condition for conducting the check.

CODE	CAUSE OF FAULT CODE
OL...-...0X	Waiting period is not complete
OL...-...EL	Engine speed (rpm) too low
OL...-...EH	Engine speed (rpm) too high
OL...-...SN	N (neutral) must be selected
OL...-...TL	Sump oil temperature too low
OL...-...TH	Sump oil temperature too high
OL...-...SH	Output shaft rotation
OL...-...FL	Sensor failure

EXITING THE FLUID LEVEL DISPLAY MODE

To exit the Oil Level Display Mode, press any range button: «R», «N» or «D» at any time.

CONTROL SYSTEM PROGNOSTICS

The transmission control system includes the provision for the user to monitor various transmission operating parameters. Transmission operating parameters monitored by the prognostics feature are:

- Oil Life Monitor
- Filter Life Monitor
- Transmission Health Monitor



NOTE

*The prognostics package requires the use of TranSynd™ or an Allison approved TES-295 licensed fluid in the transmission and Allison High Capacity filters. If any other fluids or filters are used, Prognostic mode **must be disabled**. Prognostic information will not be accurate with any other fluids or filters and could result in missed maintenance activities resulting in transmission damage.*

Refer to TES 295 Approved Fluids list, found under the Service/Fluids heading on the home page of the Allison Transmission web site.

www.allisontransmission.com

When a specified threshold is detected for any of the serviceable conditions, the TRANSMISSION SERVICE indicator  is illuminated to alert the operator. Failure to attend to the service condition and reset the TRANSMISSION SERVICE indicator within a defined operating period will result in illumination of the CHECK TRANS light on the dashboard telltale panel, indicating the increased probability that the service condition will develop into a more serious condition.

To access the Prognostic Mode functions, simultaneously press the  (Up) and  (Down) arrow buttons repeatedly. See the reference table at the end of this section.

• **OIL LIFE MONITOR**

The display message denotes the calculated remaining life of the transmission fluid. This value is based on the established life for the required baseline fluid, and then is continuously adjusted for cumulative effects of such operating parameters as operating time, retarder operation, output shaft revolutions and shift frequency.

Display: The display is a two-digit number, denoting percentage of the fluid life which remains. New fluid is displayed as 99%.

The TRANSMISSION SERVICE indicator  will be illuminated, denoting a required change of transmission fluid, when the remaining fluid life reaches approximately 1–2 %. The indicator will be lit steadily upon each initialization of the TCM, and will remain on steady for approximately 1–2 minutes after the first selection of “D” (drive) range each time, until service is performed and the indicator is reset.

Failure to perform maintenance and reset the TRANSMISSION SERVICE indicator within a defined period will result in the illumination of the CHECK TRANS light on the dashboard telltale panel and diagnostic code P0897 Transmission Fluid at Limit will be set.

Reset: The TRANSMISSION SERVICE indicator can be reset by a message over the SAE J1939 communication interface, with the Allison DOC™ for PC diagnostic program, or by depressing and holding the MODE button for ten (10) seconds while the Oil Life Monitor function is displayed. It may also be reset by selecting N-D-N-D-N-R-N on the shift selector, pausing briefly (less than 3 seconds) between each selector movement, with the ignition on and the engine not running.



CAUTION

Required calendar-based oil & filter change intervals (based on month) still apply because Oil Life Monitor function cannot measure time while ignition power is OFF.

If the Oil Life Monitor function has not indicated the need for a fluid change before 60 month (five years) have passed, it will be necessary to change the fluid and filters per calendar requirements and reset the system.

• **FILTER LIFE MONITOR**

The display message denotes operating status of the transmission main fluid filter, based on the measured pressure drop across the filter. The feature is not functional at transmission sump temperatures below 40 °C (105 °F). Both the main and lube filters **must be** changed when the TRANSMISSION SERVICE indicator  shows the main filter should be changed.

Display: An acceptable filter life status is displayed as "OK". An unacceptable filter life status is displayed as "LO".

Once the programmed threshold for maximum filter pressure drop has been observed and verified, the diagnostic code P088A Transmission Filter At/Over Limit will be recorded to indicate that the filter has reached the end of its designed life. At the next initialization of the TCM, the TRANSMISSION SERVICE indicator  will flash for approximately 1–2 minutes after the first selection of "D" (drive) range. Thereafter, the indicator will illuminate and flash upon each TCM initialization, continuing to flash for 1–2 minutes after the first selection of a drive range each time, until service is performed and the indicator is reset.

Failure to perform maintenance and reset the monitor after a calibration-defined number of warnings will result in the illumination of the CHECK TRANS light on the dashboard telltale panel and diagnostic code P088B will be recorded to indicate a highly deteriorated filter.

Reset: The feature will reset automatically when the main fluid filter has been changed and the pressure drop across the filter no longer exceeds the threshold value. A manual reset can be performed by depressing and holding the MODE button for ten (10) seconds while the Filter Life Monitor function is displayed. It may also be reset by selecting N-R-N-R-N-D-N on the shift selector, pausing briefly (less than 3 seconds) between each selector movement, with the ignition on and the engine not running.

• **TRANSMISSION HEALTH MONITOR**

The display message denotes clutch life status, as determined by monitored changes and the calculated running clearance of the transmission clutches C1, C2, C3, C4 & C5.

Display: An acceptable clutch life status is displayed as "OK". An unacceptable clutch life status is displayed as "LO". The specific clutch(es) for which the function indicates "LO" cannot be identified with the shift selector. Allison DOC™ for PC-Service Tool displays clutch condition as OK or NOT OK for each clutch, C1 through C5.

The TRANSMISSION SERVICE indicator will be illuminated, indicating the need for clutch maintenance, when the remaining clutch life reaches approximately 10%, or if the running clearance exceeds a maximum value which may

indicate a non-wear-related issue. Thereafter, the indicator will be lit upon each initialization of the TCM, and will remain on steady during all vehicle operation until service is performed and the indicator is reset.

Failure to perform maintenance and reset the monitor after a number of warnings will result in the illumination of the CHECK TRANS light on the dashboard telltale panel and diagnostic code P2789 Clutch Adaptive learning at Limit will be set.

Reset: The feature will reset automatically upon elimination of the clutch clearance condition which initiated it. The indicator can also be manually reset using the Allison DOC™ for PC diagnostics program if necessary.

184 Appendix C – Allison Diagnostic Troubleshooting Codes

▲ (up) & ▼ (down) arrow buttons pressed simultaneously	DESCRIPTION	SELECT	MONITOR
1 st press	Allison transmission oil level check Other codes will be displayed	" _ "	" _ "
2 nd press	Oil Life Monitor Oil life remaining will range from 99% down to 00%	" O " Some number from 9 to 0	" M " Some number from 9 to 0
3 rd press	Filter Life Monitor Present life of filter is OK Present life of filter is low	" F " " O " " L "	" M " " K " " O "
4 th press	Transmission Health Monitor Shows "OK" until remaining life of one or more of the clutch(es) wear enough so that the programming changes One or more of the clutches C1 through C5 have worn enough to change the program	" O " " O " " L "	" K " " K " " O "
5 th press	Display of diagnostic codes Other codes will be displayed	" d "	" 1 "

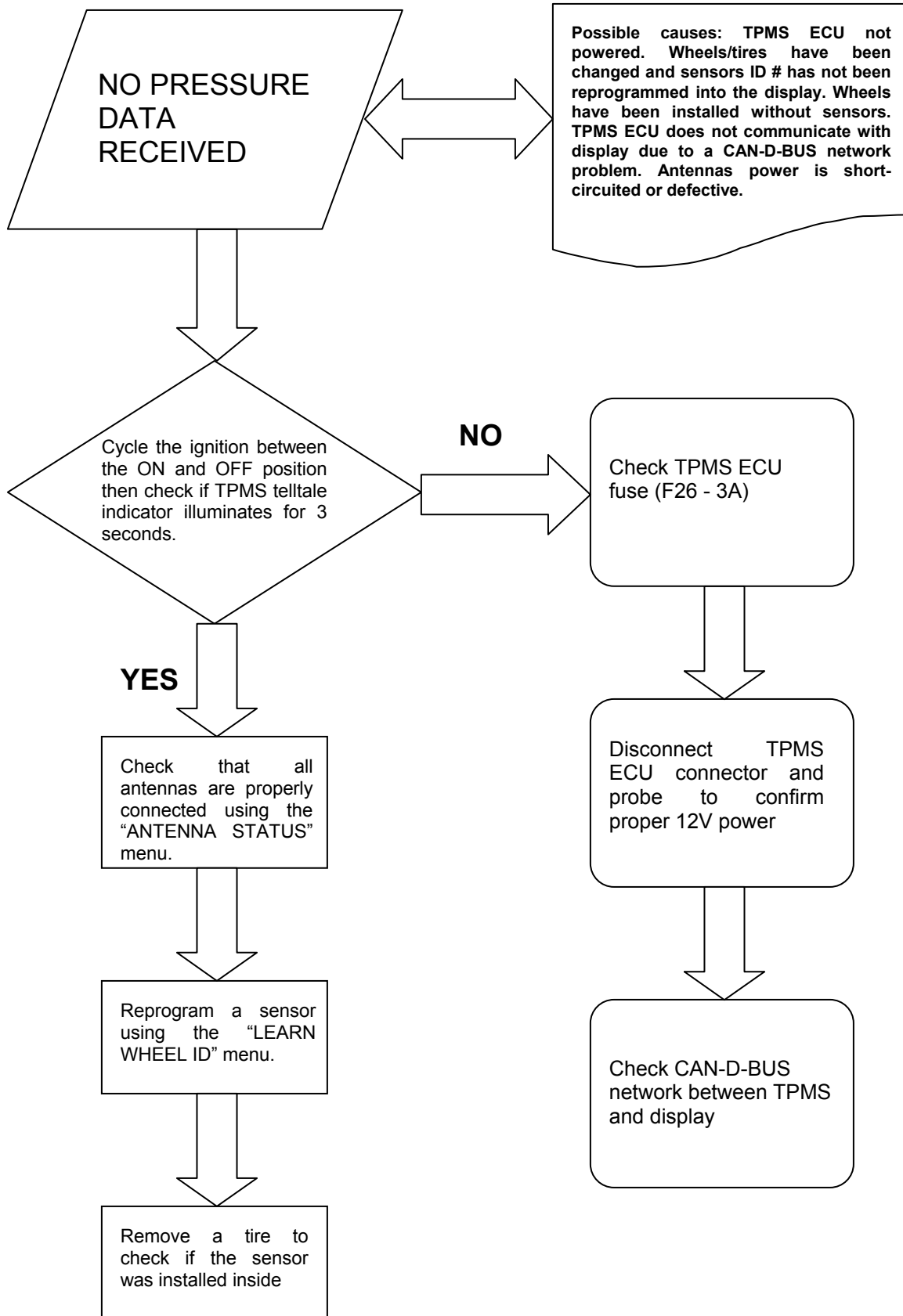

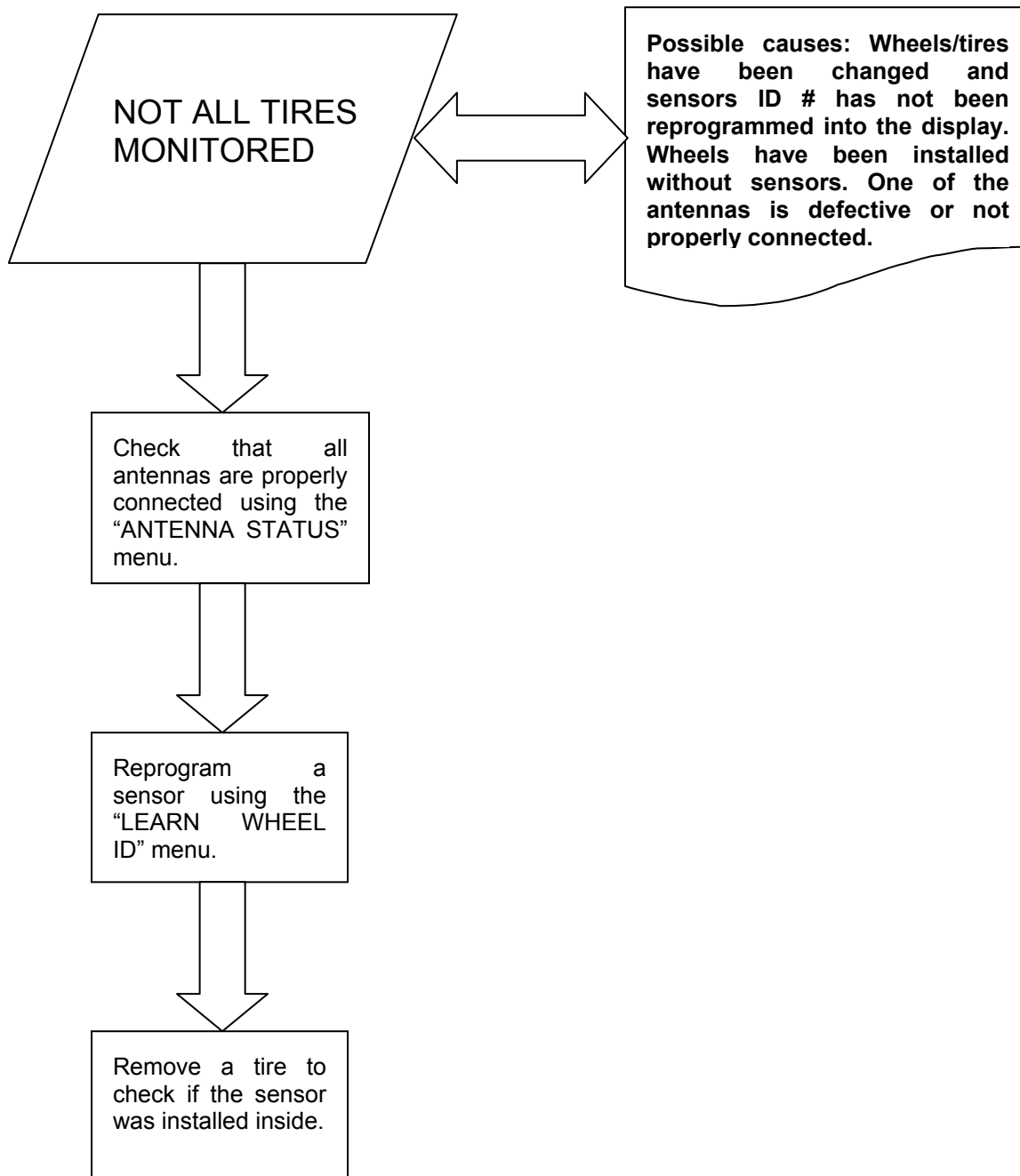

110-120 VOLT CONNECTOR 15

A

ABBREVIATIONS 161

ADJUSTABLE HVAC REGISTERS20

AIR SYSTEM 154

ALIGNMENT SPECIFICATIONS 155

 DRIVE AXLE 156

 INDEPENDENT FRONT SUSPENSION 156

 TAG AXLE 156

ALLISON AUTOMATIC TRANSMISSION69

 DESCRIPTION OF AVAILABLE RANGES.....70

 FUNCTIONS OF THE "MODE" BUTTON70

 OPERATION 69

 PUSH BUTTON SHIFT SELECTOR.....69

 TRANSMISSION SERVICE INDICATOR.....70

ALLISON TRANSMISSION..... 153

 GEAR RATIOS 154

ALLISON TRANSMISSION ELECTRONIC CONTROLS95

ALLISON TRANSMISSION WARM-UP 115

ANTILOCK BRAKING SYSTEM (ABS) ..97, 154

 TROUBLESHOOTING AND TESTING 154

APPENDIX A – SERVICE LITERATURE 163

 SERVICE LITERATURE.....164

 NOTICE.....165

APPENDIX B – TROUBLESHOOTING GUIDE FOR MULTIPLEX VEHICLES 167

APPENDIX C – ALLISON DIAGNOSTIC TROUBLESHOOTING CODES 173

 CONTROL SYSTEM PROGNOSTICS 182

 DIAGNOSTIC TROUBLESHOOTING CODES (DTC) – ALLISON 4TH GENERATION CONTROLS.....174

 ALLISON TRANSMISSION OIL LEVEL CHECK USING THE PUSH-BUTTON SHIFT SELECTOR 181

APPENDIX D – TPMS TROUBLESHOOTING GUIDE..... 185

AUTOMATIC FIRE DETECTION AND SUPPRESSION SYSTEM (AFSS) 31, 119

AUTOMATIC TRACTION CONTROL (ATC)..... 97, 154

B

BACK-UP ALARM..... 127

 BACK-UP ALARM CANCEL SWITCH.....127

BACK-UP CAMERA 15, 127

BAGGAGE COMPARTMENTS 12

BELTS..... 153

BRAKES 154

 BRAKE CHAMBER EFFECTIVE AREA 154

C

CAPACITIES..... 152

CARE AND MAINTENANCE..... 129

CATALYTIC CONVERTER ACCESS DOOR. 10

CHANGING WHEELS 125

 HYDRAULIC JACK.....126

 JACKING POINTS.....125

CLEANING..... 131

 CARPET132

 EXTERIOR SURFACES.....132

 FLOOR CLEANING.....132

 FORMICA.....132

 PLASTIC AND VINYL.....132

 RUBBER COMPONENTS132

 SEAT UPHOLSTERY131

 STAINLESS STEEL132

 WINDOWS132

 WINDSHIELD133

COACH FINAL RECORD 159

COLD WEATHER STARTING..... 113

COMPARTMENT LIGHTING..... 127

COMPONENTS IDENTIFICATION 145

CONDENSER COMPARTMENT (A/C) 11

CONTROL SWITCHES43

 AIR VENTS47

HVAC CONTROL MODULES46
 L.H. DASHBOARD PANEL43
 R.H. DASHBOARD PANEL.....45
CONTROLS AND INSTRUMENTS... 23
 COOLING SYSTEM.....156
 CORNERING AND DOCKING LIGHTS.....127

D

DASHBOARD42
 DAYTIME RUNNING LIGHTS127
 DEFENSIVE DRIVING PRACTICES2
 DIMENSIONS AND WEIGHTS152
 DRIVER CONTROLLED DIFFERENTIAL
 LOCK (DCDL)98
 LOCKING THE DCDL98
 OPERATION TIPS98
 UNLOCKING THE DCDL98
 DRIVER INFORMATION DISPLAY (DID)
 MENUS86
 DRIVER’S SEAT - DELIVERY18
 DRIVER’S AND CO-PILOT’S SEATS –
 /SR/ (OPTIONAL).....18
 ELECTRIC ISRI SEATS18
 PNEUMATIC ISRI SEATS.....18
 DRIVING MODE MENU86
 FUEL DATA.....88
 GAUGES86
 RESET TRIP DATA.....89
 TIME / DISTANCE.....88
 VEHICLE MESSAGES89

E

ELECTRICAL SYSTEM155
 ELECTRONIC STABILITY CONTROL (ESC)
97, 154
 EMERGENCY AIR-FILL VALVES118
 EMERGENCY AND PARKING BRAKES119
 EMERGENCY EXITS.....118
 ELECTRIC AWNING WINDOW118

ELECTRIC SLIDING WINDOWS118
 FIXED WINDOWS.....118
 ENGINE153
 ENGINE BLOCK HEATER113
 ENGINE BRAKE96
 ENGINE BRAKE – AUTO MODE (WITH I-SHIFT
 TRANSMISSION ONLY)97
 EXHAUST BRAKE96
 VOLVO ENGINE BRAKE (VEB).....96
 ENGINE COMPARTMENT COMPONENTS....8
 ENGINE COMPARTMENT R.H. SIDE DOOR....9
 ENGINE COMPARTMENT REAR DOORS9
 ENGINE WARM-UP115
 ENTRANCE DOOR14
 KEYLESS ENTRY SYSTEM14, 99
 EVAPORATOR COMPARTMENT.....11
 EXHAUST AFTERTREATMENT SYSTEM79
 DEF TANK LEVEL – DRIVER WARNING AND
 INDUCEMENT83
 DEF QUALITY – DRIVER WARNING AND
 INDUCEMENT84
 FILTRATION AND REGENERATION UNIT79
 SCR SYSTEM TAMPERING – DRIVER
 WARNING AND INDUCEMENT85
 SELECTIVE CATALYTIC REDUCTION UNIT ...81
 EXHAUST AFTERTREATMENT SYSTEM
 ACCESS DOOR10
 EXHAUST SYSTEM156
 EXTERIOR LIGHTING VERIFICATION141

F

FLUID LEVEL VERIFICATION133
 COOLANT FLUID LEVEL.....136
 COOLING FAN RIGHT ANGLE GEARBOX OIL
 LEVEL136
 DRIVE AXLE WHEEL BEARING OIL LEVEL..136
 ENGINE OIL LEVEL.....133
 FRONT AND TAG AXLE WHEEL HUBS136
 POWER STEERING FLUID LEVEL135
 TRANSMISSION OIL LEVEL134

WINDSHIELD WASHER & HEADLIGHTS
WASHER RESERVOIRS137

FOG LIGHTS127

FOOT-OPERATED CONTROLS68

 ACCELERATOR PEDAL.....69

 SERVICE BRAKES68

FRONT ELECTRICAL AND SERVICE
COMPARTMENT11

FUEL AND DIESEL EXHAUST FLUID (DEF)
FILLER DOOR13

FUEL SYSTEM156

FUEL TYPE.....152

 BIODIESEL FUELS152

G

GENERAL RECOMMENDATIONS143

H

HEATING AND AIR CONDITIONING157

 CENTRAL HVAC SYSTEM157

 COMPRESSOR (for central HVAC system)157

 COMPRESSOR (for small HVAC system)157

 SMALL HVAC SYSTEM157

I

IGNITION SWITCH26

INDEX **187**

INSIDE MIRROR.....20

INSTRUMENT CLUSTER.....48

 ANALOG INCATORS49

 DRIVER INFORMATION DISPLAY56

 TELLTALE LIGHTS52

I-SHIFT TRANSMISSION – STARTING THE
VEHICLE AT LOW TEMPERATURES115

J

JUMP STARTING114

K

KEYLESS ENTRY SYSTEM99

 KEYLESS OPERATING INSTRUCTIONS99

 PROGRAMMING A PERSONAL CODE99

 PROGRAMMING TRANSMITTERS.....100

 REMOTE ENTRY TRANSMITTER.....100

KEYS26

 ENTRANCE DOOR KEY26

 EXTERIOR COMPARTMENTS KEY.....26

 FUEL FILLER DOOR KEY26

L

LATERAL CONTROL PANEL28

 12-VOLT DC POWER OUTLET31

 ACCESSORY POCKET31

 ASHTRAY31

 AUTOMATIC FIRE DETECTION AND
 SUPPRESSION SYSTEM (AFSS)31

 CIGARETTE LIGHTER30

 CONTROL SWITCHES28

 CRUISE CONTROL31

 LEVEL LOW SYSTEM29

 MIRROR CONTROLS29

 PARKING BRAKES CONTROL VALVE.....30

 TAG AXLE CONTROL VALVE30

 TIRE PRESSURE MONITORING SYSTEM
 (TPMS).....38

 TRAILER AIR SUPPLY CONTROL VALVE31

 TRANSMISSION CONTROL PAD28

M

MUD FLAPS AND SPLASH GUARDS127

N

NON-DRIVING / STATIONARY
MODE MENUS89

 AFTERTREATMENT94

 DATA LOG93

 DIAGNOSTICS.....91

DISPLAY SETTINGS89
 PASSWORD95
 PRE-TRIP ASSISTANT.....92
 NOTICE.....165

O

OIL SPECIFICATIONS157
 ALLISON AUTOMATIC TRANSMISSION.....157
 DIFFERENTIAL.....157
 ENGINE.....157
 FAN RIGHT ANGLE GEARBOX158
 I-SHIFT TRANSMISSION.....157
 POWER STEERING RESERVOIR.....158
 OTHER FEATURES..... 77
 OTHER PRECAUTIONS.....3
 OTHER VERIFICATIONS137
 A/C AND HEATING SYSTEM AIR FILTERS...140
 AIR COMPRESSOR BELT TENSION
 ADJUSTMENT.....139
 AIR FILTER RESTRICTION INDICATOR139
 AIR TANK PURGE137
 BACK-UP CAMERA139
 FAN AND ALTERNATOR DRIVE BELTS139
 FIRE EXTINGUISHERS138
 FUEL FILTER / WATER SEPARATOR.....138
 HOSE INSPECTION140
 LUBRICATION141
 PARKING/EMERGENCY BRAKE TEST141
 SERVICE BRAKE TEST141
 WHEEL BEARINGS141
 WHEELS AND TIRES141

P

PLATES AND CERTIFICATION158
 DOT CERTIFICATION PLATE159
 EPA ENGINE LABEL159
 SAFETY CERTIFICATION158
 PROPELLER SHAFT154

R

RADIATOR DOOR..... 10
 REAR VIEW MIRRORS..... 15
 RECLINING BUMPER COMPARTMENT 13
 REMOTE ENTRY TRANSMITTER.....27, 100
 RETRACTABLE TAG AXLE98

S

SAFE OPERATING PRACTICES..... 2
 SAFETY BELTS..... 19
 SAFETY EQUIPMENT 119
 AUTOMATIC FIRE DETECTION AND
 SUPPRESSION SYSTEM (AFSS)119
 FIRE EXTINGUISHERS124
 FIRST AID KIT124
 JACK AND TOOLS.....125
 SPARE PARTS KIT.....125
 TIRE PRESSURE MONITORING SYSTEM
 (TPMS)120
 WARNING REFLECTORS124
 SAFETY FEATURES AND
 EQUIPMENT 117
 SAFETY PRECAUTIONS 1
 SERVICE LITERATURE..... 164
 SLIDE-OUT OPERATION 101
 FRONT AND REAR SLIDE-OUT OPERATION101
 SAFETY PRECAUTIONS.....101
 SLIDE-OUT MANUAL OVERRIDE
 PROCEDURE102
 SLIDE-OUT TROUBLESHOOTING105
 TROUBLESHOOTING – OPERATING
 CONDITIONS, CONTROL & MECHANICAL
 COMPONENTS.....106
 STARTING AND STOPPING
 PROCEDURES 111
 STARTING THE ENGINE..... 112
 STARTING FROM THE DRIVER'S SEAT.....112
 STARTING FROM THE ENGINE
 COMPARTMENT112
 STEERING COLUMN CONTROLS..... 65

HORNS67

MULTI-FUNCTION LEVER65

STEERING WHEEL CONTROLS.....66

TRANSMISSION RETARDER68

STEERING WHEEL ADJUSTMENT20

STEERING155

SUNSHADES (BLINDS)20

SUSPENSION.....155

 DRIVE AXLE155

 INDEPENDENT FRONT SUSPENSION155

 TAG AXLE155

T

TECHNICAL INFORMATION..... 149

TIRE PRESSURE MONITORING SYSTEM
(TPMS).....38, 120

TOWING.....126

TRAILER HITCH16

TRANSMISSION RETARDER68, 95

V

VARIABLE ASSISTANCE STEERING
GEAR (OPTIONAL)99

VEHICLE EXTERIOR..... 5

VEHICLE IDENTIFICATION
NUMBER (VIN)159

VEHICLE INTERIOR..... 17

VOLVO I-SHIFT TRANSMISSION.....72, 154

 ACCELERATOR PEDAL73

 DISPLAY72

 DRIVING.....75

 ECONOMY AND PERFORMANCE MODE73

 ECO-ROLL MODE (FREEWHEEL FUNCTION)73

 GEAR RATIOS154

 LIMP HOME MODE.....73

 PUSHBUTTON SHIFT SELECTOR72

 STARTING AND STOPPING.....74

 STARTING THE VEHICLE UPHILL AND
 DOWNHILL.....74

TOWING.....76

W

WALK-AROUND INSPECTION
(BEFORE EVERY TRIP) 146

WHEELS AND TIRES 153

 RECOMMENDED TIRE INFLATION
 PRESSURE AT MAXIMUM COLD LOAD153

WINDOWS.....20, 132

 AWNING WINDOWS.....20, 118

 DRIVER'S POWER WINDOW20

 FIXED WINDOWS20, 118

 SLIDING WINDOWS21, 118