

# PREVOST®

COACH MANUFACTURER

## OWNER'S MANUAL



# PA1601 Rev.2

February 2015

PA1601

Featuring:

- PRIME (Power Recovery by Intelligent Management of Energy) and Bitzer A/C Compressor

First edition: April 2013, starting from vehicle D-2364

REV	EFFECTIVE	DESCRIPTION	DATE
1	E-2602	Allison transmission 5th Generation, GHG14	August 2014
2	F-2929	New Keyless Entry System	Feb. 2015



This PREVOST *Private Coach Owner's Manual* has been prepared to thoroughly acquaint you, the owner, with vehicle equipment and features in order to fully appreciate and safely enjoy your vehicle. Of course, you are anxious to drive your new private coach and test its features, but first please read this publication carefully to help ensure enjoyable and trouble free operation. This book should be kept inside the vehicle at all times for convenient reference. It is also suggested that it remains with the vehicle at the time of resale. Please notify PREVOST CAR INC. when the vehicle's ownership is transferred so that our records can be kept up to date. Do this by filling out the appropriate form at the end of this manual.

The specifications, descriptions and figures given are based on the latest information available at printing time. And because at PREVOST we are constantly striving to improve our products, we reserve the right to make changes at any time without notice and/or obligation on our part.

Please note that this publication applies to factory-prepared, conversion-ready luxury private coaches, manufactured by PREVOST CAR INC. It describes and explains the equipment and options available for installation in our factory. Therefore, there may be equipment described herein that is not installed on your vehicle. This publication also does not cover equipment installed by your interior designer or system manufacturer.

This manual, or portions thereof, cannot be reproduced in any form whatsoever, in whole or in part, without the written consent of PREVOST CAR INC.

The following words are used to emphasize particularly important information:

 <b>WARNING</b>
Identifies instructions which, if not followed, could result in serious personal injury or loss of life.

 <b>CAUTION</b>
Denotes instructions which, if not followed, could cause serious damage to vehicle components.

<b>NOTE</b>
<i>Indicates supplementary information needed to fully understand and complete an instruction.</i>

For your own safety and to ensure prolonged service life of your private coach, heed our cautions, warnings and notes. Ignoring them could result in extensive damage and/or serious personal injury.

**Note:** Illustrations in this manual are used for reference only and may differ slightly from the actual vehicle; however, key components addressed in the manual are represented as accurately as possible.

## ii FOREWORD

---

### CRITICAL EMISSION-RELATED MAINTENANCE

#### **Source of parts and repair:**

A repair shop or person of the owner's choosing must maintain, replace, or repair emission control devices and systems per manufacturer's recommendations.

#### **Replacement of tires that are GHG certified:**

The original equipment tires installed on this vehicle at the factory were certified to the U.S. EPA Greenhouse Gas (GHG) and **National Highway Traffic Safety Administration (NHTSA)** Fuel Efficiency regulations. Replacement of these tires should be with a tire of equal or lower rolling resistance levels (TRRL or Crr). Please consult your tire supplier(s) for appropriate replacement tires.

#### **Maintaining a GHG certified tire:**

In order to maintain the certified rolling resistance of the tires which optimize fuel economy, the maintenance procedures provide by the tire manufacturer must be followed.

### EVENT DATA RECORDING DEVICES

This PREVOST vehicle is equipped with a device generally referred to as an "event data recorder" or "EDR." Please note that while the term "event data recorder" is typically used throughout the motor vehicle industry, not every EDR is the same; i.e., they do not all record the same data elements.

The EDR on this PREVOST vehicle records vehicle speed, engine RPM, time and date, plus a variety of pedal and switch positions, both before and after an "event." Sudden vehicle deceleration or the occurrence of certain other vehicle operational characteristics will define (trigger) an "event."

For any questions about this vehicle EDR device, contact a PREVOST Service Center or a regional service manager.



**SECTION 1     SAFETY PRECAUTIONS..... 1-1**

**SECTION 2     VEHICLE EXTERIOR ..... 2-1**

**SECTION 3     VEHICLE INTERIOR ..... 3-1**

**SECTION 4     CONTROLS AND INSTRUMENTS ..... 4-1**

**SECTION 5     OTHER FEATURES ..... 5-1**

**SECTION 6     STARTING AND STOPPING PROCEDURES..... 6-1**

**SECTION 7     SAFETY FEATURES AND EQUIPMENT ..... 7-1**

**SECTION 8     CARE AND MAINTENANCE ..... 8-1**

**SECTION 9     TECHNICAL INFORMATION..... 9-1**

**ABBREVIATIONS**

**APPENDIX A – SERVICE LITERATURE**

**APPENDIX B – TROUBLESHOOTING MULTIPLEX**

**APPENDIX C – ALLISON DIAGNOSTIC TROUBLESHOOTING CODES**

**APPENDIX D – TPMS TROUBLESHOOTING GUIDE**





**SECTION 1 SAFETY PRECAUTIONS**

**SAFE OPERATING PRACTICES ..... 2**

**DEFENSIVE DRIVING PRACTICES ..... 2**

**OTHER PRECAUTIONS ..... 3**

## 1-2 SAFETY PRECAUTIONS

---

### SAFE OPERATING PRACTICES

To ensure safe and reliable operation, heed the following safety precautions.

- Operation and maintenance of the vehicle must be performed only by qualified personnel.
- Before driving, conduct a walk around inspection and check that all baggage compartment doors and equipment access doors are securely shut.
- Make sure good visibility is maintained at all times. Keep windshields clean and free of obstructions.
- Adjust the driver's seat so that all controls can be reached easily.
- Always wear your safety belt when driving.
- Check the instrument panel frequently. Do not operate the vehicle when dials or indicators do not indicate normal operating conditions.
- Always pay attention to pedestrians passing in front and behind the vehicle. Always yield to pedestrians at pedestrian walkways.
- Do not drive over obstacles on the road. Empty boxes, piles of leaves, and snowdrifts could conceal hidden dangers that could damage the vehicle suspension and underbody.
- When turning or changing lanes, signal your intention well in advance.
- When approaching to make a right turn, reduce the space between the vehicle and the curb to make sure another vehicle cannot pass on the right. Since the vehicle makes wide turns, allow enough space to make safe turns.
- Switch from high beams to low beams when meeting or following other vehicles within 500 feet (150 meters).
- Never leave the vehicle unattended with the engine running or with the key in the ignition. Turn off the engine, remove keys and apply the parking brake before leaving the vehicle.
- Shut-off the engine before refueling, adding oil, performing maintenance or servicing tasks, unless stated otherwise.
- Fuel is highly flammable and explosive. Do not smoke when refueling. Keep away from open flames or sparks.
- Do not run the engine or HVAC system with access doors left open. Close compartment doors before operating any equipment.
- Do not remove the surge tank filler cap or the cooling system pressure cap when the engine is hot. Let the engine cool down before removing filler caps.
- Do not attempt to push or pull-start the vehicle.
- The service life of the vehicle depends on the kind of maintenance it receives. Always record any problems and report them immediately to maintenance personnel. After each trip, perform a system diagnostic to check if error codes and anomalies were recorded in the vehicle electronic modules.

### DEFENSIVE DRIVING PRACTICES

- For city driving, allow a four to six second travel interval between your vehicle and the vehicle ahead. Increase this travel interval to six to eight seconds for highway driving. Increase time interval for driving at night or in foul weather.
- Be prepared to stop when approaching an intersection. The stopping distance of the vehicle increases with the weight and speed.
- Establish eye-to-eye contact with other drivers and with pedestrians. Use, high beam and low beam headlights, turn signals and horn as needed.
- On highway, don't stare at the road ahead. Keep your eyes moving. Check mirrors and dashboard instruments frequently.
- To keep the vehicle from drifting across lanes during highway driving, always look over the horizon on the road ahead.
- Adjust your speed to road conditions, traffic and visibility. Never exceed the posted speed limits.
- If another vehicle is following close behind, reduce your speed to let the vehicle pass.

For additional information about safe operation and defensive driving practices, contact the local department of motor vehicles authority.

**OTHER PRECAUTIONS**

 <b>WARNING</b>
<p>Prior to working on a system inside vehicle, make sure to cut electrical power and air supply. A component could be supplied with electricity even if the ignition switch is set to the OFF position and/or a component could be pressurized even if air tanks are emptied. Always refer to the appropriate wiring and pneumatic diagrams prior to working on electrical and/or pneumatic systems.</p>

 <b>WARNING</b>
<p><b>CALIFORNIA PROPOSITION 65:</b></p> <p>Diesel engine exhaust and some of its constituents are known to the State of California to cause cancer, birth defects and other reproductive harm.</p> <p>Battery posts, terminals and other related accessories contain lead and lead compounds, chemical known to the State of California to cause cancer and other reproductive harm.</p> <p>Batteries also contain other chemicals known to the State of California to cause cancer.</p> <p><b>Wash hands after handling.</b></p>

<i><b>NOTE</b></i>
<p><i>When the ignition switch is set to the OFF position, the electrical components are not energized except for the CECM (Chasis Electronic Control Module), the battery equalizer, the preheater system and some electronic modules; which are energized during 15 minutes after the ignition has been set to the OFF position. Prior to working on one of these electrical components, set the battery master switch in the main power compartment to the OFF position. If the vehicle will not be operated for a long period (more than 2 weeks), it is recommended, in order to prevent the batteries from discharging, to trip the main circuit breakers located in the main power compartment to stop the small current drawn by the radio preset station memory, the CECM memory and the instrument cluster clock. Note that the radio station presets will be erased, same thing for the diagnostic codes history and the instrument cluster clock will have to be reset.</i></p>

 <b>CAUTION</b>
<p>Prior to arc welding on the vehicle, refer to section 00-GENERAL of your maintenance manual. Precautions have to be taken to avoid costly damage to the electronic components.</p>



**SECTION 2 VEHICLE EXTERIOR**

**EXTERIOR VIEW.....2**

**ENGINE COMPARTMENT CURBSIDE DOOR.....3**

**ENGINE COMPARTMENT DOOR.....3**

**DPF ACCESS DOOR.....4**

**MAIN POWER COMPARTMENT (BATTERY).....4**

**ENGINE RADIATOR DOOR.....5**

**SCR CATALYTIC CONVERTER ACCESS HATCH.....5**

**CONDENSER COMPARTMENT (WITH OPTIONAL CENTRAL A/C SYSTEM).....5**

**EVAPORATOR COMPARTMENT (WITH OPTIONAL CENTRAL A/C SYSTEM).....6**

**FRONT ELECTRICAL AND SERVICE COMPARTMENT.....7**

**RECLINING BUMPER COMPARTMENT.....7**

**BAGGAGE COMPARTMENTS.....7**

**FUEL AND DIESEL EXHAUST FLUID (DEF) FILLER NECK ACCESS DOOR.....8**

    ENTRANCE DOOR.....8

    INSIDE OPERATION.....8

    OUTSIDE OPERATION.....9

    KEYLESS ENTRY SYSTEM.....9

**EXTERIOR REAR VIEW MIRRORS.....9**

    ELECTRICALLY ADJUSTED MIRROR.....9

**RETRACTABLE BACK-UP CAMERA.....10**

**120 VOLTS CONNECTOR.....10**

**TRAILER HITCH.....10**

## 2-2 VEHICLE EXTERIOR

### EXTERIOR VIEW

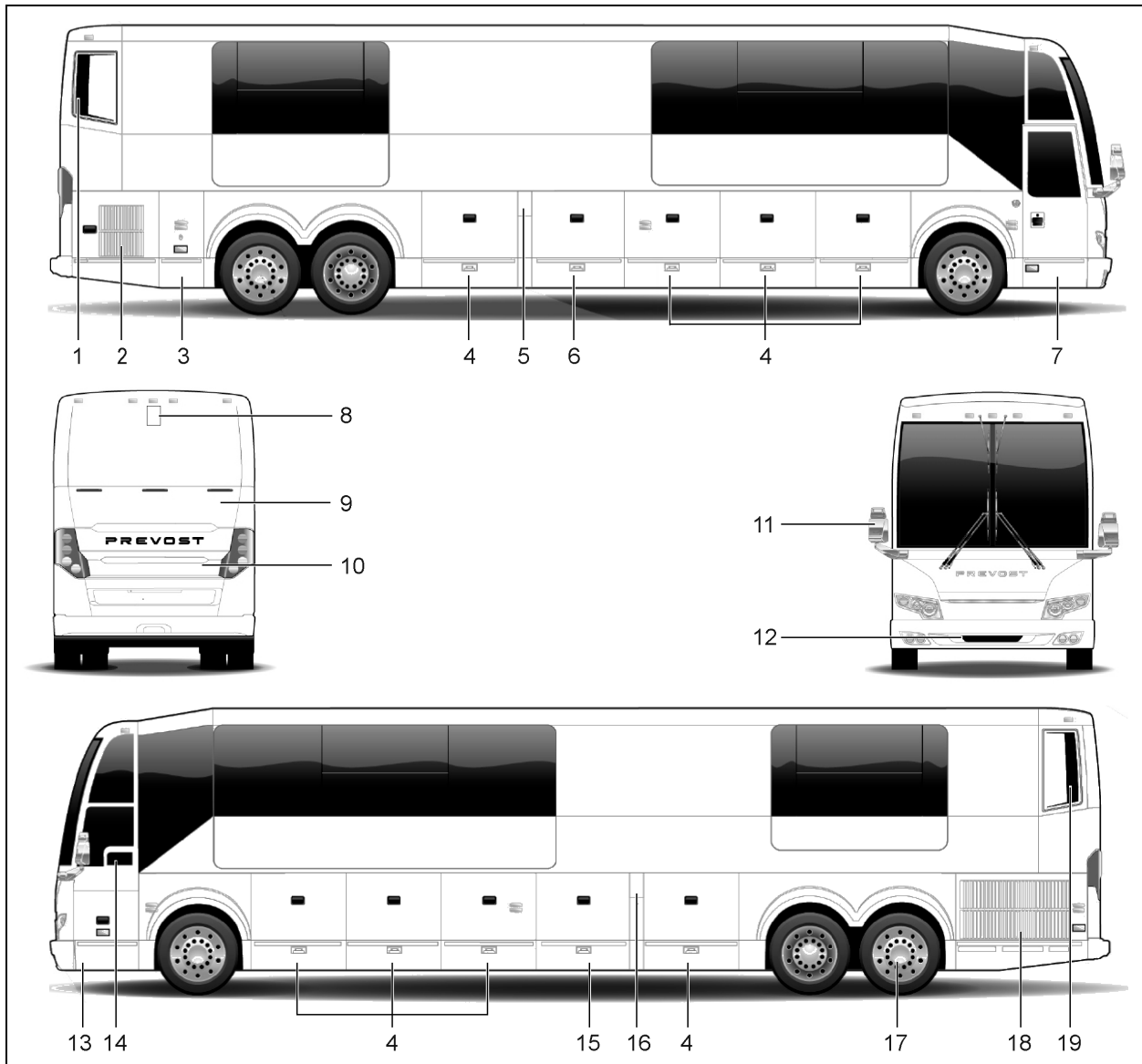

H3-45 VIP EXTERIOR VIEW

18688

- |   |   |
|---|---|
| 1. Engine air intake                                | 12. Reclining bumper compartment  |
| 2. Engine R.H. side access door                     | 13. Front electrical and service compartment  |
| 3. Main power compartment                           | 14. Driver's power window   |
| 4. Baggage compartment                              | 15. Heating, ventilating and air conditioning compartment (HVAC) or baggage compartment |
| 5. Fuel filler neck access door                     | 16. Fuel filler neck and diesel exhaust fluid (DEF) filler neck access door             |
| 6. A/C condenser compartment or baggage compartment | 17. Auxiliary axle  |
| 7. Entrance door                                    | 18. Engine radiator door  |
| 8. Retractable back up camera (optional)            | 19. SCR catalytic converter access door   |
| 9. Diesel Particulate Filter (DPF) access door      |   |
| 10. Engine compartment rear door                    |   |
| 11. Rear-view mirror                                |   |

**ENGINE COMPARTMENT CURBSIDE DOOR**

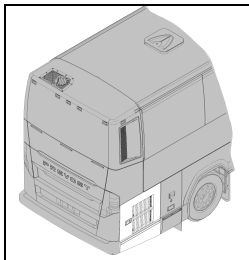

Lock this door using the exterior compartment key. Lift up protector cover to gain access to the lock. Pull up the door handle to release the latch and then pull the door open.

The curbside door has a safety catch on top to prevent it from closing inadvertently. Release the safety catch before closing the door.

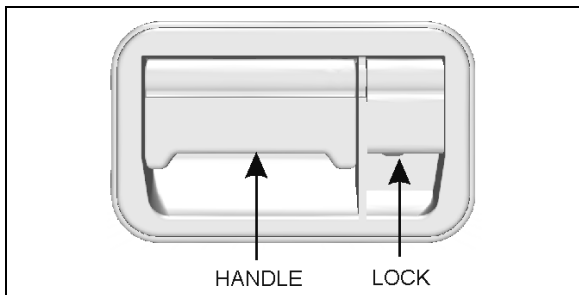

DOOR HANDLE

18184

The engine compartment curbside door provides access to the following (if equipped)

- Engine compartment rear door release lever
- Fuel Pro 382 filtration system (optional)
- Primary and secondary air system fill valve
- Booster block terminals
- Wet air tank drain valve
- Engine air filter
- Engine block heater connector
- Power steering fluid reservoir
- Battery charger 110-120 volts connector



**WARNING**

Unless otherwise stated, do not run the engine when the engine compartment curbside door is open.

**ENGINE COMPARTMENT DOOR**

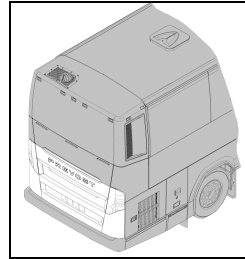

To open engine compartment door, first open engine compartment curbside door. Lift the latch release lever, place hand on the upper right of the rear door and pull rearward.

Then, using both hands, lift the door up. Always engage the safety catch when the engine compartment rear door is open. Release the catch before closing the door.

The lighting in the engine compartment turns on automatically when that door is open if the engine compartment light switch is set to ON and the ignition key is set to ON or ACC. Use this switch to turn off the light if it is not required when the door is open for an extended period. When open or not closed properly, an annunciator pictogram will appear on the instrument cluster DID. To close the door, lift it slightly and release the safety catch.

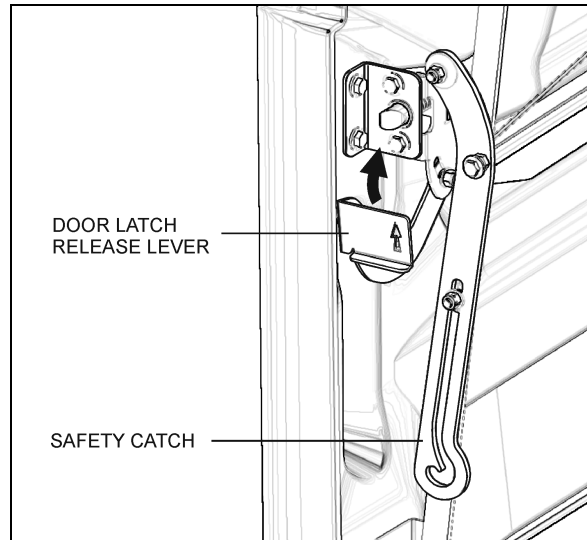

OPENING THE ENGINE COMPARTMENT DOOR

18331

The engine compartment rear door provides access to the following:

- Engine
- Alternators
- Compressors
- Belt tensioner control valve (see *Care and Maintenance* chapter)
- Starter selector switch (see *Starting and Stopping Procedures* chapter)
- Engine cooling fluid surge tank and filler cap

## 2-4 VEHICLE EXTERIOR

- Engine air filter restriction indicator
- Engine oil dipstick
- Engine oil filler cap
- Allison transmission oil dipstick & filler tube



### WARNING

Pressurized cylinders assist the engine compartment door opening. To avoid injury, stand clear when opening the engine compartment rear door.



### WARNING

Unless otherwise stated, avoid running the engine when the engine compartment door is open.

### DPF ACCESS DOOR

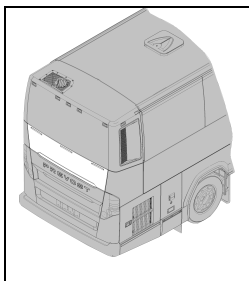

The engine door must be open before opening the diesel particulate filter access door. To open the DPF access door, press the latch release lever. Using both hands, push the door up until it locks in place.

To close the door, press the latch release lever again and lower the door, holding it with both hands.



### WARNING

Proceed with extreme care when opening the DPF access door. Hold the door with both hands and never place your fingers behind the door panel.

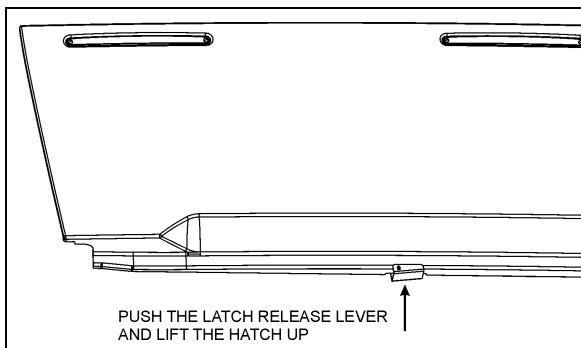

**DIESEL PARTICULATE FILTER ACCESS DOOR**

### MAIN POWER COMPARTMENT (BATTERY)

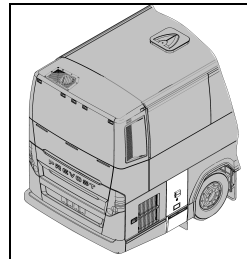

To unlock the main power compartment door, use the exterior compartment door key. The door will pop open.

The lighting in the compartment turns on automatically when the door is open if the ignition key is set to ON or ACC. When the main power compartment door is open, an annunciator pictogram appears on the instrument cluster DID.

The main power compartment provides access to the following:

- (4x) 12-volt batteries
- 12-volt and 24-volt electrical systems main circuit breakers for
- Battery charger (optional)
- Vanner battery equalizer
- Battery master switch
- Transmission Electronic Control Unit (TECU)
- Multiplex modules: I/O-A, I/O-B
- Rear fuse box (VECR) & spare fuses
- Relays and diodes
- Electronic ground stud

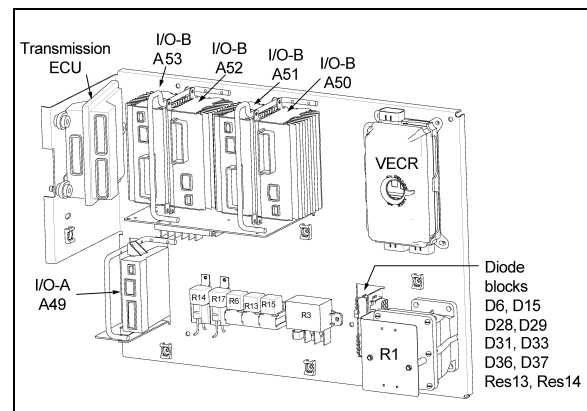

**PARTIAL VIEW OF MAIN POWER COMPARTMENT**



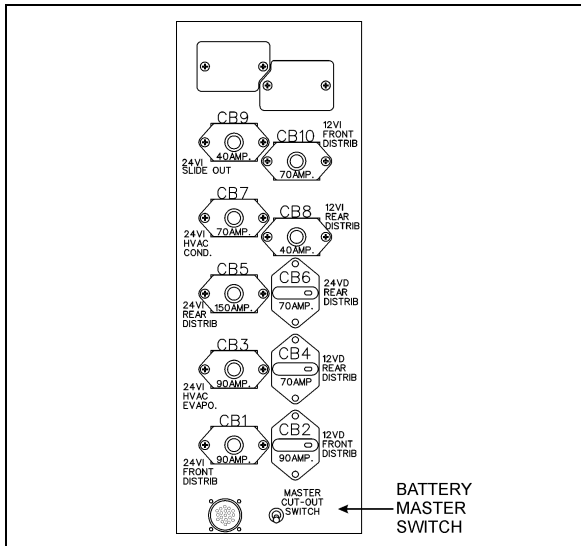

MAIN CIRCUIT BREAKERS 12-VOLT & 24-VOLT 06605A

**ENGINE RADIATOR DOOR**

Open the engine radiator door by pushing on the release latch located on the left side, behind the louvers.

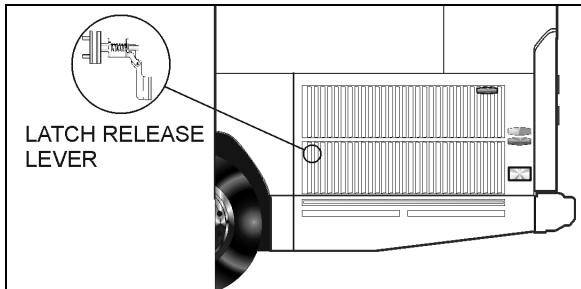

RADIATOR DOOR RELEASE LATCH LOCATION 18529

**SCR CATALYTIC CONVERTER ACCESS HATCH**

To gain access to the SCR catalytic converter:

1. Open the radiator door first;
2. Pull the catch connecting rod to unlock the access hatch;
3. Lift the hatch open;
4. Hold the door open by inserting the support rod free end into the receptacle located on the left side of the door.

**WARNING**

After inserting the support rod into the receptacle, make sure that the rod supports the door securely from falling down on to your head or body.

**WARNING**

External and internal temperatures remain hot long after engine has been shutdown. Allow the aftertreatment device and DPF to cool before handling. Wear protective clothing and glove while servicing.

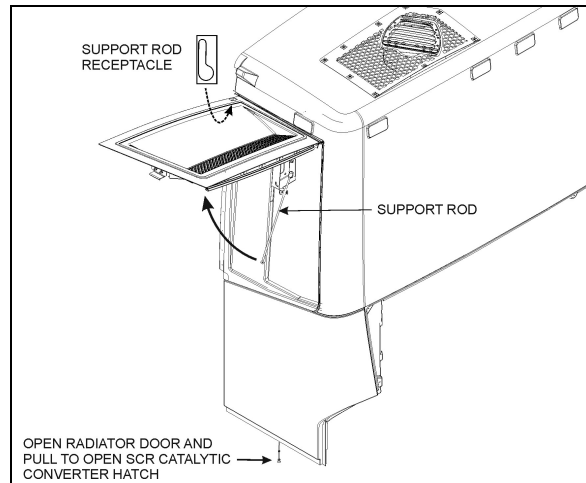

ACCESSING THE SCR CATALYTIC CONVERTER 04035

**CONDENSER COMPARTMENT (with optional central A/C system)**

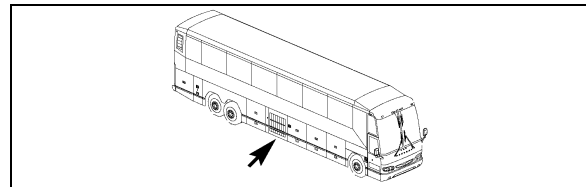

To open the condenser compartment door:

1. Open the fuel filler door first;
2. Move the latch bolt pin to the right as shown (step 1 on image);
3. Rotate the latch handle as shown (step 2);
4. Open the door on the right side when facing the door.

## 2-6 VEHICLE EXTERIOR

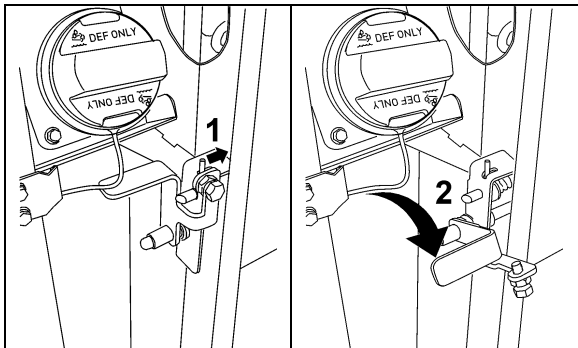

**A/C CONDENSER COMPARTMENT DOOR OPENING**

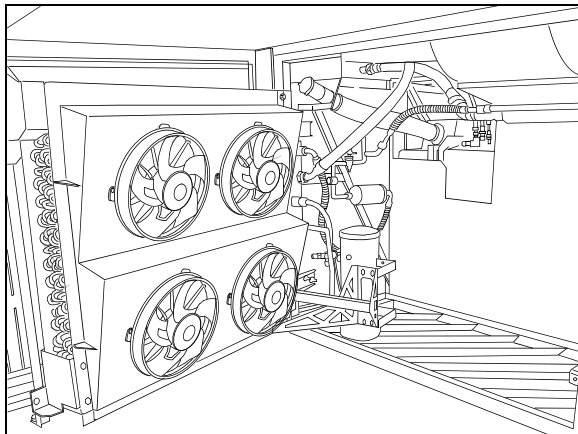

**CONDENSER COMPARTMENT (WITH CENTRAL A/C SYSTEM, DEF TANK NOT SHOWN)**  
22362

### **EVAPORATOR COMPARTMENT (with optional central A/C system)**

Find the evaporator compartment door release latch on the left wall of the adjacent baggage compartment. Pull the release latch then pull the evaporator compartment door open.

The evaporator compartment contains relays, diodes and an I/O-B multiplex module mounted on a panel located on the R.H. side wall when facing the compartment.

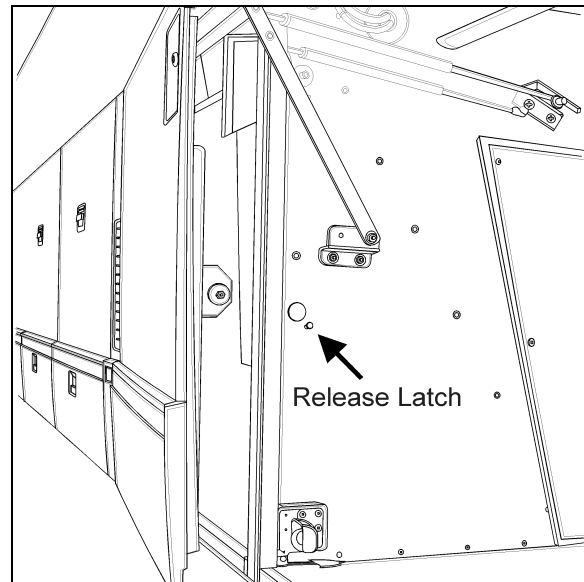

**EVAPORATOR COMPARTMENT ACCESS**

18306

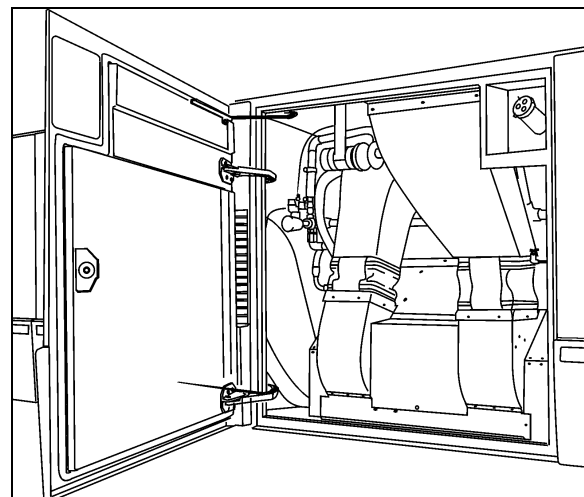

**EVAPORATOR COMPARTMENT (WITH CENTRAL A/C SYSTEM ONLY)**

22365

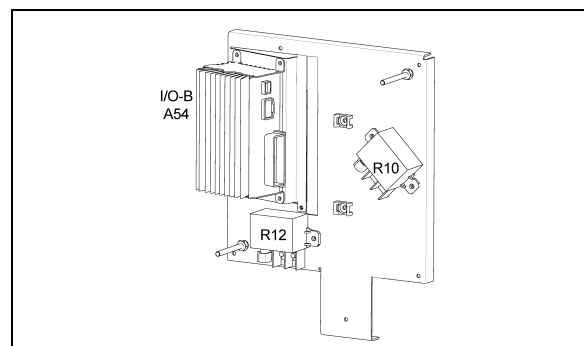

**HVAC COMPONENTS PANEL**

06596B

#### **NOTE**

*It is important to keep the evaporator compartment door closed while checking the HVAC system to prevent faulty readings.*

### FRONT ELECTRICAL AND SERVICE COMPARTMENT

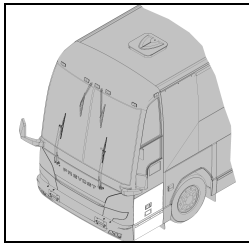

Unlock this compartment door using the exterior compartment key. Pull up door handle to release the latch then pull the door open.

The lighting in the front electrical & service compartment turns on automatically when the door is open if the ignition key is set to ON or ACC.

The front electrical and service compartment provides access to the following:

- Front fuse box (VECF) & spare fuses
- ABS module
- Multiplex modules: I/O-A, I/O-B
- Relays & diode blocks
- Windshield washer reservoir
- Headlights washer reservoir
- Reclining bumper opening lever
- Accessory air tank drain valve
- Accessory air tank fill valve
- Electronic ground stud
- MCM module
- Keyless entry module
- Tire Pressure Monitoring System module

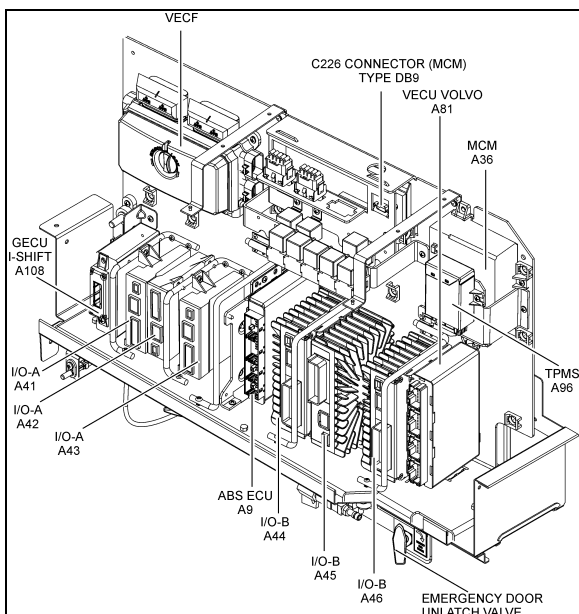

FRONT ELECTRICAL & SERVICE COMPARTMENT 06665

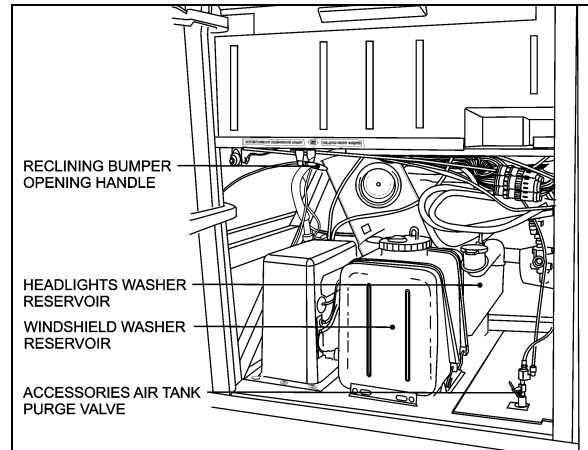

FRONT ELECTRICAL & SERVICE COMPARTMENT 14066

### RECLINING BUMPER COMPARTMENT

The front bumper can be tilted downward to give access to the compartment. Pull the opening handle located in the front electrical and service compartment to unlock. Tilt down the bumper to access the compartment. Push the bumper back up firmly in place to lock in position.

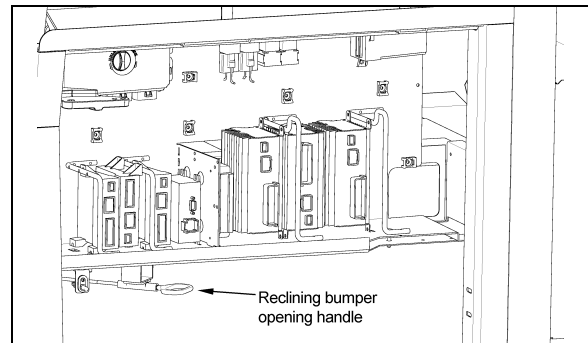

RECLINING BUMPER OPENING HANDLE

06602



### WARNING

The compartment behind the bumper is not designed for storage. Never store loose objects in this compartment since they can interfere with the steering linkage mechanism.

Use care when opening or closing the reclining bumper compartment to prevent personal injury

### BAGGAGE COMPARTMENTS

The baggage compartment doors can be locked and unlocked using the exterior compartment key. Lift up the cover to gain access to the lock.

## 2-8 VEHICLE EXTERIOR

Pull up door handle to release the latch and then pull the door open. Pressurized cylinders assist the opening and closing of the baggage compartment doors and hold the doors open.

The lighting in the baggage compartments turns on automatically when the door is opened if the ignition key is set to ON or ACC.



### WARNING

To avoid injury, keep hands clear of door edge and door frame when closing.

### NOTE

To prevent theft and vandalism, always lock all doors before leaving the vehicle unattended.

### NOTE

The baggage compartment doors can also be locked and unlocked using:

- The baggage compartments central locking system switch on the L.H. dashboard (refer to Controls and Instruments chapter).
- The keyless entry system.
- The remote entry transmitter (refer to Controls and Instruments chapter).

## FUEL AND DIESEL EXHAUST FLUID (DEF) FILLER NECK ACCESS DOOR

These access doors must be opened with the exterior compartment key. To open, turn the key ¼ turn clockwise. Hold the door with your hand as you open the door. Open the street side filler neck access door to gain access to the DEF filler neck.

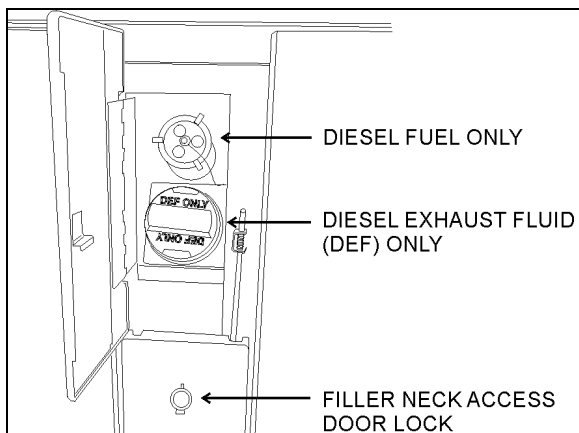

STREET SIDE FUEL AND DEF FILLER NECK ACCESS DOOR 03093

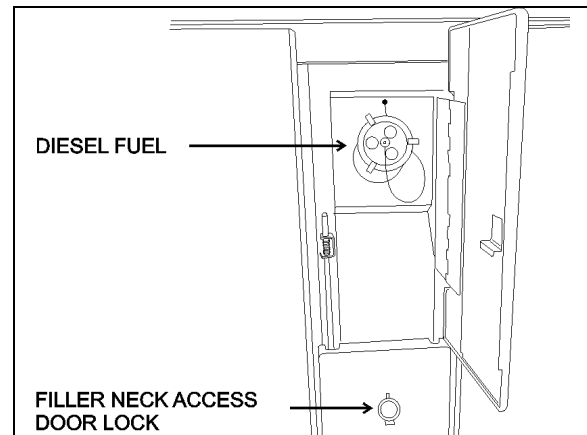

CURBSIDE FUEL FILLER NECK ACCESS DOOR 03093

### NOTE

Provided the vehicle is parked on level ground, an automatic nozzle will automatically shut off when tank is approximately 95% full.



### CAUTION

Do not fill to more than 95% of the tank capacity. Do not "top off" the tank, doing so may result in fuel spillage when the fuel expands.



### CAUTION

Diesel exhaust fluid DEF will begin to crystallize and freeze at 12°F (-11°C) and expand by 7% when frozen. To allow expansion without damaging the DEF tank, do not fill the tank with more than 15.9 gallons (60 liters).

## ENTRANCE DOOR

### INSIDE OPERATION

Lock or unlock the entrance door from the inside either by actuating the front entrance door rocker switch on the R.H. dashboard panel or using the door inside lock knob.

### NOTE

If the alarm system is armed, unlocking the entrance door from the inside by sliding its lock knob will not disarm the alarm system. The alarm will sound.

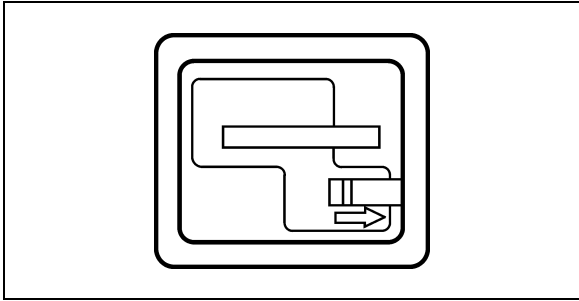

DOOR LOCK KNOB INSIDE THE VEHICLE  
18187

**OUTSIDE OPERATION**

The first way of locking and unlocking the entrance door from the outside is the front entrance door lock key provided with the vehicle. Turn key counterclockwise to lock or clockwise to unlock the entrance door and disarm the intrusion protection and anti-theft system.

**NOTE**  
*The stepwell lights and entrance overhead light turn on as the door opens.*

**NOTE**  
*For complete information regarding the Keyless Entry System & Anti-theft Alarm System, refer to the document included in your vehicle's "publication box".*

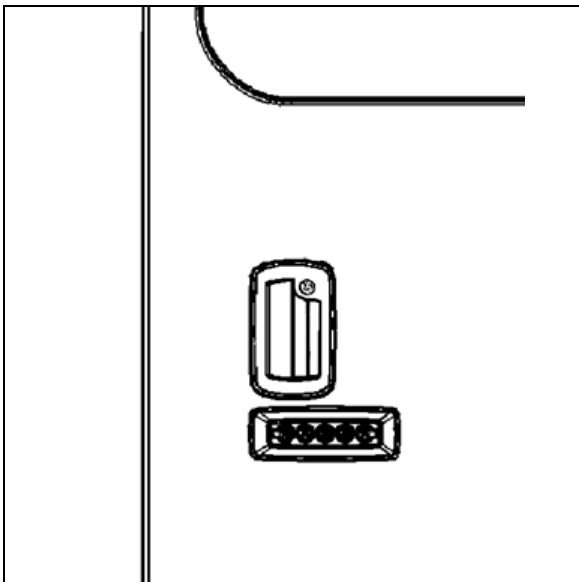

DOOR HANDLE & KEYLESS ENTRY SYSTEM KEYBOARD

**KEYLESS ENTRY SYSTEM**

This system, located below the entrance door handle, is used to lock or unlock the entrance door, the baggage compartment and the service compartment. A master code is permanently preprogrammed in the module by the manufacturer to use as a default code. This code is supplied to the owner of the vehicle and will allow the storage of up to 40 personal alternate codes.

**NOTE**  
*Refer to "Other Features" chapter for complete keyless system operating instructions.*

**EXTERIOR REAR VIEW MIRRORS**

The coach is equipped with flat-type and convex-type rear-view mirrors. Convex mirrors give a wide angle view. Objects viewed in convex-type rear-view mirrors appear smaller and are actually closer than they appear.

To provide good visibility in cold weather, the mirrors may be equipped with heating elements activated by a rocker switch located on the dashboard. Refer to *Controls and Instruments* chapter. Thermostats are used to prevent continuous operation of the heating elements.

**CAUTION**  
Do not attach stick-on type convex mirror accessories to the heated mirror glass. This could impede uniform heat distribution on the mirror surface and could break the mirror glass.

**ELECTRICALLY ADJUSTED MIRROR**

Electrically adjusted mirrors are adjusted by the outside mirror controls located on the L.H. control panel. Refer to *Controls and Instruments* chapter. Manual adjustment is also possible.

Adjust the side-view mirrors until the side of the vehicle is visible. Adjust the flat-type mirror until the road behind is in full view.

## 2-10 VEHICLE EXTERIOR

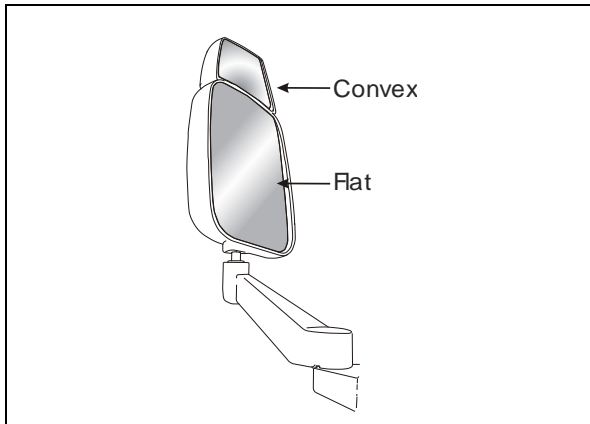

RAMCO REAR-VIEW MIRROR

18443

### RETRACTABLE BACK-UP CAMERA

An optional back-up camera is available which provides the driver with visual assistance when backing-up. The back-up camera is mounted in a retractable housing. For additional information, refer to *Controls and Instruments* and *Care and maintenance* chapters.

#### **NOTE**

A switch located in the rear electric compartment is used to retract the back-up camera for cleaning or maintenance.

### 120 VOLTS CONNECTOR

This connector is used with a 120 volts supply and is connected to the optional engine block heater. Refer to *Starting and Stopping Procedures* chapter.

### TRAILER HITCH

Your vehicle may be equipped with a factory installed trailer hitch which has been designed to meet the following rating:

- **Maximum gross trailer weight: 20,000 lbs (9072 kg)**
- **Maximum tongue weight at 6 1/2 inches (165 mm) or less from coupling receiver : 1,500 lbs (680 kg)**

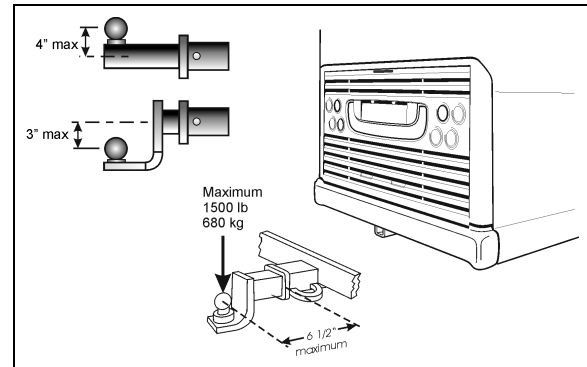

TRAILER HITCH

18487



### WARNING

The draw bar and the ball used for towing the trailer should be rated for 20,000 lb capacity or more.



### WARNING

Pulling a trailer weighing more than the recommended maximum gross weight may cause engine and transmission overheating, and also possible hitch failure.

#### **NOTE**

Pulling a trailer over long distances is considered as a "severe operating condition" for the vehicle and therefore, power plant requires more frequent servicing.



### CAUTION

The minimum requirement for a trailer weighing up to 20,000 lbs when coupled to a 20,000 lb Prevest Trailer Hitch is as per the following:

- A) Trailer must comply with **Federal Motor Carrier Safety Regulations 393.52** regarding trailer breaking capability.
- B) The trailer coupling attachments meet the following minimum static test load requirements :
  - Longitudinal tension and compression: (1.5 x GVWR of trailer)

- Transverse thrust : (0.5 x GVWR of trailer)
- Vertical tension and compression: (0.5 x GVWR of trailer)

Loads indicated must be applied without incurring loss of attachments or distortion or failure which could affect the safe towing of trailer.

C) The ball and trailer coupling should meet the following minimum test load requirements without incurring failure :

- Longitudinal tension and compression : (Gross Trailer Weight of trailer x 3)
- Transverse thrust : (Gross Trailer Weight of trailer x 1)
- Vertical tension and compression : (Gross Trailer Weight of trailer x 1.3)

In this case, failure is identified as the point at which the coupling or ball will accept no additional test load without separation of the ball from the coupling ball socket, or the occurrence of a metal fracture of either coupling ball or coupling assembly, which results in separation of the ball from the coupling ball socket.

D) Two lengths of safety chain shall be used. The strength rating (minimum breaking force) of each individual chain and its connecting means shall be equal to, or exceed the trailer GVWR.

E) Towing vehicle must be equipped with engine or transmission retarder. The engine or the transmission retarder on the vehicle must be functional at all time (to be inspected frequently).

This hitch must be used for recreational use only.





**SECTION 3      VEHICLE INTERIOR**

**DRIVER'S SEAT - "DELIVERY" ..... 2**

**ISRI DRIVER'S AND NAVIGATOR'S SEATS (OPTIONAL) ..... 2**

    PNEUMATIC ISRI SEATS .....2

    ELECTRIC ISRI SEATS .....2

**SAFETY BELTS..... 3**

**STEERING WHEEL ADJUSTMENT ..... 3**

**SUNSHADES (BLINDS)..... 4**

**INSIDE MIRRORS ..... 4**

**ADJUSTABLE HVAC REGISTERS ..... 4**

**WINDOWS ..... 4**

    DRIVER'S POWER WINDOW .....4

    FIXED WINDOWS .....5

    AWNING WINDOWS .....5

    SLIDING WINDOWS.....5

## 3-2 VEHICLE INTERIOR

### DRIVER'S SEAT - "DELIVERY"

The driver's "delivery" seat is standard and legal only for driving the vehicle on its initial delivery. It is a conventional van seat equipped with tracks for fore and aft adjustments.

### ISRI DRIVER'S AND NAVIGATOR'S SEATS (OPTIONAL)

Two distinct ISRI model driver's and navigator's seats may be supplied with your vehicle: both with a sophisticated air suspension system, one being pneumatically operated, while the other is electrically operated. Both seats may be equipped with lumbar supports, heated cushions and adjustable armrests. Seats can be adjusted to the desired driving position by following the instructions listed below.

#### PNEUMATIC ISRI SEATS

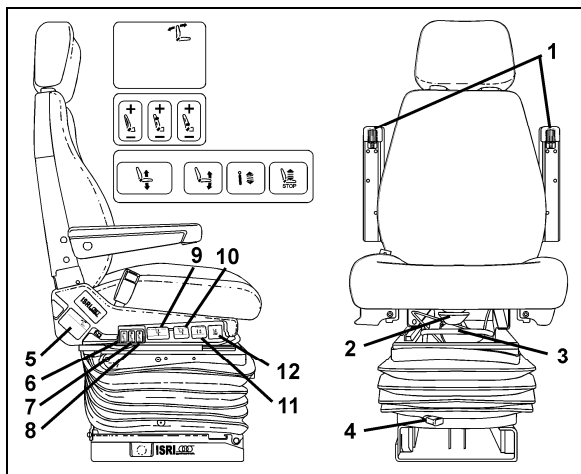

PNEUMATIC DRIVER'S SEAT

18385



### WARNING

Never try to adjust seat while driving vehicle as this could result in loss of vehicle control.

#### 1 Armrest

Rotate control knob to select desired arm-resting angle. When not in use, raise armrest parallel with backrest.

#### 2 Seat Cushion

Provides optimum comfort and support for any leg shape or size. Adjustable to 2" (50 mm) length.

#### 3 Fore-and-aft

Pull handle up and slide seat forwards or backwards to adjust distance between seat and dashboard.

#### 4 Isolator

Reduces horizontal vibration, ensuring smooth ride.

#### 5 Backrest

Lift lever to select proper adjustment angle of backrest.

#### 6 Air Side Bolster

Offers desired side support to avoid body sideway.

#### 7 Air Lumbar

Provides back support with upper settings, ensuring comfort during lengthy sitting.

#### 8 Air Lumbar

Provides back support with lower settings, ensuring comfort during lengthy sitting.

#### 9 Air Height Adjustment

Moves seat up or down independently of other seat settings. 100mm total travel.

#### 10 Adjustable Seat Recline

Allows easy adjustment of four-setting inclination.

#### 11 Adjustable Shock Absorber

Choose stiff or soft ride infinitely.

#### 12 Quick Air Release

Exhausts all air from suspension, allowing for easy entry/exit. Returns seat to previous position.

#### ELECTRIC ISRI SEATS

Adjust electric seats as follows:

#### 1 Tilt (rear)

Pull switch up to raise rear section of seat. Push switch down to lower rear section of seat.

#### 2 Fore-and-aft/Up-Down

Push switch towards dashboard to move seat forwards or back to move seat backwards. Pull switch up to raise seat or push switch down to lower seat.

#### 3 Tilt (front)

Pull switch up to raise front section of seat. Push switch down to lower front section of seat.

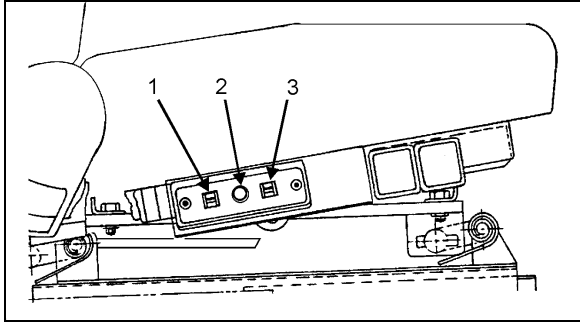

SEAT CONTROLS

18040

**SAFETY BELTS**

The driver's seat is equipped with a retractable safety belt as required by State, Provincial and Federal regulations. To fasten, pull seat belt out of the retractor and insert the latch plate into the buckle until it clicks. No special adjustment is required since the reel device is self-adjusting. If seat belt operation becomes defective, report to Manufacturer's Service Center.

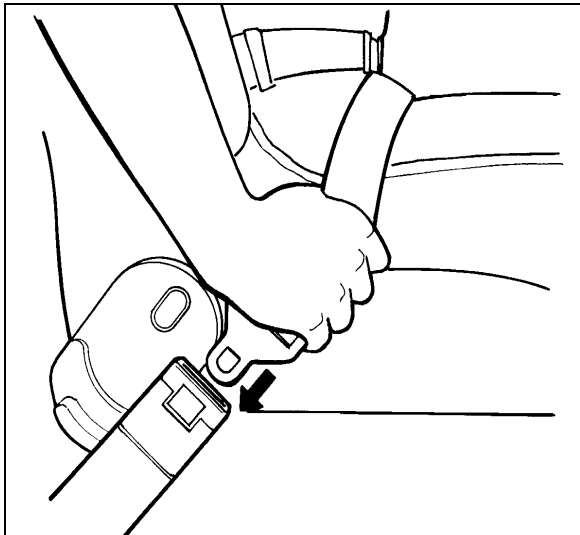

SEATBELT

18028

**NOTE**

*The safety belt must be pulled out slowly and continuously, otherwise it will lock the reel before the latch plate reaches the buckle. If this happens, allow the belt to retract completely and repeat the procedure correctly.*



**WARNING**

A snug fit with the lap belt positioned low on the hips is necessary to ensure motorist's safety. The belt should not be worn twisted. Avoid pinching belt and/or belt hardware in seat mechanism. Do not wear belt over rigid or breakable objects, such as eyeglasses, pens or keys as these may cause injuries.



**CAUTION**

Never bleach or dry-clean safety belt.



**WARNING**

Safety belts should always be worn by motorists using seats supplied with belts since this is required by most State and Provincial laws.

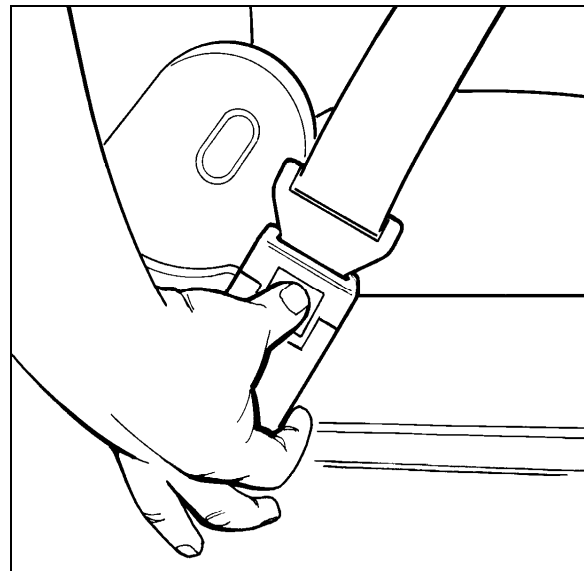

SEATBELT

18029

**STEERING WHEEL ADJUSTMENT**

Push on the valve button with the left foot to unlock the steering wheel for tilt and telescopic adjustment.

## 3-4 VEHICLE INTERIOR



### WARNING

Do not adjust the steering wheel while the vehicle is moving. Loss of control could result. Park the vehicle safely and apply parking brakes before adjusting the steering wheel.

### SUNSHADES (BLINDS)

This vehicle is provided with two electrically operated sunshades which are installed on both sides of the windshield. Push up or down the appropriate switch to raise or lower the shade to the desired position.

Moreover, an optional spring release type sunshade is provided for the driver's window to protect him from side glare. To operate, pull down the shade by its hem to the appropriate position and release it. It will remain automatically in position. To lift, depress the unlocking lever.

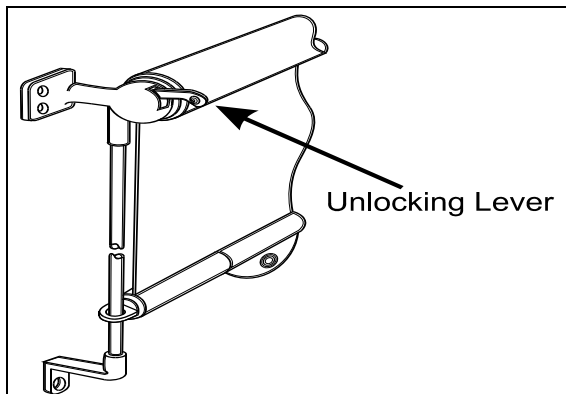

SPRING RELEASE SUNSHADE

23019

### INSIDE MIRRORS

Two mirrors are located in the driver's area. The left overhead mirror provides visibility in the critical area on the R.H. side of the private coach. Adjust the left overhead mirror to see through the front cabin windows. The central mirror allows the driver to see in the central cabin aisle.

### ADJUSTABLE HVAC REGISTERS

The HVAC system has adjustable registers to control air flow around the driver's and navigator's area.

- Three are located on the dashboard, two on the R.H. side and one on the left (refer to *Controls and Instruments* chapter).
- Two more registers are located near the steering wheel column, under the dashboard. These registers are not adjustable but may be electrically open or closed by means of the HVAC control panel.
- Three auxiliary unit registers are located behind the driver (with small HVAC system only).
- For the navigator, two adjustable registers are located near the entrance door, at bottom of first lateral window (refer to *Controls and Instruments* chapter).

Use the HVAC control panel to set air temperature.

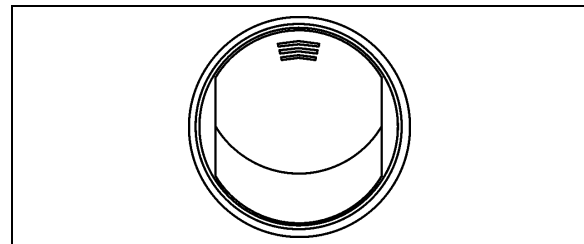

DASHBOARD AIR REGISTER

22287

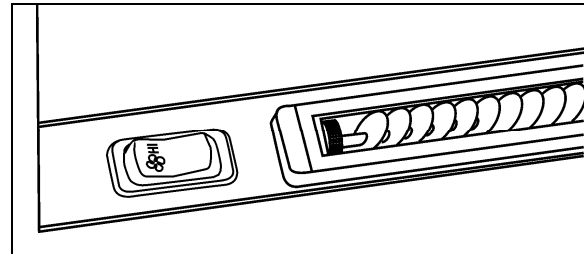

NAVIGATOR'S AIR REGISTER & FAN SPEED CONTROL SWITCH

22286

### WINDOWS

The vehicle is equipped with single pane or double pane (thermos) windows. There is one automobile-like power window and a possible combination of three types of side windows, all of them flush-mounted to the structure: fixed, awning and sliding windows. Following is a description and operating instructions for these types of windows:

#### DRIVER'S POWER WINDOW

The driver's area is equipped with a power window. The window is controlled by a rocker switch located on the L.H. control panel. Refer to *Controls and Instruments* chapter.

**FIXED WINDOWS**

These windows are either fastened or glued to the structure and form an integral part of the body of the vehicle, helping reduce vibration and noise. Fixed windows cannot be opened.

**AWNING WINDOWS**

To open or close an electrically-operated awning window, use the rocker switch button located on the wall, next to the window. After closing the window, maintain the rocker switch button depressed to latch the window.

**NOTE**  
*The awning window electrical circuit is equipped with a thermistor protecting the components from overheating. If the awning window is opened and closed repeatedly, causing overheating of the components, the thermal protection will interrupt the operation of the window for a short while to permit cooling down of the components. This feature also prevents personal injuries and damages to the components if something obstructs the window movement.*

**CAUTION**  
 Avoid holding the rocker switch button depressed after the window has reached its full opened position or after the window has been latched.

**CAUTION**  
 Never try to open or close the awning window by pulling or pushing directly on the window, this could damage the opening mechanism gearbox.

A pop-up pictogram will appear in the DID when an awning window is opened. Refer to *Controls and Instruments* chapter for more information.

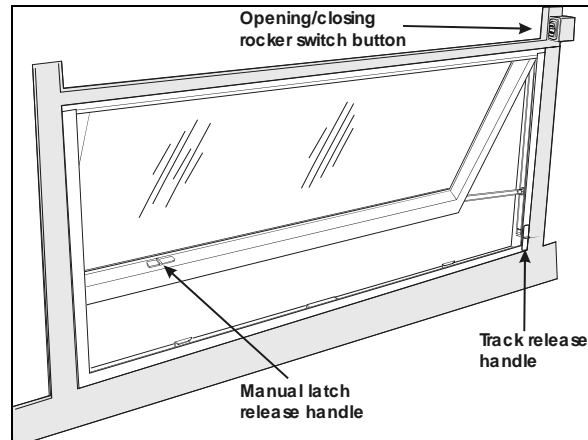

**ELECTRIC AWNING WINDOW**

18585

**SLIDING WINDOWS**

To open or close an electrically-operated sliding window, use the rocker switch button located on the wall, next to the window.

**CAUTION**  
 Never try to open or close the awning window by pulling or pushing directly on the window; this could damage the opening mechanism gearbox.

**NOTE**  
*If the sliding window electrical circuit is inoperative, the power sliding window can be manually closed by removing the lateral plastic trim located on the R. H. side of the window to access the drive belt. Manually move the drive belt to close the window.*

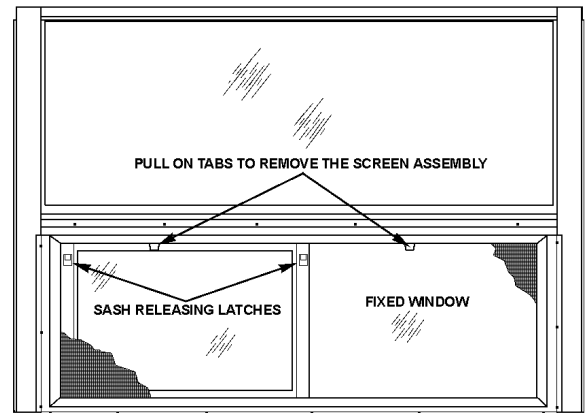

**SLIDING WINDOW**

18206

## 3-6 VEHICLE INTERIOR

---

***NOTE***

*The sliding window electrical circuit is equipped with a thermistor protecting the components from overheating. If the sliding window is opened and closed repeatedly, causing overheating of the components, the thermal protection will interrupt the operation of the window for a short while to permit cooling down of the components. This feature also prevents personal injuries and damages to the components if something obstructs the window movement.*

## **SECTION 4            CONTROLS AND INSTRUMENTS**

<b>KEYS .....</b>	<b>3</b>
FRONT ENTRANCE DOOR LOCK KEY .....	3
EXTERIOR COMPARTMENTS KEY .....	3
UTILITY COMPARTMENT KEY .....	3
<b>REMOTE ENTRY TRANSMITTER.....</b>	<b>ERREUR ! SIGNET NON DEFINI.</b>
IGNITION SWITCH.....	4
<b>DRIVER'S AREA .....</b>	<b>5</b>
<b>LATERAL CONTROL PANEL .....</b>	<b>6</b>
① TRANSMISSION CONTROL KEYPAD.....	6
② CONTROL SWITCHES .....	6
③ MIRROR CONTROLS.....	7
④ ⑤ ⑥ LEVEL LOW SYSTEM .....	7
⑦ PARKING BRAKES CONTROL VALVE .....	8
⑧ AUXILIARY AXLE CONTROL VALVE .....	8
⑨ TRAILER AIR SUPPLY CONTROL VALVE (OPTIONAL) .....	8
(10) (11) UTILITY COMPARTMENT & 12-VOLT DC POWER OUTLET .....	8
(12) ASHTRAY.....	8
(13) CIGAR LIGHTER.....	9
DIAGNOSTIC TOOL RECEPTACLE .....	9
AUTOMATIC FIRE DETECTION AND SUPPRESSION SYSTEM (AFSS) .....	9
REGULAR CRUISE CONTROL.....	9
PREVOST AWARE • ADAPTIVE CRUISE BRAKING .....	11
TIRE PRESSURE MONITORING SYSTEM (TPMS).....	16
<b>DASHBOARD .....</b>	<b>20</b>
CONTROL SWITCHES.....	21
L. H. INSTRUMENT PANEL.....	21
R.H. INSTRUMENT PANEL .....	25
HVAC CONTROL UNITS .....	26
VEHICLES EQUIPPED WITH SMALL HVAC SYSTEM .....	26
<b>HVAC AIR REGISTERS .....</b>	<b>26</b>
<b>NAVIGATOR AIR REGISTERS.....</b>	<b>27</b>
<b>INSTRUMENT CLUSTER .....</b>	<b>30</b>
ANALOG INDICATORS .....	31
TELLTALE LIGHTS .....	34
STOP, CHECK AND INFORMATION TELLTALE LIGHTS .....	37
DRIVER INFORMATION DISPLAY .....	37
PICTOGRAMS DISPLAYED ON THE DRIVER INFORMATION DISPLAY (DID) .....	40
VEHICLE CLEARANCE INFORMATION.....	47
<b>STEERING COLUMN CONTROLS .....</b>	<b>47</b>
MULTI-FUNCTION LEVER .....	47

## 4-2 CONTROLS AND INSTRUMENTS

---

STEERING WHEEL CONTROLS .....	48
HORNS.....	49
TRANSMISSION RETARDER (OPTIONAL) .....	49
OPERATING THE RETARDER USING THE BRAKE PEDAL .....	50
<b>FOOT-OPERATED CONTROLS .....</b>	<b>50</b>
BRAKE PEDAL.....	50
ACCELERATOR PEDAL .....	51
STEERING WHEEL ADJUSTMENT UNLOCK AIR VALVE .....	51
<b>ALLISON TRANSMISSION .....</b>	<b>51</b>
OPERATION .....	51
PUSHBUTTON SHIFT SELECTOR .....	51
PRIMARY AND SECONDARY SHIFT SCHEDULES.....	52
TRANSMISSION SERVICE INDICATOR.....	52
DESCRIPTION OF AVAILABLE RANGES.....	52



**KEYS**

Four different key models are provided with the vehicle. They are used as described below.

**FRONT ENTRANCE DOOR LOCK KEY**

Use this key to lock or unlock the entrance door from outside. It is also possible to lock or unlock the entrance door using the entrance door locking switch, the keyless entry system or the remote entry transmitter.

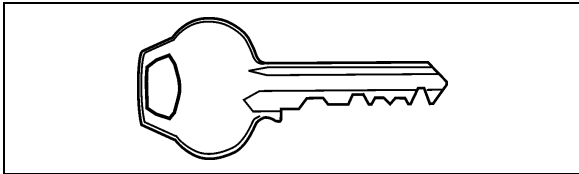

**EXTERIOR COMPARTMENTS KEY**

Use this key to lock or unlock any exterior compartment door, including the fuel tank filling access doors, the baggage compartment doors and the electrical and service compartment doors. It is also possible to lock or unlock the baggage compartments from the inside by means of the baggage compartment central locking system switch located on the lateral control panel.

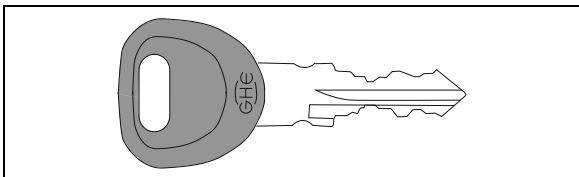

**NOTE**

Record the key numbers and keep this information in a safe place. Do not keep these records inside vehicle.

It is also advisable to deposit a duplicate of each key in a safe place, so they can be obtained without difficulty in case of an emergency or loss.

**UTILITY COMPARTMENT KEY**

This key locks or unlocks the utility compartment and the utility drawers on the dashboard.



**IGNITION SWITCH KEY**

Turn the ignition key counterclockwise to the ACC position to activate the electrical circuits.

To start the engine, turn the key clockwise to the START position, and then release it. The key will set back to the ON position.

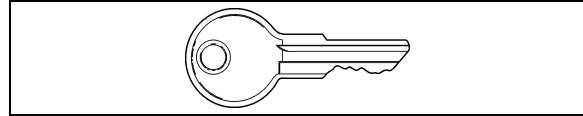

**CAUTION**

When the vehicle is parked overnight or for an extended period of time, the battery master switch should be set to the OFF position.

**NOTE**

When the battery master switch is set to the OFF position, all electrical supply from the batteries is cut off, with the exception of battery equalizer check module, MCM ignition and power supply, TCM power (Transmission), coolant heater electronic timer coolant heater and water re-circulating pump, pro-driver, power-verter, keyless entry system and fire alarm.

**REMOTE ENTRY TRANSMITTER**

Hand held transmitters (key FOB) can be used to control the keyless door lock system.



**To lock the entrance door and the baggage compartment doors simultaneously and arm the intrusion protection and anti-theft system:**

## 4-4 CONTROLS AND INSTRUMENTS

- Press LOCK (top) button on the transmitter once.

### **NOTE**

*The lock function will not function when the ignition is in the ON position or the entry door is open.*

### **NOTE**

*The intrusion protection and anti-theft system will be set after a 10 seconds delay.*

### **To unlock the entrance door:**

- Press UNLOCK DOOR (bottom) button on the transmitter. This will unlock the door and disarm the anti-theft system.
- Hold the button to unlatch the entrance door and reduce the effort necessary to open it.

### **To unlock the baggage compartment doors:**

- Press UNLOCK BAGGAGE (right) button. This will not disarm the alarm.

### **To set off the personal security alarm (Panic mode):**

- Press and hold the red (left) PANIC button for two seconds. The horn will sound and the marker lights will flash for 30 seconds.

### **To deactivate the personal security alarm:**

- Press any FOB button again or unlock the entrance door using the keypad.

For additional information, refer to *Other Features* chapter.

## IGNITION SWITCH

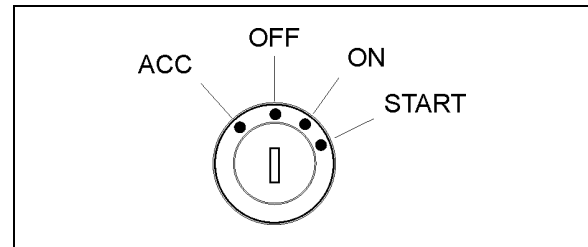

IGNITION SWITCH POSITIONS

06354

The ignition switch is located on the lower left side of the dashboard. For further details, refer to STARTING AND STOPPING PROCEDURES section in this manual.

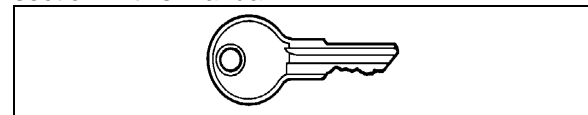

IGNITION KEY

23056

**DRIVER'S AREA**

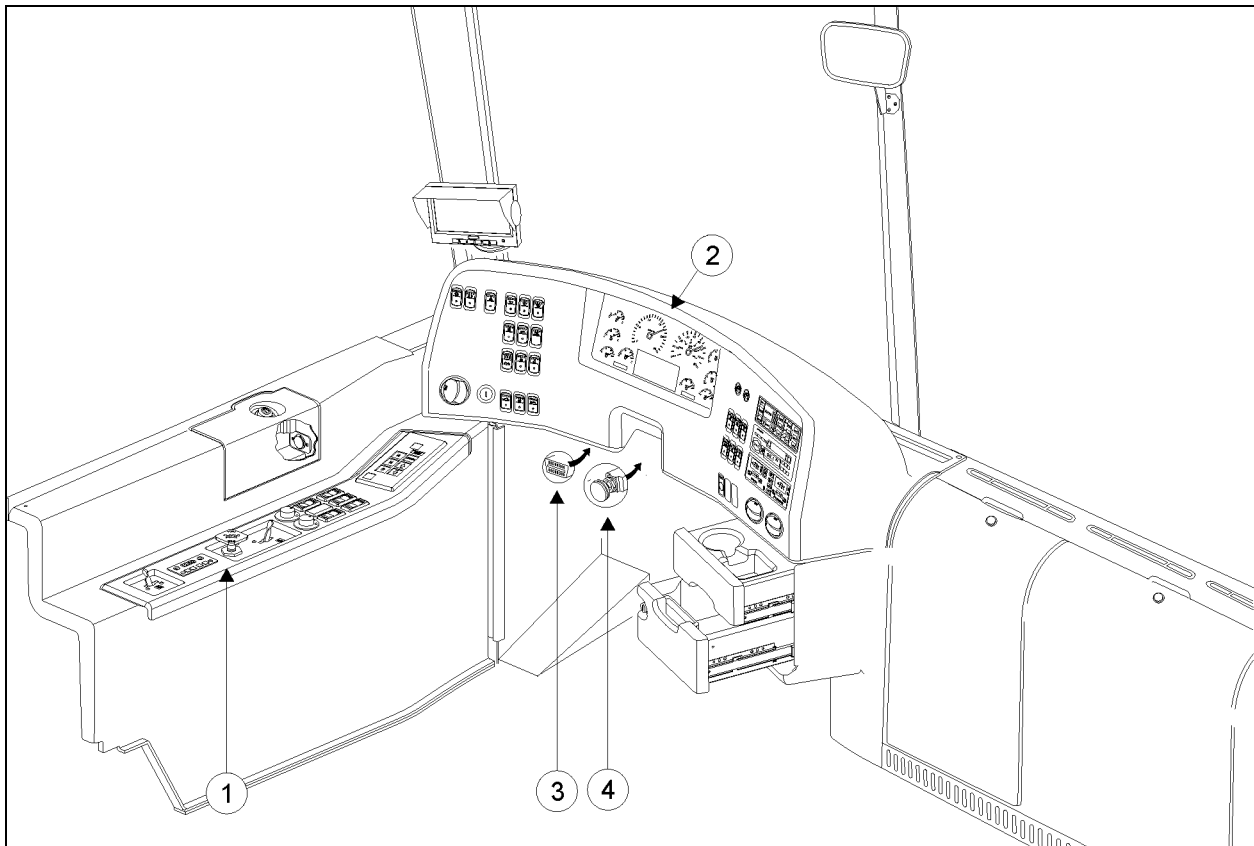

18675

1. Lateral control panel
2. Dashboard
3. Diagnostic tool receptacle (OBD)
4. Foot-operated steering wheel adjustment knob

LATERAL CONTROL PANEL

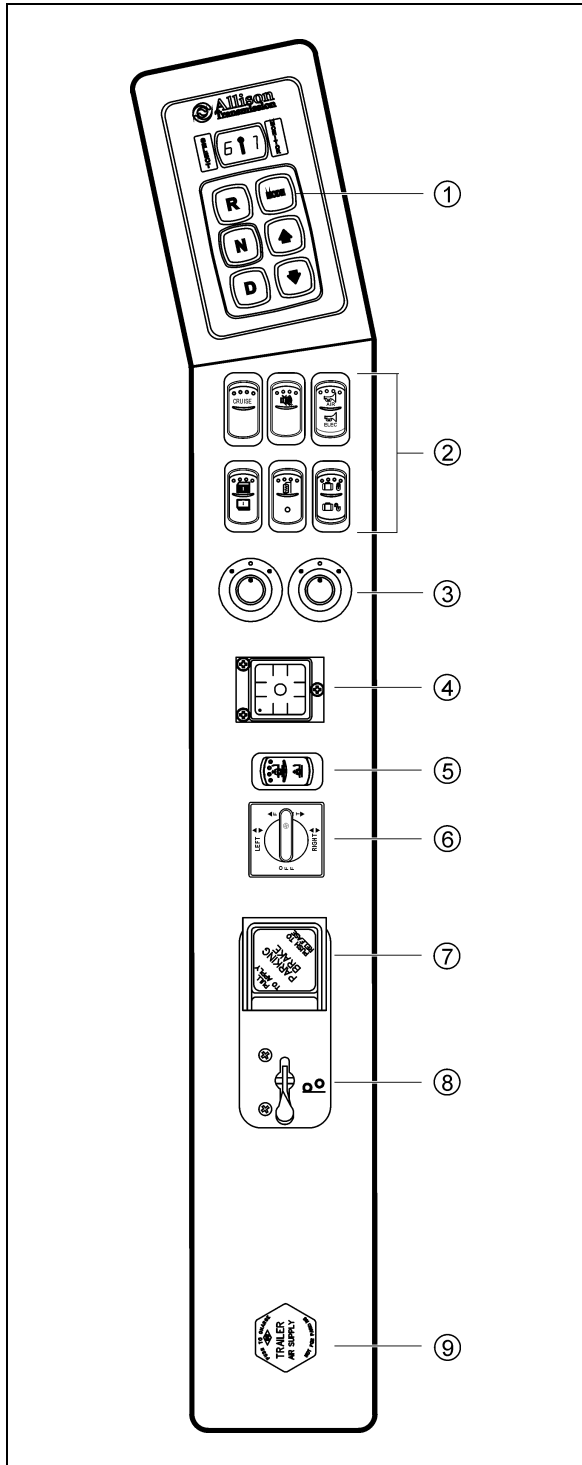

② CONTROL SWITCHES

Cruise Control Switch

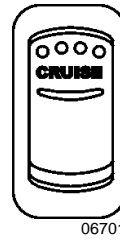

For operation of the cruise control, refer to "Regular Cruise Control" or "Prevost Aware Adaptive Cruise Braking" paragraph in this chapter.

Back-up Alarm Cancel

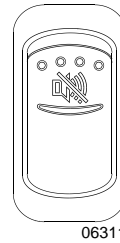

Press down this switch to cancel the back-up alarm. Return to normal operation after use.

Horn Selector



Use this switch the toggle between the air horn and the electric horn when pressing the steering wheel center pad.

Power Window Switch

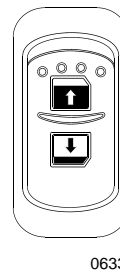

Use this rocker switch to open or close the driver's power window.

	<p><b>CAUTION</b></p>
<p>Close power window when parked or leaving the coach unattended.</p>	

① TRANSMISSION CONTROL KEYPAD

Refer to "Allison Transmission" in this chapter for operating instructions and more information.

**Outside Rear View Mirror Heat (optional)**

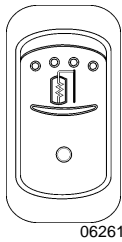

Press this rocker switch to clear fog, frost or thin ice from outside mirror.

06261

**Baggage Compartments Central Locking**

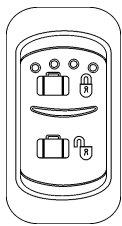

This rocker switch enables locking all baggage compartment doors by pressing the switch forward. To unlock, press the switch rearward.

06266

**NOTE**

*Service compartment doors are not linked to the baggage compartments locking system.*

*Doors must be locked using the key first; they can then be unlocked or locked using the baggage compartments locking system.*

**③ MIRROR CONTROLS**

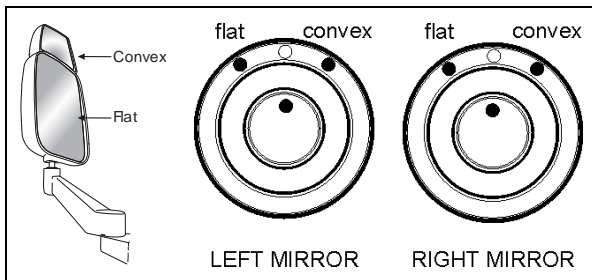

MIRROR CONTROLS

06374

Turn left pointer knob counterclockwise for flat mirror adjustments and clockwise for convex mirror adjustment, then use the pointer knob as a joystick to adjust the selected mirror's viewing angle. Adjust the right outside mirror similarly using the right side control.

**④ ⑤ ⑥ LEVEL LOW SYSTEM**

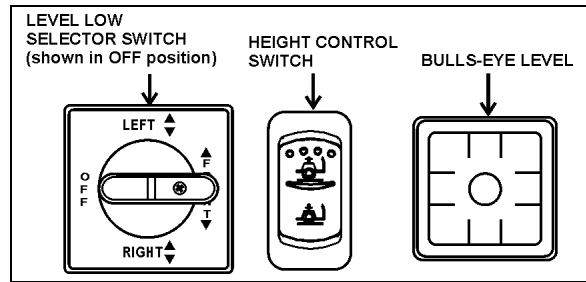

LEVEL LOW SYSTEM

12224\_3

When driving, the conventional air leveling system of the vehicle controls the height at three points: the front, the left rear and the right rear. Your vehicle is equipped with a suspension system that consists of air springs (pressurized air bellows) located near each wheel. The amount of air in each air spring (and thus the vehicle height) is controlled by automatic leveling valves that operate between the chassis and the axles of the vehicle.

The three leveling valves are located as follows: one at the front which controls the amount of air in both front air springs, one at the left rear which controls the left rear corner of the vehicle and one at the right rear which controls the right rear corner of the vehicle. During normal driving, these valves work automatically to maintain the chassis at the proper level above the axles, indifferent of road conditions or vehicle weight.

**NOTE**

*It is always better to first level the rear of the vehicle (right to left) before raising or lowering the front. After adjusting the rear, watch the level indicator as you adjust the front. If the level shows that the vehicle is starting to tilt to either side, then stop adjusting the front as one of the air springs has come to the end of its travel range.*

When parked, and **only** when parked, the level of the vehicle can be manually adjusted within the range of travel of the air springs. Thus, if the vehicle is parked on uneven ground, the manual override leveling system can be used to level the chassis of the vehicle. With the ignition ON (engine running or not), turn the selector switch located on L.H. side control panel to the area of the vehicle requiring leveling, then press the height control switch accordingly (up or down) to inflate or deflate the selected set of air springs. The front position raises or lowers the front only and does not tilt the vehicle to its sides. Each rear position raises or lowers its respective side,

## 4-8 CONTROLS AND INSTRUMENTS

therefore, the rear positions can be used to tilt the vehicle to one side or the other, or they can be used to raise or lower the rear of the vehicle. When leveling vehicle, it is often necessary to run the engine in order to get an adequate air supply.

After manual leveling, turn OFF the engine. The vehicle will stay in the leveled position (the air is "locked" in the air springs) as long as there are no air leaks. The vehicle will hold this position for several days. When engine is restarted and air pressure is adequate, the vehicle will automatically level itself for driving conditions.



### WARNING

**Do not** drive the vehicle with the level low selector switch in any position other than OFF, as this may render the vehicle unsafe and uncontrollable. If this is the case, a pictogram appears in the Driver Information Display as the vehicle speed exceeds 12 mph (20 km/h), reminding you that the selector is not in the OFF position.

### NOTE

If, for any reason, you wish to start the engine without moving vehicle (to warm up engine for instance) while keeping the vehicle in the manually leveled position, place selector switch in any position except **OFF**. When ignition switch is turned to the **OFF** position, reset the Level Low selector switch to the **OFF** position.

### ⑦ PARKING BRAKES CONTROL VALVE

Spring-loaded parking brakes are applied by pulling up the control valve knob and protector assembly. Lift the safety cover and push down to release brakes. Refer to *Safety Features and Equipment* chapter.

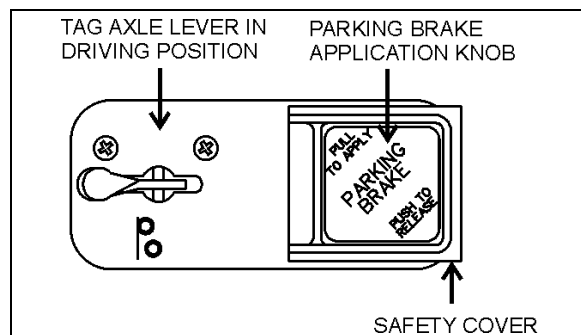

CONTROL VALVES

12224

### ⑧ AUXILIARY AXLE CONTROL VALVE

Lift the auxiliary axle by pushing the lever forward. Pulling the lever back will lower and load the auxiliary axle. Refer to *Other Features* chapter for additional information.



### WARNING

Do not drive vehicle with auxiliary axle raised when speed is exceeding 12 mph (20 km/h).

### ⑨ TRAILER AIR SUPPLY CONTROL VALVE (optional)



12225

The trailer air braking system is supplied by pushing this control valve.

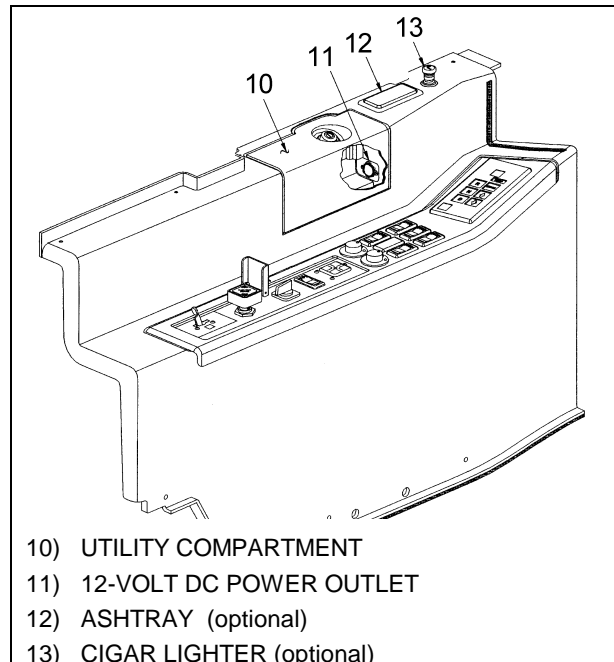

10) UTILITY COMPARTMENT

11) 12-VOLT DC POWER OUTLET

12) ASHTRAY (optional)

13) CIGAR LIGHTER (optional)

### (10) (11) UTILITY COMPARTMENT & 12-VOLT DC POWER OUTLET

The lockable free space utility compartment also includes a 12-volt appliance socket.

### (12) ASHTRAY

To open the ashtray, push slightly on the cover's side. The ashtray can be removed for cleaning by pulling it out.

 **WARNING**

To prevent a fire, never put paper or plastic wrappers in the ashtray. Empty ashtray often.

**(13) CIGAR LIGHTER**

Push lighter in to activate. When ready to use, it will spring out automatically. Replace lighter in non-activated position. The cigar lighter socket can be used to power 12-volt appliances (eg. flashlight, vacuum cleaner). The maximum power consumption allowed for appliances plugged in this socket is 130 watts. Make sure the appliances are equipped with suitable plugs that will not damage the socket.

**NOTE**

*The cigar lighter can still be used after the ignition key has been removed.*

**DIAGNOSTIC TOOL RECEPTACLE**

To ease troubleshooting, a diagnostic tool (OBD) can be connected through this receptacle.

**AUTOMATIC FIRE DETECTION AND SUPPRESSION SYSTEM (AFSS)**

**Protection Panel**

The protection panel displays the current system status. The protection panel contains “SYSTEM OK”, fire “ALARM” and “TROUBLE” lamps, the audio alarm, the “TEST/RESET” switch, and the “ALARM SILENCE” switch.

The “SYSTEM OK” lamp indicates power is on the system and that there are no trouble conditions present. The “TROUBLE” lamp blinks if there is a fault in the detection circuitry and illuminates solid if there is a fault in the extinguishing circuitry. When the “TROUBLE” lamp is on, the “SYSTEM OK” lamp will be off and the audible alarm will sound intermittently. The “SYSTEM OK” lamp will flash when the system is low on battery power. Depressing the “TEST/RESET” switch tests the protection panel lamps and audio alarm. The “ALARM SILENCE” switch will disable the audio alarm.

When a fire detector automatically detects a fire, the fire “ALARM” lamp and audio alarm activate. When the Manual Activation Switch is activated, the fire “ALARM” lamp blinks and the audio

alarm activates. The lamp will remain blinking until power is cycled to the system.

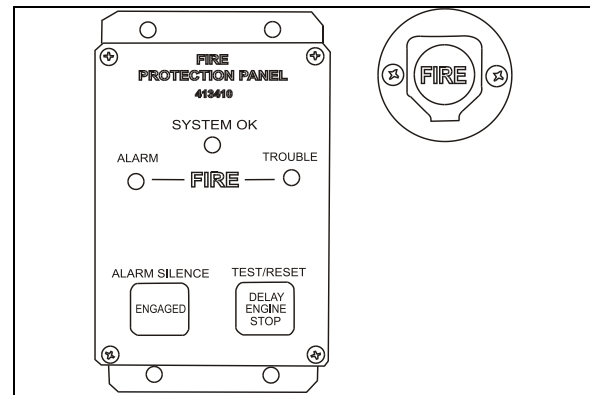

**AFSS PROTECTION PANEL & MANUAL ACTIVATION SWITCH**

**Manual Activation Switch**

The manual activation switch allows immediate system activation (extinguisher discharge and engine shutdown) by the operator at any time. Activation of the switch is accomplished by twisting and pulling the tamper seal to remove, lifting the cover and pressing the red “FIRE” button for more than half a second. After the manual activation switch has been activated, the protection panel will blink the fire “ALARM” indicator until power has been cycled to the system.

Refer to Safety Features and Equipment chapter for more information on *Kidde Dual Spectrum* Automatic Fire detection and Suppression System (AFSS).

**REGULAR CRUISE CONTROL**

The cruise control allows you to cruise the vehicle at a desired speed over 30 mph (50 km/h) without having to use the accelerator pedal.

**Turning the system on**

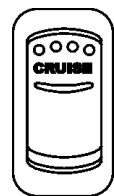

06701

To operate the cruise control, press the **CRUISE** rocker switch located on the lateral control panel to the ON position. This turns the system on. The dashboard telltale turns on; you can now set the vehicle at a desired cruising speed. To turn off the system, press the rocker switch to the OFF position.

## 4-10 CONTROLS AND INSTRUMENTS

### *NOTE*

The **CRUISE** switch and **RESUME** button do not operate at speeds below 30 mph (50 km/h).

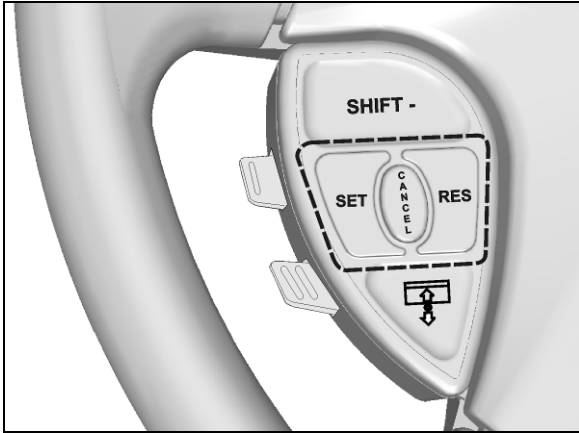

CRUISE CONTROL BUTTONS

### Setting at a desired speed

Accelerate the vehicle to the desired cruising speed using the accelerator pedal. Press and release the **SET** button then remove foot from the accelerator pedal. This will set the vehicle cruise speed and store it in memory. The set speed will appear in the driver information display.

### Increasing set speed

The vehicle cruise speed setting can be increased by one of the following methods.

1. Accelerate using the accelerator pedal until the desired cruising speed is reached. Press and release the **SET** button.

or

2. Press and hold the **RES** (RESUME) button until the desired cruising speed is reached. When the **RES** button is released, the new cruising speed will be stored in the cruise control memory.

or

3. When driving with cruise control, each time the **RES** button is momentarily depressed, the cruising set speed is raised by 1 mph (2 km/h).

### *NOTE*

When driving with cruise control, the vehicle can still be accelerated by depressing the accelerator pedal in the usual manner. Once the accelerator pedal is released, the vehicle will return to the previously set cruising speed.

### Decreasing set speed

The vehicle cruise speed setting can be decreased by one of the following methods.

1. Press and hold the **SET** button until the desired cruising speed is reached. When the **SET** button is released, the new cruising speed will be stored in the cruise control memory.

or

2. Each brief pressing of the **SET** button will decrease set cruising speed by 1 mph (2 km/h).

or

3. Slightly apply the service brake and when desired cruise speed is reached, press and release the **SET** button.

### Canceling the preset speed

You can cancel the preset cruising speed by:

1. Pressing momentarily the **CANCEL** button;
2. Depressing the brake pedal.

### Resuming Set Speed

If the preset speed is cancelled by pressing the **CANCEL** button or depressing the brake pedal, pressing the **RES** (RESUME) button will restore the speed set prior to cancellation, providing that your speed is above 30 mph (50 km/h).



**NOTE**

When driving downhill with the cruise control on and set, the engine brake or the transmission retarder engage automatically (if previously activated) when the selected cruise speed is exceeded by approximately:

- 4 mph (7 km/h) with the engine brake activated;
- 0.6 mph (1 km/h) with the transmission retarder activated.

The engine brake or the transmission retarder is then disengaged when speed has returned near to selected cruise speed.

The engine brake will provide low braking power or high braking power depending on which of the two steering wheel engine brake control buttons is activated;

① = Engine Brake Low

② = Engine Brake High

The transmission retarder maximum braking level is determined by the retarder hand lever position on the steering wheel.

**NOTE**

To avoid sudden vehicle hesitation, slightly depress the accelerator pedal before disengaging the cruise control.

**NOTE**

When the **CRUISE** rocker switch is released, the cruise control is completely shut off and the cruise speed setting is erased from the cruise control memory.

**IMPORTANT NOTE**

If the engine was stopped and the **CRUISE** rocker switch was in the **ON** position, the rocker switch must be reset by turning it **OFF** then **ON** again in order for the cruise control to be reactivated.



**WARNING**

Do not use the cruise control when driving speed must be constantly adjusted, such as in heavy traffic or on winding, icy, snow-covered or slippery roads, or on gravel roads.



**WARNING**

Do not put the transmission in the neutral (N) position while driving with cruise control. This may cause the engine to over-speed and result in a loss of driving control.

**PREVOST AWARE • ADAPTIVE CRUISE BRAKING**

Prevost AWARE Adaptive Cruise Braking (ACB) is an optional cruise control that not only maintains the set speed, but will also intervene, as needed, to help the driver maintain a set following distance behind the forward vehicle by reducing speed as necessary. As soon as the forward vehicle is at a safe distance, the coach will accelerate back to the cruise set speed.

**NOTE**

The following paragraphs briefly sum up the information concerning the operation and function of the ACB. Before driving the vehicle, be certain that you have read and that you fully understand each and every step of the driving and handling information found in Bendix Wingman ACB Active Cruise with Braking Operator's Manual. The driver should fully understand all the audible alerts and visual indicators that the system provides. Bendix Wingman ACB Active Cruise with Braking Operator's Manual (available on Prevost web site and included on the Technical Publications CD) will assist in explaining what each of them means and what actions the driver may be required to take to avoid potential collisions.



**WARNING**

Even with ACB, the driver must remain alert, react appropriately and in a timely manner, and use good driving practices. Ultimate responsibility for the safe operation of the vehicle remains with the driver at all times.

Be certain that you have read all safety warnings found in Bendix Wingman ACB Active Cruise with Braking Operator's Manual.

The driver will benefit all the audible and visual warnings that the system provides whether or not ACB is turned on. In addition to the audible and visual warnings, when the ACB is turned on and a cruise speed is set, the driver benefits from active interventions like engine throttle

## 4-12 CONTROLS AND INSTRUMENTS

reduction, retarder or engine brake application and service brakes application to help maintain a set following distance.



### WARNING

Adaptive Cruise Braking must be used only in the same conditions that are normally recommended for ordinary cruise control. Refer to "Regular Cruise Control" paragraph.

### Turning the ACB system on

Activation of the adaptive cruise braking is similar to the regular cruise control activation. Press the CRUISE rocker switch to the ON position, accelerate the vehicle to the desired cruising speed and then, press the SET button. ACB is now engaged with the set following distance and driver warnings features. Whenever the cruise control is engaged, the ACB is also engaged. You cannot engage the cruise control without also using the ACB features.

### Turning off the ACB system

You can turn off the ACB system, simply by applying service brakes, setting the CRUISE rocker switch to the OFF position or pressing the cruise control CANCEL button on the steering wheel.

#### NOTE

*Whenever the service brakes are applied by intervention of the ACB or by the driver, normal cruise will automatically be cancelled. The driver must resume or set the cruise mode in order for the vehicle to throttle up.*

### Maintaining a set following distance

Using a radar sensor mounted to the front bumper, the ACB system measures the distance between the coach and the forward vehicle and intervenes to help maintain a safe set following distance behind the vehicle. This feature engages automatically once the driver turns on and sets cruise speed.

Following distance refers to the time gap, measured in seconds, between the coach and the vehicle ahead. The actual physical distance between the coach and the vehicle ahead will vary based on your set cruise speed; although the set time gap remains the same for all set

cruise speeds. Prevost's default set time gap is 1.7 seconds.

With cruise control engaged and a cruise speed set, you are maintaining a set following distance between the coach and the forward vehicle:

- **If the vehicle in front of the coach slows down** below your cruise control set speed, the system will progressively intervene as follows, in this order:
  - 1) reduce the engine throttle;
  - 2) apply the engine brake or transmission retarder;
  - 3) apply about 30% of the service brakes available braking power in an attempt to maintain the set following distance.

**The driver must apply additional braking power when required, to avoid collision or to maintain a safe distance from the vehicle ahead.**

#### NOTE

*If the ACB is actively decelerating or braking the coach in an attempt to maintain the set following distance at the moment when the driver cancels the ACB system, the ACB system will continue deceleration or braking intervention until a safe following distance is established, then will cancel.*

*Even though the cruise control doesn't operate at speeds below 30 mph (50 km/h), the ACB system will continue deceleration or braking intervention in an attempt to maintain the set following distance if the coach speed reduces to less than 30 mph (50 km/h).*

- **If the vehicle ahead slows below your cruise control's set speed**, but then accelerates away, and the ACB system did not need to use the service brakes as it managed the intervention, the coach will automatically accelerate back to the original cruise control set speed, and again maintain a set following distance behind the forward vehicle.

#### NOTE

*The maximum radar range is approximately 500 feet (150 meters). Rain, snow, fog, ice and other severe weather conditions may affect the performance of the ACB system and shorten radar range.*

**NOTE**

As part of your pre-trip vehicle inspection, check to see that there is no mud, snow, ice build-up or other obstruction in front of the radar sensor. You should inspect the radar sensor mounting and remove any obstruction that may impair the sensor functioning.

**Driver warnings**

Before using the ACB, the driver should fully understand all the audible and visual warnings that the system provides. Any audible warning (beeping or tone) means that your vehicle is too close from the vehicle ahead.

**DASHBOARD TELLTALE**

When ACB is turned on and a cruise speed is set, if the forward vehicle is detected (in range) by the radar, the FORWARD VEHICLE DETECTED telltale light on the dashboard will illuminate. This is an indication to the driver that the forward vehicle is being tracked, that the ACB is actively managing the distance between the coach and the vehicle ahead and that the ACB system may automatically intervene to maintain the set following distance.



**FORWARD VEHICLE DETECTED telltale light**

There are three types of warnings with this telltale light:

- Green: The forward vehicle is detected (in range).
- Flashing red: Collision alert. The forward vehicle is too close to follow safely or a metallic stationary object such as a stopped or stalled vehicle in your lane of travel is detected. The driver must intervene to avoid a collision.
- Solid red: ACB system malfunction. The ACB system and the alert functions are not available.

**SPEEDOMETER LEDS**

With the cruise control engaged and a cruise speed set, a green LED illuminates above the cruise control set speed on the speedometer.

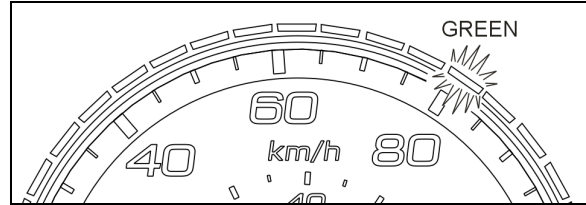

THE CRUISE SET SPEED IS 80 km/h

With a cruise speed set, the vehicle ahead slows moderately. The system will display to the driver the approximate speed of the vehicle ahead with yellow LEDs above the speedometer.

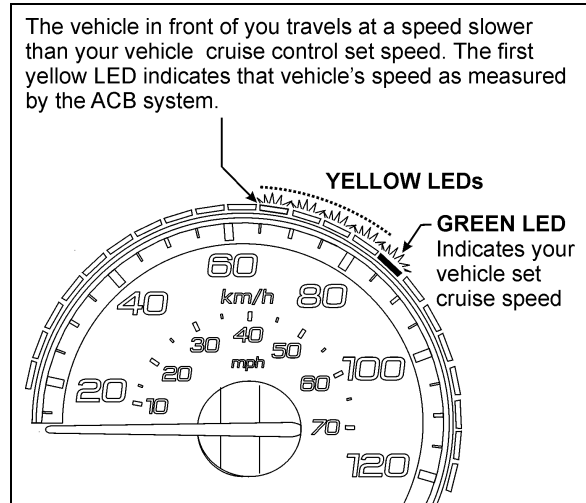

EXAMPLE OF THE SPEEDOMETER LED DISPLAY WHEN THE FORWARD VEHICLE IS SLOWER WHILE THE COACH TRAVELS WITH THE ACB CRUISE CONTROL ON AND SET

06729\_3

**FOLLOWING DISTANCE ALERT (FDA)**

Following Distance Alert provides both audible and visual warnings whenever the distance between the coach and the forward vehicle is less than the set distance and getting closer. Once the audible warning is given, the driver must increase the distance between the coach and the vehicle ahead until the audible warning stops or maneuver clear of the forward vehicle.



### WARNING

Following Distance Alert is always active whenever the coach is moving to a speed greater than 37 mph (60 km/h), whether or not ACB is turned on. Active interventions of ACB to maintain safe following distance (throttle reduction, engine brake/retarder application, service brakes application) are only operational when the ACB is engaged with a cruise speed set.

runs may cause this alert to be activated. It is recommended that ACB be disengaged on downhill grades. The driver should use appropriate gearing and brake techniques, and not rely on ACB, on downhill grades.

If the driver does not respond to the Brake Overuse Warning after a brief delay, the ACB will switch off.

### IMPACT ALERT

The Impact Alert warning is the most severe warning issued by the ACB system. This alert indicates that the driver must take immediate evasive action by applying more braking power and/or steering clear of the vehicle ahead to avoid a potential collision.

The Impact Alert is also applicable to stationary metallic objects such as stopped or stalled vehicles. This alert provides a warning given up to 3.0 seconds before a potential collision with a stationary metallic object in the coach's lane of travel. The driver can either slow down or maneuver in an attempt to avoid the object. The Impact Alert will only warn and will not actively decelerate or brake the coach when approaching stationary objects.







### WARNING

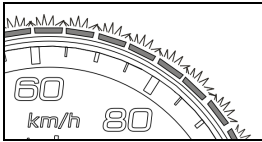
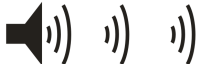

Impact Alerts are always operational when the vehicle is running, whether or not ACB is turned on. Active interventions of ACB to maintain safe following distance (throttle reduction, engine brake/retarder application, service brakes application) are only operational when the ACB is engaged with a cruise speed set.

### BRAKE OVERUSE WARNING

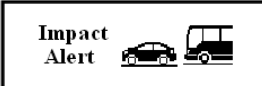
ACB provides a warning when the system is intervening and using the service brakes excessively. Overuse of the foundation brakes can lead to the brakes overheating and a potential loss of braking performance from brake fade. For example, the use of ACB on downhill

<b>FOLLOWING DISTANCE ALERT</b>	
<b>CONDITION</b>	The Following Distance Alert feature is only available when the coach speed is greater than 37 mph (60 km/h), whether or not ACB is engaged.
	The forward vehicle is slowing down and the distance between your vehicle the coach and the forward vehicle is less than the set distance
<b>ACTIONS BY ACB SYSTEM</b>	<p>“Distance Alert” pop-up message appears on the DID</p> <div style="text-align: right; margin-right: 20px;">  </div> <p>The speedometer LEDs illuminate in <b>red</b></p> <div style="text-align: right; margin-right: 20px;">  </div> <p>If the vehicles remain too close from each other for more than 15 seconds, an audible warning will sound (<b>beeping</b>)</p> <div style="text-align: right; margin-right: 20px;">  </div>

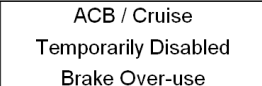
<b>IMPACT ALERT</b>	
<b>SITUATION</b>	ACB system detects a risk of collision with forward moving vehicle or a stationary metallic object in your lane of travel.
<b>ACTIONS BY ACB SYSTEM</b>	<p>On the dashboard, the Forward Vehicle Detected telltale <b>flashes</b> in <b>red</b></p> <div style="text-align: right; margin-right: 20px;">  </div> <p>“Impact Alert” pop-up message appears on the DID</p> <div style="text-align: right; margin-right: 20px;">  </div> <p>The speedometer LEDs <b>flash</b> in <b>red</b></p> <div style="text-align: right; margin-right: 20px;">  </div> <p>An audible warning will sound (<b>continuous modulating tone</b>)</p> <div style="text-align: right; margin-right: 20px;">  </div>

<b>BRAKE OVERUSE WARNING</b>	
<b>SITUATION</b>	ACB system is using the service brakes excessively to maintain the set following distance (for example, the use of ACB on long, steep downhill runs). Excessive application of the service brakes can cause the brakes to overheat resulting in increasing stopping distances.
<b>ACTIONS BY ACB SYSTEM</b>	<p>After a brief delay, the ACB system will stop functioning and be disabled.</p> <p>On the dashboard, the Forward Vehicle Detected telltale <b>illuminates</b> in <b>red</b></p> <div style="text-align: right; margin-right: 20px;">  </div> <p>“ACB/Cruise Temporarily Disabled Brake Over-use” pop-up message appears on the DID</p> <div style="text-align: right; margin-right: 20px;">  </div> <p>“ACB Not Available” pictogram appears on the DID status line</p> <div style="text-align: right; margin-right: 20px;">  </div>

## 4-16 CONTROLS AND INSTRUMENTS

### SELF-DIAGNOSTIC AT START-UP

Initiate the self-diagnostic as follows:

- The engine must be running since at least 15 seconds with parking brake applied.
- Trip the CRUISE rocker switch located on the lateral control panel from OFF to ON position.

The following sequence will begin:

1. Pop-up message “Impact Alert” will show in the DID;
2. The speedometer LEDs will flash in red;
3. FORWARD VEHICLE DETECTED telltale will flash in red;
4. The Impact Alert audible alarm will sound.

At the end of the self-diagnostic sequence, pop-up message « ACB SELF CHECK OK » will show on the DID if the system functions properly or « ACB SELF CHECK NOT OK » if a fault condition is detected.

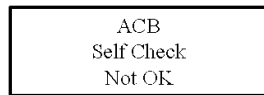
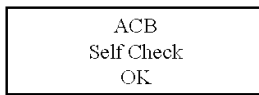

### SYSTEM MALFUNCTION

In case of system malfunction, visual warnings will illuminate in the instrument cluster or the driver information display to warn the driver that the ACB is disabled. In that situation, the Impact Alert and Distance Alert functions are not available.

If the ACB is not available, the FORWARD VEHICLE DETECTED telltale light will illuminate in red and will stay on and “ACB NOT AVAILABLE” pictogram will appear on the DID status line.



FORWARD VEHICLE DETECTED telltale light



ACB NOT AVAILABLE pictogram

For proper functioning of the system, the radar must be perfectly aligned and not blocked. If a radar fault condition is detected, one of the following pop-up messages will show in the DID.

### ACB RADAR MISALIGNMENT

### ACB RADAR FAULT

### ACB RADAR DATA LINK FAILURE

### ACB RADAR BLOCKED

### TIRE PRESSURE MONITORING SYSTEM (TPMS)

This system is a sensing device designed to identify and display tire operating data and activate an alert or warning when pressure or temperature irregularities are detected.

#### NOTE

*It is the responsibility of the driver to react promptly and with discretion to alerts and warnings. Abnormal tire inflation pressures should be corrected at the earliest opportunity.*

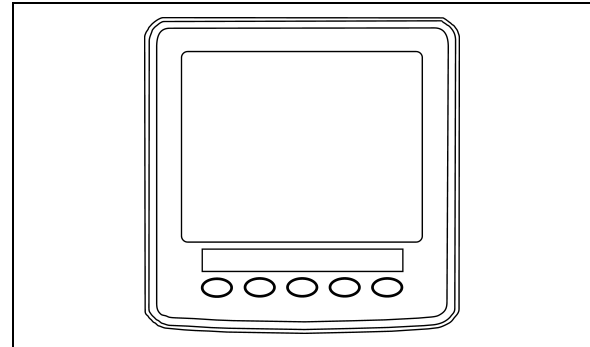

TPMS DISPLAY

### TPMS Display

The TPMS display knows where the sensors are located. It receives the raw temperature and pressure readings from the TPMS receiver, it reads several signals from the vehicle and does the calculation required to generate the various screens.

When no readings have been received for a tire location or when the received data correspond to a parameter range defined as unavailable, then the reading is considered as not available and appears as two dash lines “\_ \_”.

The TPMS display is initially configured to define how many axles and running tires are present on the vehicle. For current Prevost vehicle models, there are two axle / tire configurations.

These configurations are:

**Config 1:** Axle 1 (Front) Two tires, Axle 2 (Drive) 4 tires, Axle 3 (Auxiliary) 2 tires.

**Config 2:** Axle 1 (Front) Two tires, Axle 2 (Drive) 2 tires (super Singles), Axle 3 (Auxiliary) 2 tires.

The TPMS display is also configured with several other parameters, including threshold levels for the alarms.

The TPMS display power supply turns OFF when the ignition key is switched OFF.

**Operation**

The system will monitor all vehicle tires (6 or 8) plus the spare tire when a spare is supplied.

**NOTE**  
Some vehicle models do not come with a spare tire.

There are two configurations of vehicle tires to be supported. One configuration (the most common) consists of 8 tires total: two tires on the front axle, 4 tires on the drive axle and 2 tires on auxiliary axle. All screen figures shown in this document relates to this vehicle configuration. The second tire configuration consist of 6 tires total: 2 tires on the front axle, 2 tires on the drive axle (super single tires) and 2 tires on the auxiliary axle. The vehicle tire configuration is selected with a parameter (Refer to "SAFETY FEATURES AND EQUIPMENT" chapter for more information). When the display is configured for 6 tires, the drive axle tires appears as one large tire on both side instead of twin tires as illustrated in this document and there is one reading appearing on each side instead of two as illustrated in this document.

**Start-up**

When turning the ignition switch to ON, the following screen appears on the TPMS Display. Dash lines are displayed meaning that no pressure data have been received by the display.

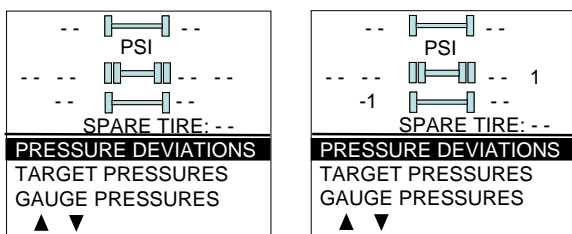

As illustrated, the pressure readings will appear replacing the dash lines as the TPMS display starts to receive pressure data from the TPMS receiver. It can take 1 minute to get all pressure

readings updated since the sensors transmit at a one minute interval.

The user can flip through the menus.

**Pre-Trip Check**

When one of the preconditions defined to start the pre-trip check is met, the TPM display enters into a pre-trip check routine and the screen shown below appears. The preconditions to initiate the pre-trip are: Park brake removed Or No activity on the display menu keys for a defined time (Key pressed timeout). After a pre-trip, the display is in a "drive" mode with bottom menu replaced by the alarm status. The display remains in this mode until one of the following occurs: A menu key is touched while the park brake is applied, or the park brake does a transition from released to park brake applied.

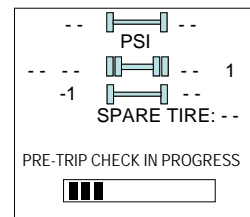

During the pre-trip check, the pressure readings for the different wheels become all available.

The pre-trip check ends, either when: the pressure readings have been received for all running wheels or the pre-trip check maximum time has elapsed. It was selected to provide sufficient time for all wheel sensors to wake-up and send a first reading.

The pre-trip check is aborted and the bottom menu reappears if the park brake was active and the user press one of the menu keys.

Upon completion of the pre-trip check, the TPMS display will come up with one of the following screens:

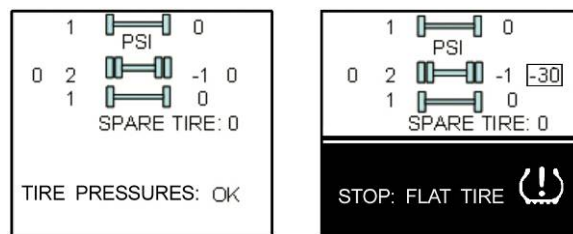

## 4-18 CONTROLS AND INSTRUMENTS

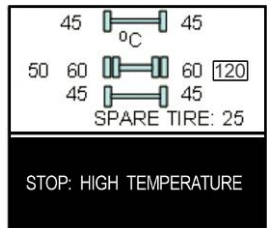
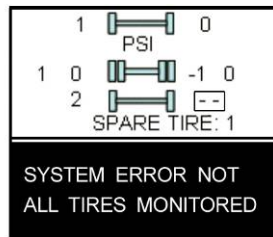
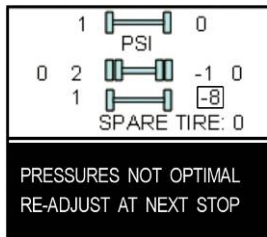

A rectangle around each pressure/temperature reading of the tires that have an issue is blinking to draw the attention to the defective tires.

In the case of multiple errors at the same time, the highest priority error is displayed at the bottom. "Flat Tire" has the highest priority followed by "High Temperature", "Not all tires monitored" and "Tire pressure not Optimal".

To get the driver's attention to the alarms, the bottom section of the screen where the alarm message appears will blink to reverse contrast at the following rate: 0.7sec normal contrast, 0.3 sec reverse contrast. Pressing any key will acknowledge the alarms that are considered as non-critical and stop the blinking of these alarms message for the remaining of the trip. The non-critical alarms are: "Pressure not optimal" and "Not all tires monitored". The "flat tires" and "high temperature" alarms are critical and will keep blinking even when a key is pressed. If a different alarm occurs, blinking will start again. The blinking rectangle around the pressure/temperature readings is not impacted by the acknowledgement and keeps blinking until the error condition disappears.

The spare tire does not contribute to alarms and so never blinks.

On the road, the TPMS display shows one of the 5 previous screens.

In the event of a temperature alarm, the display switches automatically to temperature readings.

The driver can also press any of the menu keys to momentarily switch the display to temperature readings. In this case, the temperature reading appears for 15 seconds and the display returns to pressure.

The switching to temperature by pressing a key does not take place if there is an acknowledgeable alarm active, since in this case pressing the key does acknowledge the alarm.

The switching to temperature does not take place either if there is an alarm of Temperature or Flat Tire.

The switching to temperature works when the bottom message indicates either: Tire Pressure OK, Pressure Not Optimal non flashing or not all tires monitored non flashing. When the switch is done to temperature readings, the bottom portion of the screen is not affected and still shows the status message.

### *NOTE*

*High temperature is not likely to occur during the pre-trip.*

The pressure and temperature readings are continuously updated with the displayed readings of the wheel having issues blinking. The bottom line message is automatically updated to the highest priority alarm prevailing. There is a hysteresis on the alarm levels to assure that the error conditions do not flicker ON and OFF.

On the occurrence of an alarm, a beep will sound. The alarm beep could be turned OFF in the alarm settings menu.

### **Spare tire:**

The spare tire is monitored but it is not taken into account when setting the bottom alarm messages. This is to prevent unnecessary alarms that would otherwise occur, if for example, the spare tire is removed from a vehicle.

The user will have the possibility to check the pressure of the spare tire by accessing the TPMS display menu. For vehicles that have no spare tires, the title "spare tire:" will still appear on the screens but the pressure will remain with two dash lines at all time.

### **Post Trip Operation**

When parking the vehicle (park brake applied), the TPMS display keep the drive mode display active. The driver can press any keys to get the bottom lines showing the status information replaced with the menus.

The pressure readings are still displayed and updated as new readings are received and the



readings are blinking if not within the optimum pressure range.

From this point the user can scroll through the menus to get more detailed information and inflate/deflate the tires to bring them back to their optimum target pressures. Scrolling through these menus is also available prior to departure.

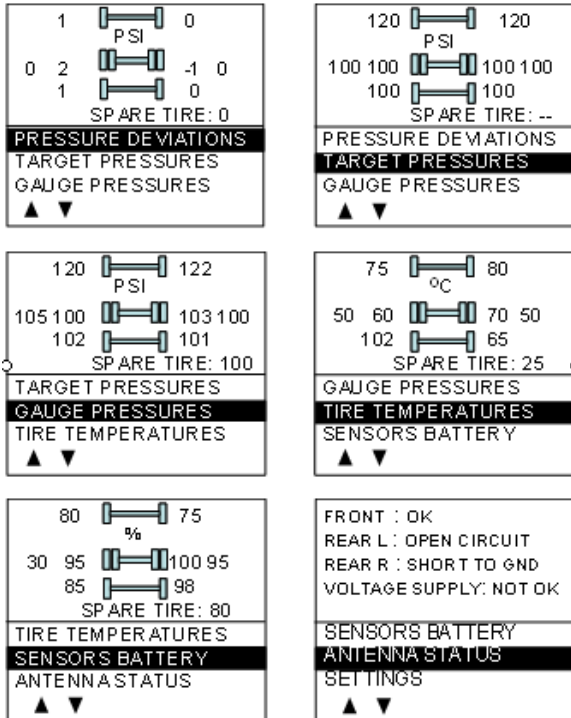

The display remains in this mode with the menus appearing at the bottom until the pre-trip check sequence starts again.

Scrolling down below the Battery life menu will show the Settings menu. Highlighting the Settings and pressing OK allows entering the settings menu. Refer to "SAFETY FEATURES AND EQUIPMENT" chapter for more information on "Settings Menu".

Highlighting the Exit menu and pressing OK exits the settings and come back to the pressure display mode.

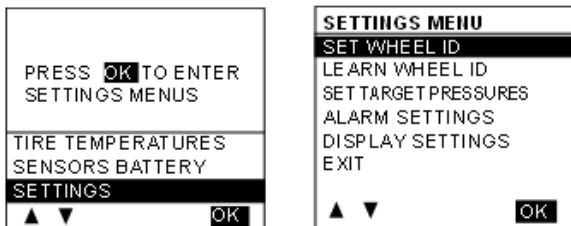

## 4-20 CONTROLS AND INSTRUMENTS

### DASHBOARD

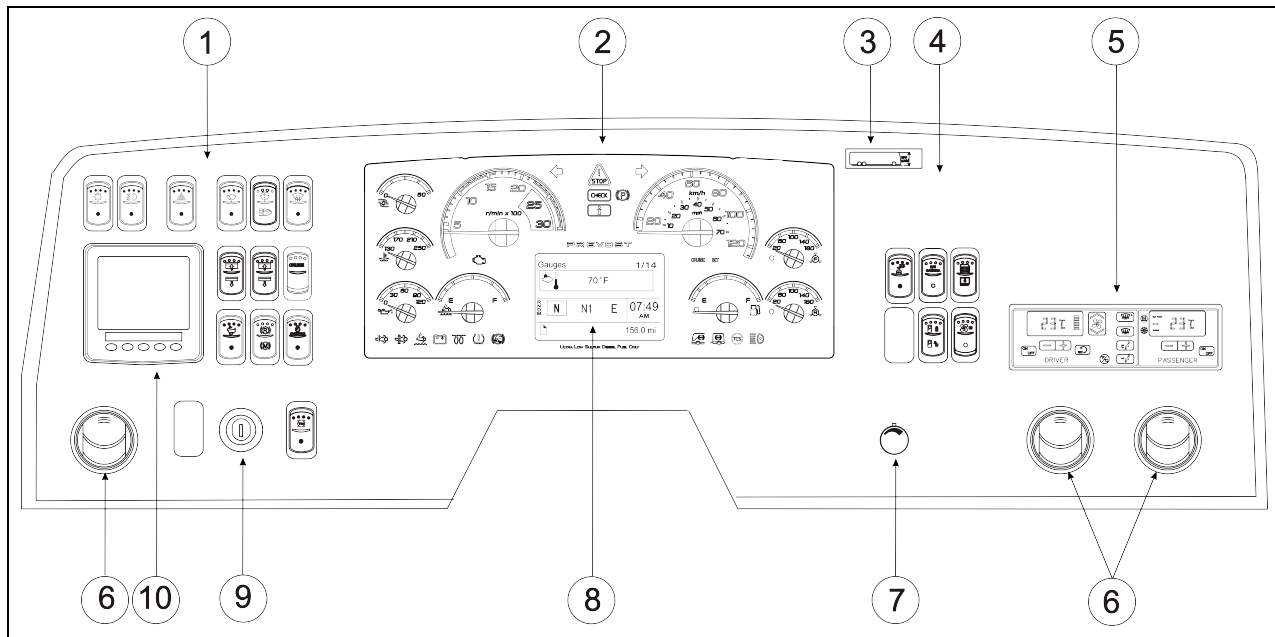

DASHBOARD

06754\_VIP

1. L. H. instrument panel
2. Instrument cluster
3. Vehicle clearance information
4. R.H. instrument panel
5. HVAC control unit
6. Adjustable air registers
7. Instrument lights brightness control
8. Driver Information Display (DID)
9. Ignition switch
10. Tire pressure monitoring system display (TPMS)

**CONTROL SWITCHES**

High quality laser-engraved switches are used to control many of the features of the coach. Many switches have an embedded indicator LED to inform the driver at a glance which features are active. Some switches' LED will turn off after a short while when the engine is running. This is normal and is designed to reduce glare when driving. The functions still operate even if the LED is off. If the switches are still ON when the engine is turned OFF, the LEDs will illuminate to warn the driver to turn them OFF.

**L. H. INSTRUMENT PANEL**

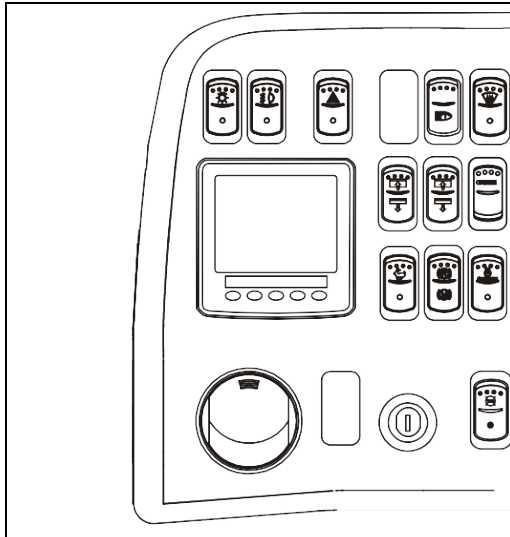

L. H. INSTRUMENT PANEL

06762\_2

The L.H. instrument panel includes driver-exclusive controls, ignition switch and an adjustable air register for the driver.

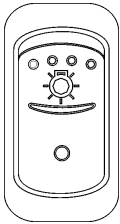

06254

**Headlights and Exterior Lighting**

**OFF position** – Daytime running lights only.

Press this rocker switch to turn on the following lights:

**First position** – Front parking lights, taillights, clearance lights, marker lights, license plate light.

**Second position** (depress completely) – All the lights from the first position plus the headlights and the instrument light and all lights from the first position.

**NOTE**

*Daytime running lights will be automatically cancelled when the exterior lighting switch is fully depressed (second position).*

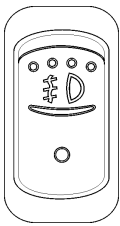

06255

**Fog Lights (optional)**

Optional halogen fog lights provide better visibility in fog and precipitation. They improve close range visibility and provide added safety.

**NOTE**

*Some states and provinces restrict the use of fog lights. Verify local state or provincial regulations before using.*

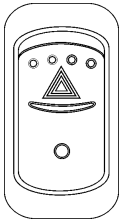

06256

**Hazard Warning Flashers**

Press the rocker switch to make all turn signal lights flash at once.



**CAUTION**

Do not use the hazard flashers for an extended period of time unless necessary because the electrical circuits are activated when the hazard switch is depressed.

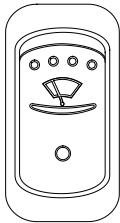

06257

**Upper Windshield Wipers (optional)**

Press the rocker switch to the first position to activate the upper wipers intermittently. Press to the second position for continuous operation of the upper wipers.



**CAUTION**

To avoid damaging the wiper blades or scratching the windshield, do not operate the wipers when the windshield is dry. Also, loosen frozen wipers before operating.

**NOTE**

Lower windshield wipers are activated using the multi-function lever. Refer to "Steering Column Controls" paragraph in this chapter.



06615

**Upper Windshield Washer (optional) & Headlights Washer**

Press this rocker switch upwards to spray the upper windshields with washer fluid. Windshield wipers will automatically come on and stop a few seconds after releasing the switch.

Momentarily press this rocker switch downwards to spray the headlights washer fluid. Each pressing of this switch produces 2 successive jets.



**CAUTION**

Do not operate the washer mechanism while the washer fluid reservoirs are empty. This may damage the washer fluid pumps.

**NOTE**

Lower windshield wipers are activated using the multi-function lever. Refer to paragraph: "Steering Column Controls" in this chapter.

**Traction Control System Mud/Snow Mode (option)**

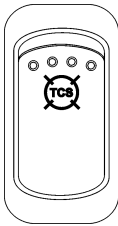

06758

On certain road conditions, it may be useful to retard the intervention of the traction control system TCS during vehicle acceleration. The Mud/Snow function allows greater engine power and more wheel spin during TCS operation. This function may be helpful to set the vehicle in motion on iced road for example.

Press the Mod/Snow switch to turn on this function. The TCS/ESC telltale blinks slowly when the TCS Mud/Snow mode is active. Always remember to turn the Mud/Snow feature off when driving on a firm road surface.

A new ignition cycle or a second pressing of the Mud/Snow switch will turn this function off.

**Left and Right Sunshades**

Two independent switches are provided, press and hold to lower or raise left or right sunshade.

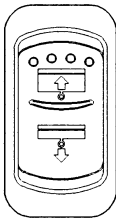

06268

**NOTE**

*Dashboard and steering wheel controls for the sunshades work in parallel and the driver can use them based on its own preference. However, if both set of controls are pressed at the same time, the dash controls will have priority and the steering wheel controls will be deactivated until the ignition is turned off and on again.*



**CAUTION**

Do not attempt to raise or lower these shades manually. Damage to the electric motor or roller mechanism could result.

**Low Docking**

Press this rocker switch to reduce cornering and docking lights intensity.

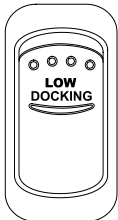

06486

**Traction Control System Mud/Snow Mode**

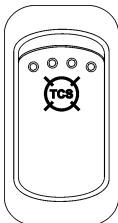

06758

On certain road conditions, it may be useful to retard the intervention of the traction control system TCS during vehicle acceleration. The Mud/Snow function allows greater engine power and more wheel spin during TCS operation. This function may be helpful to set the vehicle in motion on iced road for example.

Press the Mod/Snow switch to turn on this function. The TCS/ESC telltale blinks slowly when the TCS Mud/Snow mode is active. Always remember to turn the Mud/Snow feature off when driving on a firm road surface.

A new ignition cycle or a second pressing of the Mud/Snow switch will turn this function off.

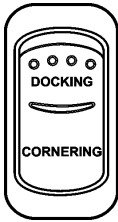

06337

**Docking / Cornering**

Press this rocker switch upwards (DOCKING) to illuminate the cornering and docking lights.

Press this rocker switch rearwards (CORNERING) to illuminate the cornering lights when signaling a left or right turn.

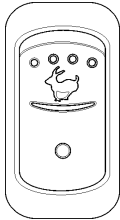

06264

**Fast Idle**

For extended idling periods, run the engine at fast idle. Press down the rocker switch to engage fast idle. This increases the engine speed to approximately 1,000 rpm. Return to normal idle before driving or when stopping engine.

	<b>CAUTION</b>
Even if normally the engine will return to normal idle and remain there if the parking brake is applied and/or transmission is placed in neutral (N), it is safer to first press down the rocker switch to run the engine at normal idle before engaging the transmission.	

	<b>CAUTION</b>
Return the engine to normal idle before shutting the engine OFF.	

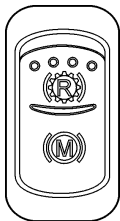

06703

**Engine Brake / Transmission Retarder**

Use this switch to select between the transmission retarder and the engine brake when using the vehicle speed retarding device switches on the steering wheel. Both systems cannot be in function at the same time. This rocker switch can be found on the dashboard, only if the vehicle is equipped with both systems. Refer to "Transmission Retarder" heading in this chapter. Refer also to "Transmission Retarder" & "Engine Brake" in *Other Features* chapter.



06265

**Engine Stop Override (with Automatic Fire Detection and Suppression System)**

Press the Engine Stop Override switch on the dashboard or the Delay Engine Stop switch on the AFSS Protection Panel to delay the engine shutdown and extinguisher discharge by an additional 15 seconds.

	<b>CAUTION</b>
Use this function if you are not prepared to bring the vehicle to a safe stop (i.e. on a railroad track, in intersection).	

This switch is functional only if the vehicle is equipped with the Automatic Fire Detection and Suppression System.

**R.H. INSTRUMENT PANEL**

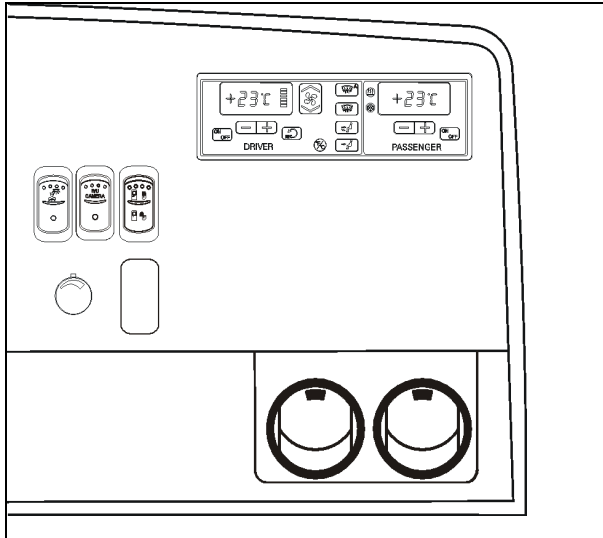

The HVAC control module as well as the cluster dimmer switch, miscellaneous control switches and air vents, are located in the R.H. dashboard panel.

**R.H. INSTRUMENT PANEL**

06562

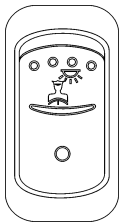

06244

**Driver's Area Lighting**

Press the rocker switch to turn on the driver's overhead light as needed.

**NOTE**

*The entrance overhead light and the stepwell lights turn on with the entrance door opening and turn off with door closing. If the entrance door is left opened, these lights will be turned off automatically if the batteries voltage drops below 24.0 volts.*

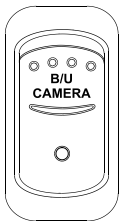

06314

**Back-up Camera**

The back-up camera will turn on automatically upon selection of the reverse gear. Press this switch to turn on the back-up camera and monitor when the transmission is not in the reverse gear.

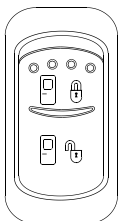

06313

**Front Entrance Door Lock**

Press this switch forward to lock the entrance door from the inside. To unlock the entrance door from the inside and disarm the intrusion protection and anti-theft system, press the switch rearward.

**NOTE**

*When the alarm system is armed, unlocking the entrance door from the inside by sliding its lock lever will not disarm the alarm system. The alarm will sound.*



**Brightness Control**

Adjusts the brightness of the dashboard instruments and switches.

06565

**HVAC CONTROL UNITS**

**Vehicles equipped with small HVAC system**

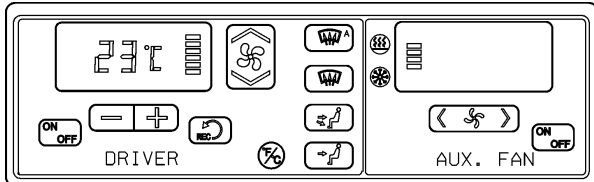

**CONTROL UNIT FOR SMALL HVAC SYSTEM**  
22286

The temperature control in the driver's area is provided directly by the driver section of the HVAC control unit.

Using the Up/Down type switch sets the fan speed and the speed chosen is illustrated on the window display.

In addition to the driver's unit, the small HVAC system also includes an auxiliary unit which uses the temperature control of the driver section of the control unit. The R.H. section of the control unit AUX. FAN enables to actuate the auxiliary unit and to regulate its fan speed. Using the < > type switch sets the fan speed and the speed chosen is illustrated on the window display.

**Vehicles equipped with central HVAC system**

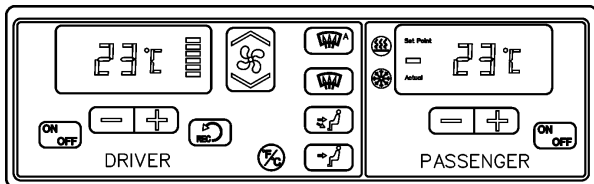

**CONTROL UNIT FOR CENTRAL HVAC SYSTEM** 22276

The vehicle is slightly pressurized by the central HVAC system to prevent dust and moisture from entering. Air flow and controls divide the vehicle into two areas: *driver's area* with defroster and *passenger's (cabin) area*.

Fresh air is fed in each area and has a separate return air and discharge air duct.

**NOTE**  
To operate the air conditioning system when stationary, run engine at fast idle. When the system is running, keep windows and door

closed.

To prevent battery run-down, the central A/C and heating systems will not operate if the charging system is not working properly.

When the A/C system is running, park at least 4 feet (1,5 m) from other vehicles or buildings to allow sufficient air flow through the condenser core.

Separate driver and passenger heating, ventilation and air conditioning controls are located on this control unit. To operate, the vehicle's engine must be running.

The driver section and the passenger section of the control unit may be turned ON by pressing the following button:



06372

Also, the driver section of the control unit turns on automatically at starting of the engine and uses the settings that were kept in memory before turning off of the system.

The A/C compressor starts automatically when the two following conditions are satisfied:

1. The outside temperature is above 32°F (0°C).
2. The passenger's area temperature has reached 7°F (4°C) under the set point.

**NOTE**  
Upon starting, if the outside temperature is above 32°F (0°C) and then drops below 32°F (0°C), the compressor will keep running up to a temperature of 15°F (-9°C) to prevent condensation from forming on the windows.

All parameters set before turning the system OFF will be kept in memory for the next power ON.

**HVAC Air Registers**

The HVAC system has registers to control air flow around the driver's and navigator's area.



- Three are located on the dashboard, two on the R.H. side and one on the left.
- Two more registers are located near the steering wheel column, under the dashboard. These registers are not adjustable but may be electrically open or closed by means of the HVAC control panel.
- Three auxiliary unit registers are located behind the driver (with small HVAC system only).
- For the navigator, two adjustable registers are located near the entrance door, at bottom of first lateral window.

On vehicles equipped with the central HVAC system, these registers are supplied in air by the passenger's (cabin) unit.

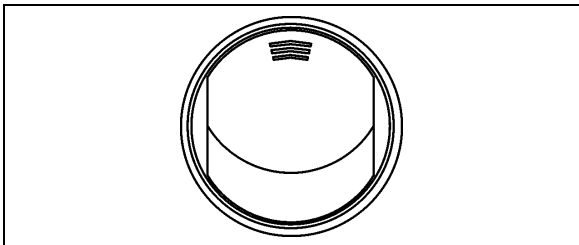

**DASHBOARD AIR REGISTER**  
22287

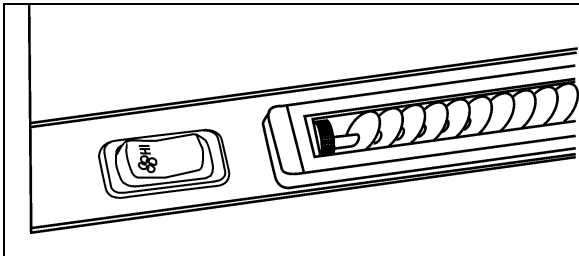

**NAVIGATOR'S AIR REGISTER & FAN SPEED SELECTOR**

### **Navigator fan speed switch**

Upon turning on of the HVAC control unit, both right and left windshield defogging/defrosting fans speed is set according to the driver section settings of the control unit. The navigator can afterwards, use this switch to increase or decrease the right windshield defogging/defrosting fan speed as needed.

### **Navigator air registers**

On small HVAC system, these registers are part of the auxiliary unit. Use the auxiliary unit fan speed switch on the R.H. portion of the control unit (AUX. FAN) to regulate the fan speed. Doing so will also reduce air from the three registers located behind the driver.

## 4-28 CONTROLS AND INSTRUMENTS



### Heating mode indicator

This red LED illuminates when system is heating.



### Cooling mode indicator

This green LED illuminates when the system is cooling (when the compressor clutch is engaged).

#### **NOTE**

*Both heating mode and cooling mode indicator LED can illuminate simultaneously. During winter, if the outside temperature is above 32°F (0°C), the A/C compressor may start for dehumidification purposes to prevent condensation from forming on the windows.*



### Fan speed

This switch controls both right and left windshields defogging/defrosting fans speed. Increase speed by pressing on the upper portion of the button, decrease by pressing on the lower portion.



### Auxiliary unit fan speed (with small HVAC system only)

Use this switch to increase or decrease the auxiliary unit fan speed by pressing on the right or left portion of the button.



### Recirculate

Close or opens the driver's and passenger's section fresh air damper.

A red LED in the top right corner of the button illuminates when air is recirculating. Use for faster section heating.

This feature is automatically cancelled when defogging is activated.

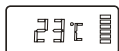

### Driver's section temperature setting

The temperature displayed on the driver section of the control unit is the temperature set point.

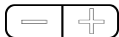

To increase the temperature set point, press on the "+" sign, to decrease the temperature set point, press on the "-" sign. Temperature range is between 60°F and 82°F (16°C to 28°C). On the driver section only, asking for a temperature set point of 82°F (28°C) will keep the coolant valve open.

In case of interior temperature sender unit failure, the coolant valve will remain open and three lines "---" will be displayed.



### **WARNING**

Warm temperatures may cause drowsiness and affect alertness while driving. Keep the temperature comfortable but not too high.

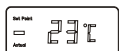

### Passenger's (cabin) section temperature setting (with Central HVAC System)

The temperature displayed on the passenger's side HVAC control unit is the actual temperature

in the passenger's area.

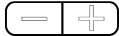

To increase or decrease the temperature set point, press on the "+" or the "-" sign. Pressing these buttons will flash the displayed set point and the word "SET" will highlight. Temperature range is between 60°F and 82°F (16°C to 28°C).

In case of interior temperature sender unit failure, the coolant valve will remain open and three lines "---" will be displayed.

**NOTE**  
*Upon starting of the vehicle, when the ambient temperature is very cold and so is the inside of the vehicle, the HVAC control unit will permit a temperature overshoot up to 3° over the passenger's area set point to help warming up of the area.*



**Windshield defogger/defroster**

Upon pressing this button, the dashboard damper sends air only to the lower windshield. The fans are turned on to maximum speed, the fresh air damper opens completely (REC off) and the driver set point is increased to 4°F (2°C) over the passenger's section set point.



The dashboard damper sends air only to the lower windshield when activated. The footwell damper is closed also but the fans speed can be reduced or increased.



**Panel and footwell**

The dashboard damper sends air to the panel vents and footwell.



**Panel**

Air is sent to panel vents. The foot damper is closed.



**Temperature degree selector**

Toggles the HVAC control unit temperature units between Fahrenheit and Celsius. The driver's section must be on. Also toggles the outside temperature units displayed on the telltale panel.

## 4-30 CONTROLS AND INSTRUMENTS

### INSTRUMENT CLUSTER

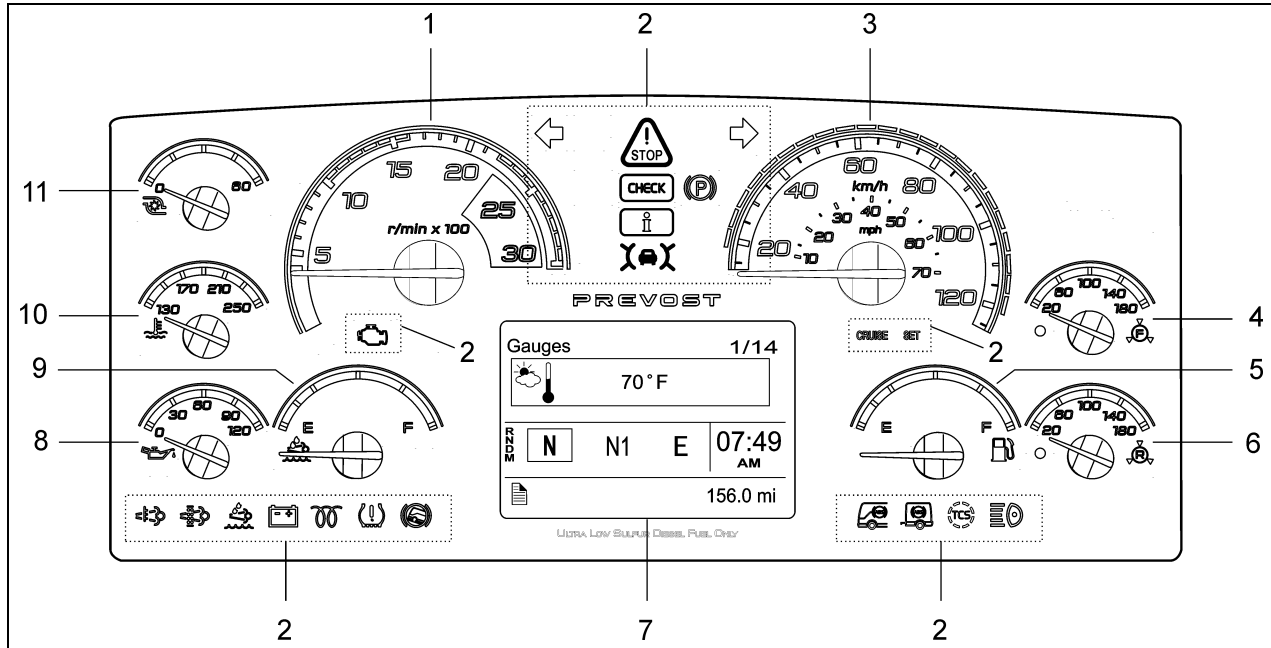

06727

1. Tachometer
2. Telltale lights
3. Speedometer
4. Front brake air pressure (secondary)
5. Fuel level
6. Rear brake air pressure (primary)
7. Driver Information Display (DID)
8. Oil pressure indicator
9. DEF level (Diesel Exhaust Fluid) indicator
10. Engine coolant temperature
11. Turbo boost pressure

The instrument cluster includes the analog instruments. It also presents two devices to communicate information to the driver, the telltale lights and the Driver Information Display (DID).

Indications and warnings are presented according to three levels of attention required:

#### 1. THE TELLTALE LIGHTS

The highest level of attention. The telltale lights are temporary and exceptional; they present information critical to safety or vehicle integrity.

#### 2. THE POP-UP MESSAGES

The second level of attention. The pop-up messages appear in the Driver Information Display DID without the driver's intervention and acknowledgement. Pop-up messages present supplemental information to the driver.

#### 3. THE STATUS LINE

The lowest level of attention. The status line monitors certain systems and gives feedback to the driver concerning current actions and functions.

ANALOG INDICATORS

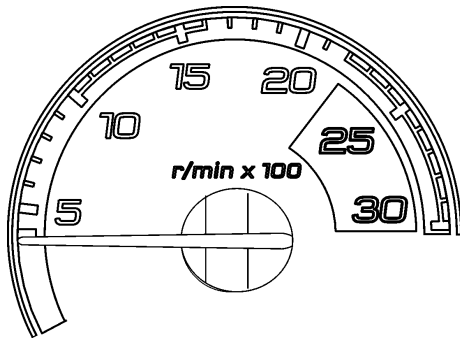

06728

**Tachometer (rpm x 100)**

Indicates the operating speed of the engine in hundreds of revolutions per minute. The tachometer serves as a guide for gear shifting and helps to prevent engine over-speeding when driving downhill with the engine brake operating. Use the green field for normal driving (1000 to 1600 RPM).



**CAUTION**

Never allow the engine to go into the red field. This could lead to severe engine damage.

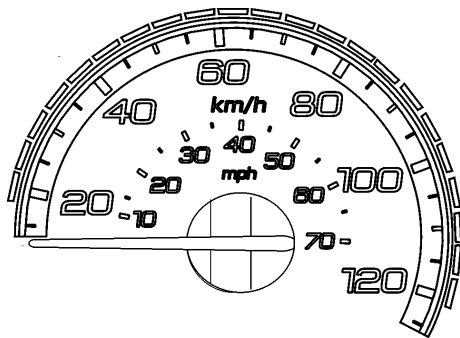

06729

**Speedometer (mph, km/h)**

Indicates the vehicle speed in miles per hour (mph) and kilometers per hour (km/h). The LEDs above the instrument work in conjunction with AWARE Adaptive Cruise Braking (ACB) system. Refer to "Prevost Aware Adaptive Cruise Braking" paragraph.

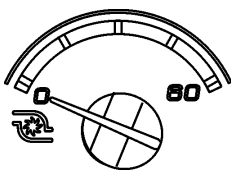

06730

**Turbo boost pressure (psi)**

Indicates the turbo boost pressure in psi. This pressure should be the same at a given engine temperature, speed, and load. An unusual reading could indicate an engine failure.

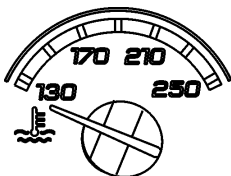

06731

**Engine coolant temperature (°F)**

Indicates the operating temperature of the engine coolant in °F. The normal reading should be between 170°F and 222°F (80°C to 106°C).

The temperature limit is dependent on the electronic program for the engine model. When coolant temperature is excessive, the STOP telltale light turns on, an audible alarm sounds and a pop-up message appears on the DID. The engine protection system will automatically derate and stop the engine in 30 seconds. Stop at the first safe place where the problem can be checked.

If the temperature remains below or exceeds the normal temperature range, the cooling system should be checked for problems.



STOP telltale light

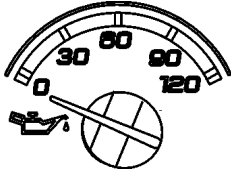

06732

**Engine oil pressure (psi)**

Indicates the engine oil pressure in psi. When the oil pressure is too low, the STOP telltale light turns on, an audible alarm sounds and a message appears on the DID. If the engine is at risk, the EECU may decrease the engine power. Bring the vehicle to a safe stop where the problem can be checked.



STOP telltale light



OIL PRESSURE Pictogram



**WARNING**

Failure to take necessary action when the STOP telltale light is on can ultimately result in automatic engine derate and shutdown.

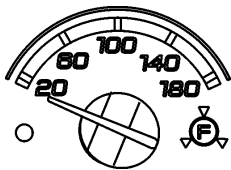

06737

**Front brake air pressure (psi) – Secondary System**

Indicates the front brake air system pressure in psi. The normal operating pressure is from 122 to 140 psi.

A low air pressure indicator LED illuminates when the front (secondary) air system pressure drops below 75 psi. If the air pressure drops further, the STOP telltale light will turn on, an audible alarm will sound and a message will appear on the DID. If the air pressure drops below 60 psi, the emergency spring brake applies at full capacity.



**WARNING**

Do not drive the coach when the brake air pressure is low.

**NOTE**

Do not refer to dashboard instruments during adjustment procedures. Use only calibrated gauges.

**Rear brake air pressure (psi) – Primary System**

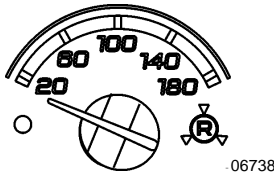

Indicates the rear brake air system pressure in psi. The normal operating pressure is from 122 to 140 psi.

A low air pressure indicator LED illuminates when the rear (primary) air system pressure drops below 75 psi. If the air pressure drops further, the STOP telltale light will turn on, an audible alarm will sound and a message will appear in the DID. If the air pressure drops below 60 psi, the emergency spring brake applies at full capacity.



STOP telltale light



**WARNING**

Do not drive the coach when the brake air pressure is low.

**DEF level**

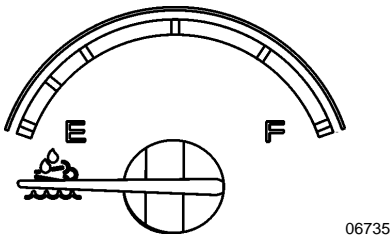

Indicates the amount of DEF (Diesel Exhaust Fluid) remaining in the DEF tank. The DEF tank is considered as being full when it contains 16 gallons (60 liters) of DEF. DEF consumption will be approximately 2% of the diesel fuel consumed.



**CAUTION**

DEF will begin to crystallize and freeze at 12°F (-11°C). DEF expands by approximately 7% when frozen. In order to permit DEF expansion without causing damages to the DEF tank, do not fill the DEF tank with more than 16 gallons (60 liters).

**Fuel level**

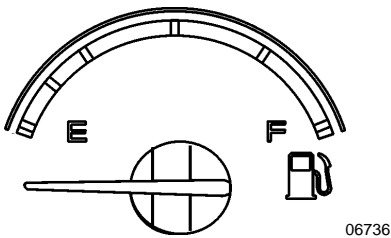

Indicates the amount of fuel remaining in the fuel tank. At the beginning of the red area, there is approximately 48 gallons (182 liters) left in the tank.

**NOTE**

A pop-up message will appear in the DID informing that there is only 24 gallons (92 liters) left in the fuel tank.

TELLTALE LIGHTS

The telltale lights illuminate during 5 seconds at the start of every ignition cycle as a light bulb check.



**Stop**

Indicates that a serious problem has been detected. Immediately park the coach in a safe place and stop the engine. This telltale light may be accompanied with a message in the DID and a diagnostic troubleshooting code will be stored to ease identification of the problem. **WARNING:** Failure to take necessary action when the STOP telltale light is on can ultimately result in automatic engine derate and shutdown.



**Check**

Indicates that a problem has been detected and must be checked at the next stop. This telltale light may be accompanied with a message in the DID and a diagnostic troubleshooting code will be stored to ease identification of the problem.



**Forward vehicle detected – Adaptive cruise braking**

When the ACB is engaged with a cruise speed set and the forward vehicle is in range, the FORWARD VEHICLE DETECTED telltale light illuminates, indicating the ACB system is actively tracking the forward vehicle.

**Green:** The vehicle ahead of you is detected by the radar.

**Flashing red:** Impact alert. The vehicle ahead of you is too close. The driver must take immediate evasive action by applying more braking power and/or steering clear of the vehicle ahead to avoid a potential collision.

**Red:** System malfunction. The Adaptive Cruise Braking is not available.



**Information**

This telltale light illuminates when there is a new information message or an abnormal status is detected by the electronic control unit. A pictogram, text or both are shown in the DID in addition to the INFO telltale light. Make sure the indicated fault is checked at the next stop.



**Turn signal indicators**

Flashes when the right or left turn signals are activated. Signal right and left turns by operating the multi-function lever. See “Steering Column Controls” in this chapter.

***NOTE***  
*The turn signals are automatically activated when the vehicle is backing up.*



**Parking brake or emergency brake applied**

Illuminates when the emergency/parking brake is applied. The control valve is located on the L.H. control panel. An audible alert will sound if ignition is turned to OFF and the parking brake is not engaged.



**Aftertreatment system malfunction (Malfunction Indicator Lamp)**

Indicates a failure of an emission control device. May illuminate at the same time as the CHECK amber warning light. The lamp will go out after 3 completed *ignition on-ride-ignition off* cycles. Vehicle can be driven to end of shift. Call for service.



**CRUISE**      **Cruise control**  
Indicates that the cruise control is enabled.

**SET**            **Cruise control set speed**  
Indicates that a cruising speed is set and stored in the memory.



06740\_A

**High exhaust system temperature (HEST)**  
Illuminates to notify the driver of potentially hazardous exhaust gas temperature at the exhaust system diffuser.

 <b>WARNING</b>
<p>During regeneration, exhaust temperature may reach up to 1200°F (650°C) at the particulate filter. When parking the vehicle, if this telltale light is illuminating, make sure that the exhaust system diffuser is away from people or any flammable materials, vapors or structures.</p>



06740\_B

**DPF regeneration request**  
Illuminates to notify the driver that a manual stationary regeneration will be required soon. Refer to “Exhaust Aftertreatment System” paragraph in *Other Features* chapter.



06740\_C

**Low DEF level**  
Illuminates when there is less than 2.6 gallons (10 liters) of DEF left in the tank.

 <b>CAUTION</b>
<p>This telltale light starts flashing when there is only 2.5 liters (0.6 gallons) left in the tank.</p> <p>If the vehicle is kept in operation with an empty DEF tank, and engine derate will eventually occur, limiting the speed to 5 mph.</p>



06740\_D

**Alternators**  
Indicates that one of the alternators is not charging.

<b>NOTE</b>
<p><i>To identify which alternator is defective (1=lower alternator, 2=upper alternator), perform a system diagnostic using the Driver Information Display DIAGNOSTICS menu. Select VIEW ACTIVE FAULTS and then ELECTRICAL SYSTEM. Scroll through the active faults. The electrical system active faults will appear. A diagnostic message indicating “alternator 1” or “alternator 2” with failure mode “open circuit” will come in sight.</i></p>



06740\_E

**Intake air preheater on – wait before starting**

Illuminates when the intake air preheater element is in function. Wait until this telltale light has turned off before starting the engine. For more information on this feature, refer to paragraph “Cold Weather Starting” in *Starting And Stopping Procedures* chapter.



06740\_F

**Flat tire (with optional tire pressure monitoring system)**

Illuminates when a tire pressure is 25% below the target tire pressure.



06740\_H

**Antilock brake system (ABS)**

Illuminates when the ABS is not available or when the ABS is malfunctioning. Since the ABS system does not operate at less than 4 mph (7 km/h), the indicator will remain illuminated until the coach reaches that speed. Refer to *Other Features* chapter.



06740\_I

**Trailer antilock brake system (ABS)**

Illuminates when the trailer ABS is not available or when the trailer ABS is malfunctioning.



06740\_AA

**TCS/ESC - Traction Control System and Electronic Stability Control**

At vehicle ignition, TCS/ESC telltale lamp illuminates for approximately 3 seconds and then turns off. If it remains on steadily (not flashing) after ignition, or if it illuminates steadily while you are driving, the TCS or ESC system may not be fully functional or their operation may be completely disabled. If this happens, your vehicle will still have normal service braking and it still can be driven, although without the benefits of TCS or an ESC system.

**Flashes quickly** when ESC or TCS intervenes to reduce risk of loss of control.

**Flashes slowly** when TCS's Mud/Snow mode is turned on using the Mud/Snow switch



06740\_K

**High beam**

Illuminates when the high beams are selected. High and low beams are selected with the multi-function lever. Refer to “Steering Column Controls” paragraph in this chapter.

**STOP, CHECK and INFORMATION telltale lights**

STOP, CHECK and INFORMATION telltale lights illuminate automatically to draw the attention of the driver and their associated messages are displayed in the DID. More than one message (see “Acknowledging Messages” below) can be active at the same time. A displayed message can be replaced by a new message provided the new message has a higher priority. Only fault codes that have a direct impact on vehicle operation are displayed. All fault codes are stored in the appropriate ECU for access by service technicians.

**STOP Telltale light**

In the event of a serious fault, the red STOP telltale light comes on and an audible alarm will sound if the engine is running. An illuminated stop message light indicates a serious problem has been detected, and the driver must respond immediately to the problem.



When illuminating, this telltale light means the vehicle must be safely pulled off the road and stopped. In some instances, the engine must be switched off immediately.

	<p><b>WARNING</b></p>
<p>Failure to stop and take necessary action when the STOP telltale light is on can result in automatic engine derate and shutdown.</p>	

In some cases preventive action may be taken by the engine ECU to protect the engine. For further details, refer to “Engine Protection System” in *Starting and Stopping Procedures*.

**CHECK Telltale light**

This telltale light means that a fault or an abnormal operating condition has been detected. The vehicle must be checked at the next stop.



If the CHECK telltale light illuminates, an associated message is displayed in the DID. Always pay attention to the associated messages (see “Acknowledging Messages” below).

**INFORMATION Telltale light**

The INFO indicator light comes on when there is a new information message or an abnormal status is detected by the electronic control unit. A pictogram or text or both are shown in the DID in addition to the INFO telltale light (see “Acknowledging Messages” below).



**Acknowledging Messages**

A fault message associated to a STOP, CHECK or INFORMATION telltale light must be acknowledged by pressing the ESCAPE or ENTER button after which the display returns to the same status that existed before the fault occurred. All messages can be acknowledged. Acknowledged but inactive messages are displayed again when the ignition key is turned to the START position or they can be read in the DID menu. Refer to *Other Features* for more information on the DID menus.

**DRIVER INFORMATION DISPLAY**

The DID (Driver Information Display) is located in the center of the instrument cluster. It displays digital gauges, main menus and sub-menus that provide necessary and important information to the driver. The information available to the driver depends on vehicle configuration, and whether the vehicle is in operation or parked. For the list of the available menus and sub-menus, refer to “Driver Information Display Menus” in *Other Features* chapter.

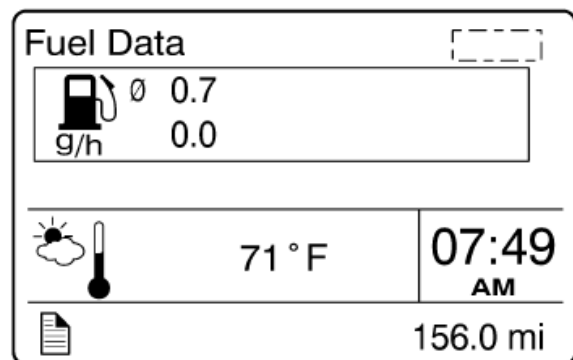

The outside air temperature, fuel flow and the odometer are part of the default display. You can change the default display by your selection of favorite gauges using the Driver Information Display sub-menu Favorite Display Setting.

## 4-38 CONTROLS AND INSTRUMENTS

Refer to *Other Features* chapter for more information.

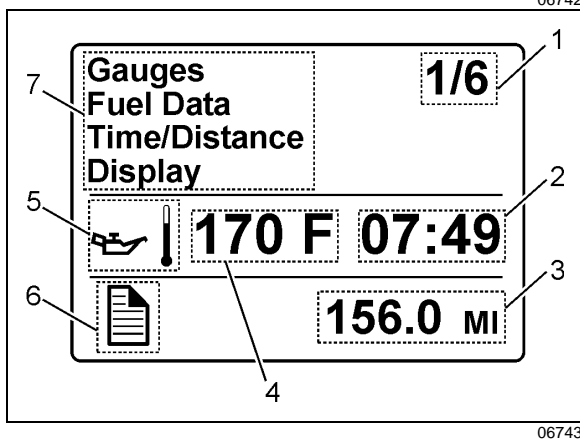
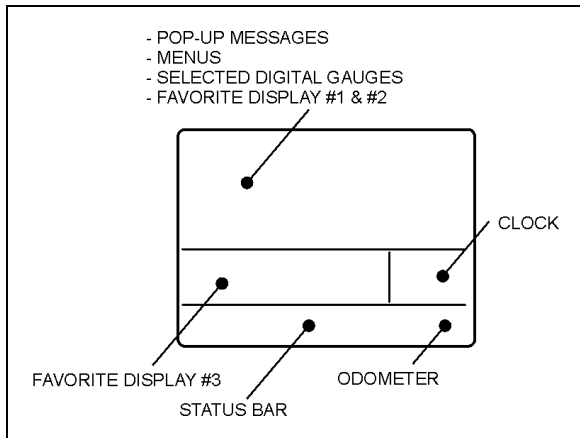

1. Indicates first of six available menus (varies by menu)
2. Clock
3. Odometer
4. Value or data (in this example, the engine oil temperature)
5. Pictogram relevant to the displayed value or data
6. Status bar active pictogram
7. Messages or available menus

### Selecting a menu

- The ESCAPE button is used to return to the previous menu or display, or to cancel a setting or operation.
- The ENTER button is used to display a list of menus, open a menu, and select a chosen value.
- The UP button is used to scroll up through a menu and to increase numerical values.

- The DOWN button is used to scroll down through a menu and to decrease numerical values.

Menus are placed in a cascade arrangement. Use the steering wheel controls buttons to scroll through them.

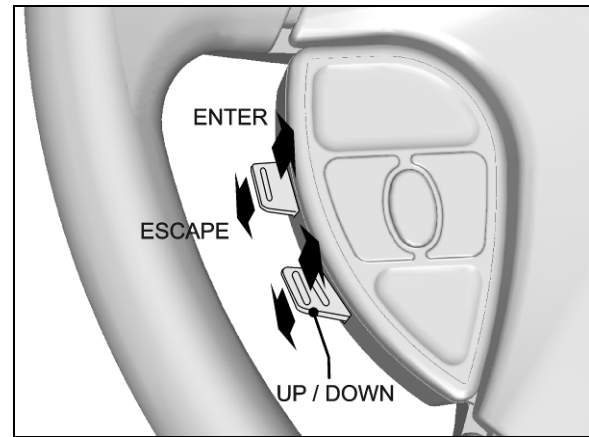

To select a menu:

1. Press the ENTER or ESCAPE button to display the list of available menus.
2. Use the UP/DOWN button to scroll up or down through the menus.
3. Use the ENTER button to open a menu.
4. Use the ESCAPE button to return to the previous menu or display or to cancel a setting or operation.

### To change settings

To change a setting, like the clock for example:

5. Use the UP/DOWN button to increase or decrease the numerical value of the selected field.
6. Use the ENTER button to confirm your choice and to move to the next field.
7. Press the ESCAPE button to return to the previous field or to cancel a setting or operation.

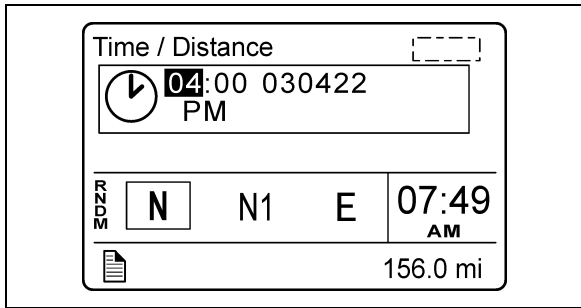

06743

**Scrolling through the menus without using the steering wheel buttons**

In case of failure of the steering wheel buttons, it is still possible to gain access to the menus or acknowledge the pop-up messages to return to the default display.

This alternate mode is possible only if the steering wheel buttons are faulty.

To enable the alternate mode:

1. Apply the parking brake;
2. Depress and hold the service brake pedal.

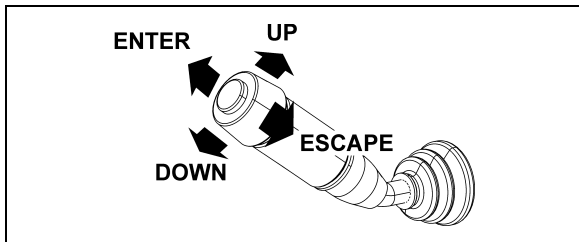

**MULTI-FUNCTION LEVER**

In alternate mode, use the multi-function lever as follows:

- Move the lever up = UP
- Move the lever down = DOWN
- Push the lever away from you = ENTER
- Pull the lever towards you = ESCAPE









## 4-40 CONTROLS AND INSTRUMENTS











### PICTOGRAMS DISPLAYED ON THE DRIVER INFORMATION DISPLAY (DID)

**NOTE**

*In certain situations, the pictogram displayed represents a system or a function of the vehicle. A particular pictogram may be displayed with different messages. In that situation, it is very important to pay attention to the message displayed with the pictogram.*

### Warning pictograms, pop-up message pictograms, verifications and information pictograms

DRIVER INFORMATION DISPLAY "GAUGES" MENU PICTOGRAMS	
Pictogram	Description
	<b>Engine oil temperature</b>
	<b>Outside air temperature</b>
	<b>A/C compressor pressure</b> This pictogram is displayed with A/C compressor suction pressure value (Low Side) and discharge pressure value (High Side).
	<b>Accessories air pressure</b> Normal pressure should be between 95 and 125 psi.
	<b>Voltmeter</b> This pictogram is displayed with both the 12-volt and 24-volt electrical system current voltage value. When the engine is running, the 24-volt electrical system voltage value should be between 26,5 et 28,0 volts.
	<b>Transmission oil temperature</b>
	<b>Current gear position (I-Shift transmission)</b> Indicate the current transmission gear position on the Volvo I-Shift transmission. R= reverse N = neutral D= drive M= manuel mode
	<b>Battery state of charge</b> This pictogram is displayed with the state of charge (%) of the 12-volt and 24-volt battery banks.

POP-UP MESSAGES	
Pictogram	Description
	<b>High engine oil temperature</b>
	<b>Engine coolant temperature</b>
	<b>Engine oil pressure</b>
	<b>Intake air preheater failure</b>
	<b>Engine temperature too low for Volvo Engine Brake (VEB) operation</b>
	<b>High transmission oil temperature</b> This pictogram indicates that the transmission oil temperature is too high. Turn the transmission retarder off to allow the oil to cool down.
	<b>Allison Transmission– Oil or filter replacement required</b> This pictogram may be displayed with many different messages. Pay attention to the displayed message which can advise that the transmission oil or filter change is necessary. Refer to Appendix C for more information on the Allison transmission prognostic features (oil life monitor, filter life monitor, transmission health monitor).
	<b>Trailer braking system low air pressure / Trailer parking brake</b> This pictogram appears when the trailer emergency/parking brake is unexpectedly applied as when the vehicle is moving and a parking brake air line rupture happens.
	<b>Low brake or ABS air pressure</b>
	<b>A/C system pressure high</b> This pictogram indicates that the A/C system pressure is too high. If the A/C pressure is too high, the compressor clutch is disengaged, but the fan remains activated.
<p><b>NOTE</b></p> <p>When outside temperature is high, it is possible and normal for that pictogram to appear.</p>	



**A/C System Pressure Low**

This pictogram indicates that the A/C system pressure is too low. If the A/C pressure is too low, the compressor clutch disengages and the fan stops.

**NOTE**

When outside temperature is low, it is possible and normal for that pictogram to appear.



**Battery voltage warning**

This pictogram indicates that the battery voltage is too high, too low or the 12-12-volts/24-volts battery arrangement is not equalized.

The value LOW or HIGH is displayed at the right of the pictogram to indicate if the voltage is too low or too high.

**NOTE**

This pictogram will illuminate for a few seconds after the engine is started because of the voltage drop when the starter is engaged.

**NOTE**

To identify the battery problem (too high, too low or not equalized voltage), using the DID menus, perform a system diagnostic by selecting DIAGNOSTIC, VIEW ACTIVE FAULTS, ELECTRICAL SYSTEM and see the fault messages.

**NOTE**

To prevent discharge of the batteries when the engine is not running, some functions are automatically switched off if the batteries voltage drops below 24.0 volts for more than 30 seconds. Set the ignition key to the OFF position and then turn the ignition key to the ON position to reactivate the functions for a period of 30 seconds before they switch off again.

**NOTE**

If the battery equalizer indicator illuminates, make sure that the battery equalizer circuit breakers are reset before requesting breakdown assistance. Wait 15 minutes after setting breakers to allow batteries to equalize. The breakers are located in the main power compartment.



**Engine door ajar**

This pictogram indicates that the engine compartment door is ajar.



**Awning window open**

This pictogram indicates that an awning window is open or unlocked.





**Baggage compartment door ajar**

This pictogram indicates that one or more baggage bay doors are ajar.



**Low Windshield Washer or Headlights Washer Fluid Level**

Illuminates when the windshield washer or the headlight washer fluid level is low. The washer fluid containers are located inside the front service compartment.



**WARNING**

Do not drive without sufficient washer fluid.



**Wheelchair lift**

This pictogram indicates that the wheelchair lift system is enabled and the wheelchair access door or the lift compartment door is open. It is necessary to stow the wheelchair lift, close the doors and set the wheelchair lift system enable switch to the OFF position to permit release of the parking brake.



**Lavatory occupied**

This pictogram indicates that the lavatory compartment is occupied. This pictogram will appear only when the engine is shut down in order to advise the driver of the presence of a passenger in the lavatory compartment during a stop.



**Lavatory compartment emergency call**

If the vehicle is moving, this pictogram indicates that a passenger has activated the lavatory compartment emergency call button.



**Differential lock (option)**

This pictogram indicates that the differential action is locked.



**Freezing conditions**

This pictogram appears when the temperature is in the range between 0°C and 2°C (32°F et 35°F), when the road is most slippery.



**Fuel level**

This pictogram appears when approximately 24 US gallons (92 liters) of fuel remains in the tank. Refuel as soon as possible.



**Automatic traction control**

This pictogram appears when the automatic traction control system intervenes to prevent excess wheel spin during acceleration.



**Parking brake applied**



**DPF regeneration**



**High exhaust gas temperature**

This pictogram appears to notify the driver of potentially hazardous exhaust gas temperature at the DPF outlet.



**WARNING**

During regeneration, exhaust temperature may reach up to 1200°F (650°C) at the particulate filter. When parking the vehicle, if this pictogram is displayed, make sure that the DPF outlet diffuser is away from people or any flammable materials, vapors or structures.



**Fuel economy**

This pictogram is displayed with fuel consumption value of the vehicle. Proper units for the displayed value are written under the pictogram: liters/100km, km/liter, mpg, liters/hour.



**Percentage of trip made with regenerated electricity**

This pictogram is displayed with the percentage of trip done with electricity produced with engine negative torque (braking, deceleration).



**Leg fuel consumption**

This pictogram is displayed with the value for the fuel consumption for the current leg.



**Leg fuel consumption**

This pictogram is displayed with the value for the fuel consumption for the current leg.



**Trip data**

Function of the DID's "Time/Distance" menu. Refer to "Driver Information Display Menus" in *Other Features* chapter.



**Estimated time of arrival**

Function of the DID's "Time/Distance" menu. Refer to "Driver Information Display Menus" in *Other Features* chapter.



**Fuel filter/water separator**

Indicates that the draining the fuel filter/water separator is required. See *Care And Maintenance* chapter.



**Raised auxiliary axle**

This pictogram appears if the vehicle speed exceeds 12 mph (20 km/h) while the auxiliary axle is raised.



**Low buoy**

This pictogram appears if the vehicle speed exceeds 12 mph (20 km/h) while the front suspension of the vehicle (kneeling) or the entire vehicle suspension is lowered (low buoy).



**Fire in engine compartment**

This pictogram appears if a fire is detected in the engine compartment while the vehicle is on the road. An audible alarm informs the driver when a fire is detected. In case of fire detection when parked (parking brake applied, engine running or not), the electric horn is activated to alert the driver. Refer to *Safety Features and Equipment* chapter.



**WARNING**

In case of a fire, stop the vehicle immediately, stop the engine and evacuate the vehicle.

**NOTE**

*It is possible to cancel an alarm while on the road. To do so, stop the vehicle. Cycle the ignition between the ON and OFF position and then start the vehicle normally. This can be done on a temporary basis when a false alarm is activated by a defective fire detector. The driver can go on without being annoyed by the alarm.*











**NOTE**

*To stop the electric horn alarm when parked, cycle the ignition between the ON and OFF position twice within 3 seconds.*

**NOTE**

*For extinguisher's location, refer to SAFETY FEATURES AND EQUIPMENT chapter.*

Status Line Pictograms

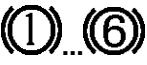
Pictogram	Description
	<b>Message active</b>
	<b>Alarm clock activated</b>
	<b>Raised auxiliary axle</b>
	<b>Kneeling/front suspension hi-buoy active</b> Indicates that the front suspension (kneeling) or the entire vehicle suspension (low buoy) is lowered.
	<b>Baggage compartments locked</b> Confirm that all the baggage compartment doors are locked.
	<b>Baggage compartments unlocked</b> Indicates that at least one baggage compartment door is unlocked.
	<b>Adaptive Cruise Braking (ACB) not available</b> Indicates that the Adaptive Cruise Braking system is disabled.
	<b>Engine brake</b> Confirm that the engine brake is disabled.
	<b>Engine brake – Engine brake Low (1) and engine brake High (2)</b> Confirm which engine braking power is selected with the steering wheel control buttons.
	<b>Allison transmission retarder</b> Confirm that the Allison transmission retarder is off.
	<b>Allison transmission retarder – Braking level 0, 1, 2, 3, 4, 5, 6</b> Confirm the retarder hand lever position. Each position corresponds to a given braking level. Refer to “Transmission Retarder” heading in this chapter.
<b>TEST</b>	<b>Vehicle test</b> Confirms that one of the vehicle test modes is active. For further information about the available test modes, refer to the Driver Information Display DIAGNOSTICS menu in <i>Other Features</i> chapter.

**Vehicle Clearance Information**

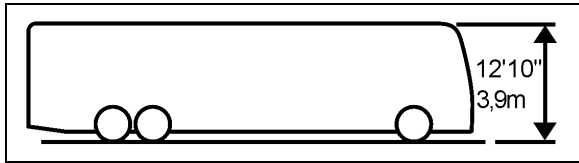

Safe vehicle clearance height is 12'10" (3.9 m).



**CAUTION**

Vehicle clearance is higher when the ventilation hatch is open, Hi-Buoy is selected or if additional equipment is installed on the roof.

**STEERING COLUMN CONTROLS**

Many of the most frequently used controls are conveniently placed on the steering column or the steering wheel, just like a passenger car. The Multi-function lever is located on the left side of the steering wheel while the optional transmission retarder lever is located on the right side of the steering wheel. Switches for the electric horn and the air horn are located directly on the steering wheel.

**MULTI-FUNCTION LEVER**

The multi-function lever is used to operate the following:

**Turn Signal (1)**

Move the lever all the way up until it locks in position to signal a right turn. Move the lever all the way down until it locks in position to signal a left turn. The lever automatically returns to the horizontal OFF position once the turn is completed.

**Lane Change Signal (2)**

Move the lever part way to the catch position and hold until the lane change maneuver is completed. The lever will spring back into the OFF position once released.

**Headlight Beam Toggle Switch (3)**

Toggle between high and low beams by pulling the lever up towards you. To flash the headlights, pull the lever up halfway. The lever will spring back into normal position once released.

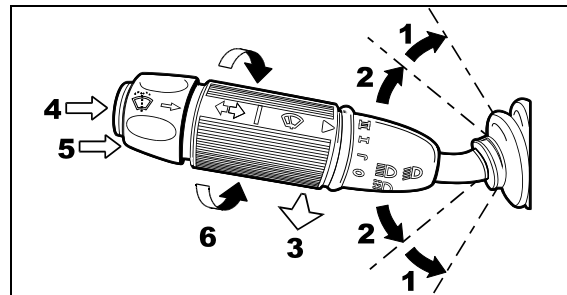

MULTI-FUNCTION LEVER

23133

**Courtesy Blinkers (4)**

Clearance and parking lights can be flashed by pressing the button located on the lever tip.

**Windshield Washer Control (5)**

Push the external ring at the end of the lever toward the steering column to activate the lower windshield washers. The wipers come ON and continue wiping for a few seconds after the ring is released.



**WARNING**

Before using the windshield washers in cold weather, heat the windshield with the defroster to prevent icing and reduced visibility.



**CAUTION**

To avoid damaging the pump mechanism, do not use the windshield washer when the fluid level is very low or empty.

**Windshield Wipers (6)**

Turn the lever counterclockwise to activate the lower windshield wipers. The first position activates the wipers intermittently. The second position is the slow speed and the third position is for high speed wiping.



**CAUTION**

To avoid scratching the windshield, do not operate the wipers when the windshield is dry. To avoid damaging the wiper motor, free wiper blades that may be frozen to the windshield before operating the wipers.

STEERING WHEEL CONTROLS

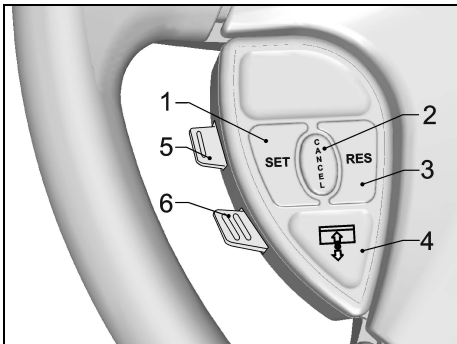

LEFT STEERING WHEEL CONTROLS

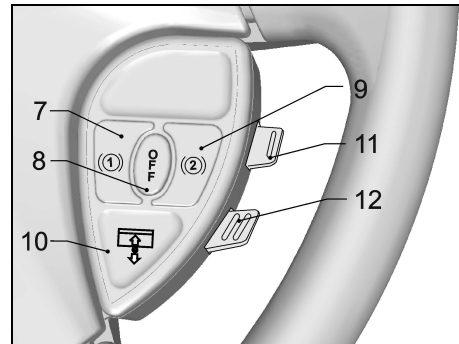



RIGHT STEERING WHEEL CONTROLS

The steering wheel controls include the following functions:

- 1 **Set (cruise control)**  
For the cruise control operating instructions, refer to “Cruise Control” paragraph in this chapter.
- 2 **Cancel (cruise control)**  
For the cruise control operating instructions, refer to “Cruise Control” paragraph in this chapter.
- 3 **Resume (cruise control)**  
For the cruise control operating instructions, refer to “Cruise Control” paragraph in this chapter.
- 4, 10 **Left Sunshade, Right Sunshade**  
Press and hold the button to lower the left or right sunshade. Press twice rapidly and hold the button to raise the left or right sunshade.

	<p><b>CAUTION</b></p> <p>Do not attempt to raise or lower these shades manually. Damage to electric motor or roller mechanism could result.</p>
---	---

- 5 **Escape/Enter (Driver Information Display)**  
Enter: Lift this button briefly.  
Escape: Press briefly on this button.
- 6 **Up/Down (Driver Information Display)**  
Use this button to scroll up or down through the menus.
- 7 **Retarder / Engine Brake Low **  
If your vehicle is equipped with a transmission retarder, press this button to simply enable the transmission retarder. Afterwards, operate the transmission retarder with the hand lever mounted on the steering wheel or the brake pedal. For more information about the operation of this system, refer to “Transmission Retarder” heading in this chapter.  
On vehicles equipped with an engine brake, the engine brake provides two levels of braking power. Press this button for low engine braking power (about 66 % of full braking power). Refer to *Other Features* chapter for more information about the engine brake operation.

 **WARNING**

Engine brake must be used on dry road only. Never use the engine brake on slippery roads; loss of control could result.

**8 Retarder / Engine Brake OFF**

Press this button to cancel operation of the transmission retarder or the engine brake.

**9 Retarder / Engine Brake High (Ⓜ)**

If your vehicle is equipped with a transmission retarder, this button has the same effect than the Retarder/Engine Brake Low (Ⓛ) button.

On vehicles equipped with engine brake, pressing this button will permit full application of engine brake (100 % of braking power). Refer to *Other Features* chapter for more information concerning the engine brake operation.

 **WARNING**

Engine brake must be used on dry road only. Never use the engine brake on slippery roads; loss of control could result.

**11** Not used on VIP.

**12** Not used on VIP.

**HORNS**

The electric horn (city horn) and air horn (highway horn) are operated from the steering wheel center pad. Use the horn selector switch located on the lateral control panel to select the appropriate horn type.

**NOTE**

*When the vehicle is stationary, the electric horn will sound to inform the driver that a fire is detected in the engine compartment.*

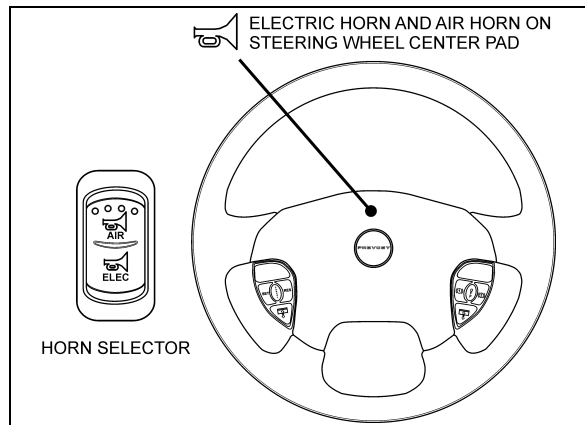

Steering Wheel

14068

**TRANSMISSION RETARDER (optional)**

The retarder can be operated using a hand lever mounted on the steering wheel column or using the service brake pedal.

To use the transmission retarder, it must be activated first by pressing one of the two Retarder/Engine Brake buttons on the steering wheel.

**Operating the Retarder Using the Hand Lever**

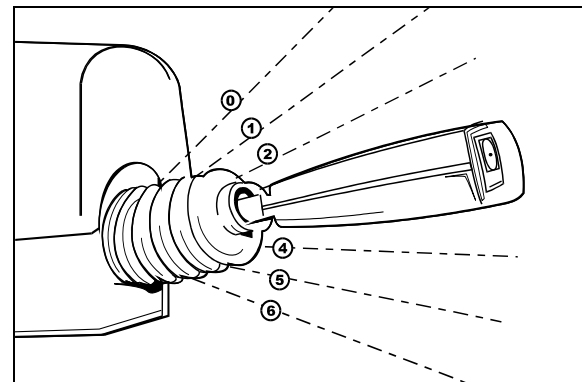

RETARDER HAND LEVER

07043

## 4-50 CONTROLS AND INSTRUMENTS

With the retarder enabled and the accelerator pedal released, move the output retarder lever clockwise from the first to the sixth position. The braking effect occurs as soon as the accelerator pedal is released. The braking level for each position is as follows:

Position	Braking level (up to)
Initial ①	Varies with brake pedal. No effect upon release of the accelerator pedal.
①	16%
②	33%
③	49%
④	71%
⑤	89%
⑥	100%

### NOTE

*The output retarder lever is located on the right side of the steering column.*

### Operating the Retarder Using the Brake Pedal

With the retarder enabled, the accelerator pedal released and the output retarder lever in the initial position ①, depressing the brake pedal will engage both the service brake and the transmission retarder. This is referred to as retarder-brake blending. The further the pedal is depressed, the more total braking power is provided. Refer to *Other Features* chapter for further information about the transmission retarder.

### NOTE

*If the wheels start to lock up on slippery roads, the output retarder will automatically deactivate until the wheels start to turn.*

## FOOT-OPERATED CONTROLS

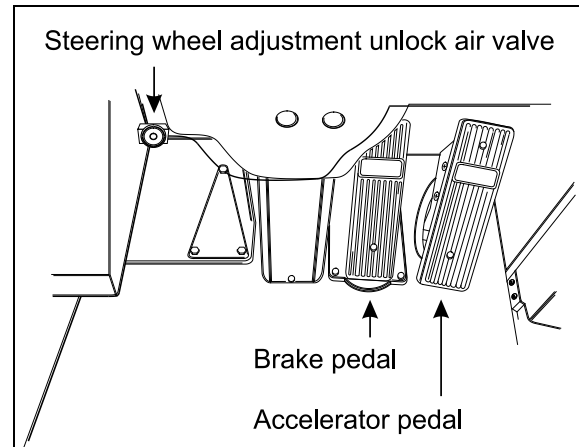

FOOT OPERATED CONTROLS

00023A

### BRAKE PEDAL

The private coach is equipped with a dual braking system. The front brakes operate from a different air source than the drive and auxiliary axle brakes.

The dual braking system becomes a modulated emergency system if a pressure drop occurs in the primary brake system.

Service brakes are applied by depressing the brake pedal. Braking increases with the amount of pressure applied to the foot pedal. Refer to *Other Features* chapter under Antilock Braking System.

For safe and effective braking, the air system pressure should reach at least 95 psi (655 kPa) in both the primary and secondary circuits.

A warning light and an audible alert will sound when the air pressure in either the primary or secondary circuits drops below 66 psi (455 kPa). If this occurs, stop the coach, determine the cause of the pressure loss before proceeding. The brake pedal can be used in conjunction with the transmission retarder. Refer to "Transmission Output Retarder" heading in this chapter.



### WARNING

Immediately report any brake system problem to the nearest Prevost or Prevost-approved service center.



**WARNING**

Do not "fan" or "pump" the brake pedal. This practice does not increase brake system effectiveness but rather reduces system air pressure thereby causing reduced braking effectiveness.

**CAUTION**

"Riding" the brake by resting one's foot on the brake pedal when not braking can cause abnormally high brake temperature, can damage and cause premature wear of brake components and reduce brake effectiveness.

**ACCELERATOR PEDAL**

Controls engine RPM as needed.

**CAUTION**

Do not let the engine operate above 2,450 RPM.

**STEERING WHEEL ADJUSTMENT UNLOCK AIR VALVE**

Push on the valve button with the left foot to unlock the steering wheel for tilt and telescopic adjustment.

**WARNING**

Do not adjust the steering wheel while the vehicle is moving. Loss of control could result. Park the vehicle safely and apply parking brake before adjusting the steering wheel.

**ALLISON TRANSMISSION**

The transmission is fully automatic: Proper ranges should be automatically selected according to driving speeds to improve vehicle performance and control. The speed ratio of the power converter changes automatically as vehicle speed increases and direct-drive goes in and out as necessary. The speed ratio is modulated by vehicle speed and accelerator pedal position. You will find the complete transmission operation instructions and driving tips in the **Allison Bus Series Operator's**

**Manual** included in your vehicle's publication box.

**OPERATION**

When a button is depressed on the transmission control pad, the corresponding letter or number is displayed indicating the transmission is ready to operate in the selected range. If the transmission control module (TCM) detects a serious problem in the transmission, the CHECK telltale illuminates on the dashboard.

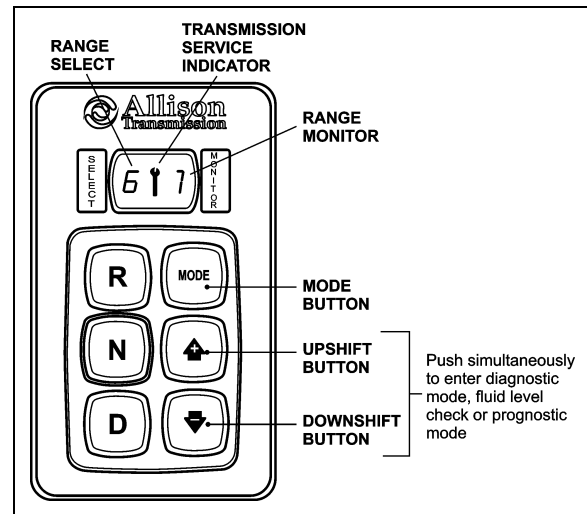

ALLISON PUSHBUTTON SHIFT SELECTOR 07142

**PUSHBUTTON SHIFT SELECTOR**

The pushbutton shift selector has the following elements:

**R** (Reverse) — Press this button to select Reverse.

**N** (Neutral) — Press this button to select Neutral.

**D** (Drive) — Press this button to select Drive. The highest forward range available will appear in the digital display window under SELECT. The transmission will start out in the lowest available forward range, displayed under MONITOR, and advance automatically to the highest range.

**▲ ▼** — Press respectively the **▲** (Upshift) or **▼** (Downshift) arrow button when in DRIVE to request the next higher or lower range. One press changes gears by one range. If the button is held down, the selection will scroll up or down until the button is released or until the highest or lowest possible range is selected. Protection mechanisms inhibit selecting ranges that are not appropriate for the current speed or which may damage driveline components.

## 4-52 CONTROLS AND INSTRUMENTS

**MODE:** Pressing the MODE button allows the driver to activate the secondary shift schedule that has been programmed into the TCM unit.

### PRIMARY AND SECONDARY SHIFT SCHEDULES

The **primary shift schedule** is the default mode at starting of the engine and is typically specified to accommodate normal vehicle operation. The transmission controller automatically selects between ECONOMY and PERFORMANCE shift strategy, based on the vehicle actual load and the grade on which the vehicle is operating. This is called Load Based Shift Scheduling (LBSS). This can produce improved overall vehicle fuel economy while still enabling high productivity when the vehicle is loaded.

In the **secondary shift schedule**, only the ECONOMY shift strategy is available. No switching is done between shift strategies. The secondary shift mode is available only if selected by the driver, using the MODE button. When the secondary mode is activated, "MODE" illuminates on the display.

#### **NOTE**

*When the diagnostic display mode has been entered, the MODE button is used to view and toggle through diagnostic code information. Refer to appendix C for more details about **diagnostic code display procedure** and **fluid level check** using the pushbutton shift selector.*

### TRANSMISSION SERVICE INDICATOR

 — This indicator will illuminate upon the detection of a service issue relating to clutch, filter or fluid life. The appearance of the indicator (lit steadily, flashing, etc.) varies for each of the conditions monitored by the system. Refer to appendix C for more details about **diagnostic code display procedure, fluid level check or prognostic features** (Oil Life Monitor, Filter Life Monitor and Transmission Health Monitor) using the pushbutton shift selector.

Illuminated at startup for a bulb check, this indicator will then turn off if no service conditions exist.

### DESCRIPTION OF AVAILABLE RANGES

#### **R (Reverse)**

Press the «R» button to select reverse. Completely stop the vehicle and let the engine return to idle before shifting from forward range «D» to reverse «R» or from reverse to forward range. The reverse warning signal will be activated when this range is selected.

#### **N (Neutral)**

Use this position to start engine. Select «N» (Neutral) when checking vehicle accessories and for extended periods of engine idle operation; parking brake must then be applied. The pushbutton shift selector will automatically select «N» (Neutral) when the ignition switch is turned ON.

#### **NOTE**

*The automatic transmission does not have a park «P» position. Select «N» (Neutral) and apply parking brake when the vehicle is left unattended. An audible alert will sound if the engine is stopped and the parking brake is not applied.*



#### **WARNING**

Before leaving driver's seat, always put the transmission in NEUTRAL and apply parking brake.



#### **WARNING**

The vehicle service brakes or park brake must be applied whenever NEUTRAL is selected to prevent unexpected vehicle movement.



#### **WARNING**

Always apply parking brake before leaving driver's seat.



#### **CAUTION**

Detroit Diesel engines should not be idled for extended periods at "slow" idle. For extended idling, engine should run at "fast" idle.

 <b>CAUTION</b>
<p>Do not allow your vehicle to "coast" in neutral «N». This practice can result in transmission damage. Also, no engine braking is available in neutral.</p>

**D (Drive)**

Use this position for all normal driving conditions. After touching this pad, the vehicle will start in first or second range and will automatically upshift to a higher range as output speed increases. As the vehicle slows down, output speed decreases, the transmission automatically downshifts to the correct range. If a locked brake or a slick surface condition should occur, the TCM (Transmission Control Module) will command converter operation (disconnect lockup) and inhibit downshifts for a period of time or until normal wheel speed has been restored.

<b><i>IMPORTANT NOTE</i></b>
<p><i>Brake pedal must be applied when selecting «D» (Drive) otherwise the transmission will stay in «N» (Neutral).</i></p>

<b><i>NOTE</i></b>
<p><i>The transmission should normally be allowed to shift by itself, but manual shifting can be done as described below.</i></p>

**1 (First range)**

Select this range when pulling through mud and snow, when speed control is needed for driving up or down steep grades or when maneuvering in tight spaces. This range also provides maximum driving torque and engine braking power or retarder braking effect. In the lower ranges (1, 2, 3 and 4), the transmission will not upshift above the highest gear selected unless engine overspeed is detected.

**2 (Second range)**

Select this range when operating in heavy and congested traffic. The transmission will start in first and automatically upshift to second. When slowing, the transmission will automatically downshift to first range. Low ranges provide progressively greater engine and retarder

braking power (the lower the range, the greater the engine and retarder braking effect).

**3, 4 (Third and fourth ranges)**

Select these ranges when driving on moderate grades or when load and traffic conditions limit speed.

 <b>WARNING</b>
<p>Service brake should not be used to control the speed of vehicle on long, steep descents. Instead, lower transmission ranges should be used (in conjunction with output retarder. Refer to "JACOBS Engine Brake" and "Transmission Retarder" headings in "OTHER FEATURES" chapter for details regarding both systems. This procedure keeps service brake cool and ready for emergency stopping.</p>

 <b>CAUTION</b>
<p>When descending in lower ranges, care must be taken that engine speed does not exceed 2,450 rpm.</p>



**SECTION 5 OTHER FEATURE**

**EXHAUST AFTERTREATMENT SYSTEM.....2**

    FILTRATION AND REGENERATION UNIT .....2

    SELECTIVE CATALYTIC REDUCTION UNIT .....4

**DRIVER INFORMATION DISPLAY (DID) MENUS.....9**

**TRANSMISSION RETARDER .....20**

**ENGINE BRAKE .....20**

    EXHAUST BRAKE.....20

    VOLVO ENGINE BRAKE (VEB).....21

**ANTILOCK BRAKING SYSTEM , TRACTION CONTROL SYSTEM & ELECTRONIC STABILITY CONTROL .....21**

    ANTILOCK BRAKING SYSTEM (ABS).....21

    TRACTION CONTROL SYSTEM (TCS).....21

    ELECTRONIC STABILITY CONTROL (ESC).....21

**RETRACTABLE AUXILIARY AXLE.....22**

**KEYLESS ENTRY SYSTEM.....22**

    KEYLESS OPERATING INSTRUCTIONS .....23

    PROGRAMMING AND MANAGING PERSONAL CODES .....23

    REMOTE ENTRY TRANSMITTER.....24

    PROGRAMMING TRANSMITTERS .....25

**SLIDE-OUT OPERATION.....25**

    SAFETY PRECAUTIONS .....25

    FRONT AND REAR SLIDE-OUT OPERATION .....25

    SLIDE-OUT MANUAL OVERRIDE PROCEDURE.....26

    SLIDE-OUT TROUBLESHOOTING .....29

    TROUBLESHOOTING – OPERATING CONDITIONS, CONTROL & MECHANICAL COMPONENTS ...30

## 5-2 OTHER FEATURES

---

### EXHAUST AFTERTREATMENT SYSTEM

The exhaust aftertreatment system consists of two units, the filtration and regeneration unit and the selective catalytic reduction SCR unit.

#### FILTRATION AND REGENERATION UNIT

The main purpose of the filtration and regeneration unit is to capture and oxidize (regenerate) the particulate matter (soot) in the engine exhaust gas. The exhaust gas first enters the Diesel Oxidation Catalyst (DOC) and then flow through the Diesel Particulate Filter (DPF); together they capture and regenerate the soot on a regular or passive basis. Through constant monitoring of the exhaust gas temperature and the system back pressure, the engine control module is able to manage regeneration.

#### Passive regeneration

Passive regeneration is the process by which the particulate matter is oxidized due to the heat generated by the engine internal combustion process. During normal highway operation, exhaust temperatures alone are usually high enough to oxidize accumulating soot. In low ambient temperatures, however, or in some stop-and-go applications, the system needs a little help to regenerate, or clean itself. This process is called "active" regeneration.

#### Active regeneration







Active regeneration is necessary when the engine internal combustion process alone does not generate enough heat. A dosing system injects a mist of diesel fuel into the exhaust system to increase and maintain the aftertreatment system temperature. Exhaust temperature must be above 572°F (300°C) to initiate the oxidation catalyst, which in turn oxidizes the injected diesel fuel molecules to achieve up to 1200°F (650°C) exhaust temperature at the particulate filter. This process of active regeneration takes place during the normal operation cycle of the vehicle without charges in performance or control for the operator. EPA2010 compliant Volvo engines produce less soot, so less active or stationary regeneration will be required.

#### Stationary (parked) regeneration

In a small number of specific engine duty cycles, engine control module may not be capable of completing an active regeneration. In these situations, the operator will be notified that a stationary or parked regeneration may be required. A DPF telltale light will illuminate indicating the need for user interaction. The lamp gives the operator a grace period to allow this process to take place at a time when most convenient for the operator. This process requires the vehicle to be parked while a driver or maintenance technician initiates the regeneration process using the DID menus. Once initiated, the stationary regeneration process will be complete in about 45 minutes.

The driver will be notified of the need for a stationary regeneration (parked) by illumination of the DPF REGENERATION telltale light.

Diesel particulate filter clogging sequence – Instrument cluster telltale light

<p><b>LEVEL 1</b></p>	 solid	<p><b>REGENERATION NEEDED</b></p> <p>Diesel particulate filter is becoming full</p> <p>The DPF REGENERATION telltale light illuminates to notify the driver that a stationary regeneration (parked) will be required soon. When this lamp is lit, initiate stationary regeneration process at an appropriate time of day. <b>THERE IS NO URGENCY AT THIS LEVEL.</b></p>
<p><b>LEVEL 2</b></p>	 flashing	<p><b>REGENERATION REQUIRED</b></p> <p>Diesel particulate filter full</p> <p>If no DPF regeneration occurs after the initial DPF REGENERATION telltale light illumination, the lamp will begin blinking and a stationary regeneration should be initiated as soon as possible in order to prevent from entering into Level 3.</p>
<p><b>LEVEL 3</b></p>	 flashing + 	<p><b>ATD SERVICE REQUIRED</b></p> <p><b>ENGINE DERATE ACTIVE</b></p> <p>Diesel particulate filter overfull</p> <p>If the flashing DPF REGENERATION telltale light is still ignored, the CHECK telltale light will illuminate. In that situation, engine performance is limited. Perform a parked regeneration IMMEDIATELY to avoid further derate and prevent from entering into Level 4.</p>
<p><b>LEVEL 4</b></p>	 flashing +  + 	<p><b>ATD SERVICE REQUIRED</b></p> <p><b>ENGINE SHUTDOWN ACTIVE</b></p> <p>A serious engine problem has occurred. The DPF may be over its maximum capacity.</p> <p>If a stationary regeneration is still not initiated, a standard Engine Protection Shutdown sequence will occur. All of the following dashboard lamps will be present:</p> <p>Blinking DPF REGENERATION telltale light; Solid CHECK telltale light; Solid STOP telltale light.</p> <p>Once engine derate and/or shutdown sequence is completed, a stationary regeneration must occur to continue vehicle operation. If the driver continues to operate the vehicle without regeneration, additional measures will be taken to protect the engine and ATD from damage, up to and including engine shutdown. Parked regeneration might no longer be possible.</p> <p><b>If engine protection has been initiated and forces the engine to shutdown, you CAN immediately re-start the engine and perform the necessary steps in order to initiate a stationary regeneration.</b></p>

## 5-4 OTHER FEATURES

### Initiating a Stationary (Parked) Regeneration

#### NOTE

At starting of the engine, if a stationary regeneration is required, the engine coolant temperature must reach 140°F (60°C) before any stationary regeneration may be initiated and completed. Permit the engine to idle for a short while or drive the vehicle until engine temperature increases sufficiently.



#### WARNING

Do not initiate a stationary regeneration in a closed area like a garage. Stationary regenerations must be undertaken outdoors only.



#### WARNING

During stationary regeneration, exhaust temperature may reach up to 1200°F (650°C) at the particulate filter. Before initiating stationary regeneration, make sure that the DPF outlet diffuser is clear of objects and that no one is working near the DPF outlet diffuser.



#### WARNING

Hot surfaces. Keep yourself clear of all hot Aftertreatment Device components, particularly during and after active or stationary regeneration. Hot surfaces can cause serious burns.

#### NOTE

#### STATIONARY REGENERATION

This process requires the vehicle to be parked while the driver or a maintenance technician initiates the regeneration process.

The DPF REGENERATION telltale light illuminates to notify the driver of the need and urgency of a manual stationary regeneration.



DPF REGENERATION telltale light

If stationary regeneration is not performed, this telltale light will blink, indicating that a stationary regeneration is required immediately. If stationary regeneration is still not performed,

“engine power derate and shutdown” sequence may occur as per level 1 to level 4 sequence.

To initiate a stationary regeneration:

- Park the vehicle in a clear area, vehicle speed must be 0 mph (0 km/h);
- Engine must be on normal idle and fully warmed up (coolant temperature above 140°F/60°C);
- Apply service brakes and set the transmission to the neutral (N) position.
- Press the DID ENTER button and then get to the DID Aftertreatment menu. Select sub-menu Request Parked REGEN and press ENTER button to confirm and initiate regeneration.

The regeneration will begin. Turn off the air conditioning to reduce engine load. The engine idling speed will increase to 1600 rpm. Once the regeneration is completed, the engine speed will return to normal idle.

### Voluntary Interruption of a Stationary Regeneration

It is possible to interrupt a stationary regeneration at all time. To do so, set the ignition key to the OFF position or get to the DID's Aftertreatment menu, select Cancel REGEN and press ENTER button to confirm. You can stop regeneration simply by releasing the parking brake. Use this procedure in order to move the vehicle in a safe area.

If regeneration is interrupted, it is very important to reinitiate the regeneration as soon as possible.

### SELECTIVE CATALYTIC REDUCTION UNIT

Selective Catalytic Reduction (SCR) is a technology that uses Diesel Exhaust Fluid (DEF) and a catalytic converter to reduce nitrogen oxides (NOx) emissions.

SCR is an exhaust aftertreatment system that injects small amount of DEF into the exhaust gas between the DPF and the selective reduction catalytic converter. DEF turns to ammonia and carbon dioxide when heated. The exhaust stream then passes over a catalyst, the ammonia reacts with the NOx to form nitrogen and water vapor.

The basic elements of the SCR system consist of a 15.9 gallons (60 liters) DEF tank complete with pump, lines and heating system, a dosing



injector, a catalytic converter and the control and monitoring system.

### Diesel exhaust fluid DEF

When handling DEF solution, it is important that electrical connectors to be connected or well encapsulated, otherwise there is a risk that the DEF will cause oxidation that cannot be removed. Water or compressed air will not help, since DEF quickly oxidizes certain metals. If a disconnected connector comes into contact with the DEF solution, it must be replaced immediately to prevent the DEF solution from creeping further into the copper wiring, which takes place at a speed of about 2.4 in (60 mm) per hour.



### CAUTION

Diesel Exhaust Fluid (DEF) is a nontoxic aqueous solution of urea (32.5%) and ultra-pure water (67.5%). Urea is a compound of nitrogen that turns to ammonia when heated. The fluid is non flammable, and is not dangerous when handled as recommended. However, it is highly corrosive to certain metals, especially copper and brass.

When detaching hoses and components, do not spill DEF on disconnected or unsealed connectors. If DEF is spilled on a disconnected or unsealed connector, the connector must be removed immediately and replaced.

Things to know about spilt diesel exhaust fluid (DEF):

- If urea solution comes into contact with the skin, rinse with plenty of water and remove contaminated clothing.
- If urea solution comes into contact with the eyes rinse for several minutes and call for medical help if necessary.
- If inhaled breathe fresh air and call for medical help if necessary.
- Do not allow the DEF solution to come into contact with other chemicals.
- The DEF solution is not flammable. If the DEF solution is exposed to high temperatures, it breaks down into ammonia and carbon dioxide.

- The DEF solution is highly corrosive to certain metals, including copper and aluminum.
- If the DEF solution is spilled onto the vehicle, wipe off the excess and rinse with water. Spilled DEF solution can form concentrated white crystals on the vehicle. Rinse off these crystals with water.



### WARNING

DEF spilt onto hot components will quickly vaporize. Turn your face away!

### Diesel Exhaust Fluid (DEF) Consumption









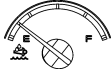

DEF consumption is related to fuel consumption. In order to meet EPA2010 requirements, DEF tanks are sized so one refill will be necessary every two refill of the fuel tank.





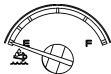

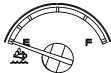

### Selective catalytic reduction – Driver warning and inducement

SCR system components must not be removed, altered or modified in any way. In order to protect the SCR system from tampering, inducement measures will occur if the following states are detected:









- Disconnection of DEF tank level sensor
- Blocked DEF line or dosing valve
- Disconnection of DEF dosing valve
- Disconnection of DEF pump
- Disconnection of SCR wiring harness
- Disconnection of NOx sensor
- Disconnected DEF temperature sensor
- Disconnected DEF quality sensor

## 5-6 OTHER FEATURES

Conditions / Triggers		DEF Tank LOW LEVEL Indicator, DID Message and audible warning		Inducement
1	<b>Normal</b> DEF tank level sensor reads between 100% and 12%	None		None
2	<b>Low DEF tank warning</b> DEF tank level sensor reads between 12% and 0.1% 	 solid	DEF TANK LEVEL LOW REFILL DEF SOON TO PREVENT ENGINE DERATE  3 beeps	Warning message
3	<b>DEF tank near empty</b> DEF tank level sensor reads less than 0.1% 	 blinking	DEF TANK EMPTY REFILL DEF TO AVOID 5 MPH LIMIT ENGINE IN DERATE  3 beeps	Engine torque reduction of 25%
4	<b>DEF tank empty</b> and one (1) hour of operation in engine derate mode 	 blinking	DEF TANK EMPTY REFILL DEF TO AVOID 5 MPH LIMIT ENGINE IN DERATE  3 beeps	Engine torque reduction of 40%
5	<b>DEF tank empty</b> and either  <ol style="list-style-type: none"> <li>Diesel fuel refueling done with a fuel level sensor reading increase of 15%, or more</li> <li>Vehicle stationary (speed=0) for 20 minutes with engine off or at idle</li> </ol>	 blinking	REFILL DEF TANK VEHICLE SPEED LIMITED TO 5 MPH (8 KM/H)  constant tone	Vehicle road speed limited (RSL) to 5 mph (8 km/h)  <i>Note: The vehicle has to be stationary before 5 mph (8 km/h) road speed limit becomes active</i>

Conditions / Triggers		Amber Warning Light & Did Message And Audible Warning		Inducement
1	<b>Good DEF quality</b>	None		None
2	<b>Poor DEF quality detected</b>		POOR DEF QUALITY DETECTED	Warning message
3	<b>Poor DEF quality detected</b>	 solid	POOR DEF QUALITY DETECTED ENGINE WILL DERATE IN < XXX MINS  3 beeps	Warning message
4	<b>Poor DEF quality detected</b> and one (1) hour of operation with active diagnostic troubleshooting code	 solid	POOR DEF QUALITY DETECTED ENGINE IN DERATE 5 MPH (8KM/H) LIMIT IN < XXX MINS  3 beeps	Engine torque reduction of 25%
5	<b>Poor DEF quality detected</b> and four (4) hours of operation with active diagnostic troubleshooting code	 solid	SERVICE DEF 5 MPH (8KM/H) LIMIT NEXT VEHICLE STOP  3 beeps	Engine torque reduction of 40%
6	Diesel fuel refueling done with a fuel level sensor increase of 15% or more and Vehicle stationary (speed=0) for 20 minutes with engine off or at idle	 solid	SERVICE DEF VEHICLE SPEED LIMITED TO 5 MPH (8 KM/H)  constant tone	Vehicle road speed limited (RSL) to 5 mph (8 km/h)  <i>Note: The vehicle has to be stationary before 5 mph (8 km/h) road speed limit becomes active</i>

## 5-8 OTHER FEATURES

Conditions / Triggers		Amber Warning Light, Did Message And Audible Warning		Inducement
1	<b>Normal</b> No diagnostic troubleshooting code active	None		None
2	<b>SCR system tampering</b> diagnostic troubleshooting code confirmed	 solid	SCR SYSTEM FAULT ENGINE WILL DERATE IN < XXX MINS  constant tone	Warning message
3	Reached one (1) hour of operation with active <b>SCR system tampering</b> diagnostic troubleshooting code confirmed	 solid	SCR SYSTEM FAULT ENGINE IN DERATE 5 MPH (8KM/H) LIMIT IN < XXX MINS  constant tone	Engine torque reduction of 25%
4	Reached four (4) hours of operation with active <b>SCR system tampering</b> diagnostic troubleshooting code confirmed	 solid	SCR SYSTEM FAULT REPAIR NEEDED 5 MPH (8KM/H) LIMIT NEXT VEHICLE STOP  constant tone	Engine torque reduction of 40%
5	Diesel fuel refueling done with a fuel level sensor increase of 15% or more	 solid	SCR SYSTEM FAULT VEHICLE SPEED LIMITED TO 5 MPH (8 KM/H)  constant tone	Vehicle road speed limited (RSL) to 5 mph (8 km/h)

**DRIVER INFORMATION DISPLAY (DID) MENUS**

There are Driving and Non-Driving menus. Several sub-menus are password-protected while the vehicle is parked. The Non-Driving menu is accessible only when the vehicle is parked.

<b>DRIVING MODE MENUS</b>	<b>NON-DRIVING/STATIONARY MODE MENUS</b>
<b>Gauges</b> <ol style="list-style-type: none"> <li>1. Current Gear Position (I-Shift)</li> <li>2. Outside Temperature</li> <li>3. Engine Oil Temperature</li> <li>4. Transmission Fluid Temperature</li> <li>5. Prevost Liaison Compass</li> <li>6. Accessories Air Pressure</li> <li>7. A/C Compressor Pressure</li> <li>8. Battery Voltage</li> <li>9. Allison Transmission Oil Life</li> <li>10. Battery State Of Charge</li> </ol>	<b>Display Settings</b> <ol style="list-style-type: none"> <li>1. Language</li> <li>2. Units</li> <li>3. Time/Date</li> <li>4. Favorite Display Setting</li> <li>5. Display Light</li> <li>6. Change Password</li> </ol>
<b>Fuel Data</b> <ol style="list-style-type: none"> <li>1. Fuel Flow / ECO %</li> <li>2. Trip Fuel Used</li> <li>3. Distance to Empty</li> </ol>	<b>Diagnostics</b> <ol style="list-style-type: none"> <li>1. View Active Faults</li> <li>2. View Inactive Faults</li> <li>3. Cluster Self Test</li> <li>4. Part Number</li> <li>5. Reset Inactive Faults</li> <li>6. Vehicle Tests</li> </ol>
<b>Time-Distance</b> <ol style="list-style-type: none"> <li>1. Time and Date</li> <li>2. Alarm Clock</li> <li>3. Trip Odometer 1 and 2</li> <li>4. Average Trip Speed</li> <li>5. Estimated Time of Arrival (ETA)</li> </ol>	<b>Pre-Trip Assistance</b> <ol style="list-style-type: none"> <li>1. Exterior Light Inspection</li> <li>2. Air Leakage Monitor</li> </ol>
<b>Prevost Liaison</b> <ol style="list-style-type: none"> <li>1. Read Message</li> <li>2. Send Message</li> <li>3. Other Info</li> </ol>	<b>Datalog</b> <ol style="list-style-type: none"> <li>1. Vehicle ID</li> <li>2. Total Data</li> <li>3. Trip Data</li> <li>4. Reset Trip Data</li> </ol>
<b>Vehicle Messages</b>	<b>Aftertreatment</b> <ol style="list-style-type: none"> <li>1. Request Parked REGEN</li> <li>2. ATS Status</li> <li>3. Cancel REGEN</li> </ol>
<b>Reset Trip Data</b>	<b>Password</b> <ol style="list-style-type: none"> <li>1. Enter Password</li> </ol>

## 5-10 OTHER FEATURES

---

### « GAUGES » MENU

---

There are several gauges in this menu. The gauges are used to view current status of important functions in the vehicle.

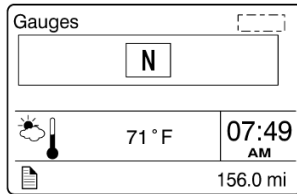

#### 1. Current Gear Position (I-Shift transmission)

Indicates the current gear position selected on the I-Shift transmission.

D= drive

N= neutral

R= reverse

M= manual

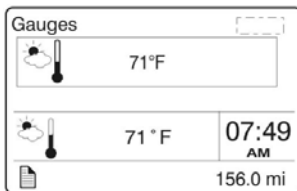

#### 2. Outside Temperature

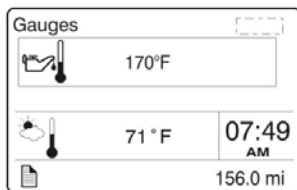

#### 3. Engine Oil Temperature

Selecting this gauge will display the engine oil temperature.

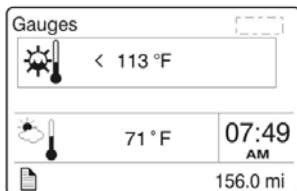

#### 4. Transmission Fluid Temperature

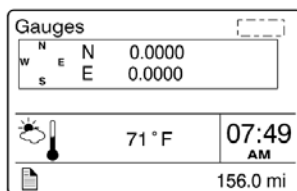

#### 5. Compass

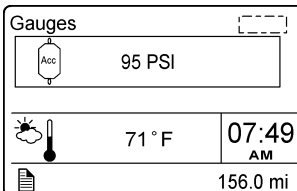

#### 6. Accessories Air Pressure

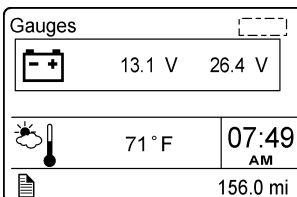

#### 7. Battery Voltage

Displays current 12-volts and 24-volts system voltage.

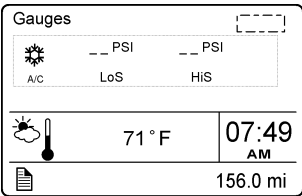

**8. A/C Compressor Pressure**

Displays the A/C compressor suction pressure value (LoS=low side) and discharge pressure value (HiS=high side).

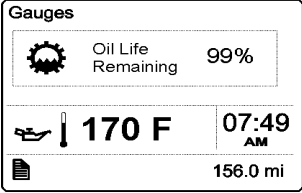

**9. Allison Transmission Oil Life**

Displays the percentage of the calculated remaining life of the transmission oil. New oil is displayed as 99%. Refer to Appendix C for more details.

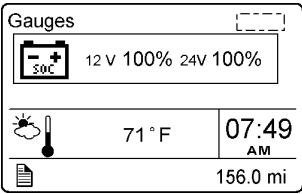

**10. Battery State Of Charge**

Displays the state of charge of the 12-volt and 24-volt battery banks.

**« FUEL DATA » MENU**

The Fuel Data menu provides information on the fuel consumption of the vehicle in various situations. For example, how much fuel has been used, how much fuel is remaining before refueling the vehicle.

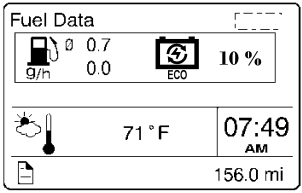

**1. Fuel Flow (gph)**

The lower numerical value indicates the instantaneous fuel consumption. In this menu, you can reset the upper numerical value which is the average fuel consumption. To reset, hold ENTER button for 1 second.

The percentage of trip made on regenerated electricity is also displayed on the right.

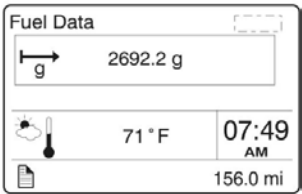

**2. Trip Fuel Used**

Indicates the total fuel consumption since the last reset. Note: Use Reset function before each new trip.

You can reset the fuel consumption value in this menu. To reset, hold ENTER button for 1 second.

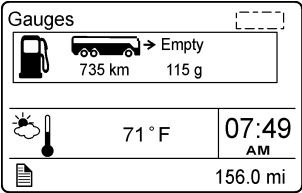

**3. Distance to Empty**

The left numerical value indicates the distance that can be traveled with the quantity of fuel that remains in the tank as indicated by the right numerical value.

**« TIME/DISTANCE » MENU**

The time and date can be set in the Time/Distance menu. The alarm clock can also be set from this menu. Following the alarm clock menu is the Trip Odometer 1 and 2 selection, which allows the operator to see the distance to travel before destination. Average trip speed is also shown. By specifying the distance to your destination, the vehicle can calculate the estimated time of arrival (ETA).

## 5-12 OTHER FEATURES

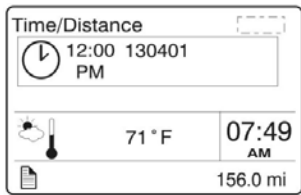

### 1. Time And Date

Adjust time and date with this menu. The instrument cluster has its own internal battery, so the date and date setting is keep in memory even if the vehicle's battery is disconnected.

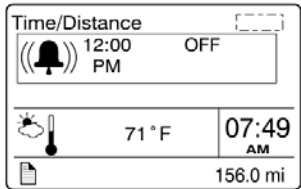

### 2. Alarm Clock

Use this function to program and activate an alarm on the instrument cluster clock. When the alarm clock goes off, a warning signal is sounded. The alarm shuts off after 60 seconds or if the ESCAPE button is depressed.

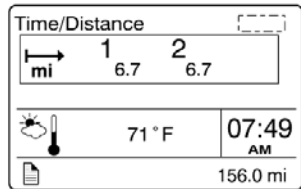

### 3. Trip Odometer 1 and 2

Allows the operator to see the distance travelled since the last reset. You can reset the trip odometer 1 or 2 in this menu. To reset, depress ENTER button, use UP/DOWN button to select between odometer 1 or 2 and then hold ENTER button for 1 second.

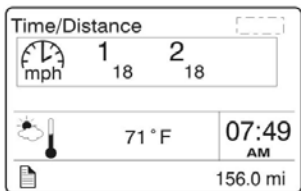

### 4. Average Trip Speed

This function displays the average speed for the current travel. The average trip speed is calculated as the distance traveled divided by the time the engine has been running (since the last reset). Two average trip speeds can be measured, corresponding to leg 1 and leg 2. Use Reset function before each new travel to start new measurements.

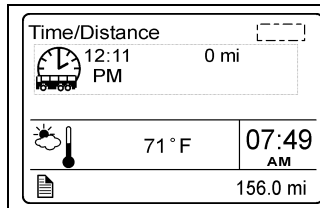

### 5. Estimated Time of Arrival (ETA)

This function will display the estimated time of arrival if the distance to be traveled is entered first, in this menu. To set distance to be traveled, press ENTER and enter the distance left to drive in mile or km using ENTER and UP/DOWN buttons.

## « PREVOST LIAISON (option) » MENU

The Prevost Liaison system provides cellular communication between the driver and the fleet operator. The driver can send and receive short text messages, which are visible through the Driver Information Display.

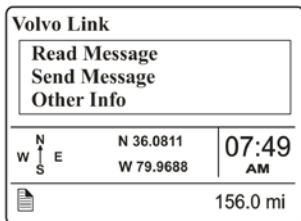

The following menus are available:

### 1. Read Message

- Quick Response (only available if there is a message available)

### 2. Send Message

- Driver & Equipment
- Dispatch Messages
- Free Text

### 3. Other Info

- Comm Liaison Info
- Mailbox Info
- GPS Info
- INI Info
- Configuration Info



« VEHICLE MESSAGES » MENU

Use this function to consult the vehicle active messages that were previously displayed as pop-up messages and then acknowledged. When consulting a message, the corresponding STOP, CHECK or INFORMATION warning light will illuminate. Scroll through the messages using the up/down button. Press ESC button to return to main menu.

« RESET TRIP DATA » MENU

When the Reset Trip Data menu is open, pressing and holding down the Enter button for more than 1 second resets the functions listed below. This function will permit to the system to calculate new value from the point of resetting.

- Fuel Flow
- Trip Fuel Used
- Average Trip Speed

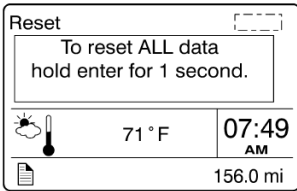

« DISPLAY SETTINGS » MENU

The Display Settings menu is used to change languages and units. The password, time and date can also be changed. The backlight and contrast of the display screen can be adjusted.

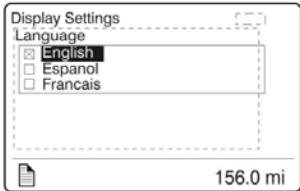

1. Language

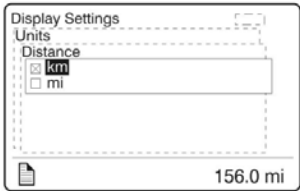

2. Units

- Use this function to select desired unit formats for:
- Distance (miles or km);
  - Fuel consumption (km/l, l/100km, mpg US or IMP);
  - Temperature (°C or °F).

## 5-14 OTHER FEATURES

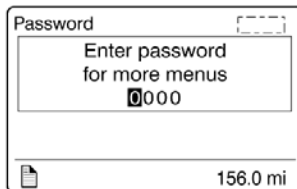
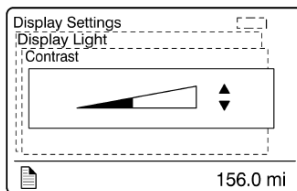
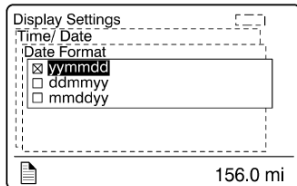
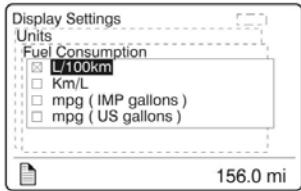

### 3. Time/Date

Select the time and date format (am, pm, 24h) using this function.

### 4. Favorite Display Setting

Use this menu to select your favorite display gauges 1, 2 and 3 and replace the default gauges. On vehicles provided with the I-Shift transmission, Favorite Display Gauge 3 cannot be edited as it is kept for display of the transmission status.

Example: You wish to display the engine oil temperature at the Gauge 1 position.

1. Use UP/DOWN button until Gauge 1 position is selected.
2. Press ENTER button to confirm.

Use UP/DOWN button to scroll through the available gauges. When the engine oil temperature gauge is displayed, press ENTER button to confirm (repeat steps 1-3 to change Gauge 2 and Gauge 3 if needed).

### 5. Display Light

The Display Light menu has three sub-menus:

- Contrast

Adjust the contrast with the UP/DOWN button and press ENTER button to confirm.

- Backlight

In this menu, the display lighting can be adjusted relative to other instrument lighting with the UP/DOWN button.

- Night/Day

Use the Night/Day menu to choose a dark background with light text and images or a light background with dark text and images. Press ENTER button to toggle between Night and Day.

### 6. Change Password

Use this menu to change the current password. This menu is only accessible if the correct password is entered. The default password is 0000.

1. Mark which password is to be changed with the display UP/DOWN button.
2. Confirm with ENTER button.
3. Set the first digit with the UP/DOWN button.
4. Step to the next digit using ENTER button.
5. Step backwards with ESC button.

The Diagnostics menu enables fault tracing on the control units in the vehicle to check for faults. Instrument tests are available to check the telltales, gauges, display and speaker. The part number of a control unit can be identified in the part number menu.

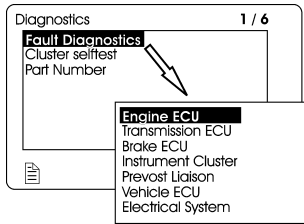

**1. View Active Fault**

A list of the control units on the vehicle is displayed. Use this function to check for active faults on specific control units.

**2. View Inactive Fault**

Use this function to check for inactive faults on specific control units.

**3. Cluster Selftest**

Use this menu to check proper functioning of the following components:

- Telltale lights
- Analog gauges
- Display
- Speakers

The following table describes the available tests. To cancel a test, press the ESC button).

Telltale lights test	Telltale lights illuminate for approximately five seconds. Press the Esc button to cancel the test.
Analog gauges	The indicators move forwards and backwards between the end positions. They do not show any particular value. This is just a check to confirm that the indicators move, and to make sure the operators are working. Press the Esc button to cancel the test.
Display test	The entire display lights up until the Esc button is pressed.
Speaker Test	A sound is emitted through the speakers. Press the Esc button to cancel the test.

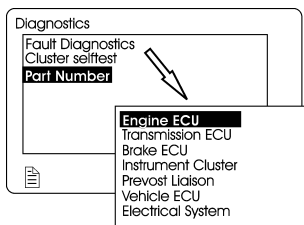

**4. Part Number**

A list of the control units on the vehicle with their part numbers is displayed in the Part Number menu.

**5. Reset Inactive Faults**

Use this menu to delete an inactive fault for a particular control unit. Note: it is not possible to delete inactive faults of the Engine ECU.

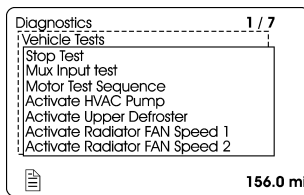

**6. Vehicle Test**

Use this menu to perform tests on several components and systems:

- dashboard switches (Mux Input Test)
- electric motors, valve and pump contactors (Motor Test Sequence)

In case of overheating of the engine due to a malfunction of the radiator fan clutch control, you can force activation of the fan clutch using ACTIVATE RADIATOR FAN SPEED 1, SPEED 2.

The DID status line will show TEST to confirm that one of the test modes is

## 5-16 OTHER FEATURES

---

active. To cancel an active test, turn the ignition switch to the OFF position or press ESCAPE button, select STOP TEST submenu and then press ENTER button twice. "TEST" will disappear from the DID status line.

For further information concerning these functions, refer to section 06: Electrical, under "Troubleshooting And Testing The Multiplex Vehicles" paragraph of the Maintenance Manual.

### « PRE-TRIP ASSISTANT (option) » MENU

---

The Pre-Trip Assistance option is a tool to assist the driver in completing the pre-trip inspection of the vehicle. This option is not a substitute for a complete pre-trip inspection. If any system of the vehicle does not pass inspection, the error must be corrected before operating the vehicle. The available pre-trip tests include the Exterior Light Inspection check, and the Air Leakage check.

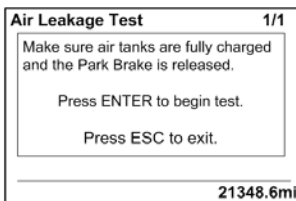
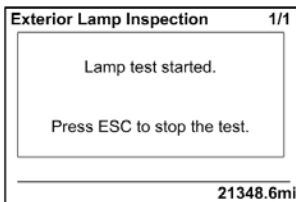
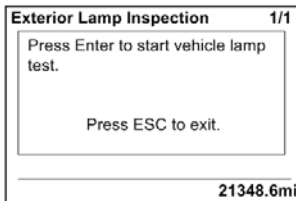
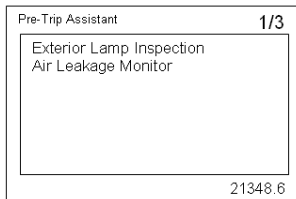

#### 1. Exterior Light Inspection

The Exterior Light Inspection function turns on all the exterior lights simultaneously. This allows the operator to start the test, exit the vehicle and do a visual check that all exterior lights function properly. Press ESCAPE button to end the test and turn off all the exterior lights.

#### 2. Air leakage Monitor

The Air Leakage check allows the driver to accurately measure the amount of air pressure drop in the front and rear brake air systems. After selecting this test from the DID, you are prompted to apply the service brake for 60 seconds. After applying and holding the service brake for 60 seconds, the DID will display the amount of pressure drop in the brake system.

Before starting the test through the DID, complete the following:

- Start the engine and check that the brake systems air pressure is greater than 100 psi.
- Turn engine off.
- Release the brakes and allow the system to settle (air gauge needle stops moving).
- Press the ENTER button to start the test.

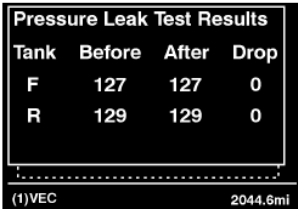
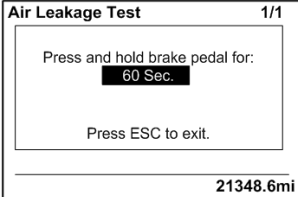
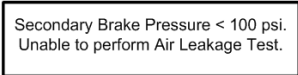
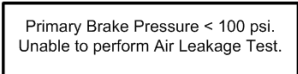

- e. If the air tanks pressure is too low to perform the test (pressure must be greater than 100 psi), the following messages will appear.
- f. You must press and hold brake pedal for 60 seconds, as instructed.
- g. Once the brake pressure test is completed the pressure leak test results are displayed.

**« DATA LOG » MENU**

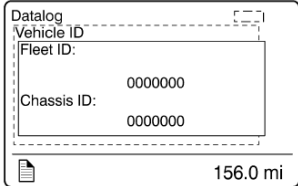

**1. Vehicle ID**

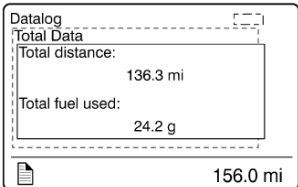

**2. Total Data**

Total Data menu indicates the accumulated engine values that have been logged during the lifetime of the engine ECU.

Available information:

- Total distance traveled
- Total fuel used
- Total engine hours
- Total idle time
- Total PTO hours
- total engine revolutions

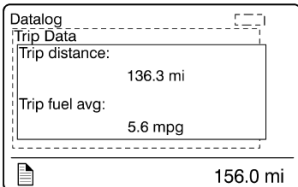

**3. Trip Data**

This menu displays the trip information listed below. This function must be reset before each measurement (before each new trip or leg) using the Reset Trip Data menu.

Available information for the trip or leg is:

- Trip distance (miles or km)
- Trip fuel average (mpg, liter/100km; km/liter)
- Trip fuel used (gallons or liters)
- Trip duration on cruise control (hours)
- Trip duration with engine rpm greater than economy rpm (hours)
- Trip duration while engine rpm is greater than the desire maximum rpm RPM Limit set in Fleet Limits sub-menu (hours)

## 5-18 OTHER FEATURES

- Trip fuel used with engine rpm greater than the economy rpm (gallons/liters)
- Trip average speed (mph, km/h)
- Trip duration with speed greater than the maximum desired speed as set in Fleet Limits sub-menu (hours)
- Trip engine hours
- Trip duration on engine idle (hours)
- Trip fuel used while in engine idle (gallons, liters)

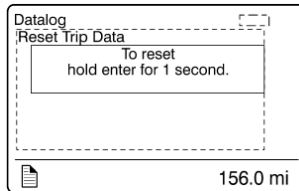

### 4. Reset Trip Data

This menu can only be accessed if the correct password has been entered. Use this function to reset measurements of the Trip Data menu before each new trip or leg.

## « AFTERTREATMENT » MENU

This menu permits to the driver to initiate a stationary regeneration, to check the status of the aftertreatment system and to interrupt regeneration.

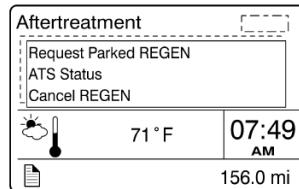

### 1. Request Parked REGEN

Use this function to initiate a stationary (parked) regeneration.

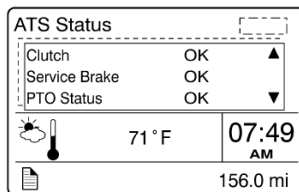

### 2. ATS Status

The Aftertreatment status sub-menus provide information about the conditions required for performing regeneration. The status can be OK (regeneration allowed), CHECK (regeneration not allowed) or N/A (not applicable). When ATS Status is selected, the following sub-menus are available.

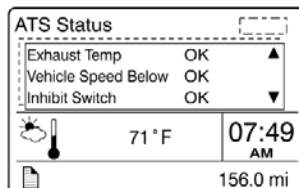
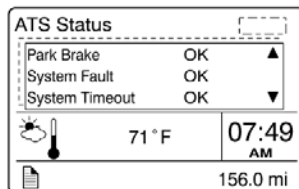
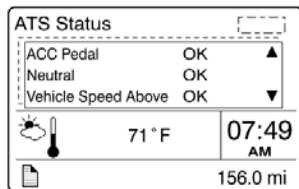

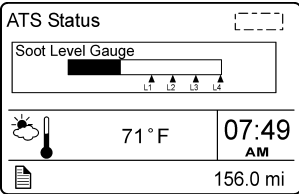
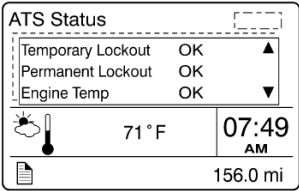

**Soot Level Gauge**

From the ATS Status sub-menu, you can view the soot level for the Aftertreatment system. When the soot level is high, regeneration is necessary. L1, L2, L3 and L4 under the scale correspond to Level 1 up to Level 4 (see Diesel particulate filter clogging sequence – Engine indicator lamp).



**3. Cancel REGEN**

From the Aftertreatment main menu, you can cancel a REGEN cycle.

**« PASSWORD » MENU**

Certain functions are password-protected. These passwords give the user access to all password-protected functions. The default password is 0000.

**1. Password**

The following menus are password-protected and marked with a key symbol in the menus:

- Change Password
- Fleet ID
- Reset Trip Data
- Fault Diagnostics
- Inactive Faults

## 5-20 OTHER FEATURES

### TRANSMISSION RETARDER

The transmission retarder is an optional device that helps to reduce the speed of a vehicle. It improves vehicle control, increases driving safety and permits more economical operation. The retarder provides slowing power when it is most needed, such as when descending mountain roads, in stop-and-go traffic and on crowded freeways.

The transmission retarder is a vehicle-slowng device, not a vehicle-stopping device. It is not a substitute for the service braking system. The service brake must be used to bring the vehicle to a complete stop.

The retarder is provided with control buttons on the steering wheel and a lever on the steering column (refer to *Controls and instruments* chapter).



#### WARNING

Do not use the retarder during inclement weather or slippery road conditions.

#### NOTE

*Extended use will raise the temperature of the transmission fluid.*

The retarder helps reduce speed on grades without using the vehicle's conventional service braking system. This virtually eliminates brake overheating and reduces the risk of a runaway vehicle. A retarder greatly increases the service life of brake pads and discs, resulting in reduced brake maintenance costs.

#### NOTE

*The stoplights automatically illuminate when the vehicle is slowing down after application of the transmission retarder.*

#### NOTE

*For vehicles equipped with the Antilock Braking System (ABS), as the wheels start to lock up on slippery roads, the output retarder automatically deactivates until the wheels roll freely.*

### ENGINE BRAKE



#### WARNING

A vehicle speed retarding device (such as engine brake) is not intended to replace the service brake systems on your vehicle nor intended to bring your vehicle to a stop. A vehicle speed retarding device is only intended to reduce the speed of your vehicle under certain conditions.

Several types of engine brake can be installed or are standard on certain engines. All are used to reduce wear on the vehicle brake linings.



#### WARNING

When descending significant grades, use the service brake as little as possible. If the engine does not slow the vehicle to a safe speed, apply service brake and shift to a lower range. Let the engine (and engine brake) slow the vehicle. Keep brakes cool and ready for emergency stopping.

#### NOTE

*When driving with cruise control, the exhaust brake automatically engages if the selected cruise speed is exceeded by approximately 4 mph (7 km/h). The exhaust brake is then disengaged when the speed has returned close to selected cruise speed, provided that the engine brake was previously enabled.*

### EXHAUST BRAKE

The exhaust brake provides about 66 % of the total available engine braking power. The exhaust brake is most effective at high engine speeds (1500 to 2300 rpm). The exhaust brake is automatically disengaged if the engine speed drops to or below 1100 rpm.

This engine brake mode provides low braking power by containing the exhaust gases in the exhaust manifold, thereby making the engine work against the back pressure. This provides a retarding force on the drive wheels.

The following must be in effect for the exhaust brake function:

- The engine brake switch found on the dashboard is set to the ON position



- The **Retarder/Engine Brake Low** ① button on the steering wheel controls is depressed
- Accelerator pedal is fully released
- Engine speed exceeds 1150 rpm

### VOLVO ENGINE BRAKE (VEB)

VEB has a higher braking effect than the exhaust brake. This engine brake mode is most effective at high engine speeds (1500 to 2300 rpm). It is automatically disengaged if engine speed drops below 1000 rpm.

The VEB is engaged using the **Retarder/Engine Brake High** ② button located on the steering wheel. It works together with the exhaust brake to provide to provide 100 % of the maximum available braking power.

The engine brake control on the steering wheel is achieved by the use of three buttons: OFF, LOW ① and HIGH ②. With the Engine Brake LOW ① button depressed, only the exhaust brake is engaged. With the Engine Brake HIGH ② button, both the exhaust brake and the compression brake are activated.

VEB = Exhaust Brake + Compression Brake

The following must be in effect for the VEB to function:

- The engine brake switch found on the dashboard is set to the ON position
- The **Retarder/Engine Brake Low** ② button on the steering wheel controls is depressed
- The vehicle speed is over 7.5 mph (12 km\h)
- Engine temperature is greater than 110°F (43°C)
- Accelerator pedal is fully released
- Engine speed exceeds 1150 rpm

## ANTILOCK BRAKING SYSTEM , TRACTION CONTROL SYSTEM & ELECTRONIC STABILITY CONTROL

### ANTILOCK BRAKING SYSTEM (ABS)

The purpose of the Antilock Braking System (ABS) is to maintain vehicle stability and control during braking and to minimize the stopping distance in any road condition.

On slippery roads and more generally in emergency situations, over-braking frequently induces wheel locking. Wheel locking greatly increases breaking distance on any road surface. Locked wheels also impede directional control and cause severe tire abrasion. An antilock braking system provides maximum braking performance while maintaining adequate control on slippery roads.

The basis of ABS is constant monitoring of wheel parameters during braking. Sensors on each wheel of the front and drive axles constantly measure wheel speed during braking. This information is transmitted to a four-channel electronic processor which senses when any wheel is about to lock. Modulating valves quickly adjust brake pressure (up to 5 times every second) to prevent wheel lock. Each wheel is therefore controlled according to the available grip.

In this way, the vehicle is brought to a stop in the shortest possible time while remaining stable and under the driver's control.



### WARNING

Vehicles following ABS-equipped vehicles may not be able to brake as fast on slippery roads.

### TRACTION CONTROL SYSTEM (TCS)

TCS controls wheel spin during vehicle acceleration to improve traction.

- The TCS system will intervene automatically and apply braking pressure to a spinning wheel transferring engine power to the other drive wheel that have better traction. This feature is active only at speeds below 25 mph (40 km/h).
- If all of the drive wheels begin to spin, the TCS system will reduce engine throttle to improve traction at all of the drive wheels.

If drive wheels begin to lose traction during acceleration, TCS will engage automatically to assist the driver in accelerating the vehicle. The TCS/ESC lamp will flash rapidly to let you know whenever TCS is actively functioning.

### ELECTRONIC STABILITY CONTROL (ESC)

The ESC stability system is an optional feature for ABS-equipped vehicles that reduces the risk of rollovers and loss of control. The ESC system

## 5-22 OTHER FEATURES

features include the RSP Roll Stability Program and Yaw Control.

The RSP system counteracts the tendency of a vehicle to tip over while changing direction (typically, while turning).

To reduce the risk of rollover, the RSP system detects potential rollover conditions and slows the vehicle both by reducing engine throttle (and hence, engine torque) and by applying service brakes as needed at the appropriate wheels.



### WARNING

During an RSP system intervention, the vehicle **automatically decelerates**. The RSP system can slow the vehicle with or **without you applying the brake pedal, and even when you are applying the throttle**.

During an RSP system intervention, you can always use your service brake pedal to increase the braking pressure that will be applied. However, if you were to apply less braking pressure than needed or even if you release the brake pedal entirely during an intervention, the RSP system will continue to apply the necessary amount of braking pressure automatically to the appropriate wheels to mitigate a potential rollover.

Yaw Control is a feature that reduces the risk of loss of control. If a vehicle's tires start to slide during a turn, Yaw Control counteracts the tendency of that vehicle to spin (or yaw), thereby reducing the risk of loss of control. Many factors, including road conditions, load distribution and driving behavior, can contribute to the development of a spin.



### WARNING

In the case where a vehicle equipped with the ESC system pulls a trailer, the latter must be equipped with ABS.



### CAUTION

Even with ESC-equipped vehicles, the driver remains responsible for ensuring vehicle stability during operation.

### NOTE

*For further details, consult "Bendix ABS Operator's Manual".*

## RETRACTABLE AUXILIARY AXLE

Lifting of the auxiliary axle is controlled by a valve located on the left lateral console. The valve can be switched to either the WHEELS UP or WHEELS DOWN position. The axle will be raised or lowered by air pressure according to the position of the valve switch. Refer to Controls and Instruments chapter.

The auxiliary axle service brakes and parking brakes operate only when the auxiliary axle is in the WHEELS DOWN position. When the auxiliary axle is in the WHEELS UP position, the corresponding pictogram will appear in the DID status line. An audible alarm will sound to warn the driver if the vehicle speed exceeds 12 mph (20 km/h) with auxiliary axle raised. Lifting the auxiliary axle shortens the wheelbase and allows tighter turning. This is very useful in tight maneuvering areas like in a parking lot or when negotiating a tight corner. Raising the auxiliary axle transfers extra weight and additional traction to the drive wheels providing improved control on slippery surface when needed.



### CAUTION

Do not use auxiliary axle in raised position for an extended period. Raising auxiliary axle increases load on the drive axle, suspension and tires.

Do not drive vehicle with auxiliary axle raised when speed is exceeding 12mph (20 km/h).

In order to prevent damage to the suspension, always raise the auxiliary axle before lifting the coach.

## KEYLESS ENTRY SYSTEM

This system, located below the entrance door handle, is used to lock or unlock the entrance door, the baggage compartment and the service compartment. Unlocking the entrance door using the keyless system will also disarm the intrusion protection and the anti-theft system.

At the time of purchase, the new owner will be given a default four (4) digits access code to unlock the vehicle and a permanently programmed six (6) digits authority code that will allow him to program up to 40 alternate four (4) digits personal access codes (see "programming and managing personal codes" instructions below).

Do not push the keyless buttons with a key, pencil or any other hard or sharp object as the

buttons could be damaged. Although each button is provided with two digits separated by a vertical line, there is only one contact per button. Press in the center of the button.

**NOTE**  
*Pressing a system key will illuminate the keyboard, unlocking the entrance door will also illuminate the vehicle step lights. Both illumination will go off after a 30 seconds period of inactivity.*

**KEYLESS OPERATING INSTRUCTIONS**

Entering a valid access code enables secure operation. After entering the access code, the keypad is enabled for 5 seconds and a fifth button press initiate an action.

**NOTE**  
*A double beep after entering an access code indicates a correct code and readiness for an action command*

**To unlock the entrance door and disarm the anti-theft system:**

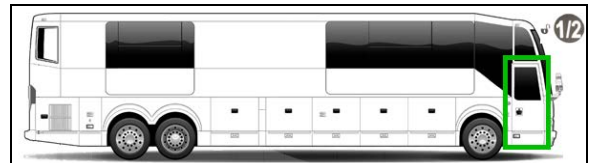

- Enter your personal or the default validation code followed within 5 seconds by the 1/2 key.
- Hold the 1/2 button to unlatch the entrance door and reduce the effort necessary to open it.

**NOTE**  
*If the entrance door is already unlocked, the door will unlatch by holding the 1/2 button without the need to enter an access code.*

**To unlock the baggage and service compartment doors:**

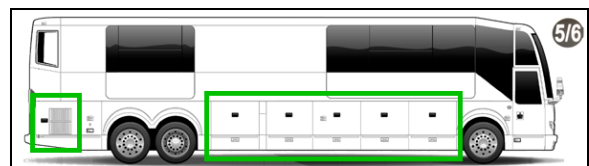

- Enter your personal or the default validation code followed within 5 seconds by the 5/6 key.

**To unlock all doors simultaneously:**

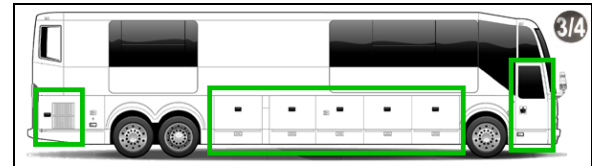

- Enter your personal or the default validation code followed within 5 seconds by the 3/4 key.

**To lock the doors and activate the anti-theft system:**



- Press the 9/0 key for 2 seconds (no validation code required).

**NOTE**  
*The lock function will not function when the ignition is in the ON position or the entry door is open.*

**NOTE**  
*After repeated attempts to enter codes (20 button presses without enabling), the keypad will enter in an inactive mode that disables buttons for 60 seconds. The lock indicator will flash amber and red during this state.*  
*If a partial validation code is entered or no action button is pressed within 5 seconds, the keypad will revert back to disabled condition and the access code will have to be entered again.*

**PROGRAMMING AND MANAGING PERSONAL CODES**

It is possible to program up to 40 four (4) digits personal access codes to unlock the entrance door and compartments. These codes do not replace the default code that is factory supplied with the vehicle.

## 5-24 OTHER FEATURES

When programming codes, do not choose codes that present the numbers in sequential order, studies show that people who idly press the buttons usually press a sequential pattern. Also, do not select a code that uses the same button four times. Thieves can easily figure out these types of codes.

### To add a new personal code:

- Choose and memorize a four (4) digits personal code.
- Press and hold the 5/6 key for five seconds (keypad will start to beep and flash).
- Enter the vehicle factory six (6) digits authority code.
- Press the 1/2 key (a short beep will be heard, validating the action).

#### **NOTE**

*If the 40 codes memory is already full, a long beep will be heard.*

- Enter the chosen personal code (three confirmation beeps will be heard).
- Re-enter the code to confirm the entry (four confirmation beeps will be heard).

Press the 1/2 key and repeat the last two steps to enter additional codes.

### To delete a personal code:

- Press and hold the 5/6 key for five seconds (keypad will start to beep and flash).
- Enter the vehicle factory six (6) digits authority code.
- Press the 3/4 key (a short beep will be heard, validating the action).

#### **NOTE**

*If the 40 codes memory is already empty, a long beep will be heard.*

- Enter the code to be deleted (three confirmation beeps will be heard).
- Re-enter the code to confirm the deletion (four confirmation beeps will be heard).

Repeat the process to delete additional codes.

## REMOTE ENTRY TRANSMITTER

Hand held transmitters (key FOB) can be used to control the keyless door lock system.



### To lock the entrance door and the baggage compartment doors simultaneously and arm the intrusion protection and anti-theft system:

- Press LOCK (top) button on the transmitter once.

#### **NOTE**

*The lock function will not function when the ignition is in the ON position or the entry door is open.*

#### **NOTE**

*The intrusion protection and anti-theft system will be set after a 10 seconds delay.*

### To unlock the entrance door:

- Press UNLOCK DOOR (bottom) button on the transmitter. This will unlock the door and disarm the anti-theft system.
- Hold the button to unlatch the entrance door and reduce the effort necessary to open it.

### To unlock the baggage compartment doors:

- Press UNLOCK BAGGAGE (right) button. This will not disarm the alarm.

### To set off the personal security alarm (Panic mode):

- Press and hold the red (left) PANIC button for two seconds. The horn will sound and the marker lights will flash for 30 seconds.

**To deactivate the personal security alarm:**

- Press any FOB button again or unlock the entrance door using the keypad.

**PROGRAMMING TRANSMITTERS**

Up to 20 transmitters can be used with the keyless entry system. To add or replace transmitters, the system must be first put into learn mode using the vehicle keypad.

To program transmitters perform the following steps:

- Hold the 5/6 button of the keypad for 5 seconds (keypad will start to beep and flash).
- Enter the vehicle factory six (6) digits authority code.
- Hold button 7/8 for 5 seconds, a double beep will play, confirming that the system is now in learn mode.
- Press the lock button on each transmitter to be programmed for 5 seconds with a two seconds pause between each transmitter.
- Press the 9/0 button twice to exit learn mode (the keypad will beep twice and stop flashing).

**NOTE**  
If more than 20 transmitters are programmed, additional transmitters will over-write the first ones.

**SLIDE-OUT OPERATION**

**SAFETY PRECAUTIONS**

Before operating both slide-out units, proceed to the following verifications:

- Make sure that the area outside the slide-out is clear and that there are no persons or objects within 3 feet of the slide-out outside wall. **Serious personal injury or damage to the vehicle components may occur.**
- Make sure that the area inside the motor home where the room retracts (30" for the front and 24" for the rear slide-out) is free of people or obstacles. **Serious personal injury or damage to the vehicle components may occur.**

- In temperatures below freezing point, make sure that the entire sliding surface outside the slide-out is free of snow, ice or sleet. **Failure to clear all ice or snow may seriously damage the inflatable seal.**
- The parking brake must be applied.
- The transmission must be in the "NEUTRAL" position.
- Open a window to avoid slide-out movement restriction.
- Level the vehicle.

**FRONT AND REAR SLIDE-OUT OPERATION**

**Preliminary condition for the slide-out operation**

Before extending or retracting the slide-out, please make sure that all the following conditions are met:

1. Allow enough time for air pressure to build up.
2. Make sure the parking brake is applied and that transmission is in the NEUTRAL position.
3. Turn the ignition key to the ON position, start the engine and set the RPM to fast idle.

 **CAUTION**

Prevost does not recommend operation of the slide-out with the engine being shut off.

Running the engine will assure a sufficient air pressure and reserve, and high voltage for proper operation of the slide-out.

 **CAUTION**

Before extending or retracting the slide-out, always open a window to avoid movement restriction and to prevent the motor from stopping in overcurrent condition because of a vacuum or pressure build up inside the vehicle.

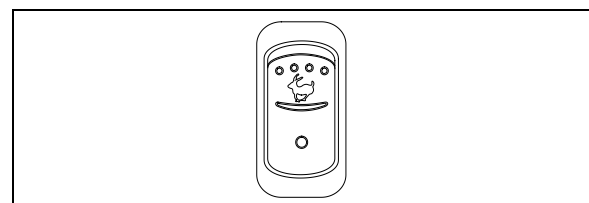

FAST IDLE BUTTON

## 5-26 OTHER FEATURES

### Slide-out extending operation

With the engine running, press and hold down the handheld control rocker switch to the OUT position. The green indicator light ROOM IN OPERATION will come on to indicate that the slide-out operation cycle is activated. The following actions will be done in sequence:

- Deflation of the inflatable seal
- Movement of the slide-out to its full OUT position

Then releasing the rocker switch will permit the following actions:

- Re-inflation of the seal

When the rocker switch is released, the green indicator light goes out. Note that for safety reasons, releasing the rocker switch will stop the slide-out movement instantly. At any time, releasing the rocker switch from the OUT position and pressing it to the IN position will reverse the operation.



### CAUTION

The inflatable seals can be re-inflated only when the slide-out is in its full OUT or full IN position. Do not leave the slide-out in any position other than the full extended or closed position as water infiltration may occur.

### NOTE

*Handheld control green indicator light blinking. A green light blinking indicates an error condition or missing operation condition on the slide-out operated by this handheld control. Refer to SLIDE-OUT TROUBLESHOOTING at the end of this section if that situation occurs.*

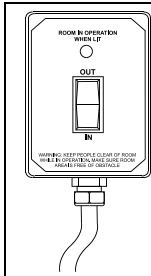

SLIDE-OUT HANDHELD CONTROL

26034

### Slide-out retracting operation

With the engine running, press and hold down the rocker switch to the IN position to retract the slide-out. Note that the green indicator light ROOM IN OPERATION will come on. When the movement of the slide-out to its full IN position is completed, the rocker switch can be released to allow the re-inflation of the seal. The green indicator light goes out as the rocker switch is released. At any time during the slide-out movement, releasing the rocker switch will stop the operation instantly.



### CAUTION

The inflatable seals can be re-inflated only when the slide-out is in its full OUT or full IN position. Do not leave the slide-out in any position other than the full extended or closed position as water infiltration may occur.

### SLIDE-OUT MANUAL OVERRIDE PROCEDURE

In case of power retracting system failure, it is possible to use the manual override procedure to retract or extend the slide-out.

The manual override procedure consist in rotating the slide-out motor shaft extension using a cordless power drill with a 3/8" hexagonal bit.

However, it is very important to follow all the instructions very carefully to assure that the inflatable seal or the retraction mechanisms are not damaged.

### Preliminary conditions for manual override procedure

Before using the slide-out manual override procedure, make sure that the problem cannot be solved by one of the following simple checks:

- Make sure that none of the breakers are tripped (slide-out circuit breakers CB9 & CB11 are located inside the main power compartment on the breaker panel).
- Make sure the parking brake is applied and that transmission is in the NEUTRAL position.
- Make sure the voltage is high enough by running the engine at fast idle or having a battery charger connected.



**CAUTION**

Before extending or retracting the slide-out, always open a window to avoid movement restriction and to prevent the motor from stopping in overcurrent condition because of a vacuum or pressure build up inside the vehicle.

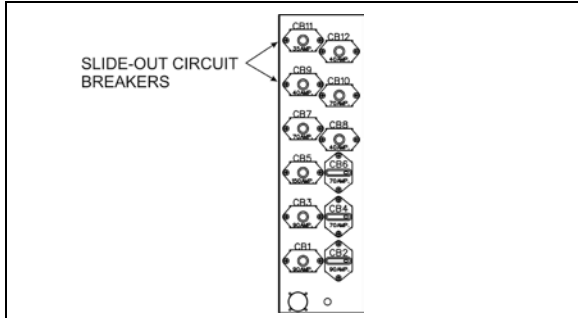

**SLIDE-OUT CIRCUIT BREAKERS CB9 & CB11 IN MAIN POWER COMPARTMENT**

26091

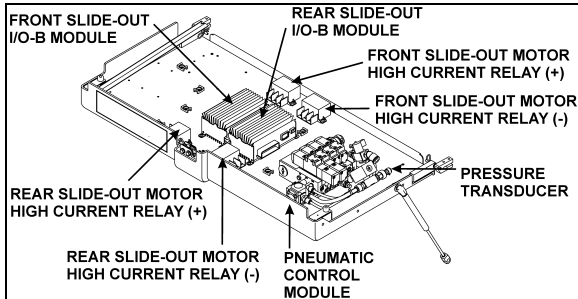

**SLIDE-OUT CONTROL PANEL IN FIRST BAGGAGE COMPARTMENT**

26107

**Manual retracting procedure – Front and rear slide-out**

1. Turn the ignition switch to the OFF position, and remove the ignition key for more safety.
2. Deflate the inflatable seal by using the relieving shut-off valve located on the slide-out control panel. Turn the handle clockwise to deflate the seal. Make sure the pressure indicator reading is "0 psi".



**CAUTION**

The pressure in the inflatable seal must be completely relieved to prevent any damage to the seal. Also, check that the security pin is retracted so it does not stop slide-out movement.

**NOTE**

When air pressure is relieved using the shut-off valve, the normal extending and retracting operation cycle is disabled, for that reason the slide-out cannot be moved using the handheld control.

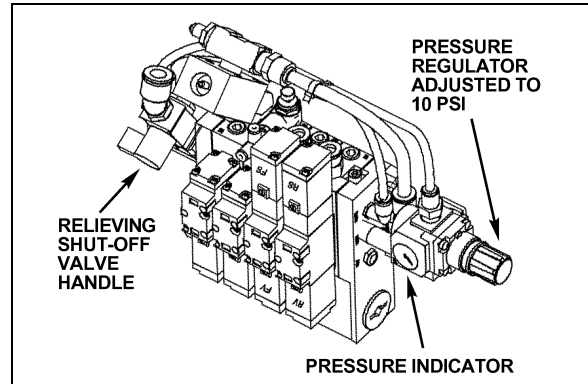

**INFLATABLE SEAL RELIEVING SHUT-OFF VALVE**

26098

3. To move the slide-out, use a cordless power drill with a 3/8" hexagonal bit on the shaft extension of the slide-out motor.
4. Rotate the slide-out motor shaft extension with the cordless power drill until the slide-out comes to its closed position.
5. Once the slide-out room is lined up to its closed position, remove the tool from the motor shaft extension.

**NOTE**

The **front slide-out motor** is located inside the 2<sup>nd</sup> baggage compartment while the **rear slide-out motor** is accessible from inside the vehicle, under the bed structure.

**RETRACTING**

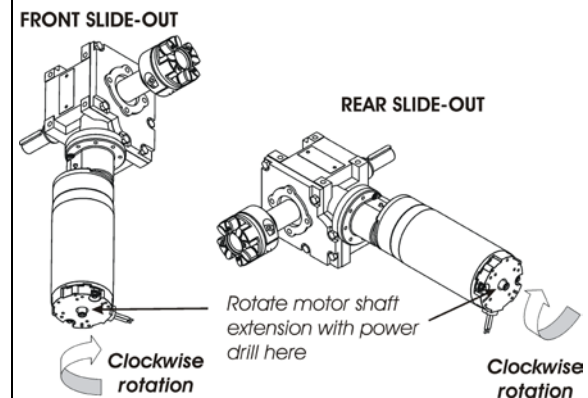

**SLIDE-OUT MOTOR ROTATION**

26038

## 5-28 OTHER FEATURES



### CAUTION

Slow down on the closing speed as the slide-out approaches its closed position. As soon as the "in limit" stoppers come in contact with their bearing surface, stop immediately the cordless power drill rotating movement. Not doing so could overload the drive mechanism and cause damage to the reduction gearbox.

6. Finally, the inflatable seal can be re-inflated by turning the shut-off valve handle counterclockwise. Check the pressure gage on the inflatable seal regulator to see if the pressure is increasing to 10 psi.

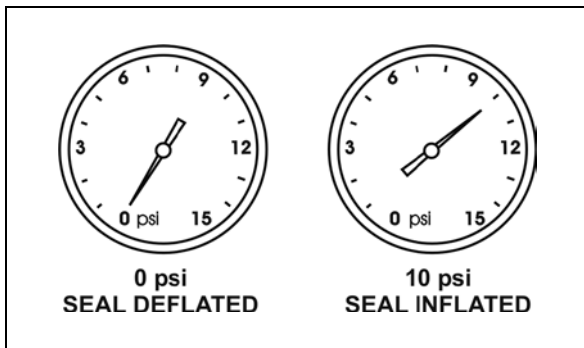

INFLATABLE SEAL PRESSURE GAGE

26108

### NOTE

*The slide-out control system inhibits transmission range selection to prevent the vehicle from moving if the slide-out is not in its full "IN" position.*

### Manual extending procedure – Front and rear slide-out

1. Apply parking brake to disengage the security pin from the receptacle.
2. Turn the ignition switch to the "OFF" position, and remove the ignition key for more safety.
3. Deflate the inflatable seal by using the relieving shut-off valve located in the slide-out control panel. Turn the handle clockwise to deflate the seal. Make sure the pressure indicator reading is "0 psi".



### CAUTION

The pressure in the inflatable seal must be completely relieved to prevent any damage to the seal. Also, check that the security pin is disengaged from the receptacle so it does not stop slide-out movement.

### NOTE

*When air pressure is relieved using the shut-off valve, the normal extending and retracting operation cycle is disabled, for that reason the slide-out cannot be moved with the handheld control.*

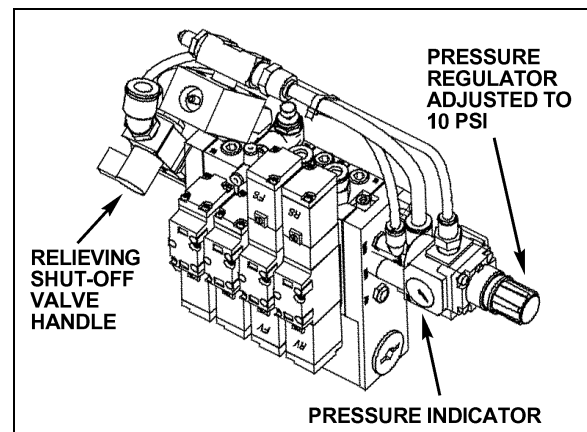

INFLATABLE SEAL RELIEVING SHUT-OFF VALVE  
26098

4. To move the slide-out, use a cordless power drill with a 3/8" hexagonal bit on the shaft extension of the slide-out motor.
5. Rotate the slide-out motor shaft extension with the cordless power drill until the slide-out comes to its opened position.
6. Once the slide-out is lined up to its opened position, remove the tool from the motor shaft extension.



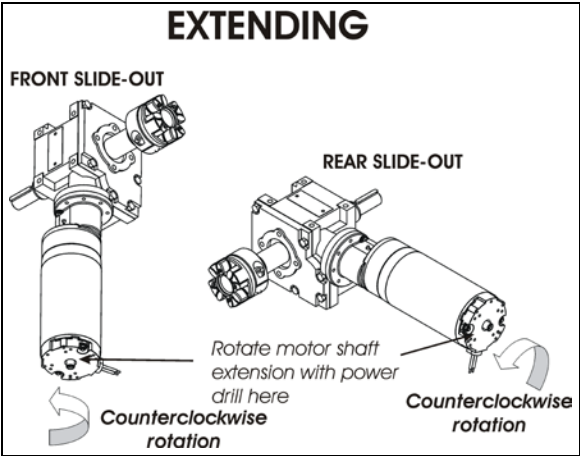

SLIDE-OUT MOTOR ROTATION 26038

**NOTE**  
 The **front slide-out motor** is located inside the 2<sup>nd</sup> baggage compartment while the **rear slide-out motor** is accessible from inside the vehicle, under the bed structure.

**CAUTION**  
 Slow down on the closing speed as the slide-out approaches its extended position. As soon as the "out limit" stoppers come in contact with their bearing surface, stop immediately the cordless power drill rotating movement. Not doing so could overload the drive mechanism and cause damage to the reduction gearbox.

- Finally, the inflatable seal can be re-inflated by turning the shut-off valve handle counterclockwise. Check the pressure gage on the inflatable seal regulator to see if the pressure is increasing to 10 psi.

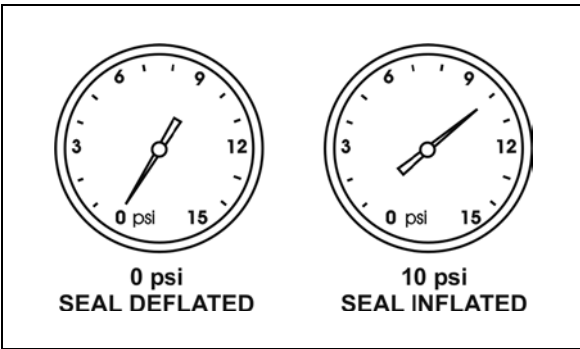

INFLATABLE SEAL PRESSURE GAGE 26108

**NOTE**  
 The slide-out control system inhibits transmission range selection to prevent the vehicle from moving if the slide-out is not in its full "IN" position.

**SLIDE-OUT TROUBLESHOOTING**

**Error condition or missing operation condition**

When an error condition or a missing operation condition is present on a slide-out, the green indicator light on its respective handheld control starts blinking upon releasing of the IN/OUT rocker switch.

Turning the ignition OFF and ON again, will stop the blinking and reset the fault. If the error condition or a missing operation condition is still present, the blinking will start again the next time that the slide-out is operated. So, to get a fault diagnostic, use the MCD right after operating the slide-out without cycling the ignition switch.

**Fault diagnostic**

To get more specific information about the error condition or the missing operation condition, request a diagnostic from the slide-out CECM using the dashboard message center display (MCD). Check if there are active errors in the slide-out electrical system. With the SYSTEM DIAGNOSTIC menu, highlight FAULT DIAGNOSTIC and then highlight ELECTRICAL SYSTEM to request a diagnostic of the electrical system from the CECM. Press the enter key. If applicable, the MCD shows the device ID, the fault messages or fault codes recorded. When more than one fault is recorded, an arrow pointing down appears on the right of the display. Use the down arrow to see all the fault messages.

Once the problem corrected, the MCD still shows the fault as being active. You have to leave the FAULT DIAGNOSTIC menu, wait approximately 20 to 30 seconds and then return to FAULT DIAGNOSTIC to request a new diagnostic of the ELECTRICAL SYSTEM from the CECM. The MCD should display the fault as being inactive.

## 5-30 OTHER FEATURES

### TROUBLESHOOTING – OPERATING CONDITIONS, CONTROL & MECHANICAL COMPONENTS

PROBLEM	CAUSE	CORRECTIVE ACTION
<p>The slide-out functions normally but the handheld control green indicator light blinks</p>	<p>Something is defective and may eventually create an issue if not repaired. The problem may be:</p> <ul style="list-style-type: none"> <li>A. Faulty limit sensor causing the slide-out to stop in overcurrent;</li> <li>B. CAN network problem causing the transmission inhibit safety to be non-operational;</li> <li>C. Vacuum pressure transducer disconnected or damaged (vacuum is applied for a fixed time of 7 seconds);</li> <li>D. Seal inflating valve solenoid open circuit (the seal is not re-inflated and water can penetrate in the vehicle);</li> <li>E. Security pin valve solenoid open circuit (the security pin is not extended while vehicle is riding).</li> </ul>	<p>Request a diagnostic from the electrical system using the MCD SYSTEM DIAGNOSTIC menu.</p>
<p>The slide-out does not extend</p>	<ul style="list-style-type: none"> <li>A. The parking brake is not seen by the controller as being applied;</li> <li>B. Not enough air pressure in the accessory air tank to permit proper operation of the vacuum generator;</li> <li>C. Faulty vacuum generator, connection to the vacuum generator open, seal deflating valve solenoid open circuit;</li> <li>D. I/O-B module output defective, regulated 5-volt supply to sensors shorted to ground, "out limit" sensor shorted to ground, connection to the motor negative relay solenoid open circuit;</li> </ul>	<ul style="list-style-type: none"> <li>A. Make sure the parking brake is applied. Confirm parking brake application with the parking brake light on the telltale panel.</li> <li>B. Run the engine at fast idle a few minutes to increase air pressure in the accessory air tank and try again.</li> <li>C. Turn the relieving shut-off valve handle clockwise to deflate the inflatable seal, disconnect the pressure transducer. Do not forget to reconnect the pressure transducer and to close the relieving shut-off valve. Failure to do so could damage the seal and lead to water infiltration;</li> <li>D. Operate the slide-out with the manual override procedures.</li> </ul>
<p>The slide-out does not retract</p>	<ul style="list-style-type: none"> <li>A. Not enough air pressure in the accessory air tank to permit proper operation of the vacuum generator;</li> <li>B. Faulty vacuum generator, connection to the vacuum generator open, seal deflating valve solenoid open circuit;</li> <li>C. I/O-B module output defective, "in limit" sensor shorted to ground, connection to the motor positive relay solenoid open circuit;</li> </ul>	<ul style="list-style-type: none"> <li>A. Run the engine at fast idle a few minutes to increase air pressure in the accessory air tank and try again.</li> <li>B. Turn the relieving shut-off valve handle clockwise to deflate the inflatable seal, disconnect the pressure transducer. CAUTION, do not forget to reconnect the pressure transducer and to close the relieving shut-off valve. Failure to do so could damage the seal and lead to water infiltration;</li> <li>C. Operate the slide-out with the manual override procedures.</li> </ul>

PROBLEM	CAUSE	CORRECTIVE ACTION
When extending, the slide-out stops after having extended by 1 inch	A. The security pin valve solenoid circuit is shorted to (+) 24-volt and the security pin remains engaged;	A. Disconnect air supply from the security pin cylinder;
Transmission DRIVE range or REVERSE cannot be selected (the slide-out telltale light is illuminating).	A. Slide-out not in full "in" position; B. Faulty "in limit" sensor. The slide-out is retracted but the controller doesn't not see it as retracted.	A. Retract slide-out. B. Confirm that all slide-outs are retracted. On the slide-out control panel, disconnect the 5 pins green connector on the I/O-B module to disable the transmission inhibit. CAUTION, this is a temporary measure, the vehicle must be serviced as soon as possible.
Slide-out does not retract or extend when depressing the control switch.	A. Electrical motor failure; B. Speed reduction gearbox failure; C. Security pin still engaged in receptacle;	A. Replace motor. B. Inspect gearbox components, particularly: bronze wheel or first reduction stage output shaft. Replace damaged components. C. Disengage pin and check if air cylinder is damaged.
Slide-out is not straight once retracted or during retracting or extending operation.	A. Broken rack tooth; B. Faulty rack attachment; C. Faulty shaft key at speed reduction gearbox or jaw coupling; D. Pinion keyless bushing slipping; E. Shaft breaking; F. Flange bearing attachment loosen;	A. Replace rack. B. Tighten mounting bolts, apply proper torque and use Loctite threadlocker (replace rack if necessary). C. Replace key or component having a damaged keyway. D. Realign slide-out and apply proper torque to keyless bushing. E. Replace shaft. F. Reposition shaft and tighten flange bearing mounting bolts.
Slide-out moves out slightly when vehicle is traveling.	A. Lower "in limit" stoppers are not leaning against the structure at the moment when the "in limit" sensor detects the magnet;	B. Adjust the sensor position in order to have contact of the stoppers against the structure at the time when the system stops the slide-out retraction.
Slide-out moves when vehicle is moving.	A. Inflatable seal not inflated	A. Check seal condition and seal air supply system.
Slide-out retracts or extends difficultly.	A. Foreign matters accumulated in the linear bearing;	A. Inspect the linear bearing end seals to see if they are in good condition. If not, replace the end seals and clean the inside of linear bearing.

## 5-32 OTHER FEATURES

Slide-out oscillates vertically when retracting or extending	<ul style="list-style-type: none"> <li>A. Linear bearing balls hardened due to a too heavy load;</li> <li>B. Linear bearing mounting bolts loosen;</li> </ul>	<ul style="list-style-type: none"> <li>C. If balls clearance is excessive, replace linear bearing.</li> <li>D. Tighten mounting bolts.</li> </ul>
Slide-out vibrating or noisy when extending or retracting	<ul style="list-style-type: none"> <li>A. Acetal plastic block rubbing against the slide-out structure;</li> <li>B. Worn-out anti-friction coating on wiper seal around slide-out;</li> <li>C. Lower acetal plastic block rubbing against rail;</li> </ul>	<ul style="list-style-type: none"> <li>A. Realign acetal plastic block.</li> <li>B. Replace wiper seal.</li> <li>C. Remove lower acetal plastic block and machine down 1mm (0.039").</li> </ul>
Top of slide-out moves sideways when vehicle is moving	<ul style="list-style-type: none"> <li>A. Roof reinforcing rod misadjusted;</li> </ul>	<ul style="list-style-type: none"> <li>A. Readjust as per procedure.</li> </ul>
Slide-out does not retract up to its full "in" position	<ul style="list-style-type: none"> <li>A. Interference between the exterior extrusion and the vehicle upper horizontal member above the slide-out;</li> </ul>	<ul style="list-style-type: none"> <li>A. Check for straightness of horizontal member and adjust the roof reinforcing rod.</li> <li>B. Check for outer wiper seal lip straightness on the slide-out roof.</li> </ul>
Bottom of slide-out not flush with vehicle body	<ul style="list-style-type: none"> <li>A. Broken or misadjusted lower "in limit" stopper;</li> <li>B. Lower "in limit" stoppers are not leaning against the structure at the moment when the "in limit" sensor detects the magnet;</li> <li>C. Acetal plastic block serving as leaning surface for lower "in limit" stopper broken or moved;</li> </ul>	<ul style="list-style-type: none"> <li>D. Replace or adjust lower "in limit" stopper.</li> <li>E. Adjust the sensor position in order to have contact of the stoppers against the structure when slide-out is stopped.</li> <li>F. Replace or adjust acetal plastic block proper position.</li> </ul>
Top of slide-out not flush with vehicle body	<ul style="list-style-type: none"> <li>A. Broken or misadjusted leveling or retaining screw;</li> <li>B. Faulty upper "in limit" stopper;</li> </ul>	<ul style="list-style-type: none"> <li>A. Check and replace screw.</li> <li>B. Replace upper "in limit" stopper.</li> </ul>
Lower edge of slide-out not parallel with vehicle body opening	<ul style="list-style-type: none"> <li>A. Faulty leveling and retaining screw (8 screws each side).</li> </ul>	<ul style="list-style-type: none"> <li>C. Inspect screw, replace and adjust slide-out level.</li> </ul>
Watertightness problem	<ul style="list-style-type: none"> <li>A. Inflatable seal and/or wiper seal damaged or unstuck;</li> <li>B. Insufficient air pressure in the seal;</li> <li>C. No air pressure in the slide-out pneumatic system;</li> </ul>	<ul style="list-style-type: none"> <li>A. Check both seals condition.</li> <li>B. Check the pressure regulator, the relieving shut-off valve and the seal valve condition.</li> <li>C. Check the slide-out air pressure inlet valve condition and the accessory air tank pressure.</li> <li>D. Check the exterior extrusion screws, the windows and the exterior panels sealant condition.</li> </ul>

	<p>D. Sealant missing;</p> <p>E. Wiper seal draining hole clogged;</p> <p>F. Faulty water recovery pan;</p> <p>G. Faulty internal gutter;</p>	<p>E. Unclog draining hole.</p> <p>F. Check the recovery pan.</p> <p>G. Check internal gutter.</p>
Knocking sound at end of travel when extending slide-out	A. Inner stoppers misadjusted;	A. Readjust the inner stoppers.
Knocking sound when parking brake is released	A. Security pin retracts too rapidly;	A. Adjust security pin air flow regulator.
Inflatable seal damaged or removed, or wiper seal unstuck from the structure.	<p>A. Slide-out has been retracted or extended with the manual procedure with the inflatable seal not deflated;</p> <p>B. Pressure transducer malfunction;</p> <p>C. Faulty roof reinforcing rod adjustment;</p> <p>D. Seal valve malfunction;</p> <p>E. Excessive load in the slide-out;</p> <p>F. Slide-out not centered in the structure opening;</p>	<p>A. Always deflate the seal when manually retracting or extending the slide-out.</p> <p>B. Check the pressure transducer condition, replace if necessary.</p> <p>C. Readjust the roof reinforcing rod.</p> <p>D. Check the seal valve condition.</p> <p>E. Reduce load or distribute load evenly in order to respect the deflection criterion and slide-out load capacity.</p> <p>F. Readjust the slide-out height and center horizontally in opening.</p>
Friction at end of travel when in full OUT position or at beginning of retraction	A. Interference between upper structure key and upper inner stopper;	A. Readjust the upper inner stopper.

<p>the structure.</p>	<p>C. Faulty roof reinforcing rod adjustment;</p> <p>D. Seal valve malfunction;</p> <p>E. Excessive load in the slide-out;</p> <p>F. Slide-out not centered in the structure opening;</p>	<p>C. Readjust the roof reinforcing rod.</p> <p>D. Check the seal valve condition.</p> <p>E. Reduce load or distribute load evenly in order to respect the deflection criterion and slide-out load capacity.</p> <p>F. Readjust the slide-out height and center horizontally in opening.</p>
<p>Friction at end of travel when in full OUT position or at beginning of retraction</p>	<p>A. Interference between upper structure key and upper inner stopper;</p>	<p>A. Readjust the upper inner stopper.</p>

## SECTION 6      STARTING AND STOPPING PROCEDURES

IGNITION SWITCH .....	2
STARTING THE ENGINE.....	2
STARTING FROM THE DRIVER’S SEAT.....	3
STARTING THE ENGINE FROM THE ENGINE COMPARTMENT .....	4
COLD WEATHER STARTING .....	4
JUMP STARTING.....	5
ENGINE BLOCK HEATER .....	6
ENGINE WARM-UP.....	6
ALLISON TRANSMISSION WARM-UP.....	7

## 6-2 STARTING AND STOPPING PROCEDURES

### IGNITION SWITCH

Coaches may be equipped with an ignition lever instead of an ignition key.

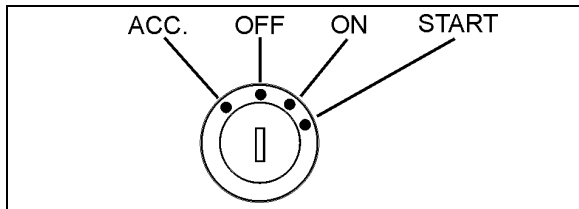

IGNITION SWITCH POSITIONS

06354

The ignition switch is located on the lower left side of the dashboard. It has four positions:

**OFF** - In the off position, ignition cannot take place. The key can be removed when in this position.

The electrical circuits are not activated when the switch is in this position. Only the accessories connected directly to the batteries can be activated. These are:

- The preheater, the preheater timer and the water pump;
- The battery master switch;
- The entrance door;
- The baggage compartments central locking system;
- The battery equalizer;
- The engine and transmission control unit;
- The fire detection and suppression system.

Maintain the switch in this position when parked overnight or for an extended period.



### CAUTION

When the vehicle is parked overnight or for an extended period of time, the battery master switch should be set to the OFF position.

### NOTE

*The battery master switch is ON when the hazard flashers are activated, even if the key is in the OFF position.*

**ACCESSORIES** - To operate the accessories only, turn the ignition key counterclockwise to the ACC position. The key cannot be removed in this position.

The electrical circuits are activated when the switch is in this position or when the hazard flashers are activated.

The features enabled when the key is in the ACC position are all those linked directly to the battery plus the exterior temperature display, the radio or entertainment system, exterior and interior lighting.

**ON** - Set the ignition switch to on by turning the key clockwise to the first position. The key cannot be removed in this position.

The electrical circuits activated when the switch is in the ACC position plus the transmission, engine and accessories, ABS system, wipers, dashboard cluster gauges and buzzers, air horn and air dryer heater are activated when the key is in this position. Do not leave the key in this position unless the engine is running.

### NOTE

*To prevent discharge of the batteries when the engine is not running, some functions are automatically switched off if the batteries voltage drops below 24.0 volts for more than 30 seconds. A pictogram and a message will appear in the DID while this protection mode is active. Set the ignition key to the OFF position and then turn the ignition key to the ON position to reactivate the functions for a period of 30 seconds before they switch off again. If a prolonged use of the functions with the engine not running is necessary, connect the battery to a charger.*

**START** - Use this position to crank the engine. The ignition switch is equipped with a starter protection which inhibits turning the lever to the START position if the lever has not previously been turned to the OFF position.

The features activated when the engine is running are all those described above plus the HVAC system and daytime running lights.

### STARTING THE ENGINE

In normal circumstances, the engine should be started from the driver's seat. However, a rear-start panel in the engine compartment permits starting of the engine from that location, mainly for maintenance purposes.



**STARTING FROM THE DRIVER'S SEAT**

1. Make sure the rear start selector switch located in the engine compartment is set to the NORMAL position and that the battery master switch located in the main power compartment is set to the ON position;

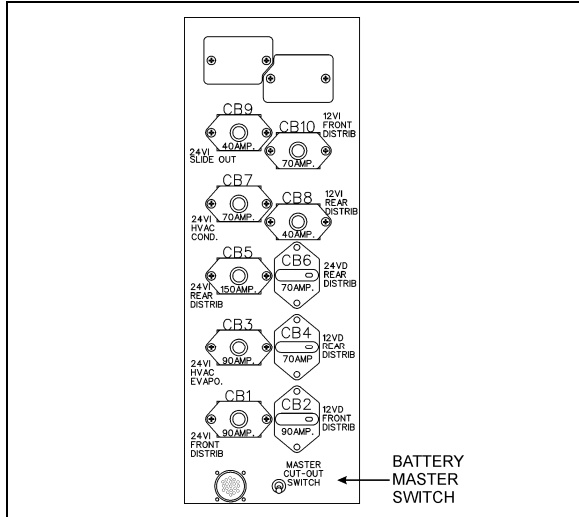

INSIDE MAIN POWER COMPARTMENT 06605A

2. Make sure the parking brake is applied, if not, apply the parking brake by pulling the parking brake control button all the way up;
3. Turn ignition switch to ON and wait a few second;

**NOTE**  
 When the ignition is turned to ON, the M32QR ABS Pressure Modulator Valve solenoids are briefly energized. This can be audibly detected by a rapid cycling of the PMVs. If the air system is fully charged and the service brake pedal is depressed when ignition is turned to ON, the modulator valves create a sharp audible "chuff" of air pressure.

4. The transmission control system automatically selects neutral (N) when the ignition switch is turned to ON;
5. With your foot off the accelerator pedal, turn ignition switch to START position, release the ignition switch after the engine starts. If the engine did not start, return the ignition switch to the OFF position before trying to restart the engine;
6. Brake pedal must be applied when selecting Drive (D) otherwise the transmission will stay in neutral (N).

**CAUTION**  
 Do not engage starter for more than 15 seconds at a time. If engine does not start within 15 seconds, release ignition key and let starter cool for one minute before attempting to restart.

**CAUTION**  
 Do not press the accelerator pedal before starting. This could result in an electronic control unit fault and degrade the fuel system control.

**CAUTION**  
 Special precautions are necessary with turbocharged engines to avoid possible turbine damage. After starting, run the engine at normal idle for two minutes to allow lubricating oil to reach the turbocharger. Then run the engine at fast idle. Let oil pressure reach normal operating range before driving.

**NOTE**  
 If engine does not start, return key to OFF position before attempting to restart.

**NOTE**  
 If the accelerator pedal is depressed before starting, release and wait 30 seconds before attempting to restart.

**WARNING**  
 Do not use ether or other combustable starting aid fluid on any engine equipped with an intake air preheater. If the engine is equipped with a preheater, introduction of ether or similar starting aids could cause a fire or explosion resulting in severe property damage, serious personal injury or death.

**Stopping the Engine**

1. Apply parking brake and place transmission in neutral (N);
2. Shut off all electrical loads;
3. Allow engine to idle for at least two minutes before shutting down the engine. This

## 6-4 STARTING AND STOPPING PROCEDURES

insures that the turbine speed drops and allows time for the engine exhaust gas temperature to drop to about 300°F (150°C);

4. Turn the ignition key to the OFF position.



### CAUTION

Do not shut off the engine when running above normal idle.



### CAUTION

Set the Safety switch to the OFF position after parking and when left unattended for an extended period of time.

### STARTING THE ENGINE FROM THE ENGINE COMPARTMENT

Switches to start and stop the engine from inside the engine compartment are mounted on a small panel on the R.H. side of engine compartment.



### WARNING

Apply parking brake before starting engine from inside the engine compartment.

1. Set the battery master switch to the ON position;
2. Set the starter selector switch to the REAR START position;
3. Press the REAR START push-button switch. Release the push-button after the engine starts.

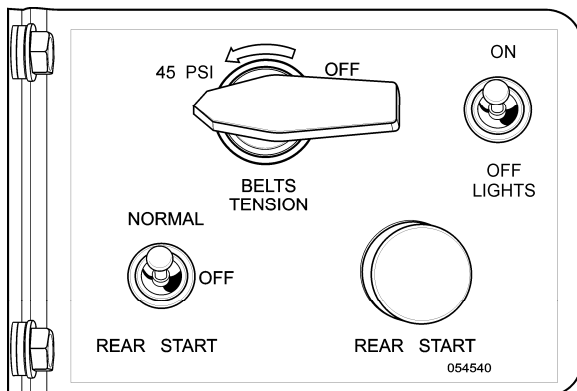

ENGINE REAR START PANEL

01044



### WARNING

Do not wear loose clothing when working near engine. Stand clear of rotating components.



### CAUTION

Refer to cautions in "Starting From The Driver's Seat" and "Stopping the Engine" in this chapter.

### STOPPING THE ENGINE

To stop the engine, set the starter selector switch to the OFF position.



### CAUTION

Do not stop engine by any other method.



### WARNING

Apply the parking brake before stopping engine. In the event the engine is stopped while the parking brake is not applied, a reminder alert will sound.

### COLD WEATHER STARTING

When starting a cold engine, the intake air will be warmed up with the intake air preheater. Turn the ignition switch to the ON position. The intake air preheater will not engage at coolant temperature above 54°F (12°C). If the coolant temperature is below 54°F (12°C), the intake air preheater will engage and will light the preheater telltale between 0 and 50 seconds, depending on the engine coolant temperature. Wait before the preheater telltale has turned off before starting the engine.

If necessary, once the engine has started, the preheater will reengage (post heating) for the same length of time as the preheat time.

 **WARNING**

Do not use ether or other combustible starting aid fluid on any engine equipped with an intake air preheater. If the engine is equipped with a preheater, introduction of ether or similar starting aids could cause a fire or explosion resulting in severe property damage, serious personal injury or death.

Engines not equipped with an intake air preheater may, depending on coolant temperature, take longer to start. If this should happen, DO NOT release the ignition key until the engine has started (while still observing the 15 second maximum cranking time).

**JUMP STARTING**

In order to avoid damage to solid-state electrical components, it is important that jumper (booster) cables be used correctly and only in emergencies. To jump start, use another 24 volt DC, negative grounded, power source. Use only jumper cables rated at 500 cranking amperes.

 **WARNING**

Injury, explosion, battery acid damage or charging system overload may result if these jump starting procedures are not precisely followed.

 **WARNING**

Wear eye protection and remove rings, metal jewelry and watches with metal bands.

 **WARNING**

The battery could rupture or explode if jump started when the run-down battery fluid is frozen or if the battery fluid level is low. Check condition of run-down battery before attempting to jump start.

 **WARNING**

The gases given off by batteries while jump starting are explosive. Do not smoke near batteries.

 **CAUTION**

Do not let the two vehicles touch. Keep a walk-through distance between the two vehicles. Make sure positive (red) and negative (black) jumper cable clamps do not touch.

 **CAUTION**

Never connect the jumper cable to the negative terminal post of the run-down battery.

 **CAUTION**

Do not jump start if a maintenance-free battery has a yellow test indicator. Have the battery replaced.

 **CAUTION**

Before attempting to jump start, make sure the parking brake is applied and the transmission is in neutral (N). Turn off all lights, heaters and other electrical accessories.

 **CAUTION**

Choose a booster vehicle which produces comparable amperage as your vehicle.

 **CAUTION**

Off-board battery charger with a start boost facility must not be used to jump start the vehicle. This could damage the electrical system.

## 6-6 STARTING AND STOPPING PROCEDURES

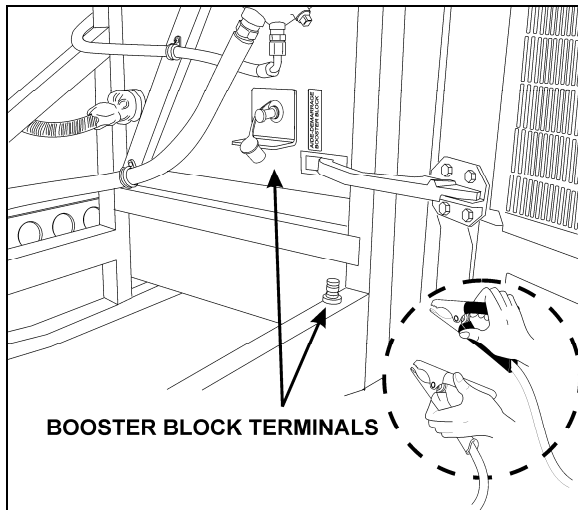

BOOSTER BLOCK TERMINALS IN ENGINE R.H. SIDE ACCESS COMPARTMENT

18645

To jump start, proceed as follows:

1. Remove the protective caps from the booster block terminals located in the main power compartment.
2. Connect one end of the red jumper cable to the positive (+) post of the booster power source. If the good battery is in another vehicle, that vehicle's engine must be stop before connecting;
3. Connect the other end of the same red jumper cable to the positive (+) terminal on the booster block;
4. Connect one end of the black jumper cable to the negative (-) post on the booster power source;
5. Connect the other end of the same black jumper cable to the negative (-) terminal on the booster block; If the good battery is in another vehicle, start that vehicle's engine;
6. Let the engine run for a few minutes, then start the vehicle with the run-down battery;
7. Disconnect the jumper cables in reverse order given in steps 2 through 5;
8. Install protective caps on the booster block terminals.

### NOTE

Jumper cables must be rated at 500 cranking amperes. If jumper cable length is 20 feet (6 m) or less, use 2/0 (AWG) gauge wires. If cable length is between 20 to 30 feet (6 to 9 m), use 3/0 (AWG) gauge wires.

## ENGINE BLOCK HEATER

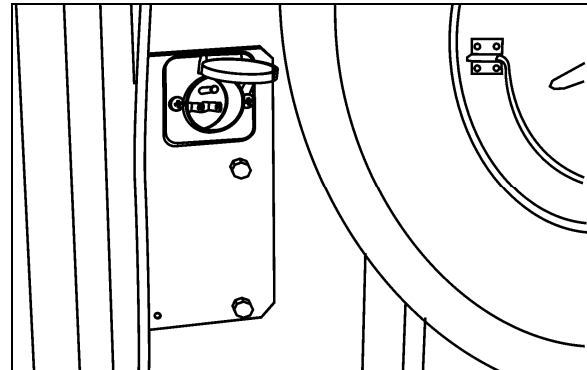

110-120 VOLTS BLOCK HEATER CONNECTOR 06650

The vehicle is equipped with an engine immersion-type electric block heater to assist cold weather starting. A connector is located inside the engine R.H. side compartment. Using an extension cord, connect to a 120 VAC outlet. Use the engine block heater when the vehicle is parked in cold weather for a long period and the proper power source is available.



### CAUTION

Connect only to a 120 VAC power source. Use only grounded (three prongs) extension cords with a minimum rated capacity of 15 amps. Disconnect the extension cord before starting. Before driving, make sure the extension cord is disconnected and the engine R.H. side compartment door is closed.

## ENGINE WARM-UP

After starting the engine, keep the parking brake applied and let the engine run at normal idle for two minutes to allow lubricating oil to reach the turbocharger. Increase engine speed to fast idle, using the fast idle switch located on the dashboard for five minutes, without loading the engine. Monitor the gauges and indicator lights to make sure all conditions are normal. If an abnormal condition is observed, stop the engine immediately and have the condition corrected.



### WARNING

Never let the engine run in an enclosed, non-ventilated area. Engine exhaust fumes contain dangerous gases which can be fatal if inhaled. Before warming up the engine, open the door(s) or move the vehicle outside.

***NOTE***

*The engine will reach normal operating temperature shortly after driving. Avoid driving at full throttle until engine coolant temperature reaches 140°F (60°C).*

**ALLISON TRANSMISSION WARM-UP**

With an automatic transmission, when the temperature falls below -20°F (-29°C), the CHECK TRANS telltale light illuminates after the engine is started, and a reminder tone will sound. In this case, the transmission will be locked in neutral (N) until the transmission temperature rises above -20°F (-29°C) and the CHECK TRANS telltale light goes out. The transmission will only operate in first or reverse gears until it reaches normal operating temperature.



## SECTION 7 SAFETY FEATURES AND EQUIPMENT

<b>EMERGENCY EXITS .....</b>	<b>2</b>
ELECTRIC AWNING WINDOWS.....	2
ELECTRIC SLIDING WINDOWS .....	2
FIXED WINDOWS .....	2
EMERGENCY ROOF ESCAPE HATCH.....	2
<b>EMERGENCY AIR-FILL VALVES.....</b>	<b>3</b>
<b>EMERGENCY AND PARKING BRAKES.....</b>	<b>4</b>
<b>SAFETY EQUIPMENT.....</b>	<b>4</b>
AUTOMATIC FIRE DETECTION AND SUPPRESSION SYSTEM (AFSS) (OPTIONAL) .....	4
TIRE PRESSURE MONITORING SYSTEM (TPMS) (OPTIONAL).....	5
FIRE EXTINGUISHERS.....	7
FIRST AID KIT .....	8
WARNING REFLECTORS .....	8
JACK/TOOLS .....	8
SPARE PARTS KIT .....	8
<b>CHANGING WHEELS .....</b>	<b>8</b>
JACKING POINTS .....	8
HYDRAULIC JACK.....	9
<b>TOWING THE VEHICLE .....</b>	<b>9</b>
LIFTING AND TOWING.....	10
TOWING WITHOUT LIFTING .....	11
<b>DAYTIME RUNNING LIGHTS.....</b>	<b>11</b>
<b>FOG LIGHTS.....</b>	<b>11</b>
<b>CORNERING AND DOCKING LIGHTS .....</b>	<b>12</b>
<b>COMPARTMENT LIGHTING .....</b>	<b>12</b>
<b>MUD FLAPS AND SPLASH GUARDS .....</b>	<b>12</b>
<b>BACK-UP CAMERA.....</b>	<b>12</b>
<b>BACK-UP ALARM.....</b>	<b>12</b>
BACK-UP ALARM CANCEL.....	12
<b>ESSENTIAL FUNCTIONS TO OPERATE THE VEHICLE (BASIC LIMP-HOME FUNCTIONS).....</b>	<b>12</b>
<b>ENGINE PROTECTION SYSTEM .....</b>	<b>13</b>
AUTOMATIC ENGINE SHUTDOWN .....	13

## 7-2 SAFETY FEATURES AND EQUIPMENT

### EMERGENCY EXITS

Locate and learn how to use all possible emergency exits. Inform all guests or passengers of the location of exits and how to use them in case of an emergency.

### ELECTRIC AWNING WINDOWS

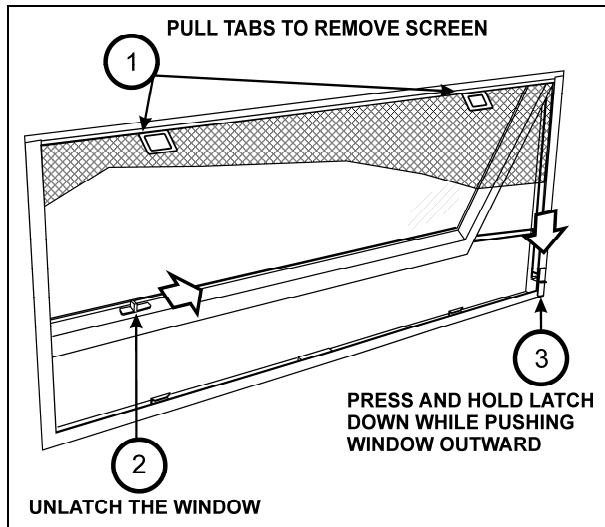

ELECTRIC AWNING WINDOW

18584

### ELECTRIC SLIDING WINDOWS

Electric (power) sliding windows can be used as emergency exits.

- Remove the screen assembly,
- Pull down on both red release latches simultaneously and rotate the sash inwards approximately 10 degrees.
- Lift the sash up and out to disengage the bottom of the sash from the window frame.

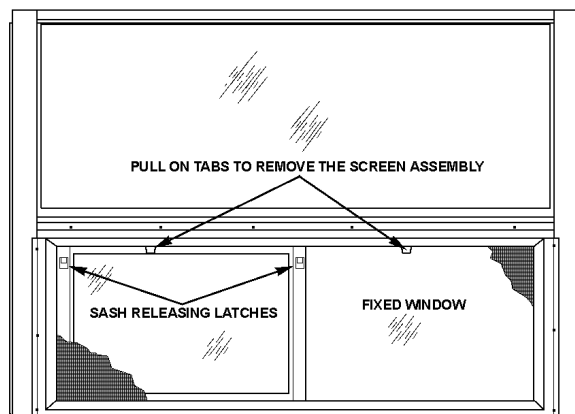

ELECTRIC SLIDING WINDOW

18206

### FIXED WINDOWS

Fixed windows are fastened or glued to the structure of the vehicle, they do not open and are very hard to break. Do not attempt to open, instead find and use the entrance door, the nearest awning or sliding window or a roof escape hatch.

### EMERGENCY ROOF ESCAPE HATCH

A roof ventilation hatch, designed to be opened by occupants may be installed in the roof at the rear of the vehicle. Another optional roof hatch may be located in the front of the vehicle. The hatches can serve as emergency exits. In case of an emergency, push the ventilation hatch upwards (1). Turn knob ¼ turn (arrow pointing "TO EXIT") and then push knob to release the hatch (2). Push the escape hatch outwards (3). A decal with operating instructions is located on the hatch.

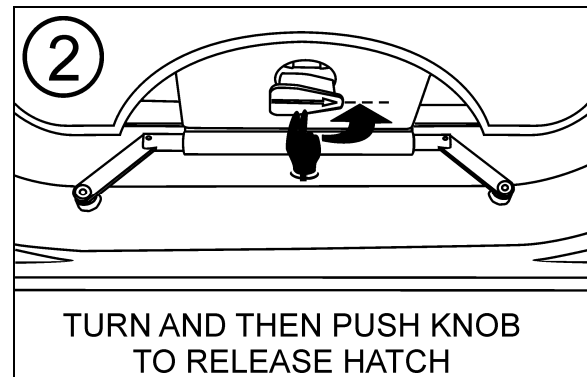
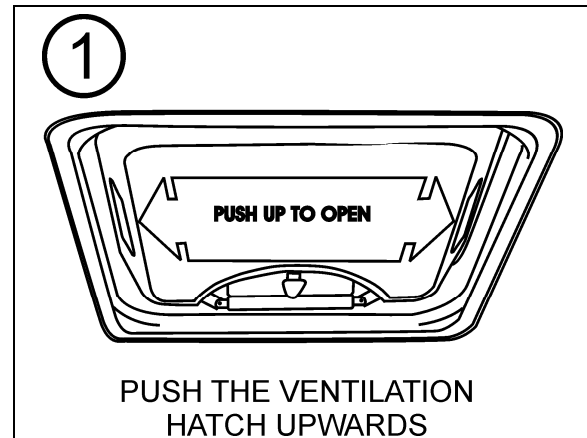



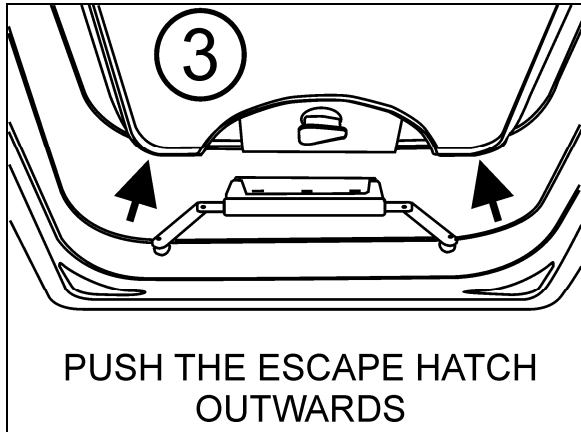

**EMERGENCY ROOF ESCAPE OPENING**

**NOTE**

*In the event of ventilation blower motor failure, the roof hatch may be used to aid ventilation by pushing the hatch upwards.*



**CAUTION**

Be aware of reduced vehicle overhead clearance when driving under overpasses with the roof hatch open.

To latch escape hatch after use, vent arms must be pushed upright in FULL OPEN VENT position. Insert edge firmly between the two sections of the bracket and then return knob to original position (arrow pointing "LATCHED") to lock the hatch. Finally, pull the hatch in to closed position, one side at a time.

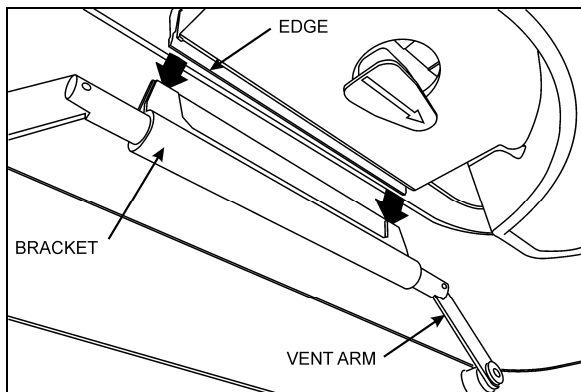

**ROOF ESCAPE LATCHING**

**EMERGENCY AIR-FILL VALVES**

The vehicle is equipped with two air system emergency fill valves to supplement the air system when air pressure is low and the engine cannot be operated. One valve is located inside

the front service compartment. The other valve is located inside the engine compartment.

Both air system emergency fill valves are fitted with standard tire valve stems. The air systems can be filled using any standard external air supply line. The fill valve located in the engine compartment supplies air for all systems (brakes, suspension and accessories). The fill valve located in the front service compartment supplies air for accessories only.



**CAUTION**

Air filled through the two emergency fill valves will pass through the standard air filtering-drying system. Do not fill air at any other location. Do not exceed 120 psi (827 kPa).

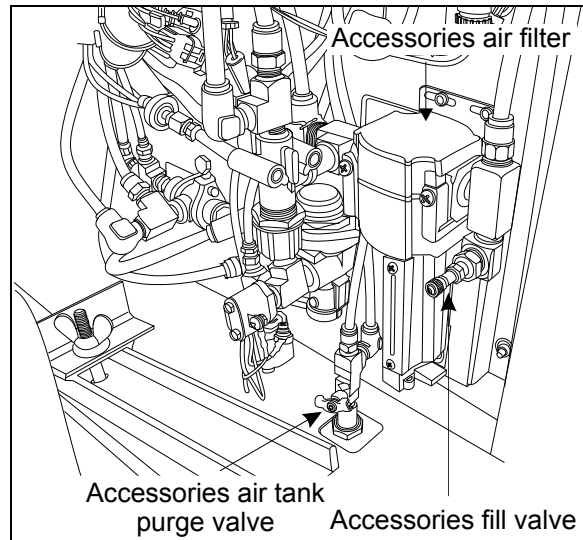

**FRONT SERVICE COMPARTMENT**

12130

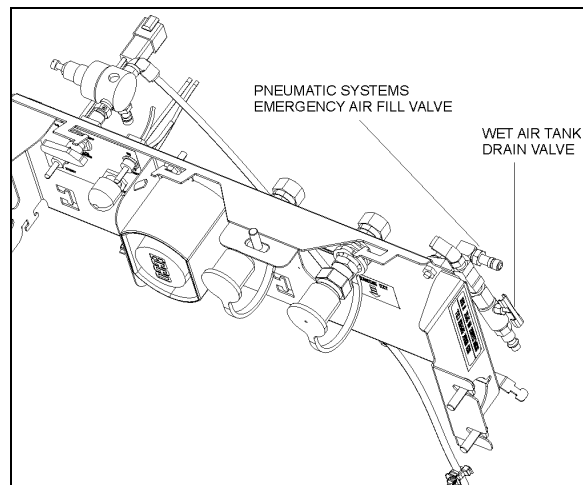

**FILL VALVE IN ENGINE COMPARTMENT**

12219\_4

## 7-4 SAFETY FEATURES AND EQUIPMENT

### EMERGENCY AND PARKING BRAKES

During normal operation, if air pressure in both brake circuits drops below 40 psi (276 kPa), spring-loaded emergency parking brakes will be immediately applied at full capacity to the drive axle wheels to stop the private coach.

Spring-loaded parking brakes are applied by pulling up the control valve knob located on the L.H. lateral console.

Parking brakes are not designed to be used as service brakes. For normal driving conditions, the control valve knob must remain in the down position.

#### **NOTE**

*Only use the parking brakes to supplement the service brakes to stop the private coach in emergency conditions. The stopping distance will be considerably longer than when using normal service brakes.*

#### **NOTE**

*Before releasing the parking brakes by pushing down the control valve knob, check the pressure gauges to make sure that the brake system air pressure is greater than or equal to 95 psi (655 kPa).*



### **WARNING**

Always apply the parking brakes before leaving the driver's seat.

#### **NOTE**

*A beep will sound if the ignition switch is turned to the OFF position without applying the parking brakes. The same beep will sound if pressure is still applied to the service brake pedal.*

#### **NOTE**

*The stoplights will automatically turn on if the parking brake is applied when the ignition key is set to the ON position.*

### SAFETY EQUIPMENT

#### **AUTOMATIC FIRE DETECTION AND SUPPRESSION SYSTEM (AFSS) (OPTIONAL)**

The vehicle may be equipped with the optional Automatic Fire Detection and Suppression System (AFSS).

#### **System operation**

When a fire is detected inside the engine compartment, the system sends a fire alarm signal to the **Protection Panel** located in the Driver's area near the lateral control panel. The **Protection Panel** immediately turns on the fire "ALARM" lamp and sounds the audio alarm. After a 15-second time delay the engine is automatically shut down. The fire extinguisher is discharged simultaneously with engine shutdown.

#### **NOTE**

*The **Manual Activation Switch** is used when immediate discharge of the fire extinguisher and engine shutdown is desired.*

#### **NOTE**

*The **Protection Panel** continuously monitors system integrity and displays the information via the "SYSTEM OK" and fire "TROUBLE" indicators.*

#### **Operational sequence (fire)**

1. A fire detector or liner thermal detector detects a fire in the engine compartment and sends a signal to the **Protection Panel** in the driver's area.
  2. The fire "ALARM" lamp on the **Protection Panel** will illuminate solid red and an audible alarm will sound.
  3. The operator shall bring the vehicle to a safe stop.
  4. The system automatically shuts down the vehicle engine and discharges the extinguisher into the engine compartment 15 seconds after the fire alarm starts unless advanced or delayed by the operator.
- If the operator presses the **Manual Activation Switch**, all delays will terminate and the engine shutdown and extinguisher discharge will occur immediately.

- If the operator presses and releases the **Delay Engine Stop** switch once, the engine shutdown and extinguisher discharge will be delayed by an additional 15 seconds.

 **WARNING**

The engine will stop 15 seconds after the fire alarm starts. The operator must be prepared to bring the vehicle to a safe stop as soon as the alarm sounds. Steering may become difficult after engine shutdown. If more time is required, the “DELAY ENGINE STOP” switch may be pressed and released for an additional 15 seconds delay.

 **WARNING**

The extinguisher discharge may cause an obscuring cloud behind and near the vehicle.

5. The red fire “ALARM” lamp and audible alarm will stay on. The yellow fire “TROUBLE” lamp will also be on indicating a discharged extinguisher.
6. The system must be reset and the fire extinguisher removed and replaced in accordance with the System Reset portion of the Kidde Dual Spectrum Operation & Maintenance Manual.

**TIRE PRESSURE MONITORING SYSTEM (TPMS) (OPTIONAL)**

The vehicle may be equipped with the optional Tire Pressure Monitoring System (TPMS).

**Description**

System includes the following elements:

- Special tire valves;
- RF sensor inside each tire, fixed to the valve;
- 3 antennas to receive the sensors RF signal (one in the front spare tire compartment, one above the L.H. side rear wheels and one above the R.H. side rear wheels);
- A TPMS receiver connected to the antennas and located in the front electrical compartment, above the CECM;
- A TPMS display built in the L.H. dashboard panel;

- A “FLAT TIRE” telltale panel indicator.

The section of the special tire valves located inside the tire is dome-shaped to allow fixing the sensor.

Sensors provide continuous tire pressure and temperature reading.

The normal sensor battery lifespan is 5 years. The remaining lifespan is displayed as a percentage in the TPMS display.

**NOTE**

*It is recommended to check the remaining battery lifespan when changing the tires in order to replace the sensors at the same time if they are due for replacement before the next change.*

The screw fixing the sensor to the valve can only be used once because the threads are powder-coated to lock the sensor in place and prevent unfastening.

The telltale panel indicator illuminates for 3 seconds when the ignition switch is turned ON to check the display operation and the communication between the display and the vehicle multiplex system. This confirms the communication between the TPMS display and CECM.

**Settings Menu**

- Set Wheel ID

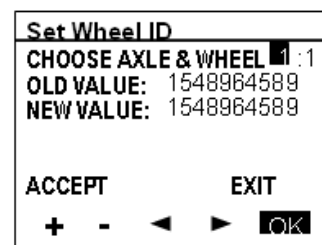
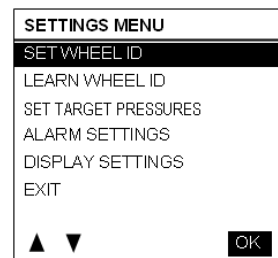

- ◀ ▶ Navigate
- +/- Increase, decrease digits
- OK Navigate forward
- ACCEPT & OK Execute Change Old Value = New. Stay in Menu
- EXIT & OK Ignore changes in progress (new value) and EXIT menu

- Learn Wheel ID

This menu allows learning new wheel sensors ID. The user can learn only one wheel, several wheels or all wheels of the vehicle. The

## 7-6 SAFETY FEATURES AND EQUIPMENT

sequence automatically jumps to the next wheel such that a user can initiate all wheels without having to come back to the display between each wheel.

The display uses a pressure change as the criteria to recognize which wheel sensor the operator wants to get assigned to a given location. The amount of pressure change required is established at 2 PSI.

A pressure change of about 3 PSI is needed to wake up a sensor and then an extra amount of pressure change of 2 PSI is needed to trigger the display. The operator has to create a pressure change by at least 6 PSI and then wait for the display to recognize the pressure change. The wait time correspond to the sensor sampling rate.

When entering the menu, the axle 1, wheel 1 is selected by default as a starting point for the learning. The user can select another axle with +/- , move the cursor to the wheel number with the right arrow and select another wheel with the +/- or move the cursor down to the start learning button.

After the start learning button is selected, the display stores the first transmission it gets from each sensor ID into the “initial pressure” for that sensor ID. Then it compares each subsequent pressures received for that sensor ID with the initial one and when the comparison shows a delta pressure exceeding the defined level required, this sensor ID is assigned to the selected tire location.

Once a wheel ID has been assigned, the display increments the number of Wheels done and it moves the axle/wheel to the next one in the sequence waiting for another sensor to come up with a pressure change. Within one learning session, the display remembers which sensor has been assigned and it will not assign it twice.

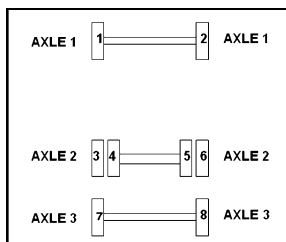

The sequence increments to the next wheel on the same axle counting wheels from left to right and then moves to the next axle counting axles from front to rear.

The display activates the next wheel parameter each time a wheel is done. This parameter is use by the vehicle electronic to activate an audible signal on the vehicle thus providing a feedback to the user that he can move to the next wheel.

The spare Tire can be done by selecting the axle/wheel “spare” which is internally encoded to 15:1.

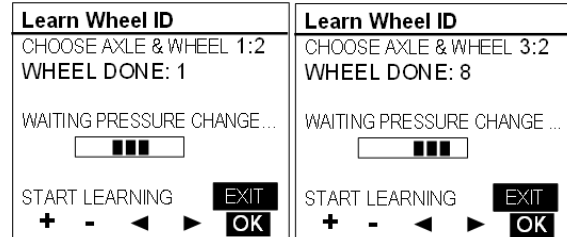
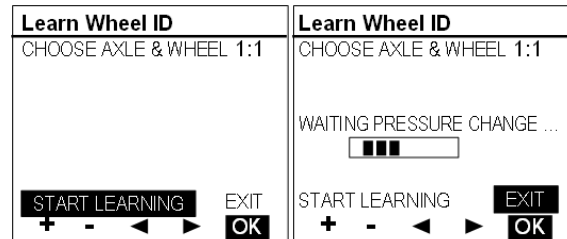
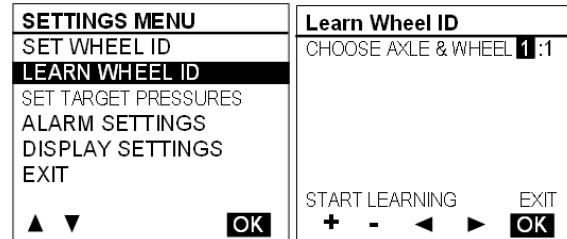

- Set Target Pressures

This menu allows the end user fine tuning the target pressure setting to account for the specific operating conditions (cold weather operation or unloaded operation). The end user can readjust the target pressure within +30% and -20% of the factory set target pressure but not outside this range.

The factory set target pressure is always kept in permanent memory into the TPMS display and cannot be edited by the end user.

When the user enters a new target value, the user cannot select values outside the valid range.

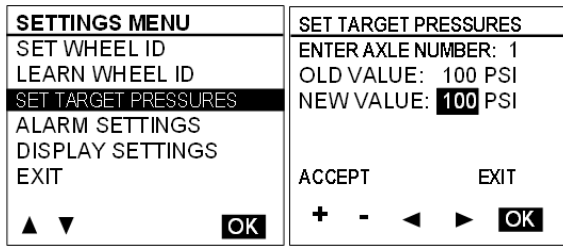

• Alarm Settings

When selecting the Alarm Settings Menu, a sub menu containing Pressure Alarm and Temperature Alarm appears.

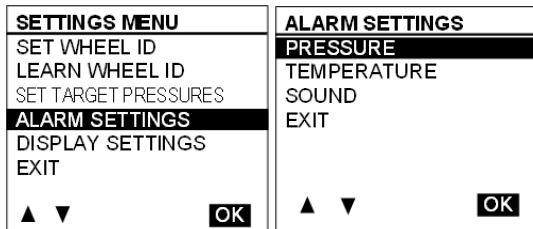

When selecting Pressure Alarm the screen pressure alarm shown below appears. A similar screen is defined for temperature settings. The cursor can be moved to highlight the number beside “new value”, “ACCEPT” or “EXIT”. +/- allows increasing or decreasing the numbers. Pressure alarms changes are allowed in steps of 1 PSI in the range from 5 to 20 PSI. Temperature alarms in steps of 5°F (2°C) in the range from 150 to 180 °F (64 to 82 °C). Pressing OK with “ACCEPT” highlighted applies the change and exits to the previous menu. Pressing OK when “EXIT” is highlighted exits without changes.

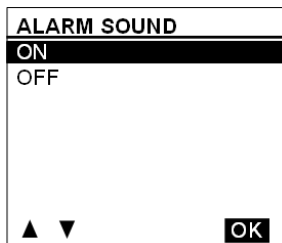
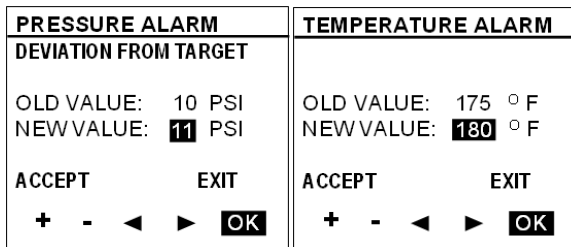

• Display Settings

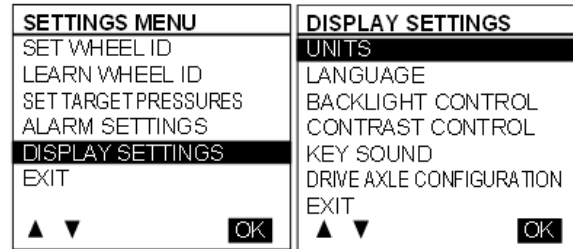

Units

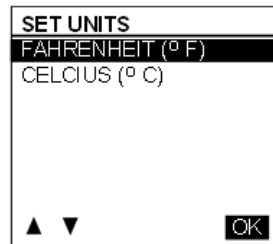

Languages



Backlight Intensity

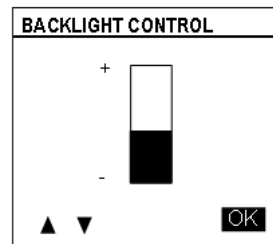

Key Sound

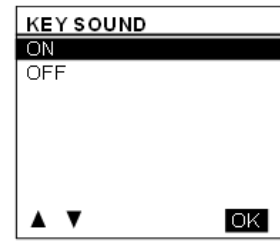

turns key press sound ON/OFF

Tire / Axle Configuration



Pressing the up down arrow when the number of tires is highlighted allows flipping the number to 2 or 4 which are the only valid choices.

Refer to *Appendix G* for Troubleshooting Guide on TPMS system.

**FIRE EXTINGUISHERS**

Two fire extinguishers are located on the private coach L.H. side just behind the driver’s seat. Instructions for use are found on the extinguishers. Make sure you know how to operate fire extinguishers in case of an emergency.

## 7-8 SAFETY FEATURES AND EQUIPMENT

### FIRST AID KIT

The First Aid Kit is optional. A sticker (white cross over red background) identifies the First Aid Kit. It is usually stored near the driver's seat.

### WARNING REFLECTORS

A kit containing three triangular reflectors is provided to warn other drivers on the road in case of a breakdown. The kit is located on the right side of the first R.H. side baggage compartment with the jack and tools. The reflectors provide visible warning of an emergency situation. The three reflectors should be placed as indicated on the box cover. These reflectors comply with FMVSS 125 (Federal Motor Vehicle Safety Standards).

### JACK/TOOLS

A kit for jacking up the private coach is stored in the first R.H. side baggage compartment. The kit includes a:

1. 12 ton bottle jack;
2. Wheel nut wrench and lever;
3. Triangular reflectors.

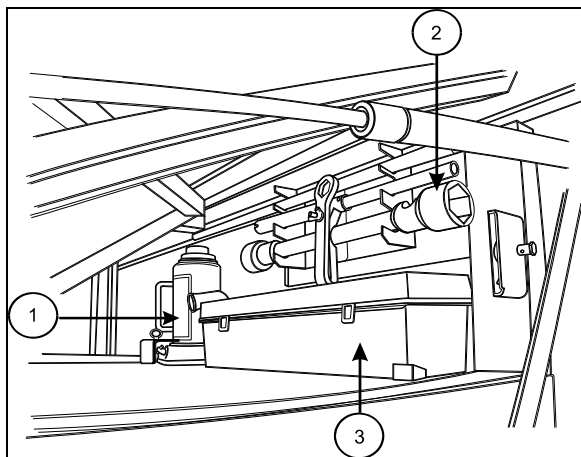

FIRST R.H. SIDE BAGGAGE COMPARTMENT 13015

### SPARE PARTS KIT

The private coach may be equipped with a spare parts kit (optional). The kit contains parts such as bulbs, circuit breakers, belts, etc. The spare parts kit is stored in the first baggage compartment.

### CHANGING WHEELS

In case of a flat tire, turn on the hazard flashers and bring the vehicle to a stop on the side of the road. Apply the parking brake. Make sure the vehicle is parked safely away from traffic. Set up the triangular reflectors in accordance with applicable highway regulations.

We suggest that you **do not** attempt to change a wheel. First, the wheel and tire are very heavy and usually there is no space available to put the removed flat. Second, the wheel nuts, especially those on inner dual, can become very tight after being on for only a short time. Often a heavy air wrench is required to get these nuts loose. We suggest you get help via cellular phone. There are tire service trucks all over the country that can bring a wheel and make the change safely.

### JACKING POINTS

Twelve jacking points are located on the vehicle: three are located on each side of the frame and two are located under each axle. Refer to the following illustrations for the location of jacking points.

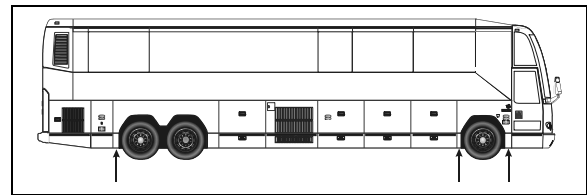

JACKING POINTS ON FRAME

18530

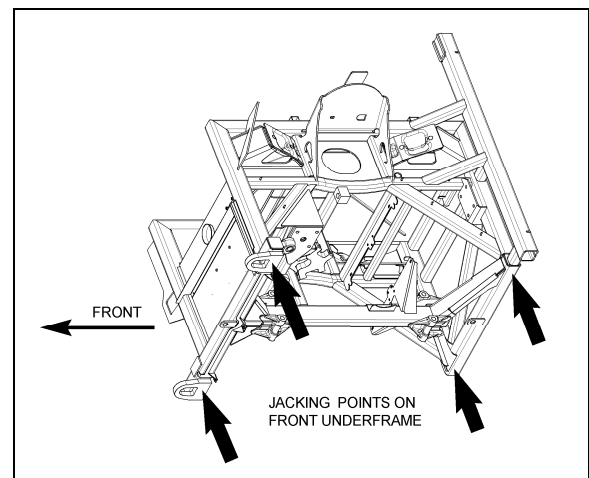

JACKING POINTS ON FRONT UNDERFRAME

18530

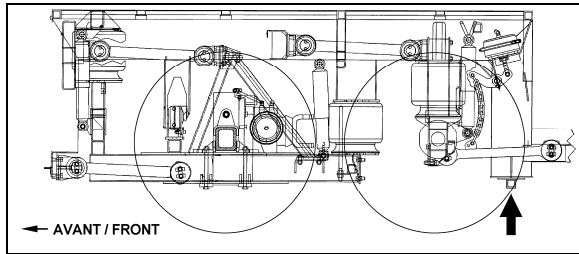

JACKING POINTS ON REAR FRAME

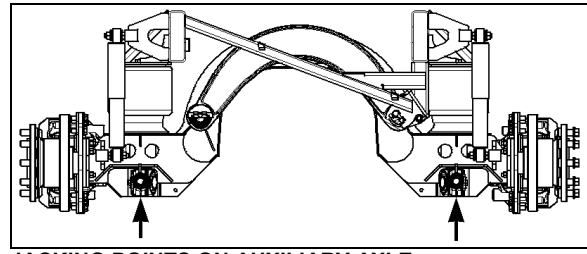

JACKING POINTS ON AUXILIARY AXLE OEH3B764



**WARNING**

The suspension of the vehicle must be in the normal ride position before jacking. The level low system must be in the OFF position prior to turning OFF the ignition key.

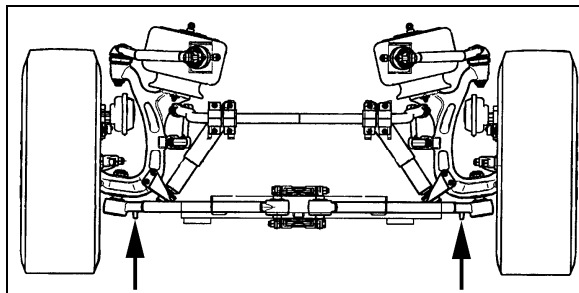

JACKING POINTS ON FRONT AXLE 16095

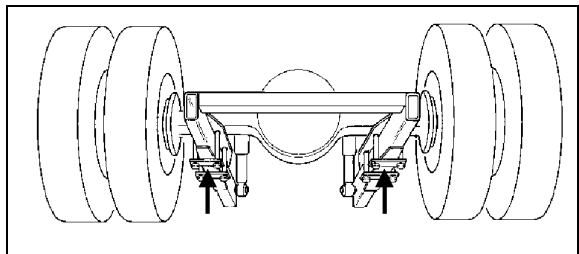

JACKING POINTS ON DRIVE AXLE OEH3B762



**WARNING**

Always unload or retract the auxiliary axle before jacking the vehicle from the front and drive axle jacking points to prevent damage to suspension components.



**WARNING**

The jacking points on the auxiliary axle must be used for raising the auxiliary axle only.

Several kinds of hydraulic jacks can be used. Only jack at the specified jacking points. Jack must support the following capacities:

Front axle: 20,000 lbs. (9 100 kg);

Drive axle: 40,000 lbs. (18 200 kg).

**HYDRAULIC JACK**

To raise: turn release valve clockwise. Insert handle in socket and raise by pumping.

To lower: remove handle and turn the release valve slowly counterclockwise.

Always keep ram and extension screw retracted when jack is not in use.

Service: Check oil level when jack fails to raise to full height. Lower ram completely with release valve open and jack in upright position, remove filler plug and refill to level of filler hole with hydraulic jack oil. Never use brake fluid.



**WARNING**

Jack is intended for lifting only. Do not get under the vehicle or load for any reason unless it is properly supported with safety stands and securely blocked.



**WARNING**

Do not overload jack above rated capacity. Prevent "side loading", make sure load is centered on ram. Do not push or tilt load off jack.

**TOWING THE VEHICLE**

The vehicle can be transported on a low bed semi-trailer of adequate gross axle weight capacity. When transporting a vehicle in this manner, apply parking brake and shut down the engine. Block all wheels and secure vehicle with tie-downs. Check that overall height will clear

## 7-10 SAFETY FEATURES AND EQUIPMENT

obstacles on the route to follow, and obtain required permits.

The vehicle can also be towed by lifting the front axle or by towing from the front with all wheels on the ground. These two methods are described below under their respective headings. Whatever the method used, the vehicle should be towed by truck operators authorized and experienced in towing highway coaches.

Observe normal precautions including, but not limited to, the ones listed below when towing the vehicle:

- Make sure the parking brake is released before towing.
- Do not allow passengers to ride onboard the towed vehicle.
- Tow the vehicle at a safe speed as dictated by road and weather conditions.
- Accelerate and decelerate slowly and cautiously.



### WARNING

Do not carry passengers while the coach is being towed.



### CAUTION

Never tow the vehicle from the rear, as this will cause serious damage to the chassis and engine cradle. In case of damage to the drive train components, use a low bed semi-trailer to support the rear end.

### LIFTING AND TOWING

The towed vehicle must be lifted from under the front axle only. The tow truck must be equipped with the proper lifting equipment to reach under the front axle since no other lifting points are recommended. Lifting and towing from any other point are unauthorized as it may cause serious damage to the structure. Do not unload or raise the tag axle when lifting and towing to prevent overloading the drive axle.

1. Remove both drive axle shafts to prevent damage to the transmission. Plug axle tube to prevent oil loss. Refer to Rockwell's "Maintenance manual no.5" annexed at the

end of Section 11: Rear Axle of the maintenance manual.



### CAUTION

Transmission lubrication is inadequate when towing. With automatic, semi-automatic or manual transmission, the axle shafts or driveshaft must be disconnected to avoid serious damage to the transmission. Do not attempt to push or pull-start the coach.

2. Operate the engine when towing to maintain brake system air pressure. If the engine cannot be operated, connect an external air pressure line from the tow truck to the emergency fill valve in the engine R.H. side compartment. The emergency fill valve in the front service compartment does not supply air pressure to the brake system. The air pressure must be a minimum of 75 psi (520 kPa), and the line should be attached to the air line with a clip-on chuck.



### CAUTION

Do not tow the vehicle without external air pressure applied to the emergency fill valve if the engine does not operate. Without brake system air pressure, the brakes may apply automatically if system air drops below 40 psi (275 kPa). If failure prevents releasing the parking brakes with air pressure, disengage the parking brakes mechanically.

3. Lift the vehicle from under the front axle, and adequately secure the underside to the tow truck lifting attachment with chains.
4. Observe safety precautions when towing.



### CAUTION

Make sure axle shafts or driveshaft are installed correctly after towing. Tighten axle shaft and driveshaft nuts to the correct torque settings. Do not invert shafts.



**TOWING WITHOUT LIFTING**

 **CAUTION**

When towing vehicle without lifting, use only a tow truck with a solid link tow bar and related equipment. All other means of towing are unauthorized. Tow only from the front of the vehicle.

1. Remove both drive axle shafts to prevent damage to the transmission. Plug axle tube to prevent oil loss. Refer to Rockwell's "Maintenance manual no.5" annexed at the end of Section 11: Rear Axle of the maintenance manual.

 **CAUTION**

Transmission lubrication is inadequate when towing. With automatic, semi-automatic or manual transmission, the axle shafts or driveshaft must be disconnected to avoid serious damage to the transmission. Do not attempt to push or pull-start the coach.

2. Operate the engine when towing to maintain brake system air pressure. If the engine cannot be operated, connect an external air pressure line from the tow truck to the emergency fill valve in the engine R.H. side compartment. The emergency fill valve in the front service compartment does not supply air pressure to the brake system. The air pressure must be a minimum of 75 psi (520 kPa), and the line should be attached to the air line with a clip-on chuck.

 **CAUTION**

Do not tow the vehicle without external air pressure applied to the emergency fill valve if the engine does not operate. Without brake system air pressure, the brakes may apply automatically if system air drops below 40 psi (275 kPa). If failure prevents releasing the parking brakes with air pressure, disengage the parking brakes mechanically.

3. Position the tow truck so that the tow bar contacts the front bumper of the vehicle.
4. Attach the tow truck chains only in the tow eyes of the vehicle under the bumper and take up all the slack.
5. Use a safety chain as applicable.

6. Observe safety precautions when towing.

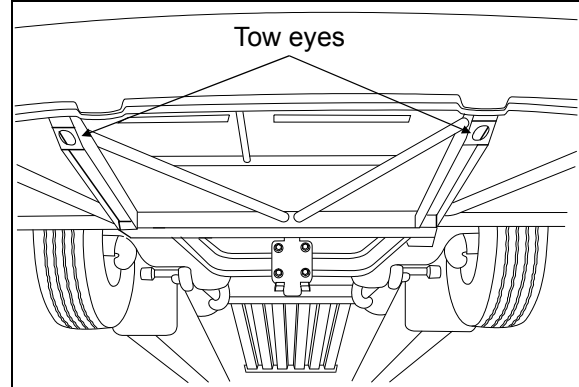

**TOW EYES UNDER VEHICLE**

18401

 **CAUTION**

Make sure axle shafts or driveshaft are installed correctly after towing. Tighten axle shaft and driveshaft nuts to the correct torque settings. Do not invert shafts.

**DAYTIME RUNNING LIGHTS**

The daytime running lights system provide added safety by making the front of the vehicle more visible to other drivers during the day.

The daytime running lights system turns the headlights on when:

1. Engine is running;
2. Parking brake is released;
3. The exterior lighting switch is set to the OFF position or depressed to the first position.

 **WARNING**

Do not drive only with the daytime running lights at night because the taillights and the side marker lights are not turned on in that situation and the high beam can blind other drivers. For night driving, turn ON the headlights by depressing the headlights and exterior lighting rocker switch to the second position.

**FOG LIGHTS**

Fog lights provide better visibility in fog and precipitation. They improve visibility immediately in front of the vehicle. They also provide added safety.

## 7-12 SAFETY FEATURES AND EQUIPMENT

### **NOTE**

*Some states or provinces may restrict the use of fog lights. Verify local state or provincial regulations before using.*

### **CORNERING AND DOCKING LIGHTS**

The private coach may be equipped with up to four halogen lights. Two cornering lights are installed at the front of the vehicle, on each side as standard equipment. Two optional docking lights may be installed on each side at the rear of the private coach. The front lights illuminate at the same time as the turn signal flashers to increase lateral visibility while turning. The rear lights illuminate automatically when the reverse (R) range is selected to increase visibility while backing-up the vehicle.

### **COMPARTMENT LIGHTING**

Baggage, engine, front service and main power compartment lights are automatically turned ON when their respective compartment door is opened if the ignition key is set to ON or ACC. A telltale light on the central dashboard will illuminate when a compartment door is open.

### **MUD FLAPS AND SPLASH GUARDS**

Mud flaps are installed behind each front wheel and the auxiliary axles. Mud flaps minimize dirt on the lower panels of the private coach and prevent stones and debris from being thrown at vehicles travelling behind the private coach. Splash guards may be installed behind each dual wheel of the drive axle to prevent stone projectiles from being thrown at the auxiliary axle wheels.

### **BACK-UP CAMERA**

An optional back-up camera is available which provides the driver with visual assistance when backing-up.

The TV monitor is mounted on the left side pillar and switches ON automatically when the transmission is in the reverse (R) range.

### **BACK-UP ALARM**

The back-up alarm alerts pedestrians and other drivers when the private coach is being backed-up. Take extra precautions whenever backing-

up. If necessary, use a guide to provide directions when backing-up. Both the alarm and optional camera are automatically activated when the transmission is put in the reverse (R) range.

### **BACK-UP ALARM CANCEL**

A rocker switch located on the L.H. side dashboard panel allows the driver to cancel the back-up alarm system (as for example: at night on a camping site).

### **NOTE**

*After use, return to normal operation.*

### **ESSENTIAL FUNCTIONS TO OPERATE THE VEHICLE (BASIC LIMP-HOME FUNCTIONS)**

Even with a defective CECM (Chassis Electronic Control Module) or a CAN network problem, essential base functions are maintained to rear start the vehicle from the engine compartment and drive in a secure manner.

### **AVAILABLE FUNCTIONS**

- Startup: Turn on the ignition in the driver's area and rear start the vehicle from the engine compartment,
- Windshield wipers: Wipers functions at 1st speed only,
- Headlights: Low beams only,
- Directional signals: Rear and front only,
- Stoplights: 2 upper stoplights + high-mounted stoplight are functional,
- HVAC: Functional with set point fixed at 70°F (22°C), evaporator and condenser fixed at speed 1, defroster fixed at speed 4.
- Entrance door lock/unlock switch.



### **CAUTION**

The following directives must be followed.

- Never connect a battery charger when the ignition is at the ON position on a vehicle with a CAN defective or certain functions will start up by themselves,
- Disconnect the charger before starting the

vehicle, if not the default functions will not activate,

- If the default mode does not activate, try to turn the ignition OFF while ensuring that no charger is connected and then restart the vehicle.



## WARNING

Failure to take necessary action when the STOP telltale light is on can ultimately result in automatic engine derate and shutdown.

## ENGINE PROTECTION SYSTEM

The engine protection will automatically derate or stop the engine when certain engine conditions reach a critical stage.

In the event of a serious fault, the red STOP telltale light comes on and an audible alarm will sound if the engine is running.



An illuminated STOP telltale light indicates a serious problem has been detected, and the driver must respond immediately to the problem. The vehicle must be safely pulled off the road and stopped. In some instances, the engine must be switched off immediately.

## AUTOMATIC ENGINE SHUTDOWN

Prior to an actual automatic shutdown, the engine will automatically derate, go to idle, and then stop as the vehicle speed gets below 2 mph (3 km/h).

The engine shutdown protection will automatically derate and stop the engine when one or more of the conditions listed below reaches a critical point:

- High engine coolant temperature
- High engine oil temperature
- Low engine oil pressure
- High crankcase pressure (rate of change)

After the automatic engine shutdown sequence, the engine may be restarted. To do so, turn the ignition switch to the OFF position during 7 seconds and then turn it back to ON. However, it will only operate for 30 seconds unless the problem is resolved.

Use this function sparingly and in order to move the vehicle to a safe parking place only. Excessive use may result in severe engine damage.



## SECTION 8 CARE AND MAINTENANCE

<b>CLEANING.....</b>	<b>2</b>
SEAT UPHOLSTERY .....	2
PLASTIC AND VINYL.....	3
WINDOWS .....	3
STAINLESS STEEL.....	3
FORMICA .....	3
CARPET .....	3
RUBBER COMPONENTS .....	3
FLOOR CLEANING .....	3
EXTERIOR SURFACES.....	3
TAR OR OIL.....	4
INSECTS .....	4
TREE SAP.....	4
WINDOWS .....	4
WIPER BLADES.....	4
<b>FLUID LEVEL VERIFICATION.....</b>	<b>4</b>
ENGINE OIL LEVEL .....	4
TRANSMISSION OIL LEVEL .....	5
POWER STEERING FLUID LEVEL.....	7
COOLING FAN RIGHT ANGLE GEARBOX OIL LEVEL.....	7
DRIVE AXLE WHEEL BEARING OIL LEVEL.....	7
FRONT AND AUXILIARY AXLE WHEEL HUBS.....	7
COOLANT FLUID LEVEL.....	7
WINDSHIELD WASHER & HEADLIGHTS WASHER RESERVOIRS .....	8
<b>OTHER VERIFICATIONS .....</b>	<b>8</b>
AIR TANK PURGE .....	8
FIRE EXTINGUISHERS .....	9
FUEL FILTER / WATER SEPARATOR .....	9
FAN AND ALTERNATOR DRIVE BELTS .....	10
A/C COMPRESSOR BELT TENSION ADJUSTMENT .....	10
BACK UP CAMERA.....	11
AIR FILTER RESTRICTION INDICATOR .....	11
MAIN POWER COMPARTMENT FAN AIR FILTER .....	11
A/C AND HEATING SYSTEM AIR FILTERS .....	12
HOSE INSPECTION.....	12
LUBRICATION.....	13
WHEELS AND TIRES.....	13
WHEEL BEARINGS.....	13
SERVICE BRAKE TEST.....	13
PARKING BRAKE TEST .....	13
EXTERIOR LIGHTING VERIFICATION .....	13
<b>GENERAL RECOMMENDATIONS.....</b>	<b>16</b>
<b>FIRST SERVICE ON NEW VEHICLE .....</b>	<b>16</b>
ENGINE OIL .....	16
ALLISON TRANSMISSION FLUID FILTER .....	16
<b>WALK-AROUND INSPECTION (BEFORE EVERY TRIP) .....</b>	<b>20</b>

## 8-2 CARE AND MAINTENANCE

### CLEANING

The cleaning information provided in this section is regarded as recommended cleaning practices. Cleaning results may vary depending on the condition of the stain. Always clean stains promptly for best results.

#### *NOTE*

*Use only approved cleaning products such as Prevost A.P.C., all purpose cleaner (Prevost # 683664). Never use stain protection products on new fabrics. To prevent permanent staining of fabrics, clean stains soon after they occur. Incorrect treatment of stains can worsen them. Get help from a cleaning specialist to remove stubborn stains.*



#### CAUTION

Custom fabrics and materials may require different cleaning and maintenance practices. Consult your converter.

### SEAT UPHOLSTERY

Firmly beat the fabric with a blunt object, such as a wooden paddle, to release dust and dirt. Vacuum the seat fabric in the direction of the stitching using an upholstery nozzle.

#### *NOTE*

*The abrasive nature of dirt and grit will reduce upholstery life expectancy. Vacuum regularly.*

### Removal of stains and marks

Depending on the nature of the stain, apply one of the two methods explained below to remove stains and marks on wool plush.

#### Method One:

1. Apply a nonflammable solvent to stained area with a clean, white absorbent rag;
2. Clean stain by starting at the outer edges of the stain and working in toward the center;
3. Blot affected area frequently with a clean, dry absorbent cloth to prevent stain rings caused by excess solvent.



#### WARNING

Use solvents in a well ventilated area. Open all windows and doors.

#### Method Two:

1. Wet the stain with a solution of household detergent and lukewarm water. Do not soak the stain;
2. Rub the stain with a damp cloth;
3. Rinse cloth after each application.



#### CAUTION

Do not use soap, soap powder, ammonia, soda, bleach or cleaning products containing any of these compounds.

### Beverage stains

Remove beverage stains by following method one. If stain persists, repeat method one using methyl alcohol instead of solvent.

### Alcoholic beverage stains

Remove alcoholic beverage stains by wetting the stain with water, then cleaning following method two.

### Burns

Scrape burnt area using a knife or razor blade then clean following method two. Consult an upholstery specialist when dealing with extensive burns.

### Cosmetic stains

Remove stains left by cosmetics by following method one then method two.

### Ink stains

Remove ink stains following method two. If stain persists, apply a warm oxalic acid solution. Rinse with water.

### Blood, urine or vomit stains

Remove such stains by following method two.

**Copying ink - ball-point pen ink**

Treat with methyl alcohol, blotting frequently to avoid spreading stain, followed by method two.

**Marking ink (Felt-tip pens)**

Treat with Methyl-Ethyl-Ketone (MEK) followed by method two.

**Oil, grease and paint**

Remove excess using a knife. Treat with method one followed by method two. If stain persists, repeat procedure.

**Rust stains**

Remove rust stains by following method two. Apply a warm oxalic acid solution to stained area. Rinse with water.

**Tar**

Soften tar with benzene, then treat using method one followed by method two.

**Chewing gum**

Soften gum with cyclohexane. Carefully scrape off stains using a sharp knife or razor blade.

**PLASTIC AND VINYL**

Clean plastic and vinyl trim using a clean damp cloth or sponge. For vinyl trim marks, use a lukewarm all purpose cleaner or a mild saddle soap. Remove water spots and soap traces using a clean damp cloth or sponge. Dry with a clean soft cloth.

Remove grease, tar or oil stains with a clean cloth or sponge and an all purpose or solvent-type vinyl cleaner.

Apply a colorless vinyl or leather protective product to maintain the luster and pliability of the plastic or vinyl surface.

**WINDOWS**

Clean the inside of the windows with a solution of one part vinegar to ten parts water.

**STAINLESS STEEL**

Use a stainless steel cleaner and follow the manufacturer's instructions. Stainless steel cleaning solution may be ordered from Prevost Car Inc. quoting part number 68-0356.

**FORMICA**

Remove stains on formica surfaces with a household detergent, methyl alcohol or mineral turps. Clean with a mild abrasive and water solution if stain persists.

**CARPET**

Vacuum carpets regularly to prolong carpet life.

**RUBBER COMPONENTS**

Use only pure water or glycerin to clean stains on rubber components.

 <b>CAUTION</b>
Never use solvents on rubber components.

**FLOOR CLEANING**

Clean vinyl floors with a quality nonionic detergent cleaner. Follow the manufacturer's recommendations for cleaning.

Remove any excess detergent solution using a wet/dry vacuum or mop. Rinse floor with a solution of one part Clorox to ten parts warm water.

Polish dry floor using a high-speed buffer and a smooth red 3-M polishing pad.

Mop floor periodically with a solution of 5 per cent Clorox in warm water.

<b>NOTE</b>
<i>For custom or special floor covering materials, consult the manufacturer or your converter for information on how to clean and maintain these types of floors.</i>

**EXTERIOR SURFACES**

Frequent washing and waxing of the vehicle exterior will help protect the finish and luster. The paint finish is attacked by the abrasive

## 8-4 CARE AND MAINTENANCE

---

effects of airborne particles and corrosive pollutants.

Before washing the exterior of the vehicle, close the fresh air dampers using the "REC" button located on HVAC control panel and on the air intake duct in the evaporator compartment. Install keyhole protectors to prevent water from penetrating. Rinse vehicle with water to remove all loose dirt. Wash vehicle using a quality brand car wash soap. Follow manufacturer's recommendations for cleaning. Rinse well with water.

The vehicle exterior should be cleaned, waxed and buffed when water droplets no longer form on the painted surfaces.

 <b>CAUTION</b>
Hot water can damage paint. Keep water cool or lukewarm.

 <b>CAUTION</b>
Make sure cleaning solutions are not harmful to painted surfaces. Read the manufacturer's instructions before using.

 <b>CAUTION</b>
Do not spray water jet directly into fresh air inlet dampers.

 <b>CAUTION</b>
Do not aim high pressure water jet at radiator or condenser doors. This could damage the fins.

To prevent corrosion, remove caked-on dirt and road salt from the vehicle underbody using a high pressure water jet. Clean wheel housings, bumpers, muffler, tailpipe and brackets.

Carry out corrosion prevention cleaning at least twice a year. Spray underneath of the vehicle and let soak before cleaning. Let engine and exhaust system cool down before cleaning.

### TAR OR OIL

Remove tar or oil as soon as possible with an approved automotive tar and oil remover or

turpentine. Thoroughly clean area with car wash soap and water. Let dry, then wax.

### INSECTS

Remove insect stains as soon as possible with lukewarm soap and water or insect remover.

### TREE SAP

Remove tree sap or bird droppings with lukewarm soap and water. Do not allow to harden.

### WINDOWS

To prevent windshield wiper streaking, keep silicone sprays away from windshield. Remove road film and wax build-up from windows with lukewarm soap and water or with an alcohol-based cleaning agent. If a chamois is used to dry and polish glass, use it exclusively for that purpose.

### WIPER BLADES

To avoid tearing frozen wiper blades, loosen them before removing. Remove and clean wiper blades periodically with an alcohol-based cleaning solution. Clean wiper blades using a sponge or soft cloth.

### FLUID LEVEL VERIFICATION

Periodic inspection of fluid level is the most economical and easiest way to help your vehicle perform at its best. Rigorous fluid level inspection and replacement will greatly help minimize expensive and unscheduled repairs.

### ENGINE OIL LEVEL

Check engine oil level when engine is still warm and with vehicle parked on a level surface. Shut off engine and wait at least 10 minutes for oil to drain into oil pan before checking. Check engine oil level daily or before each trip. Add oil as required. Do not overfill. Remove dipstick, wipe clean and fully reinsert to ensure an accurate reading. Remove dipstick and check engine oil level.

**Do not** let the oil level fall below the marking on the dipstick. **Do not** overfill so the level is above the upper marking on the dipstick. Add oil



through the oil filler pipe as required in order to maintain level within the safe range

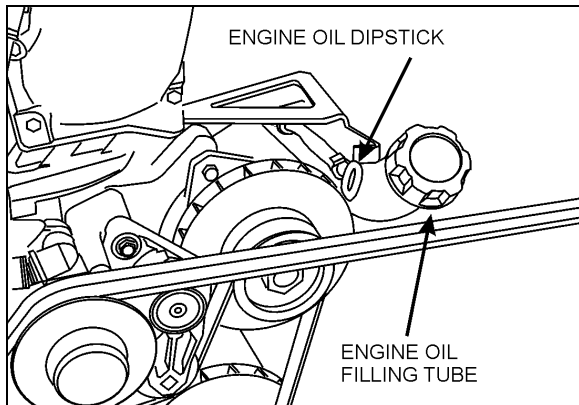

ENGINE OIL DIPSTICK

01192

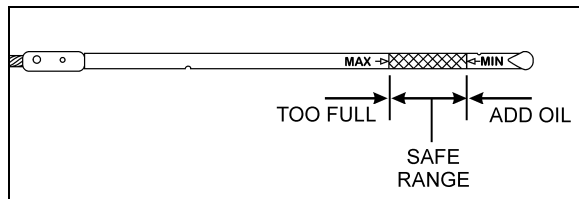

VOLVO D13 ENGINE OIL LEVEL DIPSTICK

01195

**TRANSMISSION OIL LEVEL**

The transmission fluid level can be checked with the dipstick or with the use of the shift selector display. For more information on how to use the shift selector display to check the transmission oil level, refer to *Appendix C* under "Allison transmission oil level check using the pushbutton shift selector" in this manual.

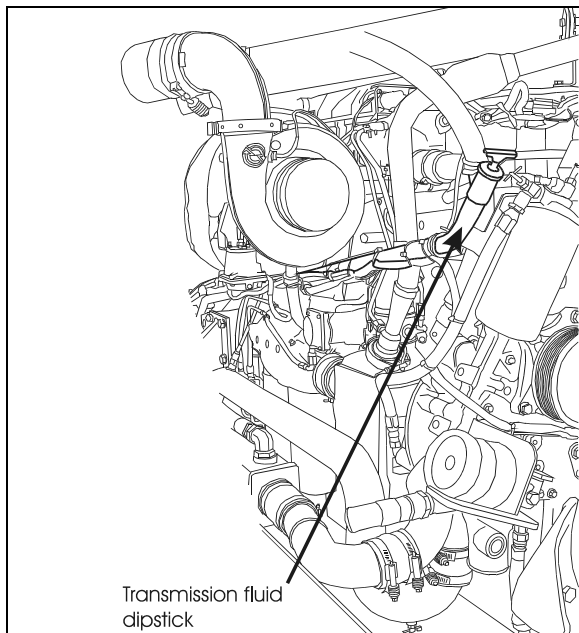

LEFT SIDE OF ENGINE

01121

The automatic transmission oil level dipstick is accessible through the engine compartment rear door and is located on the left side of the engine.

Clean all dirt from around the end of the oil filler tube before removing the dipstick. Dirt or foreign matter must not be permitted to enter the oil system since it will cause valves to stick, undue wear of transmission parts, and clogged passages. To remove dipstick, unscrew filler cap approximately three turns and pull out dipstick. Check the oil level using the procedures in Cold Check and Hot Check. Record any abnormal level on your Maintenance Records.



**WARNING**

When checking the oil level, be sure that the parking brake and/or emergency brakes are set and properly engaged, and the wheels are chocked. Unexpected and possible sudden vehicle movement may occur if these precautions are not taken.

Special care must be taken not to touch the engine coolant tubing and/or exhaust pipe, since this could cause severe burns.

Do not wear loose clothing and, stay away from rotating parts during procedure; personal injury could occur.

**NOTE**

*The Cold Check is more appropriate for verifying the oil level after the first fill-up. In case of conflict, the Hot Check has priority over the Cold Check; the fluid level check using the pushbutton shift selector has priority over the Hot Check.*

**Cold Check**

The purpose of the **Cold Check** is to determine if the transmission has enough fluid to be operated safely until a **Hot Check** can be made.

1. If the engine has been shut down for an extended period of time, park the vehicle on a level surface and apply the parking brake.
2. Run the engine at idle in «N» (Neutral) for about one minute.
3. Shift to «D» (Drive) and operate the engine for 30 seconds at 1000-1500 rpm; then shift to

## 8-6 CARE AND MAINTENANCE

«R» (Reverse) to clear the hydraulic system of air.

4. Move the vehicle to a level surface, put transmission in «N» (Neutral), and set the parking brake.
5. Finally shift to «N» (Neutral) and allow the engine to idle (500 - 800 rpm).
6. While the engine is running, remove the dipstick from the tube and wipe it clean. Insert the dipstick into the fill tube, pushing down until it stops.
7. Remove the dipstick and observe the fluid level. Repeat the check procedure to verify the reading. If the fluid on the dipstick is within the COLD CHECK band, the level is satisfactory for operating the transmission until the oil is hot enough to perform a **Hot Check**. If the fluid level **is not** within this band, add or drain fluid as necessary to bring the level within the COLD CHECK band.
8. Perform a **Hot Check** at the first opportunity after the normal operating temperature of 160°F to 200°F (71°C to 93°C) is attained.

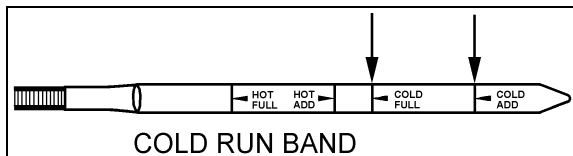

AUTOMATIC TRANSMISSION OIL LEVEL DIPSTICK 07006



### CAUTION

**DO NOT** operate the transmission for extended periods of time until a **Hot Check** has verified proper fluid level. Transmission damage can result from extended operation at improper fluid level conditions.



### CAUTION

Obtain an accurate fluid level by imposing the following conditions:

- Engine is idling (500-800 rpm) in «N» (Neutral).
- Transmission fluid is at normal operating temperature.
- The vehicle is on a level surface.



### CAUTION

The oil level rises as sump temperature increases. **DO NOT** fill above the Cold Run band if the transmission oil is below normal operating temperature. During operation, an overfull transmission can become overheated, leading to transmission damage.

### Hot Check

1. The **Hot Check** can be performed when the transmission oil reaches the normal operating temperature (160°F to 200°F / 71°C to 93°C). The transmission oil temperature can be checked with the dashboard message center display (MCD) when selecting the Gauge Mode.



### CAUTION

The oil **must be hot** to obtain an accurate check because the fluid level rises as temperature increases.

2. Park the vehicle on a level surface and shift to «N» (Neutral). Apply the parking brake and allow the engine to idle (500 - 800 rpm).
3. Remove the dipstick from the tube and wipe it clean. Insert the dipstick into the fill tube, pushing down until it stops.
4. Remove the dipstick and observe the fluid level. The safe operating level is anywhere within the HOT RUN band on the dipstick. Repeat the check procedure to verify the reading.
5. If the level **is not** within this band, add or drain fluid as necessary to bring the level within the HOT RUN band.
6. Be sure fluid level checks are consistent. Check level more than once and if readings are not consistent, check to be sure the transmission breather is clean and not clogged. If readings are still not consistent, contact your nearest Allison dealer or distributor.

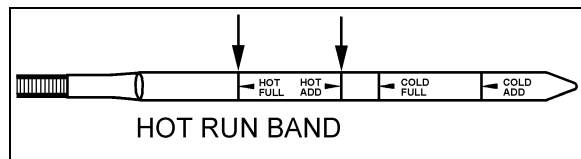

AUTOMATIC TRANSMISSION OIL LEVEL DIPSTICK 07006

**NOTE**

Approximately 1 quart (0.95 liters) of oil will raise the oil level from the lower line of the HOT RUN band to the middle of the HOT RUN band.

Replace dipstick and tighten the filler tube cap until the rubber seal is correctly seated.

**POWER STEERING FLUID LEVEL**

The vehicle is equipped with a power steering system. The hydraulic fluid tank is accessible by the engine compartment R.H. side door.

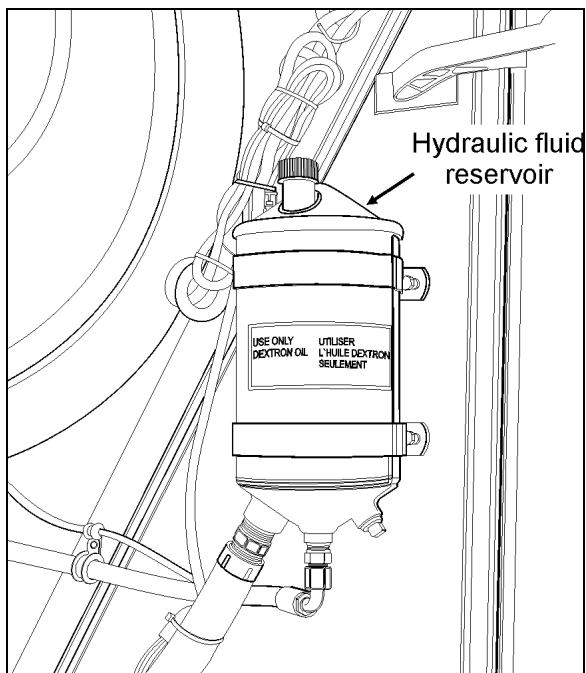

POWER STEERING HYDRAULIC FLUID TANK 14043

Check fluid level as follows:

1. Stop engine, open engine compartment R.H. side door and engine compartment door, place rear start switch to OFF position;
2. Unscrew and remove the dipstick located on top of the fluid tank and wipe with a clean rag;
3. Replace dipstick in tank, then remove to check fluid level;
4. Add hydraulic fluid until it reaches the FULL mark on the dipstick;
5. Place engine rear start switch to NORMAL position. Close engine compartment door;
6. Replace and tighten dipstick and close engine compartment R.H. side door.

**COOLING FAN RIGHT ANGLE GEARBOX OIL LEVEL**

Check cooling fan right angle gearbox oil level as follows:

1. Stop engine, open engine compartment door and place engine rear start switch to OFF position;
2. Remove side oil filler plug;
3. Add oil through the oil filling point if the oil level has fallen below the oil filling point;
4. The oil level is correct once the top of the oil has reached the bottom of the filling point or once oil has already started to escape from the filling point;
5. Replace the seal and screw the side filler plug back in;
6. Place engine rear start switch to NORMAL position. Close engine compartment door.

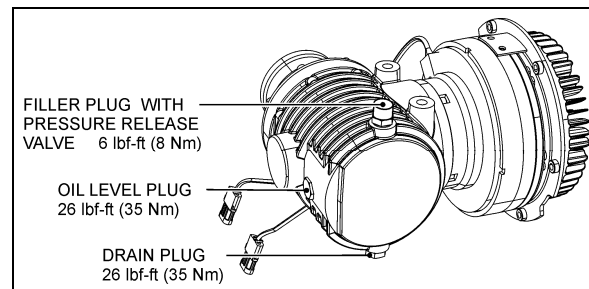

RIGHT ANGLE GEARBOX OIL LEVEL CHECK 05118

**DRIVE AXLE WHEEL BEARING OIL LEVEL**

Drive axle wheel bearings are lubricated by the differential oil. Maintain differential oil at correct level to ensure adequate lubrication of drive axle wheel bearings at all times.

**FRONT AND AUXILIARY AXLE WHEEL HUBS**

The unitized hub bearings used on the NDS range of axles, are non-serviceable items. Bearings are pre-adjusted, lubricated and have seals fitted as part of the manufacturing process. The bearings are greased for life and there is no need or facility for re-lubrication.

**COOLANT FLUID LEVEL**

Coolant level is correct when coolant reaches the middle of the surge tank sight glass when cold (ambient temperature). Fill the tank as necessary with the same 50/50 water-antifreeze mixture normally used. Do not mix two different types of coolant. Refer to the Maintenance

## 8-8 CARE AND MAINTENANCE

Manual for proper coolant type specifications or see the label affixed near the coolant surge tank on the vehicle.



### CAUTION

On Volvo D13 engine, use **only** Extended Life Coolant (ELC). **Do not** add supplemental coolant additives (SCA) to extended life coolant. **Do not** use a coolant filter containing Supplemental Coolant Additives (SCA).

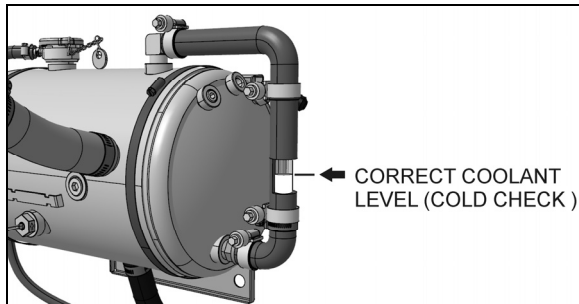

SURGE TANK IN ENGINE COMPARTMENT

05114\_3



### WARNING

Hot engine coolant is under high pressure. Allow engine to cool down before adding coolant.

### WINDSHIELD WASHER & HEADLIGHTS WASHER RESERVOIRS

The windshield washer reservoir and headlights washer reservoir are located in the front service compartment door. The windshield washer reservoir has a capacity of 5.3 US gallons (20 liters) while the headlights washer reservoir has a capacity of 2.6 US gallons (10 liters). Check fluid level regularly.

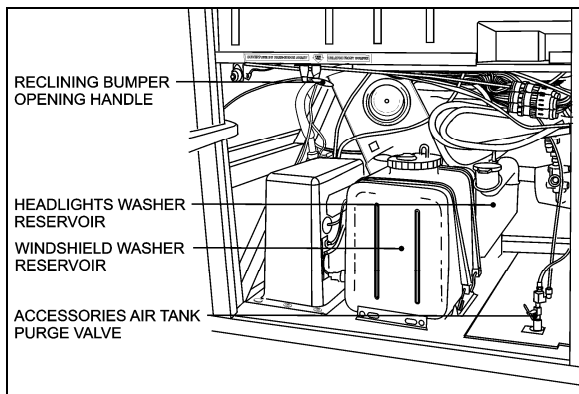

WINDSHIELD WASHER FLUID RESERVOIR

14066

The spray jets are located on the windshield wipers and are angled to spray towards the center of the windshield.

Upper and lower windshield wipers have separate controls and separate washer pumps which are connected to the same reservoir.

Adjust the headlights washer nozzles according to the instructions found in section 23 of the maintenance manual. You may use water or windshield washer fluid as well.



### CAUTION

During cold weather days, use windshield washer fluid suitable for freezing temperature only.

### OTHER VERIFICATIONS

It is good practice to regularly inspect the vehicle for signs of component wear and to perform safety and maintenance routines.

### AIR TANK PURGE

The vehicle may be equipped with up to twelve air tanks. Purge accessory and wet air tanks before each trip. The primary and secondary air tanks must be purged at least every 12,500 miles (20 000 km).

The accessory air tank drain cock is accessible from the front service and electrical compartment. The wet air tank drain cock is accessible from the engine compartment R.H. side door. All air tanks are equipped with a drain cock underneath the tank. Refer to "Components Identification" chart at the end of this chapter for tanks location.

Drain tanks by turning cocks counterclockwise.

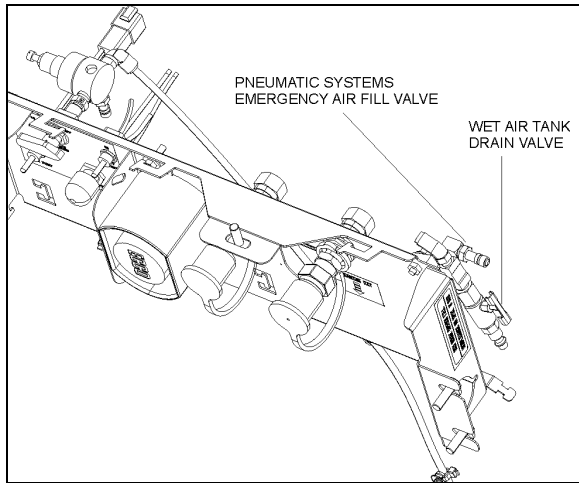

ENGINE COMPARTMENT

12219\_4

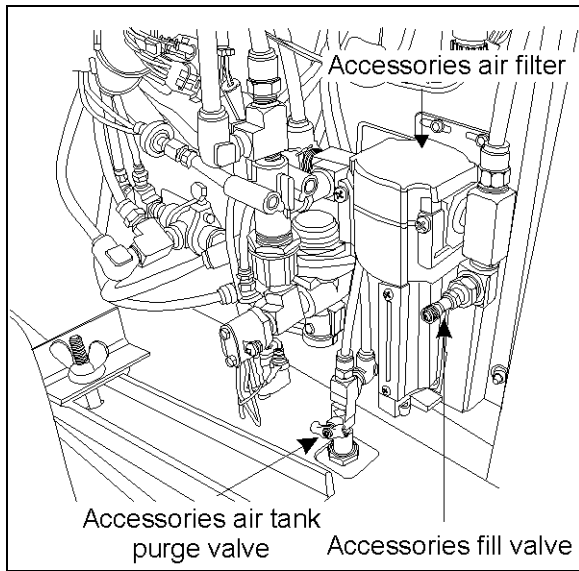

FRONT SERVICE COMPARTMENT

12130

### FIRE EXTINGUISHERS

Inspect fire extinguishers monthly to insure operation in emergency situations.

In the case of extinguishers equipped with a pressure gauge, the needle should be in the green or NORMAL range. Refill or replace extinguisher if pressure is below normal;

Check that seal on handle is intact;

Check that nozzle hose is in good condition and that nozzle is free of obstruction;

Keep fire extinguishers clean.

### FUEL FILTER / WATER SEPARATOR

The fuel system is equipped with primary and secondary fuel filters for additional protection of

the injectors. A fuel filter/water-separator may be installed in primary fuel-filter location, to prevent water infiltration in engine fuel system. It should be drained periodically, or when the water separator telltale light on the dashboard illuminates. To drain, loosen positive seal drain valve below separator, and tighten after water has been flushed out.

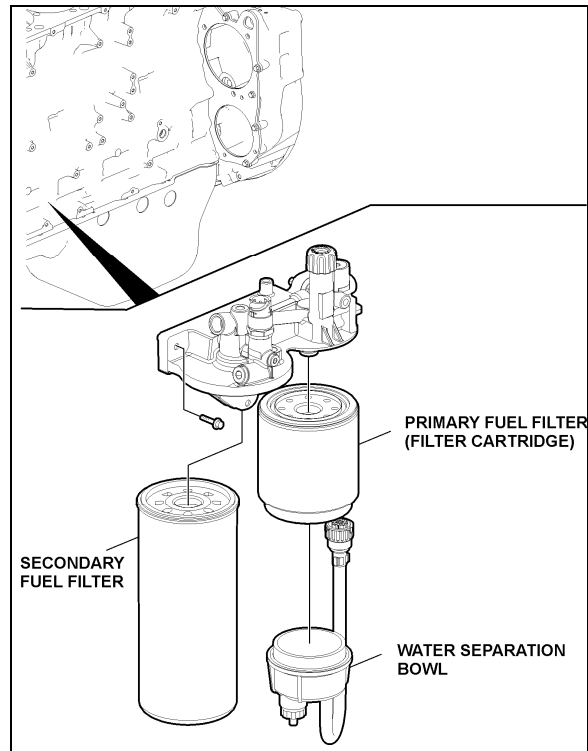

FUEL FILTERS

03085

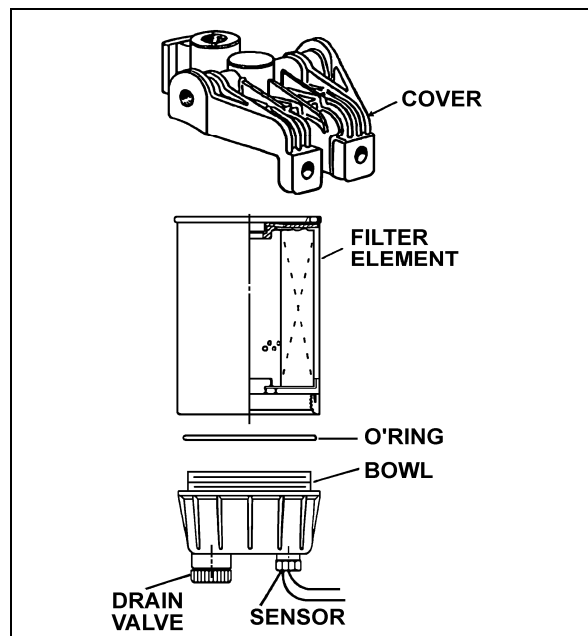

FUEL FILTER/WATER SEPARATOR

03025

## 8-10 CARE AND MAINTENANCE

The optional Fuel Pro 382 diesel fuel filter system consists of a permanently mounted fuel processor, a replaceable filter element, a filter element cover and collar and a fluid filter base assembly. This system is installed between the fuel tank and the fuel pump and replaces the primary fuel filter. The filter serves as a water separator as well as a fuel filter. To drain, turn ¼ turn the drain valve below filter, close when water has been flushed out.

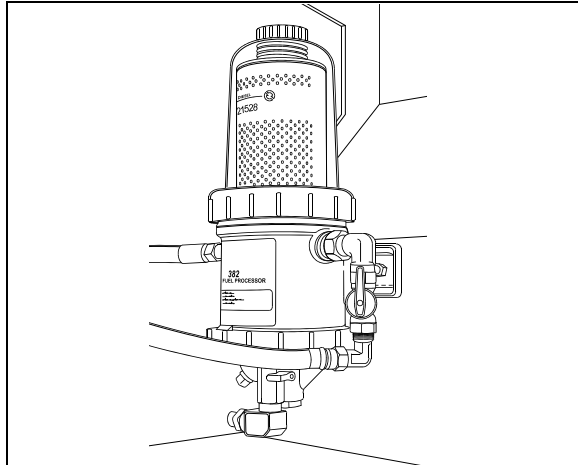

DAVCO FUEL PRO 382

03032

### FAN AND ALTERNATOR DRIVE BELTS

These belts have automatic belt tensioner to keep the correct tension without adjustment.

### A/C COMPRESSOR BELT TENSION ADJUSTMENT

#### With Central HVAC system

The central HVAC Bitzer compressor is driven by either one or two V-belts depending if a 3<sup>rd</sup> alternator is installed.

Belt tensioning is applied through the tensioner adjustment screw B. Loosen lock bolt A prior adjustment. Tighten lock bolt A to 43 lbf-ft once completed.

Belt tension should be within the following values:

Two v-belts arrangement	New belts: 90-100 lbs. Used belts: 75-85 lbs.
One v-belt arrangement	New belt: 150-160 lbs. Used belt: 120-130 lbs.

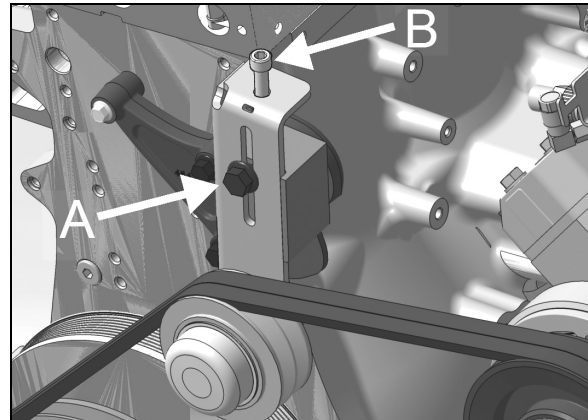

TWO V-BELTS ARRANGEMENT

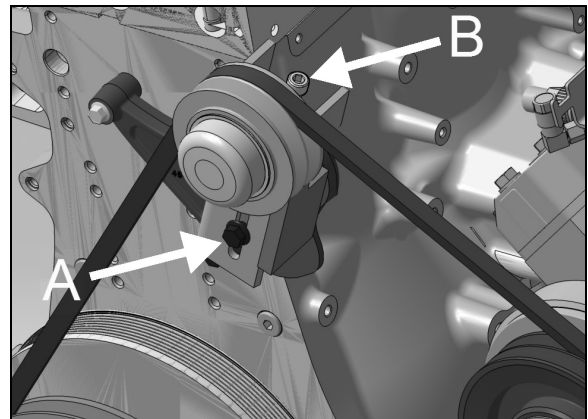

ONE V-BELT ARRANGEMENT

Check belt tension using a belt strand tension gauge..

- Once adjustment completed, allow the engine to run for about ten minutes. Check belt tension and adjust if needed.
- Do not treat belts with any compounds. Keep belts dry.
- Periodically inspect belt and pulleys for wear or damage;

### With Small HVAC System And Auxiliary Alternators

Intermediary belt tensioning is applied through an air bellows which is adjusted by an air pressure regulating valve mounted in the engine compartment, right behind the belt tensioning pressure control valve. The correct pressure of 45 psi (241 kPa) is set at the factory. Periodically verify the pressure at the regulating valve using a pressure gauge and correct if necessary.

To replace the intermediary belt, air pressure must be released from bellows by means of the belt tensioning pressure control valve. This valve, mounted close to the pressure regulating valve, is manually operated. Before handling, be sure that all engine stopping safety precautions have been observed.

Turn control valve handle counterclockwise to its initial position to reapply pressure to the air bellows.

- Refer to the Parts Manual or the Coach Final Record for recommended belt sizes;
- Periodically inspect belt and pulleys for wear or damage;
- Do not treat belts with any compounds. Keep belts dry.

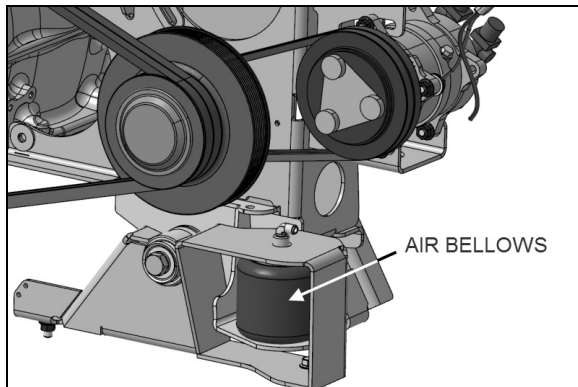

AIR BELLOWS

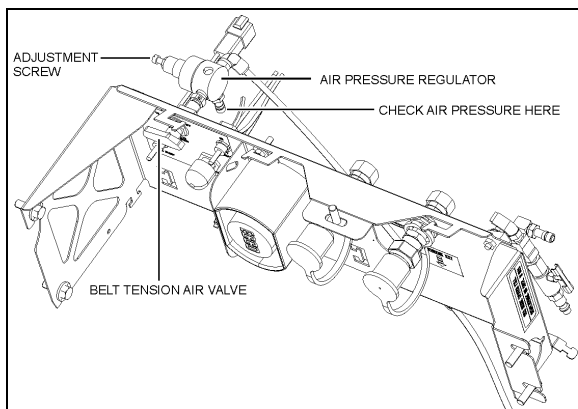

BELT TENSION AIR REGULATOR AND VALVE 12219\_5

**BACK UP CAMERA**

The optional back up camera is located on the rear cap. The retractable back-up camera is visible only when turned on. To do so, put the transmission in reverse (R). The back up camera and monitor are then turned on automatically. To clean the camera's protective

glass, spray with soapy water. Wipe with a clean damp rag or wiper blade.

**AIR FILTER RESTRICTION INDICATOR**

A filter restriction indicator is used to monitor the vacuum level between the air filter and engine. A red marker is displayed when the air filter is clogged. When a red marker is displayed, the air filter must be replaced. Reset by pressing on the indicator's extremity.

The filter restriction indicator is located on the engine air intake duct.

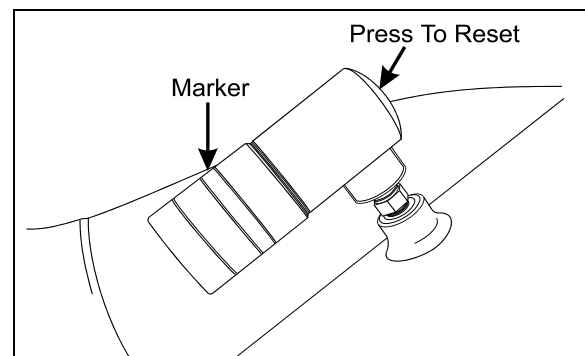

RESTRICTION INDICATOR

01052

**MAIN POWER COMPARTMENT FAN AIR FILTER**

For maximum service life of the electrical components, air filter should be inspected and cleaned as required in maintenance schedule to ensure proper ventilation and cooling of the main power compartment. Clean filter with an air jet in the opposite direction of normal air flow. Replace filter when necessary.

**CAUTION**  
Be sure not to reverse filter upon installation.

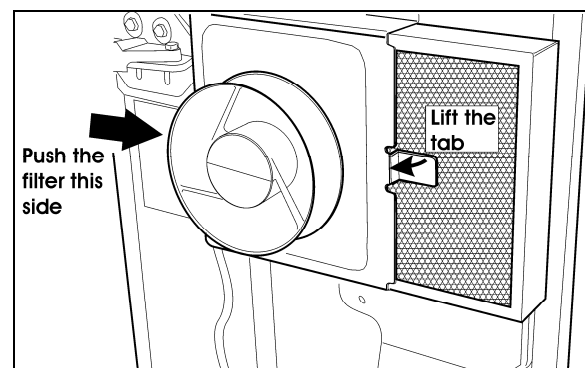

MAIN POWER COMPARTMENT FAN AIR FILTER REMOVAL

06603

## 8-12 CARE AND MAINTENANCE

### A/C AND HEATING SYSTEM AIR FILTERS

For maximum air conditioning and heating system efficiency, air filters should be inspected and cleaned as required in maintenance schedule to ensure proper ventilation of the evaporator and heating radiator cores. To clean filters, back flush with water, then dry with air.



#### CAUTION

Do not use high pressure water jet to avoid damaging filter.



#### CAUTION

Be sure not to reverse filter upon installation.

### Driver's Area Filters

The driver HVAC system's air filters are located behind the R.H. console. To gain access to the A/C filters, unscrew the grill located at the top step of the entrance door steps. Remove the filters for cleaning or replacement.

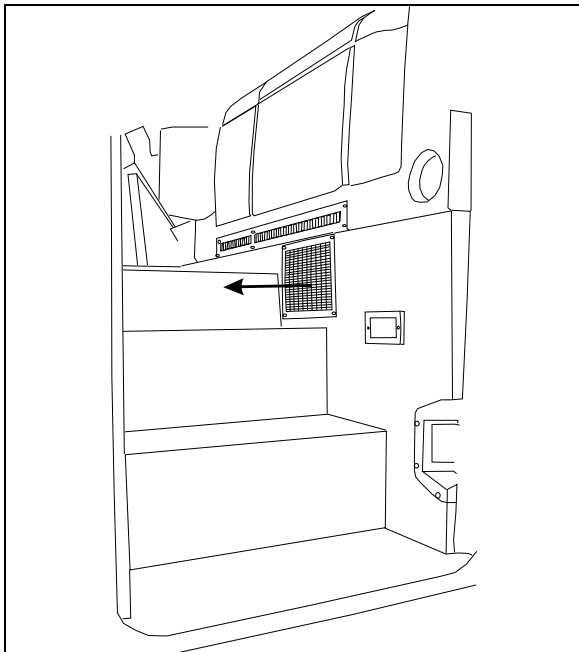

DRIVER'S AREA AIR FILTER REMOVAL

22231

### Cabin System Air Filter

The Central HVAC System's air filter is located in the evaporator compartment on L.H. side of the vehicle. To gain access, locate access panel in one of the baggage compartment adjacent to

the evaporator compartment. Open panel by unscrewing ( $\frac{1}{4}$  turn) the three screws of either panel, unsnap both fasteners on top of filter and slide out the filter for cleaning.



#### CAUTION

Be sure not to install filter in inverted position.

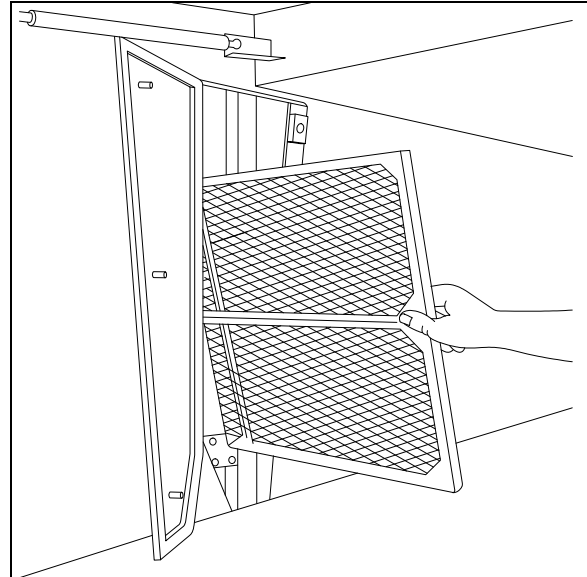

CABIN SYSTEM AIR FILTER REMOVAL

22178

### HOSE INSPECTION

Inspect hoses regularly to ensure efficient, economical and safe operation of the engine and related equipment.

Inspect hoses for leaks. Carefully inspect all fittings, clamps and ties. To prevent chafing, make sure hoses are not touching shafts, couplings, heated surfaces, sharp edges or other parts. Since hose clamps and ties can vibrate loose or fail over time, inspect frequently and tighten or replace as necessary.

Correct leaking hoses immediately. Failure to correct leaks can cause severe damage to the equipment, as well as increase operating costs due to lost fluids. Treat fuel and oil leaks as an immediate fire hazard.



#### WARNING

Fire hazard - personal injury and property damage may result from fire caused by leaking flammable fluids.



**Hose Service Life**

Hoses have a limited service life. Thoroughly inspect hoses annually. Look for surface damage or indications of twisted, worn, crimped, cracked or leaking lines. Replace damaged hoses immediately.

Hoses should be replaced during major overhaul or after a maximum of five years service. Make sure replacement hoses match the original equipment manufacturer's specifications.

**LUBRICATION**

Grease all lubrication points during scheduled maintenance. For heavy loads or extended use, lubricate more often. Refer to the end of this chapter or to Maintenance Manual, section 24 for information on lubrication.

**WHEELS AND TIRES**

Check for loose wheel nuts. Both aluminum alloy and steel wheel nuts should be tightened to 450 to 500 foot-pounds (610 to 680 Nm.) torque.

Keep the tires inflated to the recommended inflation pressure to prolong tire life and for safety.

<p><i><b>NOTE</b></i></p> <p><i>The cold tire inflation pressures are found on the DOT certification plate located under the L.H. console or behind the driver's seat.</i></p>
--

<p> <b>WARNING</b></p> <p>Do not exceed maximum inflation pressure. Incorrect tire pressure increases tire wear and could lead to loss of driving control because of reduced road handling. Check tire pressure regularly.</p>
---

**WHEEL BEARINGS**

Check wheel bearing cover for overheating (especially after brake work) during fuel stops by touching the wheel bearing cover.

**SERVICE BRAKE TEST**

Check for correct pressure build-up. Stop engine and check pressure gauge. Pressure loss should not exceed 3 psi/min (21 kPa/min) with engine stopped and without brake pedal

applied. Air loss should not exceed 7 psi/min (48 kPa/min) with engine stopped and brake pedal fully applied.

A convenient way to proceed to the service brake test is with the use of the DID menu "Air Leakage Monitor". For more information, refer to "Driver Information Display (DID) Menus" in *Other Features* chapter.

**PARKING BRAKE TEST**

Release parking/emergency brake. Pump service brake pedal until air pressure drops to 65 psi (448 kPa). Make sure the warning buzzer operates and that the emergency brakes apply (the control valve knob lifts up). Allow air pressure to reach 95 psi (655 kPa) before releasing parking brake.

Moving the vehicle while the parking brake is applied should not be possible.

**EXTERIOR LIGHTING VERIFICATION**

**Exterior Lighting Test Mode**

This useful function allows quick verification of the vehicle exterior lights.

**Activating the test mode:**

When the vehicle is stationary (parking brake applied), pull up the multi-function lever 3 times within 3 seconds to activate the test mode. This test can be done when the engine is not running providing that the battery charge is sufficient (above 24.0 volts).

The telltale panel alarm emits a sound each second to remind that the test mode is in progress.

<p><i><b>NOTE</b></i></p> <p><i>You can also initiate and stop the exterior lighting test mode with the use of the DID menu "Exterior Lamp Inspection". For more information, refer to "Driver Information Display (DID) Menus" in Other Features chapter.</i></p>
--

**Stopping the test mode:**

To stop the test mode, pull up the multi-function lever once or turn the ignition OFF or remove the parking brake.

## 8-14 CARE AND MAINTENANCE

---

### **NOTE**

*The test mode is useful to check the functioning of the multiplex outputs and the exterior lights. It doesn't test the functionality of the commands related to the exterior lighting. For a complete testing, the directional signal commands, the headlights commands and the brake pedal have to be checked before. Once these commands tested, activate the test mode to check the exterior lighting.*

### **Using the test mode:**

First, test the functionality of the commands related to the exterior lighting:

- Activate the right directional signal and check that the corresponding cluster telltale light illuminates.
- Activate the left directional signal and check that the corresponding cluster telltale light illuminates.
- Activate the hazard warning flashers and check that the corresponding cluster telltale lights illuminate.
- Press the headlights rocker switch in first position and confirm that the instrument panel illuminates. Press the headlights rocker switch in second position and confirm that the headlights illuminate.
- Turn on the high beams and check that the corresponding cluster telltale light illuminates.

Once these commands tested, activate the test mode to check the exterior lighting by pulling up the multi-function lever 3 times within 3 seconds.

Go to the front of the vehicle and check the lights:

- Left and right directional signals.
- Identification lights and clearance lights.
- Low beams.
- High beams.

Left side and right side of the vehicle:

- Directional signals.
- Marker lights.

Go to the rear of the vehicle:

- Directional signals.
- Identification lights and clearance lights.
- Stoplights and taillights.
- Back-up lights.

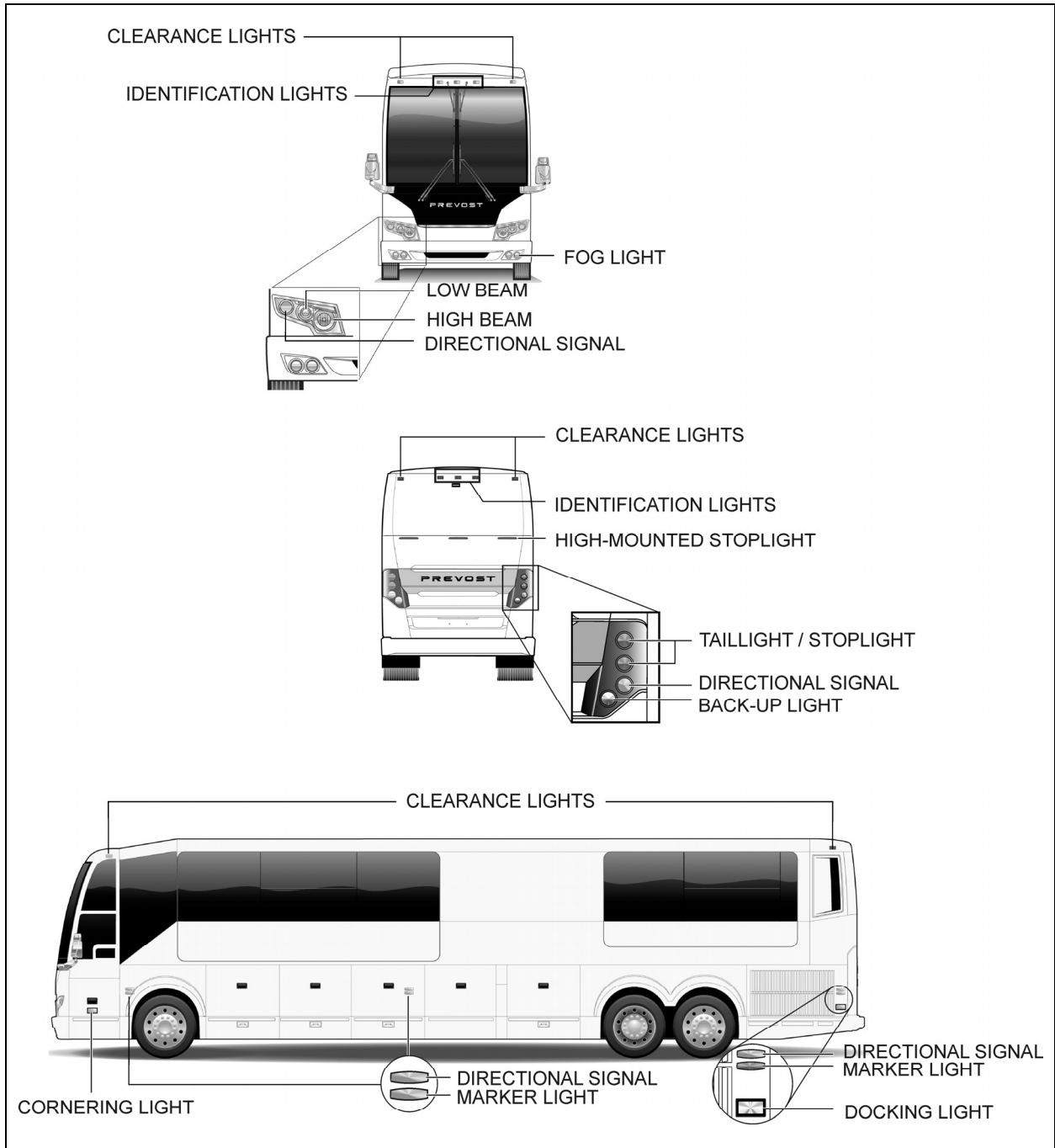

EXTERIOR LIGHTING IDENTIFICATION

### GENERAL RECOMMENDATIONS

- Understand basic principles of vehicle operation;
- Always maintain the vehicle in good running condition;
- Do not drive with low fuel. If the fuel tank runs dry, the engine will not start until the air is bled from the fuel system. Refer to "Maintenance Manual" for more information;
- Allow engine to run for at least two minutes at slow idle before shutting OFF;
- Engine should be at idle when shifting from neutral (N) to forward (D) or from neutral (N) to reverse (R);



### CAUTION

Fast idle should always be turned off before releasing the parking brake and putting the coach in gear. Driveline damage can result if the fast idle switch is always left on.

- The automatic transmission does not have a park (P) position. Place transmission in neutral (N) position and apply parking brake when the vehicle is stopped. A warning buzzer will sound if the engine is stopped and the parking brake has not been applied when foot pressure is removed from the brake pedal;
- Always follow the procedures described in this manual;
- Unless stated otherwise, shut off the engine before performing all servicing, lubrication and maintenance tasks;
- Do not attempt to push or pull-start the coach;
- Damage may result if towed with the axle shafts or driveshaft connected;
- Two chemical fire extinguishers are under the first row of passenger seats. In case of fire, immediately evacuate all occupants. Occupant safety is the first priority. Do not attempt to extinguish the fire if there is immediate danger or risk for personal injury;
- When driving on ice and snow, accelerate and decelerate gradually;



### WARNING

Report all problems affecting passenger or driver safety to a Prevost service center or an authorized service center. Have problems corrected immediately.

### FIRST SERVICE ON NEW VEHICLE

#### NOTE

Refer to Maintenance Manual for precise service schedule.

#### NOTE

If soldering has been performed on cooling system, clean strainer after 3,000 miles (5 000 km).

### ENGINE OIL

Preliminary oil change is not required since the engine has been test-run at the factory. Change oil and filter as specified in section 24 of the maintenance manual.

### ALLISON TRANSMISSION FLUID FILTER

Your Allison transmission is equipped with High Capacity filters, eliminating the requirement of an initial fluid and filter change. Refer to regular lubrication and servicing schedule.

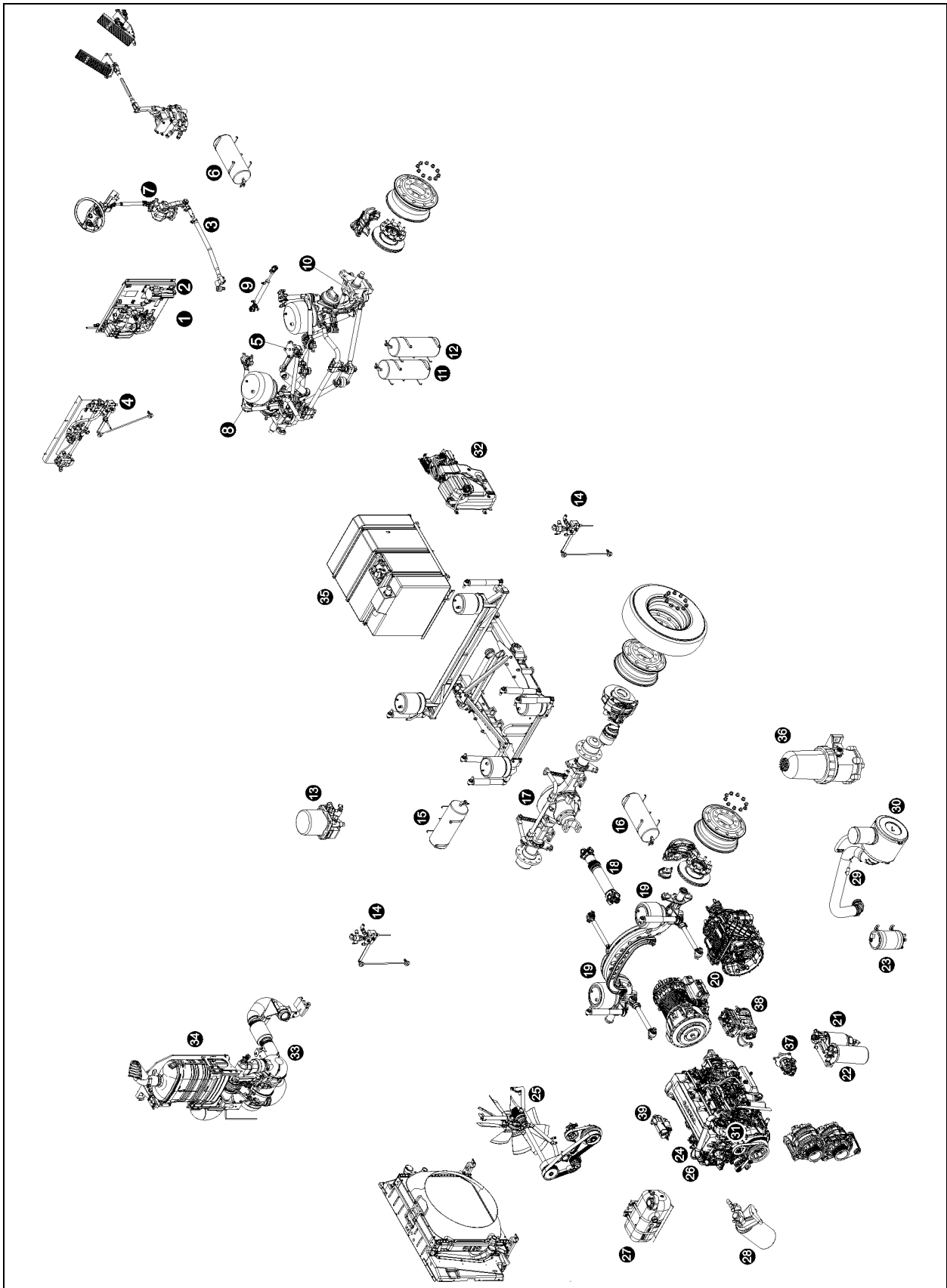

COMPONENTS IDENTIFICATION (components representation may differ slightly from the actual vehicle)

## 8-18 CARE AND MAINTENANCE

---

- |    |   |    |   |
|----|---|----|---|
| 1  | Accessories air tank drain cock         | 21 | Primary fuel filter                     |
| 2  | Accessories air filter                  | 22 | Secondary fuel filter                   |
| 3  | Steering drag link                      | 23 | Power steering fluid tank               |
| 4  | Height control valve (front)            | 24 | Engine oil filter                       |
| 5  | Bell crank                              | 25 | Cooling fan gearbox                     |
| 6  | Accessories air tank                    | 26 | Allison transmission oil dipstick       |
| 7  | Steering column U-joints                | 27 | Engine coolant surge tank               |
| 8  | Upper A-arm ball joint                  | 28 | Coolant filter & conditioner            |
| 9  | Hydraulic power cylinder                | 29 | Engine air filter restriction indicator |
| 10 | Steering king pin                       | 30 | Engine air filter                       |
| 11 | Emergency / parking brake overrule tank | 31 | Engine oil dipstick and filler tube     |
| 12 | Secondary air tank                      | 32 | DEF tank                                |
| 13 | Air dryer                               | 33 | Diesel particulate filter               |
| 14 | Height control valve (rear)             | 34 | SCR catalytic converter                 |
| 15 | Wet air tank                            | 35 | Diesel fuel tank                        |
| 16 | Primary air tank                        | 36 | Davco Fuel Pro 382 fuel filter          |
| 17 | Differential                            | 37 | Power steering pump                     |
| 18 | Propeller shaft                         | 38 | Air compressor                          |
| 19 | Auxiliary axle lever pivot              | 39 | Starter                                 |
| 20 | Transmission                            |    |   |

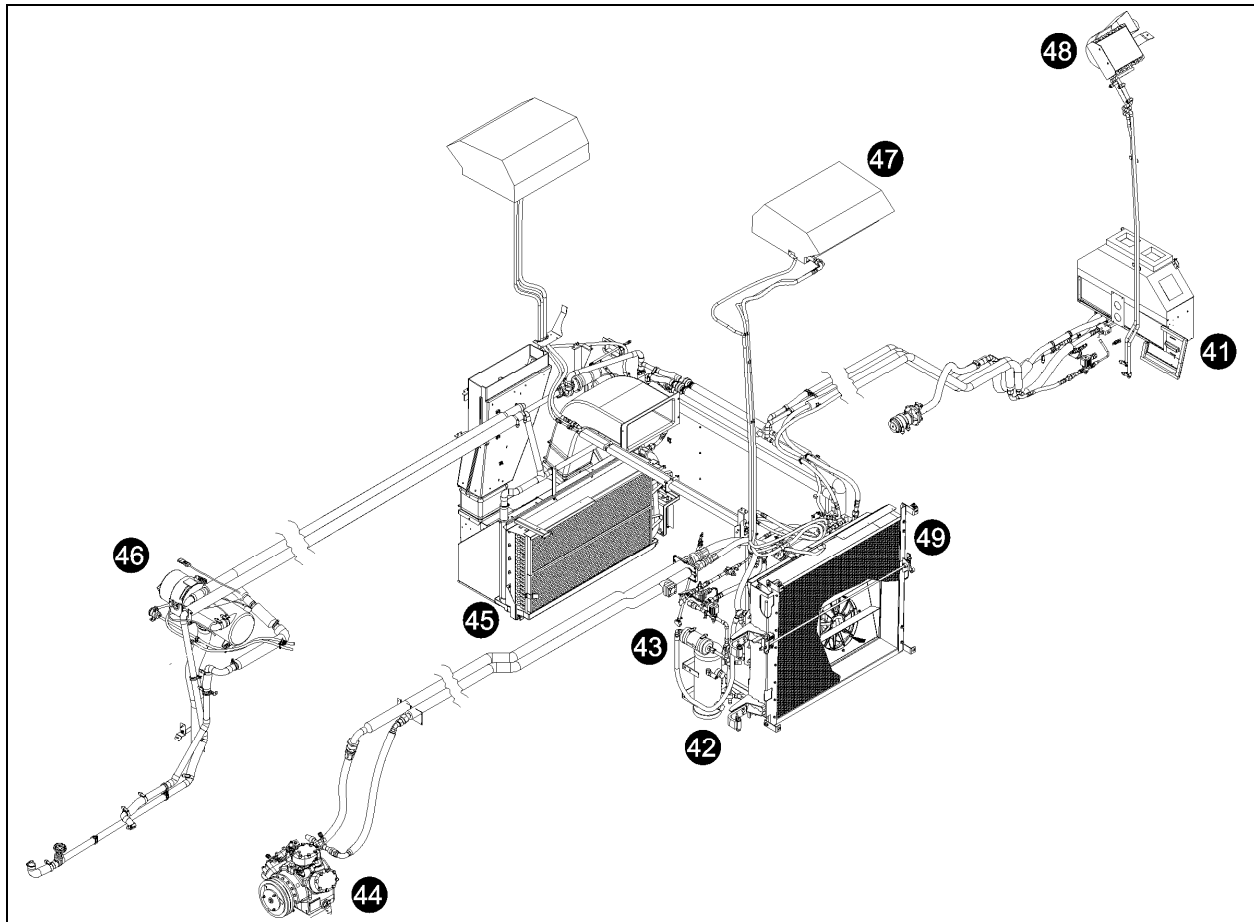

HVAC SYSTEM - MAIN COMPONENTS

24039\_3

- |    |                                    |    |   |
|----|------------------------------------|----|---|
| 41 | HVAC air filter – driver's unit    | 46 | Coolant preheater                         |
| 42 | A/C receiver tank                  | 47 | A/C system – passenger's overhead console |
| 43 | Refrigerant moisture indicator     | 48 | Upper windshield defrost unit             |
| 44 | A/C compressor                     | 49 | Condenser coil                            |
| 45 | HVAC air filter – passenger's unit |    |   |

## 8-20 CARE AND MAINTENANCE

### WALK-AROUND INSPECTION (BEFORE EVERY TRIP)

It is a good practice to make a basic visual inspection of key areas on the vehicle before every trip and to report any problem areas to your PREVOST service center or a PREVOST-authorized authorized service center.

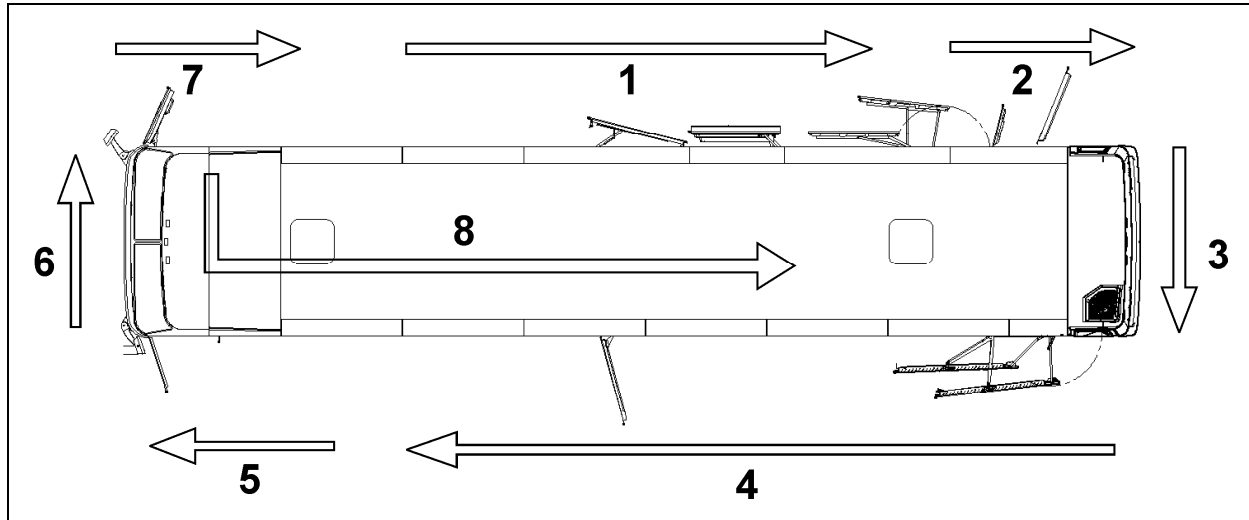

WALK-AROUND INSPECTION

18667

#### *NOTE*

*Inspect the coach in a circular manner as shown in the illustration.*

#### Approaching the Coach

- Check under the coach for oil, fuel or coolant leaks or other signs of damage.
- Check exterior body surfaces for signs of breaks or damage.
- Check condition of tires: properly inflated, no serious cuts, bulges, tread wear or any signs of misalignment; valve stems not touching wheels or rims; valve caps in place and no objects stuck between the wheels.

#### Preparation

- Start the engine and let the air pressure build up to normal. Stop engine.
- Switch on hazard warning flashers.
- Make sure parking brakes are applied.

#### Step 1: Right Side of the Coach

- Check that the vehicle is equipped with a wheel nut wrench, spare door keys, spare belts, reflectors and jack.
- Check that baggage doors and service compartment doors close properly. Check for good tightness and fit.
- Check condition of wheels and rims. Especially look for cracks, missing nuts, bent or broken studs.

#### Step 2: Engine Compartment Right Side Area

- Drain wet air tank by opening drain cock. Close drain cock when completed.
- Check engine and surrounding areas for coolant, oil and fuel leaks.
- Check primary fuel filter/water separator and drain if necessary. Close drain valve after draining.
- Check power steering reservoir fluid level, add if necessary.
- Check wiring harness for signs of damage.

#### Step 3: Engine Compartment

- Check engine and surrounding areas for coolant, oil and fuel leaks.



- Check wiring harness for signs of damage.
- Check for loose, worn or broken belts.
- Check belts tension adjustment.
- Check engine crankcase oil level, add if necessary.
- Check Allison transmission fluid level (can also be checked from push-button shift selector), add if necessary.
- Check coolant surge tank fluid level, add if necessary.
- Check air cleaner restriction indicator, replace air cleaner when red signal locks in full view.
- Check stop light, tail light, directional signal light and back-up light assembly, they should be clean.

**Step 4: Rear Left Side of the Coach**

- Check condition of wheels and rims. Especially look for cracks, missing nuts, bent or broken studs.
- Check that baggage doors and service compartment doors close properly, check for good tightness and fit.
- Check condition of tires: properly inflated, no serious cuts, bulges, tread wear or any signs of misalignment; valve stems not touching wheels or rims; valve caps in place and no objects stuck between the wheels.

**Step 5: Front Left Side of the Coach**

- Check condition of wheel rim. Especially look for cracks, missing nuts, bent or broken studs.
- Check condition of tire: properly inflated, no serious cuts, bulges, tread wear or any signs of misalignment; valve stem not touching wheel or rim; valve cap in place.
- Check windshield and headlights washer reservoir fluid level and add if necessary.
- Drain accessory air tank by opening drain cock. Close drain cock when completed.

**Step 6: Front of the Coach**

- Check for damage and clean if dirty.
- Check windshield wiper arms for proper spring tension.
- Check wiper blades for any damage, "dead" rubber and attachment to arm.
- Check clearance and identification lights, they should be clean.
- Check high and low beams, they should be clean. If equipped, check fog lights.
- Check left and right directional signals, they should be clean.
- Check to see that there is no mud, snow, ice build-up or other obstruction in front of the ACB radar sensor if applicable.

**Step 7: Front Right Side of the Coach**

- Check condition of wheel rim. Especially look for cracks, missing nuts, bent or broken studs.
- Check condition of tire: properly inflated, no serious cuts, bulges, tread wear or any signs of misalignment; valve stem not touching wheel or rim; valve cap in place.

**Step 8: Inside the Coach**

- Check for proper operation of the entrance door.
- Check steps; clean them if there is any substance that makes them slippery, which makes coach entry/exit hazardous.
- Adjust and clean mirrors for adequate rear view vision.
- Verify proper operation of windshield wiper/washer.
- Check for fire extinguishers to make sure they are ready for operation.
- Check that emergency exit windows and roof escape hatches can be opened then close all windows and hatches securely

## 8-22 CARE AND MAINTENANCE

---

### With engine running

- Start engine and check for proper operation of all gauges. Perform a telltale light test (see “CONTROLS AND INSTRUMENTS” chapter). Indicator lights and buzzers should all be OFF before driving.
- Using the message center display, perform a system diagnostic to check if error codes and anomalies were recorded in the vehicle electronic modules.
- Check for proper operation of electric and air horns and back-up alarm.
- Check automatic transmission oil level, using the pushbutton shift selector (see APPENDIX C).
- Check that there is enough fuel in the tank.
- Perform a parking brake test. Check both primary and secondary pressure gauges. Refer to “OTHER VERIFICATIONS” in this chapter.
- Perform the exterior lighting verification using the test mode. Refer to “Other Verifications” in this chapter.
- Walk around the vehicle and listen for air leaks.
- Check for leaks and listen for unusual sounds coming from the turbocharger.

## SECTION 9 TECHNICAL INFORMATION

<b>DIMENSIONS AND WEIGHTS</b> .....	<b>3</b>
<b>CAPACITIES</b> .....	<b>3</b>
<b>FUEL TYPE</b> .....	<b>3</b>
BIODIESEL FUELS .....	3
<b>WHEELS AND TIRES</b> .....	<b>4</b>
RECOMMENDED TIRE INFLATION PRESSURE AT MAXIMUM COLD LOAD .....	4
<b>BELTS</b> .....	<b>4</b>
<b>ENGINE</b> .....	<b>5</b>
VOLVO D13.....	5
<b>ALLISON TRANSMISSION</b> .....	<b>5</b>
<b>PROPELLER SHAFT</b> .....	<b>5</b>
<b>BRAKES</b> .....	<b>5</b>
BRAKE CHAMBER EFFECTIVE AREA.....	5
<b>AIR SYSTEM</b> .....	<b>5</b>
<b>ANTILOCK BRAKING SYSTEM (ABS)</b> .....	<b>5</b>
TROUBLESHOOTING AND TESTING .....	5
<b>AUTOMATIC TRACTION CONTROL (ATC) – ELECTRONIC STABILITY CONTROL (ESC)</b> .....	<b>6</b>
<b>STEERING</b> .....	<b>6</b>
<b>ELECTRICAL SYSTEM</b> .....	<b>6</b>
<b>AXLES</b> .....	<b>6</b>
FRONT AXLE.....	6
DRIVE AXLE .....	6
AUXILIARY AXLE.....	7
<b>SUSPENSION</b> .....	<b>7</b>
INDEPENDENT FRONT SUSPENSION.....	7
DRIVE AXLE .....	7
AUXILIARY AXLE.....	7
<b>ALIGNMENT SPECIFICATIONS</b> .....	<b>7</b>
<b>COOLING SYSTEM</b> .....	<b>7</b>
<b>FUEL SYSTEM</b> .....	<b>7</b>

## 9-2 TECHNICAL INFORMATION

---

<b>EXHAUST SYSTEM.....</b>	<b>8</b>
<b>HEATING AND AIR CONDITIONING.....</b>	<b>8</b>
<b>OIL SPECIFICATIONS .....</b>	<b>8</b>
ENGINE .....	8
ALLISON TRANSMISSION .....	9
DIFFERENTIAL.....	9
COOLING FAN RIGHT ANGLE GEARBOX .....	9
POWER STEERING RESERVOIR.....	9
<b>PLATES AND CERTIFICATION .....</b>	<b>9</b>
SAFETY CERTIFICATION .....	9
DOT CERTIFICATION PLATE.....	10
VEHICLE IDENTIFICATION NUMBER (VIN).....	10
<b>COACH FINAL RECORD .....</b>	<b>10</b>

DIMENSIONS AND WEIGHTS	
Overall length (over bumpers)	45' 8" (13.9 m)
Overall width	102" (2.59 m)
Overall height (normal ride height)	149" (3.785 m)
Wheelbase (center of front axle to center of drive axle)	316 1/4" (8.033 m)
Floor height from ground	63" (1.6 m)
Ground clearance	11" (280 mm)
Step height from ground	14" (356 mm)
Headroom	83" (1.956 m)
Entrance door opening width	28" (711mm )
Front overhang	76" (1,93 m)
Rear overhang	108 1/4" (2.749 m)
Front track	84.4" (2.145 m)
Drive track	76.7" (1.949 m)
Rear track (auxiliary axle)	83.6" (2.124 m)
Turning circle radius	42' (12.8 m)
Curb weight (before conversion)	31 990 lbs (14 540 Kg)
Gross Vehicle Weight Rating (G.V.W.R.)	55 500 lbs (25 174 kg)
Front axle Gross Axle Weight Rating (G.A.W.R.)	19 000 lbs (8 618 kg)
Drive axle G.A.W.R.	22 500 lbs (10 230 kg)
Auxiliary axle G.A.W.R.	14 000 lbs (6 365 kg)

**NOTE**  
*Curb weight is given as an indication only and is subject to vary from coach to coach, mostly due to optional equipment.*

The Gross Vehicle Weight Rating (G.V.W.R.) and the Gross Axle Weight Rating (G.A.W.R.) for front, drive and auxiliary axles are listed on a certification plate located on the L.H. control panel in driver's section.

CAPACITIES	
Engine oil (in crankcase)	38 quarts 36 liters
Fuel tank (legal capacity equal to 95% of volume)	230 US gal. 870 liters
DEF tank	16 US gal. 60 liters
Cooling system	27.6 US gal. 104 liters
Allison transmission (does not include external circuit)	6 US gal. 23 liters
Differential oil	5 US gal. 19 liters
Power steering reservoir	4 US qts 3.7 liters
Carrier 05G A/C compressor oil	6.3 US pints (3 liters)
Windshield washer reservoir	5 US gal. (19 l)
Refrigerant	24.1 lbs (11 kg) 6 lbs (2.75 kg) small A/C

**FUEL TYPE**

Diesel engines for 2010 and later model year vehicles are designed to operate only with **Ultra Low Sulfur Diesel** (ULSD) fuel, which can contain no more than 15 ppm sulfur.

	<p><b>CAUTION</b></p>
<p>ULSD fuel is necessary to avoid fouling the engine's Aftertreatment Device (ATD). Use of fuel other than ULSD will reduce the efficiency and durability of the engine.</p>	

**BIODIESEL FUELS**

Biodiesel up to a maximum of 20% blend (B20) may be used and will not affect the manufacturers mechanical warranty as to engine and emissions system related components, provided the biofuel used in the blend conforms to ASTM D6751, B1 to B5 blends conform to ASTM D975, and B6 to B20 blends conform to ASTM D7467. Also, any engine performance problem related to the use of biodiesel fuel

## 9-4 TECHNICAL INFORMATION

would not be recognized nor considered as Volvo or Prevost's responsibility.

However, Volvo engines are certified to comply with U.S. EPA and California emissions standards based upon the use of test fuels with specifications established by these regulatory agencies. Alternative fuels, including biodiesel, that are not substantially similar to the required test fuels may adversely affect engine emissions compliance. As a result, Volvo does not warrant the engine will conform to applicable Federal or California emissions limits when operated on biodiesel or other alternative fuels that are not substantially similar to specified test fuels used for certification.

Additional maintenance is required and is covered in Section 03: FUEL SYSTEM of the maintenance manual.

### WHEELS AND TIRES

Drive Axle Aluminum forged wheels... 9" X 22½"

Drive Axle Super Single Aluminum forged wheels ..... 14" X 22½"

Drive Axle Tires ..... 315/80 R 22½"

Drive Axle Super Single Tires .... 455/55 R 22½"

Auxiliary & Front Axle Aluminum forged Wheels ..... 10½" X 22½"

Auxiliary & Front Axle Tires ..... 365/70 R 22½"

### RECOMMENDED TIRE INFLATION PRESSURE AT MAXIMUM COLD LOAD

The recommended tire inflation pressures are given in the applicable documents supplied with the vehicle. In addition, cold tire inflation pressures are listed on the Department of Transport (DOT) certification plate, affixed on the wall behind the driver's seat.

#### NOTE

Bus Shells vehicles, before being converted, are not at their maximum weight and tire pressures are adjusted at lower level than the maximum allowed appearing on the DOT plate. Tires pressure must be re-adjusted once converted.

Vehicles equipped with TPMS: The TPMS target pressures are factory set to equal the prevailing tire pressure at delivery time. When tire pressures are increased to account for higher

vehicle weight, the TPMS set point need to be increased accordingly.



### WARNING

Special tire selection may lower maximum allowable speed limit, even below posted speed limit. For maximum safety, check with tire manufacturer.



### CAUTION

These tire pressures are established in accordance with the maximum allowable load on each axle. A lower pressure is recommended if the axle load is less than the above specifications. Weigh vehicle fully loaded and pressurize according to tire manufacturer's recommendations. For nonstandard tire and wheel specifications, see Prevost tire pressure tabulation in "Coach Final Record" or special specification chart affixed next to the DOT certification plate.

### BELTS

With high capacity Bitzer compressor

Use	Model	Qty
Cooling fan drive	Poly-V 14PK2213	1
Coolant pump	Poly-V 10PK1512	1
2 HD10 alternators 28V, 120 Amps.	Poly-V 8PK1575	1
1 HD10 alternator "limp-home" mode	Poly-V 8PK1512	1
A/C compressor	5VX810	1
3rd alternator (short)	8PK855	1
3rd alternator (on crankshaft pulley)	5VX918	1

With small A/C compressor

Use	Model	Qty
Cooling fan drive	Poly-V 14PK2213	1
Coolant pump	Poly-V 10PK1512	1
2 HD10 alternators 28V, 120 Amps.	Poly-V 8PK1587	1
1 HD10 alternator "limp-home" mode	Poly-V 8PK1524	1
A/C compressor	AX32	2
Drive belt (from crankshaft pulley to auxiliary alternators and compressor intermediary drive)	5VX950	2
3 <sup>rd</sup> alternator	8PK855	1
3 <sup>rd</sup> & 4 <sup>th</sup> alternators	8PK1080	1

**NOTE**  
Belts specifications may vary. For proper belt selection, always consult your vehicle Coach Final Record.

**ENGINE**

**VOLVO D13**

Type: 4 cycles / inline six cylinders  
 Displacement: 12.8 liters, SOHC, 4 valves per cylinder  
 Power ..... 500 HP  
 Torque ..... 1770 lbf-ft  
 Recom. cruise speed range..... 1300-1500rpm  
 Full dress, dry weight..... 2519 lb

**ALLISON TRANSMISSION**

Allison MH4000 electronically controlled six speed automatic transmission.

**Gear Ratios**

1 <sup>st</sup> .....	3.510
2 <sup>nd</sup> .....	1.906
3 <sup>rd</sup> .....	1.429
4 <sup>th</sup> .....	1.000
5 <sup>th</sup> .....	0.737
6 <sup>th</sup> .....	0.639
Reverse .....	4.801
Converter .....	1.9

**PROPELLER SHAFT**

Dana SPL250

**BRAKES**

The features of the braking system include a dual system where the front and rear circuits are completely independent from each other. The brakes are Knorr SN7000 ventilated pneumatic disc brake type with ABS and automatic slack adjusters on front drive and auxiliary axles. Model 24/24 spring brakes on drive axle provide emergency and parking brakes. Emergency brake application will be automatic if pressure drops below 40 psi. At 60 psi a warning light and buzzer will come on so the driver can bring the vehicle to a safe stop simply by a conventional application of the foot brake pedal.

**BRAKE CHAMBER EFFECTIVE AREA**

Front axle (IFS).....	24 in <sup>2</sup>
Front axle (I-Beam).....	24 in <sup>2</sup>
Drive axle ....	24 in <sup>2</sup> service, 24 in <sup>2</sup> emerg/parking
Auxiliary axle.....	16 in <sup>2</sup> (service)

**AIR SYSTEM**

Compressed air is provided by a twin cylinder 31.8 cfm Wabco, gear-driven, water-cooled and engine oil lubricated air compressor.

**ANTILOCK BRAKING SYSTEM (ABS)**

The antilock braking system has one Electronic Control Unit (ECU) controlling a four channel system. A wheel slip sensor is mounted at each front axle and drive axle wheel. The a axle wheels are slave to the drive axle wheels.

The Electronic Control Module (ECM) is maintenance free. Its operating voltage is 24 ± 6 volts DC. The thermal operating range for the ECM is from -40 to 167°F (-40 to 75°C).

The solenoid control valves are maintenance free. Their operating voltage is 24 (+4.8, -2.4) volts DC. The rated current draw is 1.65 amps. The thermal operating range of the solenoid control valves is from -40 to 176°F (-40 to 80°C).

**TROUBLESHOOTING AND TESTING**

For troubleshooting and testing of the vehicle's anti-lock braking system, refer to Meritor-WABCO Maintenance Manual MM-0112 "Anti-Lock Braking System For Trucks, Tractors and

## 9-6 TECHNICAL INFORMATION

---

Buses" or use menu "Diagnostics" of the DID (see "Driver information display menus" in *Other Features* chapter).

### AUTOMATIC TRACTION CONTROL (ATC) – ELECTRONIC STABILITY CONTROL (ESC)

In addition to the ABS function, vehicle may be equipped with an advanced model of Bendix EC-60 controller to provide an **Automatic Traction Control (ATC)** feature. Bendix ATC can improve vehicle traction during acceleration, and lateral stability while accelerating through curves. ATC utilizes **Engine Torque Limiting (ETL)** where the ECU communicates with the engine's controller and/or **Differential Braking (DB)** where individual wheel brake applications are used to improve vehicle traction.

The EC-60 advanced model controller also provides ABS-based stability features referred to as **ESC® Electronic Stability Control**.

Refer to Maintenance Manual, Section 12: Brake and Air System for more information on this system.

 <b>WARNING</b>
<b>ESC may reduce the vehicle speed automatically.</b> ESC can make the vehicle <b>decelerate automatically</b> . ESC can slow the vehicle with or <b>without the operator applying the brake</b> , and <b>even when the throttle is being applied</b> .

 <b>CAUTION</b>
Even with ESC-equipped vehicles, the driver remains responsible for ensuring vehicle stability during operation.

### STEERING

ZF 8098 integral steering gear model.

- Variable assistance in function of speed is optional.
- ZF servocomtronic integral steering gear model.
- ZF hydraulic pump gear driven from engine drive.

- Hydraulic reservoir and dipstick accessible from engine compartment.
- System pressure 2320 psi.
- Steering wheel diameter 17 3/4". Tilt and telescopic, pneumatically locked with foot operated switch for adjustment.
- Number of turns: 5¾.
- Outside turning radius: see Dimensions and Weight.

### ELECTRICAL SYSTEM

- 24 volt, negative ground;
- 12 volt exterior lighting;
- Four 12 volt, group 31 format maintenance-free batteries connected in series/parallel. Cold cranking capacity is 1900 amps with a reserve capacity of 195 minutes;
- Three manually operated circuit breakers located in the battery compartment can be tripped to cut low current direct loads and help preserving minimal charge when parked for a long period.
- 100 amp battery equalizer;

### AXLES

#### FRONT AXLE

- Prevost independent front suspension with recalibrated air springs for improved comfort.
- 19,000 lbs capacity (loading limit could be less depending on wheel and tire selection).
- Wide apart double A-arm design mounted on ball joints with torque link.
- Double sealed taper roller bearings bell crank and idler steering arm.
- Unitized wheel bearing (maintenance free bearing).
- Factory pre-adjusted caster.

#### DRIVE AXLE

- Meritor model RC23-165.
- Full floating banjo type.
- Induction hardened bearing journals for greater durability.
- Oil lubricated wheel bearing.
- Axle ratio 4.30 to 1 for optimized fuel economy at 65 mph (standard).
- Proposed ratios: 4.56 for performance.
- Differential ratios: Suggested standard 4.30. Option with Allison B500: 3.42, 4.10.



**AUXILIARY AXLE**

- Prevost hollow square beam.
- Unitized wheel bearings (maintenance free).
- Auxiliary axle may be lifted to provide better traction in snow and mud.

**SUSPENSION**

Goodyear rolling lobe type air springs (bellows) are used throughout.

**INDEPENDENT FRONT SUSPENSION**

- 2 14-inch Bellows for a G.A.W.R. of 19,000 lb;
- 2 Shock absorbers;
- 2 Upper A-arms;
- 2 Lower A-arms;
- 1 Height control valve;
- 1 sway bar (1¾" diameter).

**DRIVE AXLE**

- 4 Bellows (11");
- 4 Shock absorbers;
- 3 Radius rods;
- 2 Height control valves;
- 1 Panhard rod
- 1 Anti-roll bar, 2" diameter

**AUXILIARY AXLE**

- 2 Bellows (12");
- 2 Shock absorbers;
- 3 Radius rods;
- 1 Panhard rod.

**ALIGNMENT SPECIFICATIONS**

Use static wheel alignment systems which work with angle measurements only, such as Josam or Hunter systems. Static alignment specifications are listed in the following tables:

AUXILIARY AXLE			
	Minimum value	Nominal value	Maximum value
Thrust angle *	-0.02°	0°	0.02°
Total toe	0.08° toe-in	0°	0.02° toe-out

(\*) Use the drive axle as reference

DRIVE AXLE			
	Minimum value	Nominal value	Maximum value
Thrust angle	±0.11°		

Total toe	0.18° toe-in	0°	0.18° toe-out
-----------	--------------	----	---------------

FRONT AXLE (INDEPENDENT FRONT SUSPENSION)						
Load	Minimum value		Nominal value		Maximum value	
	Non-converted	Converted	Non-converted	Converted	Non-converted	Converted
Right camber	0.20°	-0.20°	0.30°	0°	0.50°	0.20°
Left camber	0.20°	-0.20°	0.30°	0°	0.50°	0.20°
Right caster	2.55°		2.8°		3.05°	
Left caster	2.55°		2.8°		3.05°	
Total toe	0.02°	0.04°	0.04°	0.06°	0.06°	0.08°

**COOLING SYSTEM**

- Extra capacity, copper fin radiator and aluminum charge air cooler.
- 3 speed fan clutch EECU controlled.
- Rubber insulated from the body.
- Expansion tank above radiator and remote mounted.
- System pressure 14 psi.
- One (1) 185° F thermostat.
- System capacity 27 US gal.
- Coolant filter.
- Radiator fan: 38 inches fan, belt and shaft driven.

**FUEL SYSTEM**

Polyethylene 230 us gallon/870 liters fuel tank located in middle of second baggage bay (heating and a/c section) includes:

- Anti-spill device.
- Two Safety filler cap, providing filling access on each side of the vehicle.

## 9-8 TECHNICAL INFORMATION

- Pressure relief valve.
- Electric fuel gage.
- Fuel cooler.
- Low level signal at 26 US gallon/98 liters.
- Primary filter 25 microns (standard).
- Fuel pro 382 filter available as an option as a primary filter.
- Secondary filter 3 to 5 microns.
- Shut-off valve on fuel supply line.

### EXHAUST SYSTEM

One all stainless steel exhaust system including:

- FleetGuard aftertreatment system made of a Diesel Particulate Filter (DPF), Diesel Oxidation Catalyst (DOC) and Selective Catalytic Reduction (SCR) unit. Noise, vibration and heat insulated. This ATD is mounted to the bus structure and is accessible through an exterior access door.
- Tail pipe diffuser and rain deviation device.
- Exhaust pipe with insulation and a flexible section.
- Exhaust to rear left hand top of rear cap.

### HEATING AND AIR CONDITIONING

Two air conditioning systems are available: the large capacity (central A/C) or the small capacity A/C (also known as driver's air). Vehicles equipped with the large capacity A/C benefit from a combination heating and cooling system that provides adequate capacity of conditioned and filtered air for all climatic conditions. Fresh air is drawn into the system from the left (driver's) side of the vehicle. Return air is taken from the middle of the vehicle. The driver's heater and defogger are controlled separately from the central unit. An air mixture selector enables air to be drawn into the system from outside the vehicle or recirculated. Driver's air provides cooling for the driver's area only, maximizing available baggage space for other uses. The small capacity A/C enables cooling the driver's area only.

SMALL HVAC SYSTEM	
Air conditioning capacity	2 tons
Refrigerant type	134a
Refrigerant nominal charge	6 lbs
Air flow	450cfm (12,7 m <sup>3</sup> /min)

COMPRESSOR (for small HVAC system)	
Number of cylinders	7
Operating speed	700 to 6 000 rpm
Oil capacity	6.0 U.S. oz (0,18 l)
Approved oil	SP-20 (PAG)

CENTRAL HVAC SYSTEM	
Air conditioning capacity	7.5 tons
Refrigerant type	134a
Heating capacity	152 000 Btu/h
Air flow	2 600cfm (73,6 m <sup>3</sup> /min)

COMPRESSOR (For Central HVAC System)	
Number of cylinders	4
Operating speed	500-3500 rpm
Oil capacity	2.6 U.S. qts (2,5 l)
Approved oil	Bitzer BSE55 (POE)

#### NOTE

*The above oils are suitable for use with reciprocating compressors using refrigerant R-134a and with evaporator temperatures above -40°F (-40°C).*

### OIL SPECIFICATIONS

#### ENGINE

Use SAE 10W-30 meeting the following specification:

- Volvo VDS-4
- API classification CJ-4.



#### CAUTION

CJ-4 contains less than 1% ash which is key to achieving maximum diesel particulate filter cleaning intervals. Use of high ash engine oils will reduce the cleaning interval on the Diesel Particulate Filter (DPF). DPF regenerates the combustible soot, but the ash (a product of the oil lubricant package) slowly accumulates in the channels of the DPF.

**ALLISON TRANSMISSION**

Allison Transmission recommends the following fluids:

- Castrol TranSynd™ or TES-295 specification equivalent fluid;
- TES-389 specification equivalent fluid;

**DIFFERENTIAL**

Multigrade gear oil meeting MIL-PRF-2105-E: 85W140 is recommended for use in drive axle. This lubricant performs well over a broad temperature range, providing good gear and bearing protection in a variety of climates. If temperature drops below 10°F (-12°C), 80W90 should be used, and below -15°F (-26°C), 75W90 should be used. In extreme conditions or for better performance, full synthetic gear oil should be used.

**COOLING FAN RIGHT ANGLE GEARBOX**

Use Synthetic Gear Lubricant SAE 75W-90.

**POWER STEERING RESERVOIR**

Use Automatic Transmission Fluid (ATF) Dexron-II-E or Dexron-III for this system.

**PLATES AND CERTIFICATION**

The main components of the vehicle, such as engine, transmission, axles and the chassis are identified by different serial numbers. It may be necessary to locate these numbers for warranty purposes.

In addition, option decals are located on the rocker cover (starter side). The engine serial and model number and a list of the optional engine equipment are written on these decals. Refer to this information when ordering replacement parts.

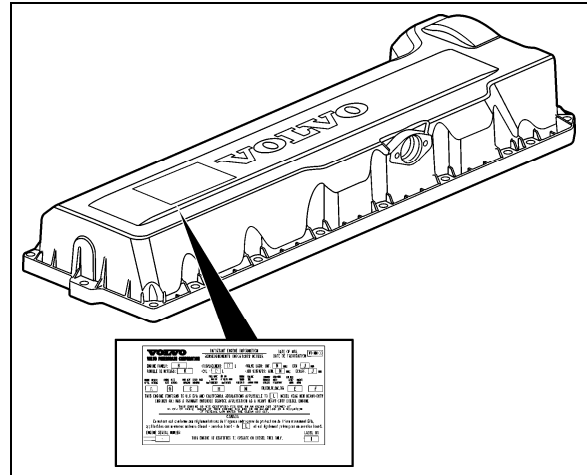

**VOLVO D13 ENGINE DATA PLATE**

00052

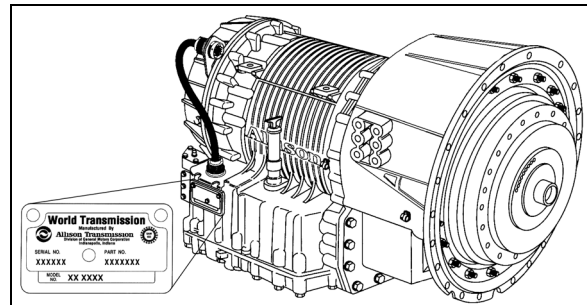

**TRANSMISSION DATA PLATE**

07076

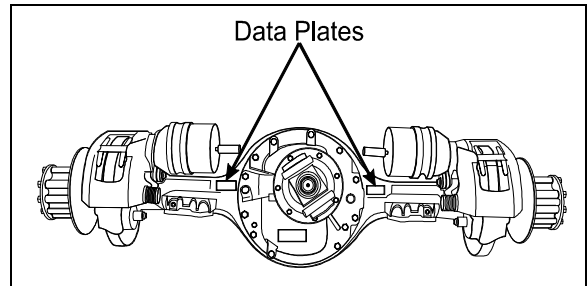

**DRIVE AXLE**

11019

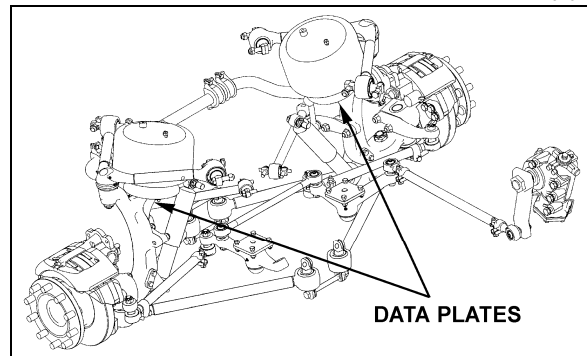

**IFS TYPICAL SERIAL & MODEL NUMBERS**

00025C

**SAFETY CERTIFICATION**

Vehicle components meet specifications and standards as follows:

## 9-10 TECHNICAL INFORMATION

- Material and parts conform to ASTM and/or SAE standards in effect at the time of manufacture.
- All factory-installed interior materials meet FMVSS 302 for fire resistance.
- Certified according to Provincial, State and Federal Safety standards (Canadian and US) BMCSS, FMVSS and CMVSS.

Other applicable certification labels are affixed to the applicable components.

### DOT CERTIFICATION PLATE

This certifies that vehicles manufactured by Prevost Car Inc. comply with all Federal Motor Vehicle Safety Standards at the time of manufacture. Information such as date of manufacture, model year, gross vehicle weight rating, tire types and inflation pressure is also etched on this plate. The DOT Certification plate is affixed to the panel behind the driver's seat.

		<b>PREVOST</b>		<input type="text"/>	
INCOMPLETE VEHICLE MANUFACTURED BY VEHICULE INCOMPLET FABRIQUE PAR		: PREVOST CAR INC. STE-CLAIRE, QUE.		<b>EC</b>	
DATE OF MFG. DATE DE FAB.		<input type="text"/>			
G.V.W.R. / P.N.B.V. : 24721 KG. (54500 LBS).		COLD INFLATION PRESS. / FROTS A QU			
AXLES / ESSEUX		G.A.W.R. / P.N.B.E.		TIRE / PNEUS	
KG (LBS)		RIMS / JANTES		SINGLE OR DUAL SIMPLE OU DOUBLE	
FRONT: AVANT:		8165 (18000)		365/70R22.5 (L) 22.5X10.5 724 (105) S	
INT. DIFF. :		10206 (22500)		315/80R22.5 (L) 22.5X9 (OUT) 655 (95) D	
REAR: TANDEM:		6350 (14000)		365/70R22.5 (L) 22.5X10.5 552 (80) S	
THIS INCOMPLETE VEHICLE CONFORMS TO ALL APPLICABLE U.S. FEDERAL MOTOR VEHICLE SAFETY STANDARDS IN EFFECT ON THE DATE OF MANUFACTURE SHOWN ABOVE. IF COMPLETED IN ACCORDANCE WITH THE INSTRUCTIONS OF INCOMPLETE VEHICLE DOCUMENTS FURNISHED PURSUANT TO CFR PART 568, CONFORMITY TO THE OTHER SAFETY STANDARDS IS NOT SUBSTANTIALLY AFFECTED BY THE DESIGN OF THE INCOMPLETE VEHICLE.					
VEHICLE IDENTIFICATION NO. / NO. IDENTIFICATION VEHICULE		<input type="text"/>			
#405444					

DOT CERTIFICATION PLATE

00016

### VEHICLE IDENTIFICATION NUMBER (VIN)

The Vehicle Identification Number is stamped on the DOT Certification plate behind the driver's seat, also on a plate located on the windshield frame pillar (driver's side). The VIN is visible from the outside of the vehicle. The VIN is also stamped on the DOT certification plate affixed behind the driver's seat. Make sure the correct vehicle identification number is given when ordering replacement parts. Using the VIN when ordering parts will facilitate processing.

### NOTE

Record the VIN in the vehicle documentation and keep with company records. The VIN will normally be used for vehicle registration, service reference needs and for obtaining vehicle insurance coverage.

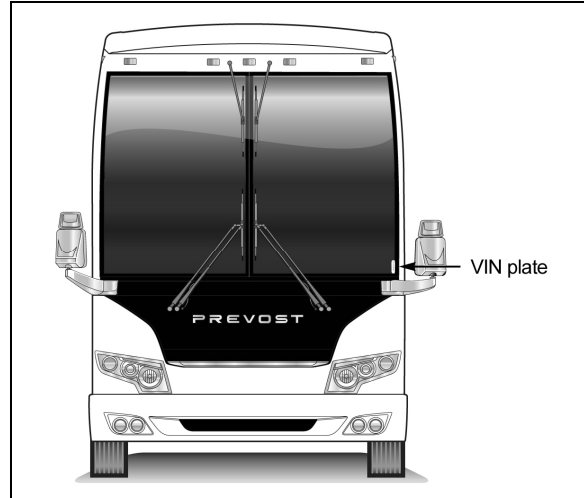

VEHICLE IDENTIFICATION NUMBER

18680

### COACH FINAL RECORD

The Coach Final Record is a record of all data pertaining to the assembly of the vehicle. This record is shipped to the new owner via a courier company. Retain this record in the company records office for reference and safe-keeping.

ABBREVIATION	DESCRIPTION
A/C	Air Conditioning / Air climatisé
ACB	Adaptive Cruise Braking / Régulateur de vitesse et d'espacement avec freinage
ACM	Aftertreatment Control Module / Unité de commande électronique du système de post-traitement
AFSS	Automatic Fire Suppression System / Système automatique de détection et d'extinction des incendies
ATC	Automatic Traction Control (Bendix) / Système d'antidérapage automatique
CECM	Chassis Electronic Control Module
CVC	Chauffage, Ventilation et Climatisation / heating, ventilation and air conditioning HVAC
DCDL	Driver Controlled Differential Lock / Verrouillage du différentiel
DDR	Diagnostic Data Reader
DEF	Diesel Exhaust Fluid / Fluide d'échappement diesel FED
DEL	Diode Électroluminescente / Light Emitting Diode LED
DID	Driver Information Display / Écran d'affichage du panneau des instruments
D-MIC	Driver Microphone / Microphone du conducteur
DPF	Diesel Particulate Filter / Filtre à particules
DTC	Diagnostic Troubleshooting Code / Code d'anomalie
DUFS	Diesel Ultra Faible en Soufre / Ultra Low Sulfur Diesel ULSD
ECU	Electronic Control Unit / Unité de commande électronique
EECU	Engine Electronic Control Unit / Unité de commande électronique du moteur
EGR	Exhaust Gas Recirculation / Recirculation des gaz d'échappement
ESC	Electronic Stability Control / Dispositif de contrôle de la stabilité
ESC	Escape / Échap
ESP	Electronic Stability Program (Bendix) / Dispositif électronique de contrôle de la stabilité
E+	Eco-Roll
FAP	Filtre À Particules / Diesel Particulate Filter DPF
FDA	Following Distance Alert / Alerte de distance
FED	Fluide d'Échappement Diesel / Diesel exhaust fluid DEF
GECU	Gear selector Electronic Control Unit / Unité de commande électronique du sélecteur de vitesses
G-MIC	Guide Microphone / Microphone du guide
HVAC	Heating, Ventilation and Air Conditioning / Chauffage, Ventilation et Climatisation CVC
IA	Impact Alert / Alerte de collision
IFS	Independent Front Suspension / suspension avant indépendante
LED	Light Emitting Diode / diode électroluminescente DEL
MCM	Master Chassis Module
MPH	Miles Per Hour / Milles à l'heure
PPT	Premium Tech Tool
PRIME	Power Recovery by Intelligent Management of Energy
PTO	Power Take Off / Prise de force
SCR	Selective Catalytic Reduction / Réduction catalytique sélective
TCM	Transmission Control Module / Module de commande de la transmission
TCS	Traction Control System / Dispositif d'antipatinage
TECU	Transmission Electronic Control Unit / Unité de commande électronique de la transmission
TPMS	Tire Pressure Monitoring System / Système de surveillance de la pression des pneus
TWS	Threshold Warning System / Système avertisseur du seuil de porte
ULSD	Ultra Low Sulfur Diesel / Diesel Ultra Faible en Soufre DUFS
VCADS	Outil informatisé de diagnostic
VEB	Volvo Engine Brake / Frein moteur Volvo
VECF	Vehicle Electrical Center Front
VECR	Vehicle Electrical Center Rear
VECU	Vehicle Electronic Control Unit / Unité de commande électronique du véhicule
VSS	Video and Sound Selector / Sélecteur audio-vidéo
WCL	Wheelchair Lift / Élévateur de fauteuils roulants



**APPENDIX A**

**SERVICE LITERATURE..... 2**

**NOTICE..... 3**

DECLARATION OF THE MANUFACTURING DEFECTS TO THE GOVERNMENT OF THE UNITED STATES ..... 3

DECLARATION OF THE MANUFACTURING DEFECTS TO THE CANADIAN GOVERNMENT ..... 3

DECLARATION OF THE MANUFACTURING DEFECTS TO PREVOST CAR INC. .... 3

## 2 APPENDIX A

---

### **SERVICE LITERATURE**

Visit our web sit at [www.prevostcar.com](http://www.prevostcar.com) for on-line product information and technical publications!

Additional copies of the following service literature are available on request and at low cost. These can be helpful to mechanics and drivers alike.

- **Maintenance Manual**
- **Operator's Manual**
- **Parts Manual**
- **Service Center Directory**

To order, call Prevost Parts toll free 1-800-463-8876 or write to:

**PREVOST PARTS INC.**

2955-A Watt Street  
Sainte-Foy, (Quebec)  
Canada G1X 3W1

**Specify the complete vehicle serial number. Allow 30 days for delivery**



## **NOTICE**

### **DECLARATION OF THE MANUFACTURING DEFECTS TO THE GOVERNMENT OF THE UNITED STATES**

If you believe that your vehicle has defect which could cause a crash or could cause injury or death, you should immediately inform the National Highway Traffic Safety Administration (NHTSA) in addition to notifying PrevoSt Car Inc.

If NHTSA receives similar complaints, it may open an investigation, and if it finds that a safety defect exists in a group of vehicles, it may order a recall and remedy campaign.

However, NHTSA cannot become involved in individual problems between you, your dealer, or PrevoSt Car Inc.

To contact NHTSA you may either call the Auto Safety Hotline toll-free at **1-800-424-9393** (or **366-0123** in Washington, D.C. area) or write to:

**NHTSA  
U.S. Department of transportation  
Washington, D.C. 20590.**

You can also obtain other information about motor vehicle safety from the Hotline.

### **DECLARATION OF THE MANUFACTURING DEFECTS TO THE CANADIAN GOVERNMENT**

If you stay in Canada, and if you believe that your vehicle has a safety defect, you should immediately inform Transport Canada and PrevoSt Car Inc. You may write to:

**Transport Canada  
Box 8880  
Ottawa, Ontario, K1G 3J2**

### **DECLARATION OF THE MANUFACTURING DEFECTS TO PREVOST CAR INC.**

In addition to notify the NHTSA (or Transport Canada), please contact PrevoSt Car at **1-418-831-2046**. Or you may write to :

**PrevoSt Car Inc.  
After-sales service department  
850 ch. Olivier,  
Saint-Nicolas (Quebec)  
Canada, G7A 2N1**



<b>Problem/Symptom</b>	<b>Probable Causes</b>	<b>Actions</b>
Vehicle does not Start	Rear Start selector switch is not at the NORMAL position	1. Check that the rear start selector switch is flipped up to NORMAL start position and battery master switch is flipped up to ON and retry cranking
	Battery master switch in the battery compartment is at the OFF position (down)	2. Flip the rear start selector switch to “Rear Start” and start the vehicle from the rear
	CAN network problem (Multiplex)	If the vehicle does not start from the rear:
	Module A53 not powered or is defective	1. Verify that module A53 is powered: <ul style="list-style-type: none"> <li>a) Check DIAGNOSTIC menu of the DID. Select FAULT DIAGNOSTIC and ELECTRICAL SYSTEM. The message “No Response ModA53, Active” indicates a power problem on the module or a CAN network problem.</li> <li>b) Check / reset circuit breaker CB5</li> <li>c) Check / replace fuse F65</li> <li>d) Probe gray connector on module to see if it is powered.</li> </ul>
	Engine ECM does not receive the ignition signal	2. Verify that the engine ECM is powered and get the ignition signal <ul style="list-style-type: none"> <li>a) Check / reset circuit breaker CB8 Check / replace fuse F74</li> <li>b) Check / reset circuit breaker CB2 Check / replace fuse F78</li> </ul>
	Engine ECM is not powered	
None of the Multiplexed functions are operating, including the basic limp-home functions (door opening, flashers, wipers in speed 1)	The program version in the MCM is different than the program in the I/O modules and the MCM is forcing all I/O modules to stay inactive	1. Engage the auto-programming of the I/O modules: Turn the ignition key to the ON position, trip and reset circuit breaker CB6.
“FLIP REAR BREAKER TO INITIATE I/O MODULES PROGRAMMING” pop-up message appears in the DID		2. The DID indicates “MUX AUTOPROGRAMMING I/O MODULE PLEASE WAIT” until the reprogramming is complete.
<i>Note: The sunshades are still functioning since these are not multiplexed</i>		
Many secondary functions (not essential for driving) not functioning (interior	The MCM module does not receive 24 V power	1. Check / reset circuit breaker CB6 (4 <sup>th</sup> from the top on the right side column) Check / replace fuse F1

## 2 APPENDIX B – Troubleshooting Multiplex

Problem/Symptom	Probable Causes	Actions
<p>lighting, driver's area lighting, wiper speed 2 and intermittent)</p> <p>Marker lights and clearance lights are turned ON when setting ignition to the ON position</p>	<p>The CAN network is not working. It could be caused by a short on the network, an open circuit, a problem with the MCM or the MCM being disconnected from the network</p>	<p>2. Operate in limp-home mode by starting the vehicle from the engine compartment (REAR START). All functions essential to drive are available</p> <p>To close and lock the door, pull the door manually up to its closed position and it will lock by itself. The door opening button is still functioning</p>
<p>No temperature control in the passenger area</p> <p>Passenger temperature display indicates two dashes "--"</p>	<p>Problem with the temperature sensor located in the evaporator compartment air intake or the sensor wiring</p>	<p>1. Instruct the driver to manually control the temperature by playing with the passenger set point. Set above 22°C (72°F) to heat and below 22° C (72°F) to cool</p>
<p>Entrance door does not open nor close using the control buttons</p> <p>Defroster fan not functioning</p> <p>Lower windshield wipers not functioning in speed 1 or intermittent</p>	<p>Module A47 is not powered or is faulty</p>	<p>1. Check DIAGNOSTIC menu of the DID. Select FAULT DIAGNOSTIC and ELECTRICAL SYSTEM. The message "No Response ModA47, Active" indicates a power problem on the module. (A CAN network problem would show the same message but doesn't produce these symptoms).</p> <p>2. Check / reset circuit breaker CB6</p> <p>3. Check / replace fuse F5</p> <p>4. Probe gray connector on module to see if it is powered.</p> <p>5. Use the air release valves near the entrance door and in the front service compartment to lock / unlock the door</p>
<p>Lower windshield wipers not functioning in speed 1 or intermittent</p>	<p>No power on R23</p>	<p>1. Check / replace fuse F18</p>
<p>HVAC condenser fans not functioning in speed 1</p>	<p>Circuit breaker CB7 was manually tripped and not reset</p> <p>Module A53 is defective</p>	<p>1. Check / reset circuit breaker CB7</p> <p>2. Verify that module A53 is powered: Check DIAGNOSTIC menu of the DID. Select FAULT DIAGNOSTIC and ELECTRICAL SYSTEM. The message "No Response ModA53, Active" indicates a power problem on the module or a CAN network problem.</p>

## APPENDIX B – Troubleshooting Multiplex 3

Problem/Symptom	Probable Causes	Actions
HVAC condenser fans not functioning in speed 2	<p>Circuit breaker CB7 was manually tripped and not reset</p> <p>Module A53 not powered or is defective</p>	<ol style="list-style-type: none"> <li>1. Check / reset circuit breaker CB7</li> <li>2. Verify that module A53 is powered: Check DIAGNOSTIC menu of the DID. Select FAULT DIAGNOSTIC and ELECTRICAL SYSTEM. The message “No Response ModA53, Active” indicates a power problem on the module or a CAN network problem.</li> </ol>
<p>Lower and upper windshield washer not functioning</p> <p>Upper windshield wiper not functioning</p> <p>Defroster fan is functioning but no heat or cooling available in the driver area</p>	Module A46 is not powered or is faulty	<ol style="list-style-type: none"> <li>1. Check DIAGNOSTIC menu of the DID. Select FAULT DIAGNOSTIC and ELECTRICAL SYSTEM. The message “No Response ModA46, Active” indicates a power problem on the module. (A CAN network problem would show the same message but doesn't produce these symptoms).</li> <li>2. Check / reset circuit breaker CB1</li> <li>3. Check / replace fuse F12</li> <li>4. Probe gray connector on module to see if it is powered.</li> </ol>
<p>Low beam headlights and front flasher on left side not functioning</p> <p>Electric horn not functioning</p>	Module A45 is not powered or is faulty	<ol style="list-style-type: none"> <li>1. Check DIAGNOSTIC menu of the DID. Select FAULT DIAGNOSTIC and ELECTRICAL SYSTEM. The message “No Response ModA45, Active” indicates a power problem on the module. (A CAN network problem would show the same message but doesn't produce these symptoms).</li> <li>2. Check / reset circuit breaker CB2</li> <li>3. Check / replace fuse F33 and F34</li> <li>4. Probe gray connector on module to see if it is powered.</li> </ol>
Low beam headlights and flasher on right side not functioning	Module A48 is not powered or is faulty	<ol style="list-style-type: none"> <li>1. Check DIAGNOSTIC menu of the DID. Select FAULT DIAGNOSTIC and ELECTRICAL SYSTEM. The message “No Response ModA48, Active” indicates a power problem on the module. (A CAN network problem would show the same message but doesn't produce this symptom).</li> <li>2. Check / reset circuit breaker CB2</li> <li>3. Check / replace fuse F33 and F34</li> <li>4. Probe gray connector on module to see if it is powered.</li> </ol>

#### 4 APPENDIX B – Troubleshooting Multiplex

Problem/Symptom	Probable Causes	Actions
<p>Rear flashers not functioning</p> <p>Stoplights and high-mounted stoplight not functioning</p>	<p>Module A51 is not powered or is faulty</p>	<ol style="list-style-type: none"> <li>1. Check DIAGNOSTIC menu of the DID. Select FAULT DIAGNOSTIC and ELECTRICAL SYSTEM. The message “No Response ModA51, Active” indicates a power problem on the module. (A CAN network problem would show the same message but doesn't produce this symptom).</li> <li>2. Check / reset circuit breaker CB2</li> <li>3. Check / replace fuse F80</li> <li>4. Probe gray connector on module to see if it is powered.</li> </ol>
<p>Engine is overheating and radiator fan clutch does not engage</p> <p>The A/C compressor clutch does not engage</p>	<p>Module A52 is not powered or is faulty</p>	<ol style="list-style-type: none"> <li>1. Check DIAGNOSTIC menu of the DID. Select FAULT DIAGNOSTIC and ELECTRICAL SYSTEM. The message “No Response ModA52, Active” indicates a power problem on the module. (A CAN network problem would show the same message but doesn't produce this symptom).</li> <li>2. Check / reset circuit breaker CB5</li> <li>3. Check / replace fuse F65</li> <li>4. Probe gray connector on module to see if it is powered.</li> </ol>
<p>Evaporator fan not functioning</p>	<p>Circuit breaker CB3 tripped</p> <p>Module A54 is not powered or is faulty</p>	<ol style="list-style-type: none"> <li>1. Check / reset circuit breaker CB3</li> <li>2. Check DIAGNOSTIC menu of the DID. Select FAULT DIAGNOSTIC and ELECTRICAL SYSTEM. The message “No Response ModA54, Active” indicates a power problem on the module. (A CAN network problem would show the same message but doesn't produce this symptom).</li> <li>3. Check / reset circuit breaker CB5</li> <li>4. Check / replace fuse F67 , F68</li> <li>5. Probe gray connector on module to see if it is powered.</li> </ol>
<p>HVAC condenser fans not functioning in speed 1</p>	<p>Module A54 is not powered or is faulty</p>	<ol style="list-style-type: none"> <li>1. Check DIAGNOSTIC menu of the DID. Select FAULT DIAGNOSTIC and ELECTRICAL SYSTEM. The message “No Response ModA54, Active” indicates a power problem on the module. (A CAN network problem would show the same message but doesn't produce this symptom).</li> <li>2. Check / reset circuit breaker CB5</li> </ol>

## APPENDIX B – Troubleshooting Multiplex 5

Problem/Symptom	Probable Causes	Actions
		<ol style="list-style-type: none"> <li>3. Check / replace fuse F67 , F68</li> <li>4. Probe gray connector on module to see if it is powered.</li> </ol>
Sound system not functioning	Circuit breaker CB4 or CB11 was manually tripped and not reset	<ol style="list-style-type: none"> <li>1. Check / reset circuit breaker CB4 or CB11</li> </ol>
Fire alarm telltale light and audible alarm always ON and there is no fire or high temperature in the engine compartment	Short-circuited fire sensor or defective sensor	<ol style="list-style-type: none"> <li>1. Prior to start the vehicle, cycle the ignition key to the ON position, OFF position and then ON position again and then start the vehicle. This will deactivate the fire alarm function. This has to be repeated each time the vehicle is re-started</li> </ol>
The vehicle is parked and the electrical horn is activated to indicate a fire in the engine compartment but there is no fire	Short-circuited fire sensor or defective sensor	<ol style="list-style-type: none"> <li>1. Cycle the ignition key between the ON and OFF position twice within 3 seconds. This will deactivate the fire alarm function. This has to be repeated each time the vehicle is parked</li> </ol>
A single light, a group of LED lights or another function of the vehicle is not functioning	The multiplex outputs are protected in current by an internal "soft-fuse". When an output is shorted, it turns OFF and stays OFF until the "soft-fuse" is reset	<ol style="list-style-type: none"> <li>1. Turn the ignition key to the OFF position and turn to the ON position again. This resets all "soft –fuses"</li> </ol>
No backlighting in the instrument cluster	Circuit breaker CB10 is tripped or fuse F29 blown	<p>Check / reset circuit breaker CB10</p> <p>Check / replace fuse F20</p>
The radiator fan clutch does not function and the engine is overheating		<p>You can manually engage the radiator fan clutch speed 1 or speed 2.</p> <ol style="list-style-type: none"> <li>1. On the Driver Information Display, select DIAGNOSTICS menu. Select VEHICLE TESTS submenu and then ACTIVATE RADIATOR FAN SPEED 1 or ACTIVATE RADIATOR FAN SPEED 2.</li> <li>2. The DID status line will show TEST to confirm the forced activation of the radiator fan clutch. To cancel, turn the ignition switch to the OFF position or press ESCAPE button, select STOP TEST submenu and then press ENTER button twice. TEST will disappear from the DID status line.</li> </ol> <p>If the fan clutch does not engage using this procedure then the clutch is faulty or the wiring between the multiplex module and the clutch is faulty. Mechanically lock the fan clutch as described in section 05: COOLING SYSTEM of the maintenance manual.</p>





## APPENDIX C

<b>ALLISON TRANSMISSION 5<sup>TH</sup> GENERATION OIL LEVEL CHECK USING THE PUSHBUTTON SHIFT SELECTOR.....</b>	<b>2</b>
<b>CONTROL SYSTEM PROGNOSTICS.....</b>	<b>3</b>
NORMAL PROGNOSTICS INDICATION AT ENGINE START .....	3
OIL LIFE MONITOR.....	3
FILTER LIFE MONITOR.....	4
TRANSMISSION HEALTH MONITOR .....	5
<b>DIAGNOSTIC TROUBLESHOOTING CODES (DTC) — ALLISON 5TH GENERATION CONTROLS.....</b>	<b>7</b>
DIAGNOSTIC TROUBLESHOOTING CODES (DTC) OVERVIEW .....	7
DIAGNOSTIC TROUBLE CODE RESPONSE .....	8
DIAGNOSTIC TROUBLESHOOTING CODES (DTC) LIST - ALLISON 5 <sup>TH</sup> GENERATION CONTROLS	9

## 2 APPENDIX C – Allison Transmission’s Other Features

### ALLISON TRANSMISSION 5<sup>th</sup> GENERATION OIL LEVEL CHECK USING THE PUSHBUTTON SHIFT SELECTOR

The oil level sensor (OLS) is standard in your transmission. With the OLS and Allison 5<sup>th</sup> generation shift selector, you can get a more accurate electronic fluid level check than with a dipstick.

Oil level codes are obtained as follows:

1. Park vehicle on a level surface, select «N» (neutral) on the pushbutton shift selector and apply parking brake.
2. Wait for at least 2 minutes to allow the oil to settle;
3. Press simultaneously the ▲ (Upshift) and ▼ (Downshift) arrow buttons once.
4. Oil level codes are displayed once the following parameters are met :
  - **The vehicle has been stationary for approximately 2 minutes to allow the oil to settle;**
  - **Engine at idle;**
  - **Oil at normal operating temperature, between 104°F (40°C) and 220°F (104°C);**
  - **Transmission in «N» (Neutral);**
  - **Transmission output shaft stopped;**
  - **Oil level sensor present and working.**

5. Correct fluid level is displayed as shown.



6. Low fluid level is displayed as shown. The number indicates the number of quarts of fluid the transmission requires.



7. High fluid level condition with the number of quarts in excess is displayed as shown.



#### NOTE

Confirm a low fluid level condition by making a manual fluid level check.

8. To exit the Oil Level Display Mode, press any range button «R», «N» or «D» at any time.

#### NOTE

Note that the quantities LO 4 and HI 3 are the largest values displayed and that the actual variation in oil level may exceed these numbers.

If the fluid level check cannot be completed, an Invalid for Display fault is reported. Refer to table below to review the codes and conditions.

CODE	CAUSE OF FAULT CODE
SETTLING OX	Settling time too short
ENG RPM TOO LOW	Engine speed (rpm) too low
ENG RPM TOO HIGH	Engine speed (rpm) too high
MUST BE IN NEU	N (Neutral) must be selected
OIL TEMP TOO LOW	Sump fluid temperature too low
OIL TEMP TOO HIGH	Sump fluid temperature too high
VEH SPD TOO HI	Output shaft speed
SENSOR FAILED	Sensor failure

## CONTROL SYSTEM PROGNOSTICS

The transmission control system includes the provision for the user to monitor various transmission operating parameters. Transmission operating parameters monitored by the prognostics feature are:

- Oil Life Monitor
- Filter Life Monitor
- Transmission Health Monitor



### NOTE

*The prognostics package requires the use of **TranSynd™** or an Allison approved **TES295 or TES389 licensed fluid** in the transmission and **Allison High Capacity filters**. If any other fluids or filters are used, Prognostic mode **must be disabled**. Prognostic information will not be accurate with any other fluids or filters and could result in missed maintenance activities resulting in transmission damage.*



*Refer to TES 295 or TES389 Approved Fluids list, found under the Service/Fluids heading on the home page of the Allison Transmission web site.*

[www.allisontransmission.com](http://www.allisontransmission.com)

When a specified threshold is detected for any of the serviceable conditions, the TRANSMISSION SERVICE indicator  is illuminated to alert the operator. Failure to attend to the service condition and reset the TRANSMISSION SERVICE indicator within a defined operating period will result in illumination of the CHECK light with associated message in the DID, indicating the increased probability that the service condition will develop into a more serious condition.

To access the Prognostic Mode functions, simultaneously press the  (Upshift) and  (Downshift) arrow buttons repeatedly. See the reference table at the end of this section.

## NORMAL PROGNOSTICS INDICATION AT ENGINE START

- A system bulb check illuminates the TRANSMISSION SERVICE indicator  approximately 0.5 seconds.
- If Prognostics features are enabled, the TRANSMISSION SERVICE indicator  illuminates again for 3 seconds after the bulb check. If Prognostics features are

disabled, the TRANSMISSION SERVICE indicator  does not illuminate again after the bulb check.

## OIL LIFE MONITOR

The display message denotes the calculated remaining life of the transmission fluid. This value is based on the established life for the required baseline fluid, and then is continuously adjusted for cumulative effects of such operating parameters as operating time, retarder operation, output shaft revolutions and shift frequency.

### Display

The display is a two-digit number, denoting percentage of the fluid life which remains. New fluid is displayed as 99%.

The TRANSMISSION SERVICE indicator  will be illuminated, denoting a required change of transmission fluid, when the remaining fluid life reaches approximately 1 %. The indicator will be lit steadily upon each initialization of the TCM, and will remain on steady for approximately 2 minutes after the first selection of “D” (drive) range each time, until service is performed and the indicator is reset.

Failure to perform maintenance and reset the TRANSMISSION SERVICE indicator within a defined period will result in the illumination of the CHECK light with associated message in the DID and diagnostic code P0897 Transmission Fluid Deteriorated.

### Reset

The TRANSMISSION SERVICE indicator can be reset by a message over the SAE J1939 communication interface, with the Allison DOC™ for PC diagnostic program, or by depressing and holding the MODE button for ten (10) seconds while the Oil Life Monitor function is displayed. It may also be reset by selecting N-D-N-D-N-R-N on the shift selector, pausing briefly (less than 3 seconds) between each selector movement, with the ignition on and the engine not running. The TRANSMISSION SERVICE indicator illuminates briefly following a reset to acknowledge the reset was successful.

### Setting Fluid Type for Prognostics

The fluid type can be programmed if the specific calibration allows it. The operator can do the following:

## 4 APPENDIX C – Allison Transmission’s Other Features

With the engine off and the ignition on, perform the following sequence on the selector, N-R-N-D-N-R-N-D-N-R-N-D-N.

The TRANSMISSION SERVICE indicator flashes if TES389 is the current setting and illuminates solidly if TES295 is the current setting. To change the transmission fluid type, wait 5 seconds after entering transmission fluid type mode and perform the following sequences to select the proper transmission type:

N-R-N to select TES295

N-D-N to select TES389

The selector exits 30 seconds after entering transmission fluid type mode or the ignition may be turned off to exit earlier. Only one transmission fluid type selection may be made after entering transmission fluid type mode. All other attempt will be ignored. Transmission fluid type mode needs to be entered again if the wrong type of fluid is selected.



### CAUTION

*Verify prognostics fluid type setting matches transmission fluid type. Oil Life Monitor notifications will be inaccurate when mismatched. This could result in transmission damage from running a TES389 fluid too long or cause shortened TES295 fluid changes to occur.*



### CAUTION

Required calendar-based oil & filter change intervals (based on month) still apply because Oil Life Monitor function cannot measure time while ignition power is OFF.

If the Oil Life Monitor function has not indicated the need for a fluid change before 60 months have passed when using TES295 fluid type or before 24 months have passed when using TES389 fluid type, it will be necessary to change the fluid and filters per calendar requirements and reset the system.

### FILTER LIFE MONITOR

This feature provides an alert when the transmission’s fluid filters need to be replaced. It helps extend filter change intervals to reduce routine maintenance downtime while providing maximum protection for the transmission.



The filter life indicator pressure switch signals the transmission control module when fluid exiting the main filter drops below a predetermined pressure. Both the main and lube filters **must be** changed when the TRANSMISSION SERVICE indicator  shows the main filter should be changed.

### Filter Change Notification

Once the programmed threshold for maximum filter pressure drop has been observed and verified, the diagnostic code P088A Transmission Filter Maintenance Alert will be recorded to indicate that the filter has reached the end of its designed life. At the next initialization of the TCM, the TRANSMISSION SERVICE indicator  will flash for 2 minutes after the first selection of “D” (drive) range. Thereafter, the indicator will illuminate and flash upon each TCM initialization, continuing to flash for 2 minutes after the first selection of a drive range each time, until service is performed and the indicator is reset.

Failure to perform maintenance and reset the monitor after a calibration-defined number of warnings will result in the illumination of the CHECK light with associated message in the DID and diagnostic code P088B will be recorded to indicate a highly deteriorated filter.

### Read and Reset Filter Life Monitor from Selector

To **enter** the filter life monitor, press simultaneously the  (Upshift) and  (Downshift) arrows three times. An acceptable filter life status is displayed as "OIL FILTER OK". An unacceptable filter life status is displayed as "REPLACE FILTERS".

The feature will **reset** automatically when the main fluid filter has been changed and the pressure drop across the filter no longer exceeds the threshold value. A manual reset can be performed by depressing and holding the MODE button for ten (10) seconds while the Filter Life Monitor function is displayed. It may also be reset by selecting N-R-N-R-N-D-N on the shift selector, pausing briefly (less than 3 seconds) between each selector movement, with the ignition on and the engine not running. The TRANSMISSION SERVICE indicator  illuminates briefly following a reset to acknowledge the reset was successful.

## TRANSMISSION HEALTH MONITOR

This prognostic feature determines clutch life status of the transmission’s clutches and alerts you when clutch maintenance is required. The clutch life status is determined by monitoring changes and the calculated running clearance of the transmission clutches.

### Clutch Maintenance Notification

The transmission health monitor feature determines when clutch maintenance is needed. If any of the clutches (except lockup) reaches a remaining life of approximately 10% or if any of the clutch running clearances exceeds a maximum value, then the TRANSMISSION SERVICE indicator is steadily illuminated from just after ignition on until ignition is turned off. Thereafter, the indicator will be lit upon each initialization of the TCM, and will remain on steady during all vehicle operation until service is performed and the indicator is reset. If the transmission health monitor mode has been accessed via the shift selector, a “TRANS HEALTH OK” or “TRANS HEALTH LO” is displayed. An acceptable clutch life status is displayed as “TRANS HEALTH OK”. An unacceptable clutch life status is displayed as “TRANS HEALTH LO”.

### Read and Reset Transmission Health Monitor from Selector

**To enter** the transmission health monitor, press simultaneously the ▲ (Upshift) and ▼ (Downshift) arrows four times. An acceptable clutch life status is displayed as “TRANS HEALTH OK”. An unacceptable clutch life status is displayed as “TRANS HEALTH LO”.

The feature will **reset** automatically upon elimination of the clutch clearance condition which initiated it. The indicator can also be manually reset using the Allison DOC™ for PC diagnostics program if necessary.

## 6 APPENDIX C – Allison Transmission’s Other Features

▲ (Upshift) & ▼ (Downshift) arrow buttons pressed simultaneously *	Description	Message	
1 <sup>st</sup> press	Allison transmission oil level check		
2 <sup>nd</sup> press	<b>Oil Life Monitor</b>	" O "	" M "
	Oil life remaining will range from 99% down to 00%	Some number from 9 to 0	Some number from 9 to 0
3 <sup>rd</sup> press	<b>Filter Life Monitor</b>	" F "	" M "
	Present life of filter is acceptable	OIL FILTER OK	
	Present life of filter is unacceptable	REPLACE FILTERS	
4 <sup>th</sup> press	<b>Transmission Health Monitor</b>	" T "	" M "
	An acceptable clutch life status is displayed as "TRANS HEALTH OK"	TRANS HEALTH OK	
	An unacceptable clutch life status is displayed as "TRANS HEALTH LO"	TRANS HEALTH LO	
5 <sup>th</sup> press	Display of diagnostic codes		

## DIAGNOSTIC TROUBLESHOOTING CODES (DTC) — ALLISON 5TH GENERATION CONTROLS

### DIAGNOSTIC TROUBLESHOOTING CODES (DTC) OVERVIEW

Diagnostic features are provided with the transmission control system to assist in troubleshooting of malfunctions and/or the monitoring of specific operating parameters. When a control system malfunction is detected, a series of Diagnostic Trouble Codes (DTCs) are used to identify and clarify the nature of the malfunction. These DTCs are each named by a 5 character alphanumeric string that refers to a diagnostic algorithm running pass/fail tests to help identify a malfunction in the transmission or vehicle operation. Most DTCs have some kind of diagnostic response that the operator notices, such as an illuminated CHECK light, selector display change, lock in range, or inhibit shifts condition.

DTCs are logged in the Transmission Control Module (TCM) memory by severity and by their active/inactive status with the most severe and active codes listed first. A maximum of five DTCs (numbered d1- d5) from most recent to oldest may be read from the shift selector. As DTCs are added, the oldest inactive DTC (historic) is dropped from the list. If all DTCs are active, the DTC with the lowest priority is dropped from the list.

An active code is any code that is current in the TCM decision-making process and has failed the DTC test(s) associated with that specific diagnostic algorithm. Historical codes, which are by definition inactive, are codes that are no longer failing their algorithm but are retained in the TCM in order to help the technician analyze possible causes and provide them direction if the vehicle is brought in before they are cleared from the queue.

DTCs can be cleared manually by the operator or they clear automatically from last (d5) to first (d1) in the queue after a number of engine starts, without becoming active again.

### USING SHIFT SELECTOR FOR ACCESSING DIAGNOSTICS INFORMATION

DTCs can be displayed on the display portion of the shift selector. A DTC is either active or historic. An active DTC is a DTC that is current in the TCM decision-making process. Historic DTCs are retained in the TCM memory and do not necessarily affect the TCM decision-making process.

#### Display Sequence

Up to five DTCs may be displayed one at a time from the selector once the diagnostic display mode has been initiated by the operator. Each DTC is 5 characters in length. The DTC status active or inactive is shown below the DTC.



Shows active DTC P0730

The operator presses the MODE button to read the next DTC in the queue (if any) or requests to exit diagnostics mode. The diagnostics mode times out and returns the selector to normal operating mode after approximately 10 minutes of operator inactivity.

### Diagnostic Code Display and Clearing Procedure

Diagnostic codes can be read and cleared by two methods:

- Using an Allison DOC™ diagnostic tool. For specific instructions on how to use an Allison DOC™ diagnostic tool, refer to the User Guide.
- Using the pushbutton shift selector.

To begin the diagnostic process:

## 8 APPENDIX C – Allison Transmission’s Other Features

---

1. Bring the vehicle to a stop at a safe location.
2. Apply the parking brake.

To display stored codes:

1. Simultaneously press the ▲ (Upshift) and ▼ (Downshift) arrow buttons five times (Prognostics enabled) to access the Diagnostic Display Mode. With Prognostics disabled, press the ▲ (Upshift) and ▼ (Downshift) arrow buttons twice.
2. Press the MODE button to read the next code in the queue, if any.

To clear all active stored codes:

While in Diagnostic Mode, clear all active codes by pressing and holding the MODE button for approximately three seconds until the MODE message flashes. Release the MODE button. The MODE message should not remain illuminated if the active DTC shown in the display has cleared.

While in Diagnostic Mode, press and hold the MODE button for 10 seconds to clear both active codes and inactive codes. The MODE message flashes a second time indicating all codes are cleared from the queue.

### Exiting Diagnostic Mode

Exit the diagnostic mode by one of the following methods:

1. Press simultaneously the ▲ (Upshift) and ▼ (Downshift) arrow buttons at the same time on the pushbutton shift selector.
2. Press any range button «D», «N» or «R» on the pushbutton shift selector.
3. After approximately 10 minutes of inactivity at the pushbutton shift selector, the diagnostic mode automatically exits and returns to normal operating mode.
4. Turn off power to the TCM (shut off the engine using the ignition key).

<b>NOTE</b>
<i>Be sure to record all codes displayed before they are cleared. This is essential for troubleshooting.</i>

<b>NOTE</b>
<i>If clearing a code while locked in a «D» (Drive) or «R» (Reverse) position (fail-to-range), the transmission will still be in «D» (Drive) or «R» (Reverse) when the clearing procedure is completed. «N» (Neutral) must be manually selected.</i>

### DIAGNOSTIC TROUBLE CODE RESPONSE

The electronic control system is programmed to inform the operator of a problem with the transmission system via the CHECK light and shift selector display while it automatically takes action to protect the operator, vehicle, and transmission. When the Transmission Control Module (TCM) flags a Diagnostic Trouble Code (DTC) as active, the TCM may take a combination of diagnostic responses as listed in the table below.



## APPENDIX C – Allison Transmission’s Other Features 9

CATEGORY OF RESPONSE	ACTIONS TAKEN
DNS - <u>Do Not Shift</u>	Release lock up (LU) clutch and inhibit lock up operation. Inhibit shifts from the current attained range. Turn on the CHECK light. Display the current attained range in the MONITOR window of the shift selector. Blank the SELECT window of the shift selector. Ignore any range selection inputs from the shift selector.
SOL OFF - <u>SOLenoid OFF</u>	All solenoids are commanded off, resulting in hydraulic default operation of the transmission – PCS1 & PCS2 are on hydraulically when off electrically.
RPR - Return to Previous Range	When the speed sensor ratio or PS1 tests do not pass, the TCM commands the same range as commanded before the shift.
NNC - Neutral No Clutches	When certain speed sensor ratio or PS1 tests do not pass, the TCM commands a neutral condition with no clutches applied.
DNA - <u>Do Not Adapt</u>	The TCM stops adaptive shift control while the code is active.

### DIAGNOSTIC TROUBLESHOOTING CODES (DTC) LIST - ALLISON 5<sup>TH</sup> GENERATION CONTROLS

DTC	Description	CHECK Light	Inhibited Operation Description
C1312	Retarder Request Sensor Failed Low	No	May inhibit retarder operation if not using J1939 datalink
C1313	Retarder Request Sensor Failed High	No	May inhibit retarder operation if not using J1939 datalink
P0122	Pedal Position Sensor Circuit Low Voltage	No	Use default throttle values. Freezes shift adapts.
P0123	Pedal Position Sensor Circuit High Voltage	No	Use default throttle values. Freezes shift adapts.
P0218	Transmission Fluid Over Temperature	Yes	Use default sump temp
P0562	System Voltage Low	No	Inhibit TCC Operation, DNA
P0602	TCM Not Programmed	Yes	Lock in Neutral
P0604	Control module random access memory (RAM)	Yes	Lock in Neutral
P0614	Torque Control Data Mismatch - ECM/TCM	Yes	Allows operation only in reverse and second range.
P0634	TCM Internal Temperature Too High	Yes	SOL OFF (hydraulic default)
P0642	Sensor Reference Voltage "A" Circuit Low	Yes	Default sensor data used
P0643	Sensor Reference Voltage "A" Circuit High	Yes	Default sensor data used
P0657	Actuator Supply Circuit Voltage 1 Open (HSD 1)	Yes	SOL OFF, DNA, Inhibit TCC operation, Inhibit main modulation
P0658	Actuator Supply Voltage 1 (HSD1) Low	Yes	DNS, SOL OFF (hydraulic default)
P0659	Actuator Supply Voltage 1 (HSD1) High	Yes	DNS, SOL OFF (hydraulic default)
P0703	Brake Switch Circuit Malfunction	No	No Neutral to Drive shifts for refuse packer. TCM inhibits retarder operation if a TPS code is also active.
P0708	Transmission Range Sensor Circuit High Input	Yes	Ignore defective strip selector inputs

## 10 APPENDIX C – Allison Transmission’s Other Features

DTC	Description	CHECK Light	Inhibited Operation Description
P070C	Transmission Fluid Level Sensor Circuit – Low Input	No	None
P070D	Transmission Fluid Level Sensor Circuit – High Input	No	None
P0712	Transmission Fluid Temperature Sensor Circuit Low Input	Yes	Use default sump temp
P0713	Transmission Fluid Temperature Sensor Circuit High Input	Yes	Use default sump temp
P0715	Turbine Shaft Speed Sensor Circuit	Yes	DNS, Lock in current range
P0716	Turbine Shaft Speed Sensor Circuit Performance	Yes	DNS, Lock in current range
P0717	Turbine Shaft Speed Sensor Circuit No Signal	Yes	DNS, Lock in current range
P071A	RELS Input Failed On	Yes	Inhibit RELS operation
P071D	General Purpose Input Fault	Yes	None
P0720	Output Shaft Speed Sensor Circuit	Yes	DNS, Lock in current range
P0721	Output Shaft Speed Sensor Circuit Performance	Yes	DNS, Lock in current range
P0722	Output Speed Sensor Circuit No Signal	Yes	DNS, Lock in current range
P0725	Engine Speed Sensor Circuit	No	Default to turbine speed
P0726	Engine Speed Sensor Circuit Performance	No	Default to turbine speed
P0727	Engine Speed Sensor Circuit No Signal	No	Default to turbine speed
P0729	Incorrect 6 <sup>th</sup> Gear Ratio	Yes	DNS, Attempt 5 <sup>th</sup> , then 3 <sup>rd</sup>
P0731	Incorrect 1 <sup>st</sup> Gear ratio	Yes	DNS, Attempt 2 <sup>nd</sup> , then 5 <sup>th</sup>
P0732	Incorrect 2 <sup>nd</sup> Gear ratio	Yes	DNS, Attempt 3 <sup>rd</sup> , then 5 <sup>th</sup>
P0733	Incorrect 3 <sup>rd</sup> Gear ratio	Yes	DNS, Attempt 4 <sup>th</sup> , then 6 <sup>th</sup>
P0734	Incorrect 4 <sup>th</sup> Gear ratio	Yes	DNS, Attempt 5 <sup>th</sup> , then 3 <sup>rd</sup>
P0735	Incorrect 5 <sup>th</sup> Gear ratio	Yes	DNS, Attempt 6 <sup>th</sup> , then 3 <sup>rd</sup> , then 2 <sup>nd</sup>
P0736	Incorrect Reverse Gear ratio	Yes	DNS, Lock in Neutral
P0741	Torque Converter Clutch System Stuck Off	Yes	None
P0752	Shift Solenoid 1 Valve Performance-Stuck On	Yes	DNS
P0776	Pressure Control Solenoid (PCS) 2 Stuck Off	Yes	DNS, RPR
P0777	Pressure Control Solenoid 2 Stuck On	Yes	DNS, RPR
P0796	Pressure Control Solenoid 3 Stuck Off	Yes	DNS, RPR
P0797	Pressure Control Solenoid 3 Stuck On	Yes	DNS, RPR
P0842	Transmission Fluid Pressure Switch 1 Circuit Low	Yes	DNS, Lock in current range
P0843	Transmission Fluid Pressure Switch 1 Circuit High	Yes	DNS, Lock in current range
P0847	Transmission Fluid Pressure Switch 2 Circuit Low	Yes	None
P0848	Transmission Fluid Pressure Switch 2 Circuit High	Yes	None
P088A	Transmission Fluid Filter Maintenance Alert	No	None
P088B	Transmission Fluid Filter Maintenance Required	No	None
P0880	TCM Power Input Signal	No	None
P0881	TCM Power Input Signal Performance	No	None
P0882	TCM Power Input Signal Low	Yes	DNS, SOL OFF (hydraulic default)
P0883	TCM Power Input Signal High	No	None
P0894	Unexpected Mechanical Gear Disengagement	Yes	DNS, Lock in first
P0897	Transmission Fluid Deteriorated	No	None
P0960	Main Pressure Modulator Solenoid Control Circuit Open	Yes	None
P0962	Main Pressure Modulator Solenoid Control Circuit Low	Yes	DNS, SOL OFF (hydraulic default)
P0963	Main Pressure Modulator Solenoid Control Circuit High	Yes	None
P0964	Pressure Control Solenoid 2 (PCS2) Control Circuit Open	Yes	DNS, SOL OFF (hydraulic default)

## APPENDIX C – Allison Transmission’s Other Features 11

DTC	Description	CHECK Light	Inhibited Operation Description
P0966	Pressure Control Solenoid 2 (PCS2) Control Circuit Low	Yes	DNS, SOL OFF (hydraulic default)
P0967	Pressure Control Solenoid 2 (PCS2) Control Circuit High	Yes	DNS, SOL OFF (hydraulic default)
P0968	Pressure Control Solenoid 3 (PCS3) Control Circuit Open	Yes	DNS, SOL OFF (hydraulic default)
P0970	Pressure Control Solenoid 3 (PCS3) Control Circuit Low	Yes	DNS, SOL OFF (hydraulic default)
P0971	Pressure Control Solenoid 3 (PCS3) Control Circuit High	Yes	DNS, SOL OFF (hydraulic default)
P0973	Shift Solenoid 1 (SS1) Control Circuit Low	Yes	DNS, SOL OFF (hydraulic default)
P0974	Shift Solenoid 1 (SS1) Control Circuit High	Yes	DNS, SOL OFF (hydraulic default)
P0976	Shift Solenoid 2 (SS2) Control Circuit Low	Yes	7-speed: Allow 2 through 6, N, R Inhibit TCC operation
P0977	Shift Solenoid 2 (SS2) Control Circuit High	Yes	7-speed: Allow 2 through 6, N, R
P097A	Shift Solenoid 1 (SS1) Control Circuit Open	Yes	Lock in range
P097B	Shift Solenoid 2 (SS2) Control Circuit Open	Yes	7-speed: Allow 2 through 6, N, R
P0989	Retarder Pressure Sensor Circuit Low	No	None
P0990	Retarder Pressure Sensor Circuit High	No	None
P1739	Incorrect Low Gear Ratio	Yes	Command 2 <sup>nd</sup> and allow shifts 2 through 6, N, R
P1790	Gear Shift Module 1 Calibrated Invalid	Yes	Shift selector language or units incorrect
P1791	Gear Shift Module 2 Calibrated Invalid	Yes	Shift selector language or units incorrect
P1891	Throttle Position Sensor PWM Signal Low	No	Use default throttle values
P1892	Throttle Position Sensor PWM Signal High	No	Use default throttle values
P2184	Engine Coolant Temperature Sensor 2 Circuit Low Input	No	Use default engine coolant values
P2185	Engine Coolant Temperature Sensor 2 Circuit High Input	No	Use default engine coolant values
P2637	Torque Management Feedback Signal (A)	Yes	Inhibit SEM
P2641	Torque Management Feedback Signal (B)	Yes	Inhibit LRTP
P2669	Actuator Supply Circuit Voltage 2 Open (HSD2)	Yes	SOL OFF, Inhibit TCC operation, Inhibit Main modulation, ONA
P2670	Actuator Supply Voltage 2 (HSD2) Low	Yes	DNS, SOL OFF (hydraulic default)
P2671	Actuator Supply Voltage 2 (HSD2) High	Yes	DNS, SOL OFF (hydraulic default)
P2684	Actuator Supply Circuit Voltage 3 Open (HSD3)	Yes	SOL OFF, Inhibit TCC operation, Inhibit Main modulation, ONA
P2685	Actuator Supply Voltage 3 (HSD3) Low	Yes	DNS, SOL OFF (hydraulic default)
P2686	Actuator Supply Voltage 3 (HSD3) High	Yes	DNS, SOL OFF (hydraulic default)
P2714	Pressure Control Solenoid 4 (PCS4) Stuck Off	Yes	DNS, RPR
P2715	Pressure Control Solenoid 4 (PCS4) Stuck On	Yes	DNS, SOL OFF (hydraulic default)
P2718	Pressure Control Solenoid 4 (PCS4) Control Circuit Open	Yes	DNS, SOL OFF (hydraulic default)
P2720	Pressure Control Solenoid 4 (PCS4) Control Circuit Low	Yes	DNS, SOL OFF (hydraulic default)
P2721	Pressure Control Solenoid 4 (PCS4) Control Circuit High	Yes	DNS, SOL OFF (hydraulic default)
P2723	Pressure Control Solenoid 1 (PCS1) Stuck Off	Yes	DNS, RPR
P2724	Pressure Control Solenoid 1 (PCS1) Stuck On	Yes	DNS, RPR
P2727	Pressure Control Solenoid 1 (PCS1) Control Circuit Open	Yes	DNS, SOL OFF (hydraulic default)
P2729	Pressure Control Solenoid 1 (PCS1) Control Circuit Low	Yes	DNS, SOL OFF (hydraulic default)
P2730	Pressure Control Solenoid 1 (PCS1) Control Circuit High	Yes	DNS, SOL OFF (hydraulic default)
P2736	Pressure Control Solenoid 5 (PCS5) Control Circuit Open	Yes	Inhibit retarder operation

## 12 APPENDIX C – Allison Transmission’s Other Features

DTC	Description	CHECK Light	Inhibited Operation Description
P2738	Pressure Control Solenoid 5 (PCS5) Control Circuit Low	Yes	Allow 2 through 6, N, R. Inhibit retarder and TCC operation
P2739	Pressure Control Solenoid 5 (PCS5) Control Circuit High	Yes	Inhibit retarder operation
P273F	Retarder Oil Temperature Sensor Over Temperature Condition	No	None
P2742	Retarder Oil Temperature Sensor Circuit – Low	No	Use default retarder temp values
P2743	Retarder Oil Temperature Sensor Circuit – High	No	Use default retarder temp values
P2761	TCC PCS Control Circuit Open	Yes	Inhibit TCC operation
P2763	TCC PCS Control Circuit High	Yes	Inhibit TCC operation
P2764	TCC PCS Control Circuit Low	Yes	7-speed: Allow 2 through 6, N, R. Inhibit TCC operation
P2789	Transmission Clutch Life Expired (Clutch Adaptive Learning at Limit)	No	None
P2793	Gear Shift Direction Circuit	Yes	Ignores PWM input from shift selector
P2808	Pressure Control Solenoid 6 (PCS6) Stuck Off	Yes	DNS, RPR
P2809	Pressure Control Solenoid 6 (PCS6) Stuck On	Yes	DNS, RPR
P2812	Pressure Control Solenoid 6 (PCS6) Control Circuit Open	Yes	DNS, SOL OFF (hydraulic default)
P2814	Pressure Control Solenoid 6 (PCS6) Control Circuit Low	Yes	DNS, SOL OFF (hydraulic default)
P2815	Pressure Control Solenoid 6 (PCS6) Control Circuit High	Yes	DNS, SOL OFF (hydraulic default)
U0073	CAN Communication Bus 1 Off	No	Use default values
U0074	CAN Communication Bus 2 Off	No	Use default values
U0100	Lost Communications with ECM A	Yes	Use default values
U0103	Lost Communication with Gear Shift Module (Shift Selector) 1	Yes	Maintain range selected, observe gear shift direction circuit
U0291	Lost Communication with Gear Shift Module (Shift Selector) 2	Yes	Maintain range selected, observe gear shift direction circuit
U0304	Incompatible Gear Shift Module 1 (Shift Selector)	Yes	Ignore shift selector inputs
U0333	Incompatible Gear Shift Module 2 (Shift Selector)	Yes	Ignore shift selector inputs
U0404	Invalid Data Received From Gear Shift Module (Shift Selector) 1	Yes	Maintain range selected, observe gear shift direction circuit
U0592	Invalid Data Received From Gear Shift Module (Shift Selector) 2	Yes	Maintain range selected, observe gear shift direction circuit

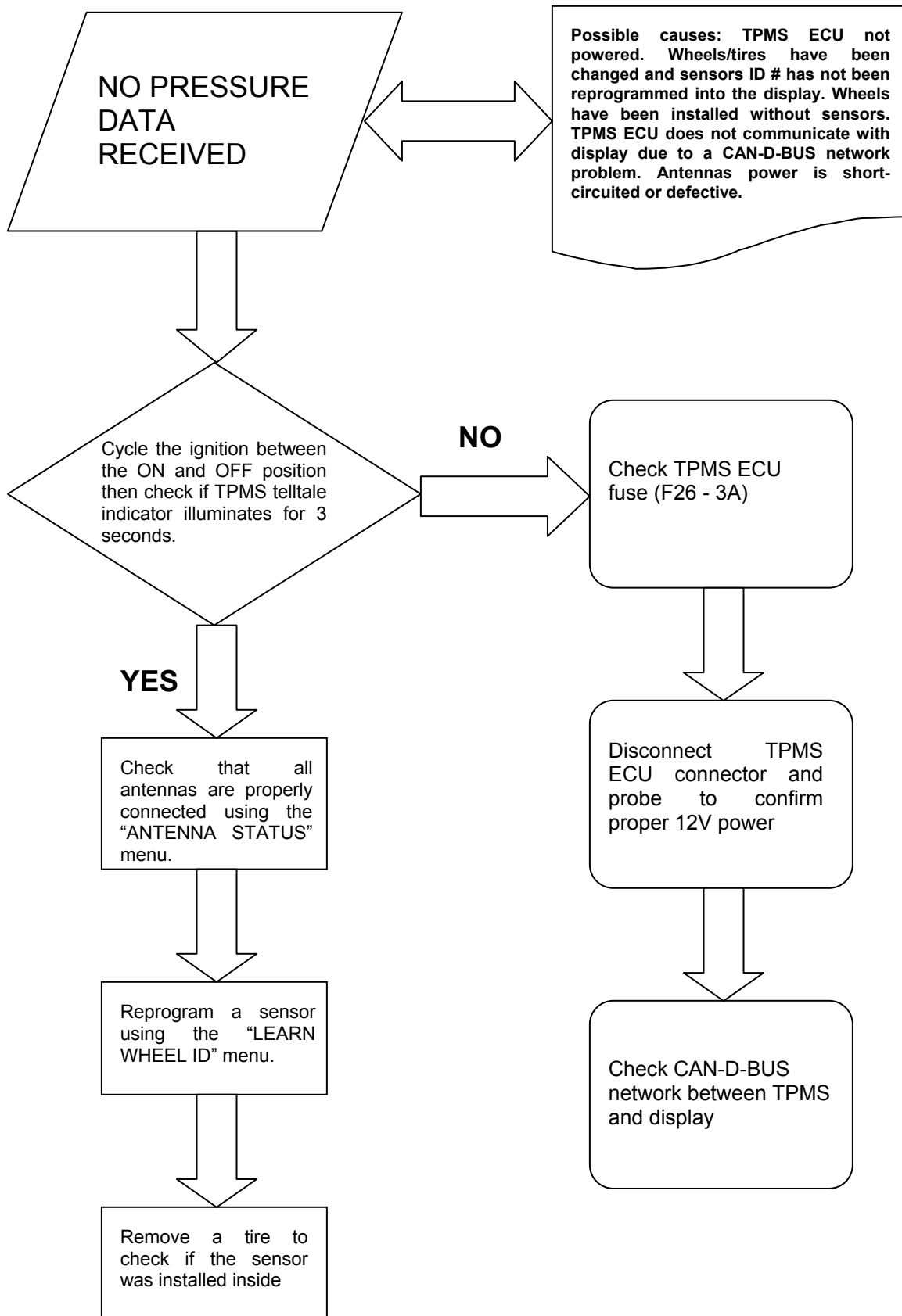

## 2 APPENDIX D – TPMS TROUBLESHOOTING GUIDE

---

