

PREVOST®

COACH MANUFACTURER

MAINTENANCE MANUAL

X3-45 COMMUTER

DOB Bus Number Series 2490 - 2789



Final Version, Rev. 2

PA1605 November 2014 (first release)

Featuring:

- GHG14 regulations engine
- ZF A-132 Drive Axle

REVISION	DESCRIPTION	DATE
1	- Sec 22: Heating and Air Conditioning updated. - Sec 13: Wheels, Hubs and Tires: updated to reflect wheel dimensions on new build; Drive axle hub updated to "ZF" design.	Feb. 2015
2	- Addition of "Change Log" table at the end of each section. - Tightening torques changed in Section 16. Refer to Section 16 Change Log. - Addition of steering play inspection. See section 14 & lubrication and servicing schedule. - Fuel tank strap torque was 60 lb-ft, is 20 lb-ft. - Section 24a lubrication and servicing schedule updated. - Section 03: FUEL. Fuel tank yearly inspection added. - Section 24a lubrication and servicing schedule updated. - Section 24a lubrication and servicing schedule updated.	April 2016 August 2016 October 2016 June 2017 May 2018 March 2019

CRITICAL EMISSION-RELATED MAINTENANCE

Source of parts and repair:

A repair shop or person of the owner's choosing must maintain, replace, or repair emission control devices and systems per manufacturer's recommendations.

Replacement of tires that are GHG certified:

The original equipment tires installed on this vehicle at the factory were certified to the U.S. EPA Greenhouse Gas (GHG) and **National Highway Traffic Safety Administration (NHTSA)** Fuel Efficiency regulations. Replacement of these tires should be with a tire of equal or lower rolling resistance levels (TRRL or Crr). Please consult your tire supplier(s) for appropriate replacement tires.

Maintaining a GHG certified tire:

In order to maintain the certified rolling resistance of the tires which optimize fuel economy, the maintenance procedures provide by the tire manufacturer must be followed.

CONTENTS

1. FOREWORD	2
2. SCHEMATICS	2
3. PRECAUTIONS TO BE OBSERVED BEFORE WELDING	2
4. SAFETY NOTICE	4
4.1 DATA PLATES AND CERTIFICATIONS	4
4.1.1 <i>Engine</i>	5
4.1.2 <i>Transmission</i>	5
4.1.3 <i>Drive Axle</i>	5
4.1.4 <i>Front Axle</i>	5
4.1.5 <i>Power Steering Pump</i>	5
4.1.6 <i>Coach Final Record</i>	5
4.1.7 <i>Safety Certification</i>	5
4.1.8 <i>DOT Certification Label</i>	6
4.1.9 <i>Fuel Tank Label</i>	6
4.1.10 <i>Vehicle Identification Number (VIN)</i>	6
5. FASTENER STRENGTH IDENTIFICATION	8
5.1 STANDARD TORQUE SPECIFICATIONS	9
5.2 SELF-LOCKING FASTENERS.....	11
5.3 RECOMMENDATIONS FOR REUSE	11
5.4 SIX LOBED SOCKET HEAD	11
6. SECTION CHANGE LOG	15

ILLUSTRATIONS

FIGURE 1: VOLVO D13 ENGINE DATA PLATE.....	5
FIGURE 2: ALLISON TRANSMISSION	5
FIGURE 3: TYPICAL SERIAL & MODEL NUMBERS	5
FIGURE 4: I-BEAM AXLE TYPICAL SERIAL & MODEL NUMBERS.....	5
FIGURE 5: POWER STEERING PUMP	5
FIGURE 6: DOT CERTIFICATION PLATE	6
FIGURE 7: VEHICLE I.D.....	6
FIGURE 8: VEHICLE IDENTIFICATION NUMBER.....	7
FIGURE 9: THREAD NOTATION	8
FIGURE 10: BOLT STRENGTH MARKINGS	8
FIGURE 11: SELF-LOCKING FASTENERS	11
FIGURE 12: METRIC - US STANDARD CONVERSION TABLE.....	13
FIGURE 13: CONVERSION CHART	14

1. FOREWORD

This manual includes procedures for diagnosis, service, maintenance and repair for components of the X3-45 series coaches listed on the front cover page. This manual should be kept in a handy place for ready reference by the technician. If properly used, it will meet the needs of the technician and owner.

Information provided in Sections 1 through 24 pertain to standard equipment items, systems and components as well as the most commonly used optional equipment and special equipment offered on the vehicle models covered by this manual. At the beginning of each section: a Table of Contents and a list of illustrations give the page number on which each subject begins and where each figure is located. Vehicle operating information is provided in a separate Manual

More specific information on engine and transmission operating, maintenance, and overhaul information is contained in the applicable engine or transmission service manual published by the engine or transmission manufacturer. Engine and transmission parts information is contained in the applicable engine or transmission parts catalog published by the engine or transmission manufacturer. All information, illustrations and specifications contained in this manual are based on the latest product information available at the time of publication approval. The right is reserved to make product changes at any time without notice.

NOTE

Illustrations in this manual are used for reference only and may differ slightly from the actual vehicle, however, key components addressed in the manual are represented as accurately as possible.

Prevost occasionally sends Maintenance Information, Warranty Bulletins, Safety Recalls or other literature to update users with the latest service procedures. They are issued, when required, to supplement or supersede information in this manual. Update sheet should be filled out and bulletins should be filed at the end of their respective section for future reference.

2. SCHEMATICS

Vehicle Air Schematics are provided at the end of Section 12, "Brake". SUSPENSION AIR SCHEMATICS are provided at the end of Section 16: "Suspension". Moreover, Electrical Schematics are provided in the technical publications box. Refer to those schematics for detailed circuit information or during diagnosis.

3. PRECAUTIONS TO BE OBSERVED BEFORE WELDING



CAUTION

Precautions are to be observed before welding to minimize the risk of major and costly damage caused to the vehicle electronic components.

NOTE

For X3-45 Series Multiplex coaches, also execute procedure no: PR060041 "MULTIPLEX MODULES DISCONNECTION PROCEDURE PRIOR TO WELDING" included at the end of this section.



CAUTION

For vehicles equipped with a WCL system, disconnect electronic controller connector.



CAUTION

Cover electronic control components and wiring to protect from hot sparks, etc.



CAUTION

Position welding machine ground clamp as close as possible to the work. Ensure that the welding machine ground return clamp is well secured and makes a good electrical contact with a large metallic area of the chassis located as close as possible to the welding point.



CAUTION

Do not use TIG welding process on the vehicle. This high frequency current process can seriously damage the electronic components.

STEEL – STEEL WELDING**CAUTION**

Before welding, perform multiplex modules disconnection procedure.

NOTE

Welding surfaces must be free of scale, slag, rust, paint, grease, humidity or other foreign material that would render welding impossible.

**DANGER**

Only a qualified and experienced person must do welding.

- FCAW (Flux Cored Arc Welding) process ;
- Electrode wire conforms to A5.20 AWS (American Welding Society) specifications ;
- E4801T-9-CH, type electrode wire with 0,045" diameter (1,14 mm) ;

Material Thickness	Voltage	Current	Wire Feed Rate	Shielding Gas
1/8" to 1/2"	26 ± 2 volts	260 Amps	450 ipm. approx.	75% argon – 25% CO2 or 100% CO2

If necessary and with great care to prevent perforating the material, it is possible to use a conventional electric arc welding machine according to the following specifications:

- SMAW (Shielded Metal-Arc Welding) process ;
- Welding rod conforms to A5.1 of AWS (American Welding Society) specifications; E 7018 type welding rod with 1/8" diameter (3,2 mm).
- Current: 100 amperes to 150 amperes; optimum at 120 amps.

It is important to grind weld bead starts and stops and also to grind arc strikes from surfaces.

STEEL - STAINLESS STEEL OR STAINLESS STEEL - STAINLESS STEEL WELDING**CAUTION**

Before welding, perform multiplex modules disconnection procedure.

NOTE

Welding surfaces must be free of scale, slag, rust, paint, grease, humidity or other foreign material that would render welding impossible.

**DANGER**

Only a qualified and experienced person must do welding.

- GMAW (Gas Metal-Arc Welding) process;
- Welding wire conforms to AWS (American Welding Standards) A5.9 specifications;
- 308LSi type welding wire with 0.035" diameter (0,9 mm);

STEEL - STAINLESS STEEL WELDING

SECTION 00: GENERAL INFORMATION

Steel Thickness	SS Thickness	Voltage	Current	Wire Feed Rate	Shielding Gas
Less than 1/8"	Any type	20±1.5 volts	130±15 Amps	290 ipm approx.	90% He, 7.5% Ar, 2.5% CO2
1/8" and more	Any type	22±1.5 volts	160±15 Amps	330 ipm approx.	90% He, 7.5% Ar, 2.5% CO2

STAINLESS STEEL - STAINLESS STEEL WELDING

SS Thickness	Voltage	Current	Wire Feed Rate	Shielding Gas
Any type	20 ± 1.5 volts	130 ± 15 Amps	290 ipm approx.	90% He – 7.5% Ar, 2.5% CO2

If necessary and with great care to prevent perforating the material, it is possible to use a conventional electric arc welding machine according to the following specifications:

- SMAW (Shield Metal-Arc Welding) process;
- Welding rod conforms to AWS (American Welding Standards) A5.4 specifications; 308L-17 type welding rod with 3/32" diameter (2,4 mm);
- Current: - 50 amperes to 90 amperes, optimum at 60 amperes.

It is important to grind weld bead starts and stops and also to grind arc strikes from surfaces.

4. SAFETY NOTICE

This maintenance manual has been prepared in order to assist skilled mechanics in the efficient repair and maintenance of PREVOST vehicles.

This manual covers only the procedures as of manufacturing date.

Safety features may be impaired if other than genuine PREVOST parts are installed.

Torque wrench tightening specifications must be strictly observed. Locking devices must be installed or replaced by new ones, where specified. If the efficiency of a locking device is impaired, it must be replaced.

This manual emphasizes particular information outlined by the wording and symbols:



DANGER

Directs the operator's attention to unsafe practices which could result in serious personal injury or death.



WARNING

Directs the operator's attention to unsafe practices which could result in serious personal injury or severe damage to the vehicle.



CAUTION

Directs the operator's attention to unsafe practices where personal injury is not likely but damage to vehicle components could occur.

NOTE

Indicates supplementary information essential to the proper operation of the vehicle. Although, the mere reading of such information does not eliminate the hazard, understanding of the information will promote its correct use.

4.1 DATA PLATES AND CERTIFICATIONS

Delay and confusion can be avoided by placing the complete vehicle identification number of the vehicle and the serial numbers of the engine on parts orders and correspondence. Also, the transmission, axles, power steering pump chassis and other major components are identified by serial numbers.

4.1.1 Engine

Volvo D13 engine serial and model numbers are stamped on the cylinder head (Figure 1).

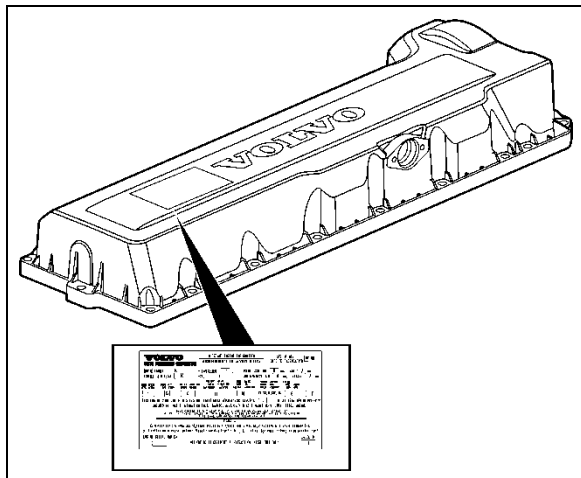

FIGURE 1: VOLVO D13 ENGINE DATA PLATE
00052

Also the engine data plate certifies that the engine conforms to federal and any state exhaust emissions regulations.

4.1.2 Transmission

The transmission identification plate is located on the oil level dipstick side of the transmission (WT) (Figure 2). The identification plate shows the transmission serial number, part number (assembly number), and model number. Use all three numbers when ordering parts.

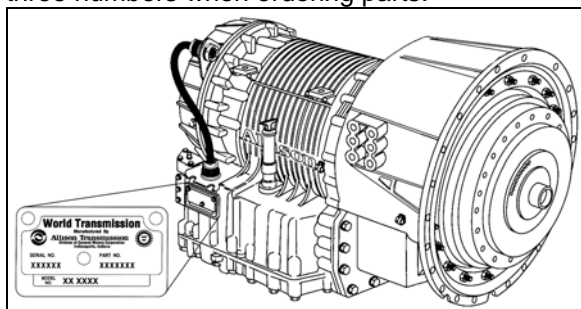

FIGURE 2: ALLISON TRANSMISSION
07076

4.1.3 Drive Axle

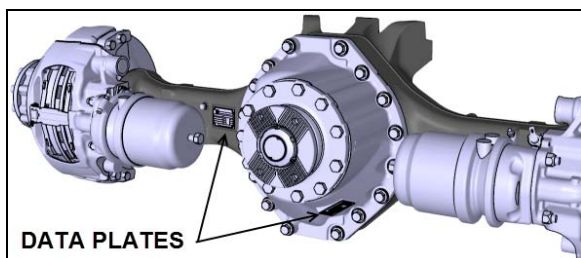

FIGURE 3: TYPICAL SERIAL & MODEL NUMBERS 00007

4.1.4 Front Axle

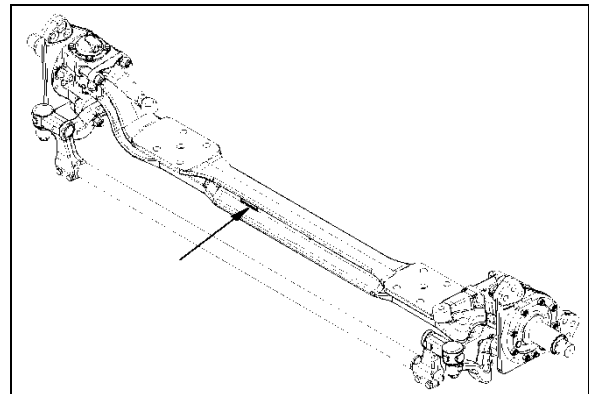

FIGURE 4: I-BEAM AXLE TYPICAL SERIAL & MODEL NUMBERS
00008

4.1.5 Power Steering Pump

Power steering pump is mounted on the engine and located underneath the air compressor (Figure 5).

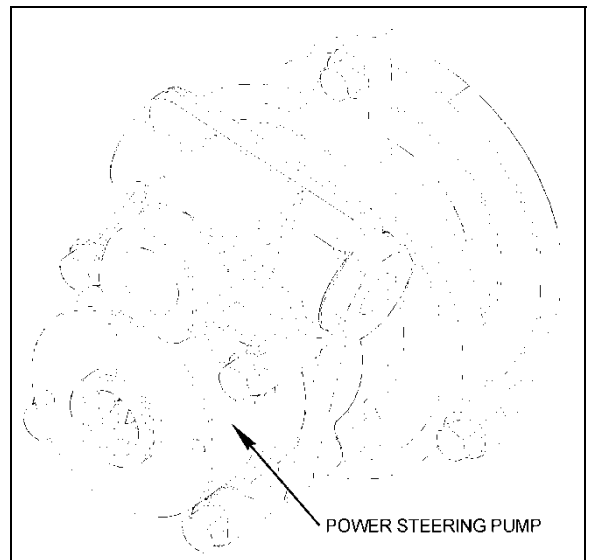

FIGURE 5: POWER STEERING PUMP

4.1.6 Coach Final Record

The Coach Final Record is a record of all data pertaining to the assembly of the vehicle. This record is shipped to the new customer via a courier company. Retain this record in the company records office for reference and safe-keeping.

4.1.7 Safety Certification

Vehicle components meet specifications and standards as follows:

- Material and parts conform to ASTM and/or SAE standards in effect at the time of manufacture.
- All factory-installed interior materials meet FMVSS 302 for fire resistance.
- Certified according to Provincial, State and Federal Safety standards (Canadian and US) BMCSS, FMVSS, and CMVSS.

Other applicable certification labels are affixed to the component.

4.1.8 DOT Certification Label

This certifies that vehicles manufactured by Prevest Inc., comply with all Federal Motor Vehicle Safety Standards at the time of manufacture. Information such as date of manufacture, model year, gross vehicle weight rating, tire types and inflation pressure is also etched on this plate. The DOT Certification plate is affixed to the side of the L.H. control panel.

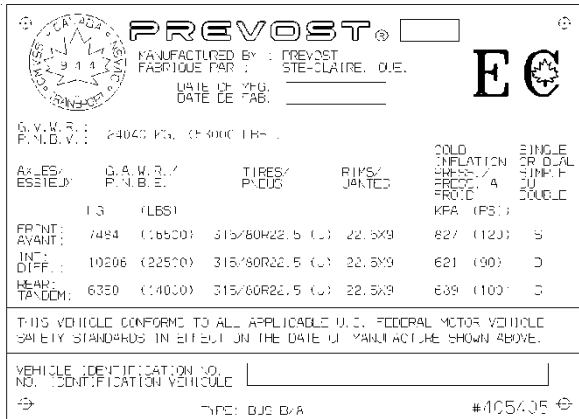

FIGURE 6: DOT CERTIFICATION PLATE 00016

4.1.9 Fuel Tank Label

The fuel tank label is molded on the side of the fuel tank. To read this label, unscrew the fuel tank access panel nuts located at the left in the condenser compartment.

4.1.10 Vehicle Identification Number (VIN)

The seventeen digit vehicle identification number (VIN) is located on a plate (Figure 8) located on the windshield frame pillar (Figure 7). The VIN is visible from the outside of the vehicle. Make sure the correct vehicle identification number is given when ordering replacement parts. Using the VIN when ordering parts will facilitate processing.



FIGURE 7: VEHICLE I.D. 00048

NOTE

Record the VIN in the vehicle documentation and keep with company records. The VIN will normally be used for vehicle registration and for obtaining vehicle insurance coverage.

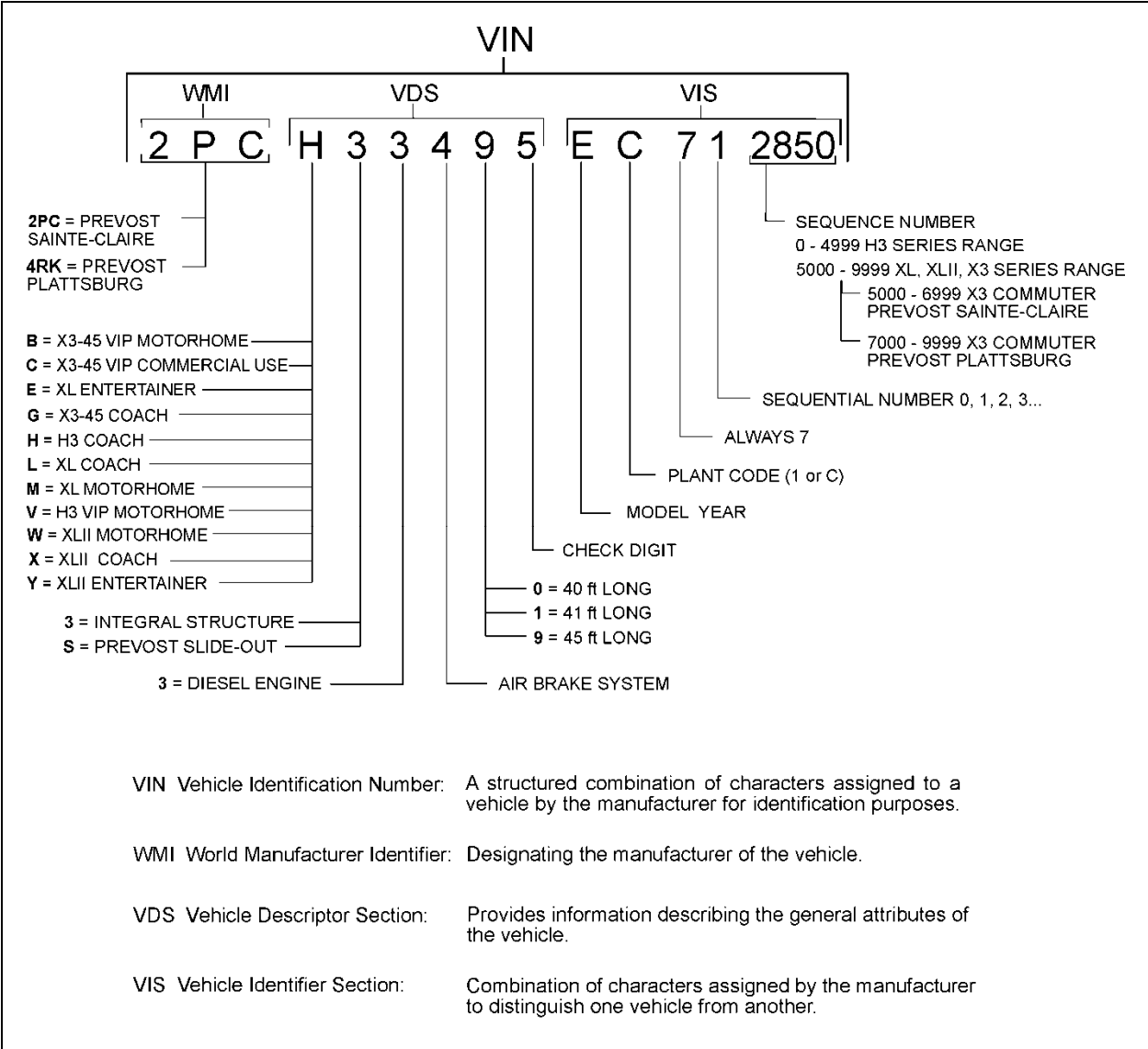

FIGURE 8: VEHICLE IDENTIFICATION NUMBER

00056

YEAR	CODE	YEAR	CODE	YEAR	CODE
2000	Y	2006	6	2012	C
2001	1	2007	7	2013	D
2002	2	2008	8	2014	E
2003	3	2009	9	2015	F
2004	4	2010	A	2016	G
2005	5	2011	B	2017	H

5. FASTENER STRENGTH IDENTIFICATION

Most commonly used metric fastener strength property classes are 9.8 and 10.9 with the class identification embossed on the head of each bolt. Customary (inch) strength classes range from grade 2 to 8 with radial line identification embossed on each bolt head actual grade (i.e., a grade 7 bolt will have 5 embossed radial lines on the bolt head). Some metric nuts will be marked with single digit strength identification numbers on the nut face. Figure 10 shows the different strength markings. When replacing

metric fasteners, be careful to use fasteners of the same or greater strength than the original fasteners (the same number marking or higher). It is also important to select replacement fasteners of the correct size. Correct replacement fasteners are available through the parts division. Some metric fasteners available in after-market parts sources were designed to metric standards of countries other than the United States and may be of a lower strength, may not have the numbered head marking system, and may be of a different thread pitch.

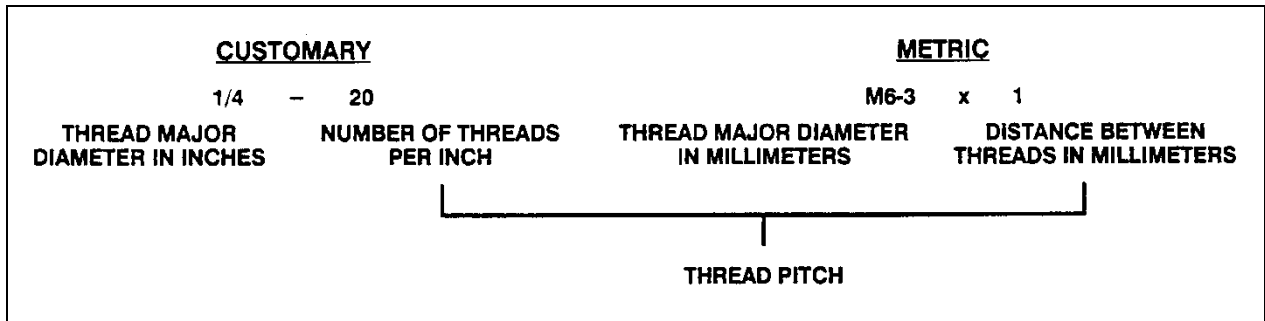

FIGURE 9: THREAD NOTATION

00002

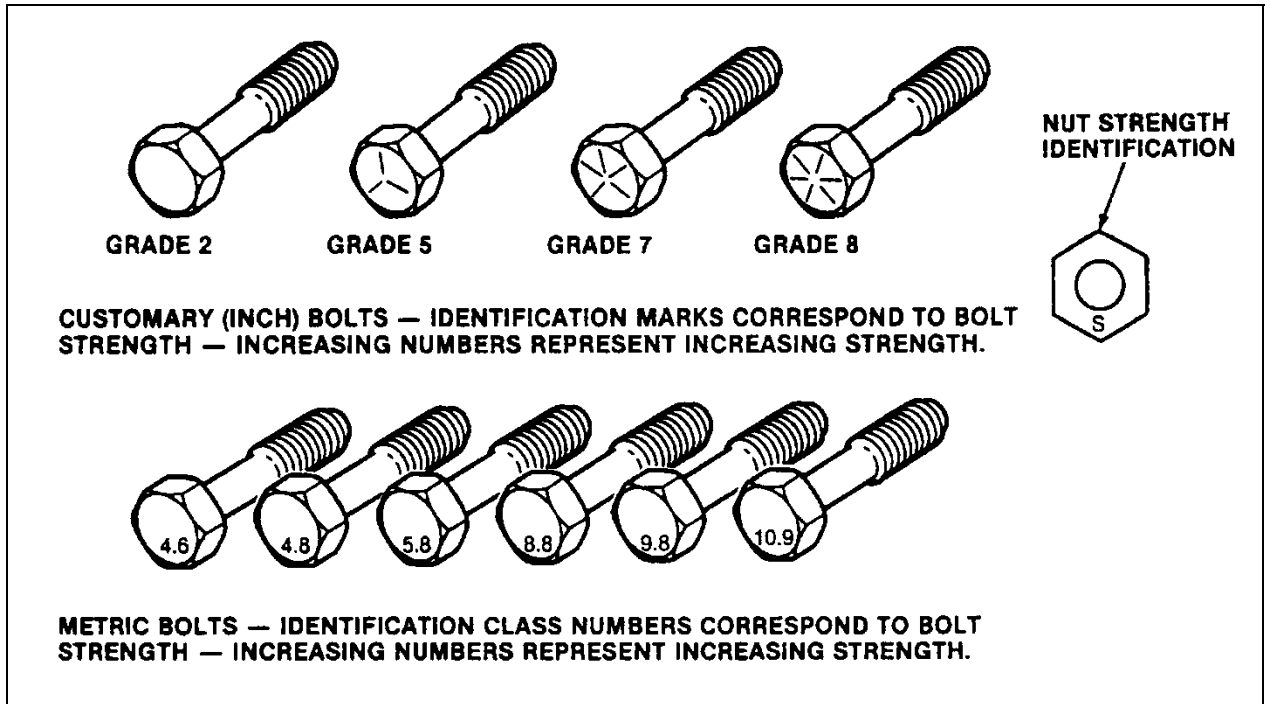

FIGURE 10: BOLT STRENGTH MARKINGS

00003

The metric fasteners used on the coach are designed to new standards and may not yet be manufactured by some non-domestic fastener suppliers. In general, except for special applications, the common sizes and pitches are:

- M 8 X 1.25;
- M 10 X 1.5;
- M 12 X 1.75;
- M 14 X 2;

5.1 STANDARD TORQUE SPECIFICATIONS

The following table lists the standard tightening torques for bolts and nuts, relating tightening torque to thread diameter. Use the following table as a general guide for tightening torques. Use this table only for the bolts and nuts which do not require a specific torque value. All of the values are for use with dry solvent-cleaned threads.

TYPE	DESCRIPTION	THREAD	GRADE	RECOMMENDED TORQUE	
				lbf-ft (dry) otherwise specified	Tolerance: $\pm 10\%$
SAE	1/4-20	unc	5	100	lbf-in (dry)
SAE	1/4-20	unc	8	143	lbf-in (dry)
SAE	1/4-28	unf	5	115	lbf-in (dry)
SAE	1/4-28	unf	8	163	lbf-in (dry)
SAE	5/16-18	unc	5	210	lbf-in (dry)
SAE	5/16-18	unc	8	305	lbf-in (dry)
SAE	5/16-24	unf	2	120	lbf-in (dry)
SAE	5/16-24	unf	5	230	lbf-in (dry)
SAE	5/16-24	unf	8	325	lbf-in (dry)
SAE	3/8-16	unc	5	31	
SAE	3/8-16	unc	8	44	
SAE	3/8-24	unf	5	35	
SAE	3/8-24	unf	8	50	
SAE	7/16-14	unc	5	50	
SAE	7/16-14	unc	8	70	
SAE	7/16-20	unf	5	55	
SAE	7/16-20	unf	8	78	
SAE	1/2-13	unc	5	75	
SAE	1/2-13	unc	8	107	
SAE	1/2-20	unf	5	85	
SAE	1/2-20	unf	8	120	
SAE	9/16-12	unc	5	109	
SAE	9/16-12	unc	8	154	
SAE	9/16-18	unf	5	122	
SAE	9/16-18	unf	8	172	
SAE	5/8-11	unc	5	151	
SAE	5/8-11	unc	8	211	
SAE	5/8-18	unf	5	170	

SECTION 00: GENERAL INFORMATION

TYPE	DESCRIPTION	THREAD	GRADE	RECOMMENDED TORQUE lbf-ft (dry) otherwise specified Tolerance: ±10%
SAE	5/8-18	unf	8	240
SAE	3/4-10	unc	5	266
SAE	3/4-10	unc	8	376
SAE	3/4-16	unf	5	298
SAE	3/4-16	unf	8	420
SAE	7/8-9	unc	5	430
SAE	7/8-9	unc	8	607
SAE	7/8-14	unf	5	470
SAE	7/8-14	unf	8	670
METRIC	M6 X 1		nut 9 / screw 8.8	7
METRIC	M6 X 1		nut 10 / screw 10.9	9
METRIC	M8 X 1.25		nut 9 / screw 8.8	16
METRIC	M8 X 1.25		nut 10 / screw 10.9	22
METRIC	M10 X 1.5		nut 9 / screw 8.8	32
METRIC	M10 X 1.5		nut 10 / screw 10.9	43
METRIC	M12 X 1.75		nut 9 / screw 8.8	60
METRIC	M12 X 1.75		nut 10 / screw 10.9	74
METRIC	M14 X 2		nut 9 / screw 8.8	90
METRIC	M14 X 2		nut 10 / screw 10.9	120
METRIC	M16 X 2		nut 9 / screw 8.8	140
METRIC	M16 X 2		nut 10 / screw 10.9	190
METRIC	M16 X 1.5		nut 10 / screw 10.9	230
METRIC	M20 X 2.5		nut 9 / screw 8.8	275
METRIC	M20 X 2.5		nut 10 / screw 10.9	450
METRIC	M20 X 1.5		nut 10 / screw 10.9	465
METRIC	M22 X 2.5		nut 9 / screw 8.8	345
METRIC	M22 X 2.5		nut 10 / screw 10.9	493
METRIC	M24 X 3		nut 9 / screw 8.8	475
METRIC	M24 X 3		nut 10 / screw 10.9	640

5.2 SELF-LOCKING FASTENERS

A self-locking fastener is designed with an interference fit between the nut and bolt threads. This is most often accomplished by distortion of the top thread of an all-metal nut or bolt or by using a nylon patch on the threads. A nylon insert or the use of adhesives may also be used as a method of interference between nut and bolt threads (Figure 11).

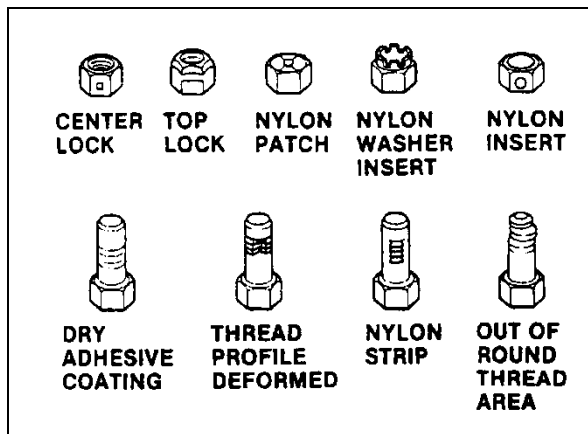

FIGURE 11: SELF-LOCKING FASTENERS

00004

are available commercially. However, in some cases, if the correct tool is not available, a hex socket head wrench may be used.

5.3 RECOMMENDATIONS FOR REUSE

Clean, rust-free self-locking fasteners may be reused as follows:

- a) Clean dirt and other foreign matter from the fastener;
- b) Inspect the fastener to ensure there is no crack, elongation, or other sign of fatigue or overtightening. If there is any doubt, replace with a new self-locking fastener of equal or greater strength;
- c) Assemble parts and hand start fastener;
- d) Observe that, before the fastener seats, it develops torque per the chart in table two. If there is any doubt, replace with a new self-locking fastener of equal or greater strength;
- e) Tighten the fastener to the torque specified in the applicable section of this manual;

Fasteners which are rusty or damaged should be replaced with new ones of equal or greater strength.

5.4 SIX LOBED SOCKET HEAD

Six lobed socket head (Torx) fasteners are used in some applications on vehicles covered in this manual. The tools designed for these fasteners

SELF-LOCKING FASTENER TORQUE CHART

METRIC		6 & 6.3	8	10	12	14	16	20	
NUTS AND ALL-METAL BOLTS	Nm	0.4	0.8	1.4	2.2	3.0	4.2	7.0	
	Lbf-in	4.0	7.0	12	18	25	35	57	
ADHESIVE OR NYLON COATED BOLTS	Nm	0.4	0.6	1.2	1.6	2.4	3.4	5.6	
	Lbf-in	4.0	5.0	10	14	20	28	46	
US STANDARD		¼	5/16	3/8	7/16	½	9/16	5/8	¾
NUTS AND ALL-METAL BOLTS	Nm	0.4	0.6	1.4	1.8	2.4	3.2	4.2	6.2
	Lbf-in	4.0	5.0	12	15	20	27	35	51
ADHESIVE OR NYLON COATED BOLTS	Nm	0.4	0.6	1.0	1.4	1.8	2.6	3.4	5.2
	Lbf-in	4.0	5.0	9.0	12	15	22	28	43

DECIMAL AND METRIC EQUIVALENTS

FRACTIONS	DECIMAL IN.	METRIC MM	FRACTIONS	DECIMAL IN.	METRIC MM
1/64	.015625	.39688	33/64	.515625	13.09687
1/32	.03125	.79375	17/32	.53125	13.49375
3/64	.046875	1.19062	35/64	.546875	13.89062
1/16	.0625	1.58750	9/16	.5625	14.28750
5/64	.078125	1.98437	37/64	.578125	14.68437
3/32	.09375	2.38125	19/32	.59375	15.08125
7/64	.109375	2.77812	39/64	.609375	15.47812
1/8	.125	3.1750	5/8	.625	15.87500
9/64	.140625	3.57187	41/64	.640625	16.27187
5/32	.15625	3.96875	21/32	.65625	16.66875
11/64	.171875	4.36562	43/64	.671875	17.06562
3/16	.1875	4.76250	11/16	.6875	17.46250
13/64	.203125	5.15937	45/64	.703125	17.85937
7/32	.21875	5.55625	23/32	.71875	18.25625
15/64	.234375	5.95312	47/64	.734375	18.65312
1/4	.250	6.35000	3/4	.750	19.05000
17/64	.265625	6.74687	49/64	.765625	19.44687
9/32	.28125	7.14375	25/32	.78125	19.84375
19/64	.296875	7.54062	51/64	.796875	20.24062
5/16	.3125	7.93750	13/16	.8125	20.63750
21/64	.328125	8.33437	53/64	.828125	21.03437
11/32	.34375	8.73125	27/32	.84375	21.43125
23/64	.359375	9.12812	55/64	.859375	21.82812
3/8	.375	9.52500	7/8	.875	22.22500
25/64	.390625	9.92187	57/64	.890625	22.62187
13/32	.40625	10.31875	29/32	.90625	23.01875
27/64	.421875	10.71562	59/64	.921875	23.41562
7/16	.4375	11.11250	15/16	.9375	23.81250
29/64	.453125	11.50937	61/64	.953125	24.20937
15/32	.46875	11.90625	31/32	.96875	24.60625
31/64	.484375	12.30312	63/64	.984375	25.00312
1/2	.500	12.70000	1	1.00	25.40000

FIGURE 13: CONVERSION CHART

00006

6. SECTION CHANGE LOG

DESCRIPTION		DATE
1		
2		
3		
4		
5		
6		

PREVOST

MULTIPLEX MODULES DISCONNECTION PROCEDURE PRIOR TO WELDING

PROCEDURE NO: PR060041	REVISION 02 2013-04-08
-------------------------------	-----------------------------------

Material: N/A

Equipment(s): Phillips-head screwdriver
Ratchet handle
3/8" socket
Electric tape
Long nose pliers

Reference schematics: N/A

Safety rules:

- Wear safety goggles
- Set the battery master switch to the OFF position first

Recommendations: This procedure should be performed by qualified personnel only.

	Effective
Revision 00 : New procedure for cooling 2007	
Revision 01 : Modified for EPA 2010	
Revision 02 : Added: battery equalizer data connection (PRIME).	

X3 Series Coaches

2.00* **Location: Rear Electrical Panel and Dashboard**
Set the battery master switch to the OFF position
Place the ignition switch to the OFF position.

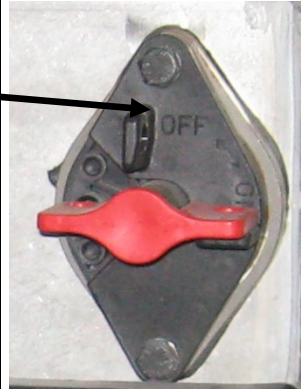

2.05* **Location: Rear Junction Panel**
Lift cover, trip circuit breakers CB2-CB6 located on junction panel.

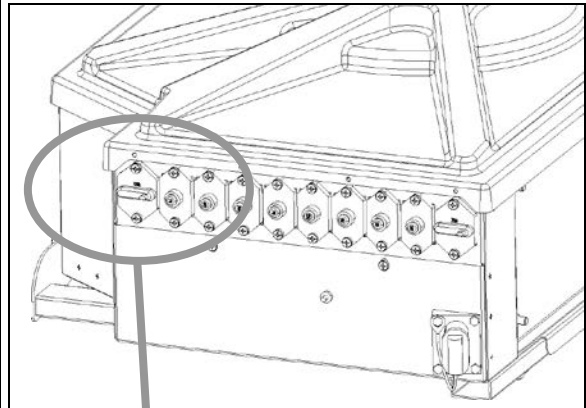

Push the red button to open the circuit



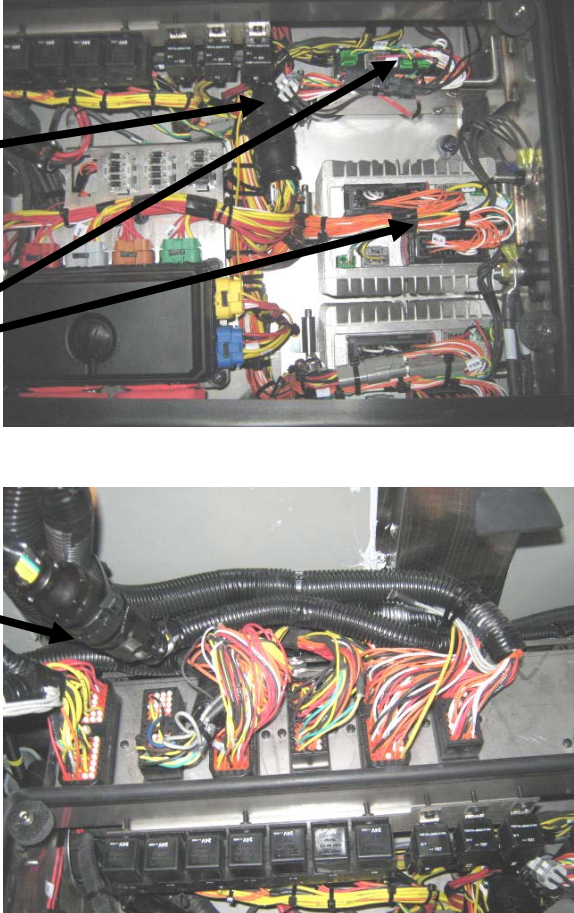

<p>2.10*</p>	<p>Location: Rear Electrical Panel</p> <p>Disconnect the electronic ground terminals from this stud.</p> <p>Use electric tape; make sure that cables do not touch each others and the vehicle body.</p> <p>Note :</p> <p><i>With disconnection of the electronic ground terminals, disconnecting the engine ECM, transmission TCM and the dashboard electronic components (telltale module, HVAC module, radio, control head ...) is not required.</i></p>	
<p>2.15*</p>	<p>Location: Rear Electrical Panel</p> <p>Disconnect the electronic modules:</p> <p>Disconnect all I/O A, I/O B modules.</p> <p style="padding-left: 100px;">Disconnect C717</p> <p>Disconnect 3 connectors from each I/O A module</p> <p>Disconnect 3 connectors from each I/O B module</p> <p style="padding-left: 100px;">Disconnect C397</p>	

2.15.2

Location: battery compartment:

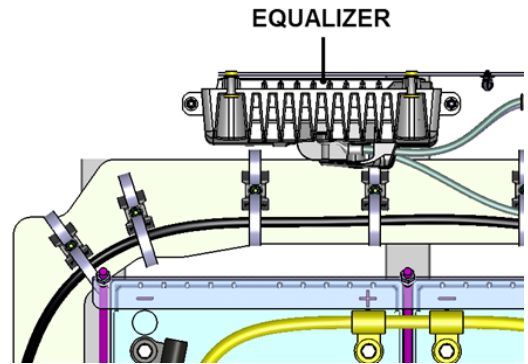
Disconnect data connector on equalizer



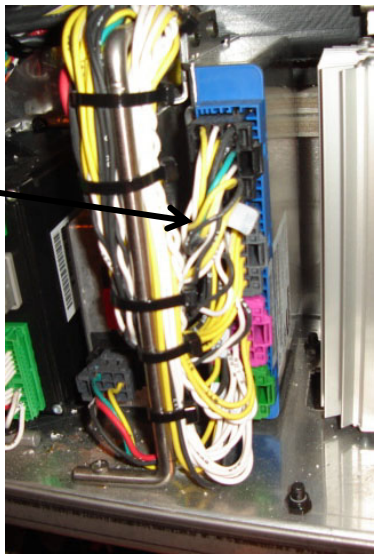
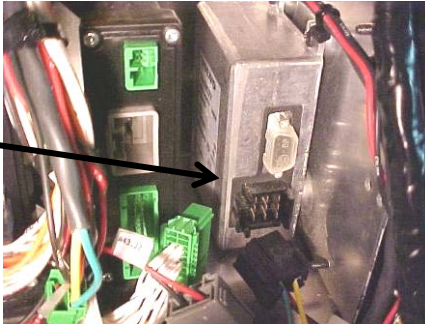

<p>2.20 *</p>	<p>Location: Front Electrical Compartment</p> <p>Disconnect the I/O A, I/O B, ABS, master ID, VECU, CECM, BERU, Volvo Link, Gsecu modules.</p> <p>Disconnect 3 connectors from I/O B and I/O A modules</p>	
	<p>Disconnect 4 connectors from the ABS module</p>	
	<p>Disconnect connector from master ID</p>	

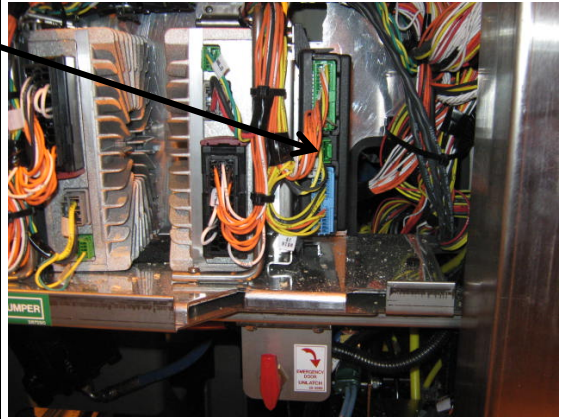
Disconnect 3 connectors from VECU



Disconnect 3 connectors from CECM

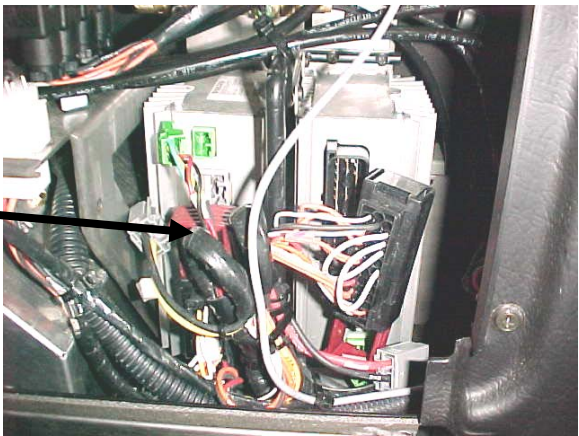

<p>2.30</p>	<p>Location: Pneumatic accessory panel inside right console</p> <p>Remove the access panel on the right console (R.H. side of dashboard)</p> <p>Disconnect both I/O B modules</p>	 <p>A photograph showing the interior of a right console. It features a white pneumatic accessory panel with various colored wires (red, white, black) connected to it. A black arrow points from the text 'Disconnect both I/O B modules' to a specific connector on the panel.</p>
<p>2.40</p>	<p>Location: Condenser Compartment</p> <p>Disconnect connector A 137</p>	 <p>A photograph of a condenser compartment. It shows a complex arrangement of pipes, hoses, and electrical components. A black arrow points from the text 'Disconnect connector A 137' to a specific electrical connector on a metal component.</p>

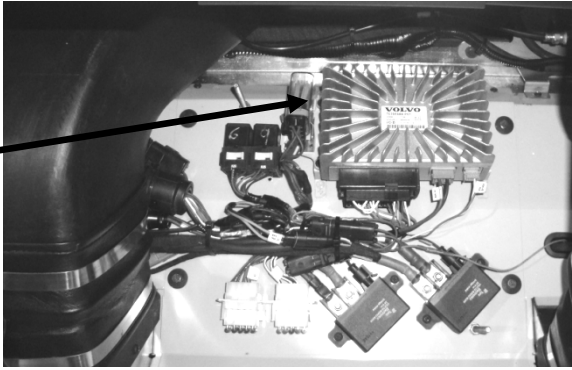
<p>2.50</p>	<p>Location: Evaporator Compartment</p> <p>Disconnect A54 module located inside the evaporator compartment</p>	
<p>2.60</p>	<p>When all the previous steps are done, you can do welding on the vehicle.</p>	<p>ENSURE THAT THE WELDING GROUND RETURN CLAMP IS WELL SECURED AND MAKES A GOOD ELECTRICAL CONTACT WITH A LARGE METALLIC AREA OF THE CHASSIS LOCATED NEAR THE WELDING POINT AS MUCH AS POSSIBLE.</p>
<p>2.70</p>	<p>When welding is completed, reconnect all the modules.</p> <p>Make sure that the connectors locking tab are well engaged!</p>	<p>BE CAREFUL TO MAKE THE PROPER CONNECTIONS, IF NOT, SOME SYSTEMS OR COMPONENTS MAY NOT BE USABLE.</p>