

# Starting and Stopping Procedures 6-1

---

<b>STARTING THE ENGINE</b> .....	<b>2</b>
STARTING FROM THE DRIVER'S SEAT .....	2
STOPPING THE ENGINE.....	2
STARTING FROM THE ENGINE COMPARTMENT.....	2
STOPPING THE ENGINE.....	3
COLD WEATHER STARTING .....	3
JUMP STARTING .....	3
<b>ENGINE PROTECTION SYSTEM</b> .....	<b>5</b>
AUTOMATIC ENGINE SHUTDOWN .....	5
<b>IDLE SHUTDOWN TIMER</b> .....	<b>5</b>
<b>ENGINE BLOCK HEATER</b> .....	<b>5</b>
<b>ENGINE WARM-UP</b> .....	<b>6</b>
<b>ALLISON TRANSMISSION WARM-UP</b> .....	<b>6</b>
<b>I-SHIFT TRANSMISSION - STARTING THE VEHICLE AT LOW TEMPERATURES</b> .....	<b>6</b>
<b>STARTING THE VEHICLE AFTER A FIRE ALARM</b> .....	<b>6</b>

### STARTING THE ENGINE

In normal circumstances, the engine should be started from the driver's seat. However, a rear-start panel in the engine compartment permits starting the engine from that location, mainly for maintenance purposes.

#### STARTING FROM THE DRIVER'S SEAT

- Make sure the starter selector switch located in the engine compartment is set to the *NORMAL* position and that the battery master switch (master cut-out) located on the rear electrical panel is set to the *ON* position.
- Apply the spring-loaded parking brake by pulling the parking brake control button all the way up;
- Place transmission in neutral;
- Turn ignition key to *START* position (refer to Controls and Instruments chapter), release the key after the engine starts.
- Brake pedal must be applied when selecting Drive (D) otherwise the transmission will stay in neutral (N).

#### CAUTION

Do not engage starter for more than 15 seconds at a time. If engine does not start within 15 seconds, release ignition key and let starter cool for one minute before attempting to restart.

#### CAUTION

Do not press accelerator pedal before starting. This could result in an electronic control unit fault and degrade the fuel system control.

#### CAUTION

Special precautions are necessary with turbocharged engines to avoid possible turbine damage. After starting, run the engine at normal idle for two minutes to allow lubricating oil to reach the turbocharger then run the engine at fast idle. Let oil pressure reach normal operating range before driving.

#### NOTE

*If engine does not start, return key to OFF position before attempting to restart.*

#### NOTE

*If the accelerator pedal is depressed before starting, release and wait 30 seconds before attempting to restart.*

### STOPPING THE ENGINE

- Apply parking brake and place transmission in neutral (N);
- Allow engine to idle for at least two minutes before shutting engine *OFF*. This insures that the turbine speed drops and allows time for the engine exhaust gas temperature to drop to about 300°F (150°C);
- Shut off all electrical loads;
- Turn the ignition key to the *OFF* position.

#### CAUTION

Do not shut *OFF* engine when running above normal idle.

#### CAUTION

Set the battery master switch (master cut-out) to the *OFF* position after parking and when left unattended for an extended period of time.

### STARTING FROM THE ENGINE COMPARTMENT

Switches to start and stop the engine from inside the engine compartment are mounted on a small panel above the air filter.

#### DANGER

Apply parking brake and place transmission in neutral (N) before starting engine from inside the engine compartment.

Set the battery master switches (ignition and master cut-out) to the *ON* position;

Set the starter selector switch to the *REAR START* position;

Press the *REAR START* push-button switch, release push-button after the engine starts.

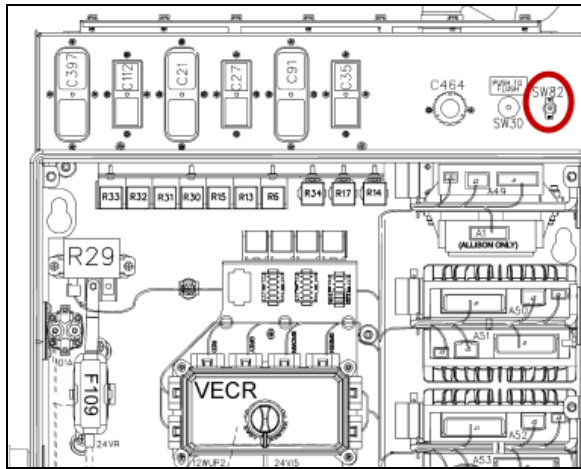

**BATTERY MASTER SWITCH** 06621\_2

 **DANGER**

Do not wear loose clothing when working near engine. Stand clear of rotating components.

 **CAUTION**

Refer to cautions in “Starting From The Driver’s Seat” in this chapter

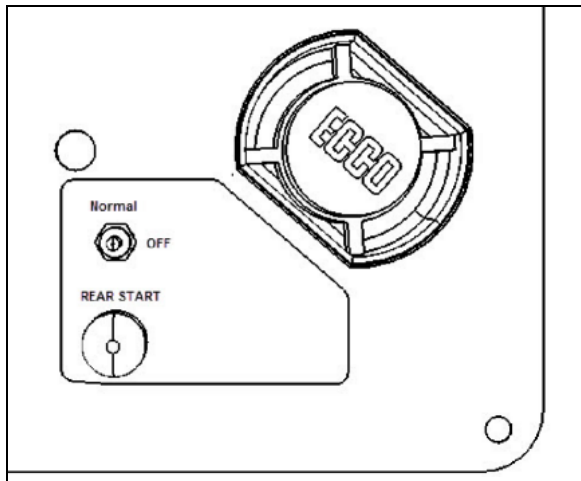

**REAR START PANEL** 06622\_2

 **DANGER**

Rotating shafts can be dangerous. You can snag cloths, skin, hair, hands, etc. This can cause a serious injury or death. Do not work on a shaft (with or without a guard) when the engine is running.

**STOPPING THE ENGINE**

To stop the engine from the engine compartment, set the starter selector switch to the *OFF* position.

 **CAUTION**

Do not stop engine by any other method.

**COLD WEATHER STARTING**

When starting a cold engine, the intake air should be warmed up by using the intake air preheater. Turn the ignition switch to the ON position. The preheater will not engage at coolant temperature above 54°F (12°C). If the coolant temperature is below 54°F (12°C), the preheater will engage and will light the preheater telltale between 0 and 50 seconds, depending on the engine coolant temperature. Wait before the preheater telltale has turned off before starting the engine.

If necessary, once the engine has started, the preheater will reengage (post heating) for the same length of time as the preheat time.

 **WARNING**

**Do not** use ether or other combustable starting aid fluid on any engine equipped with an intake air preheater. If the engine is equipped with a preheater, introduction of ether or similar starting aids could cause a fire or explosion resulting in severe property damage, serious personal injury or death.

Engines not equipped with an intake air preheater may, depending on coolant temperature, take longer to start. If this should happen, **DO NOT** release the ignition key until the engine has started (while still observing the 15 second maximum cranking time).

**JUMP STARTING**

In order to avoid damage to solid-state electrical components, it is important that jumper (booster) cables be used correctly and only in emergencies. To jump start, use another 24 volt DC, negative grounded, power source. Use only jumper cables rated at 500 cranking amperes.

 **DANGER**

Injury, explosion, battery acid damage or charging system overload may result if these jump starting procedures are not precisely followed.

 **WARNING**

Wear eye protection and remove rings, metal jewelry and watches with metal bands.

 **DANGER**

The gases given off by batteries while jump starting are explosive. Do not smoke near batteries.

 **DANGER**

The battery could rupture or explode if jump started when the run-down battery fluid is frozen or if the battery fluid level is low. Check condition of run-down battery before attempting to jump start.

 **CAUTION**

Do not let the two vehicles touch. Keep a walk-through distance between the two vehicles. Make sure positive (red) and negative (black) jumper cable clamps do not touch.

 **CAUTION**

Never connect the jumper cable to the negative terminal post of the run-down battery.

 **CAUTION**

Do not jump start if a maintenance-free battery has a yellow test indicator. Have the battery replaced.

 **WARNING**

Before attempting to jump start, make sure the parking brake is applied and the transmission is in neutral (N). Turn off all lights, heaters and other electrical accessories.

 **CAUTION**

Choose a booster vehicle which produces comparable amperage as your vehicle.

To jump start, proceed as follows:

1. Remove the protective cap from the booster block terminal located in the R.H. side engine compartment;
2. Connect one end of the red jumper cable to the positive (+) post of the booster power source. If the good battery is in another vehicle, that vehicle's engine must be shut *OFF* before connecting;
3. Connect the other end of the same red jumper cable to the positive (+) terminal on the booster block;
4. Connect one end of the black jumper cable to the negative (-) post on the booster power source;
5. Connect the other end of the same black jumper cable to the negative (-) terminal on the booster block; If the good battery is in another vehicle, start that vehicle's engine;
6. Let the engine run for a few minutes, then start the vehicle with the run-down battery;
7. Disconnect the jumper cables in reverse order given in steps 2 through 5;
8. Install protective cap on the booster block terminal.

**NOTE**

*Jumper cables must be rated at 500 cranking amperes. If jumper cable length is 20 feet (6 m) or less, use 2/0 (AWG) gauge wires. If cable length is between 20 to 30 feet (6 to 9 m), use 3/0 (AWG) gauge wires.*

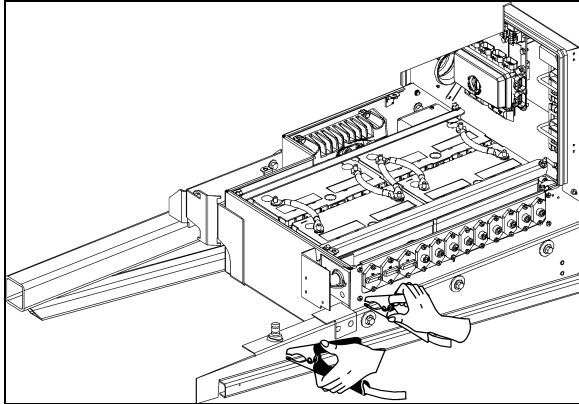

BOOSTER BLOCK LOCATION

06623

## ENGINE PROTECTION SYSTEM

The engine protection will automatically derate or stop the engine when certain engine conditions reach a critical stage.

In the event of a serious fault, the red STOP telltale light comes on and an audible alarm will sound if the engine is running.



An illuminated STOP telltale light indicates a serious problem has been detected, and the driver must respond immediately to the problem. The vehicle must be safely pulled off the road and stopped. In some instances, the engine must be switched off immediately.

## AUTOMATIC ENGINE SHUTDOWN

Prior to an actual automatic shutdown, the engine will automatically derate, go to idle, and then stop as the vehicle speed gets below 2 mph (3 km/h).

The engine shutdown protection will automatically derate and stop the engine when one or more of the conditions listed below reaches a critical point:

- High engine coolant temperature
- High engine oil temperature
- Low engine oil pressure
- High crankcase pressure (rate of change)

After the automatic engine shutdown sequence, the engine may be restarted. To do so, turn the ignition switch to the OFF position during 7 seconds and then turn it back to ON. However, it will only operate for 30 seconds unless the problem is resolved.

Use this function sparingly and in order to move the vehicle to a safe parking place only. Excessive use may result in severe engine damage.



## WARNING

Failure to take necessary action when the STOP telltale light is on can ultimately result in automatic engine derate and shutdown.

## IDLE SHUTDOWN TIMER

The optional idle shutdown timer is programmed to shut down the engine after a specific engine idling time. The idling time cannot be changed by the driver but can be changed with the use of a laptop computer and Premium Tech Tool. In this case, the engine idling time can be set from 30 seconds up to 1 hour.

The engine will shut down at the set time under the following conditions:

- Vehicle speed is 0;
- Engine is running at normal idle speed;
- Engine coolant temperature above 120°F (49°C);
- Temperature inside vehicle is between 59°F (15°C) and 81°F (27°C);
- Parking brake applied;
- Transmission into neutral (N);
- Wheelchair lift system not in use;

Pressing the fuel pedal will prevent engine shutdown and restart countdown.

## ENGINE BLOCK HEATER

The vehicle may be equipped with an engine immersion-type electric block heater to assist cold weather starting. A connector is on the rear pillar of the curb-side engine compartment door frame. Using an extension cord, connect to a 110 - 120 VAC outlet.

## 6-6 Starting and Stopping Procedures

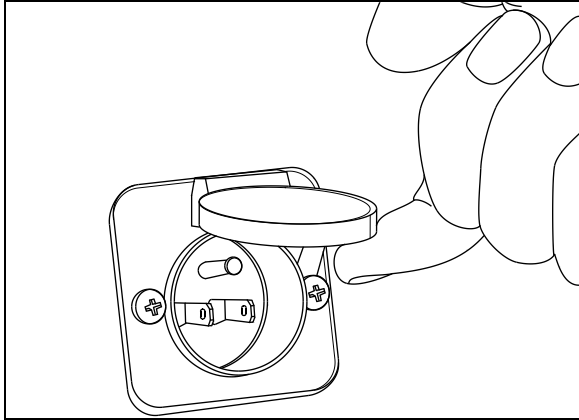

110-120 VOLTS CONNECTOR

06390



### CAUTION

Connect only to a 110-120 VAC power source. Use only grounded (three prongs) extension cords with a minimum rated capacity of 15 amps. Disconnect the extension cord before starting. Before driving, make sure the extension cord is disconnected and the engine compartment door is closed.

### ENGINE WARM-UP

After starting the engine, keep the parking brake applied and let the engine run at normal idle for two minutes to allow lubricating oil to reach the turbocharger. Increase engine speed to fast idle, using the FAST IDLE switch located on the dashboard for five minutes, without loading the engine. Monitor the gauges and indicator lights to make sure all conditions are normal. If an abnormal condition is observed, stop the engine immediately and have the condition corrected.



### DANGER

Never let the engine run in an enclosed, non-ventilated area. Engine exhaust fumes contain dangerous gases which can be fatal if inhaled. Before warming up the engine, open the door(s) or move the vehicle outside.

### NOTE

The engine will reach normal operating temperature shortly after driving. Avoid driving at full throttle until engine coolant temperature reaches 140°F (60°C).

### ALLISON TRANSMISSION WARM-UP

When the transmission temperature falls below -20°F (-29°C), the CHECK TRANS telltale light illuminates after the engine is started, and a reminder tone will sound. In this case, the transmission will be locked in neutral (N) until the transmission temperature rises above -20°F (-29°C) and the CHECK TRANS telltale light goes out. The transmission will only operate in first or reverse gears until it reaches normal operating temperature.

### I-SHIFT TRANSMISSION - STARTING THE VEHICLE AT LOW TEMPERATURES

For outside temperatures between -4°F (-20°C) and -22°F (-30°C), the transmission will require a warming up phase once the engine is started. The engine must be operated for at least 10 minutes with the vehicle at a standstill until the transmission oil has warmed up.

For outside temperatures below -22°F (-30°C), warm air must be used to heat the transmission up to a temperature above -22°F (-30°C) before the engine is started.

### STARTING THE VEHICLE AFTER A FIRE ALARM

The vehicle may be started after a fire alarm without resetting the system. Refer to section 7 SAFETY FEATURES AND EQUIPMENT under "Fire suppression system (AFSS)" for the complete procedure.